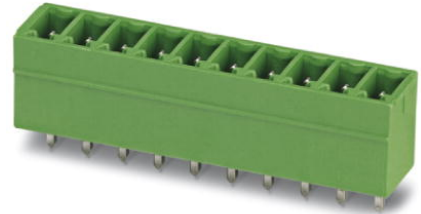

## MCV 1,5/ 3-G-3,81

Order No.: 1803439

The figure shows a 10-position version of the product

<http://eshop.phoenixcontact.de/phoenix/treeViewClick.do?UID=1803439>Header, Nominal current: 8 A, Nom. voltage: 160 V, Pitch: 3.81 mm,  
Number of positions: 3, Color: green, Assembly: Soldering

### Commercial data

EAN	4017918045746
Pack	50 pcs.
Customs tariff	85366990
Weight/Piece	0.001038 KG
Catalog page information	Page 175 (CC-2009)

### Product notes

WEEE/RoHS-compliant since:  
01/01/2003

<http://www.download.phoenixcontact.com>  
Please note that the data given here has been taken from the online catalog. For comprehensive information and data, please refer to the user documentation. The General Terms and Conditions of Use apply to Internet downloads.

### Technical data

#### Dimensions / positions

Length	7.25 mm
Pitch	3.81 mm
Dimension a	7.62 mm
Number of positions	3
Pin dimensions	0,8 x 0,8 mm

Hole diameter	1.2 mm
<b>Technical data</b>	
Insulating material group	IIIa
Rated surge voltage (III/3)	2.5 kV
Rated surge voltage (III/2)	2.5 kV
Rated surge voltage (II/2)	2.5 kV
Rated voltage (III/2)	160 V
Rated voltage (II/2)	250 V
Connection in acc. with standard	EN-VDE
Nominal current $I_N$	8 A
Nominal voltage $U_N$	160 V
Maximum load current	8 A
Insulating material	PBT
Inflammability class acc. to UL 94	V0

#### Certificates / Approvals



Certification CB, CSA, CUL, GOST, UL, VDE-PZI

#### CSA

Nominal voltage $U_N$	300 V
Nominal current $I_N$	8 A

#### CUL

Nominal voltage $U_N$	300 V
Nominal current $I_N$	8 A

#### UL

Nominal voltage $U_N$	300 V
Nominal current $I_N$	8 A

**Accessories**

Item	Designation	Description
<b>Marking</b>		
1051993	B-STIFT	Marker pen, for manual labeling of unprinted Zack strips, smear-proof and waterproof, line thickness 0.5 mm
0804109	SK 3,81/2,8:FORTL.ZAHLEN	Marker card, printed horizontally, self-adhesive, 10-section marker strip, 14 identical decades marked 1-10, 11-20 etc. up to 91-(99)100, sufficient for 140 terminal blocks
0805056	SK 3,81/2,8:SO	Marker card, special printing, self-adhesive, labeled acc. to customer requirements, 14 identical marker strips per card, max. 25-position labeling per strip, color: White

**Plug/Adapter**

1734634	CP-MSTB	Keying profile, is inserted into the slot on the plug or inverted header, red insulating material
---------	---------	---

**Additional products**

Item	Designation	Description
<b>General</b>		
1851054	FK-MCP 1,5/ 3-ST-3,81	Plug component, Nominal current: 8 A, Nom. voltage: 160 V, Pitch: 3.81 mm, Number of positions: 3, Connection type: Spring-cage conn., Color: green
1850673	FRONT-MC 1,5/ 3-ST-3,81	Plug component, Nominal current: 8 A, Nom. voltage: 160 V, Pitch: 3.81 mm, Number of positions: 3, Connection type: Screw connection, Color: green
1862580	IMC 1,5/ 3-G-3,81	Header, Nominal current: 8 A, Nom. voltage: 160 V, Pitch: 3.81 mm, Number of positions: 3, Color: green, Assembly: Soldering
1875438	IMCV 1,5/ 3-G-3,81	Header, Nominal current: 8 A, Nom. voltage: 160 V, Pitch: 3.81 mm, Number of positions: 3, Color: green, Assembly: Soldering
1803581	MC 1,5/ 3-ST-3,81	Plug component, Nominal current: 8 A, Nom. voltage: 160 V, Pitch: 3.81 mm, Number of positions: 3, Connection type: Screw connection, Color: green
1852189	MCC 1/ 3-STZ-3,81	Plug component, Nominal current: 8 A, Nom. voltage: 160 V, Pitch: 3.81 mm, Number of positions: 3, Connection type: Crimp connection, Color: green
1827130	MCVR 1,5/ 3-ST-3,81	Plug component, Nominal current: 8 A, Nom. voltage: 160 V, Pitch: 3.81 mm, Number of positions: 3, Connection type: Screw connection, Color: green
1826982	MCVW 1,5/ 3-ST-3,81	Plug component, Nominal current: 8 A, Nom. voltage: 160 V, Pitch: 3.81 mm, Number of positions: 3, Connection type: Screw connection, Color: green

1897403	QC 0,5/ 3-ST-3,81	Plug component, Nominal current: 6 A, Nom. voltage: 320 V, Pitch: 3.81 mm, Number of positions: 3, Connection type: Insulation displacement connection QUICKON, Color: green
---------	-------------------	--

**Diagrams/Drawings**

Drilling plan/solder pad geometry

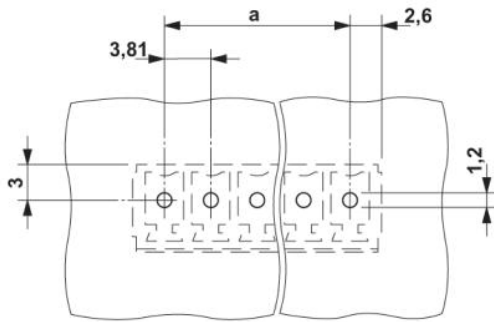

Dimensioned drawing

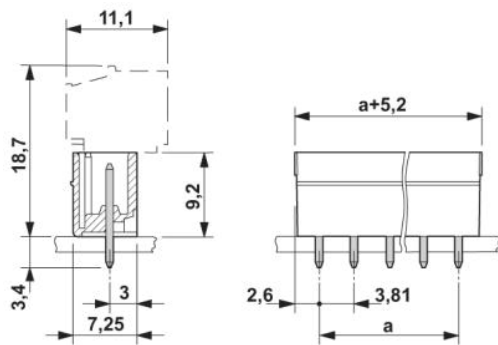

**Address**

PHOENIX CONTACT Inc., USA  
586 Fulling Mill Road  
Middletown, PA 17057, USA  
Phone (800) 888-7388  
Fax (717) 944-1625  
<http://www.phoenixcon.com>



© 2010 Phoenix Contact  
Technical modifications reserved;