

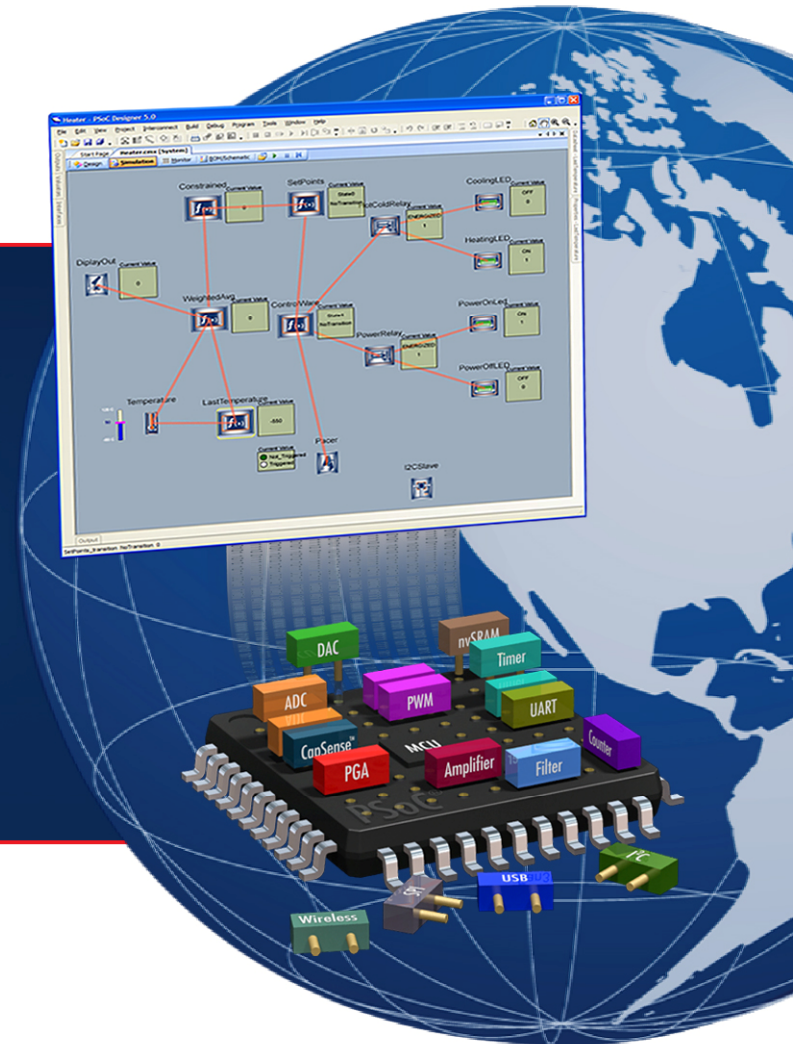

PACKAGE CROSS-SECTION DRAWINGS

February 26, 2014



Note: The purpose of this diagram is to illustrate the cross-section of Cypress products.

SOIC

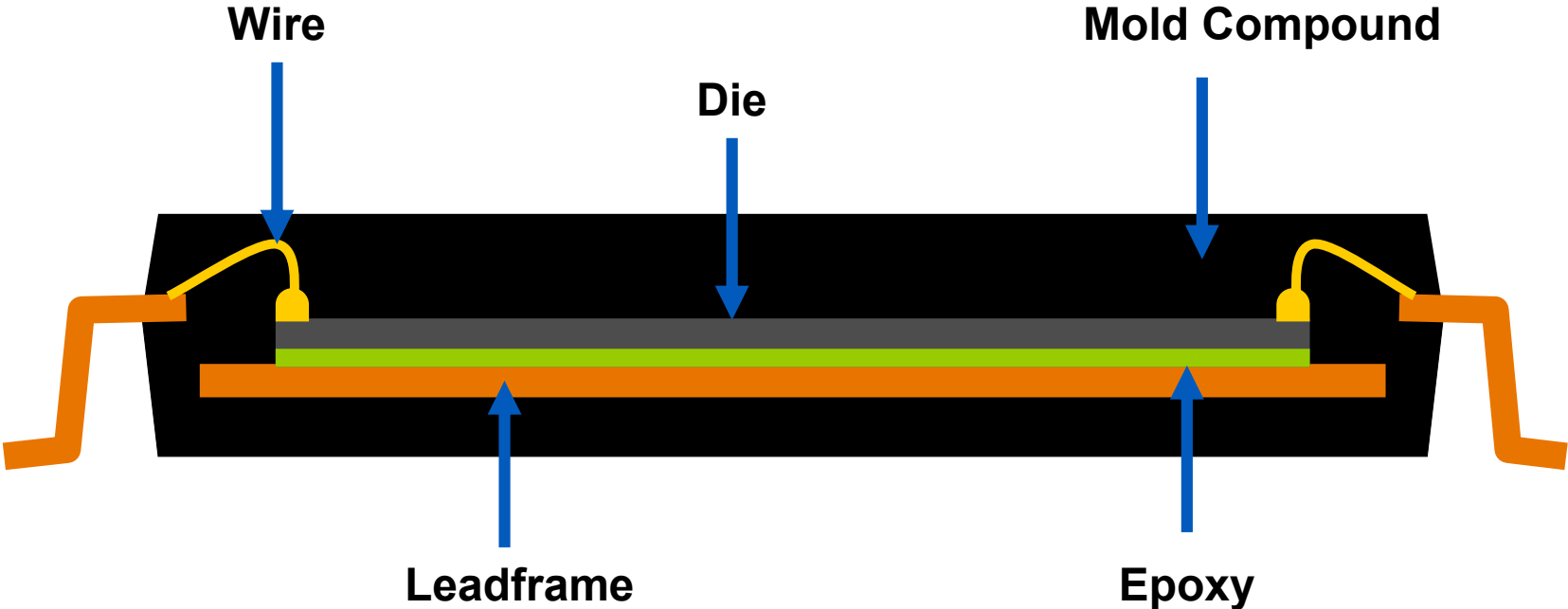

SSOP

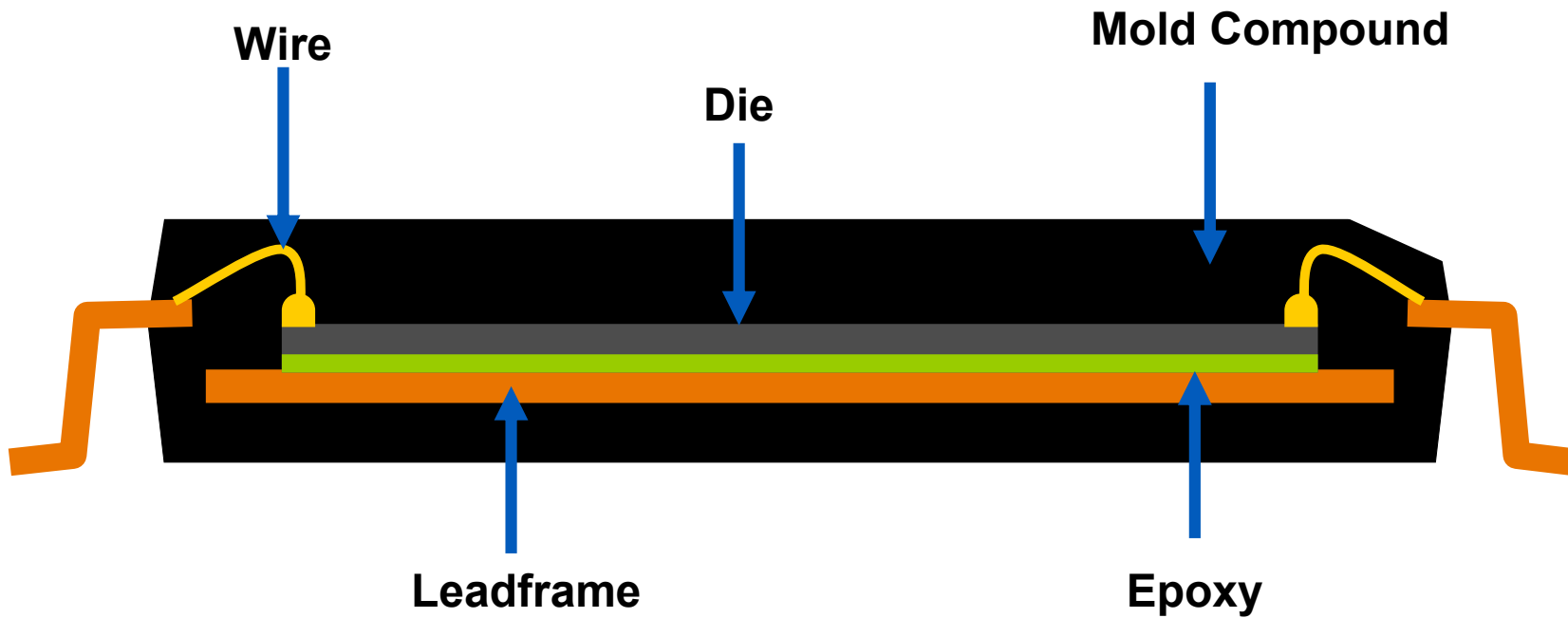

SOJ

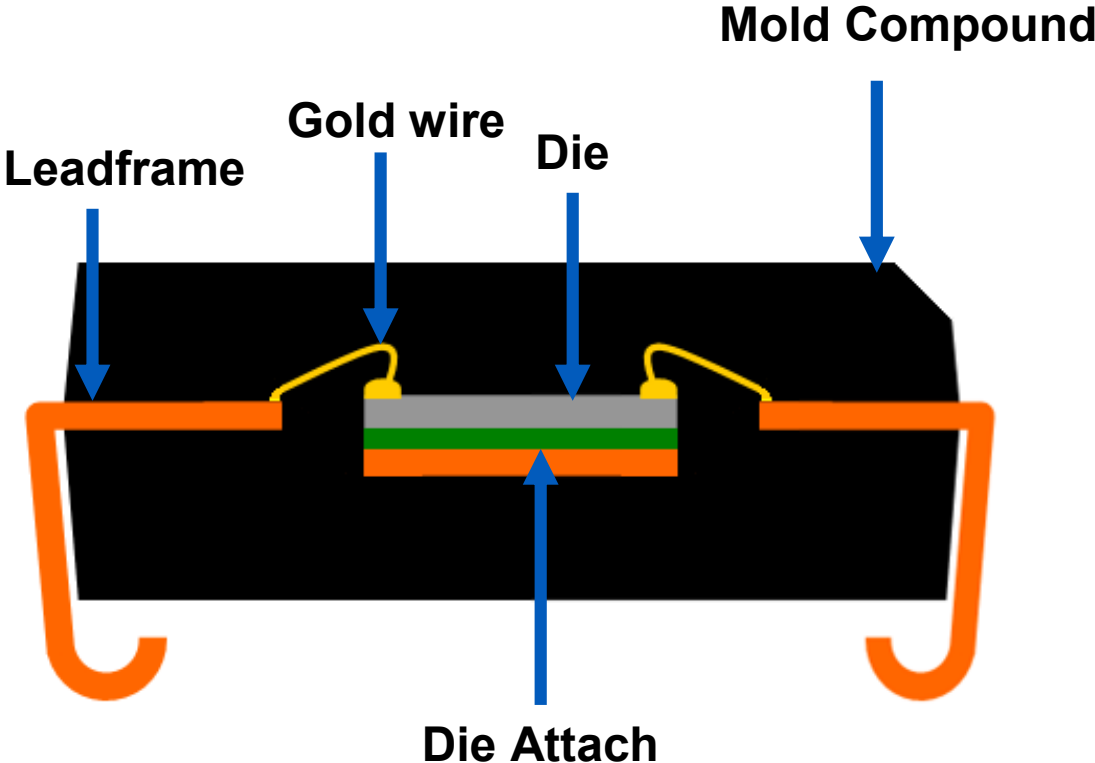

TSSOP / TSOP

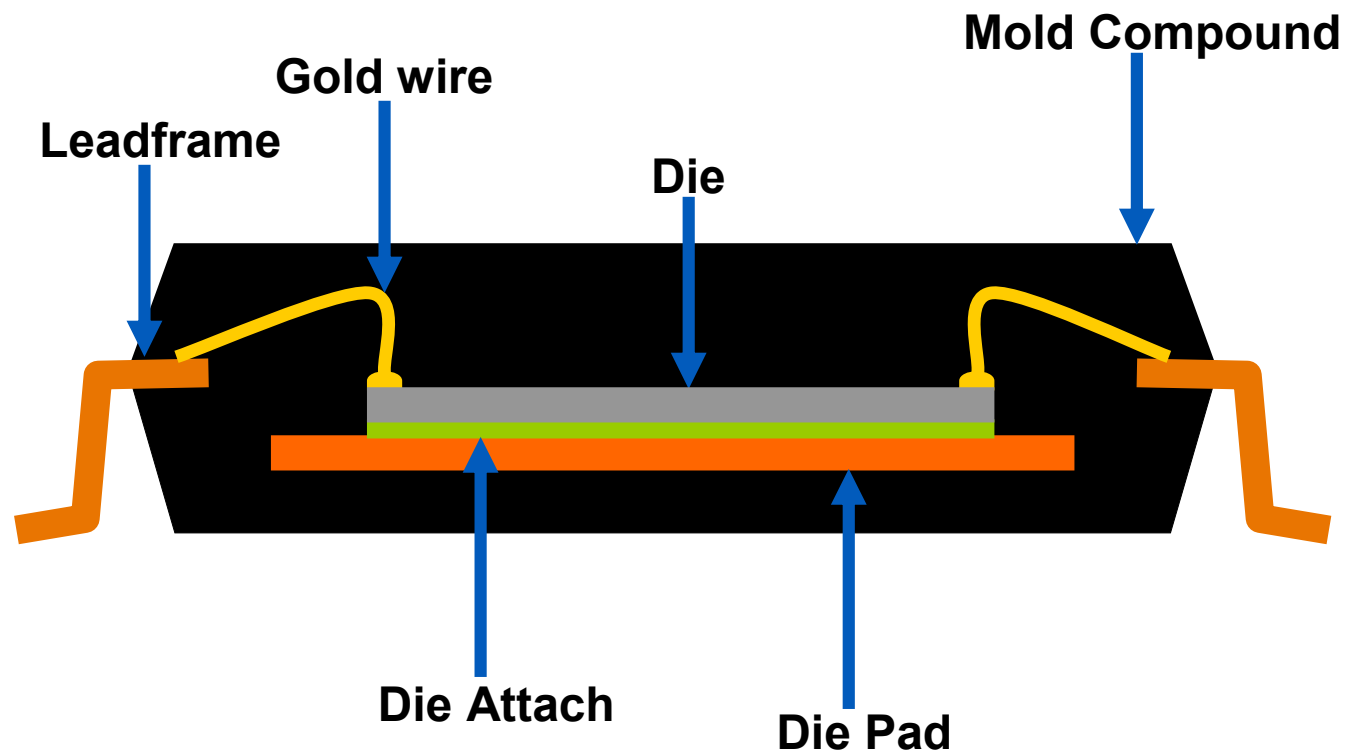

TSOP (STACKED DIE)

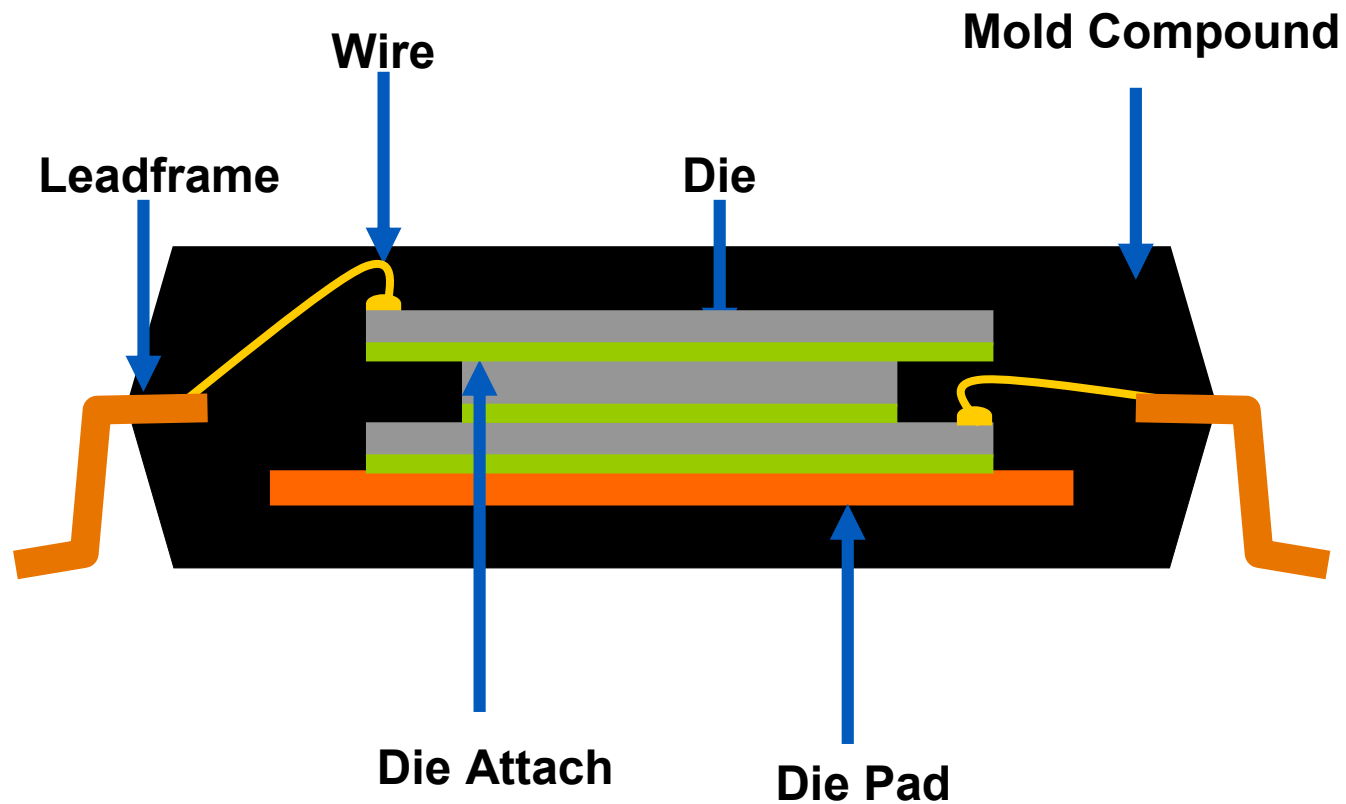

TQFP/PQFP

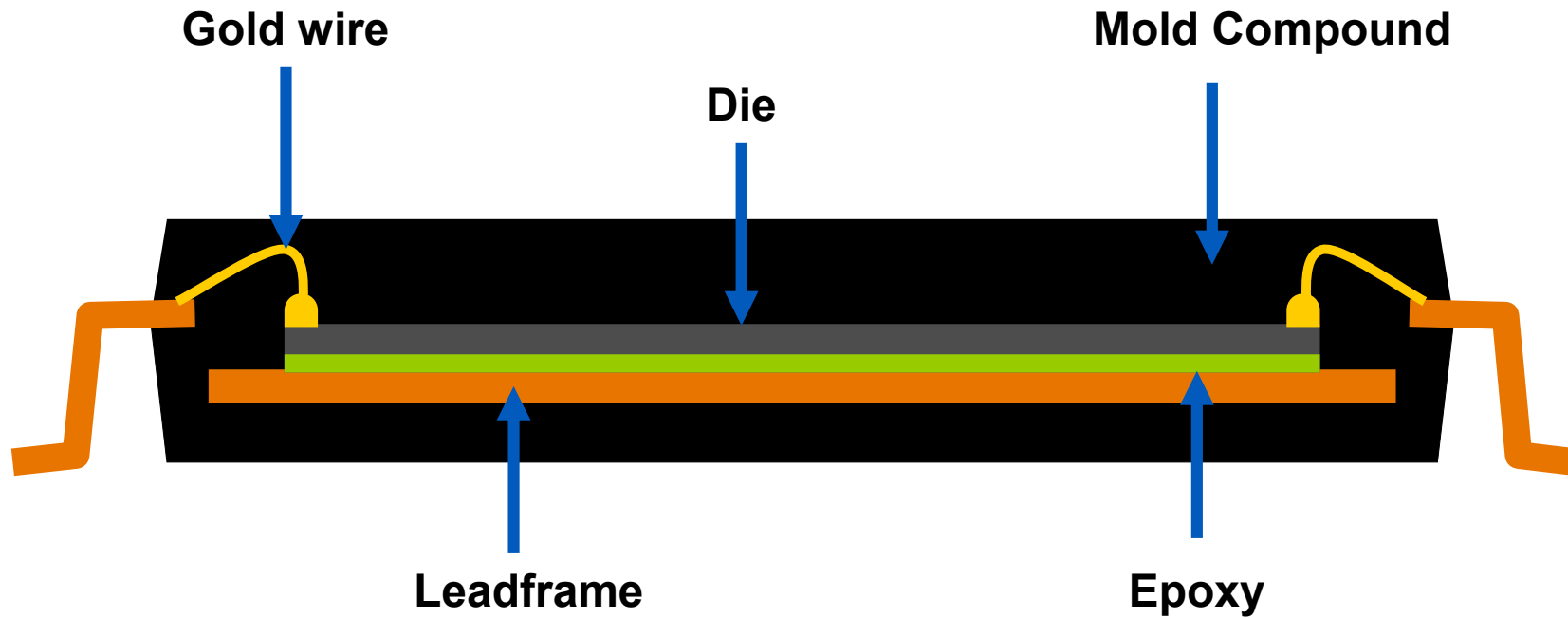

BGA

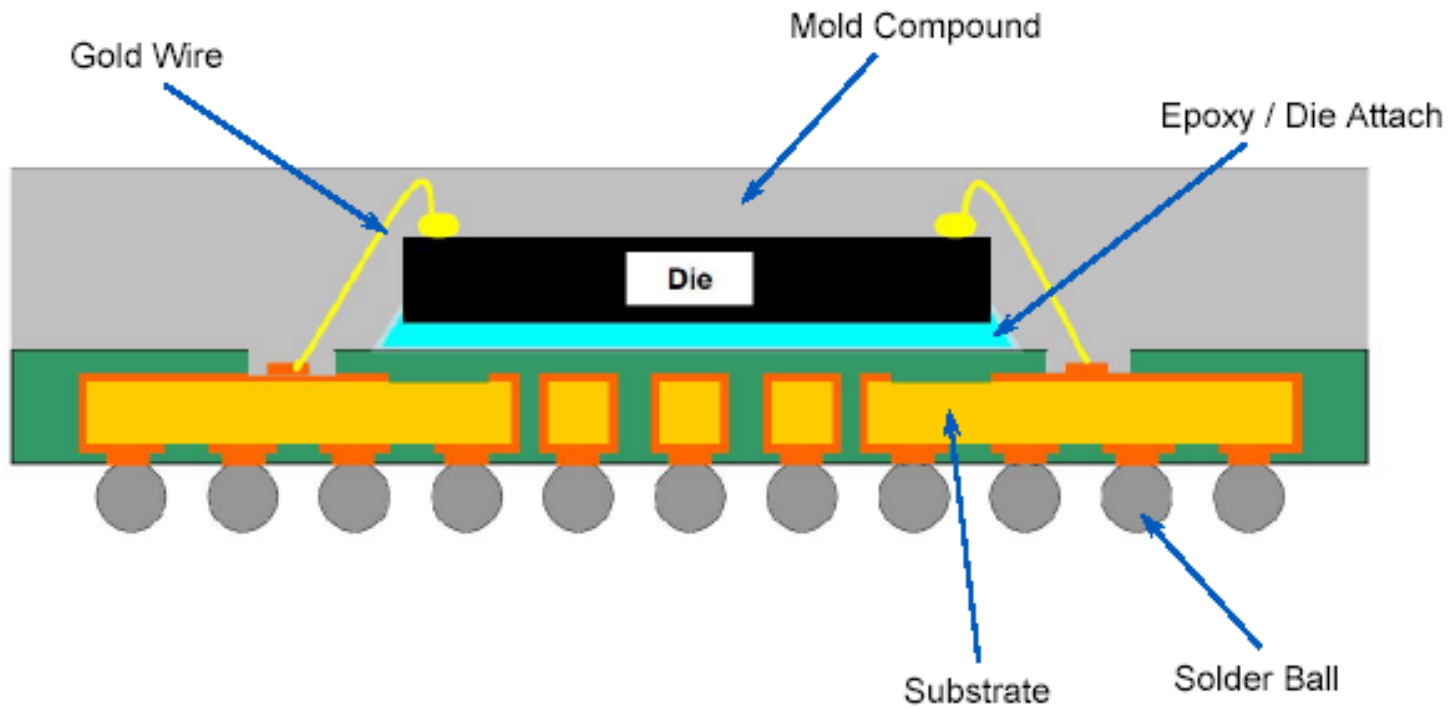

BGA (STACKED DIE)

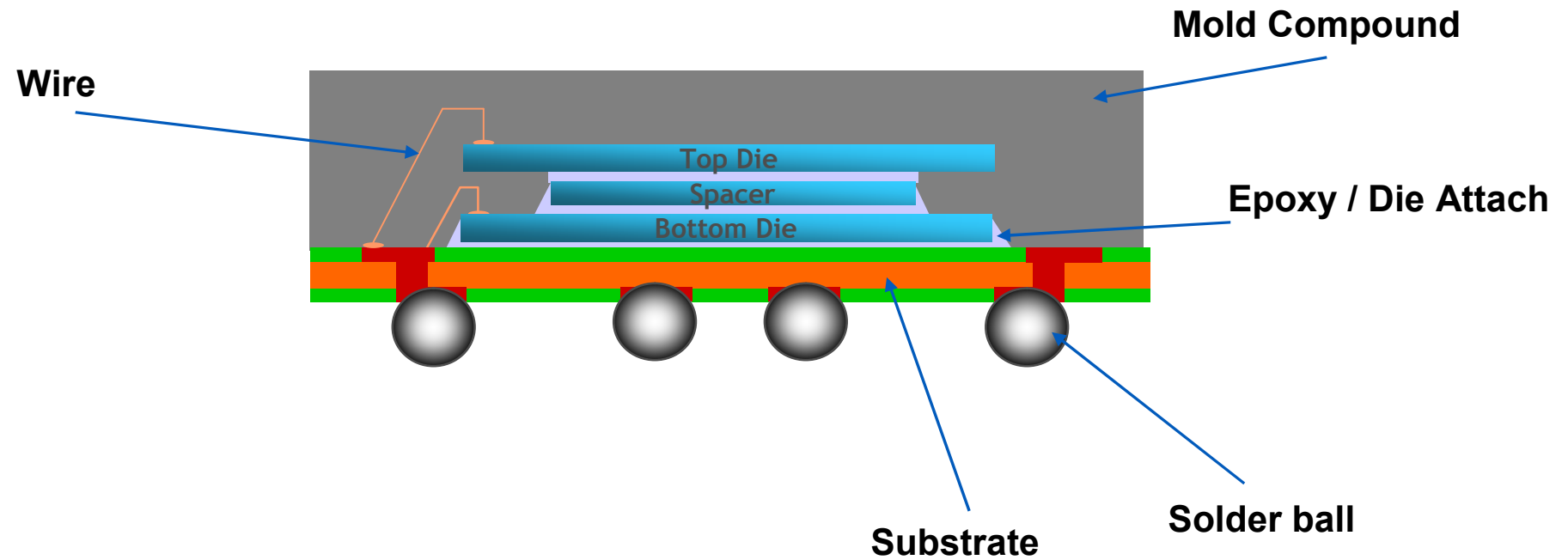

PLCC

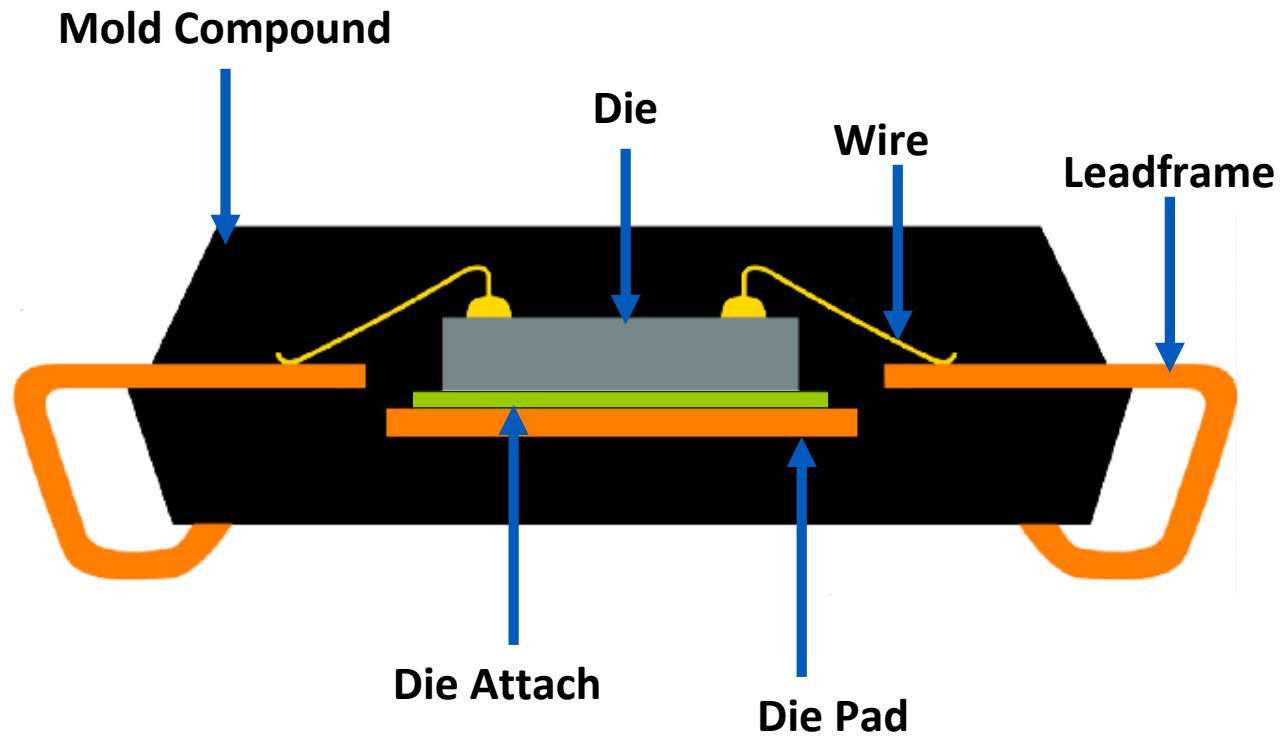

QFN (SAW)

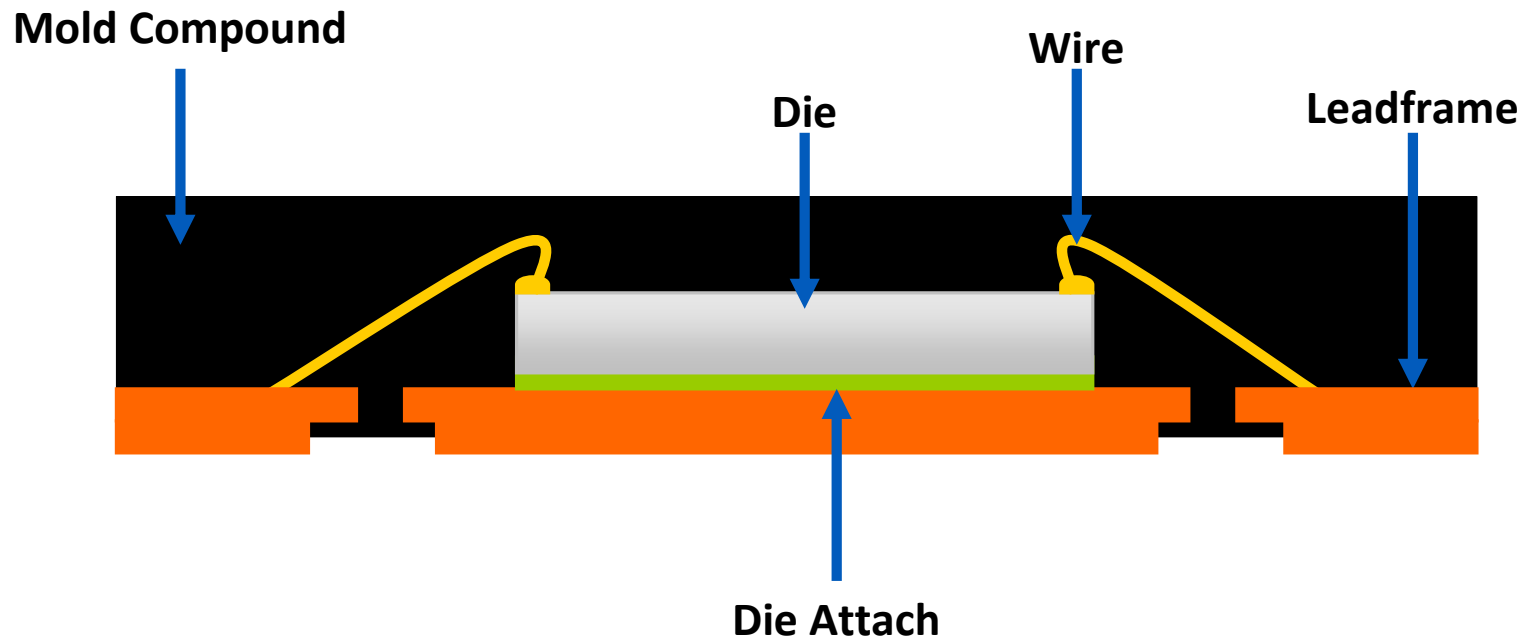

QFN (PUNCH)

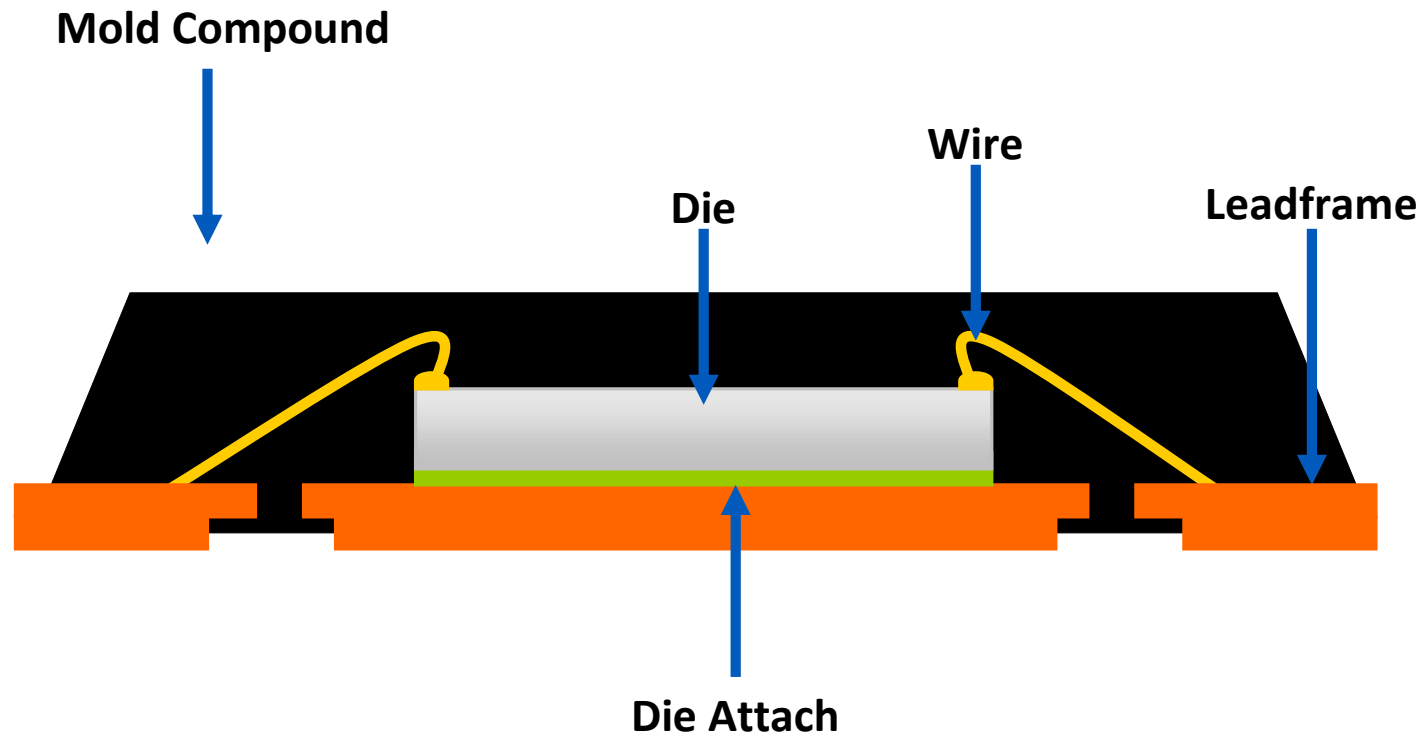

WLCSP

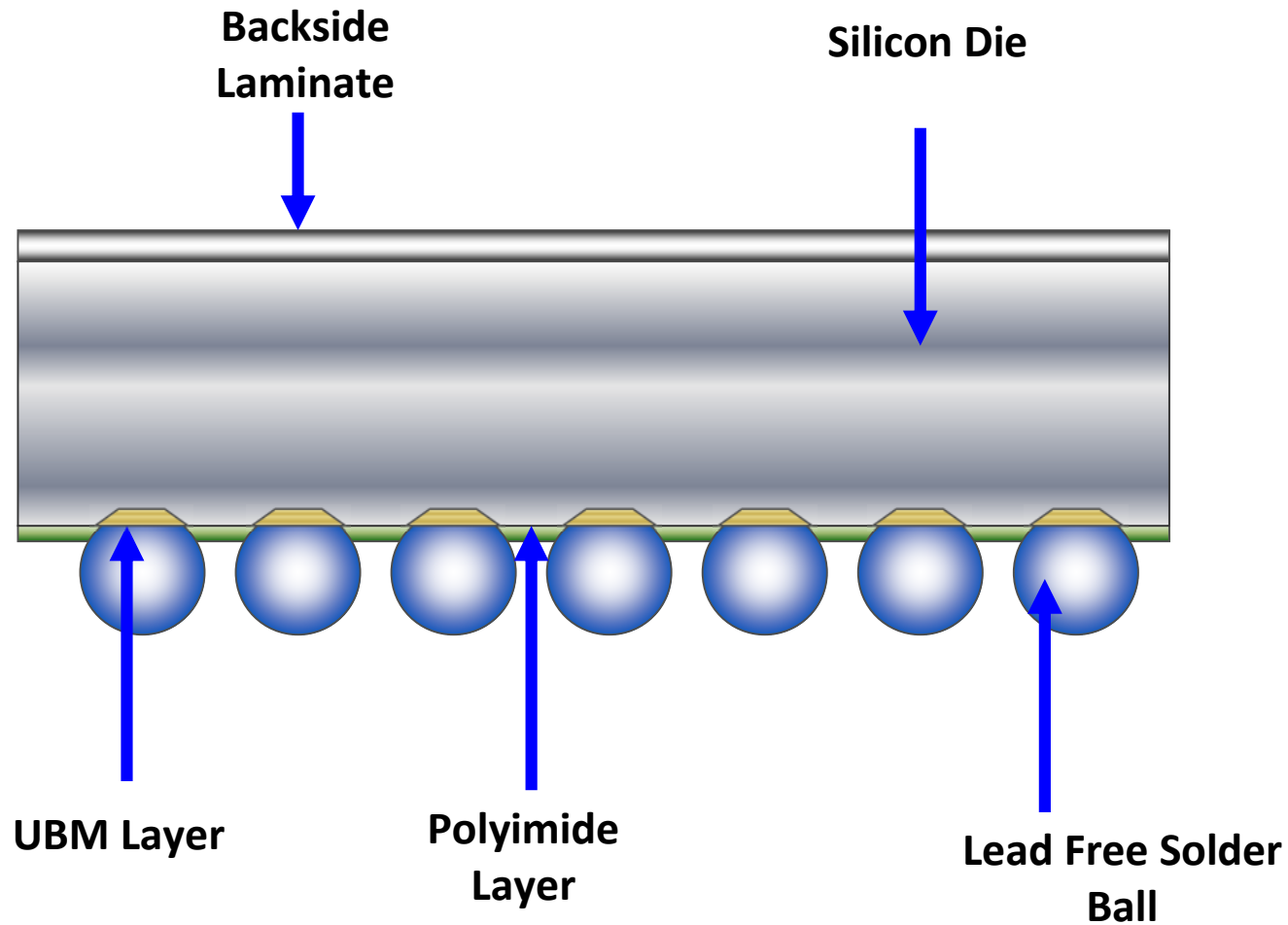

LCC

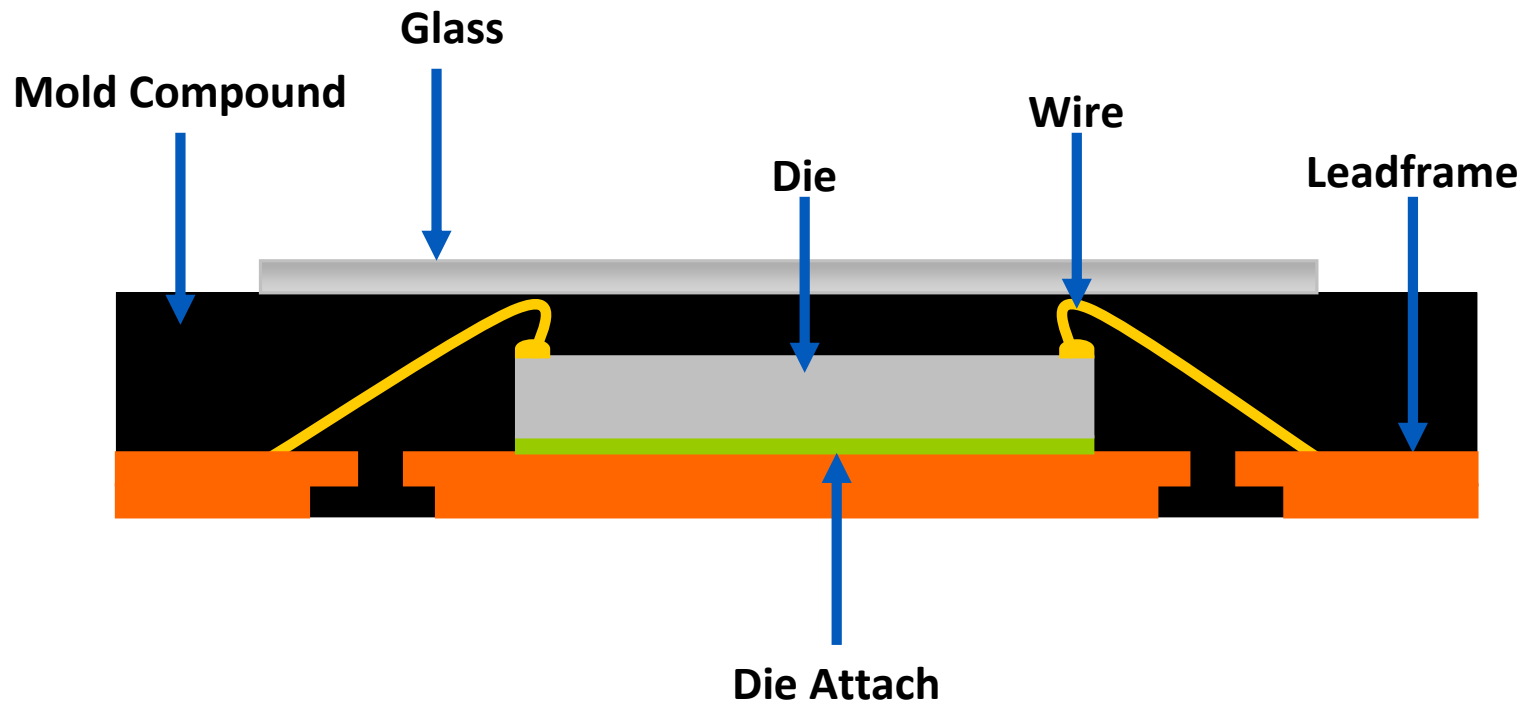

CERDIP

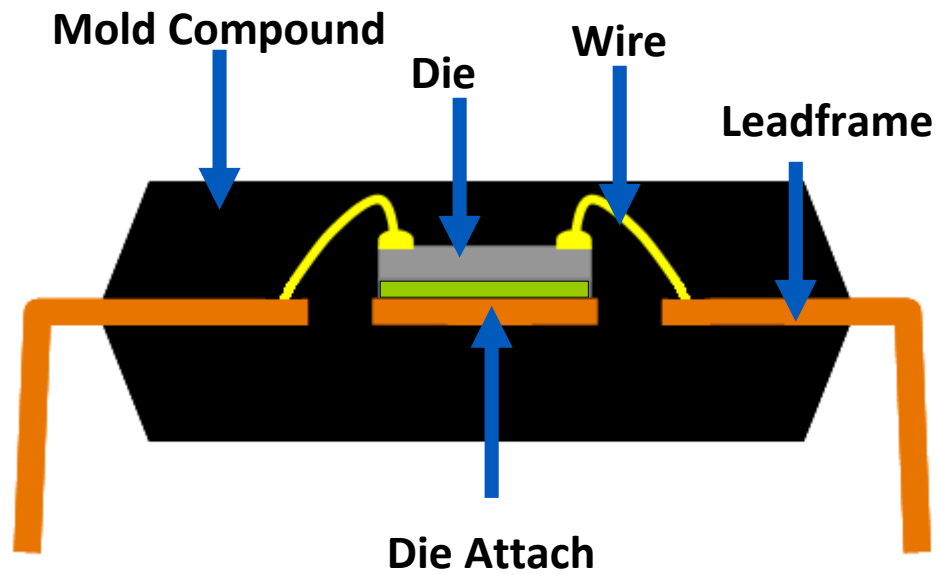

PGA

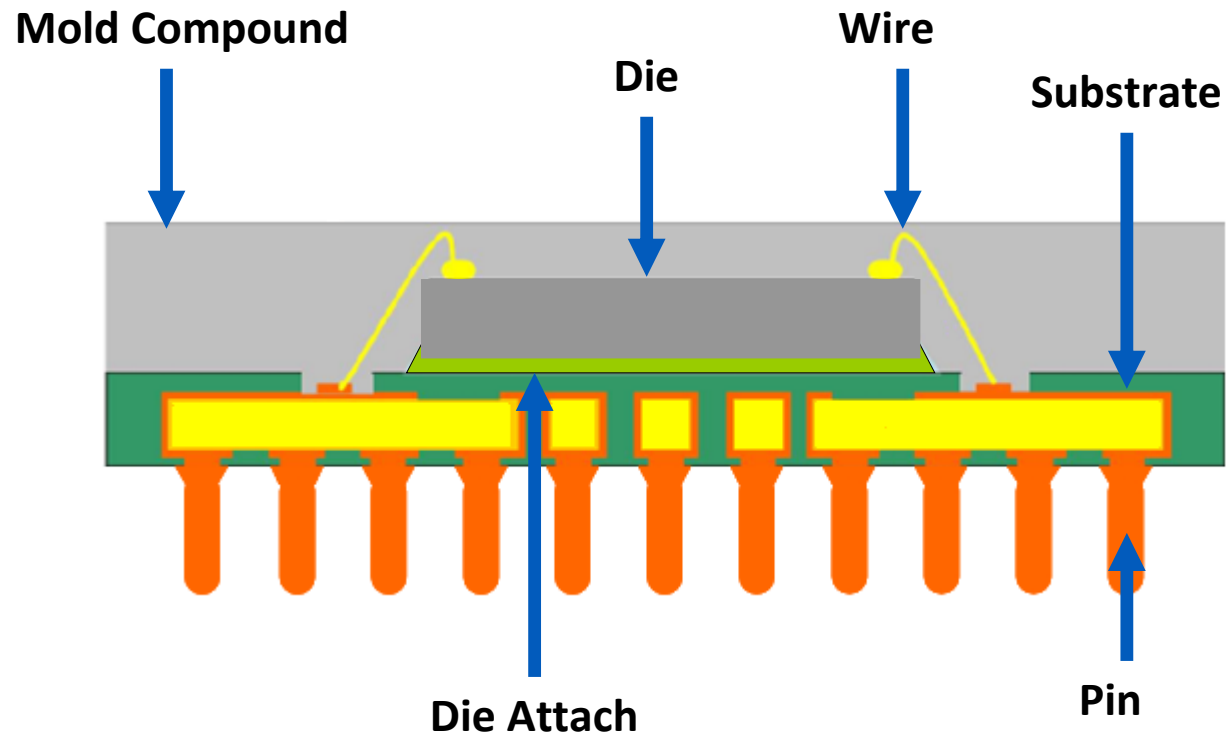

SOIC 28 (STACKED DIE)

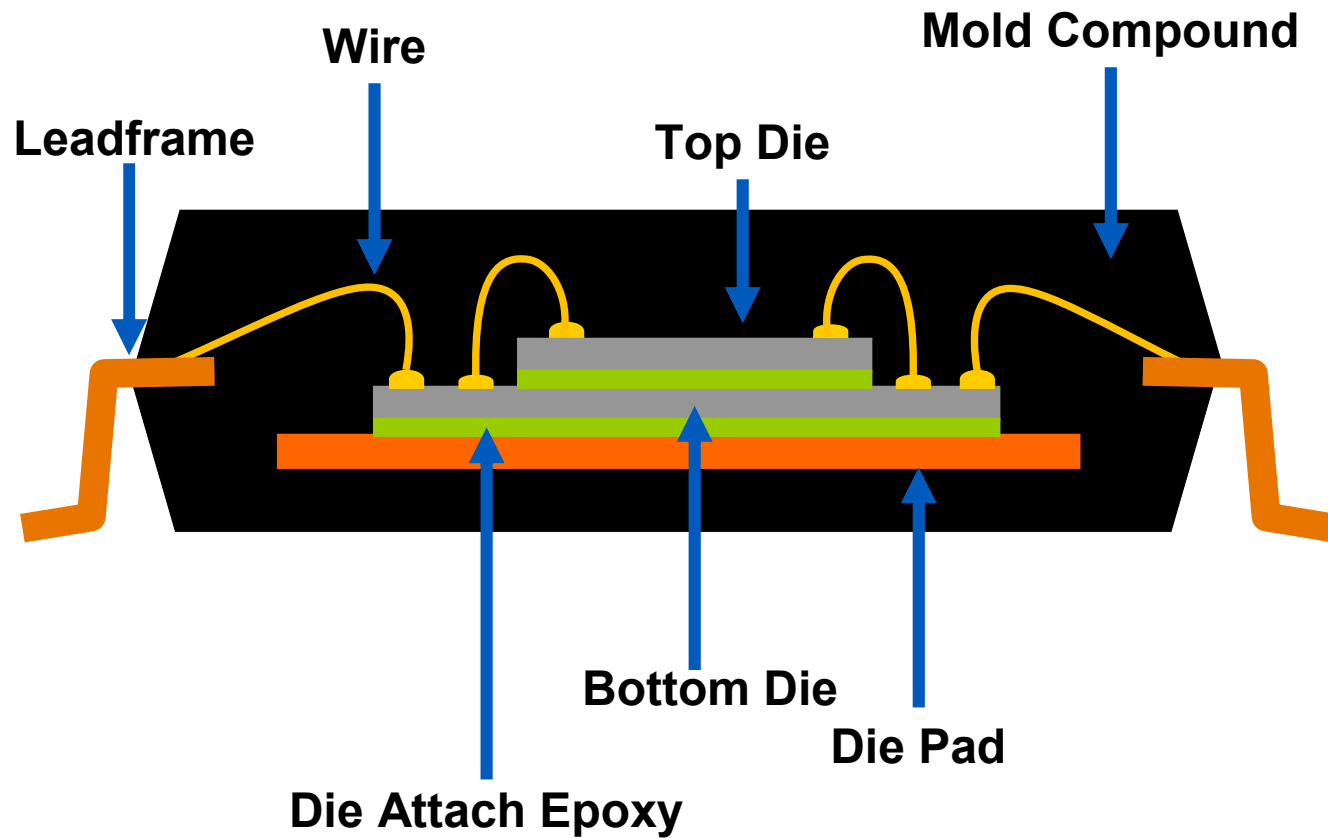

PDIP 28 (STACKED DIE)

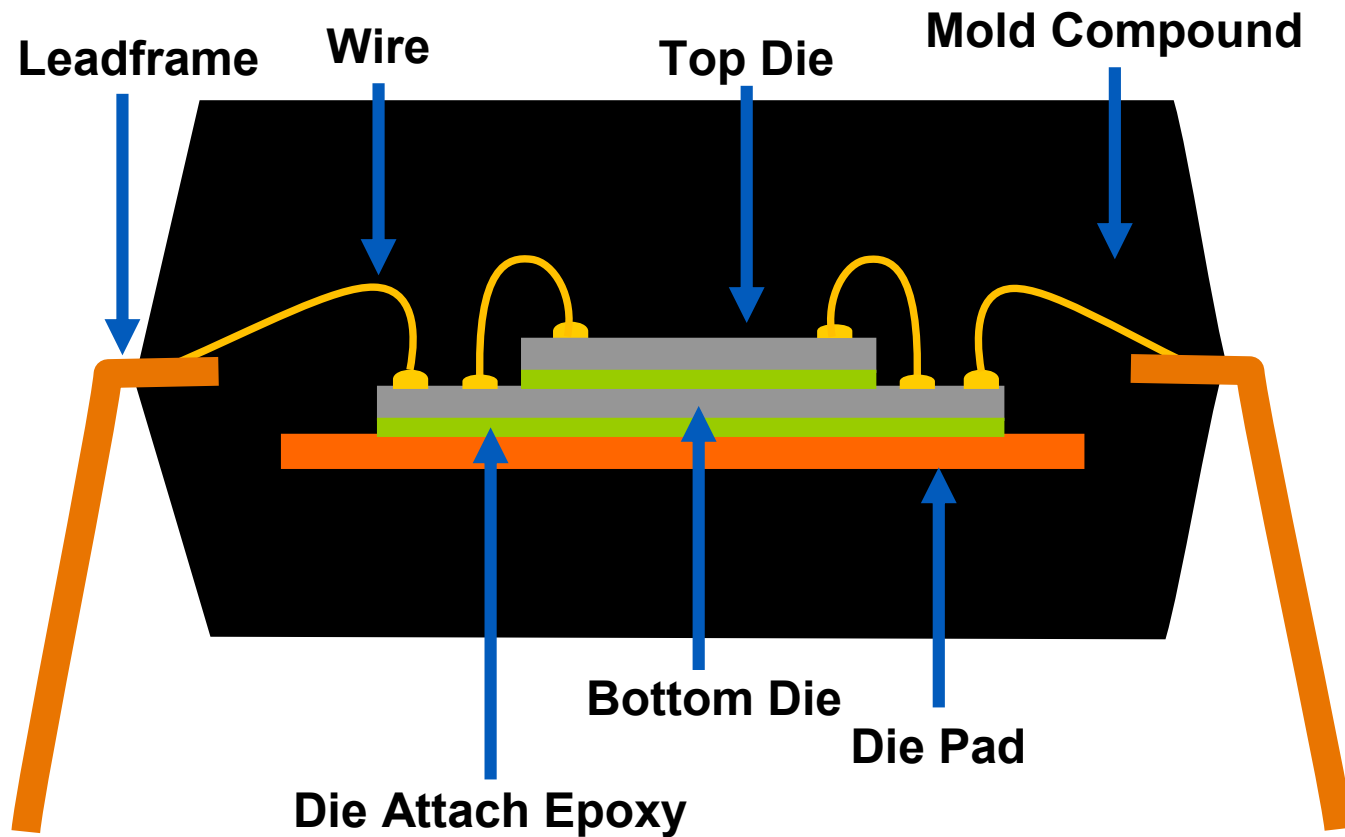

PDIP

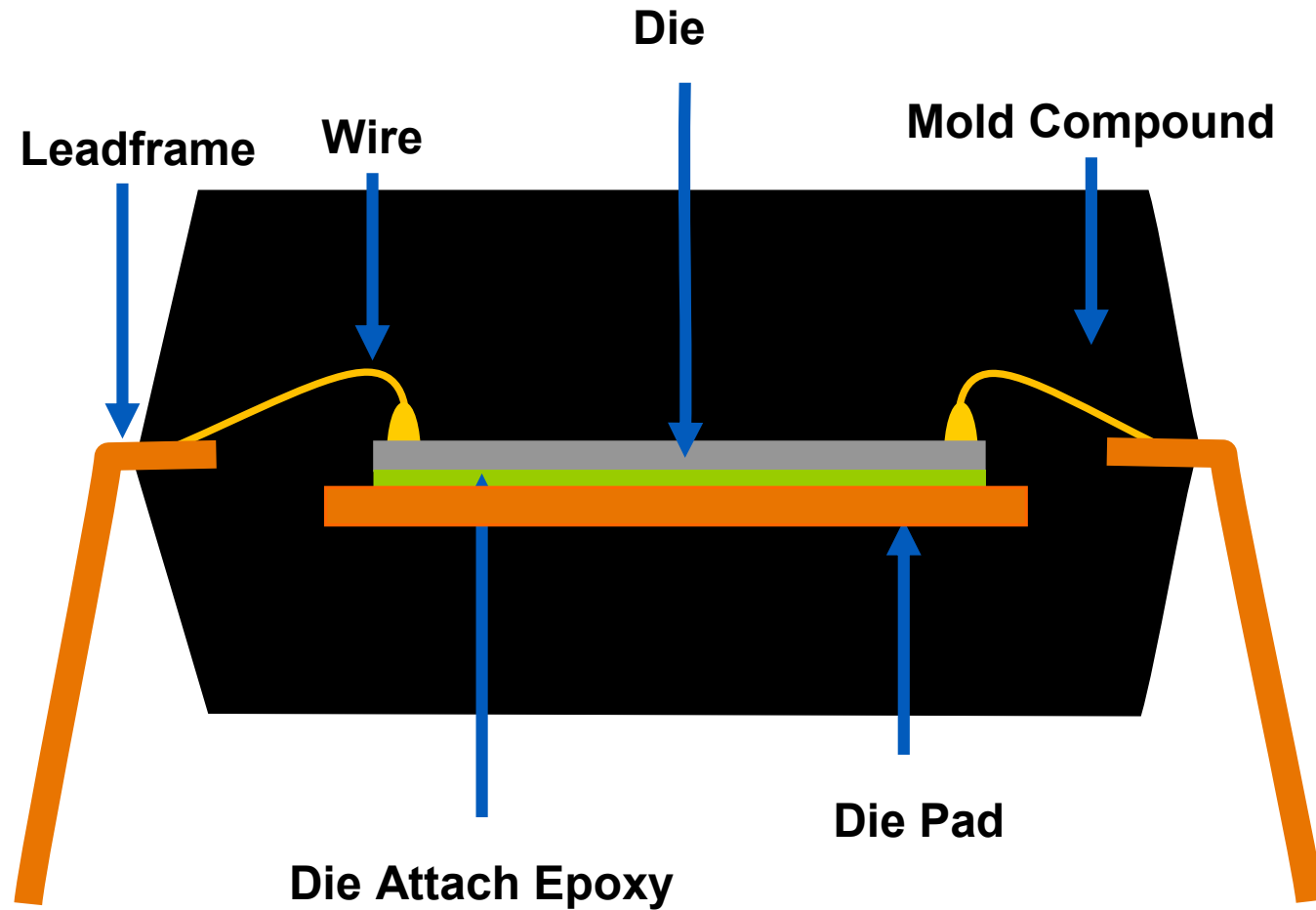

THE END

HISTORY PAGE



Revision	Owner	Description of Change
**	LMAG	Initial Release
Rev. 1	JARG	<ol style="list-style-type: none">1. Added Cross Section Drawing for BGA (STACKED DIE) Package [Page 9]2. Updated WLCSP Cross Section Drawing [Page 13]3. Change Document Title from Package Cross - Section to PACKAGE CROSS - SECTION DRAWINGS [Page 1]4. Add Month and Year on the first page to reflect the date of revision / update [Page 1]
Rev. 2	JARG	<ol style="list-style-type: none">1. Added SOIC28 (Stacked Die) Package Cross Section Drawing (Page 17)2. Added PDIP28 (Stacked Die) Package Cross Section Drawing (Page 18)
Rev. 3	JARG	<ol style="list-style-type: none">1. Added Cross section drawing of PDIP Package on (Page 19)