

Handcrafting Textile Sensors from Scratch

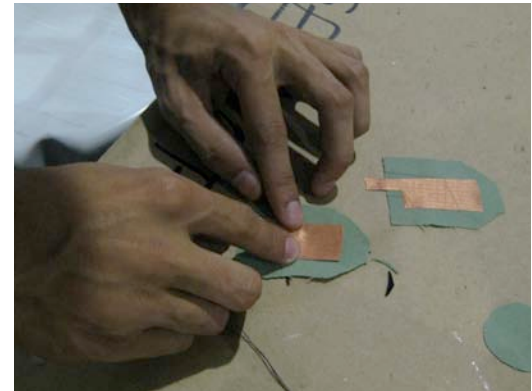
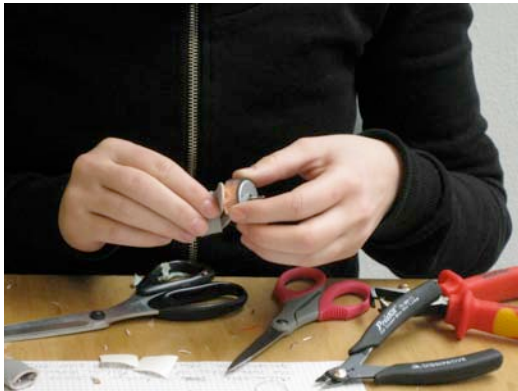

Materials

Conductive

- Stretch conductive fabric - Silver plated Nylon
- Conductive thread - 117/17 2ply silver plated Nylon
- Conductive thread - 234/34 2ply silver plated Nylon
- Metal beads

Conductive with high resistance (resistive)

- Resistive thread - 66 Yarn 22+3ply 110 PET
- Resistive yarn - Polyester and Inox steel fiber
- Velostat/Linqstat - Carbon impregnated Polyethylene film

Non-Conductive (isolating)

- Neoprene - 1.5mm with polyester jersey fused to both sides
- Felting wool
- Foam
- Fusible Interfacing - "Iron-on"
- Anti-fray or Fabric glue

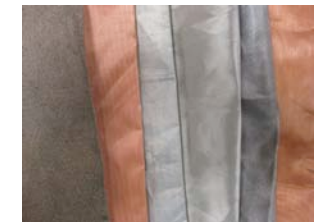

Tools

- Sewing needles
- Knitting needles
- Crochet hooks
- Circular knitting machine
- Spool knitter
- Needle felting tool
- Needle felting mat
- Hole maker
- Iron
- Multimeter
- LilyPad Arduino Mainboard
- LilyPad sewable LEDs

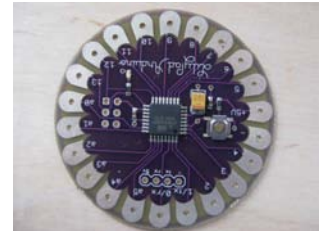

Textile Sensors

- Fabric Button
- Pressure Sensor
- Pressure Sensor Matrix
- Bend Sensor
- Tilt Sensor
- Fabric Potentiometer
- Crochet Potentiometer
- Stroke Sensor
- Knit Stretch Sensor

Bend Sensor

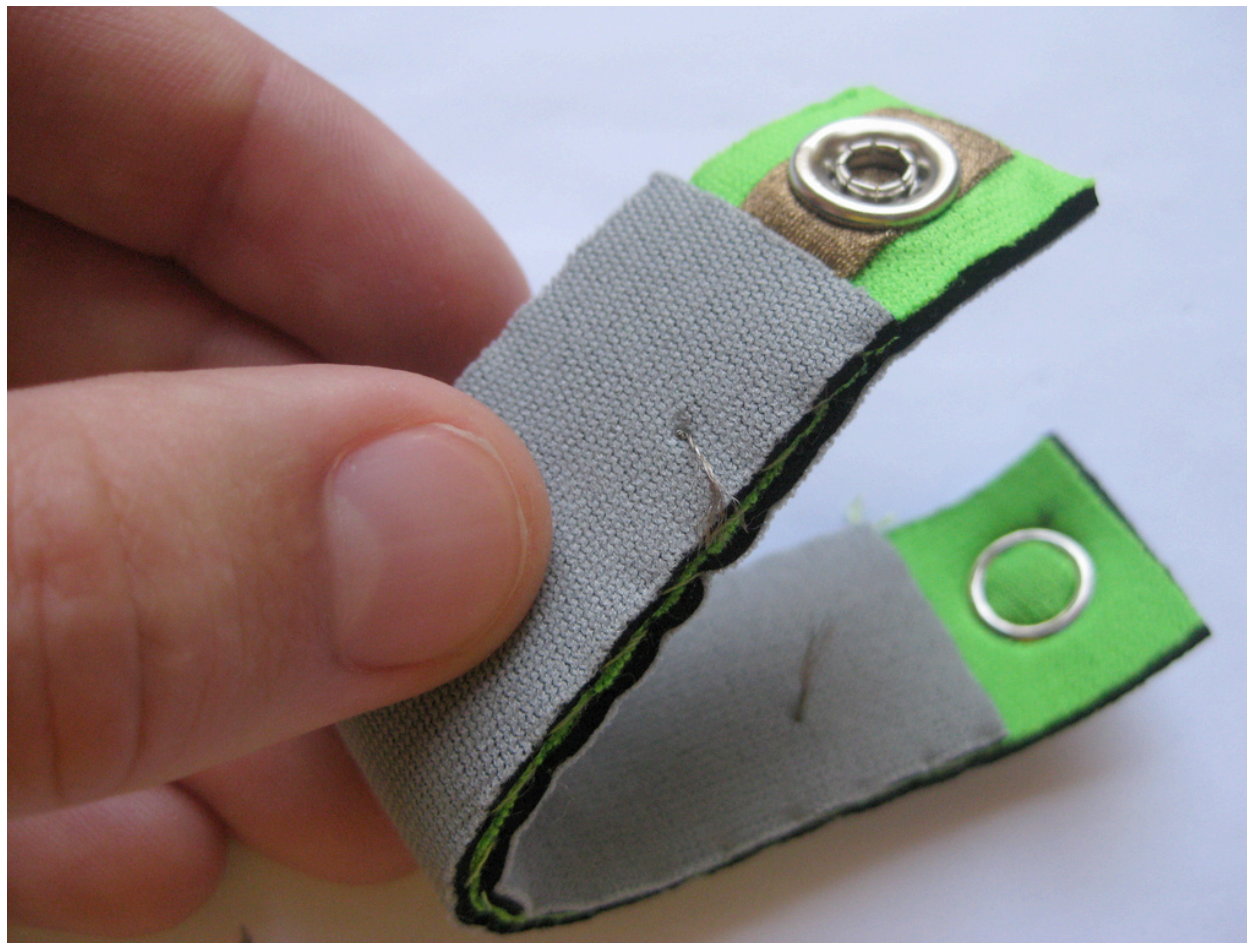

Bend Sensor

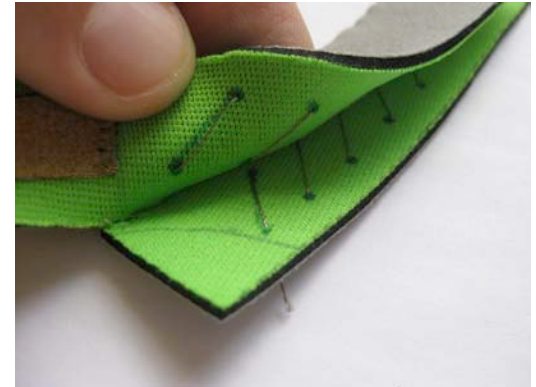
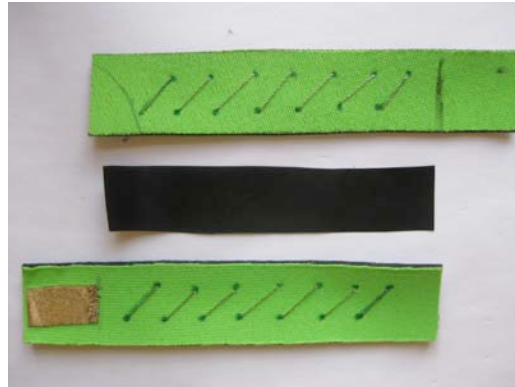
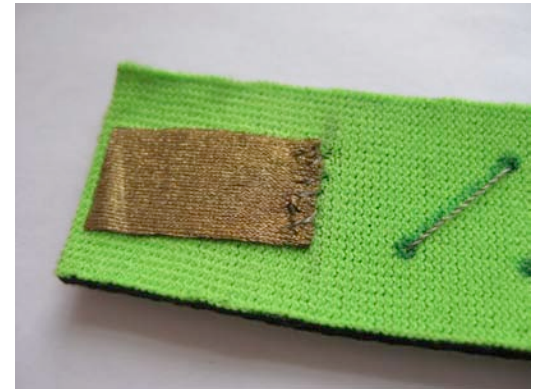
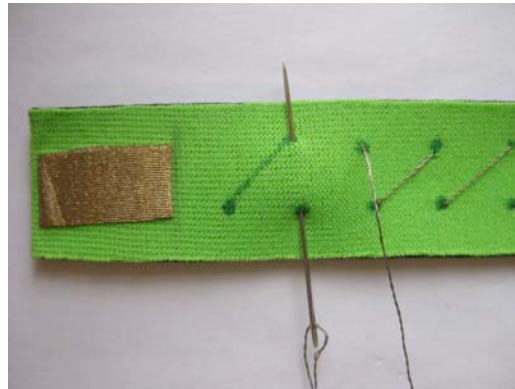

MATERIALS

- Neoprene
- Conductive thread
- Stretch conductive fabric
- Fusible interfacing
- Velostat



Bend Sensor

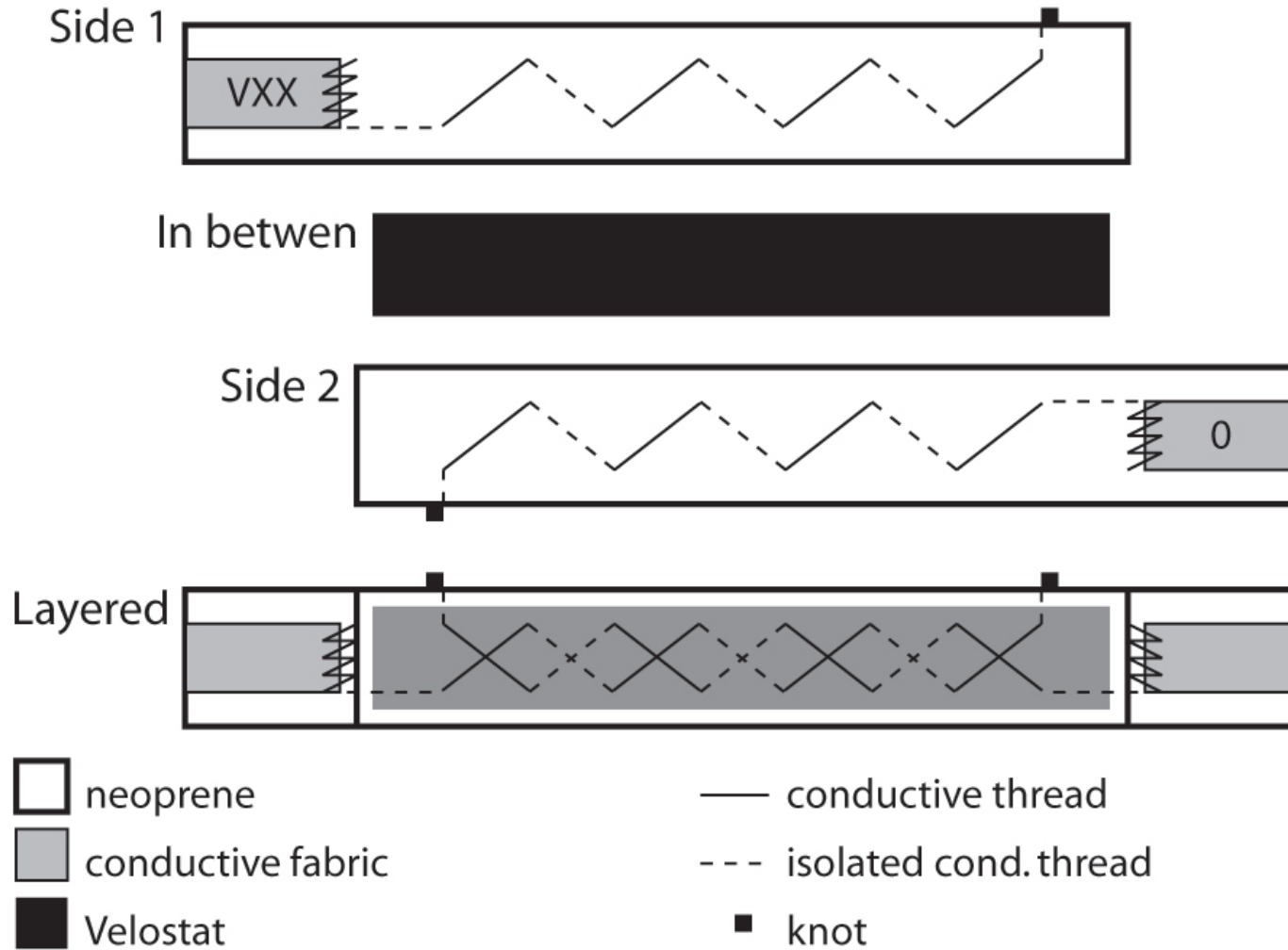

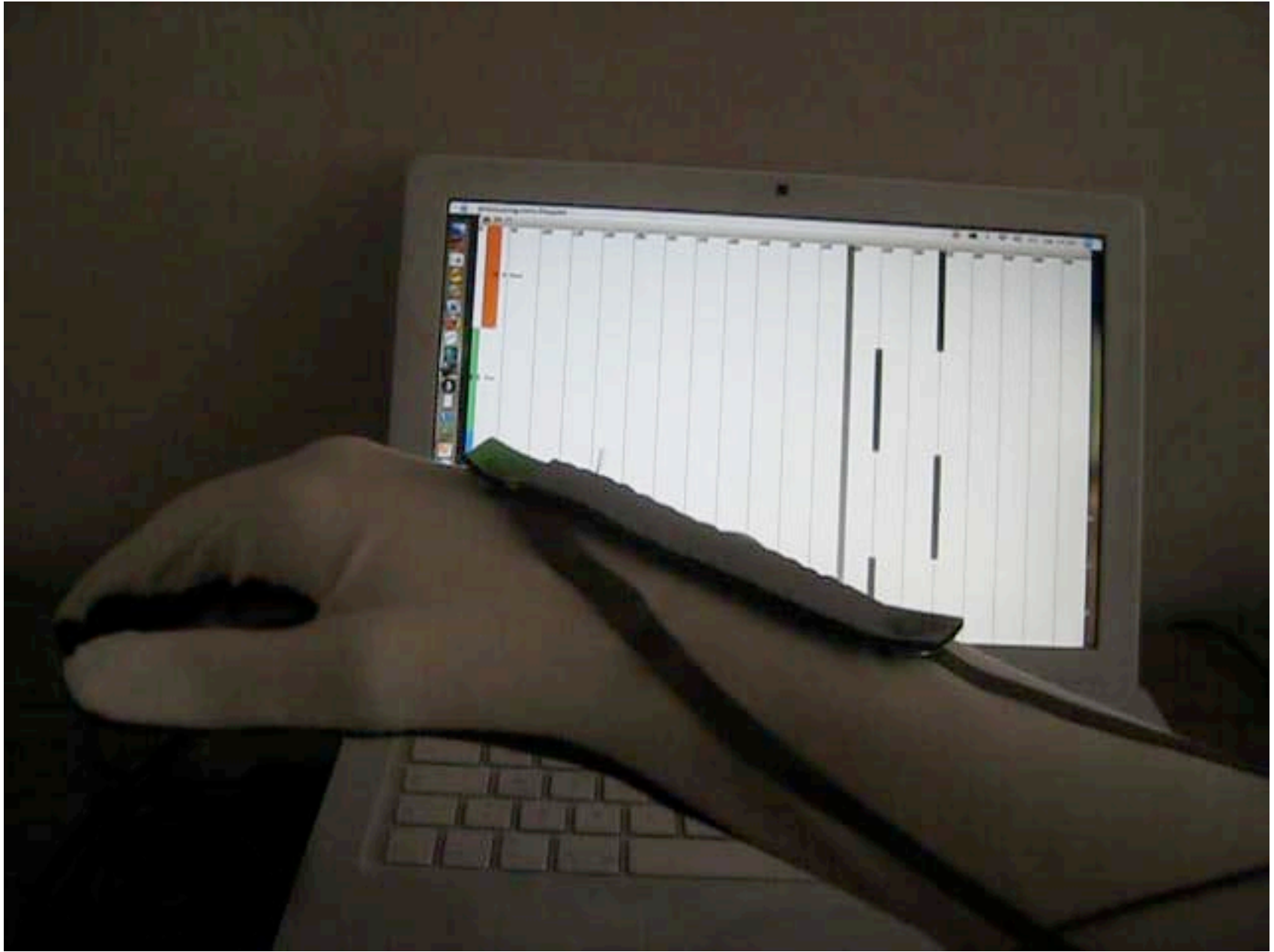

Pressure Sensor

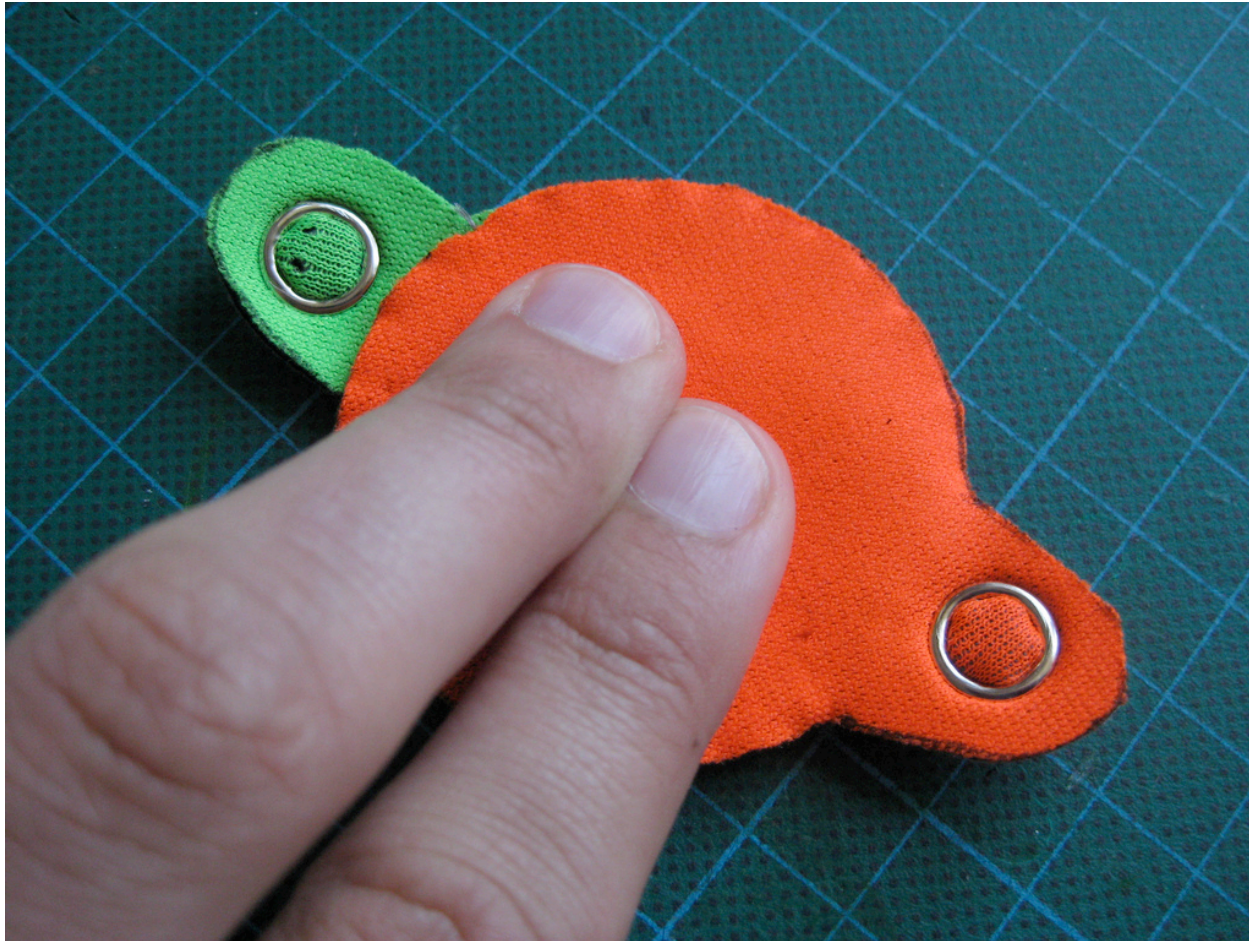

Pressure Sensor

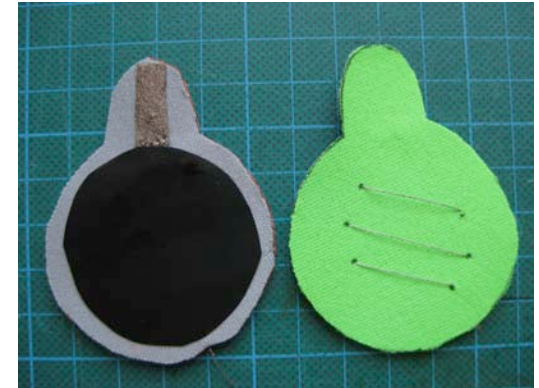
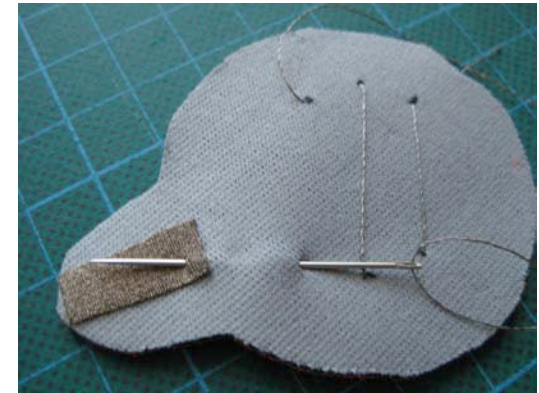
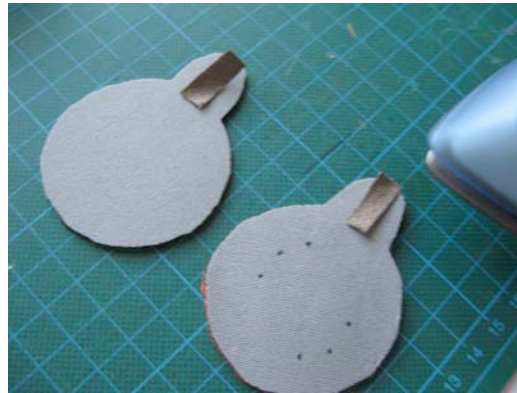

MATERIALS

- Neoprene
- Conductive thread
- Stretch conductive fabric
- Fusible interfacing
- Velostat

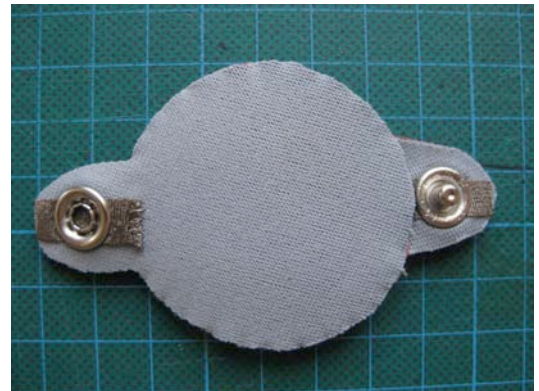

Pressure Sensor

SIDE A

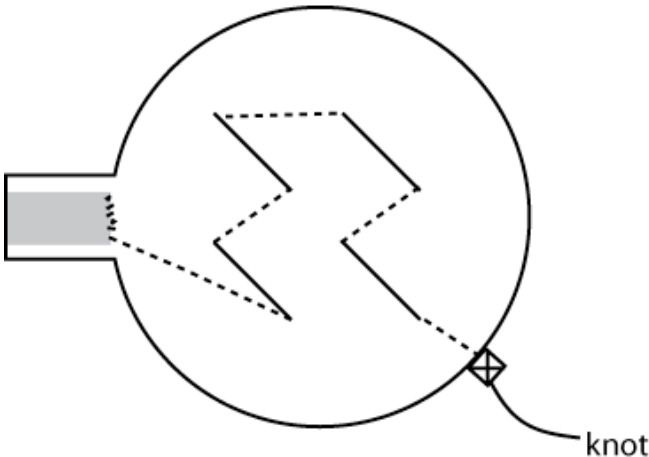

IN BETWEEN

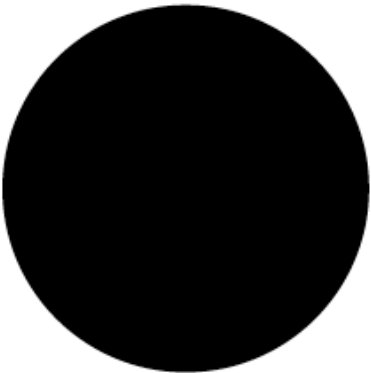

SIDE B

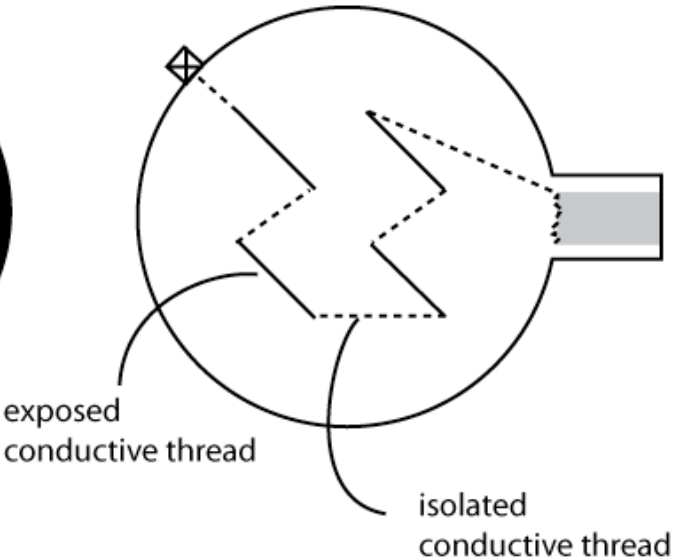



Pressure Sensor Matrix

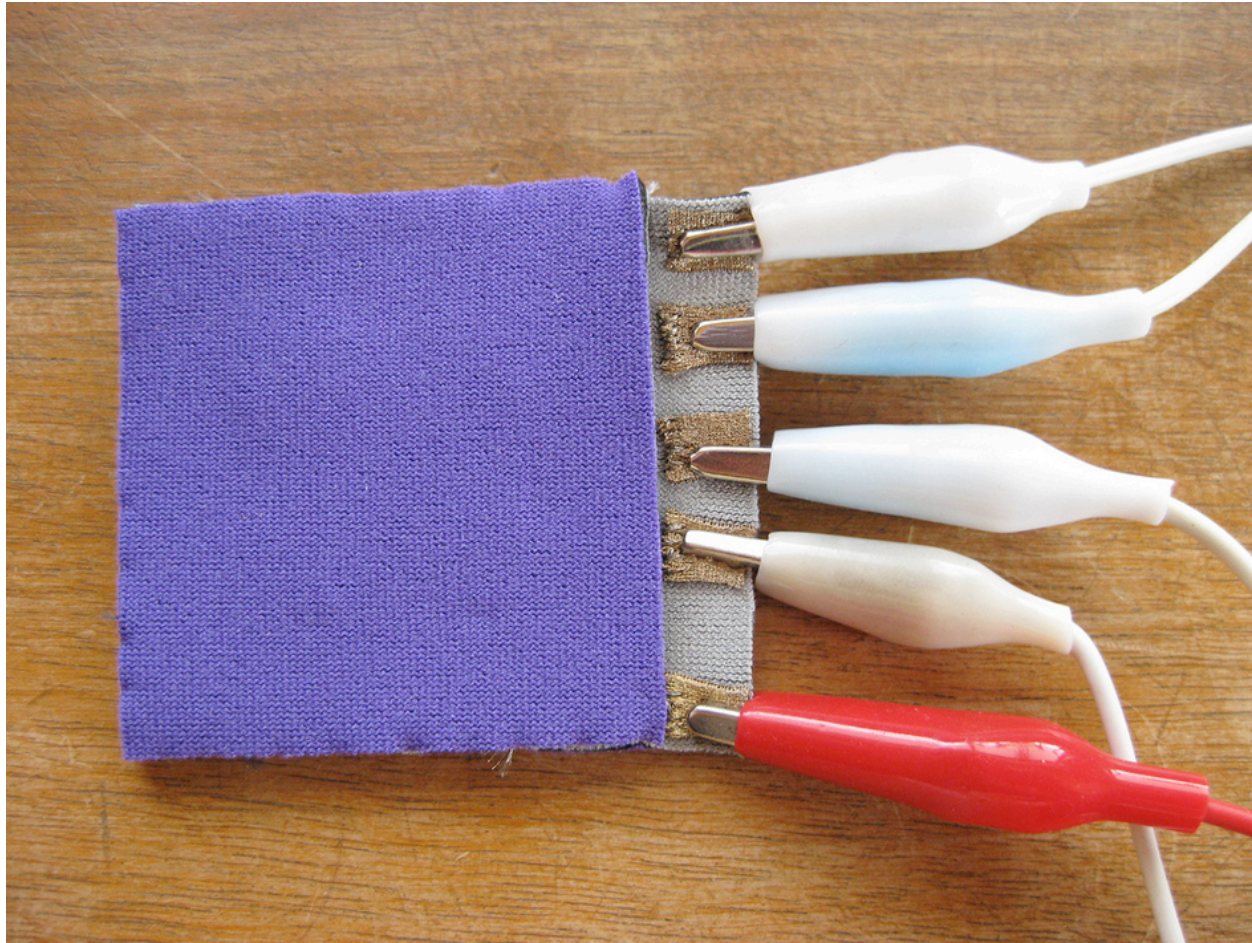

Pressure Sensor Matrix

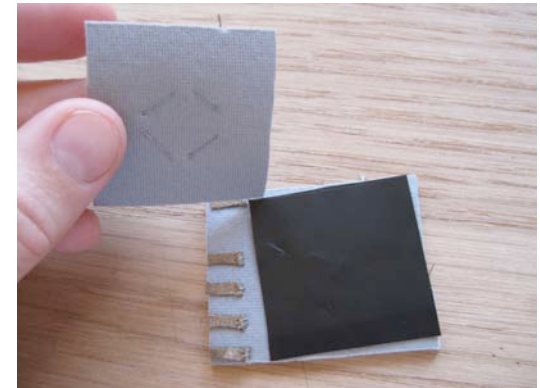
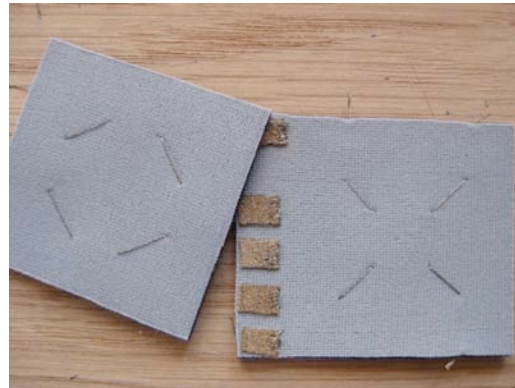
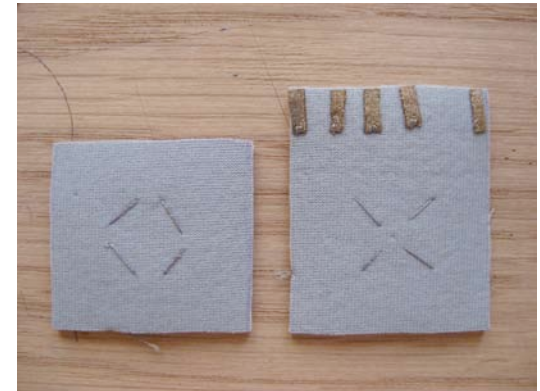
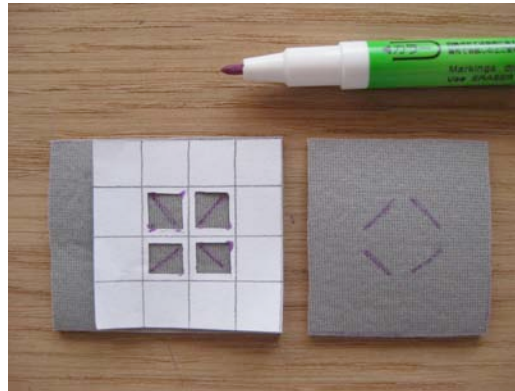

MATERIALS

- Neoprene
- Conductive thread
- Stretch conductive fabric
- Fusible interfacing
- Velostat

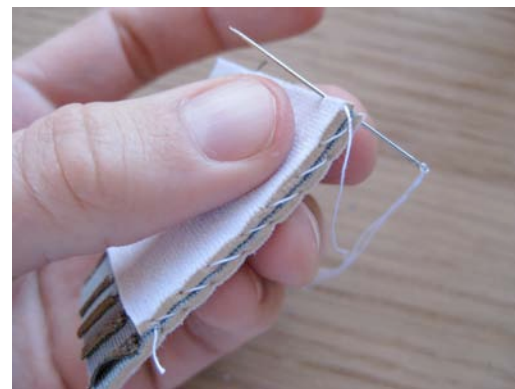

Pressure Sensor Matrix

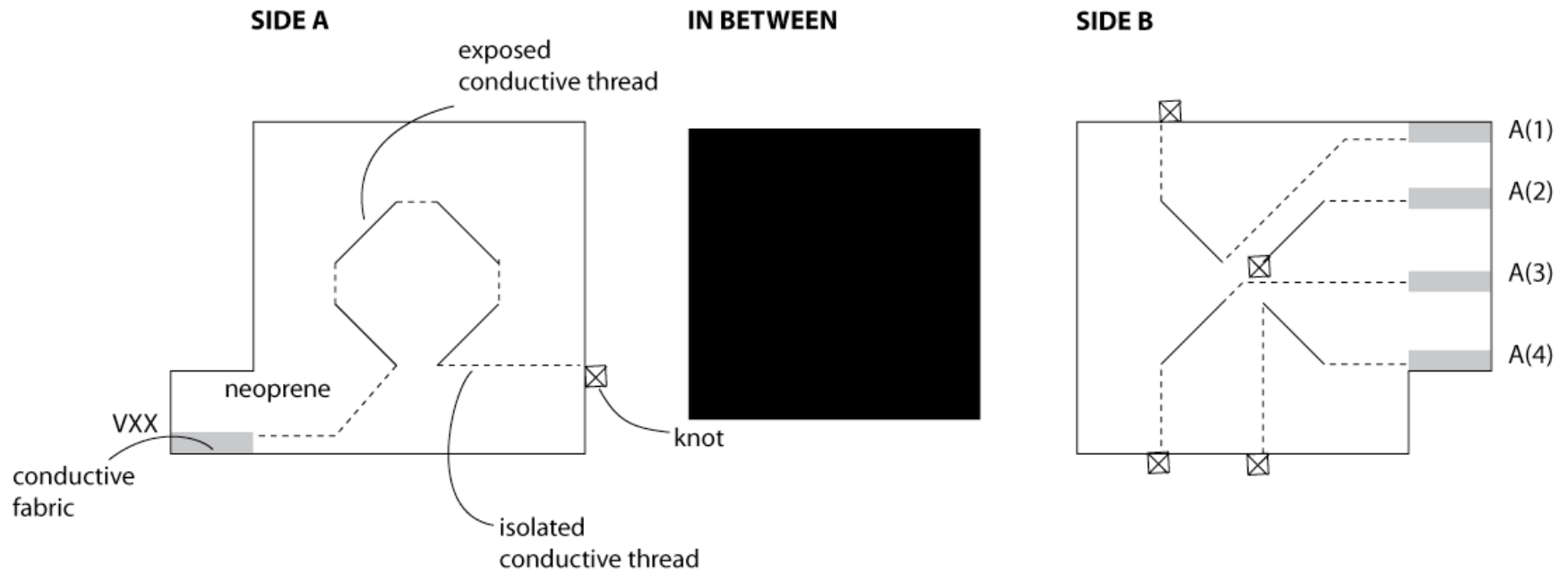

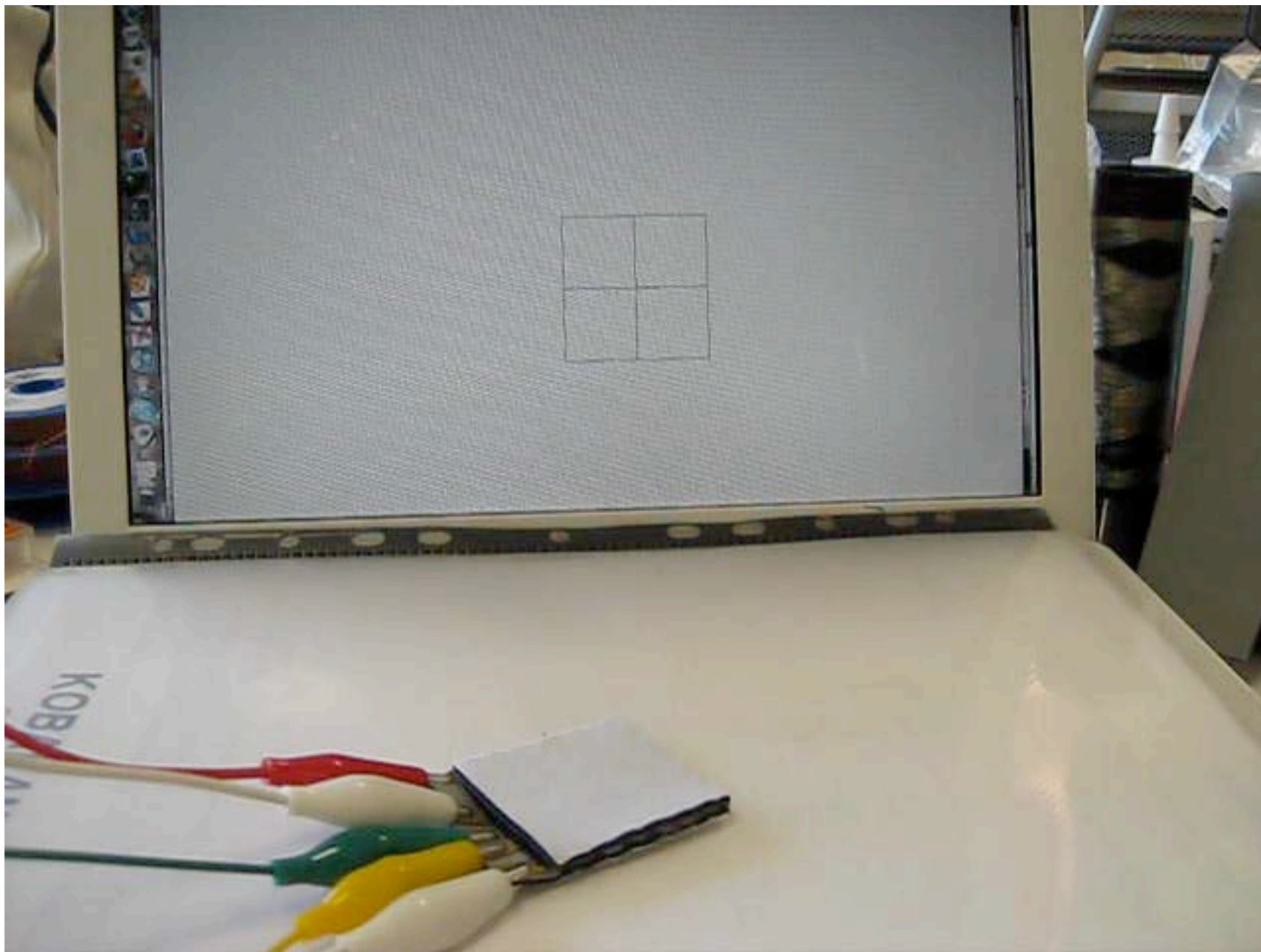

Tilt Sensor



Tilt Sensor



MATERIALS

- Neoprene
- Stretch conductive fabric
- Conductive thread
- Metal bead
- Stretchy fabric glue



Tilt Sensor

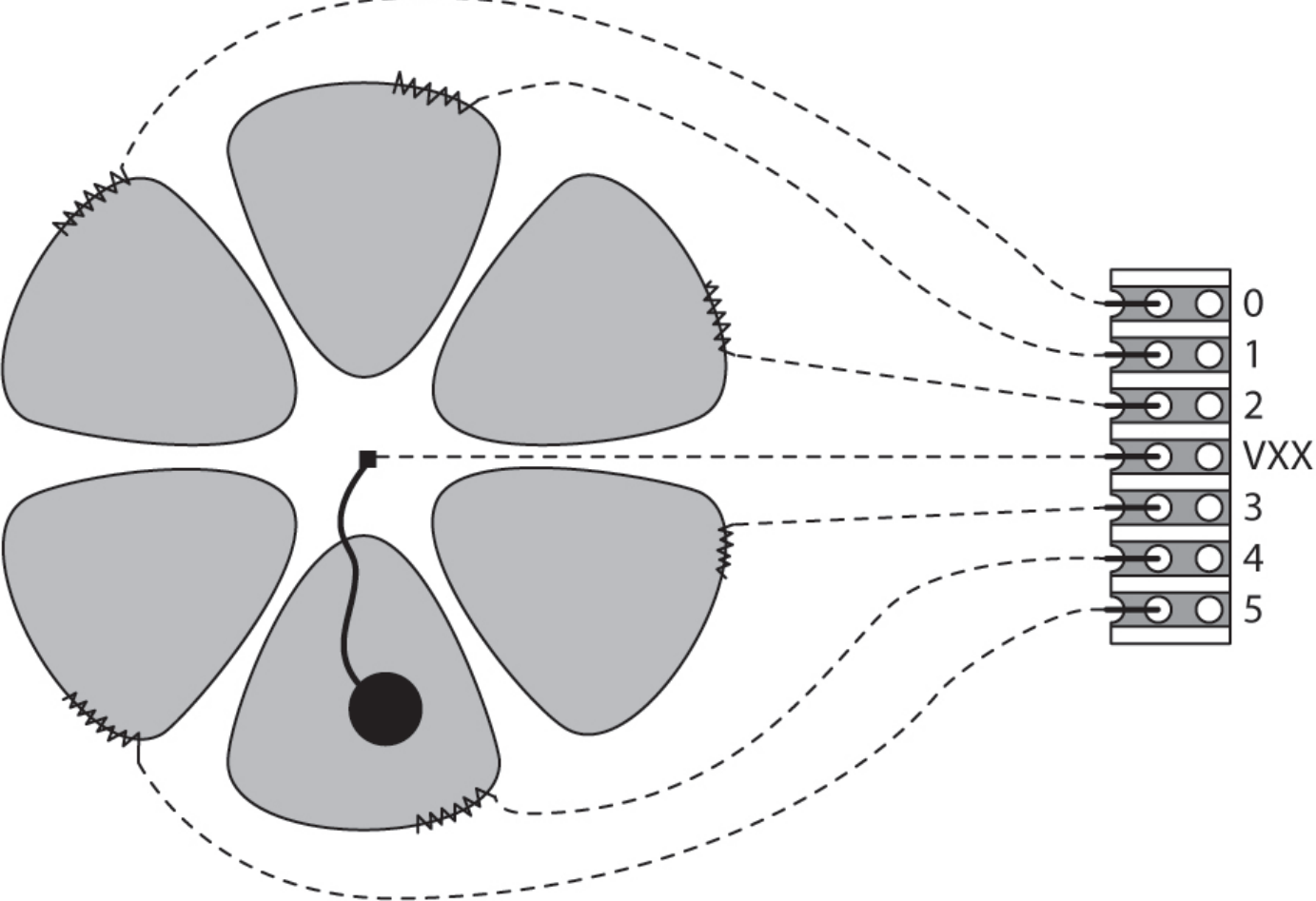

- conductive fabric
- metal bead
- knot
- conductive thread
- double cond. thread
- - - isolated cond. thread



Fabric Potentiometer

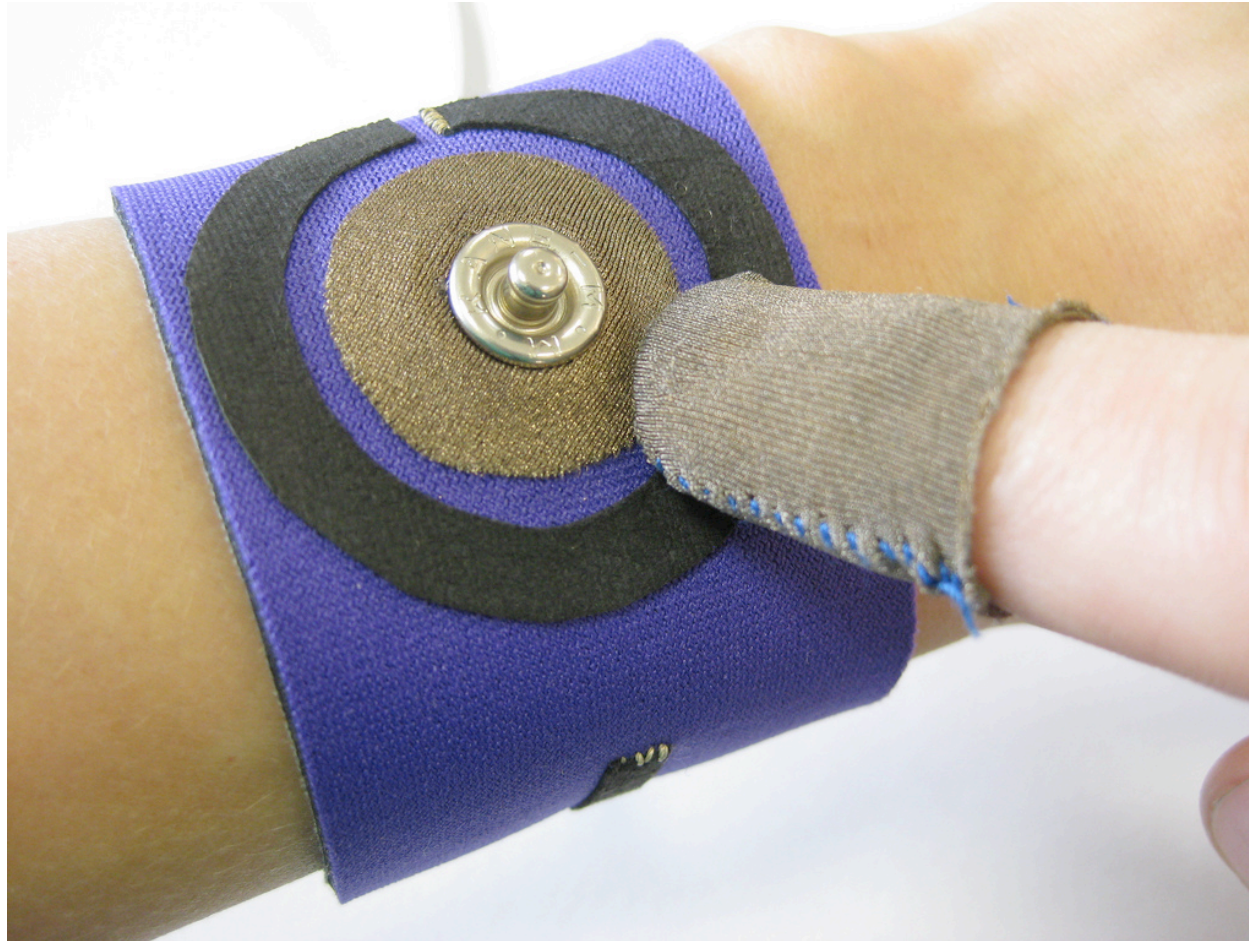

Fabric Potentiometer

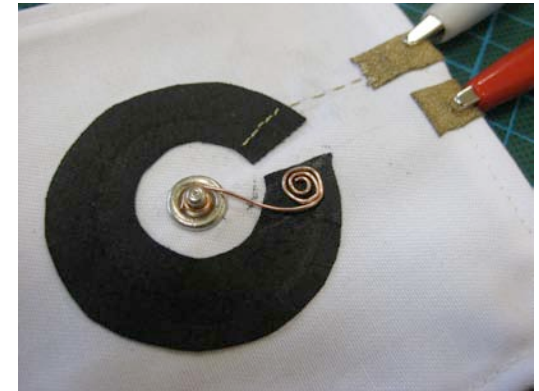
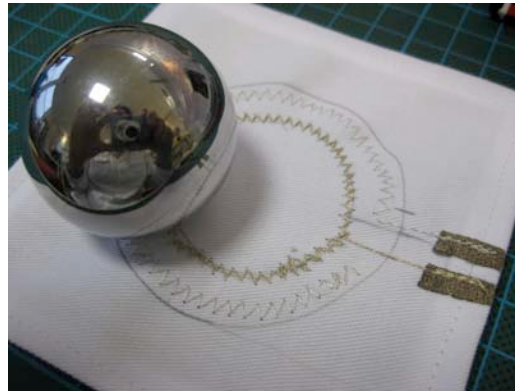

MATERIALS

- Neoprene
- Conductive thread
- Stretch conductive fabric
- Resistive fabric
- Fusible interfacing

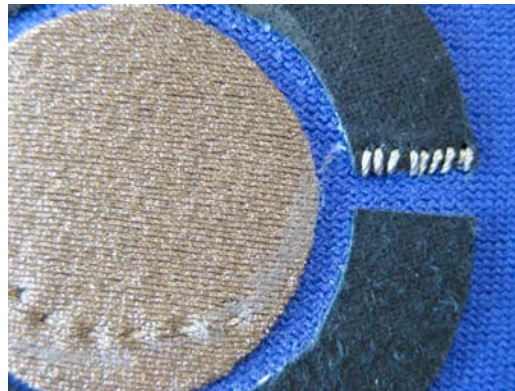

Fabric Potentiometer

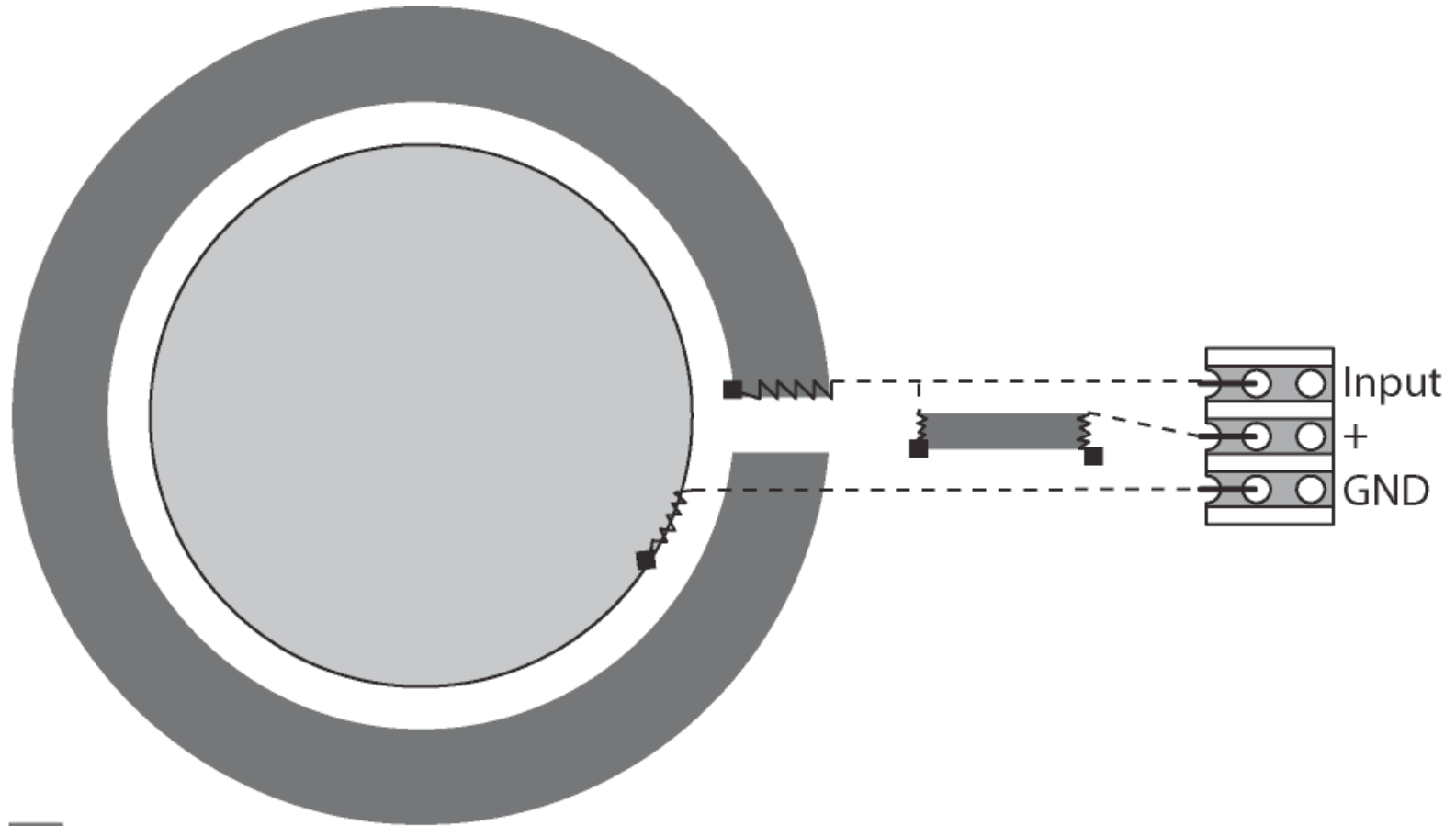

- resistive fabric
- conductive fabric
- knot

- conductive thread
- double cond. thread
- - - isolated cond. thread



Crochet Potentiometer

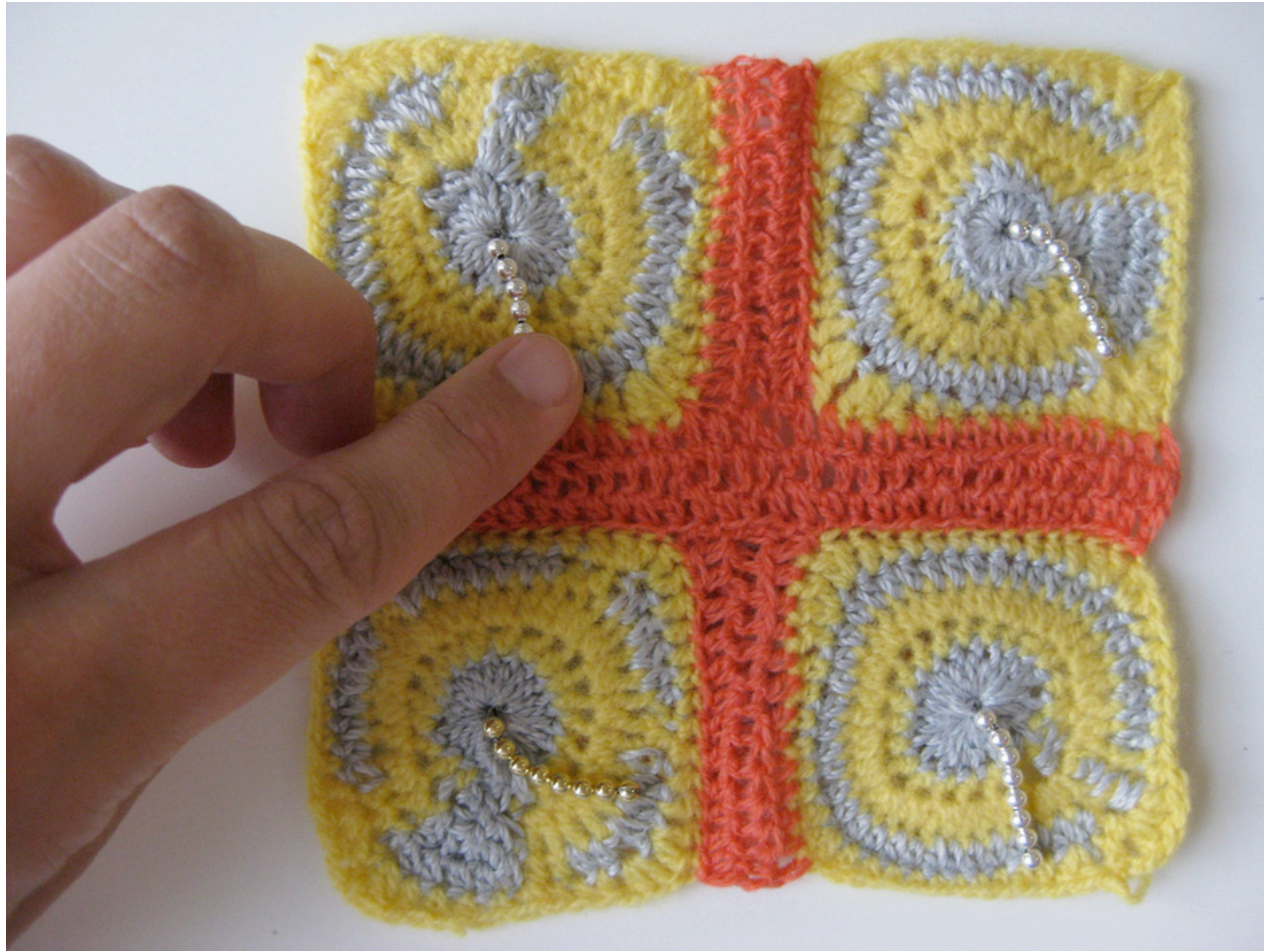

Crochet Potentiometer



MATERIALS

- Resistive yarn
- Regular yarn
- Conductive thread
- Metal bead



Potentiometer

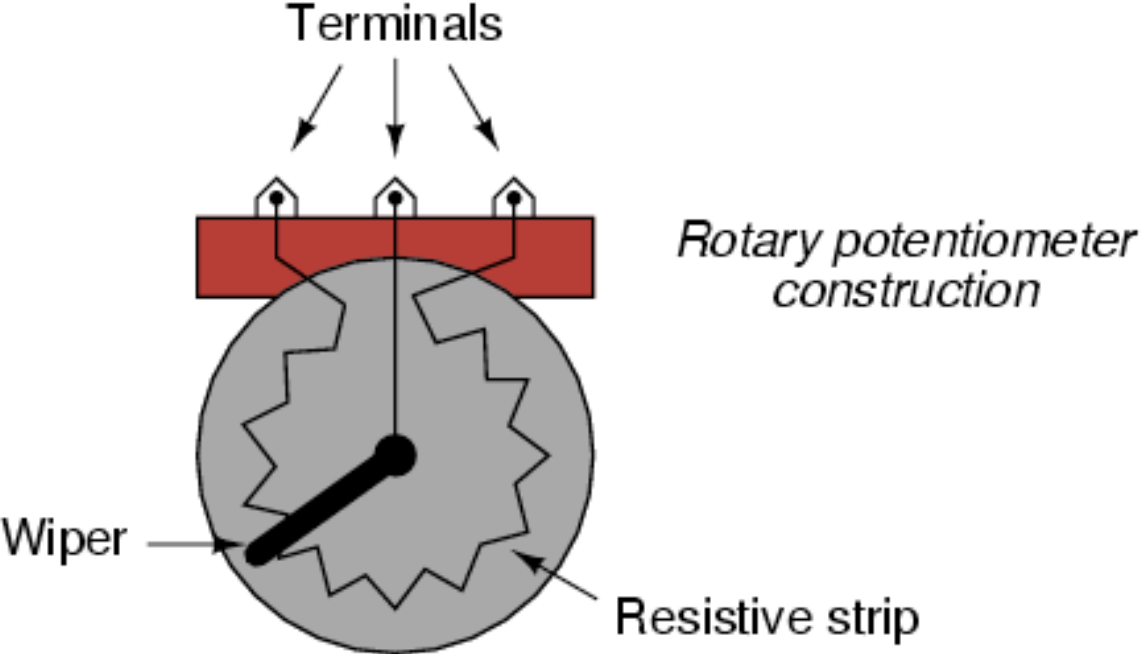

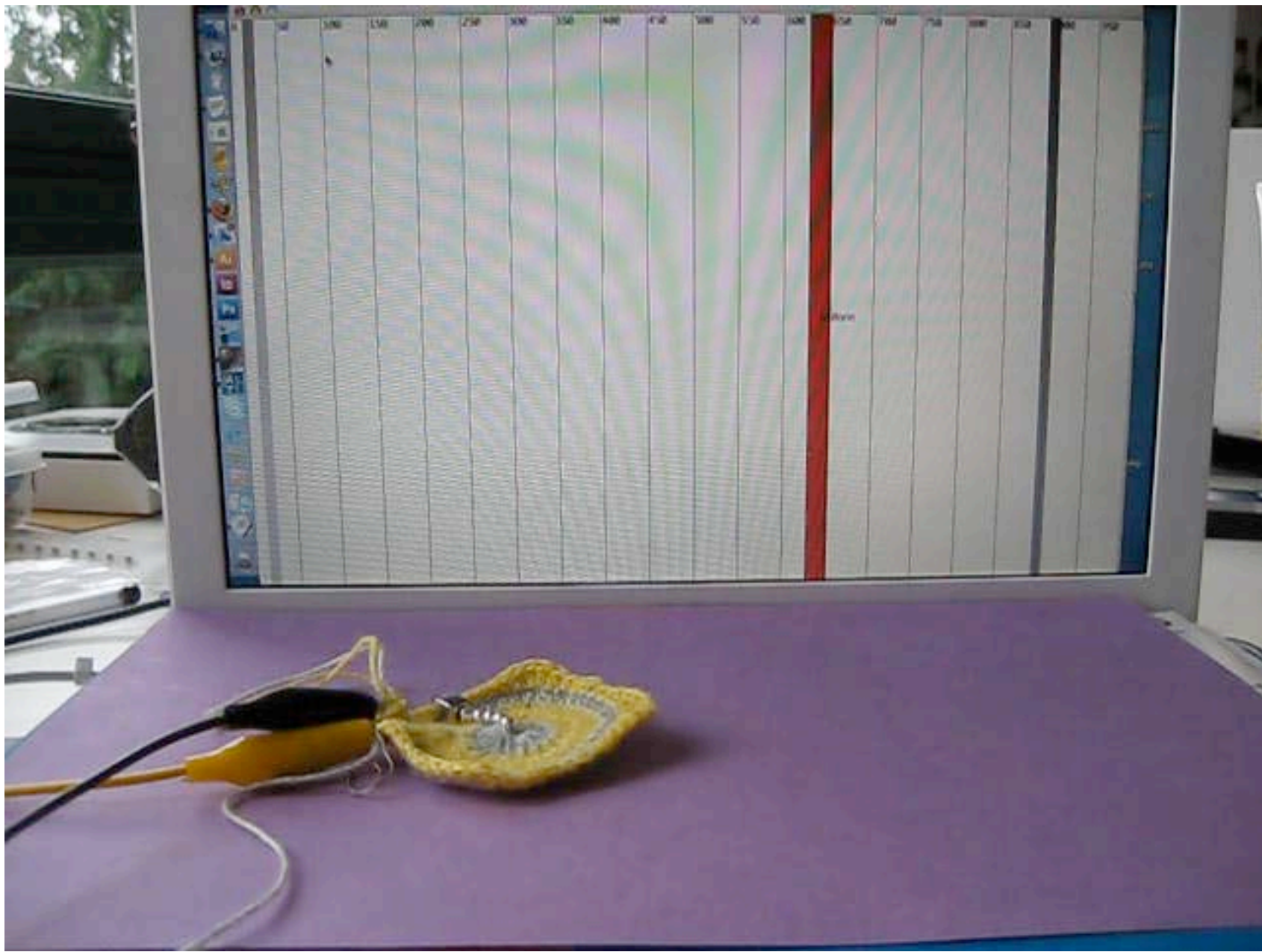

Stroke Sensor



Stroke Sensor

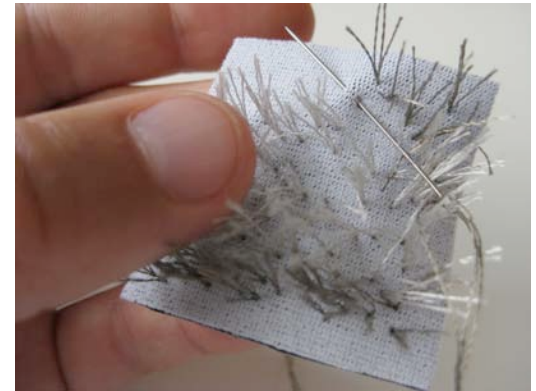

MATERIALS

- Neoprene
- Conductive thread
- Resistive thread
- Conductive fabric
- Fusible interfacing



Stroke Sensor

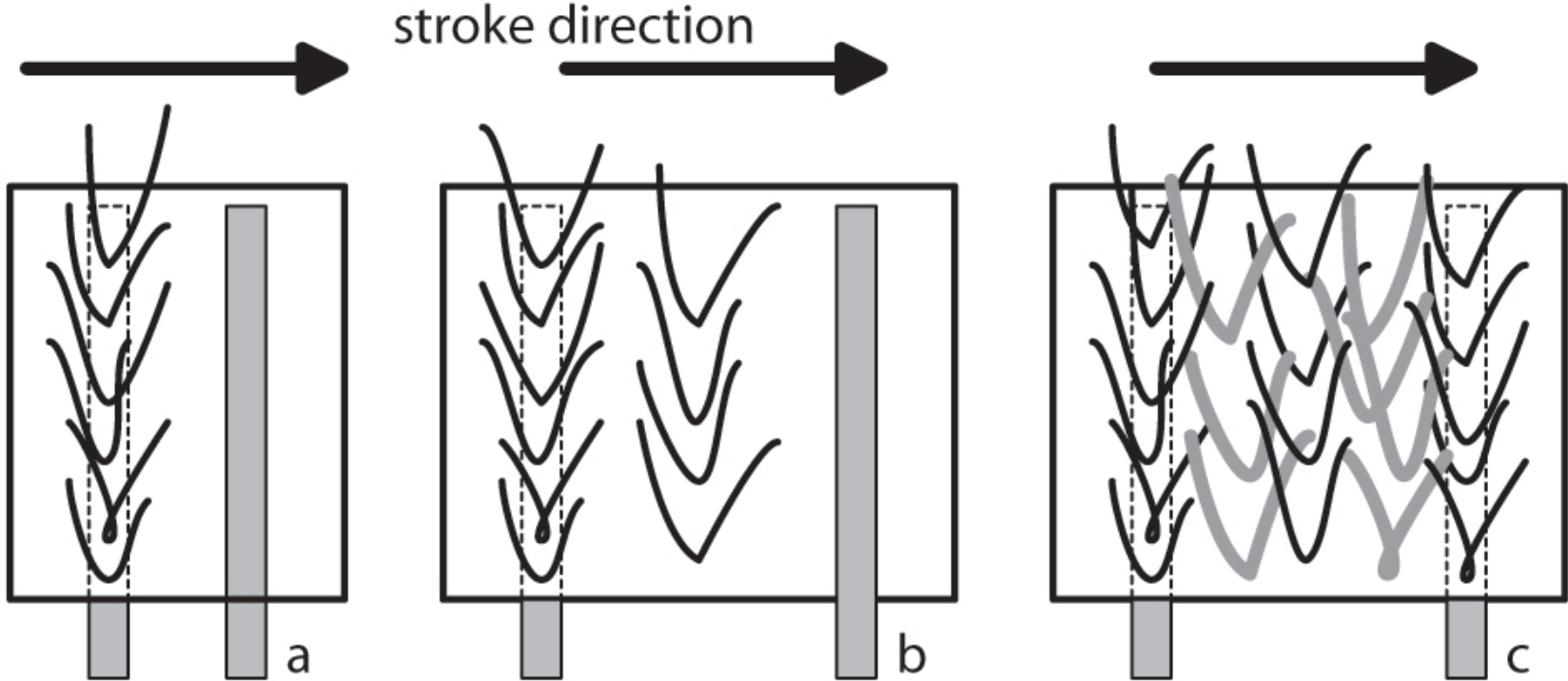

□ neoprene
■ conductive fabric

— conductive thread
— non-conductive or resistive thread

Stroke Sensor - VIDEO

Knit Stretch Sensor

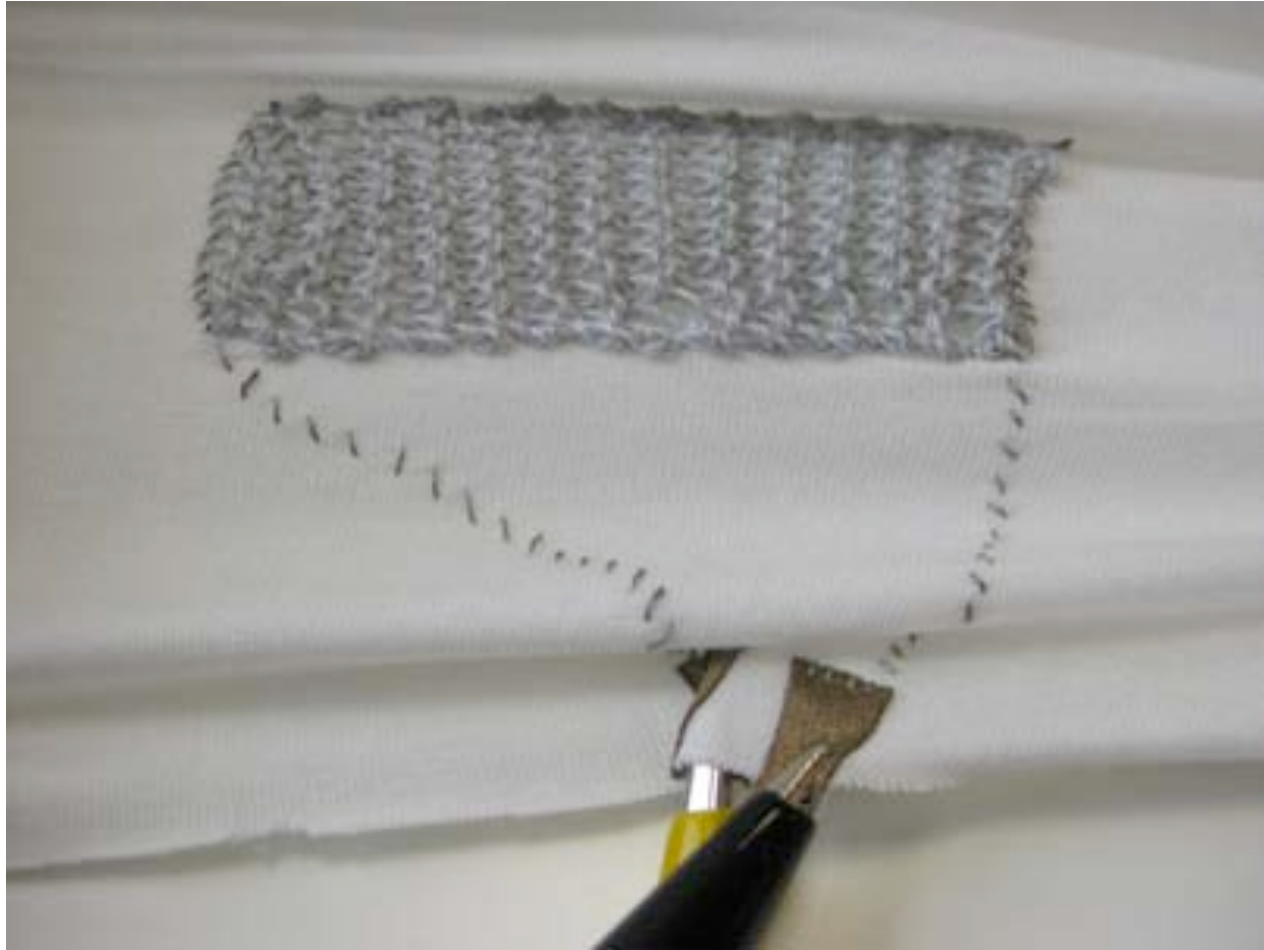

Knit Stretch Sensor

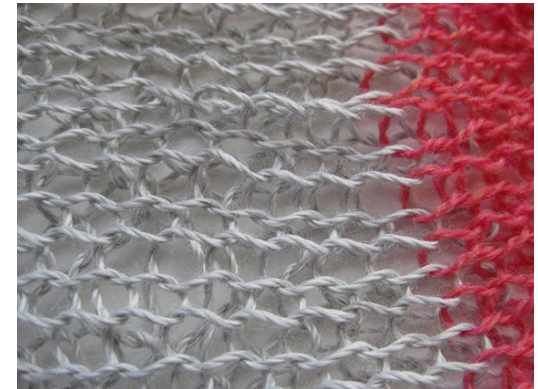
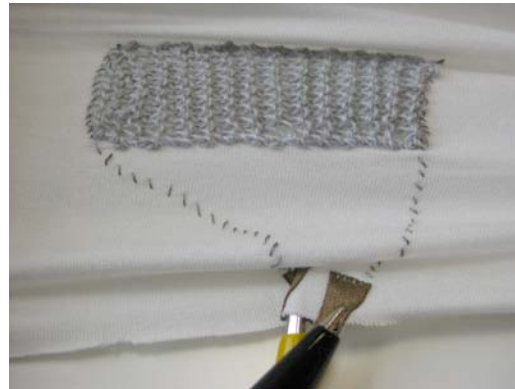

MATERIALS

- Resistive yarn
- Regular yarn

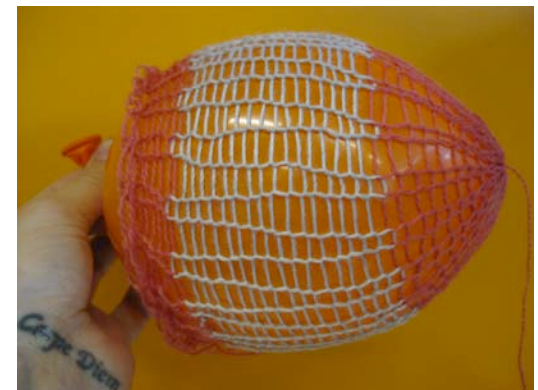

Knit Stretch Sensing Bracelet

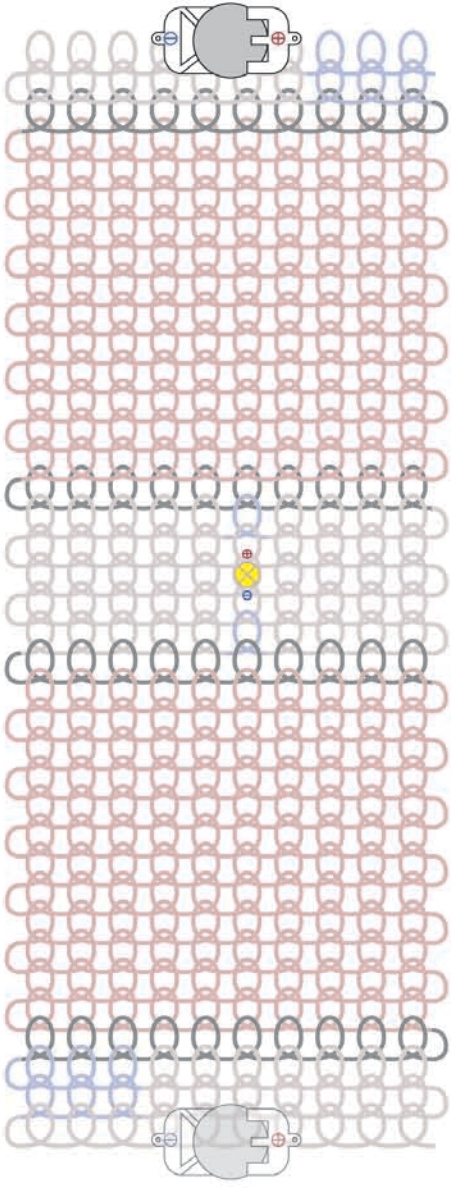
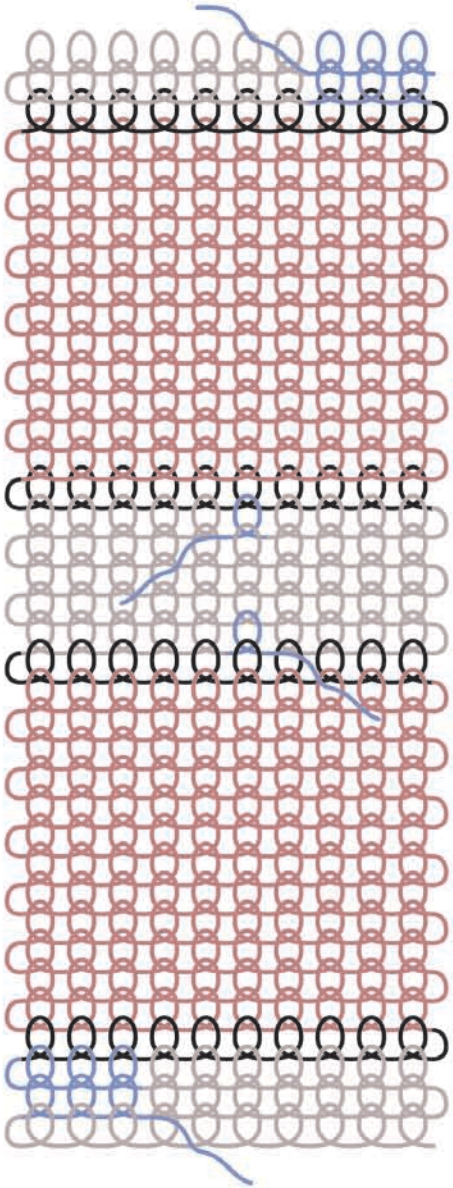

- regular yarn
- resistive yarn
- conductive thread
- regular yarn + resistive yarn
- regular yarn + conductive thread
- regular yarn + resistive yarn + conductive thread
- LED light
- Battery holder

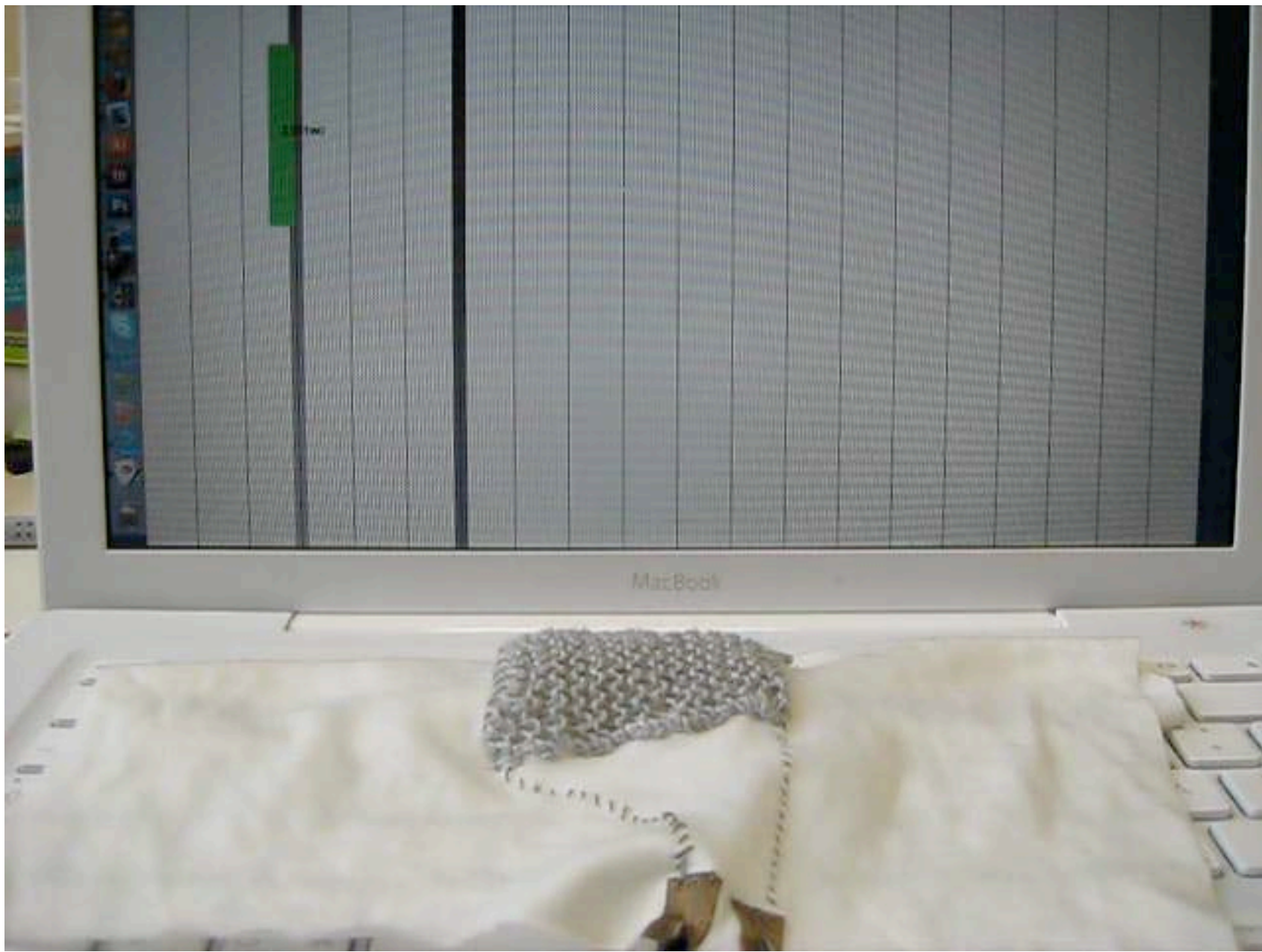

Fabric Button



Fabric Button

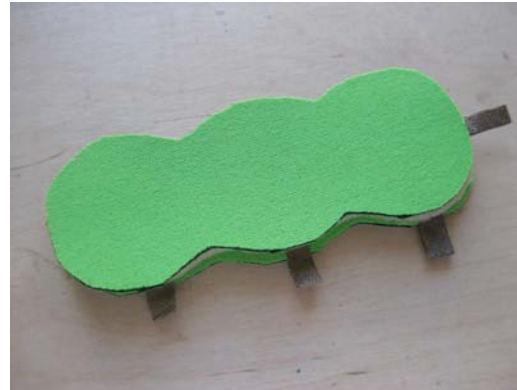
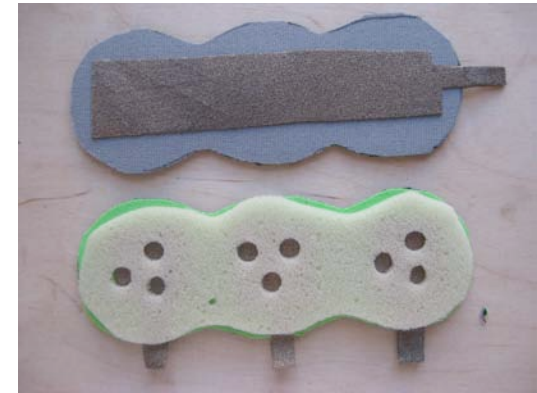
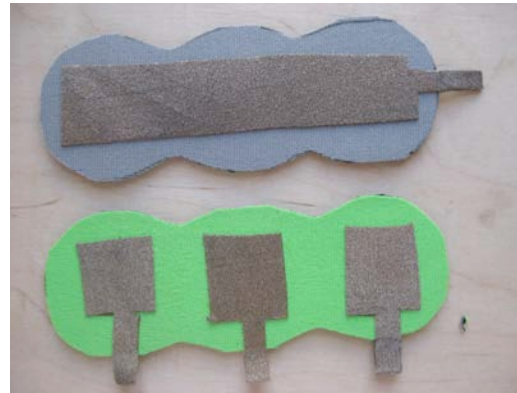

MATERIALS

- Neoprene
- Stretch conductive fabric
- Fusible interfacing
- Foam



Fabric Button

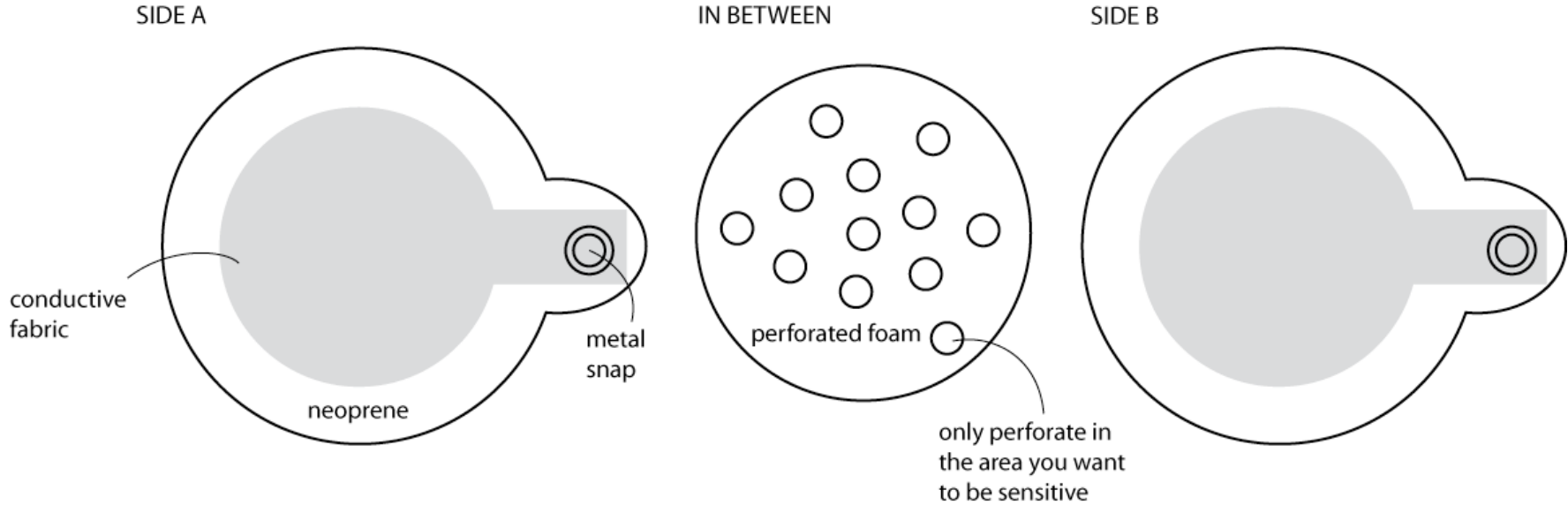

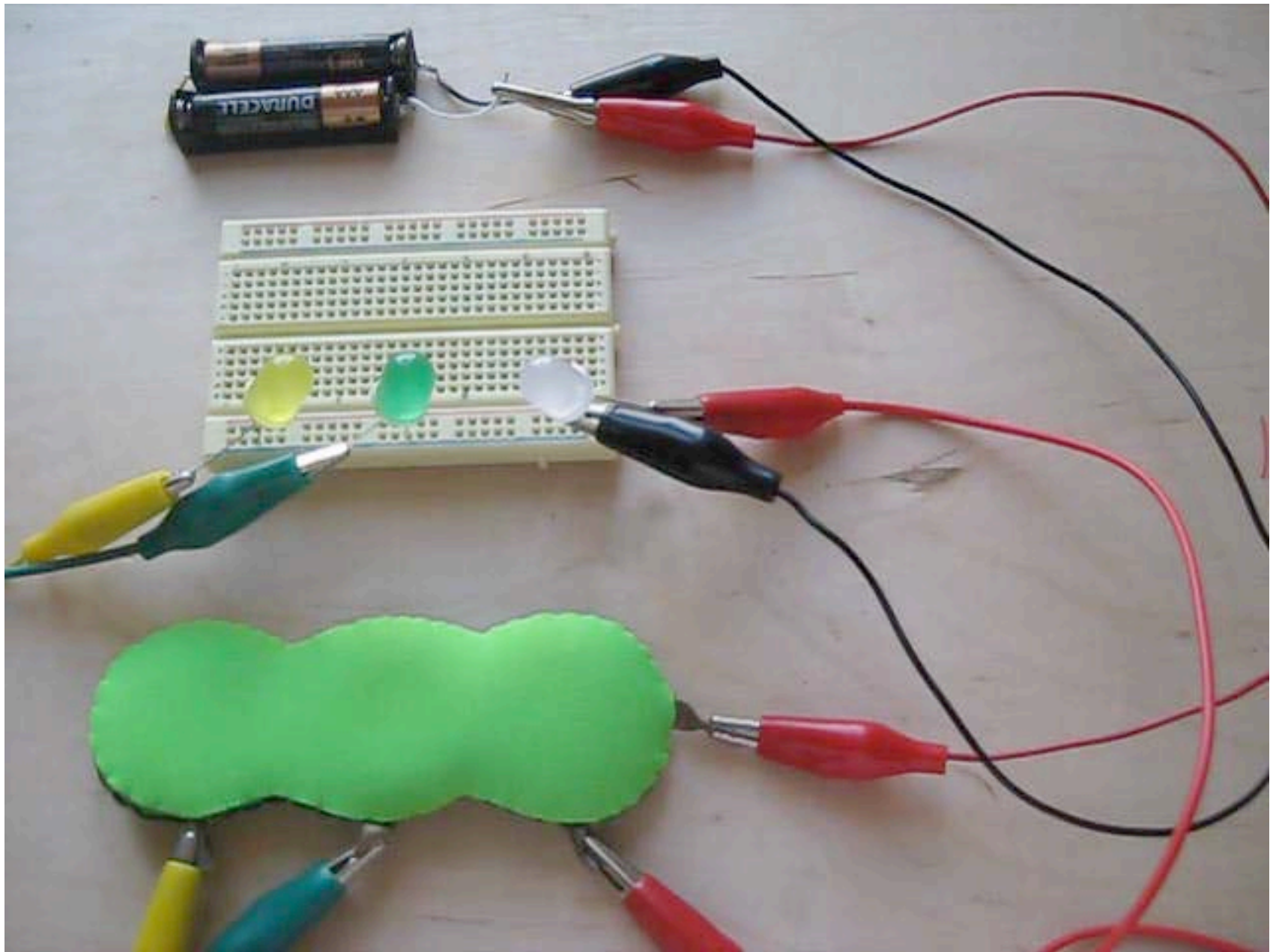

More Sensors...

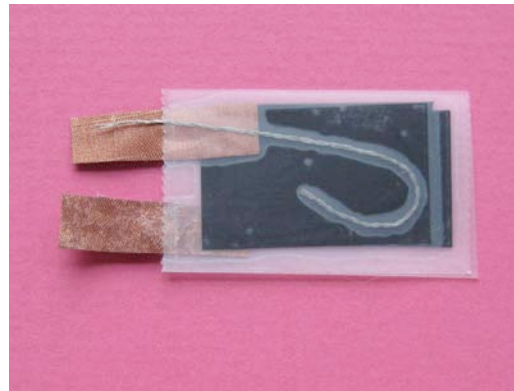
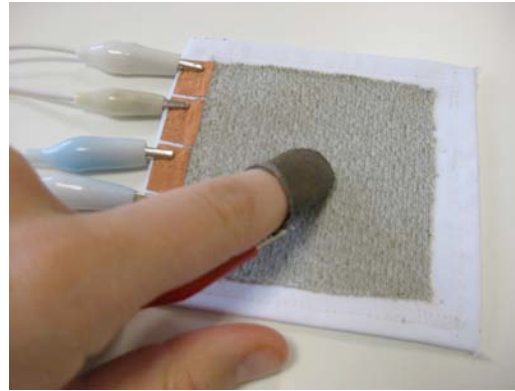

www.instructables.com/member/Plusea

instructables Home Explore Answers Community Submit

an 08 May 08 Sep 08 Jan 09 May 09

All Art Craft Food Games Green Home Kids Life Music Offbeat Outdoors Pets Ride S

member : Plusea [subscribe](#)

Instructables [rss](#) [img](#)

sort by: [recent](#) | [views](#) | [name](#) | [rating](#) 1-12 of 32 [next >](#)

Sensitive Fingertips

Stickytape Sensors

Neoprene Bend Sensor IMPROVED

Limpet Push-Button

Time Sensing Bracelet

Tilt Sensing Bracelet

Pressure Sensor Matrix

Solar Necklace T-Shirt

Plusea

Location
Brooklyn, NY

Web Site
<http://www.plusea.at>

Member Since: Jun 8, 2007

MEMBER STATS

Instructables: 32
Subscribers: 115

HOW TO GET WHAT YOU WANT

- EXAMPLE PROJECTS
- WORKSHOPS
- ACTUATORS
- CIRCUITS
- COMMUNICATION
- CONNECTIONS
- POWER
- SENSORS
- TRACES
- CONDUCTIVE MATERIALS
- NON-CONDUCTIVE MATERIALS
- TECHNIQUES
- TOOLS

- >> SENSORS
- BEAD TILT SENSOR
- CONSTRUCTED STRETCH SENSORS
- CROCHET PRESSURE SENSOR
- SENSOR
- CROCHET TILT POTENTIOMETER
- FABRIC BEND SENSOR
- FABRIC BUTTON
- FABRIC POTENTIOMETER
- FABRIC PRESSURE SENSOR
- FABRIC STRETCH SENSORS
- KNIT CONTACT SWITCH
- KNIT TOUCHPAD
- KNITTED STRETCH SENSORS
- PAINTED STRETCH SENSOR
- PRESSURE SENSOR MATRIX
- SIMPLE FABRIC PRESSURE SENSORS
- STICKYTAPE SENSORS

SENSORS

Sensors

CROCHET PRESSURE SENSOR



Here is the crochet pressure sensor. The main principle is same as regular pressure sensor. Instead of conductive fabric or thread, I used conductive yarn from Schoeller, Nm 50/2 60/40 Pes/Inox @ Euros 65.00/kg (25,000 metres/kg). Since this yarn is very thin, it is mixed with normal yarn and crochet, which is what you can see [...]

Sensors

CROCHET TILT POTENTIOMETER



Combination of tilt sensing and potentiometer using regular wool and conductive wool from Schoeller.

Sewable LED Light



Sensor or Switch
interrupts the flow of
electricity

Battery Holder

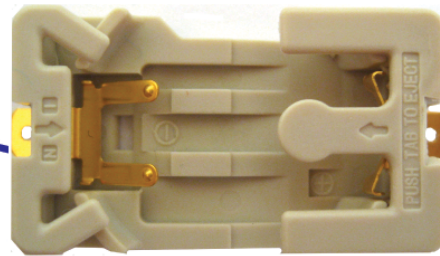

Negative
Ground

Positive
Power

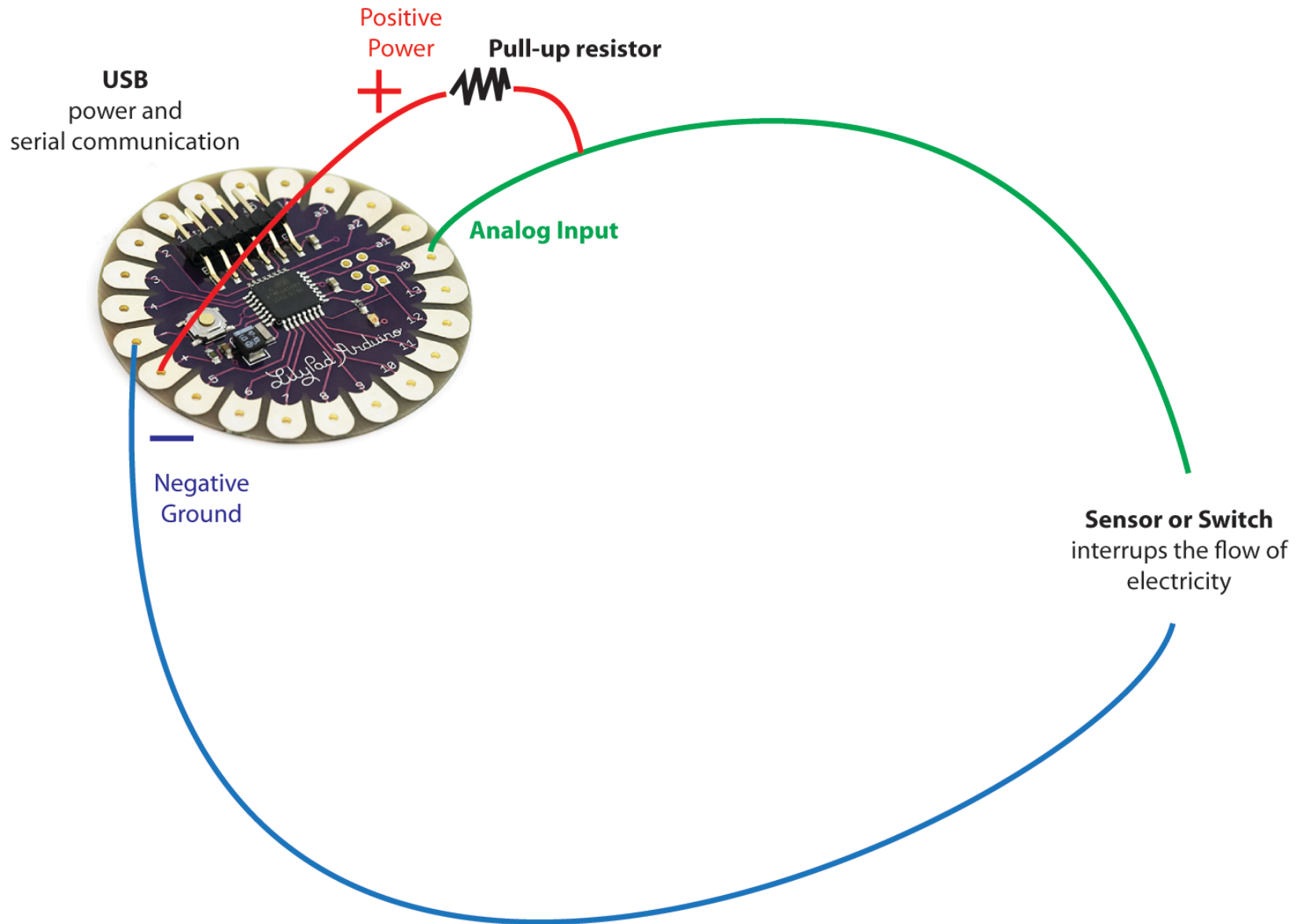

USB
power and
serial communication

**Use internal
pull-up resistor!!!**

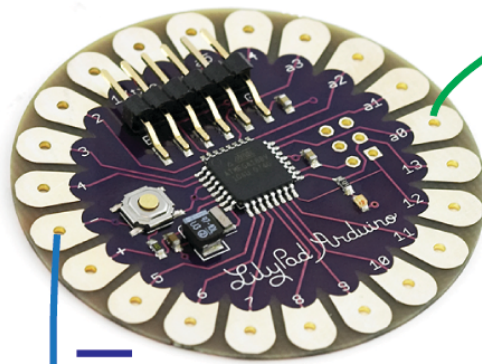

Analog Input

**Negative
Ground**

Sensor or Switch
interrupts the flow of
electricity

Arduino LilyPad

```
Blink | Arduino 0017
Blink §
int ledPin = 13; // LED connected to digital pin 13

// The setup() method runs once, when the sketch starts
void setup() {
  // initialize the digital pin as an output:
  pinMode(ledPin, OUTPUT);
}

// the loop() method runs over and over again,
// as long as the Arduino has power
void loop()
{
  digitalWrite(ledPin, HIGH); // set the LED on
  delay(1000);                // wait for a second
  digitalWrite(ledPin, LOW);  // set the LED off
  delay(1000);                // wait for a second
}
1
```

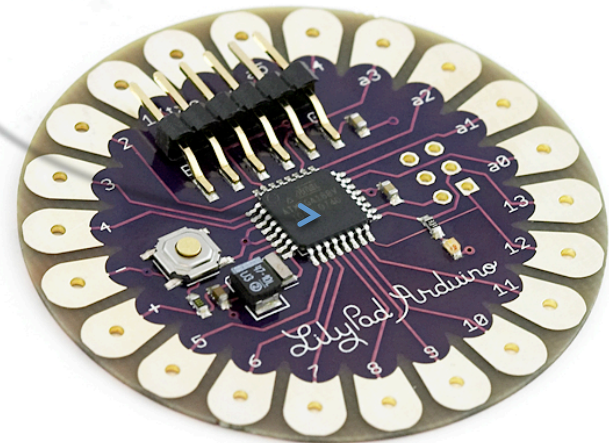

Processing

```
Graph_1AnIN | Processing 1.0.9
Graph_1AnIN serialEvent thresHolding thresholdGraph
/*
 * By Hannah Perner-Wilson, www.plusea.at
 *
 * IMPORTANT: Scroll down to set your thresholds!
 */

import processing.serial.*;

// definition of window size
// you can change the size of the window as you like
// the thresholdGraph will be scaled to fit
// the optimal size for the thresholdGraph is 1000 x 400
int xWidth = 1200;
int yHeight = 800;

// xPos input array, using prefix
int[] xPosArr= {0};

//
int[] messageArr= {0};

// Arrays for thresholding
int[] threshMax= {0};
int[] threshMin= {0};

// variables for serial connection. portname and baudrate are user specific
Serial port1;

//Set your serial port here (look at list printed when you run the application)
String V3 = Serial.list()[0];
String portname1 = V3;
int baudrate = 9600;
```

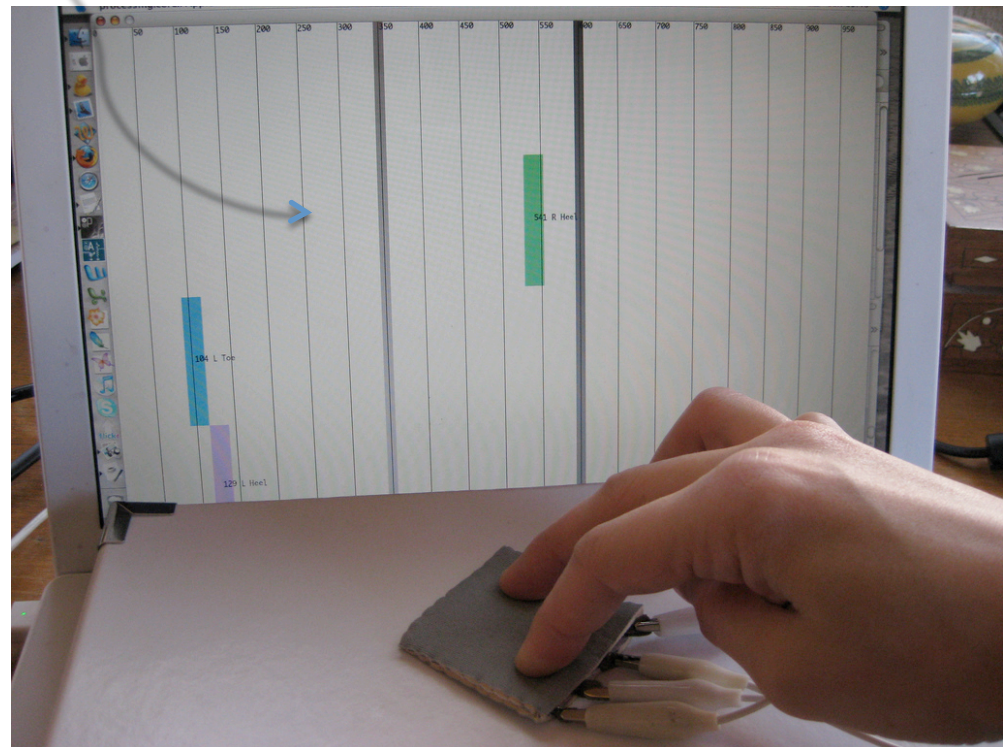

Links

Download Arduino programming environment from:

>> www.arduino.cc

(Install FTDI drivers, included in download)

Download Processing programming environment from:

>> www.processing.org

Download Arduino and Processing code for Graph:

>> www.arduino.cc/en/Tutorial/Graph

Thank you

plusea@mit.edu

www.plusea.at

www.hlt.media.mit.edu

www.media.mit.edu/~plusea