

P1/P3 FLUIDIC CONTACT WITH VALVE



Precision modular connectors to suit your application

Since its creation in Switzerland in 1946 the LEMO Group has been recognized as a global leader of circular Push-Pull connectors and connector solutions. Today LEMO and its affiliated companies, REDEL and COELVER, are active in more than 80 countries with the help of over 40 subsidiaries and distributors.

Over 75'000 connectors

The modular design of the LEMO range provides over 75'000 connectors from miniature \varnothing 3 mm to \varnothing 50 mm, capable of handling cable diameters up to 30 mm and for up to 114 contacts.

This vast portfolio enables you to select the ideal connector configuration to suit almost any specific requirement in most markets, including medical devices, test and measurement instruments, machinery, audio video broadcast, telecommunications and military.

LEMO's Push-Pull Self-Latching Connection System

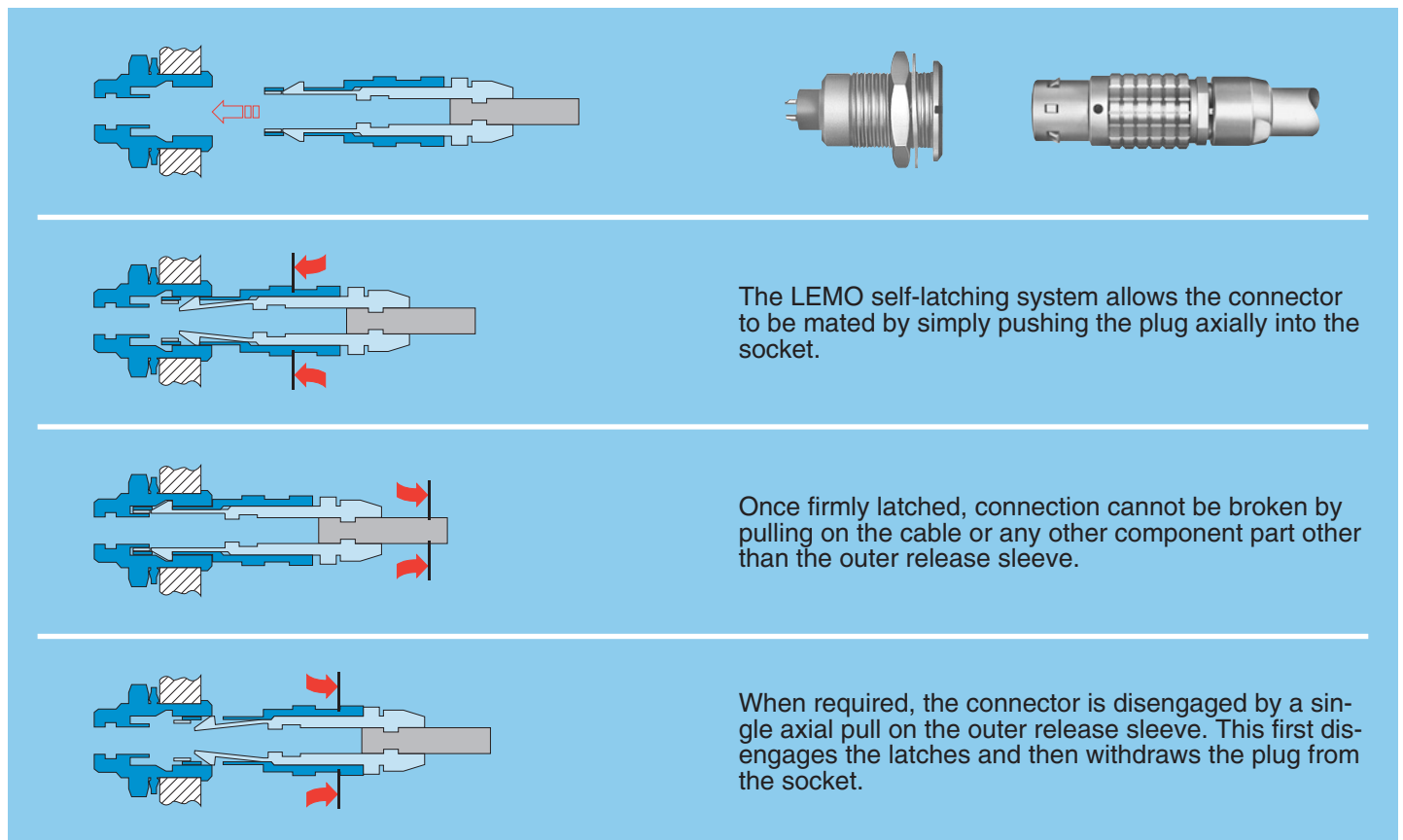

This self-latching system is renowned worldwide for its easy and quick mating and unmating features. It provides absolute security against vibration, shock or pull on the cable, and facilitates operation in a very limited space.



UL Recognition

LEMO connectors are recognized by the Underwriters Laboratories (UL). The approval of the complete system (LEMO connector, cable and your equipment) will be easier because LEMO connectors are recognized.

CE marking

CE marking  means that the appliance or equipment bearing it complies with the protection requirements of one or several European safety directives. CE marking  applies to complete products or equipment, **but not to electromechanical components, such as connectors.**

RoHS

LEMO connector specifications conforms the requirements of the RoHS directive (2011/65/EU) of the European Parliament and the latest amendments. This directive specifies the restrictions of the use of hazardous substances in electrical and electronic equipment marketed in Europe.

P1/P3 Fluidic contact with valve

The P1 fluidic contact is designed to fit multi fluid connectors or mixed fluid/electrical connectors from 2B to 5B and 2K to 5K series. This new design includes a shut-off valve. It fits into all insert cavities that already accept the LEMO coaxial type «C» of contact. The P3 fluidic contact is designed to fit multi fluid connectors of the 5B and 5K series.

Its main features are:

- contacts with shut-off valve
 - maximum working pressure 6 bars
 - stainless alloy body
 - after mounting on tube, the contact is installed in the main insulator and retained with a metallic clip.
- The contact is fitted with FPM o-ring, it can be used with liquids or gas.

Part Section Showing Internal Components

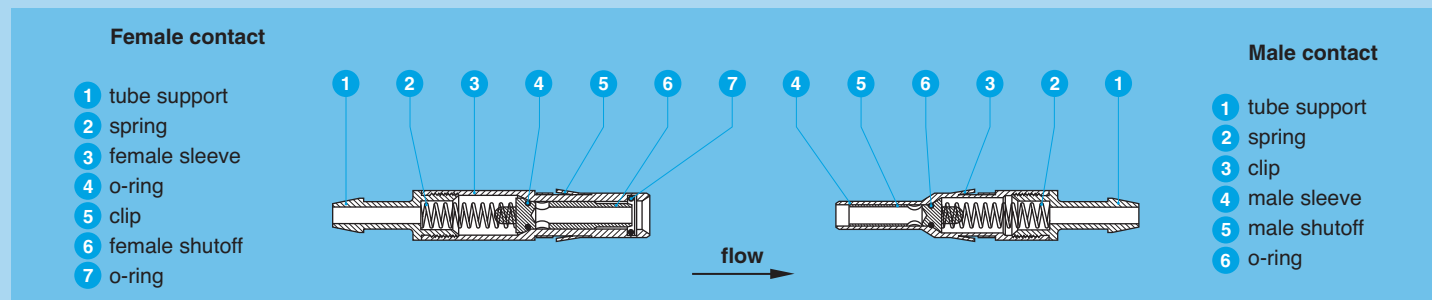

Technical Characteristics

Material and Treatment

Components	Value
Body	Stainless steel
Valve	Alloy CuNiZn
Spring	Stainless steel
Clips	CuBe
O-ring	FPM

Mechanical and Environmental

Characteristics	Value	Cont. type	Standard
Mating durability	1000 cycles	P1/P3	IEC 60512-5 test 9a
Temperature range	-20°C, +125°C	P1/P3	
Max. working pressure	6 bars	P1/P3	
Air flow rate at 6 bars	50 l/min	P1	
Water flow rate at 6 bars	0.80 l/min	P1	
Air flow rate at 6 bars	210 l/min	P3	
Water flow rate at 6 bars	4.20 l/min	P3	

Note: flow direction is always from female contact to male contact.

Flow/pressure diagram P1 contact type

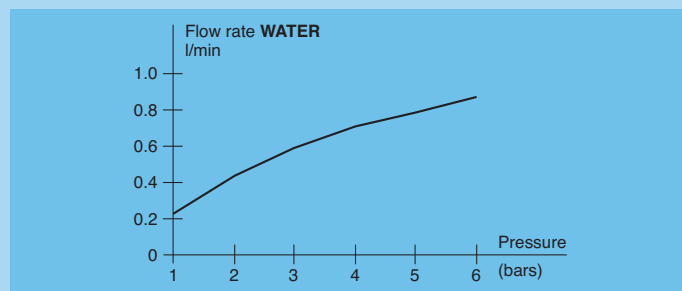
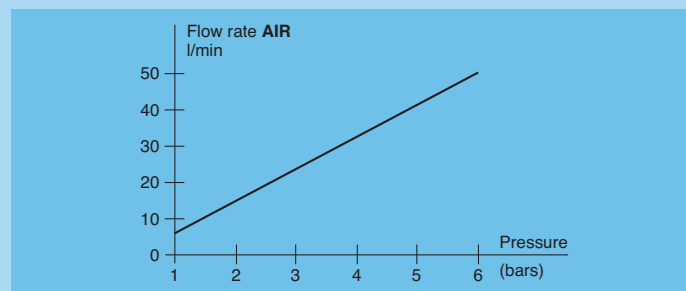

Note: test carried out with a 2 mm inner diameter tube.

Flow/pressure diagram P3 contact type

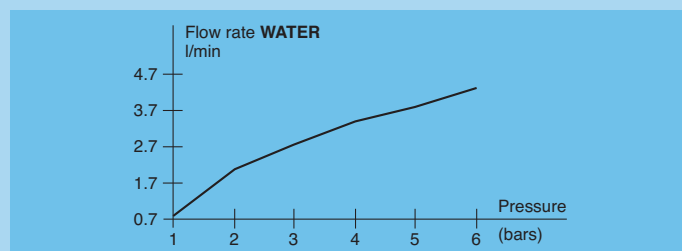
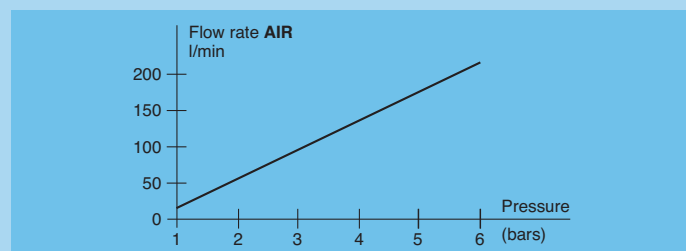

▶ **Model - Fluidic Contact Type**

P1 contacts

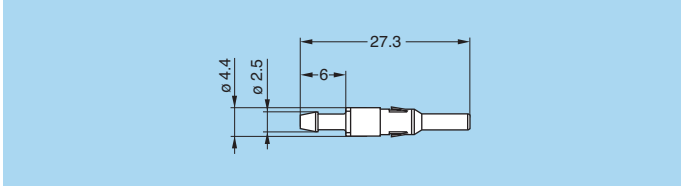
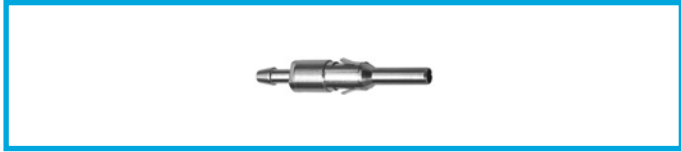

FGG.P1 Male fluidic contact with valve

Part number
FGG.P1.150.ACV

Note: Connectors are delivered without the P1 contacts.

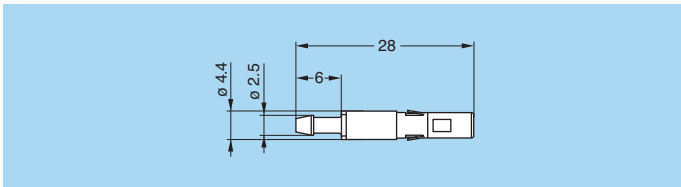
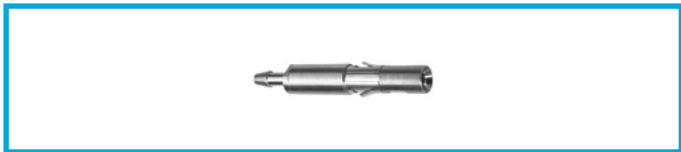

EGG.P1 Female fluidic contact with valve

Part number
EGG.P1.150.ACV

Note: Connectors are delivered without the P1 contacts.

P3 contacts

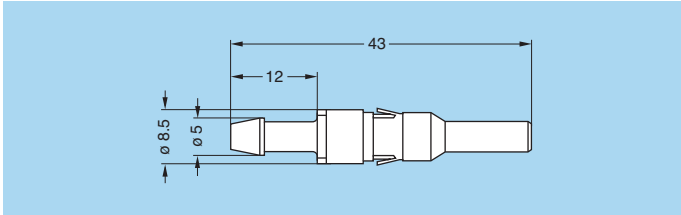

FGG.P3 Male fluidic contact with valve

Part number
FGG.P3.300.ACV

Note: Connectors are delivered without the P3 contacts.

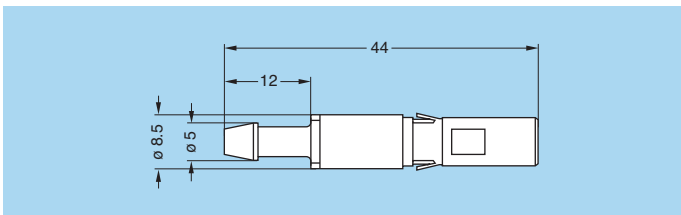
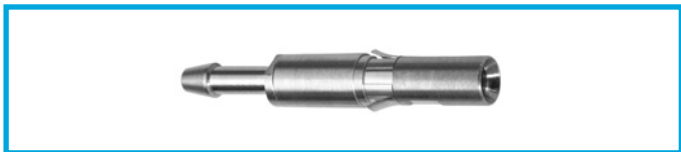

EGG.P3 Female fluidic contact with valve

Part number
EGG.P3.300.ACV

Note: Connectors are delivered without the P3 contacts.

Recommended tubing/hose

Series	Contact type	Diameter (mm)		Supplier	Material	Colour	Working temperature
		Outer \varnothing	Inner \varnothing				
2B, 3B, 2K, 3K	P1	4.0	2.0	Legris 1100P0400	Polyamide (nylon)	White	-20° C to 80° C
2B, 3B, 2K, 3K		4.0	2.0	Legris 1100P0401	Polyamide (nylon)	Black	-20° C to 80° C
2B, 3B, 4B, 5B		3.0	1.8	Legris 1025U030118	Polyurethane	Black	-20° C to 70° C
2K, 3K, 4K, 5K		3.0	1.8	Legris 1025U030118	Polyurethane	Black	-20° C to 70° C
5B, 5K	P3	6.0	4.0	Legris 1100P0601	Polyamide (nylon)	Black	-20° C to 80° C

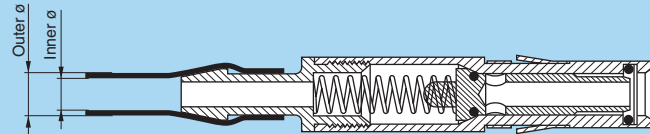

2B-5B Series

The P1 fluidic contact has been designed to work in the 2B to 5B series. The P3 contact has been designed to work in the 5B series. The main features of these series are as follows:

- security of the LEMO Push-Pull self-latching system
- the alignment key (G, A...F, Y and R) ensures excellent repeatability of performance during frequent matings
- the P1 fluidic contact allows hybrid configuration in the 2B series and multi fluid up to 10 channels in the 5B series.

The possible outer cable diameters range from 4.0 to 25 mm.

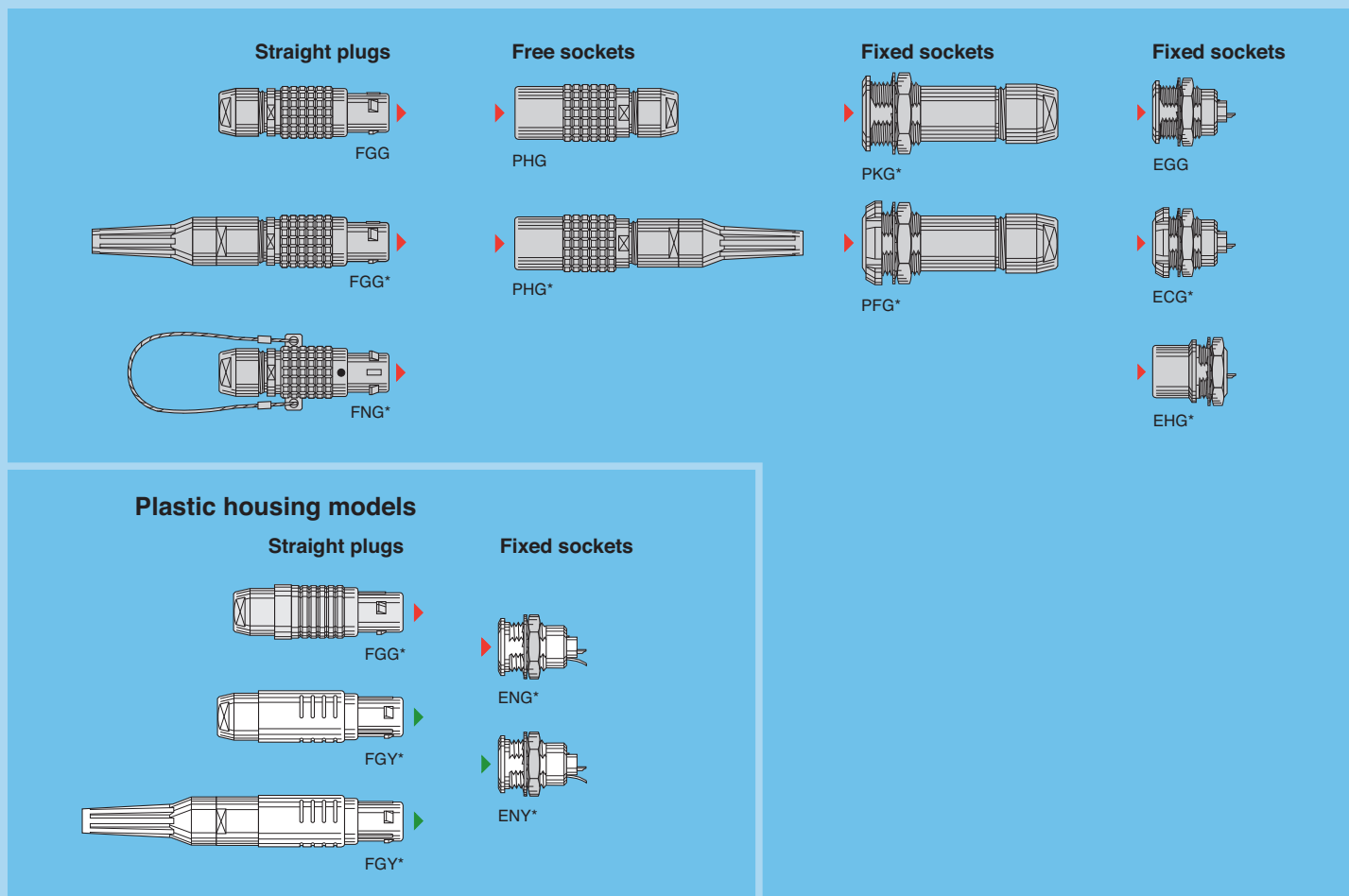

Model Description

- ECG** Fixed socket, with two nuts, key (G) or keys (A...F and R), (back panel mounting)
- EGG** Fixed socket, nut fixing, key (G) or keys (A...F and R)
- EHG** Fixed socket, nut fixing, key (G) or keys (A...F and R) with visible shell
- ENG** Fixed socket with grounding tab, nut fixing, key (G), PEEK outer shell
- ENY** Fixed socket with grounding tab, nut fixing, keys (Y), PSU or PPSU outer shell
- FGG** Straight plug, key (G) or keys (A...F and R) and cable collet
- FGG** Straight plug, key (G) or keys (A...F) cable collet and nut for fitting a bend relief

- FGG** Straight plug, key (G), cable collet, PEEK outer shell
- FGY** Straight plug, keys (Y), cable collet and PSU or PPSU outer shell
- FGY** Straight plug, keys (Y), cable collet and PSU or PPSU outer shell and nut for fitting a bend relief
- FNG** Straight plug, key (G) or keys (A...F and R) and cable collet with lanyard release
- PFG** Fixed socket, with two nuts, key (G) or keys (A...F and R) and cable collet (back panel mounting)
- PHG** Free socket, key (G) or keys (A...F and R) and cable collet

- PKG** Free socket, key (G) or keys (A...F) and cable collet and nut for fitting a bend relief
- PKG** Fixed socket, nut fixing, key (G) or keys (A...F and R) and cable collet

* Not show in this catalogue. Refer to our catalogue unipole-multipole

Certain models and certain alignment key may not be available in all series. Please consult us.

Part Number Example

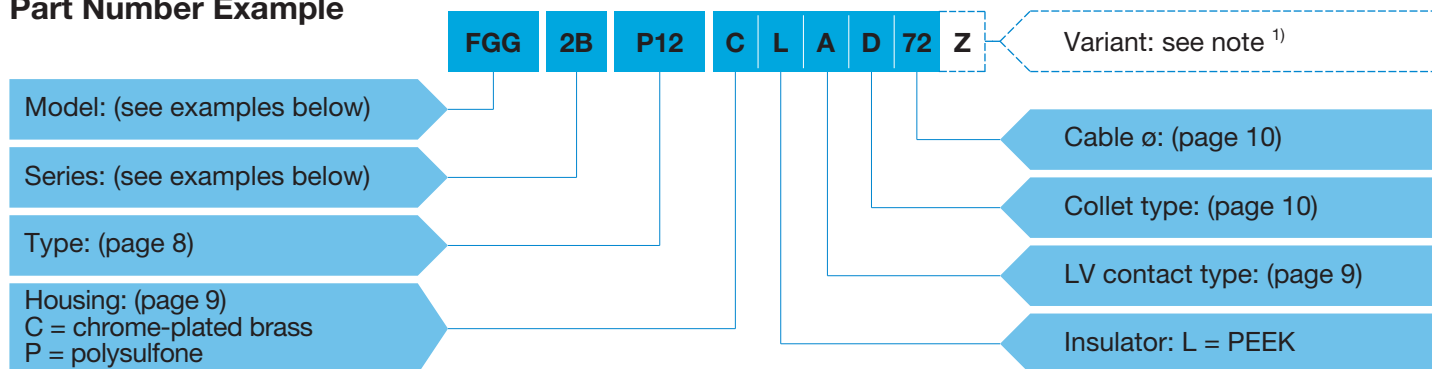

FGG.2B.P12.CLAD72Z = Straight plug with key (G), 2B series, mixed type to accept one P1 fluid contact and 4 low voltage electrical contacts, chrome-plated brass housing, PEEK insulator, 4 male solder electrical contacts, type D collet system to suit a 6.1 to 7.0 mm diameter cable, and a nut for fitting a bend relief.

Note: Connectors are always delivered without fluidic contact.

¹⁾ The «Variant» position in the reference is used to indicate the presence of a collet nut for fitting the bend relief. The bend relief must be ordered separately (see page 12).

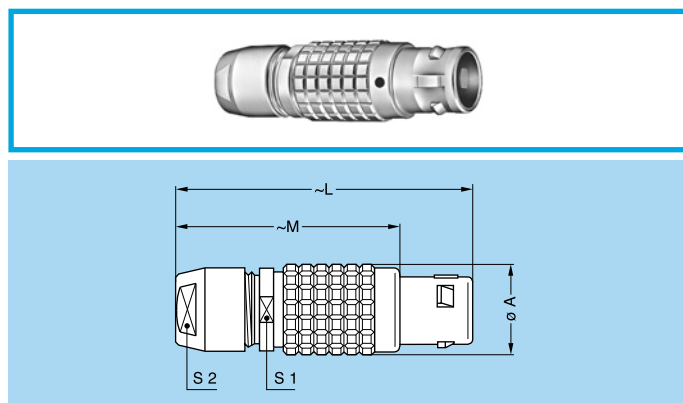

FGG Straight plug, key (G) or keys (A...F and R) and cable collet

Reference		Dimensions (mm)				
Model	Series	A	L	M	S1	S2
FGG	2B	15	50	38	13	12
FGG	3B	18	58	43	15	14
FGG	4B	25	75	57	21	20
FGG	5B	35	103	78	31	30

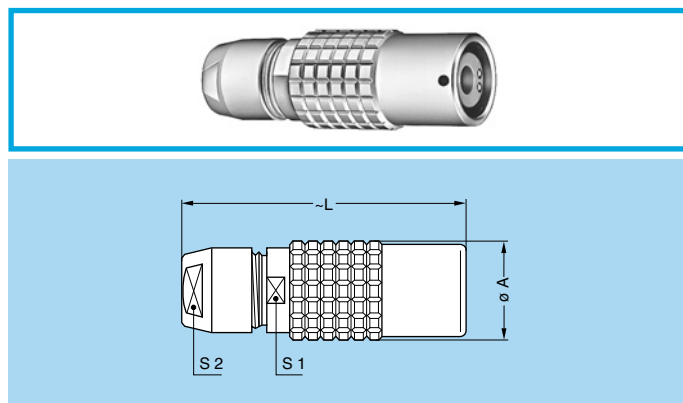

PHG Free socket, key (G) or keys (A...F and R) and cable collet

Reference		Dimensions (mm)			
Model	Series	A	L	S1	S2
PHG	2B	16.5	47.0	13	12
PHG	3B	19.0	56.0	15	14
PHG	4B	24.4	73.0	21	20
PHG	5B	34.2	99.0	31	30

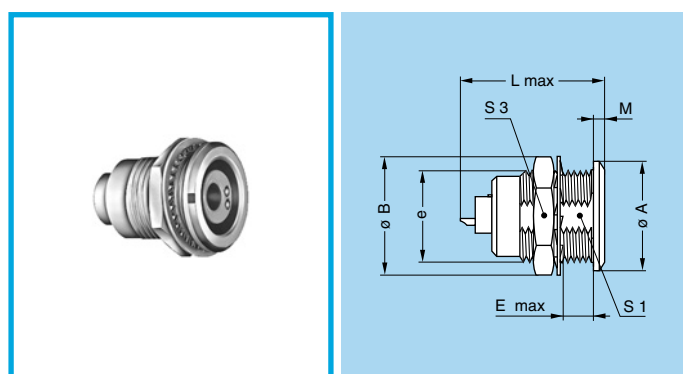

EGG Fixed socket, nut fixing, key (G) or keys (A...F and R)

Reference		Dimensions (mm)							
Model	Series	A	B	e	E	L	M	S1	S3
EGG	2B	18	19.2	M15x1.0	8.5	28.8	1.8	13.5	17
EGG	3B	22	25.0	M18x1.0	11.5	30.0	2.0	16.5	22
EGG	4B	28	34.0	M25x1.0	12.0	34.5	2.5	23.5	30
EGG	5B	40	40.0	M35x1.0	11.0	36.5	3.0	33.5	-
EGG	5B ¹⁾	40	40.0	M35x1.0	11.0	45.9	3.0	33.5	-

Note: ¹⁾ with P3 contact.

2K-5K Series

The P1 fluidic contact has been designed to work in the 2K-5K series. The P3 contact has been designed to work in the 5K series. The main features of these series are as follows:

- security of the LEMO Push-Pull self-latching system
 - specially designed for outdoors applications. All these models are waterproof when mated and reach a protection index of IP 66-IP 68, according to the IEC 60529 standard
 - the alignment key (G, A...F and R) ensures excellent repeatability of performance during frequent matings
 - the P1 fluidic contact allows hybrid configuration in the 2K series and multi fluid up to 10 channels in the 5K series.
- The 2K-5K series consists of ten models which will accept outer cable diameters ranging from 2.6 mm to 23.5 mm.

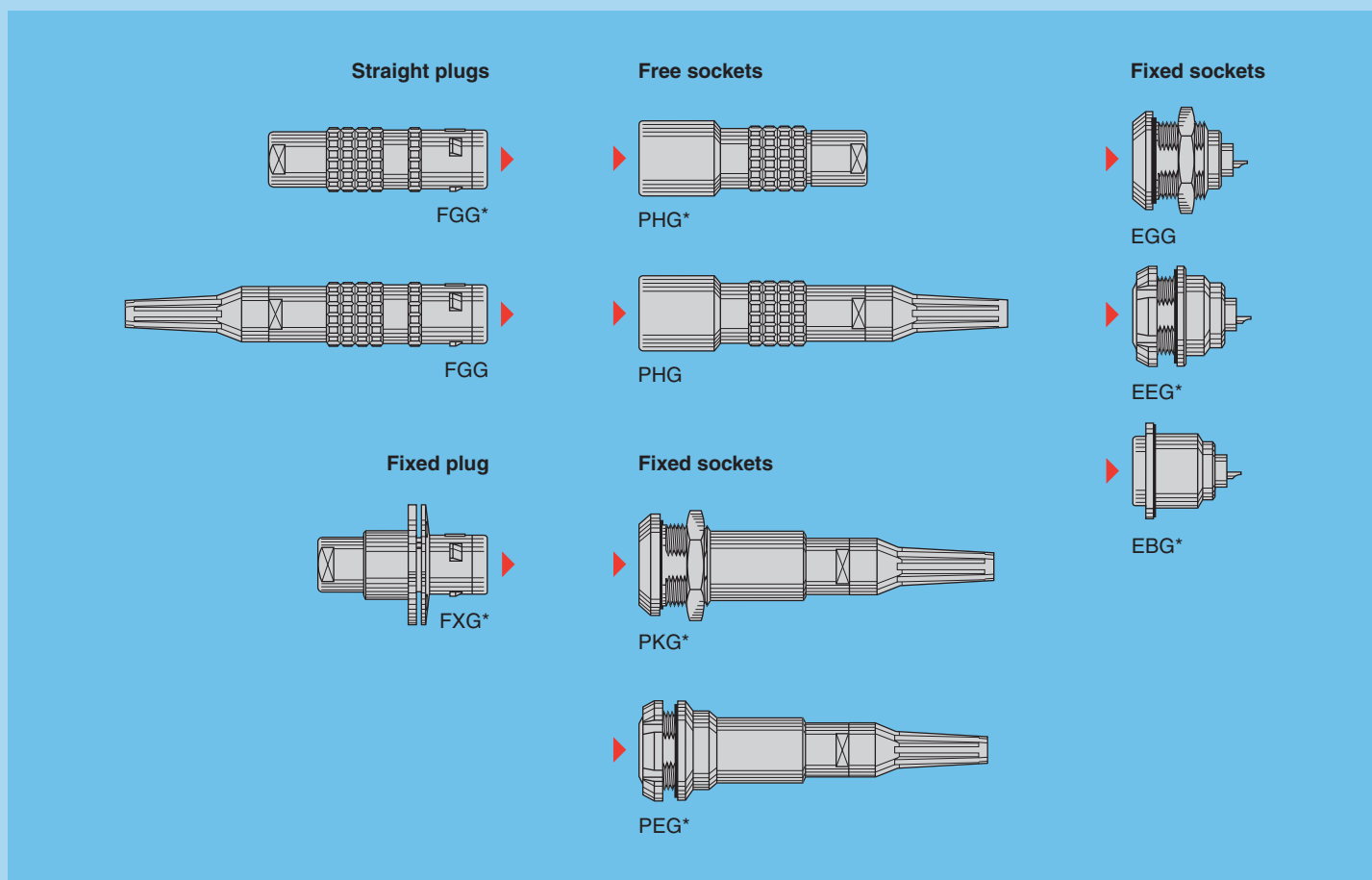

Model Description

- EBG** Fixed socket with square flange, key (G) or keys (A...F and R), four holes fixing
- EEG** Fixed socket, nut fixing, key (G) or keys (A...F and R) (back panel mounting)
- EGG** Fixed socket, nut fixing, key (G) or keys (A...F and R)
- FGG** Straight plug, key (G) or keys (A...F and R), cable collet

- FGG** Straight plug, key (G) or keys (A...F and R), cable collet and nut for fitting a bend relief
- FXG** Fixed plug with round flange, four holes fixing, key (G) or keys (A...F and R)
- PEG** Fixed socket, nut fixing, key (G) or keys (A...F and R), cable collet and nut for fitting a bend relief (back panel mounting)
- PHG** Free socket, key (G) or keys (A...F and R), cable collet

- PHG** Free socket, key (G) or keys (A...F and R), cable collet and nut for fitting a bend relief
- PKG** Fixed socket, nut fixing, key (G) or keys (A...F and R), cable collet and nut for fitting a bend relief

* Not show in this catalogue. Refer to our catalogue unipole-multipole

Certain models and certain alignment key may not be available in all series. Please consult us.

Part Number Example

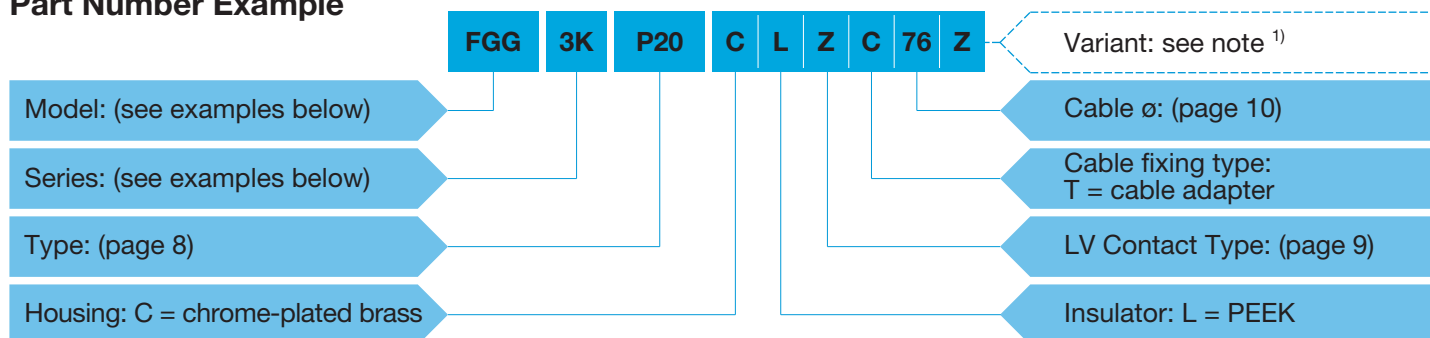

FGG.3K.P20.CLZC76Z = Straight plug with key (G), 3K series, multi fluid with 2 times P1 contacts, chrome-plated brass housing, PEEK insulator, C type collet for 7.5 mm diameter cable, and nut for fitting a bend relief.

Note: Connectors are always delivered without fluidic contact.

¹⁾ The «Variant» position in the reference is used to indicate the presence of a collet nut for fitting the bend relief. The bend relief must be ordered separately (see page 12).

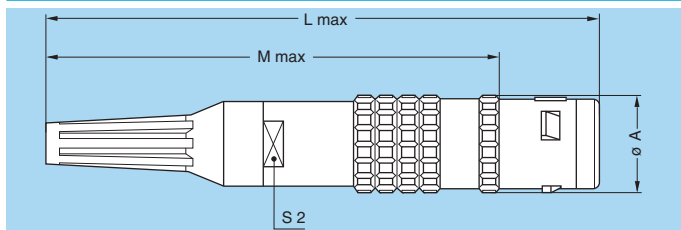
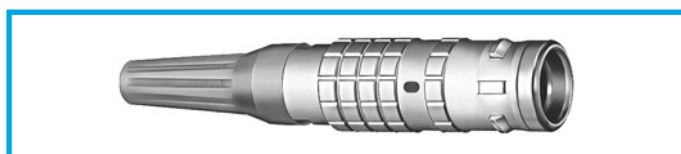

FGG Straight plug, key (G) or keys (A...F and R), cable collet and nut for fitting a bend relief

Reference		Dimensions (mm)			
Model	Series	A	L	M	S2
FGG	2K	16	101	85.0	12
FGG	3K	19	109	89.0	15
FGG	4K	25	131	110.5	19
FGG	5K	38	160	135.0	30

Note: The overall length dimension is with bend relief

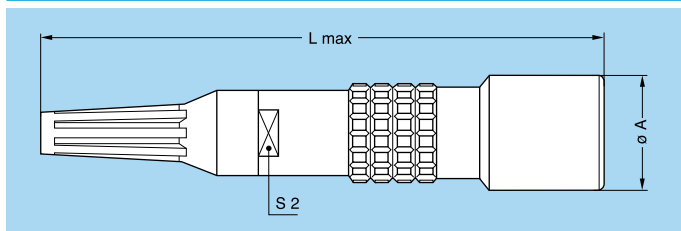
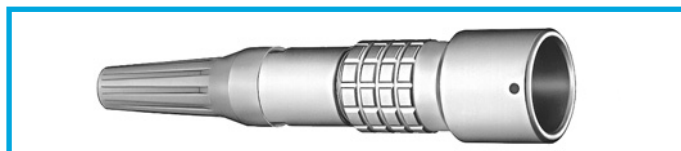

PHG Free socket, key (G) or keys (A...F and R), cable collet and nut for fitting a bend relief

Reference		Dimensions (mm)		
Model	Series	A	L	S2
PHG	2K	19	103.0	12
PHG	3K	23	113.0	15
PHG	4K	29	135.5	19
PHG	5K	42	164.0	30

Note: The overall length dimension is with bend relief

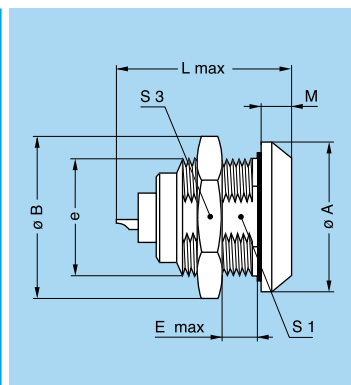

EGG Fixed socket, nut fixing, key (G) or keys (A...F and R)

Reference		Dimensions (mm)							
Model	Series	A	B	e	E	L	M	S1	S3
EGG	2K	25	27.0	M20x1.0	9	32.8	5.0	18.5	24
EGG	3K	31	34.0	M24x1.0	11	35.5	6.0	22.5	30
EGG	4K	37	40.5	M30x1.0	9	37.0	6.5	28.5	36
EGG	5K	55	54.0	M45x1.5	10	40.5	9.0	42.5	-



Insert configuration

Multi fluid and Mixed fluid + LV

		Fluidic contact						Low Voltage contact									
		Nb of fluidic tube	Type	Ext. ø of tube (see page 3)	Int. ø of tube (see page 3)	Max. working pressure (bars)	Contact No	ø A (mm)	Contact type		Solder contact		Crimp contact		Rated current (A)		
									Solder	Crimp	Test voltage (kV rms) Contact-contact	Test voltage (kV rms) Contact-shell	Test voltage (kV rms) Contact-contact	Test voltage (kV rms) Contact-shell			
		Reference															
Male solder contacts																	
Female solder contacts																	
Male crimp contacts																	
Female crimp contacts																	
2B 2K			P11	1	P1	3.0 4.0	1.8 2.0	6	2	0.9	●	●	1.75	1.60	1.85	1.60	9.0
			P12	1	P1	3.0 4.0	1.8 2.0	6	4	0.7	●	●	0.85	1.20	0.85	1.25	6.0
			P13	1	P1	3.0 4.0	1.8 2.0	6	6	0.7	●	●	0.85	1.20	0.85	1.25	6.0
			P15	1	P1	3.0 4.0	1.8 2.0	6	10	0.7	●	●	1.15	1.35	1.30	1.05	6.0
3B 3K			P20	2	P1	3.0 4.0	1.8 2.0	6	-	-	-	-	-	-	-	-	-
			P22	2	P1	3.0 4.0	1.8 2.0	6	4	0.9	●	●	1.20	1.05	1.00	0.80	8.0
			P23	2	P1	3.0 4.0	1.8 2.0	6	6	0.9	●	●	1.20	1.05	1.00	0.80	8.0
			P25	2	P1	3.0 4.0	1.8 2.0	6	10	0.7	●	●	0.95	0.75	0.85	0.65	6.0
			P28	2	P1	3.0 4.0	1.8 2.0	6	16	0.7	●	●	0.80	0.70	0.80	0.75	5.5
4B 4K			P40	4	P1	3.0	1.8	6	-	-	-	-	-	-	-	-	-
			P49	4	P1	3.0	1.8	6	9	0.7	●	●	1.00	1.00	0.80	0.80	8
			P33	3	P1	3.0	1.8	6	6	0.7	●	●	0.90	0.95	0.80	0.80	8
			P36	3	P1	3.0	1.8	6	12	0.7	●	●	0.90	0.95	0.80	0.80	6
			P26	2	P1	3.0	1.8	6	12	0.9	●	●	0.95	0.85	0.90	1.20	10
			P28	2	P1	3.0	1.8	6	16	0.9	●	●	0.95	0.85	0.85	0.85	10
			P29	2	P1	3.0	1.8	6	18	0.7	●	●	0.90	0.95	0.85	0.75	8

Multi fluid and Mixed fluid + LV

	Male solder contacts		Female solder contacts		Reference	Fluidic contact					Low Voltage contact								
	Male crimp contacts		Female crimp contacts			Nb of fluidic tube	Type	Ext. ϕ of tube (see page 3)	Int. ϕ of tube (see page 3)	Max. working pressure (bars)	Contact No	ϕ A (mm)	Contact type		Solder contact		Crimp contact		Rated current (A)
													Solder	Crimp	Test voltage (kV rms) Contact-contact	Test voltage (kV rms) Contact-shell	Test voltage (kV rms) Contact-contact	Test voltage (kV rms) Contact-shell	
5B 5K					P01	10	P1	3.0	1.8	6	-	-	-	-	-	-	-	-	-
					P30	3	P3	6.0	4.0	6	-	-	-	-	-	-	-	-	-
					P40	4	P3	6.0	4.0	6	-	-	-	-	-	-	-	-	-

Housings (B and K series)

Ref.	Outer shell and collet nut		Latch sleeve + earthing crown		Other metallic components		Remarks
	Material	Surf. treatment	Material	Surf. treatment	Material	Surf. treatment	
C	Brass	chrome	brass/bronze	nickel ²⁾	brass	nickel	
G	PEEK (natural)	-	brass/bronze	nickel ²⁾	brass	nickel	Only for FGG and ENG (B series)
P	PSU	-	brass/bronze	nickel ²⁾	brass	nickel	Only for FGY and ENY (B series) ¹⁾

Note: ¹⁾ see «variant» for the colour. ²⁾ in the K series, the latch sleeve is chrome-plated.

Electrical Contact

Contact for plug, socket, and fixed socket

Ref.	Contact type
A	male solder
C	male crimp
L	female solder
M	female crimp
Z	no contact



Collets (B and K series)

D and M type collets for B series

D type



M type



	Reference		Collet ø		Cable ø		Notes
	Type	Code	ø A	ø B	max.	min.	
2B	D	42	4.2	–	4.2	> 3.2	
	D	52	5.2	–	5.2	> 4.2	
	D	62	6.2	–	6.2	> 5.2	
	D	72	7.2	–	7.2	> 6.2	
	D	82	8.2	–	8.2	> 7.2	
	D	92	9.2	8.6	9.2	> 8.2	
	D	99	9.9	8.6	9.9	> 9.2	1)
3B	M	52	5.2	–	5.2	> 4.2	
	D	62	6.2	–	6.2	4.9	
	D	72	7.7	–	7.7	> 6.2	
	D	92	9.2	–	9.2	> 7.7	
	D	10	10.2	–	10.0	> 9.2	
	D	11	11.0	–	11.0	> 10.1	
D	12	12.0	10.2	11.9	10.8	1)	

	Reference		Collet ø		Cable ø		Notes
	Type	Code	ø A	ø B	max.	min.	
4B	M	62	6.2	–	6.2	4.9	
	M	72	7.2	–	7.7	> 6.2	
	M	92	9.2	8.6	9.2	> 7.7	
	D	10	10.8	–	10.5	9.1	
	D	12	12.3	–	12.0	10.6	
	D	13	13.8	12.5	13.5	12.1	
	D	15	15.3	12.5	15.0	13.6	
	D	16	16.3	12.5	16.0	15.1	1)
5B	D	11	11.8	–	11.5	9.6	
	D	13	13.8	–	13.5	11.6	
	D	15	15.8	–	15.5	13.6	
	D	17	17.8	–	17.5	15.6	1)
	D	19	19.8	–	19.5	17.6	1)
	D	21	21.8	–	21.5	19.6	1)
	D	23	23.8	21.8	23.5	21.6	1)
	D	25	25.3	21.8	25.0	23.6	1)

Note: all dimensions are in millimetres.

¹⁾ these collets cannot be used for connector models with nut for fitting a bend relief.



C and K type collets for K series

C type

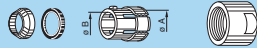

K type
oversize
cable collet



	Reference		Collet \varnothing		Cable \varnothing	
	Type	Code	\varnothing A	\varnothing B	max.	min.
2K	C	35	4.2	–	3.5	3.1
	C	40	4.2	–	4.0	3.6
	C	45	5.2	–	4.5	4.1
	C	50	5.2	–	5.0	4.6
	C	55	6.2	–	5.5	5.1
	C	60	6.2	–	6.0	5.6
	C	65	7.2	–	6.5	6.1
	C	70	7.2	–	7.0	6.6
	C	75	8.2	8.2	7.5	7.1
	C	80	8.2	8.2	8.0	7.6
	C	85	9.2	8.6	8.5	8.1
	K	90	9.2	–	9.0	8.6
	K	95	10.2	10.2	9.5	9.1
	K	10	10.2	10.2	10.0	9.6
K	11	11.2	10.6	10.5	10.1	
3K	C	30	3.2	–	3.0	2.6
	C	35	4.2	–	3.5	3.1
	C	40	4.2	–	4.0	3.6
	C	45	5.2	–	4.5	4.1
	C	50	5.2	–	5.0	4.6
	C	55	6.2	–	5.5	5.1
	C	60	6.2	–	6.0	5.6
	C	65	7.2	–	6.5	6.1
	C	70	7.2	–	7.0	6.6
	C	75	8.2	–	7.5	7.1
	C	80	8.2	–	8.0	7.6
	C	85	9.2	–	8.5	8.1
	C	90	9.2	–	9.0	8.6
	C	95	10.2	10.2	9.5	9.1
	C	10	10.2	10.2	10.0	9.6
	C	11	11.2	10.6	10.5	10.1
	K	11	12.3	–	12.0	10.6
	K	12	13.8	13.8	12.8	12.1
	K	13	13.8	13.8	13.5	12.9
	K	14	15.3	15.3	14.0	13.6
K	15	15.3	15.3	15.0	14.1	

	Reference		Collet \varnothing		Cable \varnothing	
	Type	Code	\varnothing A	\varnothing B	max.	min.
4K	C	50	6.3	–	5.0	4.6
	C	55	6.3	–	5.5	5.1
	C	60	6.3	–	6.0	5.6
	C	65	7.3	–	6.5	6.1
	C	70	7.3	–	7.0	6.6
	C	75	8.3	–	7.5	7.1
	C	80	8.3	–	8.0	7.6
	C	85	9.3	–	8.5	8.1
	C	90	9.3	–	9.0	8.6
	C	95	10.8	–	9.5	9.1
	C	10	10.8	–	10.5	9.6
	C	11	12.3	–	12.0	10.6
	C	12	13.8	13.8	12.8	12.1
	C	13	13.8	13.8	13.5	12.9
	C	14	15.3	15.3	14.0	13.6
	C	15	15.3	15.3	15.0	14.1
	K	16	17.8	–	16.5	15.6
	K	17	17.8	–	17.5	16.6
	K	18	19.8	–	18.5	17.6
	K	19	19.8	–	19.5	18.6
	K	20	21.8	–	20.5	19.6
	K	21	21.8	–	21.5	20.6
	K	22	23.8	23.8	22.5	21.6
K	23	23.8	23.8	23.5	22.6	
5K	C	10	11.8	–	10.5	9.6
	C	11	11.8	–	11.5	10.6
	C	12	13.8	–	12.5	11.6
	C	13	13.8	–	13.5	12.6
	C	14	15.8	–	14.5	13.6
	C	15	15.8	–	15.5	14.6
	C	16	17.8	–	16.5	15.6
	C	17	17.8	–	17.5	16.6
	C	18	19.8	–	18.5	17.6
	C	19	19.8	–	19.5	18.6
	C	20	21.8	–	20.5	19.6
C	21	21.8	–	21.5	20.6	
C	22	23.8	23.8	22.5	21.6	
C	23	23.8	23.8	23.5	22.6	

Note: all dimensions are in millimetres.

Tools

Extractor

Reference	Contact type
DCC.91.10P.1LA	P1
DCC.91.808.0LC	P3

Variant (B and K series)

Bend relief for B series models with collet

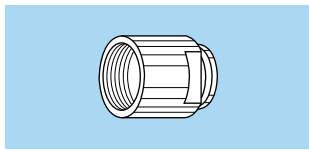

Need to be ordered

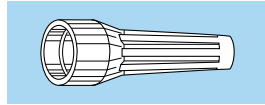

	Ref.	Collet		Need to be ordered separately
		Type	Code	
2B	Z	D	42 to 92	GMA.2B.●●●●
3B	Z	M	52	GMA.1B.●●●●
		D	62 to 10	GMA.3B.●●●●
4B	Z	M	62 and 72	GMA.2B.●●●●
		M	92	GMA.4B.●●●●
		D	10 to 15	GMA.4B.●●●●
5B	Z	D	11 to 15	GMA.4B.●●●●

Bend relief for K series models with collet

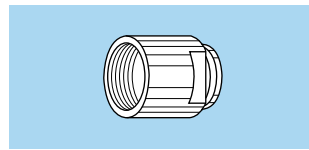

Need to be ordered

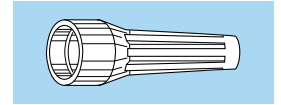

	Ref.	Collet		Need to be ordered separately
		Type	Code	
2K	Z	C	40 to 85	GMA.2B.●●●●
		K	90 to 10	GMA.3B.●●●●
3K	Z	C	40 to 10	GMA.3B.●●●●
		K	11 to 15	GMA.4B.●●●●
4K	Z	C	50 to 15	GMA.4B.●●●●

Note: All dimensions are in millimetres.

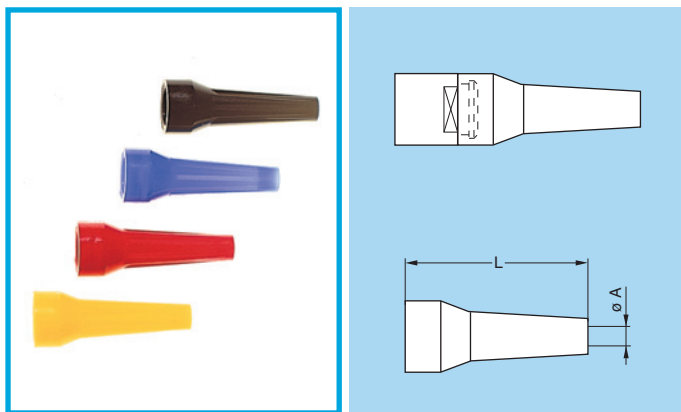

GM● Bend relief

A bend relief made from thermoplastic polyurethane elastomer can be fitted over LEMO plugs and sockets that are supplied with nut for fitting such bend relief.

They are available in nine different colours that match with the GRA insulating washers (see unipole-multipole catalog). Use the part numbers shown below to order this accessory separately.

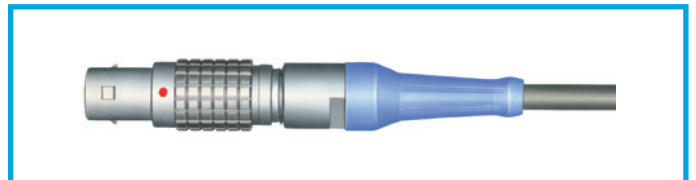

Main characteristics

- Material: TPU (Thermoplastic Polyurethane)
- Temperature range in dry atmosphere: -40°C +80°C

Part number	Dimensions (mm)				Series
	Bend relief		Cable ø		
	A	L	max.	min.	
GMA.2B.040.DG	4.0	36	4.5	4.0	2B-2K
GMA.2B.045.DG	4.5	36	5.0	4.5	
GMA.2B.060.DG	6.0	36	6.5	6.0	
GMA.2B.070.DG	7.0	36	7.7	7.0	
GMA.3B.060.DG	6.0	42	6.9	6.0	3B-3K
GMA.3B.070.DG	7.0	42	7.9	7.0	
GMA.3B.080.DG	8.0	42	8.9	8.0	
GMA.4B.011.DG	11.0	60	11.9	11.0	4B-4K-5B
GMA.4B.012.DG	12.0	60	13.0	12.0	
GMA.4B.013.DG	13.5	60	14.5	13.5	

Ref.	Colour	Ref.	Colour
A	blue	N	black
B	white	R	red
G	grey	S	orange
J	yellow	V	green
M	brown		

Note: the last letter «G» of the part number indicates the grey colour of the bend relief. For ordering a bend relief with another colour, see table above and replace the letter «G» by the letter of the required colour.

Product safety notice

PLEASE READ AND FOLLOW ALL INSTRUCTIONS CAREFULLY AND CONSULT ALL RELEVANT NATIONAL AND INTERNATIONAL SAFETY REGULATIONS FOR YOUR APPLICATION. IMPROPER HANDLING, CABLE ASSEMBLY, OR WRONG USE OF CONNECTORS CAN RESULT IN HAZARDOUS SITUATIONS.

1. SHOCK AND FIRE HAZARD

Incorrect wiring, the use of damaged components, presence of foreign objects (such as metal debris), and / or residue (such as cleaning fluids), can result in short circuits, overheating, and / or risk of electric shock. Mated components should never be disconnected while live as this may result in an exposed electric arc and local overheating, resulting in possible damage to components.

2. HANDLING

Connectors and their components should be visually inspected for damage prior to installation and assembly. Suspect components should be rejected or returned to the factory for verification. Connector assembly and installation should only be carried out by properly trained personnel. Proper tools must be used during installation and / or assembly in order to obtain safe and reliable performance.

3. USE

Connectors with exposed contacts should never be live (or on the current supply side of a circuit). Under general conditions voltages above 30 VAC and 42 VDC are considered hazardous and proper measures should be taken to eliminate all risk of transmission of such voltages to any exposed metal part of the connector.

4. TEST AND OPERATING VOLTAGES

The maximum admissible operating voltage depends upon the national or international standards in force for the application in question. Air and creepage distances impact the operating voltage; reference values are indicated in the catalog however these may be influenced by PC board design and / or wiring harnesses. The test voltage indicated in the catalog is 75% of the mean breakdown voltage; the test is applied at 500 V/s and the test duration is 1 minute.

5. CE MARKING

CE marking  means that the appliance or equipment bearing it complies with the protection requirements of one or several European safety directives.

CE marking  applies to complete products or equipment, **but not to electromechanical components, such as connectors.**

6. PRODUCT IMPROVEMENTS

The LEMO Group reserves the right to modify and improve to our products or specifications without providing prior notification.

LEMO HEADQUARTERS

SWITZERLAND

LEMO SA

Chemin des Champs-Courbes 28 - P.O. Box 194 - CH-1024 Ecublens
Tel. (+41 21) 695 16 00 - Fax (+41 21) 695 16 02 - e-mail: info@lemo.com

LEMO SUBSIDIARIES

AUSTRIA

LEMO Elektronik GesmbH

Lemböckgasse 49/E6-3
1230 Wien
Tel: (+43 1) 914 23 20 0
Fax: (+43 1) 914 23 20 11
sales@lemo.at

BRAZIL

LEMO Latin America Ltda

Av. José Rocha Bonfim,
214 Salas 224 / 225
Condomínio Praça Capital
Ed. Chicago
Campinas / SP - Brasil 13080-650
Tel: +55 (11) 98689 4736
info-la@lemo.com

CANADA

LEMO Canada Inc

44 East Beaver Creek Road, unit 20
Richmond Hill, Ontario L4B 1G8
Tel: (+1 905) 889 56 78
Fax: (+1 905) 889 49 70
info-canada@lemo.com

CHINA / HONG KONG

LEMO Electronics (Shanghai) Co., Ltd

First Floor, Block E,
18 Jindian Road, Pudong
Shanghai, China, 201206
Tel: (+86 21) 5899 7721
Fax: (+86 21) 5899 7727
cn.sales@lemo.com

DENMARK

LEMO Denmark A/S

Gammel Mosevej 46
2820 Gentofte
Tel: (+45) 45 20 44 00
Fax: (+45) 45 20 44 01
info-dk@lemo.com

FRANCE

LEMO France Sàrl

24/28 Avenue Graham Bell
Bâtiment Balthus 4
Bussy Saint Georges
77607 Marné la Vallée Cedex 3
Tel: (+33 1) 60 94 60 94
Fax: (+33 1) 60 94 60 90
info-fr@lemo.com

GERMANY

LEMO Elektronik GmbH

Hanns-Schwindt-Str. 6
81829 München
Tel: (+49 89) 42 77 03
Fax: (+49 89) 420 21 92
info@lemo.de

HUNGARY

REDEL Elektronika Kft

Nagysándor József u. 6-12
1201 Budapest
Tel: (+36 1) 421 47 10
Fax: (+36 1) 421 47 57
info-hu@lemo.com

ITALY

LEMO Italia srl

Viale Lunigiana 25
20125 Milano
Tel: (+39 02) 66 71 10 46
Fax: (+39 02) 66 71 10 66
sales.it@lemo.com

JAPAN

LEMO Japan Ltd

2-7-22, Mita,
Minato-ku, Tokyo, 108-0073
Tel: (+81 3) 54 46 55 10
Fax: (+81 3) 54 46 55 11
lemoinfo@lemo.co.jp

MIDDLE EAST

LEMO Middle East Gen. Trad. LLC

Concorde Tower 6th Floor,
Dubai Media City, P.O. Box 126732
Dubai, United Arab Emirates
Tel: +971 55 222 36 77
info-me@lemo.com

NETHERLANDS / BELGIUM

LEMO Connectors Benelux

De Trompet 1060
1967 DA Heemskerk
Tel: (+31) 251 25 78 20
Fax: (+31) 251 25 78 21
info@lemo.nl

NORWAY / ICELAND

LEMO Norway A/S

Stanseveien 6B, 0975 Oslo
Tel: (+47) 22 91 70 40
Fax: (+47) 22 91 70 41
info-no@lemo.com

SINGAPORE

LEMO Asia Pte Ltd

4 Leng Kee Road,
#06-09 SiS Building
Singapore 159088
Tel: (+65) 6476 0672
Fax: (+65) 6474 0672
sg.sales@lemo.com

SPAIN / PORTUGAL

IBERLEMO SAU

Brasil, 45, 08402 Granollers
Barcelona
Tel: (+34 93) 860 44 20
Fax: (+34 93) 879 10 77
info-es@lemo.com

SWEDEN / FINLAND

LEMO Nordic AB

Mariehällsvägen 39A
168 65 Bromma
Tel: (+46 8) 635 60 60
Fax: (+46 8) 635 60 61
info-se@lemo.com

SWITZERLAND

LEMO Verkauf AG

Grundstrasse 22 B
6343 Rotkreuz
Tel: (+41 41) 790 49 40
ch.sales@lemo.com

UNITED KINGDOM

LEMO UK Ltd

12-20 North Street, Worthing,
West Sussex, BN11 1DU
Tel: (+44 1903) 23 45 43
lemouk@lemo.com

USA

LEMO USA Inc

P.O. Box 2408
Rohnert Park, CA 94927-2408
Tel: (+1 707) 578 88 11
(+1 800) 444 53 66
Fax: (+1 707) 578 08 69
info-US@lemo.com

LEMO DISTRIBUTORS

AUSTRALIA, CHILE, CZECH REPUBLIC, GREECE, INDIA, ISRAEL,
NEW ZEALAND, POLAND, RUSSIA, SOUTH AFRICA, SOUTH KOREA,
TAIWAN, TURKEY, UKRAINE

www.lemo.com