

DESCRIPTION

The MC34064 is an undervoltage sensing circuit designed specifically for use as a reset controller in microprocessor-based systems. It offers the designer an economical, space-efficient solution for low supply voltage detection when used in combination with a single pullup resistor. Adding one capacitor offers the functionality of a programmable delay time after power returns. The 34064 consists of a temperature stable reference comparator with hysteresis, high-current clamping diode and open collector output stage capable of sinking up to 60mA. The MC34064's RESET output is specified to be fully functional at $V_{IN}=1V$. A major improvement over competing products is the glitch-free supply current during undervoltage detection. Competing products demand a step function increase in operating current during the time that you least want or need it: during power loss. See Product Highlight below.

IMPORTANT: For the most current data, consult MICROSEMI's website: <http://www.microsemi.com>

KEY FEATURES

- Monitors 5V Supplies ($V_T = 4.6V$ Typ.)
- Outputs Fully Defined At $V_{IN} = 1V$ (See Figure 1)
- Glitch-Free Supply Current During Switching (See Product Highlight)
- Ultra-Low Supply Current (500 μA Max.)
- Temperature Compensated ICC For Extremely Stable Current Consumption
- μP Reset Function Programmable With 1 External Resistor And Capacitor
- Comparator Hysteresis Prevents Output Oscillation
- Electrically Compatible With Motorola MC34064
- Pin-to-Pin Compatible With Motorola MC34064 / MC34164

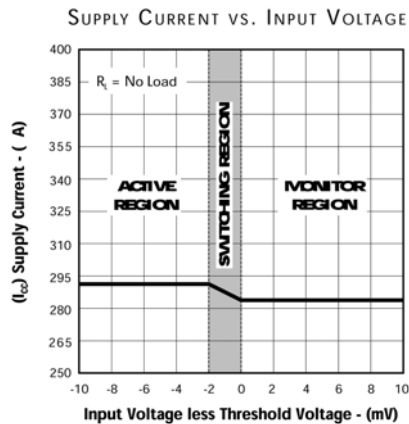
PRODUCT HIGHLIGHT

APPLICATIONS

- All Microprocessor Or Microcontroller Designs Using 5V Supplies
- Simple 5V Undervoltage Detection

PACKAGE ORDER INFO

T_A ($^{\circ}C$)	DM Plastic SOIC 8-Pin	LP Plastic TO-92 3-Pin	PK Plastic SOT-89 3-Pin
	RoHS / Pb-free Transition DC: 0440	RoHS / Pb-free Transition DC: 0509	RoHS / Pb-free Transition DC: 0518
0 to 70	MC34064DM	MC34064LP	MC34064PK
-40 to 85	MC33064DM	MC33064LP	MC33064PK

Note: Available in Tape & Reel. Append the letters "TR" to the part number. (i.e. LX34064DM-TR)

Undervoltage Sensing Circuit
PRODUCTION DATA SHEET
ABSOLUTE MAXIMUM RATINGS

Input Supply Voltage (V_{IN}).....	-1V to 10V
RESET Output Voltage (V_{OUT}).....	10V
Output Sink Current (I_{OL}).....	Internally Limited (mA)
Clamp Diode Forward Current (I_F), Pin 1 to Pin 2.....	100mA
Operating Temperature Range.....	150°C
Operating Ambient Temperature Range (T_A)	
MC34064	0°C to 70°C
MC33064	-40°C to 85°C
Storage Temperature Range.....	-65°C to 150°C
Package Peak Temp. for Solder Reflow (40 seconds maximum exposure) ...	260°C (+0 -5)

Note: Exceeding these ratings could cause damage to the device. All voltages are with respect to Ground. Currents are positive into, negative out of specified terminal.

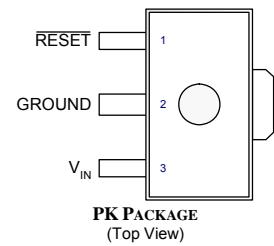
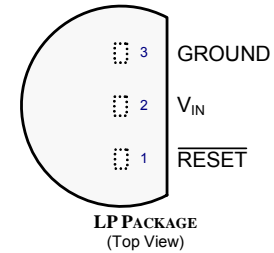
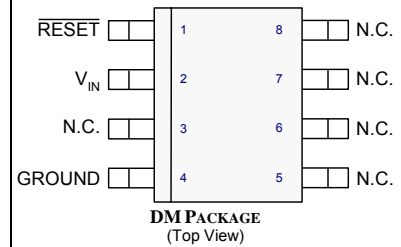
PACKAGE PIN OUT

RoHS / Pb-free 100% matte Tin Lead Finish

THERMAL DATA
DM Plastic SOIC 8-Pin

THERMAL RESISTANCE-JUNCTION TO AMBIENT, θ_{JA}	165°C/W
---	----------------

LP Plastic TO-92 3-Pin

THERMAL RESISTANCE-JUNCTION TO AMBIENT, θ_{JA}	156°C/W
---	----------------

PK Plastic SOT-89 3-Pin

THERMAL RESISTANCE-JUNCTION TO TAB, θ_{JT}	35°C/W
THERMAL RESISTANCE-JUNCTION TO AMBIENT, θ_{JA}	71°C/W

Junction Temperature Calculation: $T_J = T_A + (P_D \times \theta_{JA})$.

The θ_{JA} numbers are guidelines for the thermal performance of the device/pc-board system. All of the above assume no ambient airflow.

RECOMMENDED OPERATING CONDITIONS

Conditions: Range over which the device is functional.

Parameter	Symbol	MC3x064			Units
		Min	Typ	Max	
Input Supply Voltage	V_{IN}	1		6.5	V
RESET Output Voltage	V_{OUT}		6.5		V
Clamp Diode Forward Current	I_F		50		mA

IC ELECTRICAL CHARACTERISTICS

Unless otherwise specified, the following specifications apply over the operating ambient temperature $0^{\circ}\text{C} \leq T_A \leq 70^{\circ}\text{C}$ for the MC34064 and $-40^{\circ}\text{C} \leq T_A \leq 85^{\circ}\text{C}$ for the MC33064. Low duty cycle pulse testing techniques are used which maintains junction and case temperatures equal to the ambient temperature.

Parameter	Symbol	Test Conditions	MC3x064			Units
			Min	Typ	Max	
COMPARATOR SECTION						
Threshold Voltage						
High State Output	V_{T+}	V_{IN} Increasing – 4V to 5V	4.5	4.61	4.7	V
Low State Outputs	V_{T-}	V_{IN} Decreasing – 5V to 4V	4.5	4.59	4.7	V
Hysteresis	V_H		0.01	0.02	0.05	V
RESET OUTPUT SECTION						
Output Low Level Saturation Voltage	V_{OL}	$V_{IN} = 4.0\text{V}, I_{OL} = 8.0\text{mA}$			1.0	V
		$V_{IN} = 4.0\text{V}, I_{OL} = 2.0\text{mA}$			0.4	V
		$V_{IN} = 1.0\text{V}, I_{OL} = 0.1\text{mA}$			0.1	V
Output Low Level Current	I_{OL}	$V_{IN} = V_{OUT} = 4.0\text{V}$	10	27	60	mA
Output Off-State Leakage	I_{OH}	$V_{IN} = V_{OUT} = 5.0\text{V}$		0.02	0.5	μA
Clamp Diode Forward Voltage	V_F	Pin 1 to Pin 2, $I_F = 10\text{mA}$	0.6	0.9	1.2	V
TOTAL DEVICE						
Supply Current	I_{CC}	$V_{IN} = 5.0\text{V}$		390	500	μA

CHART AND APPLICATION INDEX
Characteristic Curves

- Figure #
- Input Voltage and $\overline{\text{RESET}}$ Output Voltage vs. Time
 - Power-Up $\overline{\text{RESET}}$ Voltage
 - Power-Down $\overline{\text{RESET}}$ Voltage
 - $\overline{\text{RESET}}$ Output Voltage vs. Input Voltage
 - Threshold Voltage vs. Temperature
 - Threshold Hysteresis vs. Temperature
 - Supply Current vs. Input Voltage
 - Supply Current vs. Temperature
 - Low Level Output Current vs. Temperature
 - Low Level Output Saturation Voltage vs. Temperature
 - Low Level Output Saturation Voltage vs. Temperature
 - Clamp Diode Forward Voltage vs. Forward Current
 - Propagation Delay – HIGH to LOW
 - Propagation Delay – LOW to HIGH

Application Circuits

- Figure #
- Low Voltage Microprocessor Reset
 - Switching the Load off when Battery Reaches Below 4.3V
 - Voltage Monitor
 - MOSFET Low Voltage Gate Drive Protection
 - Low Voltage Microprocessor Reset with Additional Hysteresis
 - Solar Powered Battery



SIMPLIFIED BLOCK DIAGRAM

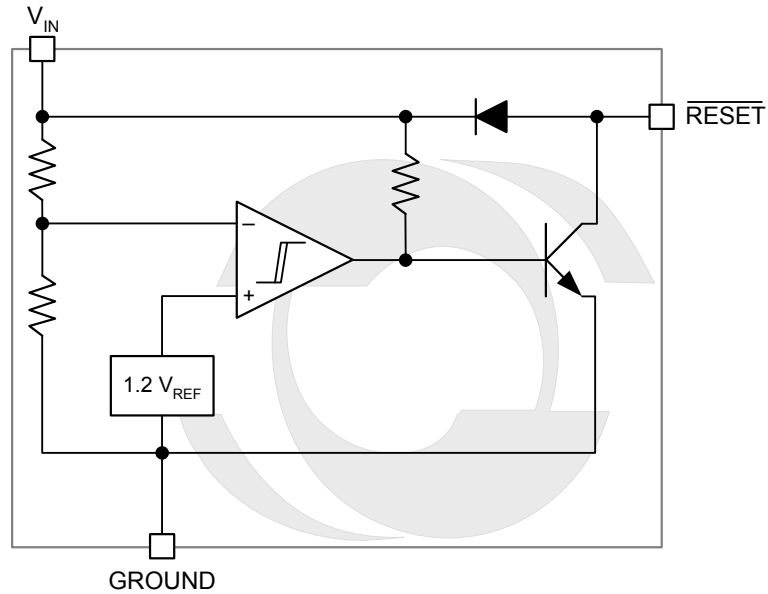

Simplified Block Diagram

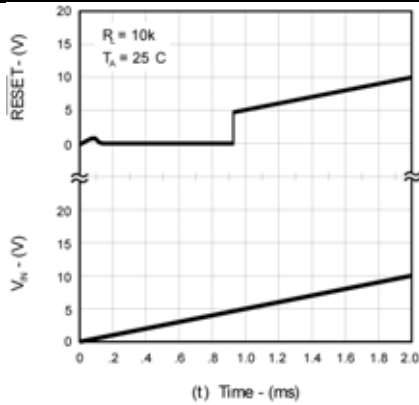
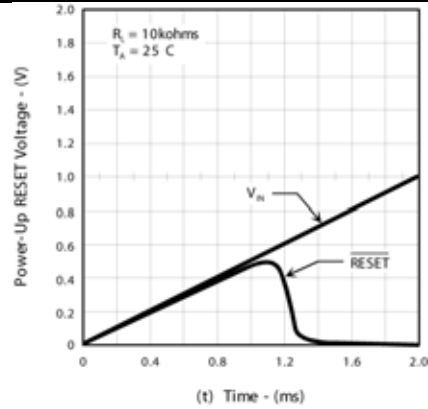
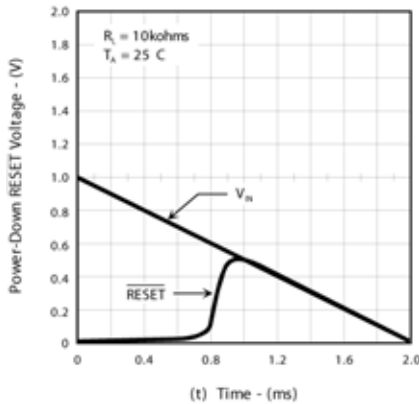
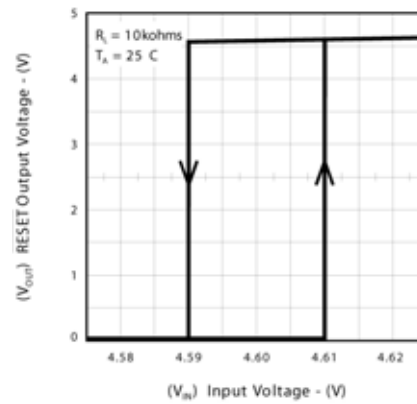
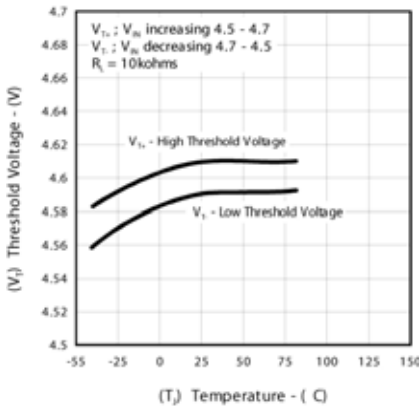
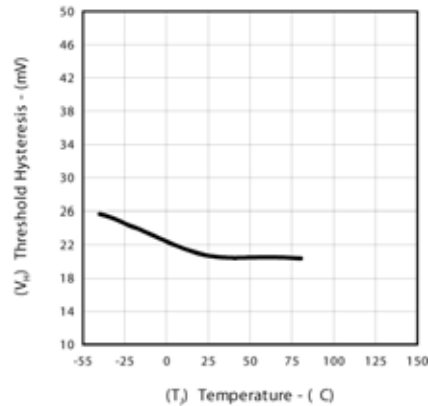
CHARACTERISTIC CURVES

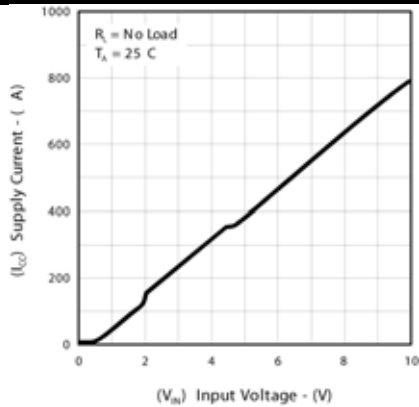
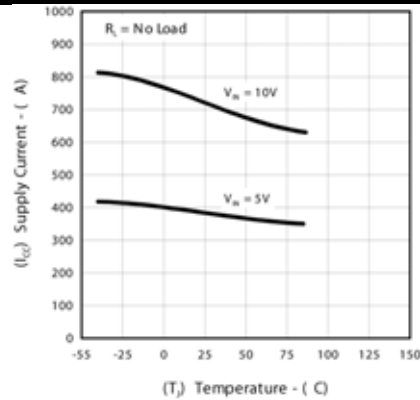
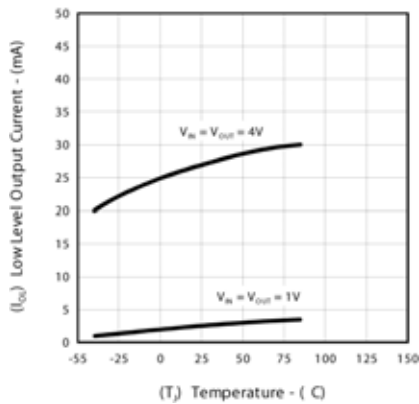
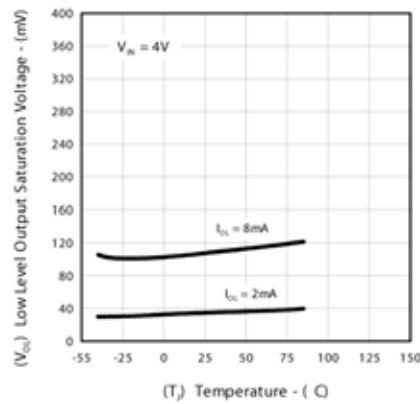
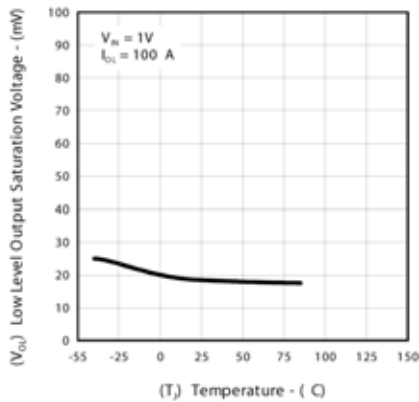
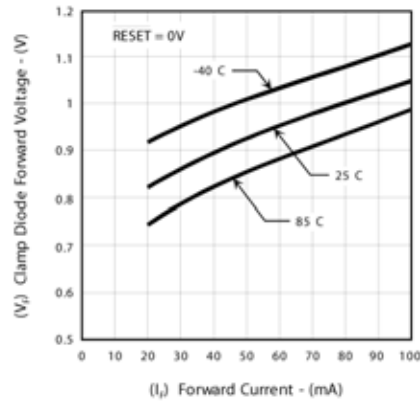
Figure 1 – Input Voltage and $\overline{\text{RESET}}$ Output Voltage vs. Time

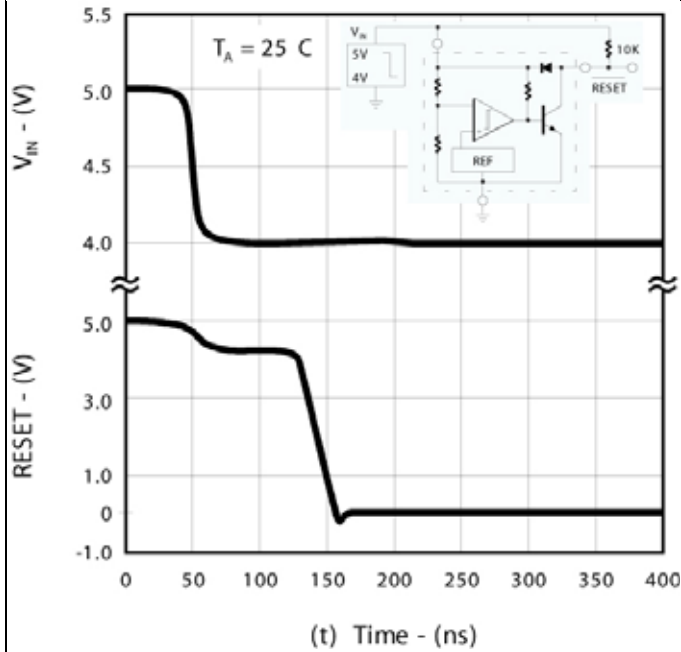
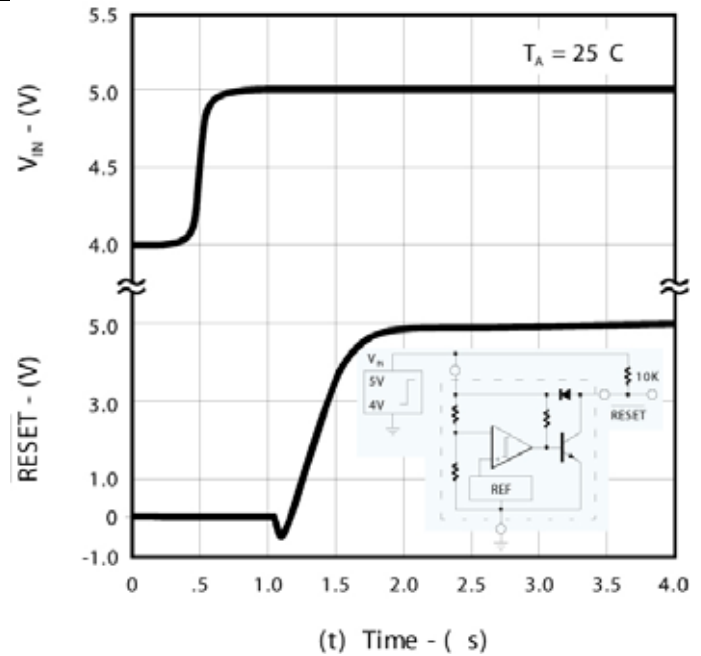
Figure 2 – Power-Up $\overline{\text{RESET}}$ Voltage

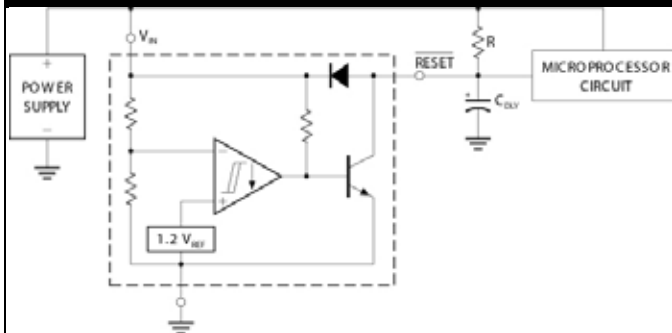
Figure 3 – Power-Down $\overline{\text{RESET}}$ Voltage

Figure 4 – $\overline{\text{RESET}}$ Output Voltage vs. Input Voltage

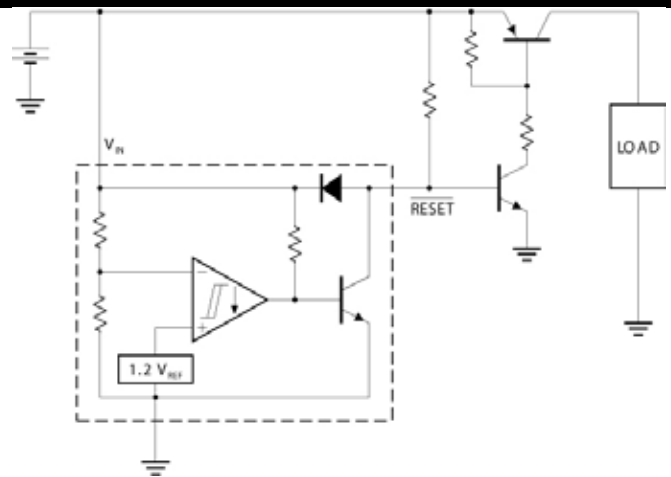
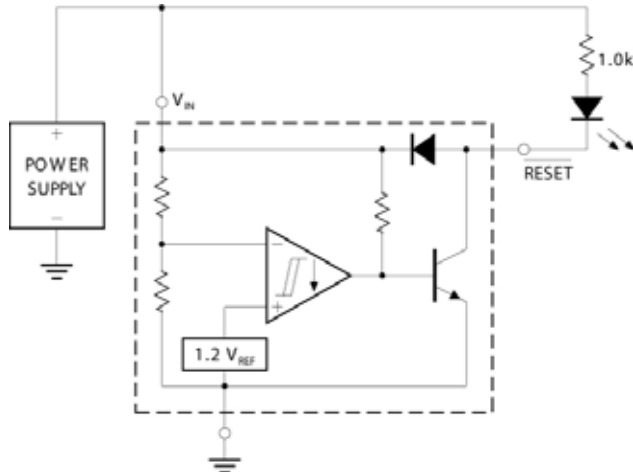
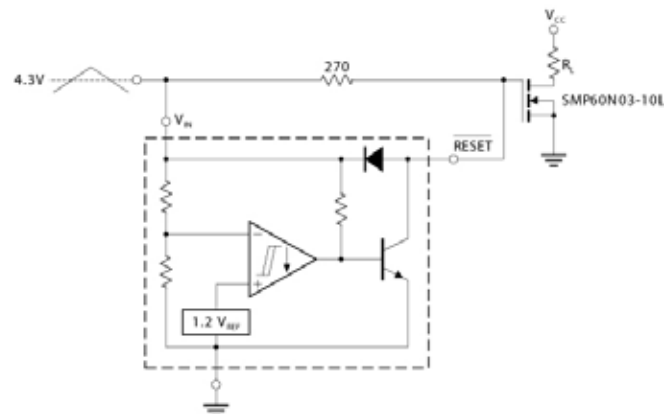
Figure 5 – Threshold Voltage vs. Temperature

Figure 6 – Threshold Hysteresis vs. Temperature

CHARACTERISTIC CURVES

Figure 7 – Supply Current vs. Input Voltage

Figure 8 – Supply Current vs. Temperature

Figure 9 – Low Level Output Current vs. Temperature

Figure 10 – Low Level Output Saturation Voltage vs. Temperature

Figure 11 – Low Level Output Saturation Voltage vs. Temperature

Figure 12 – Clamp Diode Forward Voltage vs. Forward Current

CHARACTERISTIC CURVES

Figure 13 – Propagation Delay – HIGH to LOW

Figure 14 – Propagation Delay – LOW to HIGH

TYPICAL APPLICATION CIRCUITS

Figure 15 – Low Voltage Microprocessor Reset

A time delayed reset can be accomplished with the addition of C_{DLY} . For systems with extremely fast power supply rise times (<500ns) it is recommended that the RC_{DLY} time constant be greater than $5.0\mu s$. $V_{TH(MPU)}$ is the microprocessor reset input threshold.

Figure 16 – Switching the Load off When battery Reaches Below 4.3V

Figure 17 – Voltage Monitor

Figure 18 – MOSFET Low Voltage gate Drive Protection

Overheating of the logic level power MOSFET due to insufficient gate voltage can be prevented with the above circuit. When the input signal is below the 4.6 volt threshold of the MC34064, its output grounds the gate of the L^2 MOSFET.

TYPICAL APPLICATION CIRCUITS

Figure 19 – Low Voltage Microprocessor Reset with Additional Hysteresis.

$$V_H = \frac{4.6R_H}{R_L} + 0.02$$

$$V_{TH(LOWER)} = 340R_H \cdot 10^{-6}$$

Where: $R_H = 150\Omega$
 $R_L = 1.5\Omega = 10k\Omega$

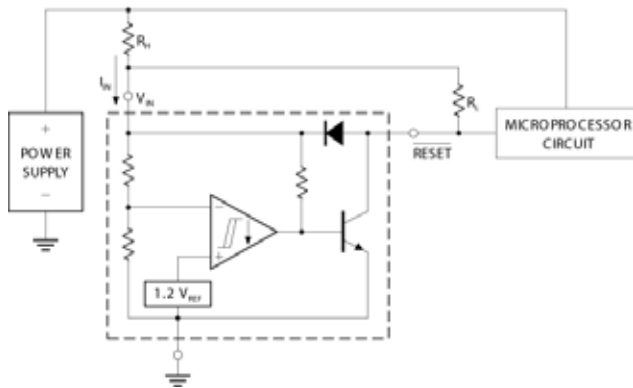
Test Data			
VH (mV)	ΔV_{TH} (mV)	RH (Ω)	RL (Ω)
20	0	0	0
51	3.4	10	1.5
40	6.8	20	4.7
81	6.8	20	1.5
71	10	30	2.7
112	10	30	1.5
100	16	47	2.7
164	16	47	1.5
190	34	100	2.7
327	34	100	1.5
276	51	150	2.7
480	51	150	1.5

Comparator hysteresis can be increased with the addition of resistor R_H . The hysteresis equation has been simplified and does not account for the change of input current I_{IN} as V_{CC} crosses the comparator threshold. An increase of the lower threshold. $\Delta V_{TH(LOWER)}$ will be observed due to I_{IN} which is typically $340\mu A$ at $4.59V$. The equations are accurate to $\pm 10\%$ with R_H less than 150Ω and R_L between $1.5k\Omega$ and $10k\Omega$.

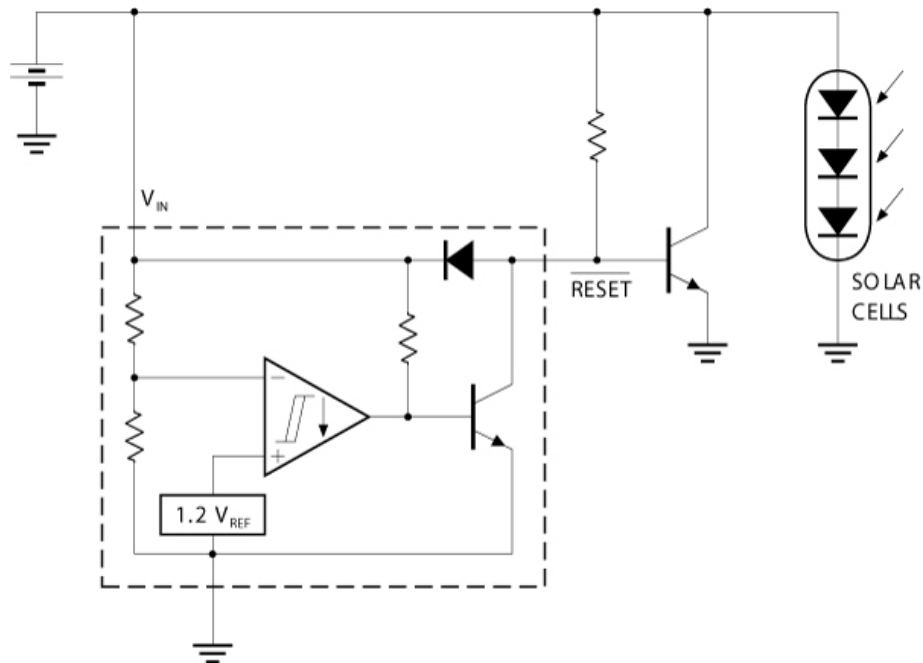

Figure 20 – Solar Powered Battery Charger



Microsemi[®]

MC33064 / MC34064

Undervoltage Sensing Circuit

PRODUCTION DATA SHEET

NOTES

PRODUCTION DATA – Information contained in this document is proprietary to Microsemi and is current as of publication date. This document may not be modified in any way without the express written consent of Microsemi. Product processing does not necessarily include testing of all parameters. Microsemi reserves the right to change the configuration and performance of the product and to discontinue product at any time.