

Features

- Dual TVS in Common Cathode Configuration for ESD Protection
- 40 Watt Peak Power Dissipation @1.0ms (Unidirectional)
- 225mW Power Dissipation
- Ideally Suited for Automated Insertion
- Low Leakage
- **Totally Lead-Free & Fully RoHS Compliant (Notes 1 & 2)**
- **Halogen and Antimony Free. "Green" Device (Note 3 & 4)**

Mechanical Data

- Case: SOT23
- Case Material: Molded Plastic. UL Flammability Rating Classification 94V-0
- Moisture Sensitivity: Level 1 per J-STD-020
- Terminals: Solderable per MIL-STD-202, Method 208 Lead Free ^(e3) Plating (Matte Tin Finish annealed over Alloy 42 leadframe).
- Polarity: See Diagram
- Weight: 0.008 grams (approximate)

SOT23



Top View

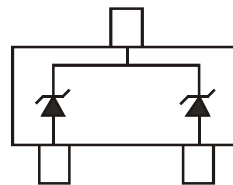

Device Schematic

Ordering Information (Note 5 & 6)

Part Number	Compliance	Case	Packaging
MMBZ15VDL-7-F	Standard	SOT23	3000/Tape & Reel
MMBZ27VCL-7-F	Standard	SOT23	3000/Tape & Reel
MMBZ15VDLQ-7-F	Automotive	SOT23	3000/Tape & Reel
MMBZ27VCLQ-7-F	Automotive	SOT23	3000/Tape & Reel

- Notes:
1. No purposely added lead. Fully EU Directive 2002/95/EC (RoHS) & 2011/65/EU (RoHS 2) compliant.
 2. See http://www.diodes.com/quality/lead_free.html for more information about Diodes Incorporated's definitions of Halogen- and Antimony-free, "Green" and Lead-free.
 3. Halogen- and Antimony-free "Green" products are defined as those which contain <900ppm bromine, <900ppm chlorine (<1500ppm total Br + Cl) and <1000ppm antimony compounds.
 4. Product manufactured with Date Code V9 (week 33, 2008) and newer are built with Green Molding Compound. Product manufactured prior to Date Code V9 are built with Non-Green Molding Compound and may contain Halogens or Sb₂O₃ Fire Retardants.
 5. Automotive products are AEC-Q101 qualified and are PPAP capable. Automotive, AEC-Q101 and standard products are electrically and thermally the same, except where specified.
 6. For packaging details, go to our website at <http://www.diodes.com/products/packages.html>.

Marking Information

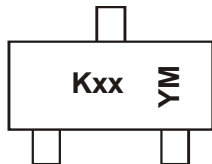

xx = Product Type Marking Code
 YM = Date Code Marking for Shanghai
 Assembly / Test site
 Y = Year (ex: A = 2013)
 M = Month (ex: 9 = September)

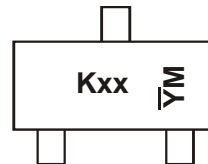

xx = Product Type Marking Code
 YM = Date Code Marking for Chengdu
 Assembly / Test site
 Y = Year (ex: A = 2013)
 M = Month (ex: 9 = September)

Date Code Key

Year	2006	2007	2008	2009	2010	2011	2012	2013	2014	2015	2016	2017
Code	T	U	V	W	X	Y	Z	A	B	C	D	E

Month	Jan	Feb	Mar	Apr	May	Jun	Jul	Aug	Sep	Oct	Nov	Dec
Code	1	2	3	4	5	6	7	8	9	O	N	D

Maximum Ratings (@ $T_A = +25^\circ\text{C}$, unless otherwise specified.)

Characteristic	Symbol	Value	Unit
Peak Power Dissipation (Note 7)	P_{PK}	40	W

Thermal Characteristics

Characteristic	Symbol	Value	Unit
Power Dissipation (Note 8)	P_D	225	mW
Thermal Resistance, Junction to Ambient Air (Note 8)	$R_{\theta JA}$	556	$^\circ\text{C/W}$
Operating and Storage Temperature Range	T_J, T_{STG}	-65 to +150	$^\circ\text{C}$

Electrical Characteristics (@ $T_A = +25^\circ\text{C}$, unless otherwise specified.)

 $V_F = 0.9\text{V max @ } I_F = 10\text{mA}$

Type Number	Marking Code	V_{RWM}	Max Reverse Leakage I_R @ V_{RWM} (Note 9)	Breakdown Voltage				Max. Clamping Voltage V_C @ I_{PP} (Note 7)		Typical Temperature Coefficient T_C (%/ $^\circ\text{C}$)
				V_{BR} (Note 9) (V)			@ I_T	V_C	I_{PP}	
				Min	Nom	Max	mA	V	A	
MMBZ15VDL	KVJ	12.8	100	14.3	15	15.8	1.0	21.2	1.9	+0.080

 $V_F = 1.1\text{V max @ } I_F = 200\text{mA}$

Type Number	Marking Code	V_{RWM}	Max Reverse Leakage I_R @ V_{RWM} (Note 9)	Breakdown Voltage				Max. Clamping Voltage V_C @ I_{PP} (Note 7)		Typical Temperature Coefficient T_C (%/ $^\circ\text{C}$)
				V_{BR} (Note 9) (V)			@ I_T	V_C	I_{PP}	
				Min	Nom	Max	mA	V	A	
MMBZ27VCL	KVP	22	50	25.65	27	28.35	1.0	38	1.0	+0.090

- Notes:
7. Non-repetitive current pulse per Figure 2 and derate above $T_A = +25^\circ\text{C}$ per Figure 1.
 8. Device mounted on FR-5 PCB 1.0 x 0.75 x 0.062 inch pad layout as shown on Diodes Inc. suggested pad layout AP02001, which can be found on our website at <http://www.diodes.com>. 200mW per element must not be exceeded.
 9. Short duration pulse test used to minimize self-heating effect.

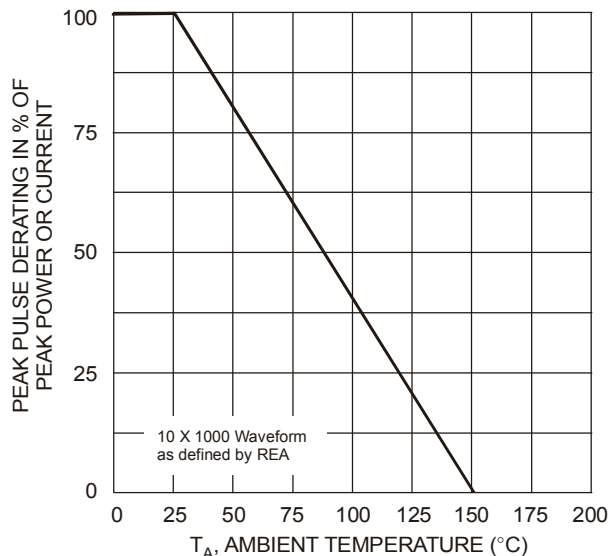

Figure 1 Pulse Derating Curve

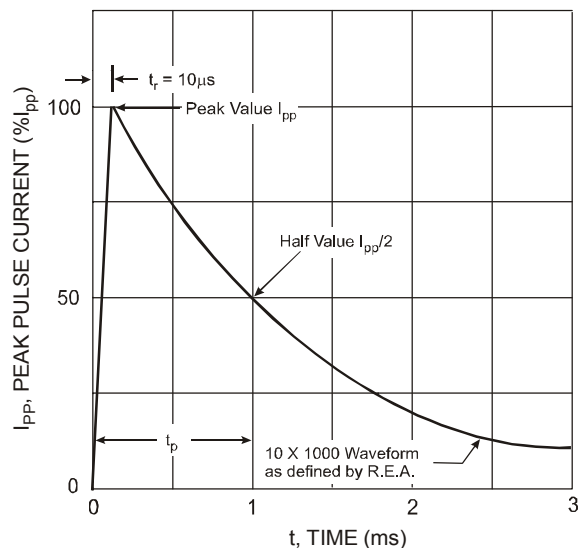

Figure 2 Pulse Waveform

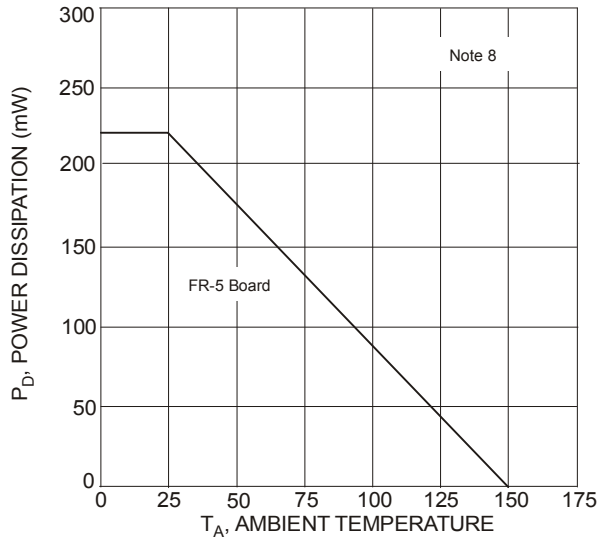

Figure 3 Steady State Power Derating Curve

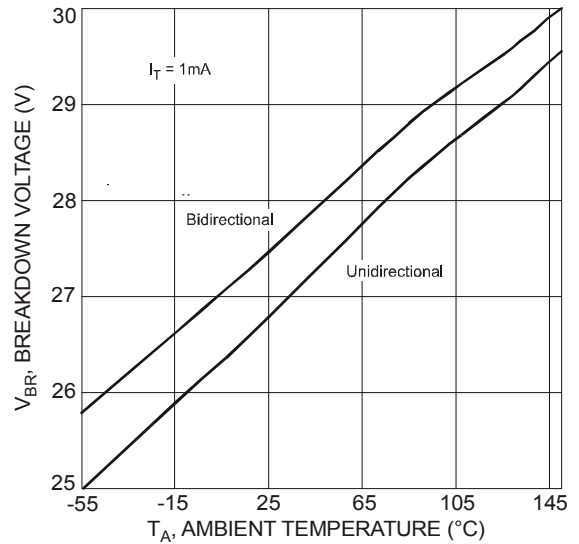

Figure 4 Typical Breakdown Voltage vs. Temperature (MMBZ27VCL)

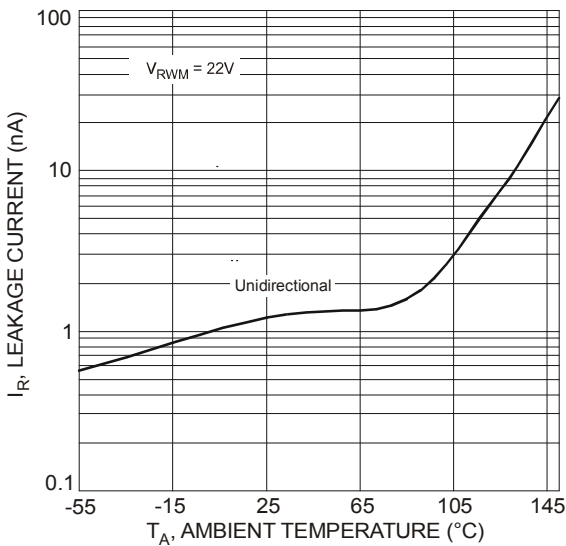

Figure 5 Typical Leakage Current vs. Temperature (MMBZ27VCL)

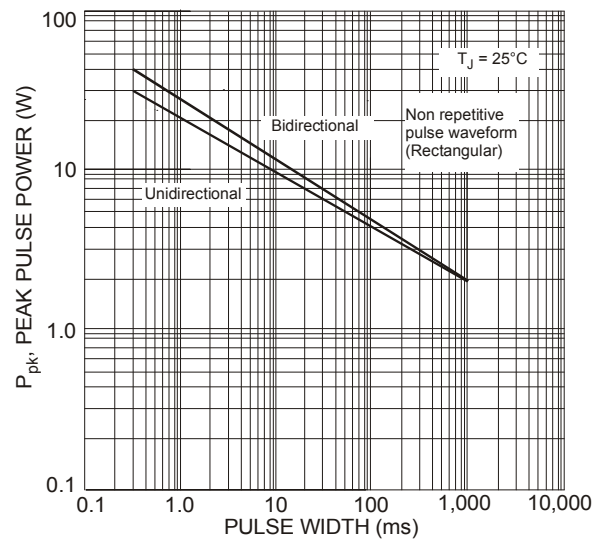

Figure 6 Pulse Rating Curve, P_{pk} (W) vs. Pulse Width (ms)
Power is defined as $P_{pk} = V_C \times I_{pp}$

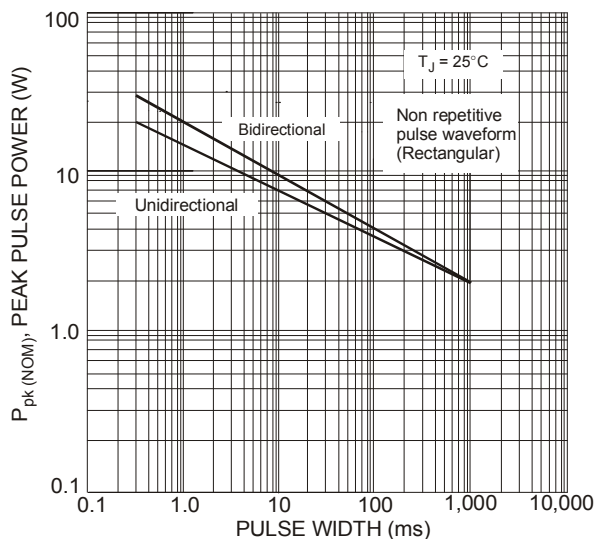
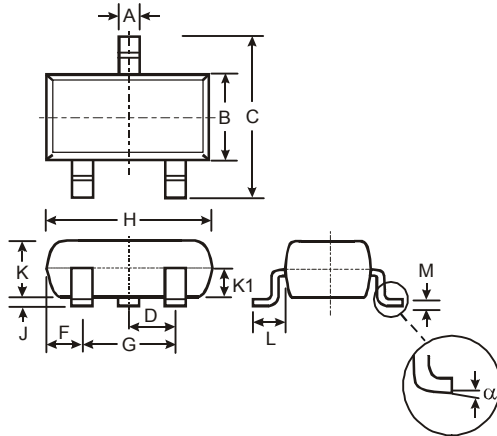

Figure 7 Pulse Rating Curve, $P_{pk(NOM)}$ (W) vs. Pulse Width (ms)

Power is defined as $P_{pk(NOM)} = V_{BR(NOM)} \times I_{pp}$
where $V_{BR(NOM)}$ is the nominal breakdown voltage

Package Outline Dimensions

Please see AP02002 at <http://www.diodes.com/datasheets/ap02002.pdf> for the latest version.



SOT23			
Dim	Min	Max	Typ
A	0.37	0.51	0.40
B	1.20	1.40	1.30
C	2.30	2.50	2.40
D	0.89	1.03	0.915
F	0.45	0.60	0.535
G	1.78	2.05	1.83
H	2.80	3.00	2.90
J	0.013	0.10	0.05
K	0.903	1.10	1.00
K1	-	-	0.400
L	0.45	0.61	0.55
M	0.085	0.18	0.11
α	0°	8°	-
All Dimensions in mm			

Suggested Pad Layout

Please see AP02001 at <http://www.diodes.com/datasheets/ap02001.pdf> for the latest version.

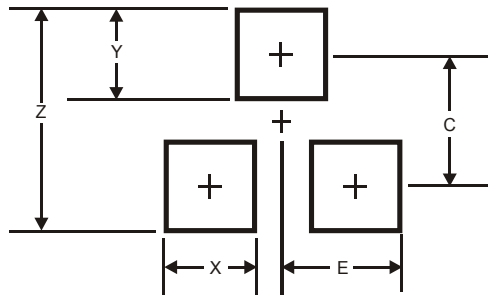

Dimensions	Value (in mm)
Z	2.9
X	0.8
Y	0.9
C	2.0
E	1.35

IMPORTANT NOTICE

DIODES INCORPORATED MAKES NO WARRANTY OF ANY KIND, EXPRESS OR IMPLIED, WITH REGARDS TO THIS DOCUMENT, INCLUDING, BUT NOT LIMITED TO, THE IMPLIED WARRANTIES OF MERCHANTABILITY AND FITNESS FOR A PARTICULAR PURPOSE (AND THEIR EQUIVALENTS UNDER THE LAWS OF ANY JURISDICTION).

Diodes Incorporated and its subsidiaries reserve the right to make modifications, enhancements, improvements, corrections or other changes without further notice to this document and any product described herein. Diodes Incorporated does not assume any liability arising out of the application or use of this document or any product described herein; neither does Diodes Incorporated convey any license under its patent or trademark rights, nor the rights of others. Any Customer or user of this document or products described herein in such applications shall assume all risks of such use and will agree to hold Diodes Incorporated and all the companies whose products are represented on Diodes Incorporated website, harmless against all damages.

Diodes Incorporated does not warrant or accept any liability whatsoever in respect of any products purchased through unauthorized sales channel. Should Customers purchase or use Diodes Incorporated products for any unintended or unauthorized application, Customers shall indemnify and hold Diodes Incorporated and its representatives harmless against all claims, damages, expenses, and attorney fees arising out of, directly or indirectly, any claim of personal injury or death associated with such unintended or unauthorized application.

Products described herein may be covered by one or more United States, international or foreign patents pending. Product names and markings noted herein may also be covered by one or more United States, international or foreign trademarks.

This document is written in English but may be translated into multiple languages for reference. Only the English version of this document is the final and determinative format released by Diodes Incorporated.

LIFE SUPPORT

Diodes Incorporated products are specifically not authorized for use as critical components in life support devices or systems without the express written approval of the Chief Executive Officer of Diodes Incorporated. As used herein:

A. Life support devices or systems are devices or systems which:

1. are intended to implant into the body, or
2. support or sustain life and whose failure to perform when properly used in accordance with instructions for use provided in the labeling can be reasonably expected to result in significant injury to the user.

B. A critical component is any component in a life support device or system whose failure to perform can be reasonably expected to cause the failure of the life support device or to affect its safety or effectiveness.

Customers represent that they have all necessary expertise in the safety and regulatory ramifications of their life support devices or systems, and acknowledge and agree that they are solely responsible for all legal, regulatory and safety-related requirements concerning their products and any use of Diodes Incorporated products in such safety-critical, life support devices or systems, notwithstanding any devices- or systems-related information or support that may be provided by Diodes Incorporated. Further, Customers must fully indemnify Diodes Incorporated and its representatives against any damages arising out of the use of Diodes Incorporated products in such safety-critical, life support devices or systems.

Copyright © 2013, Diodes Incorporated

www.diodes.com