

LOC	DIST	REVISIONS					
GP	00	P	LTN	DESCRIPTION	DATE	DMN	APVD
		D2		ADDED NEW DASH NUMBER -13	02NOV2009	IL	SY
		E		REV PER ECR-09-024231	06NOV2009	IL	SY
		E1		REV PER ECR-09-025057	16NOV2009	IL	SY

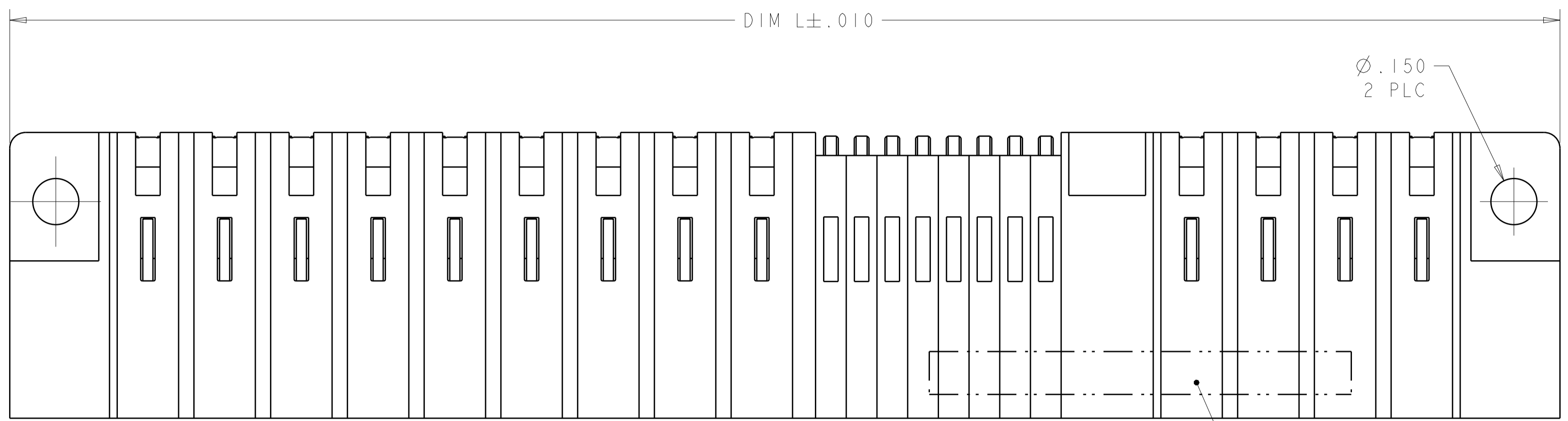

- 1 OPTIONAL CENTER MODULE WITH Ø.150 THRU HOLE OR HOLD DOWN FEATURE.
- 2 "AMP", PART NUMBER, AND DATE CODE TO BE MARKED IN AREA SHOWN.
- 3 MATERIAL: HOUSING - GLASS FILLED HIGH TEMP THERMO PLASTIC, UL94 V-0, BLACK
 SIGNAL CONTACT - COPPER ALLOY
 POWER CONTACT - HIGH CONDUCTIVITY COPPER ALLOY
- 4 CONTACT PLATING: NOBLE METAL PLATING ON CONTACT FUNCTIONAL AREA OF POWER AND SIGNAL CONTACTS
- 5 MECHANICAL CONNECTOR KEEP OUT ZONE.
- 6 DATUM AND BASIC DIMENSIONS ESTABLISHED BY CUSTOMER.
- 7 PCB - ALL HOLE DIAMETERS ARE FINISHED HOLE SIZES.
- 8 PCB - .0453 +/- .0010 DRILLED HOLES PLATES WITH .0003 MIN Sn OVER .001 TO .003 PLATING TO ACHIEVE A .040 DIA. HOLE.
- 9 VARIABLE DIMENSION SHOW ON VIEW (SHEET 4,5).

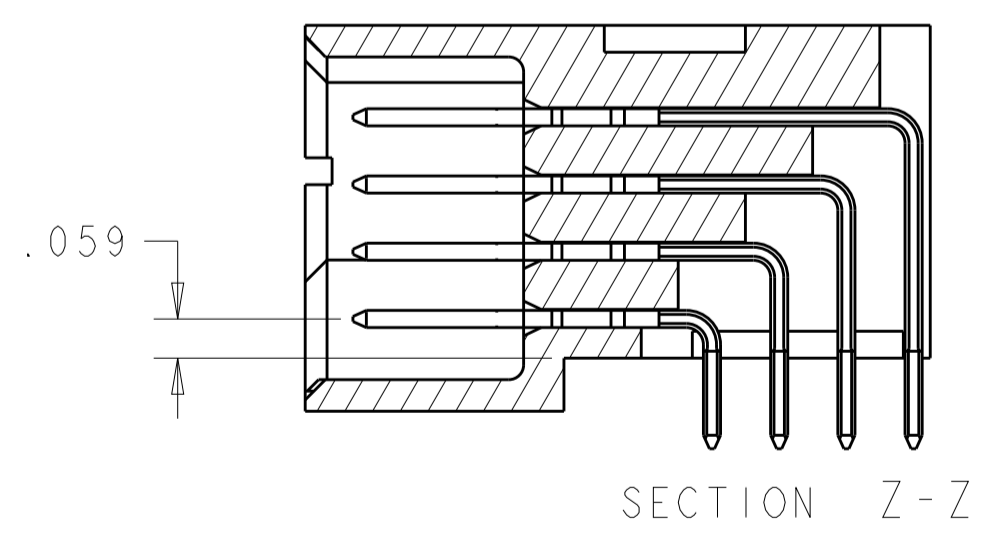
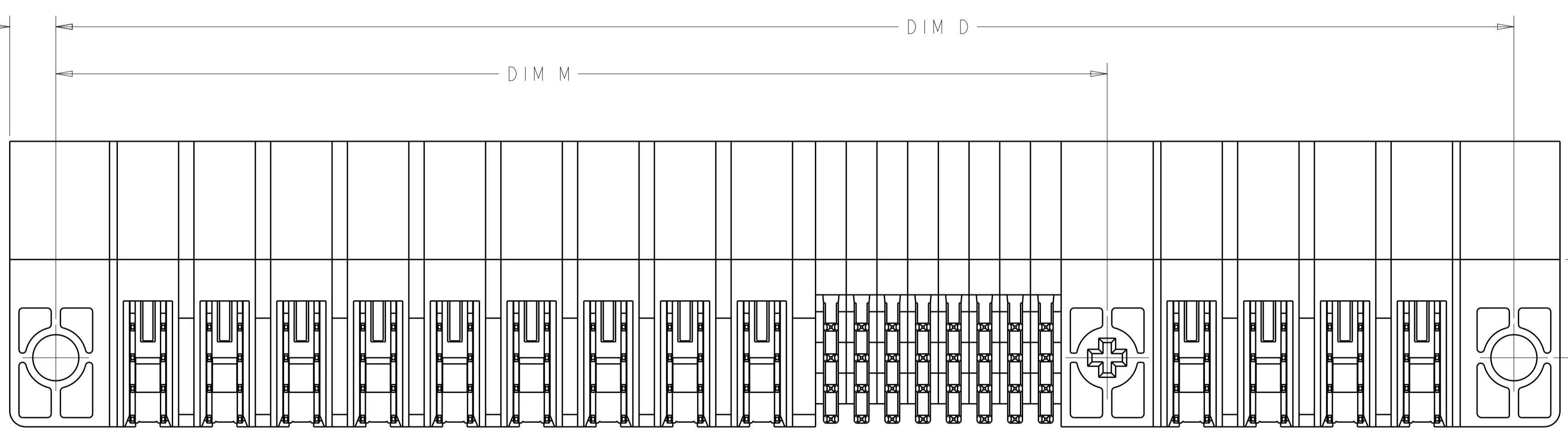
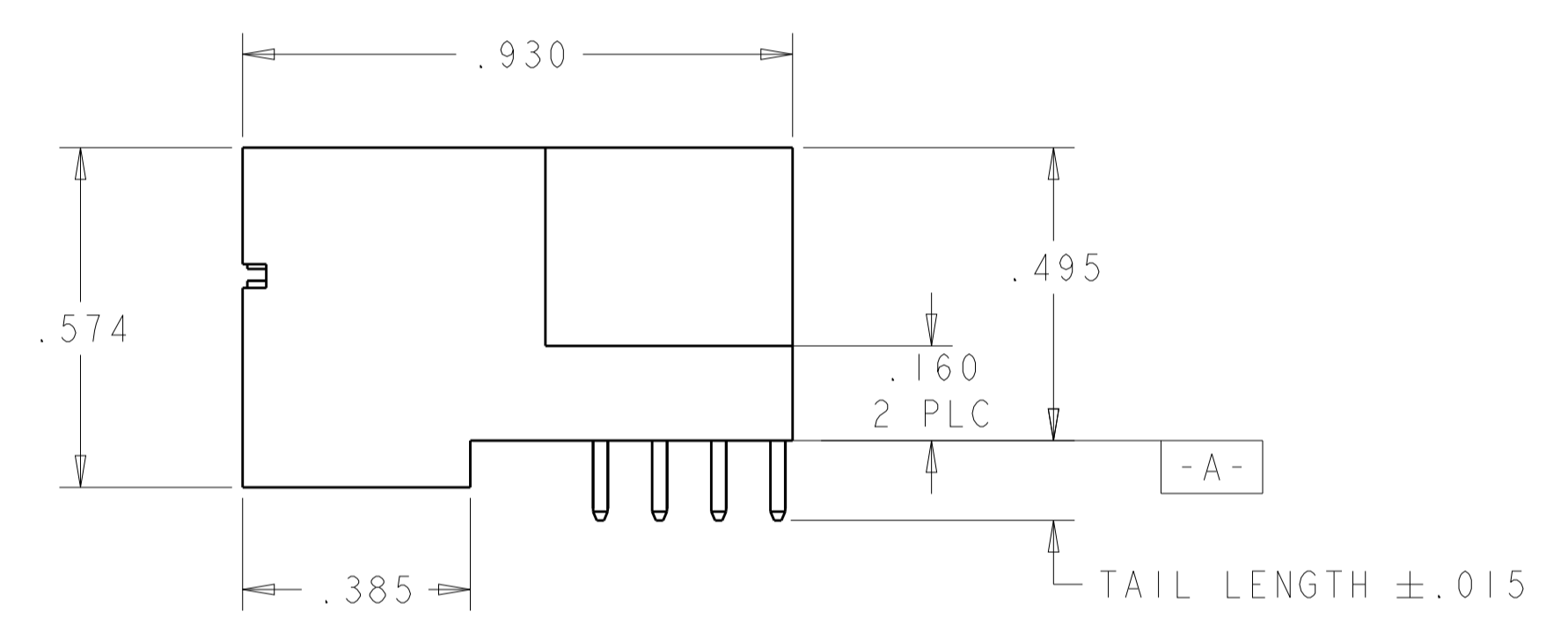
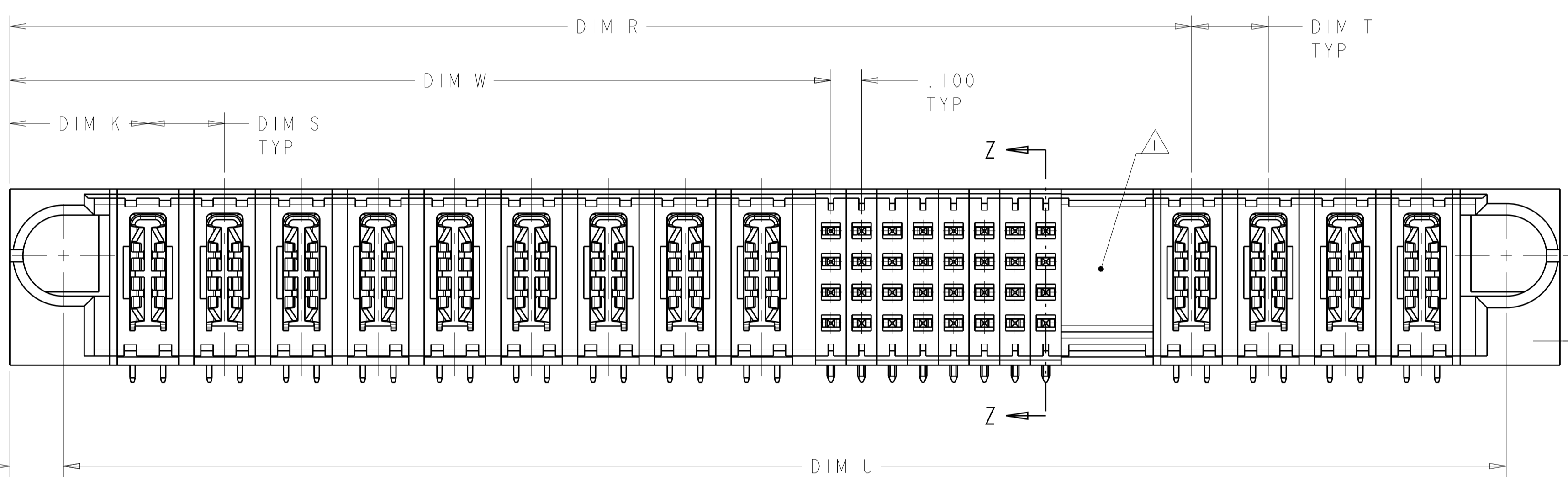

DIMENSIONS: INCHES 		TOLERANCES UNLESS OTHERWISE SPECIFIED: 0 PLC ±. 1 PLC ±.01 2 PLC ±.005 3 PLC ±.002 4 PLC ±.002 ANGLES ±.7° FINISH: 3		DWN: R. GRZYBOWSKI 30MAR05 CHK: M. PERCHERKE 30MAR05 APVD: M. PERCHERKE PRODUCT SPEC: 108-1973 APPLICATION SPEC: 114-13038 WEIGHT: - CUSTOMER DRAWING		Tyco Electronics Corporation Harrisburg, PA 17105-3608 NAME: RIGHT ANGLE HEADER W/GUIDES ASSEMBLY MULTI-BEAM XL SIZE: A1 CAGE CODE: 00779 DRAWING NO: 6450320 SCALE: 4:1 SHEET: 1 of 7 REV: E2	
---------------------------	--	-------------------------------------------------------------------------------------------------------------------------------------------	--	-------------------------------------------------------------------------------------------------------------------------------------------------------------------------	--	------------------------------------------------------------------------------------------------------------------------------------------------------------------------------------------------------------------------	--

THIS DRAWING IS UNPUBLISHED. RELEASED FOR PUBLICATION 20
 © COPYRIGHT 20 BY TYCO ELECTRONICS CORPORATION. ALL RIGHTS RESERVED.

LOC	DIST	REVISIONS			
P	LTN	DESCRIPTION	DATE	DMN	APVD
-	-	SEE SHEET 1	-	-	-

①2

3.700	.250	.250	2.850	1.375	3.750	-	4.050	.450	4P + 56S + 4P	1-6450320-3
2.400	.200	.200	2.100	0.825	2.450	-	2.750	.450	2P + 48S + 2P	1-6450320-2
2.900	.250	.250	2.050	1.375	2.950	-	3.250	.450	4P + 24S + 4P	1-6450320-1
5.500	.300	△	3.175	2.525	5.550	-	5.850	.475	7ACP + 20S + 4ACP + 5P	1-6450320-0
2.300	.250	.250	1.700	1.175	2.350	-	2.650	.450	3P + 16S + 3P	6450320-9
2.750	△	.200	1.450	1.175	2.800	-	3.100	.450	2P + 1ACP + 8S + 7HDP	6450320-8
4.500	.250	.250	2.900	2.125	4.550	-	4.850	.450	7P + 28S + 7P	6450320-5
4.250	.250	.250	2.650	1.875	4.300	-	4.600	.450	6P + 28S + 7P	6450320-4
2.500	.250	.300	1.800	1.125	2.550	-	2.850	.450	3P + 24S + 3ACP	6450320-2
1.900	.250	.250	1.550	0.875	1.950	-	2.250	.450	2P + 24S + 2P	6450320-1
DIM U	S	T	R	W	D	M	L	K	DESCRIPTION	PART NUMBER

<small>THIS DRAWING IS UNPUBLISHED. RELEASED FOR PUBLICATION 20 © COPYRIGHT 20 BY TYCO ELECTRONICS CORPORATION. ALL RIGHTS RESERVED.</small>		DWN R. GRZYBOWSKI 30MAR05 CHK M. PERCHERKE 30MAR05	 Tyco Electronics Corporation Harrisburg, PA 17105-3608
DIMENSIONS: INCHES	TOLERANCES UNLESS OTHERWISE SPECIFIED: 0 PLC ±. 1 PLC ±.01 2 PLC ±.01 3 PLC ±.005 4 PLC ±.0020 ANGLES ±.020	APVD M. PERCHERKE NAME PRODUCT SPEC 108-1973 APPLICATION SPEC 114-13038	SIZE CAGE CODE DRAWING NO RESTRICTED TO A1 00779 C=6450320 -
MATERIAL	FINISH	WEIGHT	SCALE 4:1 SHEET 2 OF 7 REV E2
CUSTOMER DRAWING			

LOC	DIST	REV	DATE	BY	APPV
GP	00				
P LTH		DESCRIPTION		DATE	OWN
		SEE SHEET 1			

PART NUMBER	ROWS	POWER		SIGNAL						POWER			
		P1	P2	1	2	3	4	5	6	P3	P4		
6450320-1	D C B A	PM	PM	J	J	J	J	J	J	PM	PM		
				K	K	K	K	K	K				
				N	N	N	N	N	N				
				S	S	S	S	S	S				
2P + 24S + 2P													

PART NUMBER	ROWS	POWER						SIGNAL							POWER									
		P1	P2	P3	P4	P5	P6	1	2	3	4	5	6	7	P7	P8	P9	P10	P11	P12	P13			
6450320-4	D C B A	PM	PM	PM	PM	PM	PM	J	J	J	J	J	J	PM	PM	PM	PM	PM	PM	PM	PM	PM	PM	PM
								K	K	K	K	K	K											
								N	N	N	N	N	N											
		S	S	S	S	S	S																	
6P + 28S + 7P																								

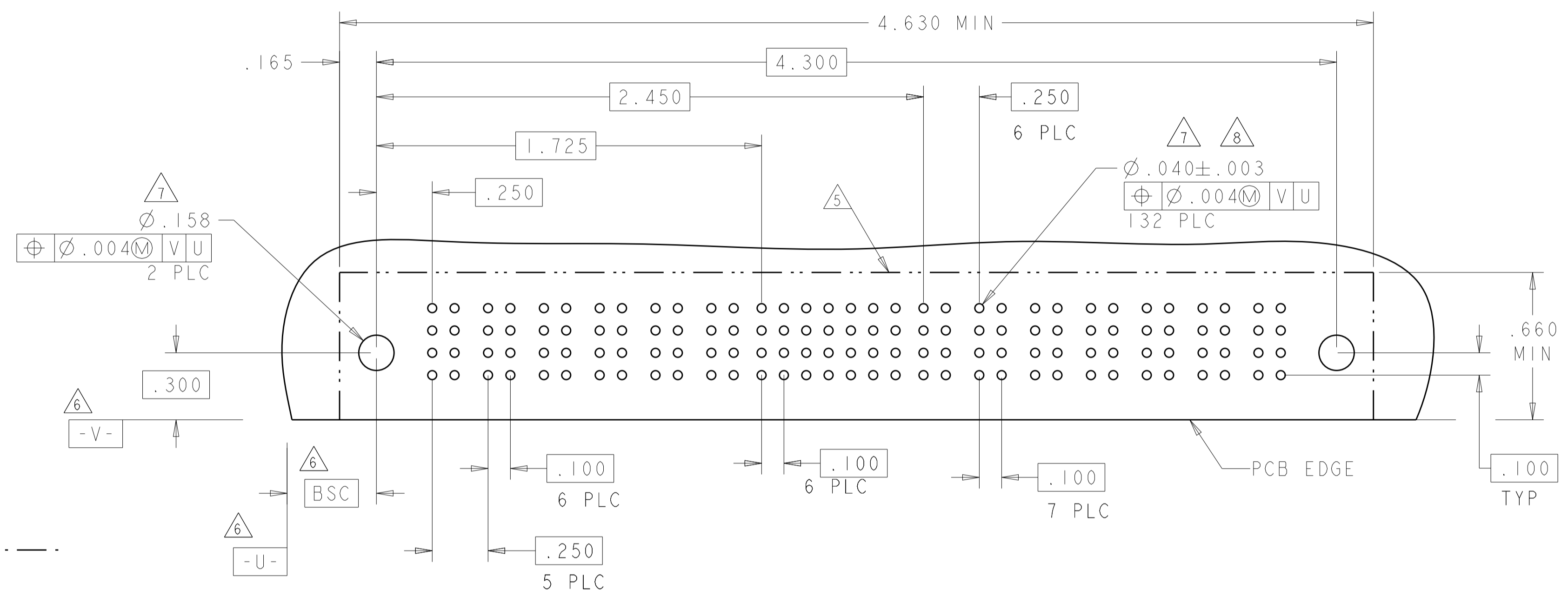
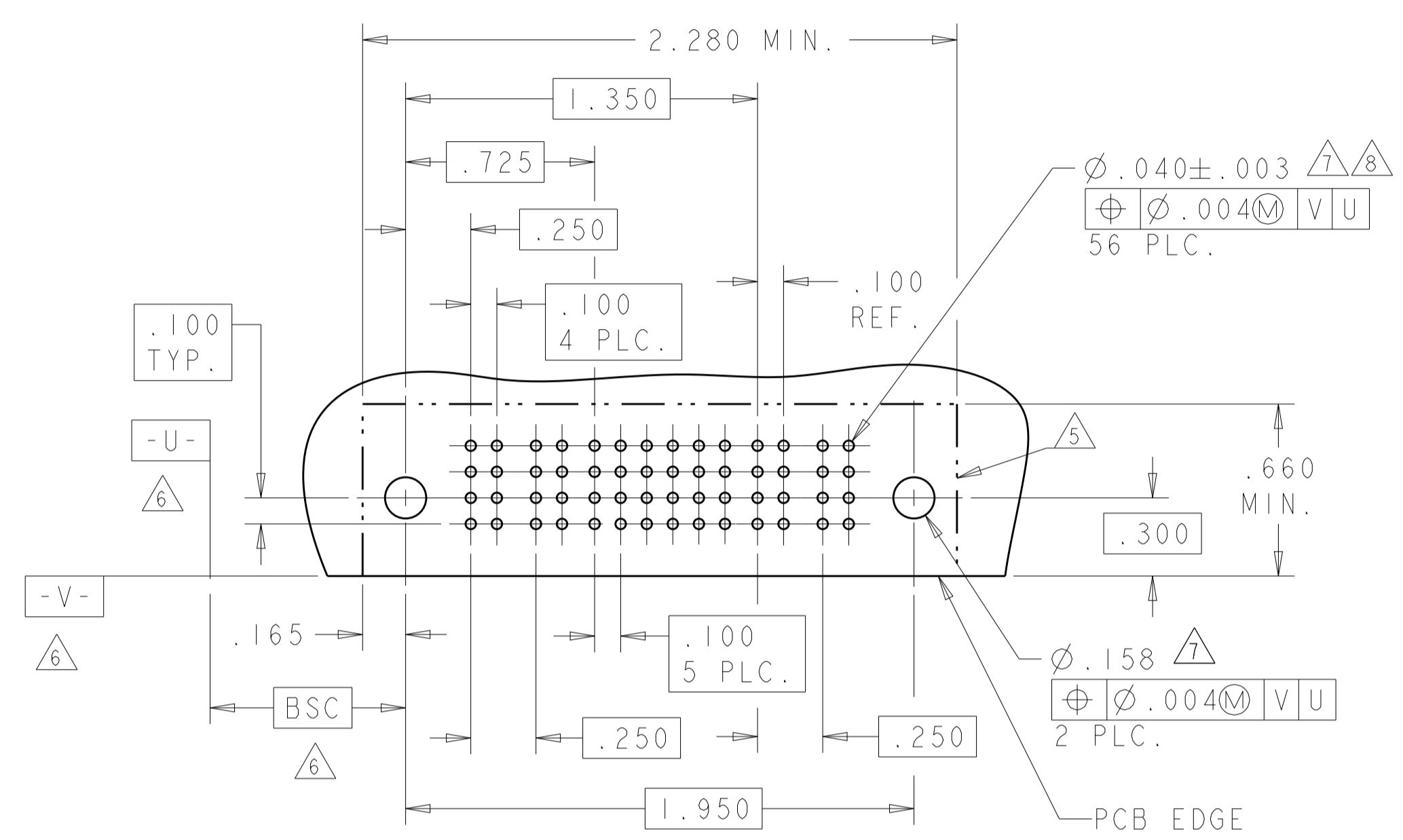

PART NUMBER	ROWS	POWER			SIGNAL						POWER		
		P1	P2	P3	1	2	3	4	5	6	P4	P5	P6
6450320-2	D C B A	PM	PM	PM	J	J	J	J	J	J	PM	PM	PM
					K	K	K	K	K	K			
					N	N	N	N	N	N			
				S	S	S	S	S	S				
3P + 24S + 3ACP													

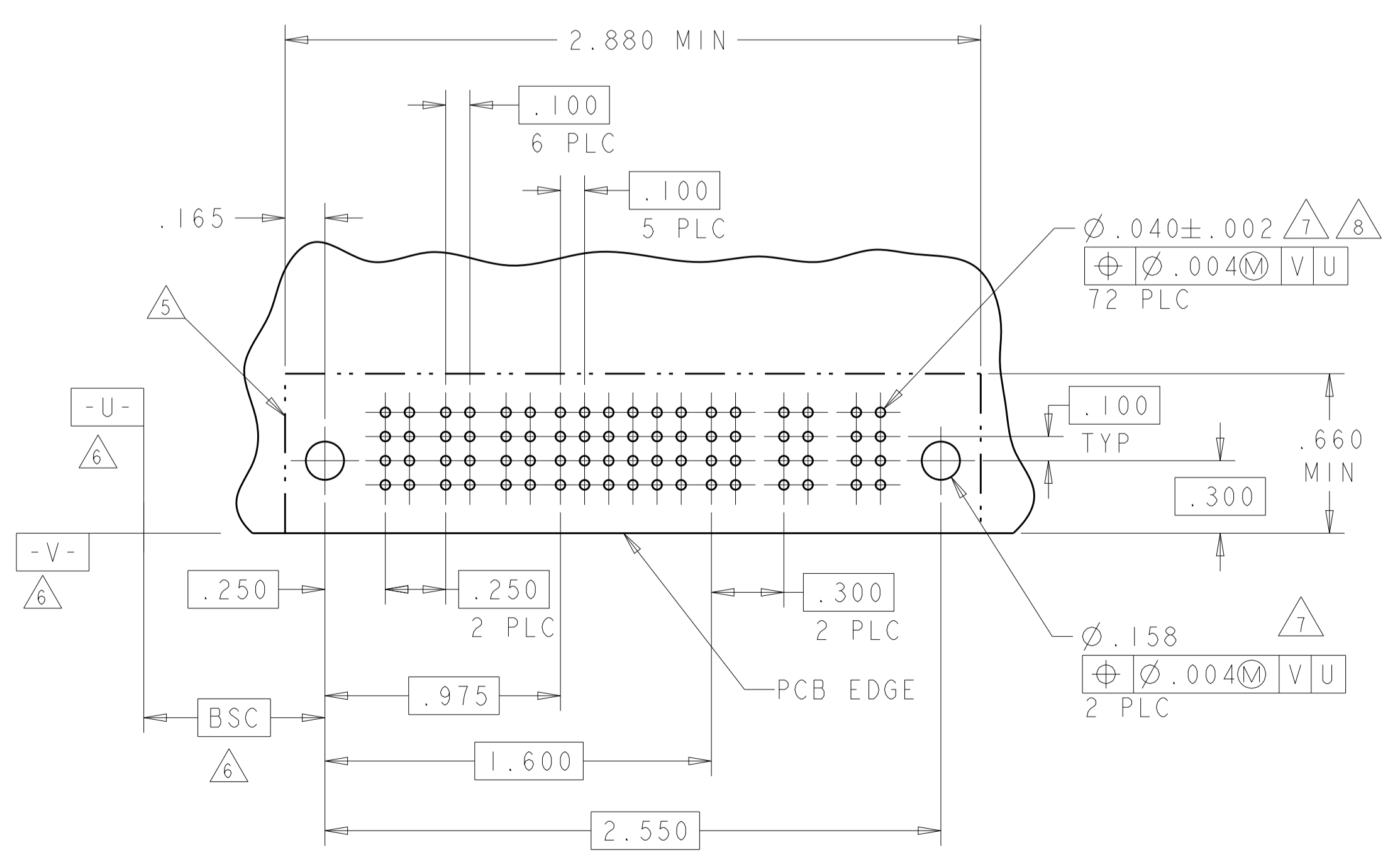

CODE	MATING SEQUENCE	TAIL LENGTH	ROW
Z	STD	.090	D
Y	STD	.090	C
R	STD	.090	B
O	STD	.090	A
J	STD	.135	D
K	STD	.135	C
N	STD	.135	B
S	STD	.135	A

DIMENSIONS:		TOLERANCES UNLESS OTHERWISE SPECIFIED:	
INCHES		0 PLC	±.01
		1 PLC	±.01
		2 PLC	±.01
		3 PLC	±.005
		4 PLC	±.002
		ANGLES	±.020
MATERIAL		FINISH	

PA	.090
PM	.135
CODE	TAIL LENGTH
POWER CONTACT	

OWN	R. GRZYBOWSKI	30MAR05	
CHK	M. PERCHERKE	30MAR05	
APPV			
NAME	RIGHT ANGLE HEADER W/GUIDES ASSEMBLY MULTI-BEAM XL		
PRODUCT SPEC	108-1973		
APPLICATION SPEC	114-13038		
SIZE	CAGE CODE	DRAWING NO	RESTRICTED TO
A1	00779	6450320	
CUSTOMER DRAWING		SCALE	4:1
		SHEET	3 of 7
		REV	E2

LOC	DIST	REVISIONS		
GP	00	P	LTN	DATE
		-	SEE SHEET 1	-

PART NUMBER	ROWS	POWER						SIGNAL							POWER						
		P1	P2	P3	P4	P5	P6	P7	1	2	3	4	5	6	7	P8	P9	P10	P11	P12	P13
6450320-5	D C B A	PM	PM	PM	PM	PM	PM	J	J	J	J	J	J	J	PM	PM	PM	PM	PM	PM	PM
								K	K	K	K	K	K								
								N	N	N	N	N	N								
								S	S	S	S	S	S								

7P + 28S + 7P

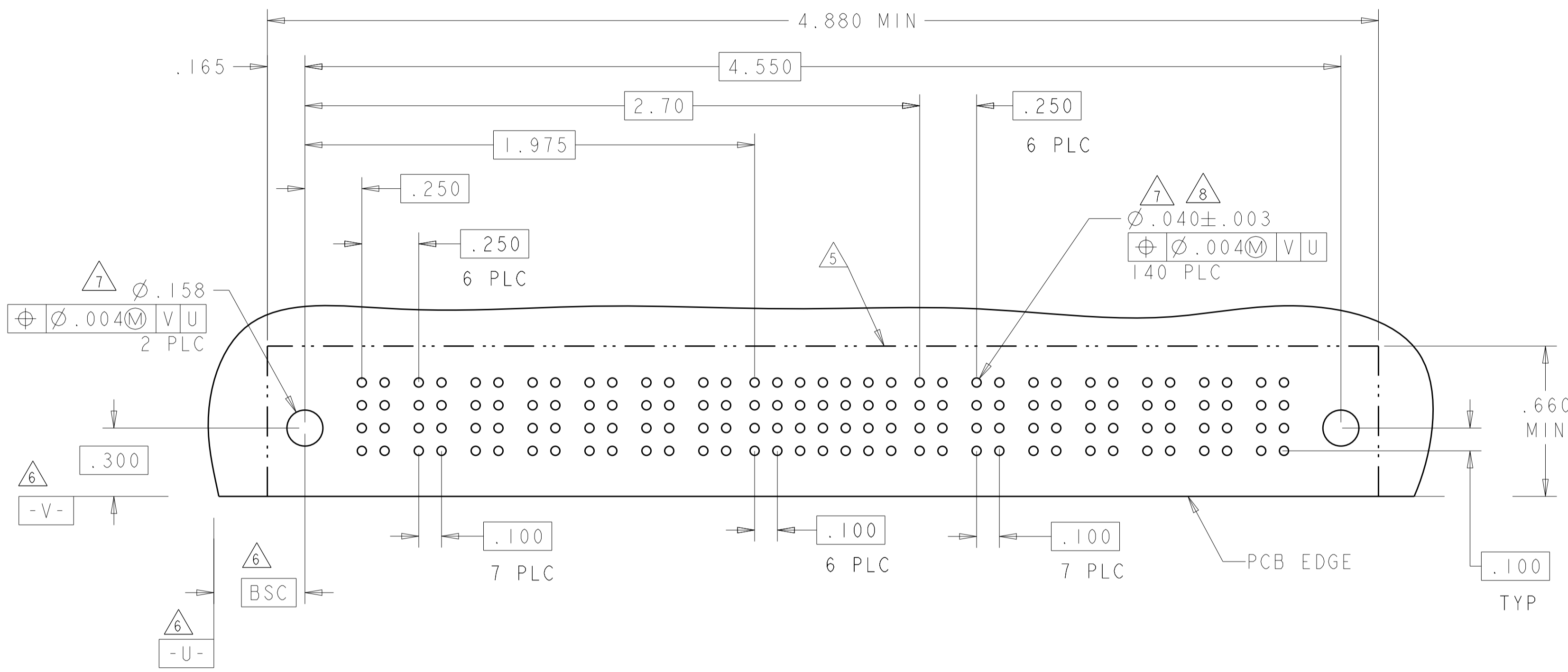

PART NUMBER	ROWS	POWER			SIGNAL		POWER									
		P1	P2	P3	1	2	P4	P5	P6	P7	P8	P9	P10			
6450320-8	D C B A	PM	PM	PM	J	J	PM	PM	PM	PM	PM	PM	PM			
					K	K										
					N	N										
					S	S										

2P+1ACP+8S+7HDP

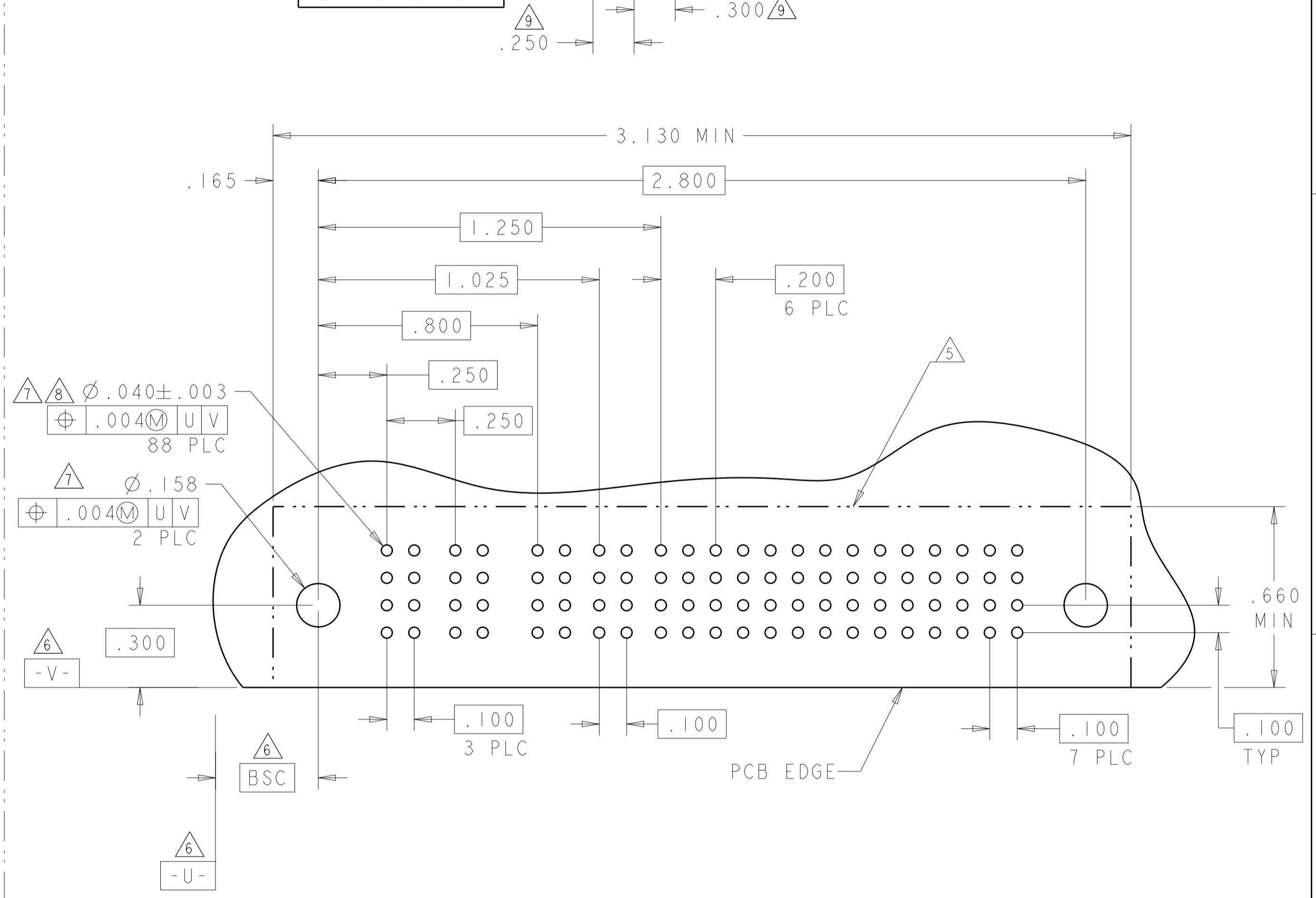

PART NUMBER	ROWS	POWER			SIGNAL				POWER		
		P1	P2	P3	1	2	3	4	P4	P5	P6
6450320-9	D C B A	PM	PM	PM	J	J	J	J	PM	PM	PM
					K	K	K	K			
					N	N	N	N			
					S	S	S	S			

3P + 16S + 3P

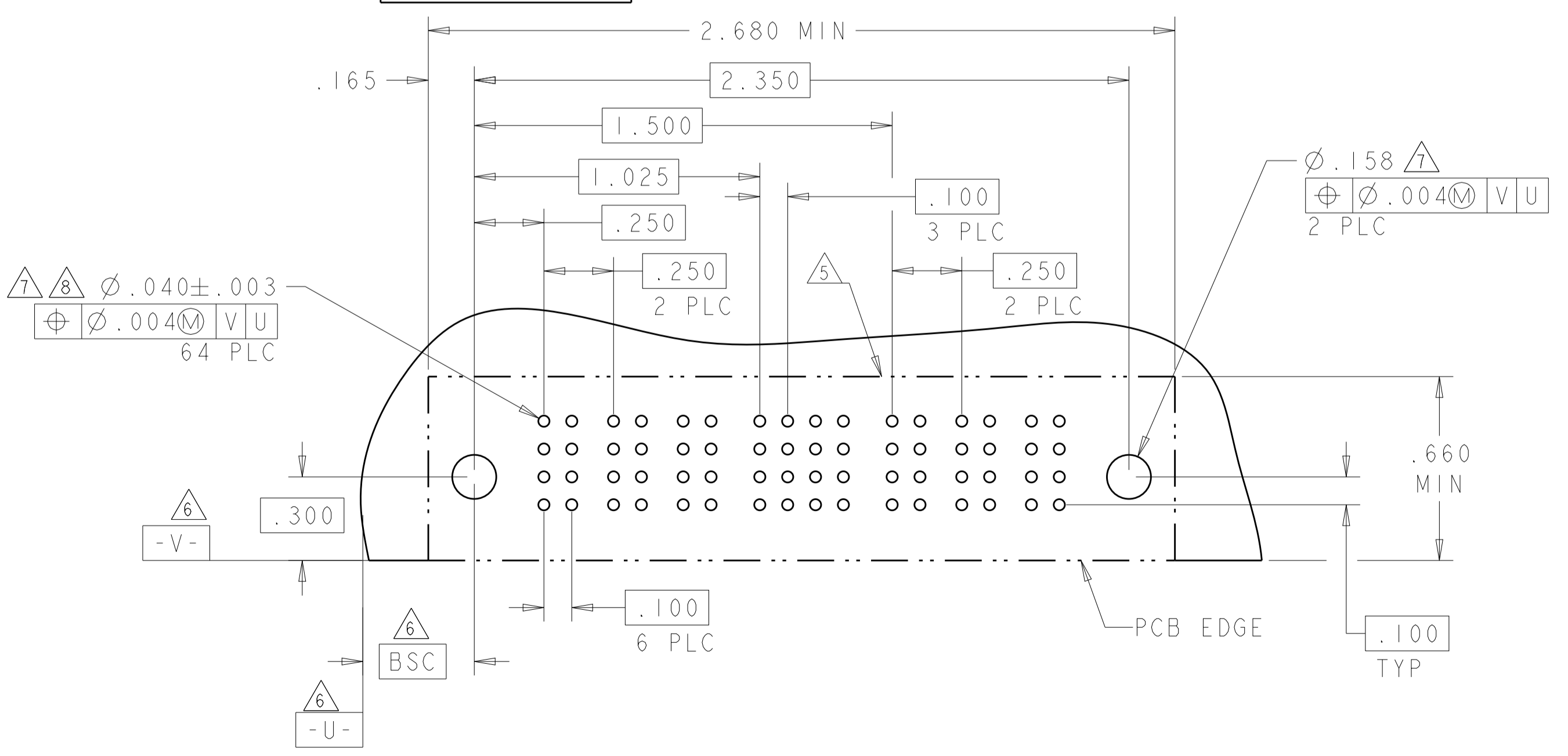

DIMENSIONS: INCHES 		TOLERANCES UNLESS OTHERWISE SPECIFIED: 0 PLC ±. 1 PLC ±.01 2 PLC ±.01 3 PLC ±.005 4 PLC ±.002 ANGLES ±.020		DWN: R. GRZYBOWSKI 30MAR05 CHK: M. PERCHERKE 30MAR05 APVD: M. PERCHERKE PRODUCT SPEC 108-1973 APPLICATION SPEC 114-13038 WEIGHT CUSTOMER DRAWING		Tyco Electronics Corporation Harrisburg, PA 17105-3608 NAME: RIGHT ANGLE HEADER W/GUIDES ASSEMBLY MULTI-BEAM XL SIZE: A1 CAGE CODE: 00779 DRAWING NO: 6450320 SCALE: 4:1 SHEET: 4 OF 7 REV: E2	
---------------------------	--	------------------------------------------------------------------------------------------------------------------------------	--	--------------------------------------------------------------------------------------------------------------------------------------------------------------------------	--	------------------------------------------------------------------------------------------------------------------------------------------------------------------------------------------------------------------------	--

LOC		DIST		REVISONS			
GP	00	P	LTN	DESCRIPTION	DATE	DWN	APVD
		-		SEE SHEET 1			

PART NUMBER	ROWS	POWER						SIGNAL					POWER								
		P1	P2	P3	P4	P5	P6	P7	1	2	3	4	5	P8	P9	P10	P11	P12	P13	P14	P15
I-6450320-0	D	PM	PM	PM	PM	PM	PM	J	J	J	J	J	PM	PM	PM	PM	PM	PM	PM	PM	
	C	PM	PM	PM	PM	PM	PM	K	K	K	K	K	PM	PM	PM	PM	PM	PM	PM	PM	
	B	PM	PM	PM	PM	PM	PM	N	N	N	N	N	PM	PM	PM	PM	PM	PM	PM	PM	
	A	PM	PM	PM	PM	PM	PM	S	S	S	S	S	PM	PM	PM	PM	PM	PM	PM	PM	
7ACP+20S+4ACP+5P																					

NO CONTACT LOADED

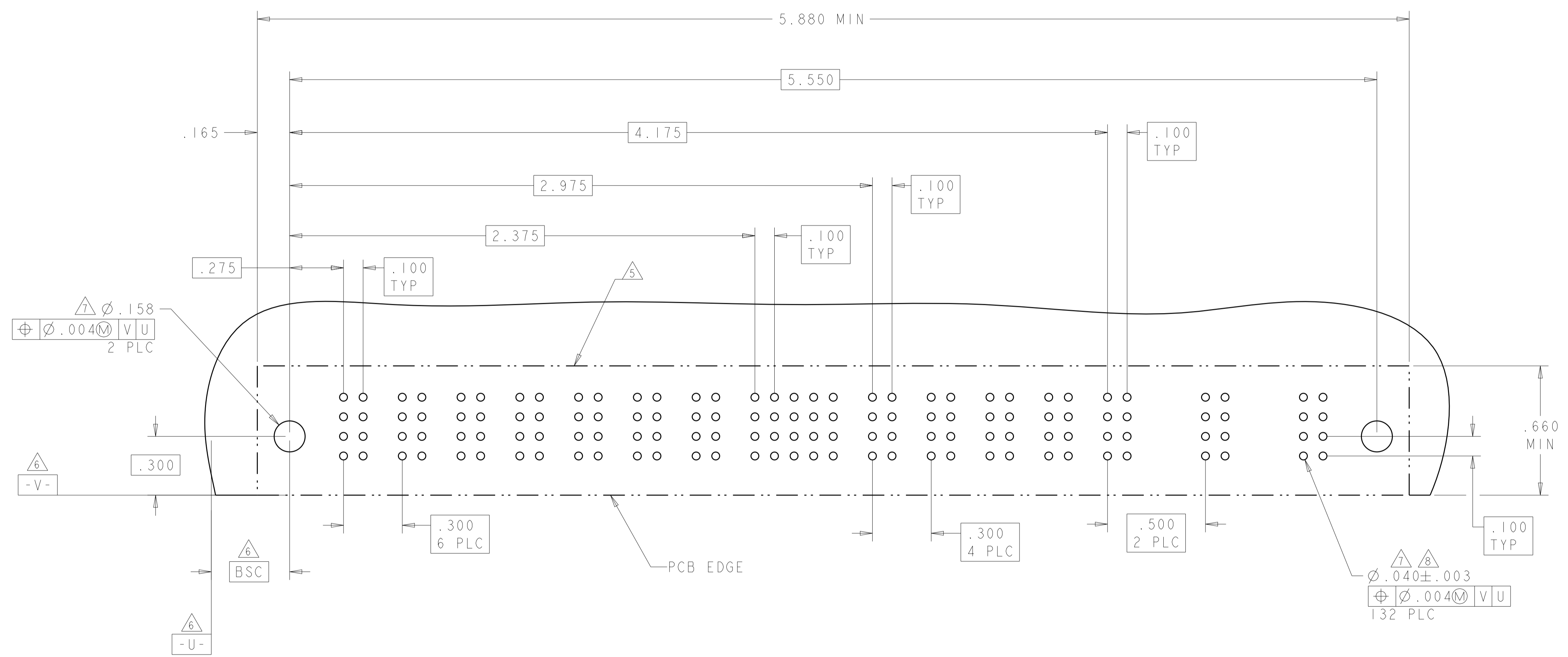
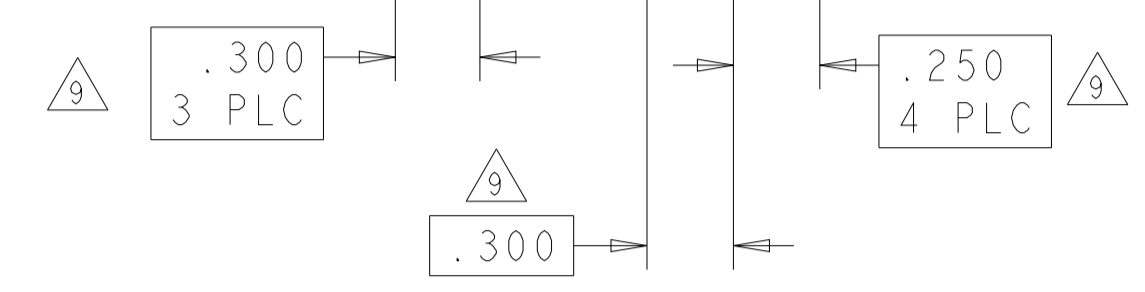

<small>THIS DRAWING IS UNPUBLISHED. RELEASED FOR PUBLICATION BY TYCO ELECTRONICS CORPORATION. ALL RIGHTS RESERVED.</small>		DWN: R. GRZYBOWSKI 30MAR05 CHK: M. PERCHERKE 30MAR05	Tyco Electronics Corporation Harrisburg, PA 17105-3608
DIMENSIONS: INCHES	TOLERANCES UNLESS OTHERWISE SPECIFIED: 0 PLC ±. 1 PLC ±.01 2 PLC ±.01 3 PLC ±.005 4 PLC ±.0020 ANGLES ±.7° FINISH	NAME: RIGHT ANGLE HEADER W/GUIDES ASSEMBLY PRODUCT SPEC: 108-1973 APPLICATION SPEC: 114-13038 WEIGHT:	SIZE: A1 CAGE CODE: 00779 DRAWING NO: 6450320 RESTRICTED TO:
MATERIAL:	FINISH:	SCALE: 4:1	SHEET 5 OF 7 REV E2

LOC	DIST	REVISIONS					
GP	00	P	LTN	DESCRIPTION	DATE	DMN	APVD
		-		SEE SHEET 1			

PART NUMBER	ROWS	POWER				SIGNAL						POWER			
		P1	P2	P3	P4	1	2	3	4	5	6	P5	P6	P7	P8
I-6450320-1	D	PM	PM	PM	PM	J	J	J	J	J	J	PM	PM	PM	PM
	C					K	K	K	K	K	K				
	B					N	N	N	N	N	N				
	A					S	S	S	S	S	S				
4P + 24S + 4P															

PART NUMBER	ROWS	POWER		SIGNAL												POWER		
		P1	P2	1	2	3	4	5	6	7	8	9	10	11	12	P3	P4	
I-6450320-2	D	PM	PM	J	J	J	J	J	J	J	J	J	J	J	J	J	PM	PM
	C			K	K	K	K	K	K	K	K	K	K	K	K			
	B			N	N	N	N	N	N	N	N	N	N	N	N	N		
	A			S	S	S	S	S	S	S	S	S	S	S	S	S		
2P + 48S + 2P																		

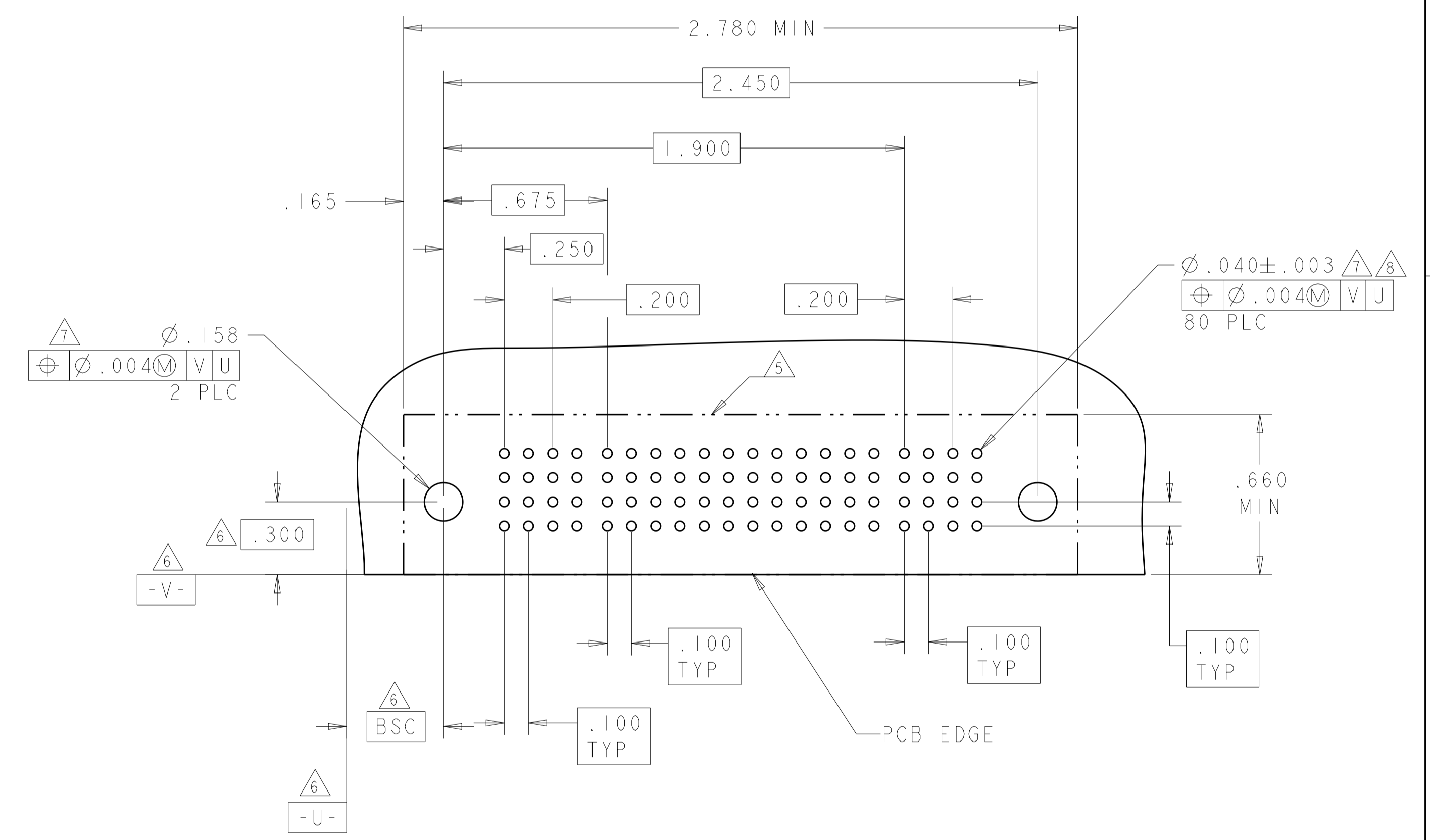
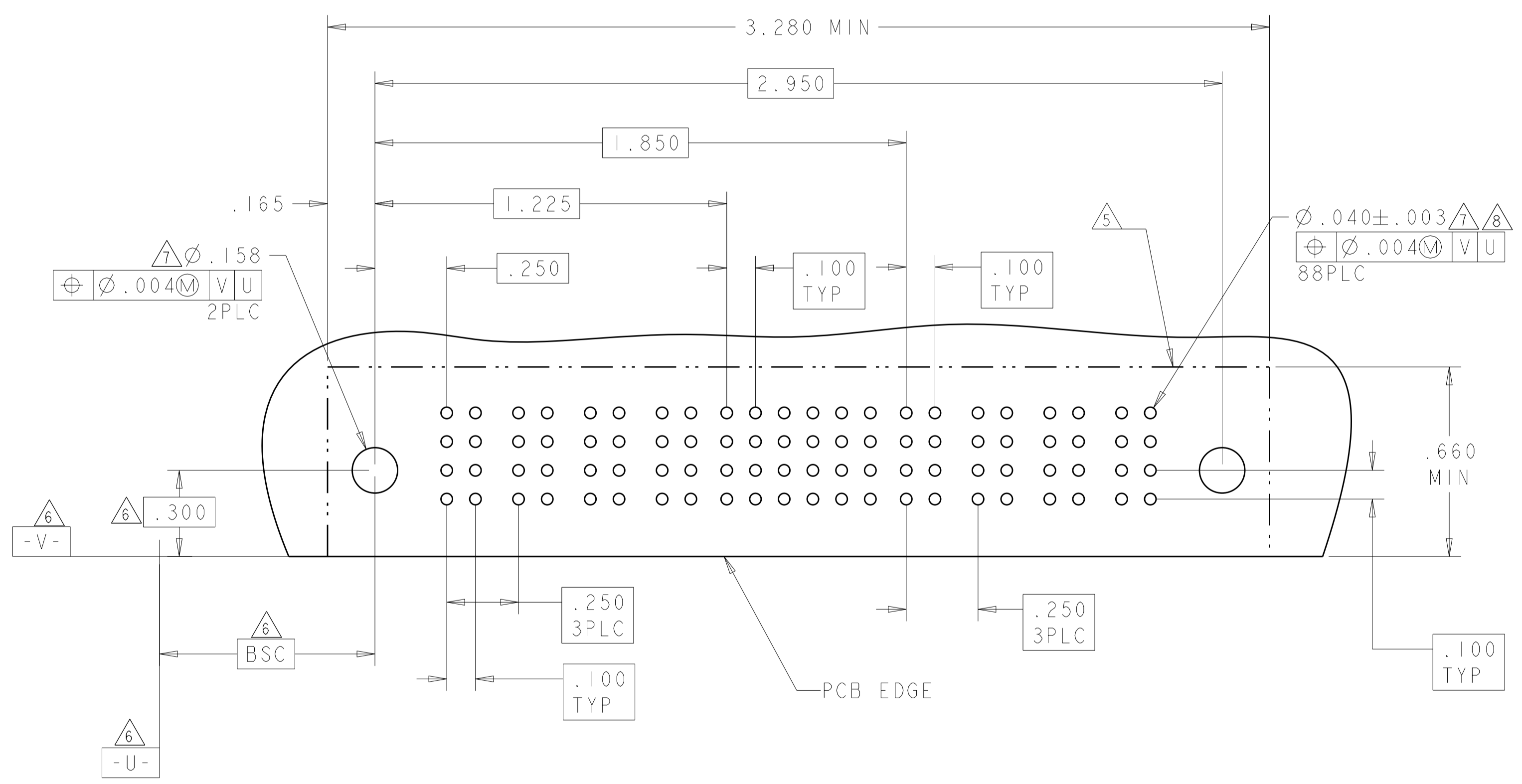

DIMENSIONS: INCHES 		TOLERANCES UNLESS OTHERWISE SPECIFIED: 0 PLC ±. 1 PLC ±.01 2 PLC ±.01 3 PLC ±.005 4 PLC ±.0020 ANGLES ±.2° FINISH		DWN: R. GRZYBOWSKI 30MAR05 CHK: M. PERCHERKE 30MAR05 APVD: M. PERCHERKE PRODUCT SPEC: 108-1973 APPLICATION SPEC: 114-13038 WEIGHT:		Tyco Electronics Corporation Harrisburg, PA 17105-3608 NAME: RIGHT ANGLE HEADER W/GUIDES ASSEMBLY MULTI-BEAM XL SIZE: A1 CAGE CODE: 00779 DRAWING NO: 6450320 SCALE: 4:1 SHEET: 6 OF 7 REV: E2	
MATERIAL:		FINISH:		CUSTOMER DRAWING		RESTRICTED TO:	

LOC	DIST	REVISIONS			
P	LTN	DESCRIPTION	DATE	DMN	APVD
-	-	SEE SHEET 1	-	-	-

PART NUMBER	ROWS	POWER				SIGNAL														POWER					
		P1	P2	P3	P4	1	2	3	4	5	6	7	8	9	10	11	12	13	14	P5	P6	P7	P8		
I-6450320-3	D	PM	PM	PM	PM	J	J	J	J	J	J	J	J	J	J	J	J	J	J	J	PM	PM	PM	PM	
	C					K	K	K	K	K	K	K	K	K	K	K	K	K	K	K					
	B					N	N	N	N	N	N	N	N	N	N	N	N	N	N	N					N
	A					S	S	S	S	S	S	S	S	S	S	S	S	S	S	S					S
4P + 56S + 4P																									

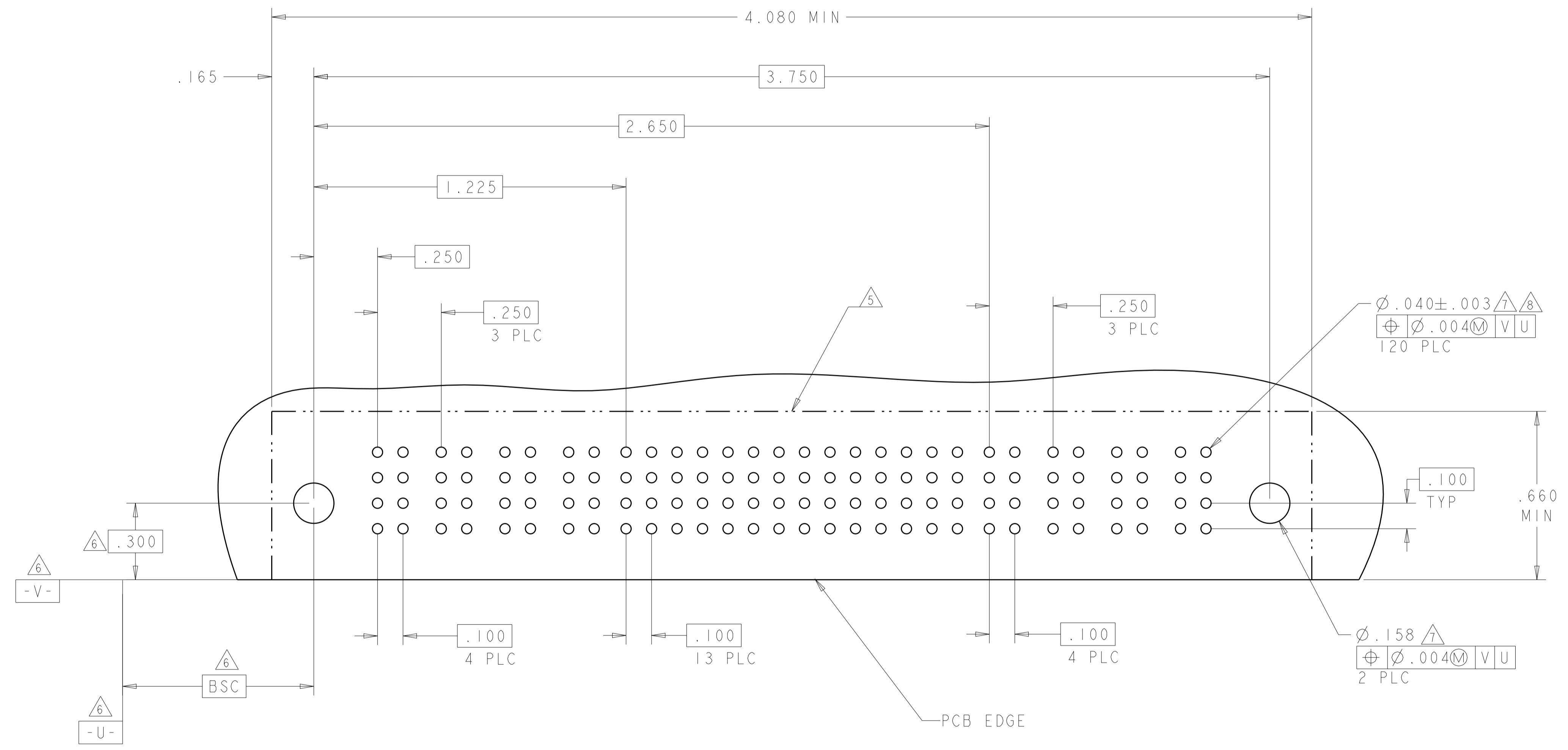

<small>THIS DRAWING IS UNPUBLISHED. RELEASED FOR PUBLICATION 20. IT IS THE PROPERTY OF TYCO ELECTRONICS CORPORATION. IT IS SUBJECT TO CHANGE AND WITHOUT WARRANTY OF MERCHANTABILITY. REVISIONS SHOULD BE CONTACTED FOR THE LATEST REVISION.</small>		DWN: B. GRZYBOWSKI / 30MAR05 CHK: M. PERCHERKE / 30MAR05 APVD: M. PERCHERKE	Tyco Electronics Corporation Harrisburg, PA 17105-3608
DIMENSIONS: INCHES	TOLERANCES UNLESS OTHERWISE SPECIFIED: 0 PLC ±. 1 PLC ±.01 2 PLC ±.01 3 PLC ±.005 4 PLC ±.0020 ANGLES ±.2°	NAME: RIGHT ANGLE HEADER W/GUIDES ASSEMBLY PRODUCT SPEC: 108-1973 APPLICATION SPEC: 114-13038 WEIGHT: -	SIZE: A1 CAGE CODE: 00779 DRAWING NO: 6450320 RESTRICTED TO: -
MATERIAL: -	FINISH: -	CUSTOMER DRAWING	SCALE: 4:1 SHEET 7 OF 7 REV: E2