

1 DB LSB GAAS MMIC 5-BIT DIGITAL ATTENUATOR, 0.7 - 3.8 GHz

Typical Applications

The HMC273AMS10G(E) is ideal for:

- Cellular; UMTS/3G Infrastructure
- ISM, MMDS, WLAN, WiMAX
- Microwave Radio & VSAT
- Test Equipment and Sensors

Features

- RoHs Compliant Product
- 1 dB LSB Steps to 31 dB
- Single Positive Control Per BIT
- ±0.2 dB Typical Bit Error
- Miniature MSOP 10 Package: 14.8mm²
- Included in the HMC-DK004 Designer's Kit

Functional Diagram

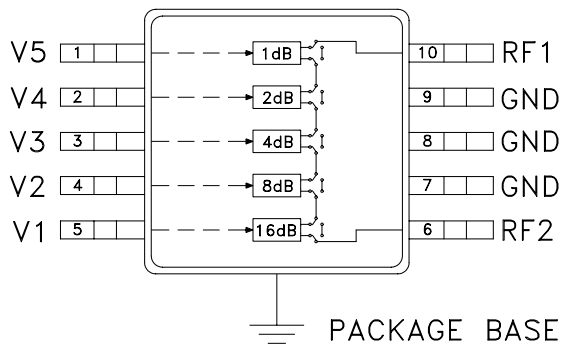

General Description

The HMC273AMS10G(E) is a general purpose broadband 5-Bit positive control GaAs IC digital attenuator in a 10 lead MSOP plastic package. Covering 0.7 to 3.8 GHz, the insertion loss is typically less than 3 dB. The attenuator bit values are 1 (LSB), 2, 4, 8, and 16 dB for a total attenuation of 31 dB. Accuracy is excellent at ±0.2 dB typical with an IIP3 of up to +46 dBm. Five bit control voltage inputs, toggled between 0 and +3 to +5 volts, are used to select each attenuation state. A single Vdd bias of +3 to +5 volts applied through an external 5K Ohm resistor is required.

Electrical Specifications,

$T_A = +25^\circ\text{C}$, $V_{dd} = +3\text{V to } +5\text{V}$ & $V_{ctl} = 0/V_{dd}$ (Unless Otherwise Stated)

Parameter	Frequency	Min.	Typical	Max.	Units
Insertion Loss	0.7 - 1.4 GHz		1.8	2.4	dB
	1.4 - 2.3 GHz		2.3	2.9	dB
	2.3 - 2.7 GHz		2.5	3.1	dB
	2.7 - 3.8 GHz		2.9	3.5	dB
Attenuation Range	0.7 - 3.8 GHz		31		dB
Return Loss (RF1 & RF2, All Atten. States)	0.7 - 1.4 GHz	10	14		dB
	1.4 - 2.7 GHz	11	15		dB
	2.7 - 3.8 GHz	12	16		dB
Attenuation Accuracy: (Referenced to Insertion Loss) All Attenuation States All Attenuation States All Attenuation States All Attenuation States	0.7 - 1.4 GHz	± (0.30 + 3% of Atten. Setting) Max			dB
	1.4 - 2.2 GHz	± (0.30 + 4% of Atten. Setting) Max			dB
	2.2 - 2.7 GHz	± (0.40 + 5% of Atten. Setting) Max			dB
	2.7 - 3.8 GHz	± (0.50 + 5% of Atten. Setting) Max			dB
Input Power for 0.1 dB Compression	0.7 - 3.8 GHz	Vdd = 5V	28		dBm
		Vdd = 3V	26		dBm
Input Third Order Intercept Point (Two-tone Input Power = 0 dBm Each Tone)	0.7 - 3.8 GHz	Vdd = 5V	46		dBm
		Vdd = 3V	45		dBm
Switching Characteristics tRISE, tFALL (10/90% RF) tON, tOFF (50% CTL to 10/90% RF)	0.7 - 3.8 GHz		1250		ns
			1300		ns

HMC273A* PRODUCT PAGE QUICK LINKS

Last Content Update: 02/23/2017

COMPARABLE PARTS

View a parametric search of comparable parts.

EVALUATION KITS

- HMC273A Evaluation Board

DOCUMENTATION

Data Sheet

- HMC273AMS10GE: 1 dB LSB GaAs MMIC 5-Bit Digital Attenuator, 0.7 to 3.8 GHz Data Sheet

TOOLS AND SIMULATIONS

- HMC273AMS10GE IBIS Model

DESIGN RESOURCES

- HMC273A Material Declaration
- PCN-PDN Information
- Quality And Reliability
- Symbols and Footprints

DISCUSSIONS

View all HMC273A EngineerZone Discussions.

SAMPLE AND BUY

Visit the product page to see pricing options.

TECHNICAL SUPPORT

Submit a technical question or find your regional support number.

DOCUMENT FEEDBACK

Submit feedback for this data sheet.

1 DB LSB GAAS MMIC 5-BIT DIGITAL ATTENUATOR, 0.7 - 3.8 GHz

Insertion Loss vs. Temperature

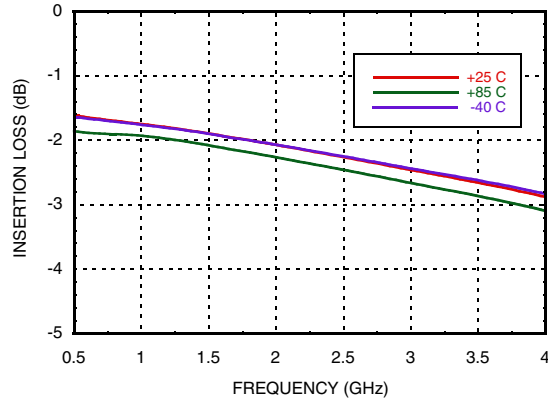

Return Loss RF1, RF2
(Only Major States are Shown)

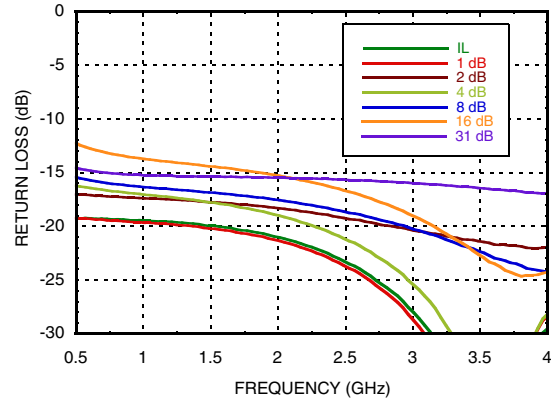

Normalized Attenuation
(Only Major States are Shown)

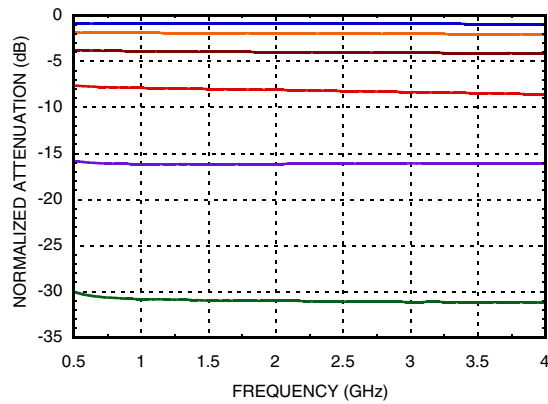

Bit Error vs. Attenuation State

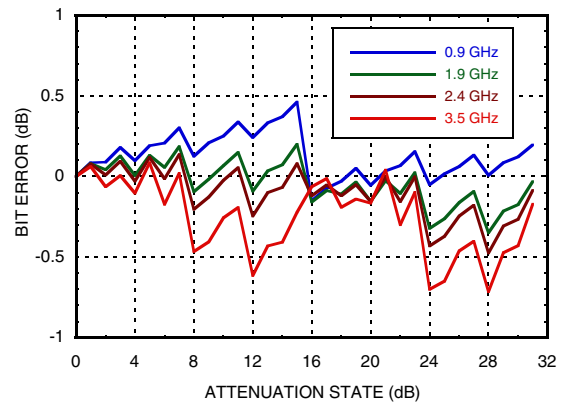

Bit Error vs. Frequency
(Only Major States are Shown)

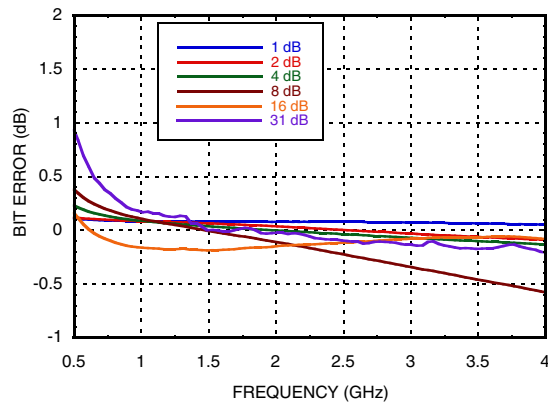

Relative Phase vs. Frequency
(Only Major States are Shown)

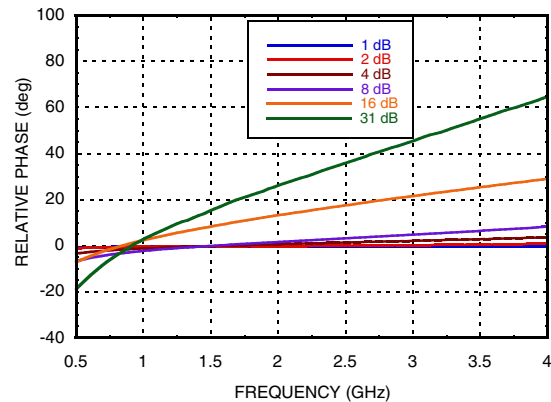

Note: All Data Typical Over Voltage (+3V to +5V)

1 DB LSB GAAS MMIC 5-BIT DIGITAL ATTENUATOR, 0.7 - 3.8 GHz

**Input IP3 Vs. Frequency @ VDD= 3V,
T_A = +25° C**

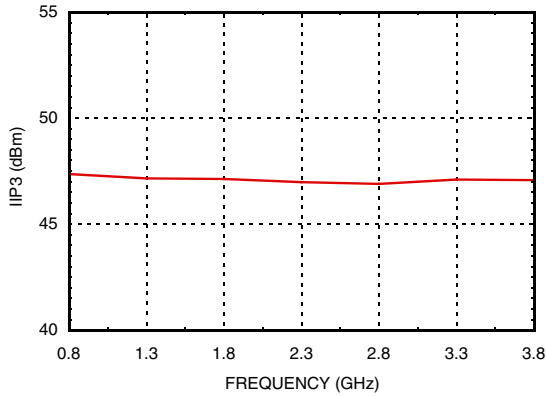

**Input IP3 vs. Frequency @ VDD= 5V,
T_A = +25° C**

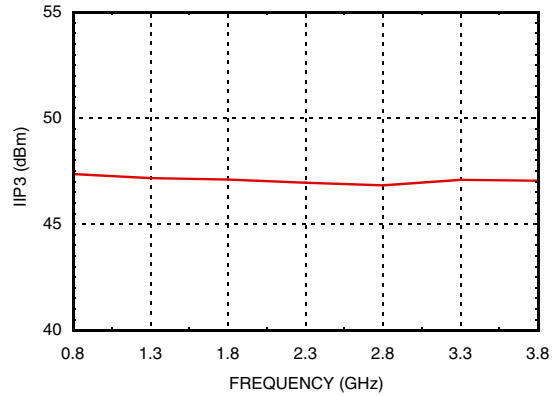

**P0.1dB Vs. Frequency @ VDD= 3V,
T_A = +25° C**

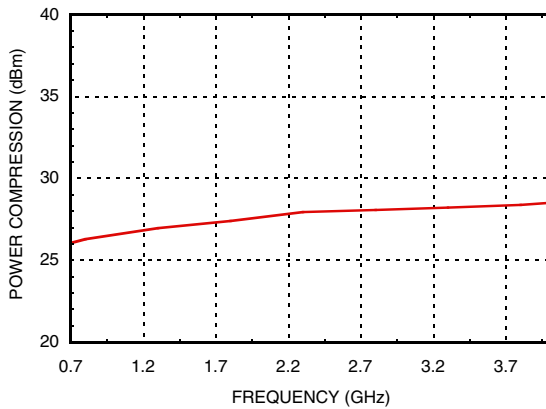

**P0.1dB Vs. Frequency @ VDD= 5V,
T_A = +25° C**

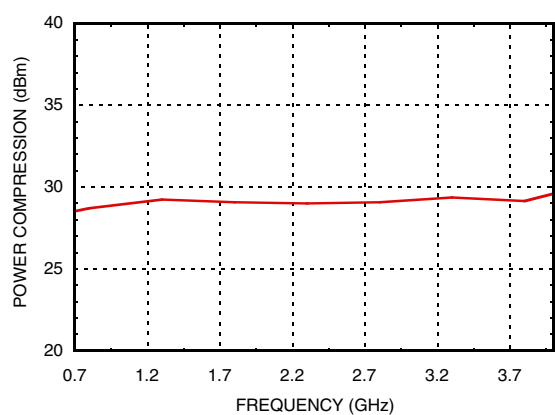

**Step Error Vs. Frequency
(Only Major States are Shown)**

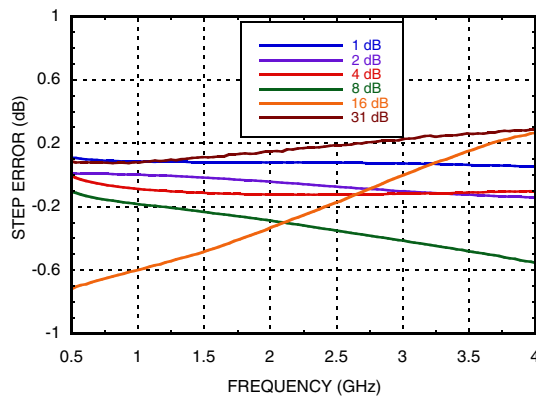

1 DB LSB GAAS MMIC 5-BIT DIGITAL ATTENUATOR, 0.7 - 3.8 GHz

Application Circuit

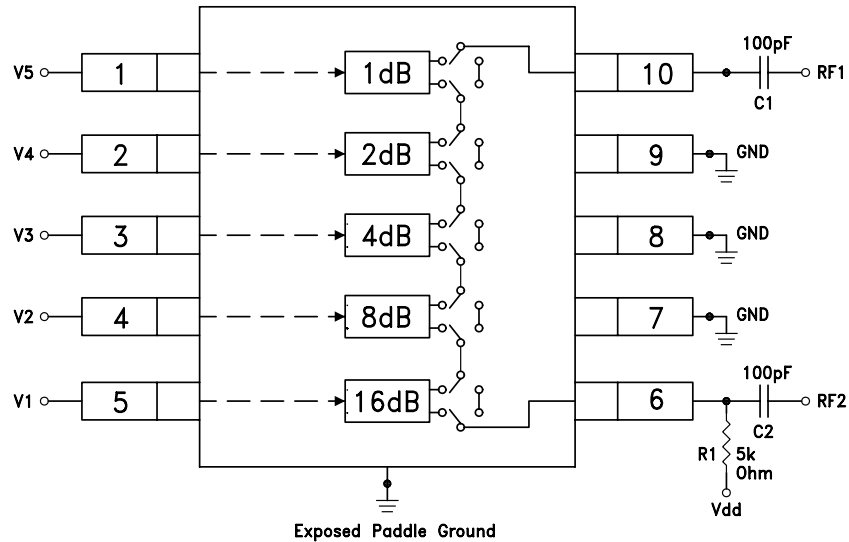

DC blocking capacitors C1 & C2 are required on RF1 & RF2. Choose C1 = C2 = 100 ~ 300 pF to allow lowest customer specific frequency to pass with minimal loss. R1 = 5K Ohm is required to supply voltage to the circuit through either PIN 6 or PIN 10.

Truth Table

Control Voltage Input					Attenuation Setting RF1 - RF2
V1 16 dB	V2 8 dB	V3 4 dB	V4 2 dB	V5 1 dB	
High	High	High	High	High	Reference I.L.
High	High	High	High	Low	1 dB
High	High	High	Low	High	2 dB
High	High	Low	High	High	4 dB
High	Low	High	High	High	8 dB
Low	High	High	High	High	16 dB
Low	Low	Low	Low	Low	31 dB Max. Atten.

Any combination of the above states will provide an attenuation approximately equal to the sum of the bits selected.

Control Voltages

State	Bias Condition
Low	0 to +0.2 V @ < 1uA Max
High	Vdd ± 0.2V @ 1uA Max

Note: Vdd = +3V to 5V ± 0.2V

Absolute Maximum Ratings

Control Voltage (V1 - V5)	Vdd + 0.5 V
Bias Voltage (Vdd)	+8.0 Vdc
Channel Temperature	150 °C
Continuous Pdiss	0.68 W
Thermal Resistance	95°C/W
Storage Temperature	-65 to +150 °C
Operating Temperature	-40 to +85 °C
RF Input Power	+26 dBm
ESD Sensitivity (HBM)	Class 1A



ELECTROSTATIC SENSITIVE DEVICE
OBSERVE HANDLING PRECAUTIONS

1 DB LSB GAAS MMIC 5-BIT DIGITAL ATTENUATOR, 0.7 - 3.8 GHz

Outline Drawing

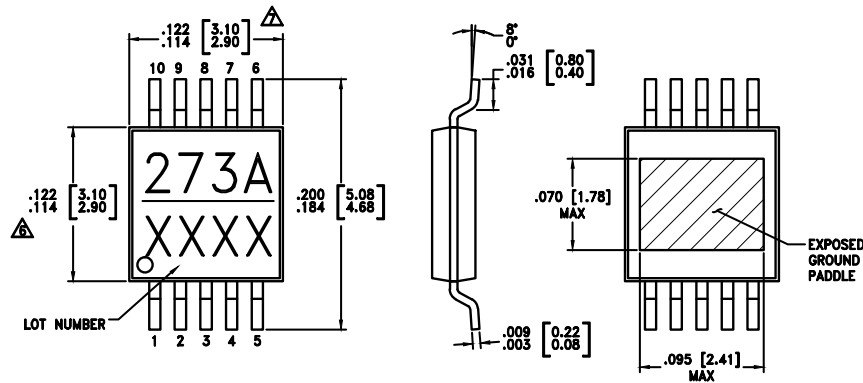

NOTES:

1. PACKAGE BODY MATERIAL: LOW STRESS INJECTION MOLDED PLASTIC SILICA AND SILICON IMPREGNATED.
2. LEAD AND GROUND PADDLE MATERIAL: COPPER ALLOY
3. LEAD AND GROUND PADDLE PLATING: 100% MATTE TIN.
4. DIMENSIONS ARE IN INCHES [MILLIMETERS]
5. CHARACTERS TO BE HELVETICA MEDIUM, .030 HIGH, LASER OR WHITE INK, LOCATED APPROXIMATELY AS SHOWN.
6. DIMENSION DOES NOT INCLUDE MOLDFLASH OF 0.15mm PER SIDE.
7. DIMENSION DOES NOT INCLUDE MOLDFLASH OF 0.25mm PER SIDE.
8. ALL GROUND LEADS AND GROUND PADDLE MUST BE SOLDERED TO PCB RF GROUND.

Package Information

Part Number	Package Body Material	Lead Finish	MSL Rating	Package Marking ^[3]
HMC273AMS10GE	RoHS-compliant Low Stress Injection Molded Plastic	100% matte Sn	MSL1 ^[2]	273A XXXX

[1] Max peak reflow temperature of 235 °C

[2] Max peak reflow temperature of 260 °C

[3] 4-Digit lot number XXXX

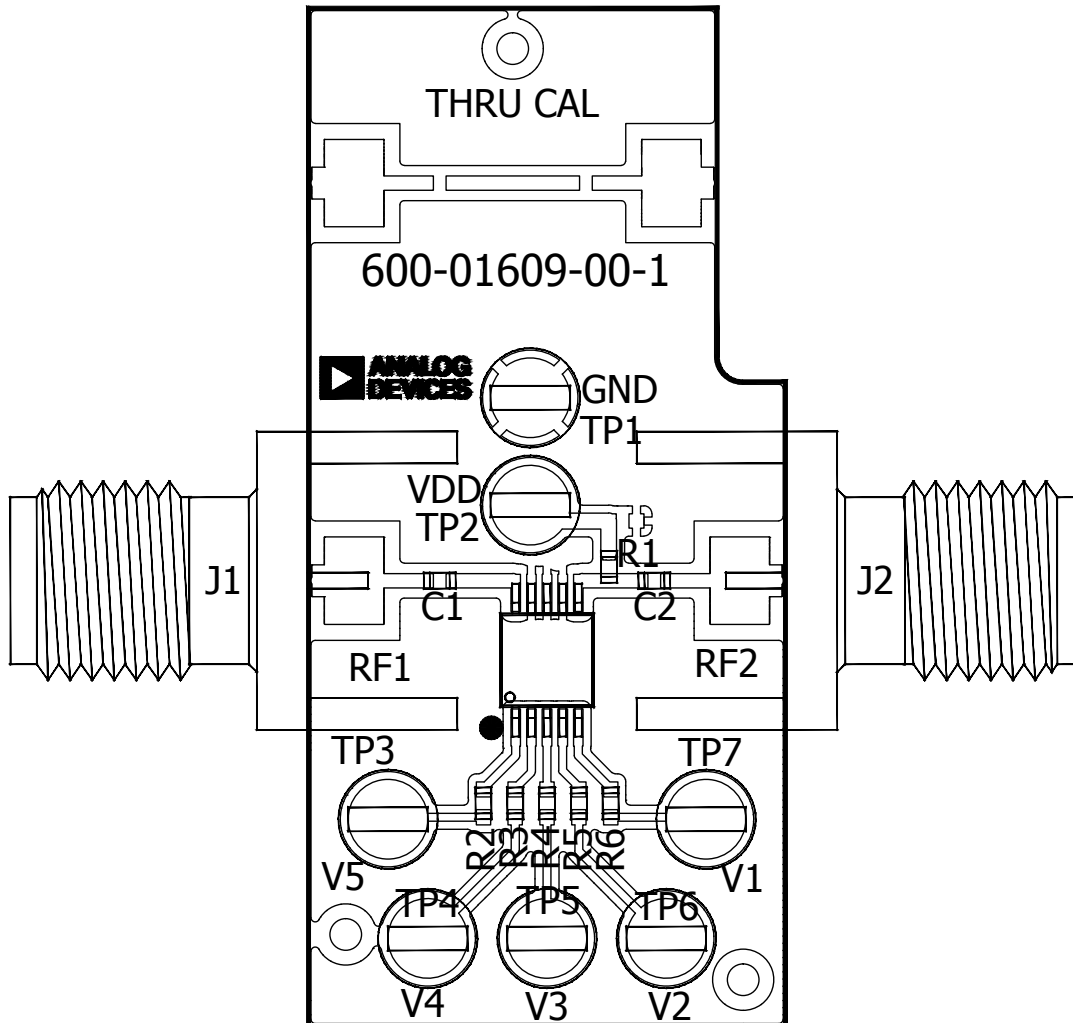
**1 DB LSB GAAS MMIC 5-BIT DIGITAL
ATTENUATOR, 0.7 - 3.8 GHz**
Evaluation Circuit Board

List of Materials for Evaluation PCB EV1HMC273AMS10G^[1]

Item	Description
J1 - J2	PCB Mount SMA Connector
J3 - J6	DC Pin
R1	5 kOhm Resistor, 0402 Chip
R2, R3, R4	100 Ohm Resistor, 0402 Chip
C1, C2	0402 Chip Capacitor, Select for Lowest Frequency of Operation
U1	HMC273AMS10GE Digital Attenuator
PCB [2]	EV1HMC273AMS10G Evaluation PCB 1.5" x 1.5"

[1] Reference this number when ordering complete evaluation PCB

[2] Circuit Board Material: Rogers 4350

The circuit board used in the application should use RF circuit design techniques. Signal lines should have 50 Ohm impedance while the package ground leads and exposed ground paddle should be connected directly to the ground plane similar to that shown below. A sufficient number of via holes should be used to connect the top and bottom ground planes. The evaluation circuit board as shown is available from Hittite Microwave Corporation upon request.