

**NPN Silicon Germanium RF Transistor**

- High gain ultra low noise RF transistor
- Provides outstanding performance for a wide range of wireless applications up to 10 GHz and more
- Ideal for CDMA and WLAN applications
- Outstanding noise figure  $F = 0.5$  dB at 1.8 GHz  
Outstanding noise figure  $F = 0.8$  dB at 6 GHz
- High maximum stable gain  
 $G_{ms} = 24$  dB at 1.8 GHz
- Gold metallization for extra high reliability
- 150 GHz  $f_T$ -Silicon Germanium technology

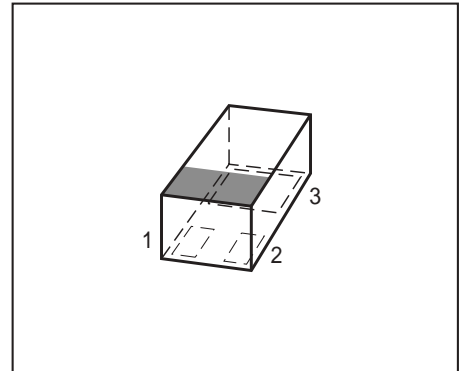

**ESD (Electrostatic discharge) sensitive device, observe handling precaution!**

Type	Marking	Pin Configuration			Package
BFR740L3	R7	1=B	2=C	3=E	TSLP-3-8

**Maximum Ratings**

Parameter	Symbol	Value	Unit
Collector-emitter voltage $T_A > 0^\circ\text{C}$ $T_A \leq 0^\circ\text{C}$	$V_{CEO}$	4 3.5	V
Collector-emitter voltage	$V_{CES}$	13	
Collector-base voltage	$V_{CBO}$	13	
Emitter-base voltage	$V_{EBO}$	1.2	
Collector current	$I_C$	30	mA
Base current	$I_B$	3	
Total power dissipation <sup>1)</sup> $T_S \leq 94^\circ\text{C}$	$P_{tot}$	160	mW
Junction temperature	$T_j$	150	$^\circ\text{C}$
Ambient temperature	$T_A$	-65 ... 150	
Storage temperature	$T_{stg}$	-65 ... 150	

<sup>1)</sup>  $T_S$  is measured on the collector lead at the soldering point to the pcb

**Thermal Resistance**

Parameter	Symbol	Value	Unit
Junction - soldering point <sup>1)</sup>	$R_{thJS}$	$\leq 350$	K/W

**Electrical Characteristics** at  $T_A = 25^\circ\text{C}$ , unless otherwise specified

Parameter	Symbol	Values			Unit
		min.	typ.	max.	

**DC Characteristics**

Collector-emitter breakdown voltage $I_C = 1 \text{ mA}, I_B = 0$	$V_{(BR)CEO}$	4	4.7	-	V
Collector-emitter cutoff current $V_{CE} = 13 \text{ V}, V_{BE} = 0$	$I_{CES}$	-	-	30	$\mu\text{A}$
Collector-base cutoff current $V_{CB} = 5 \text{ V}, I_E = 0$	$I_{CBO}$	-	-	100	nA
Emitter-base cutoff current $V_{EB} = 0.5 \text{ V}, I_C = 0$	$I_{EBO}$	-	-	3	$\mu\text{A}$
DC current gain $I_C = 25 \text{ mA}, V_{CE} = 3 \text{ V}$ , pulse measured	$h_{FE}$	160	250	400	-

<sup>1)</sup>For calculation of  $R_{thJA}$  please refer to Application Note Thermal Resistance

**Electrical Characteristics** at  $T_A = 25^\circ\text{C}$ , unless otherwise specified

Parameter	Symbol	Values			Unit
		min.	typ.	max.	
<b>AC Characteristics</b> (verified by random sampling)					
Transition frequency $I_C = 25\text{ mA}$ , $V_{CE} = 3\text{ V}$ , $f = 2\text{ GHz}$	$f_T$	-	42	-	GHz
Collector-base capacitance $V_{CB} = 3\text{ V}$ , $f = 1\text{ MHz}$ , $V_{BE} = 0$ , emitter grounded	$C_{cb}$	-	0.1	0.16	pF
Collector emitter capacitance $V_{CE} = 3\text{ V}$ , $f = 1\text{ MHz}$ , $V_{BE} = 0$ , base grounded	$C_{ce}$	-	0.18	-	
Emitter-base capacitance $V_{EB} = 0.5\text{ V}$ , $f = 1\text{ MHz}$ , $V_{CB} = 0$ , collector grounded	$C_{eb}$	-	0.38	-	
Noise figure $I_C = 8\text{ mA}$ , $V_{CE} = 3\text{ V}$ , $f = 1.8\text{ GHz}$ , $Z_S = Z_{Sopt}$ $I_C = 8\text{ mA}$ , $V_{CE} = 3\text{ V}$ , $f = 6\text{ GHz}$ , $Z_S = Z_{Sopt}$	$F$	-	0.5 0.8	-	dB
Power gain, maximum stable <sup>1)</sup> $I_C = 25\text{ mA}$ , $V_{CE} = 3\text{ V}$ , $Z_S = Z_{Sopt}$ , $Z_L = Z_{Lopt}$ , $f = 1.8\text{ GHz}$	$G_{ms}$	-	24	-	dB
Power gain, maximum available <sup>1)</sup> $I_C = 25\text{ mA}$ , $V_{CE} = 3\text{ V}$ , $Z_S = Z_{Sopt}$ , $Z_L = Z_{Lopt}$ , $f = 6\text{ GHz}$	$G_{ma}$	-	14.5	-	dB
Transducer gain $I_C = 25\text{ mA}$ , $V_{CE} = 3\text{ V}$ , $Z_S = Z_L = 50\ \Omega$ , $f = 1.8\text{ GHz}$ $f = 6\text{ GHz}$	$ S_{21e} ^2$	-	21.5 12	-	dB
Third order intercept point at output <sup>2)</sup> $V_{CE} = 3\text{ V}$ , $I_C = 25\text{ mA}$ , $Z_S = Z_L = 50\ \Omega$ , $f = 1.8\text{ GHz}$	$IP_3$	-	25	-	dBm
1dB Compression point at output $I_C = 25\text{ mA}$ , $V_{CE} = 3\text{ V}$ , $Z_S = Z_L = 50\ \Omega$ , $f = 1.8\text{ GHz}$	$P_{-1dB}$	-	11	-	

<sup>1)</sup>  $G_{ma} = |S_{21e} / S_{12e}| (k - (k^2 - 1)^{1/2})$ ,  $G_{ms} = |S_{21e} / S_{12e}|$ 
<sup>2)</sup>  $IP_3$  value depends on termination of all intermodulation frequency components.  
Termination used for this measurement is  $50\ \Omega$  from 0.1 MHz to 6 GHz

**Total power dissipation  $P_{tot} = f(T_S)$**

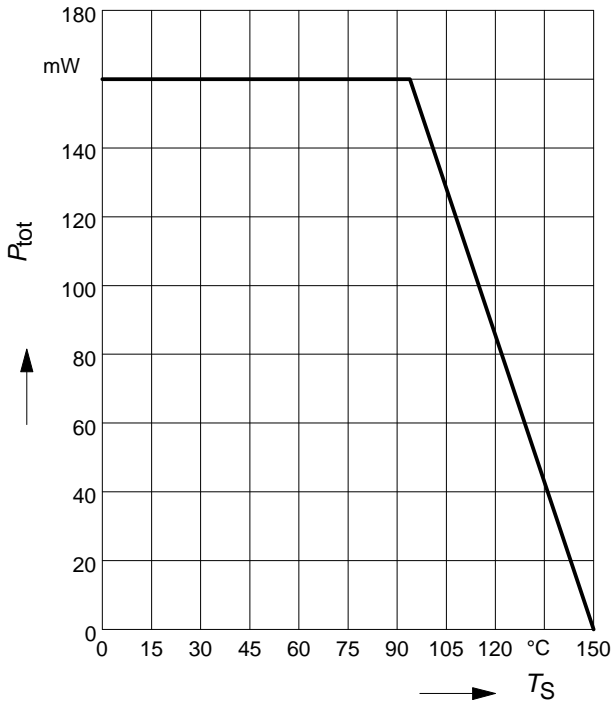

**Permissible Pulse Load  $R_{thJS} = f(t_p)$**

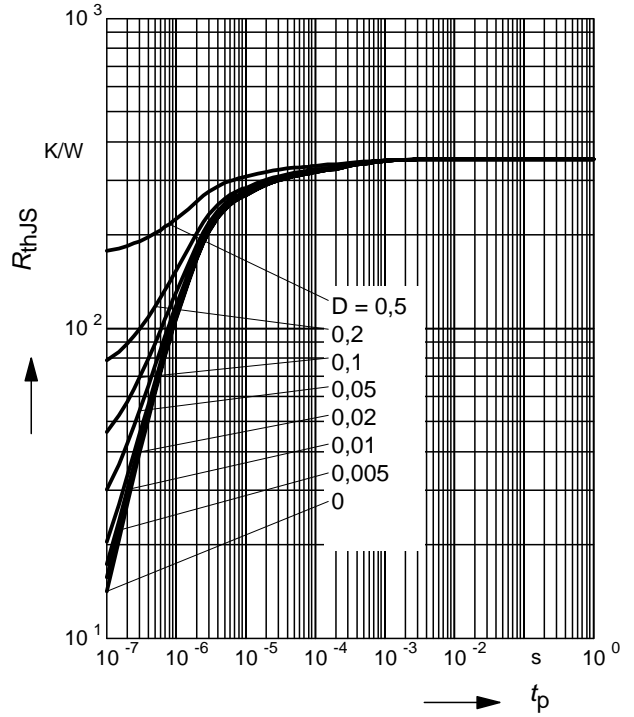

**Permissible Pulse Load**

$P_{totmax}/P_{totDC} = f(t_p)$

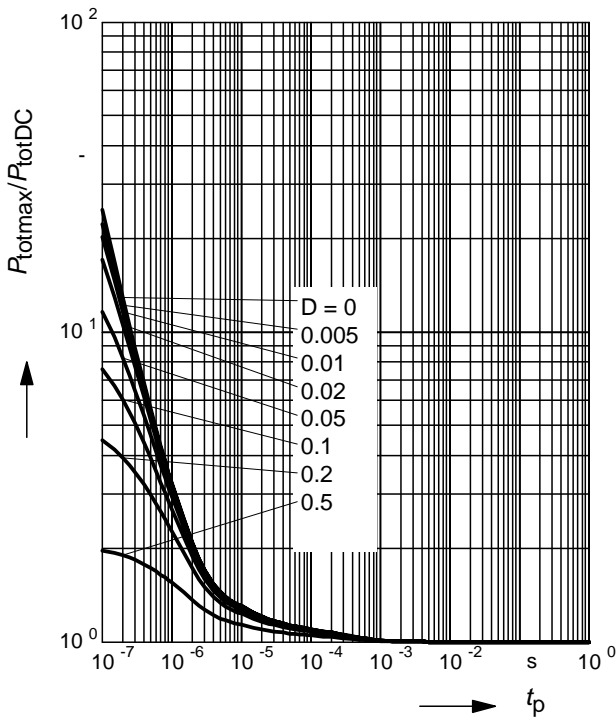

**Collector-base capacitance  $C_{cb} = f(V_{CB})$**

$f = 1 \text{ MHz}$

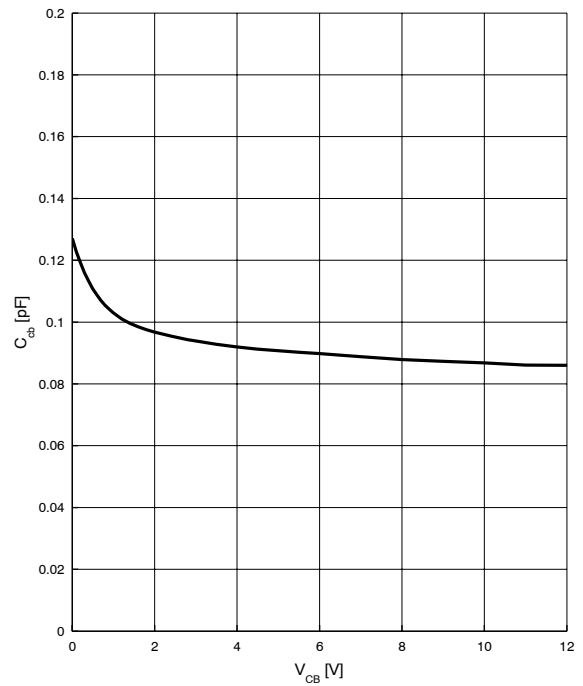

**Third order Intercept Point  $IP_3 = f(I_C)$**

(Output,  $Z_S = Z_L = 50 \Omega$ )

$V_{CE} = \text{parameter}$ ,  $f = 1.8 \text{ GHz}$

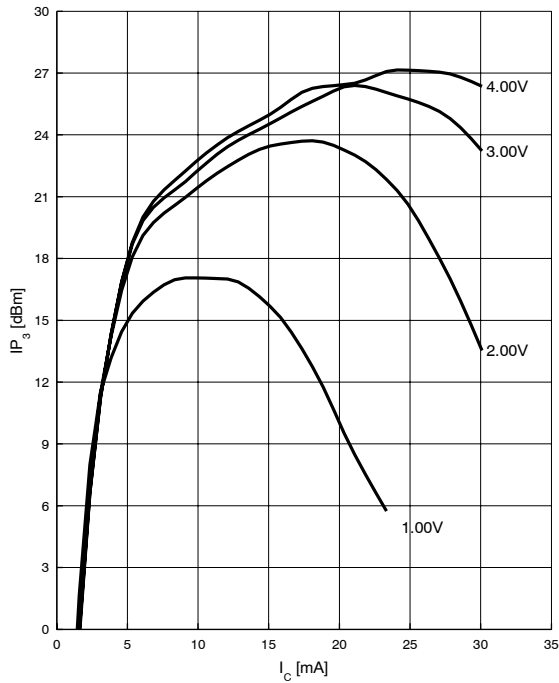

**Transition frequency  $f_T = f(I_C)$**

$V_{CE} = \text{parameter}$ ,  $f = 2 \text{ GHz}$

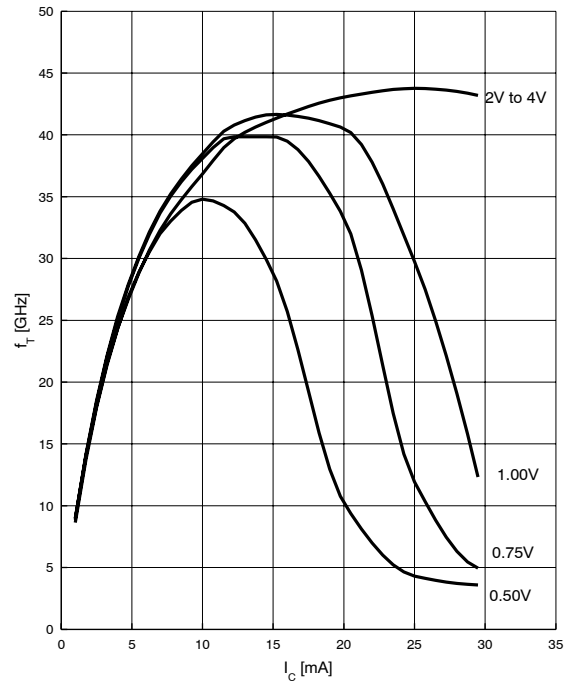

**Power gain  $G_{ma}, G_{ms} = f(f)$**

$V_{CE} = 3 \text{ V}$ ,  $I_C = 25 \text{ mA}$

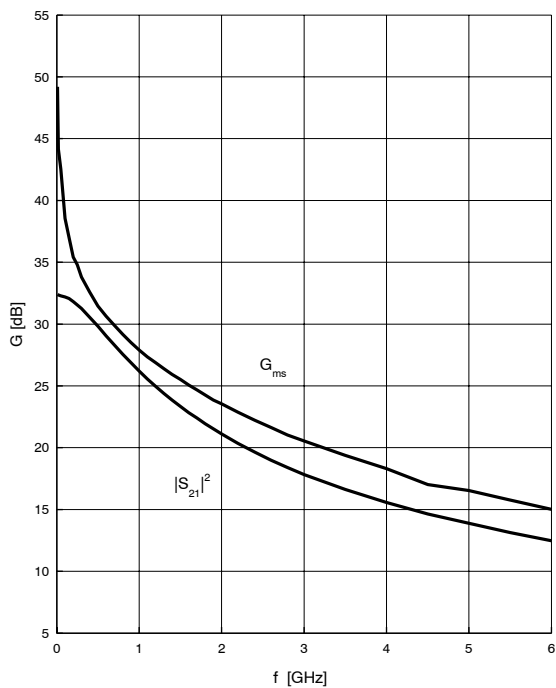

**Power gain  $G_{ma}, G_{ms} = f(I_C)$**

$V_{CE} = 3 \text{ V}$

$f = \text{parameter}$

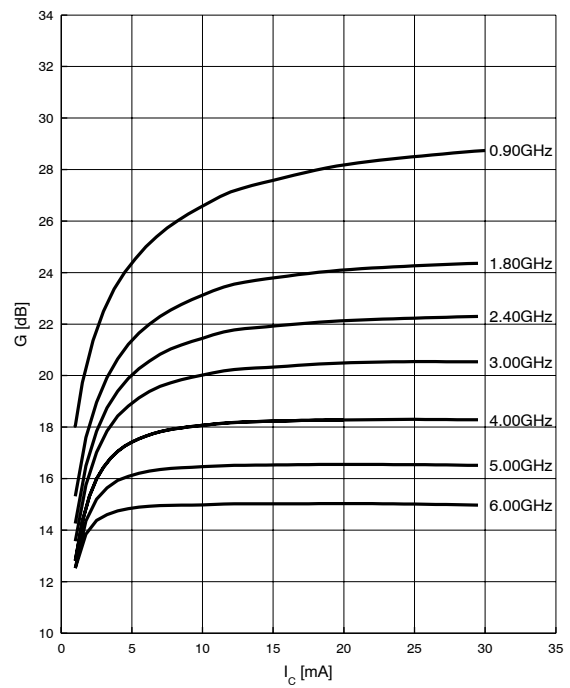

**Power gain  $G_{ma}$ ,  $G_{ms} = f(V_{CE})$**

$I_C = 25 \text{ mA}$

$f = \text{parameter}$

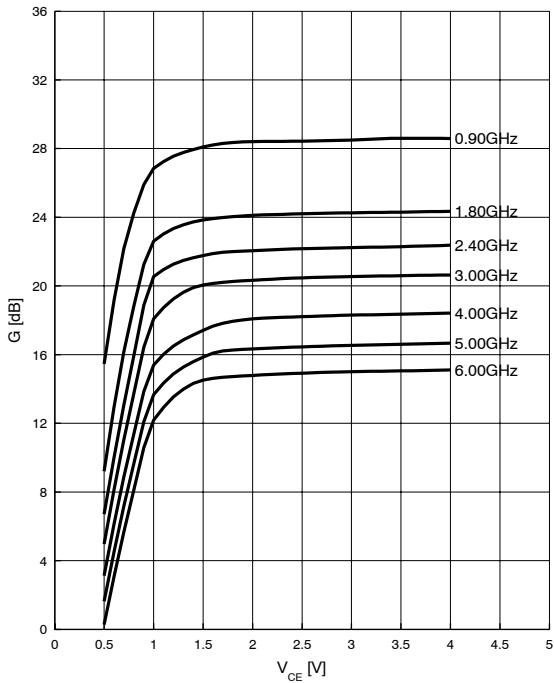

**Noise figure  $F = f(I_C)$**

$V_{CE} = 3 \text{ V}$ ,  $f = \text{parameter}$

$Z_S = Z_{Sopt}$

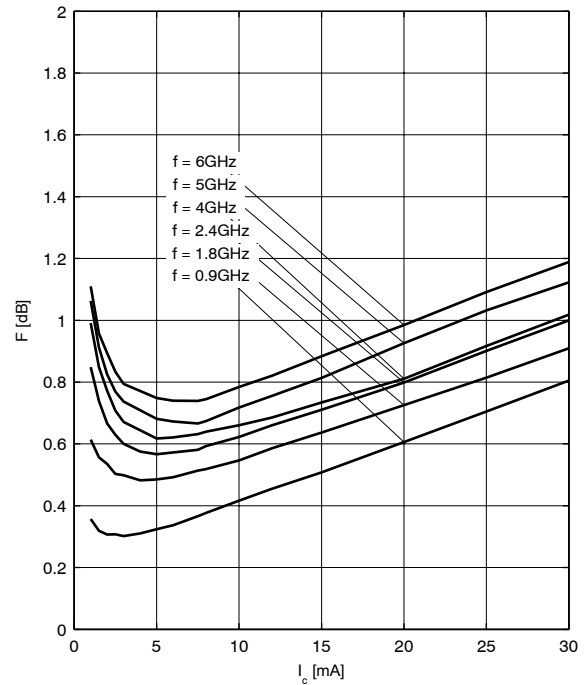

**Noise figure  $F = f(I_C)$**

$V_{CE} = 3 \text{ V}$ ,  $f = 1.8 \text{ GHz}$

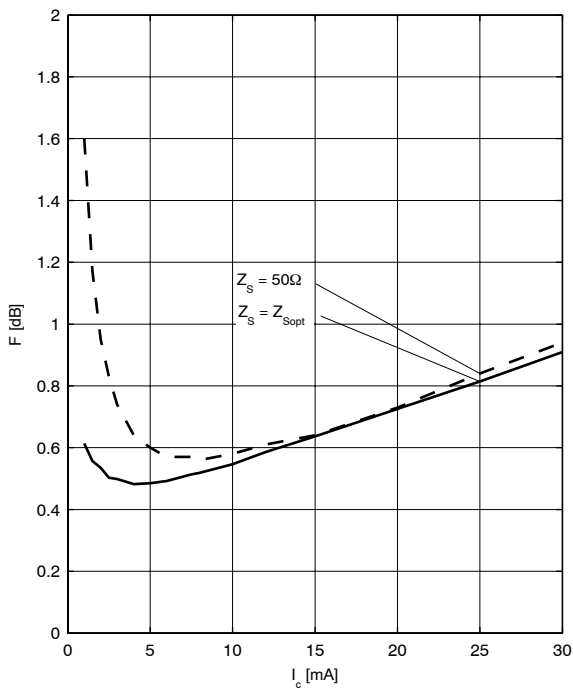

**Noise figure  $F = f(f)$**

$V_{CE} = 3 \text{ V}$ ,  $Z_S = Z_{Sopt}$

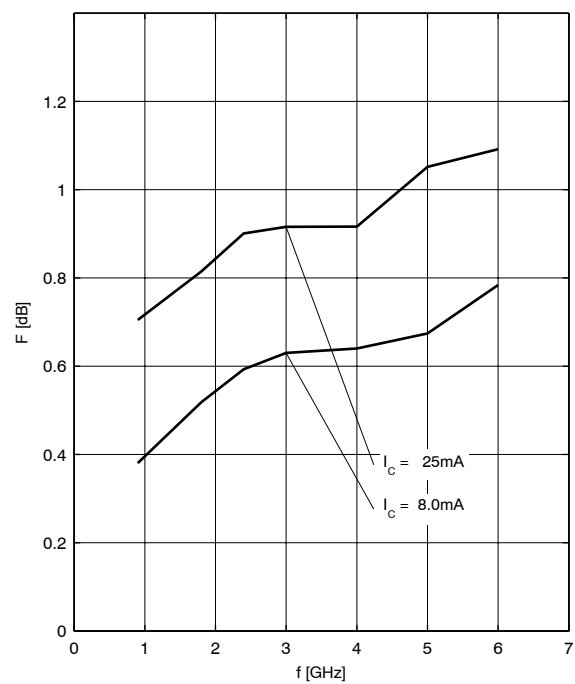

Source impedance for min.

noise figure vs. frequency

$V_{CE} = 3\text{ V}$ ,  $I_C = 8\text{ mA} / 25\text{ mA}$

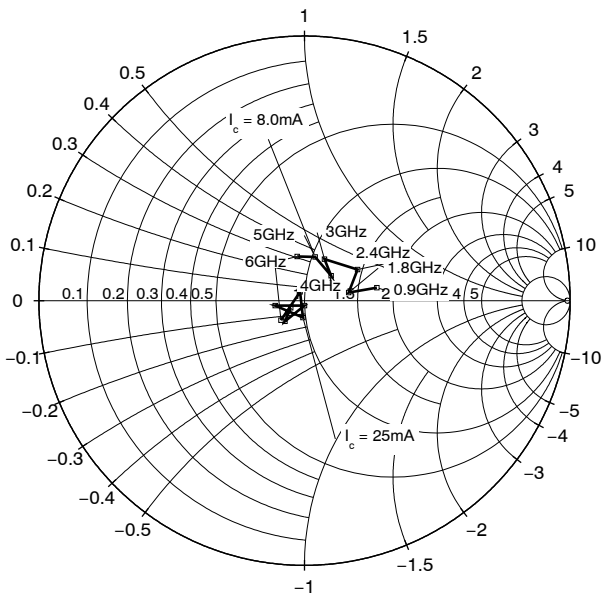

### Package Outline

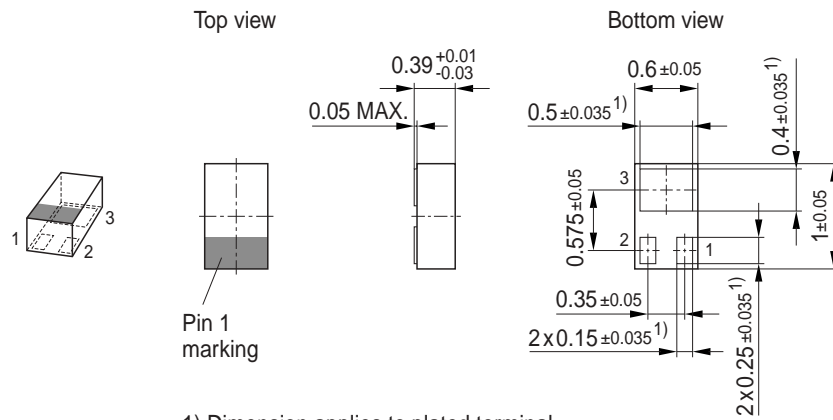

1) Dimension applies to plated terminal

### Foot Print

For board assembly information please refer to Infineon website "Packages"

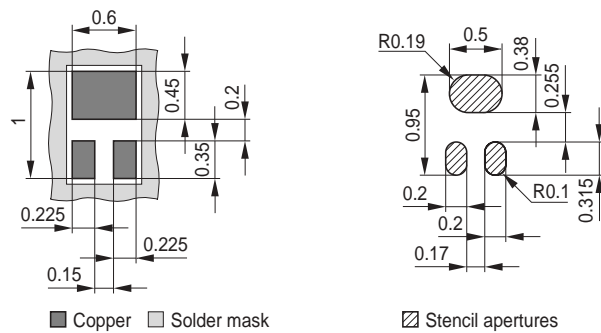

### Marking Layout

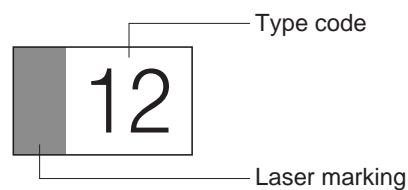

### Standard Packing

Reel ø180 mm = 15.000 Pieces/Reel

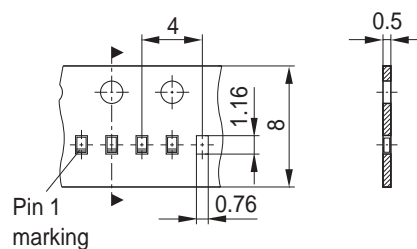



Published by Infineon Technologies AG,  
St.-Martin-Strasse 53,  
81669 München  
© Infineon Technologies AG 2005.  
All Rights Reserved.

**Attention please!**

The information herein is given to describe certain components and shall not be considered as a guarantee of characteristics.

Terms of delivery and rights to technical change reserved.

We hereby disclaim any and all warranties, including but not limited to warranties of non-infringement, regarding circuits, descriptions and charts stated herein.

**Information**

For further information on technology, delivery terms and conditions and prices please contact your nearest Infineon Technologies Office ([www.infineon.com](http://www.infineon.com)).

**Warnings**

Due to technical requirements components may contain dangerous substances. For information on the types in question please contact your nearest Infineon Technologies Office.

Infineon Technologies Components may only be used in life-support devices or systems with the express written approval of Infineon Technologies, if a failure of such components can reasonably be expected to cause the failure of that life-support device or system, or to affect the safety or effectiveness of that device or system. Life support devices or systems are intended to be implanted in the human body, or to support and/or maintain and sustain and/or protect human life. If they fail, it is reasonable to assume that the health of the user or other persons may be endangered.