

LTC3880: Dual Output Step-Down DC/DC Controller with Digital Power Management

DESCRIPTION

Demonstration circuit 1590B is a dual output synchronous buck converter featuring the LTC[®]3880EUJ, a dual output peak current mode controller with digital power system management. There are two versions of the board available:

- DC1590B-A: Senses the output current across a sense resistor and has a default switching frequency of 350kHz.
- DC1590B-B: Senses output current with the inductor DCR and has a default switching frequency of 425kHz.

Either version can be populated with the LTC3880EUJ-1, instead of the LTC3880EUJ, which allows the user to provide bias power to the IC from an external power supply.

These boards provide two programmable outputs of 20A each. The factory default settings are 1.8V for each output.

Both boards power up to default settings and produce power based on configuration resistors without the need for any serial bus communication. This allows easy evaluation of the DC/DC converter. To fully explore the extensive digital

power management features of the part, download the GUI software LTpowerPlay™ onto your PC and use LTC's I²C/SMBus/PMBus dongle DC1613A to connect to the board. LTpowerPlay allows the user to reconfigure the part on the fly and store the configuration in EEPROM, view telemetry of voltage, current, temperature and fault status.

GUI Download

The software can be downloaded from:

<http://www.linear.com/ltpowerplay>

For more details and instructions of LTpowerPlay, please refer to LTpowerPlay GUI for LTC3880 Quick Start Guide.

Design files for this circuit board are available at <http://www.linear.com/demo>

LT, LT, LTC, LTM, Linear Technology and the Linear logo are registered trademarks and LTpowerPlay is a trademark of Linear Technology Corporation. All other trademarks are the property of their respective owners.

PERFORMANCE SUMMARY (T_A = 25°C)

SYMBOL	PARAMETER	CONDITIONS	MIN	TYP	MAX	UNITS
V _{IN}	Input Supply Range		6.5	12	24	V
V _{OUT_0}	Adjustable Output Voltage Range	I _{OUT1} = 0A to 20A, V _{IN} = 6.5V to 24V	0.5	1.8	4.0	V
I _{OUT_0}	Output Current Range				20	A
V _{OUT_1}	Adjustable Output Voltage Range	I _{OUT1} = 0A to 20A, V _{IN} = 6.5V to 24V	0.5	1.8	5.0	V
I _{OUT_1}	Output Current Range				20	A
f _{SW-A}	Factory Default Switching Freq-A (R _{SENSE})			350		kHz
f _{SW-B}	Factory Default Switching Freq-B (DCR)			425		kHz
EFF	Peak Efficiency	V _{OUT} = 1.8V, See Figures 6 and 7		89.5		%

QUICK START PROCEDURE

Demonstration circuit 1590B makes it easy to set up and evaluate the performance of the LTC3880. Refer to Figure 3 for proper measurement equipment setup and follow the procedure below:

Note: When measuring the input or output voltage ripple, care must be taken to avoid a long ground lead on the oscilloscope probe. Measure the output voltage ripple by touching the probe tip directly across the C32 or C34. See Figure 5 for proper scope probe technique.

1. Make sure jumpers are in the following positions:

JUMPER	POSITION	FUNCTION
JP1	OFF	Write Protection of LTC3880
JP2	NC	RUN0 to RUN1
JP3	ON	3.3V Test—3.3V for LED indicator
JP4	OFF	EXTVCC_DRV—External V _{CC} for LTC3880-1
JP5	NC	GPIO0B to GPIO1B—Tie GPIOs Together

2. With power off, connect the input power supply to V_{IN} and GND. Connect active loads to outputs.
3. Make sure both RUN switches are off.
4. Turn on the power at the input.

Note: Make sure that the input voltage does not exceed 24V.

5. Turn on RUN switches as desired.
6. Check for the correct output voltages. $V_{OUT1} = V_{OUT2} = 1.8V \pm 0.5\%$

Note: If there is no output, temporarily disconnect the load to make sure that the load current is not set too high.

7. Once the proper output voltages are established, adjust the loads within the operating range and observe the output voltage regulation, ripple voltage, efficiency and other parameters.
8. Connect the dongle and control the output voltages from the GUI. See “LTpowerPlay GUI for the LTC3880 Quick Start Guide” for details.

Connecting a PC to DC1590B

You can use a PC to reconfigure the power management features of the LTC3880 such as: nominal V_{OUT}, margin set points, OV/UV limits, temperature fault limits, sequencing parameters, the fault log, fault responses, GPIOs and other functionality. The DC1613A dongle may be plugged in regardless of whether or not V_{IN} is present.

QUICK START PROCEDURE

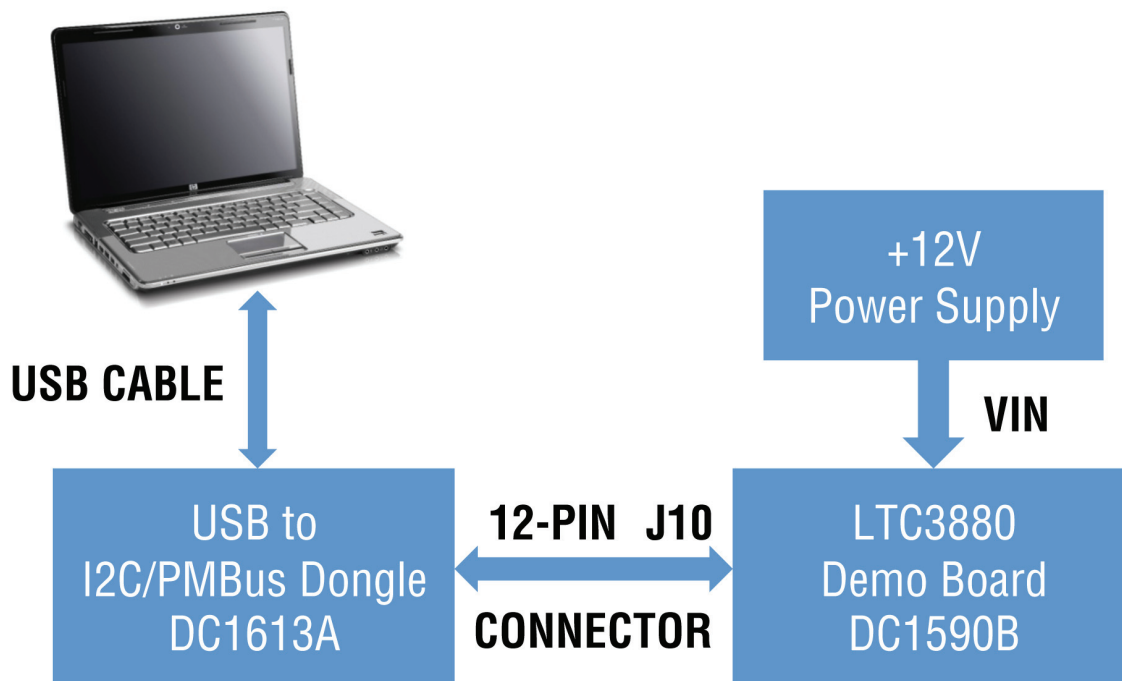

Figure 1. Demo Setup with PC

Plug the dongle into the correct connector. Dongle can be hot plugged.

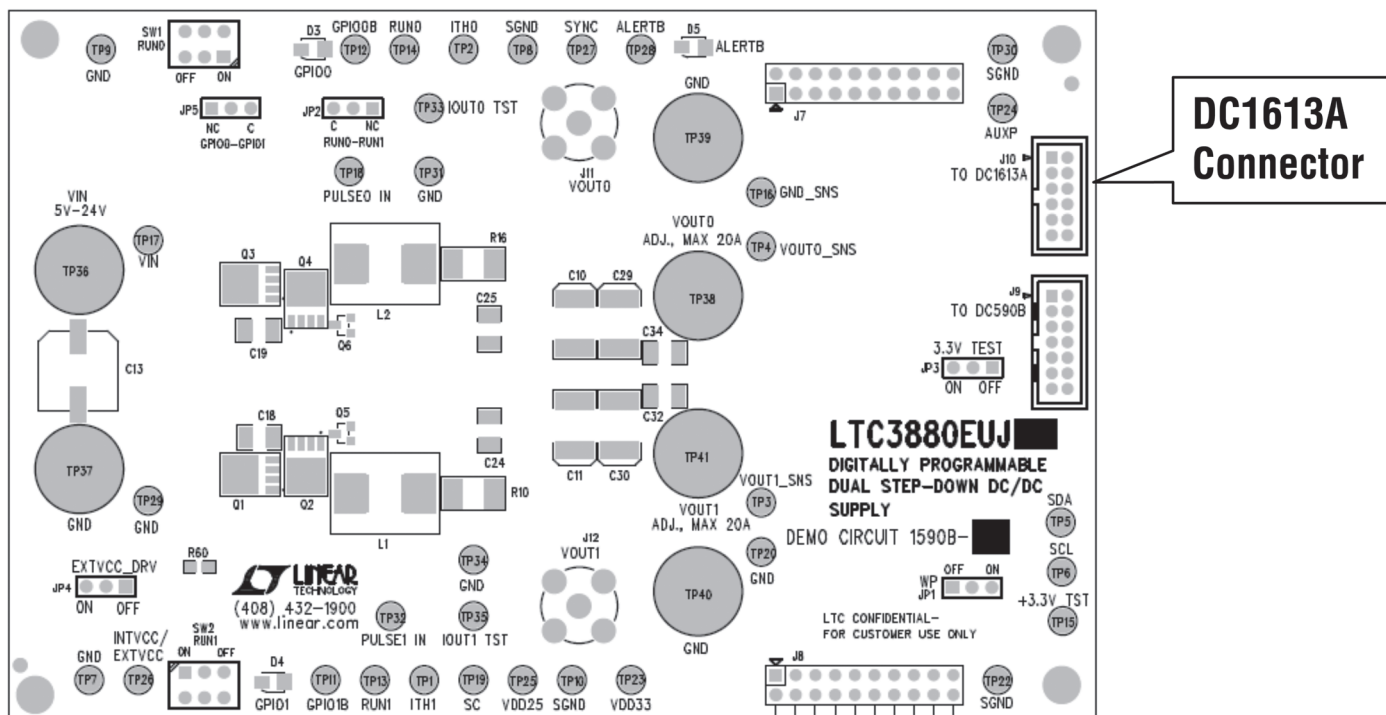

Figure 2. Dongle Connector Locations

QUICK START PROCEDURE

High Output Current Configuration

By default, the DC1590B powers up with two independently adjustable outputs at 1.8V each. For >20A operation, it is recommended to install the optional MOSFETs Q9 and Q10 for large step-down ratios and Q7 and Q8 for small step-down ratios.

Combining DC1590B with Other Digital Power Demo Boards

The DC1590B may be plugged together in a multi-board array with other digital power boards using optional J7 and J8.

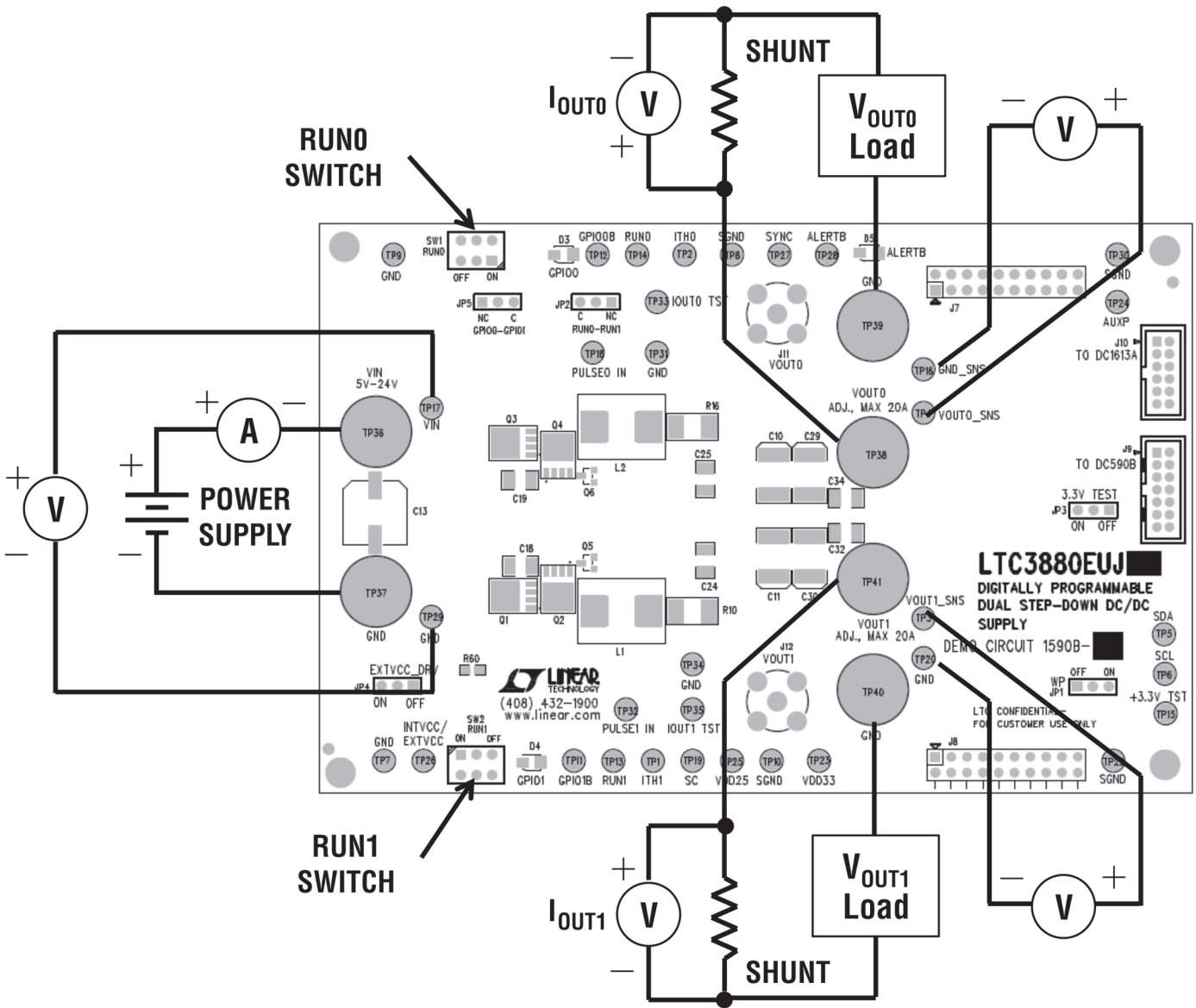

Figure 3. Dual Output Test Setup

QUICK START PROCEDURE

Measuring Efficiency (See Figure 4)

To accurately measure efficiency of any configuration, do the following:

- Set JP3 to OFF to disable the regulator that provides power to various auxiliary demo board components like LEDs.
- Measure V_{IN} across the input ceramic capacitor (C18, C19). Measure V_{OUT} across the output ceramic capacitor (C24, C25).

Evaluating the LTC3880-1

For applications that require the highest possible efficiency, the LTC3880-1 allows the user to supply the bias voltage and gate driver current from an external power supply. Connect the power supply, 4.8V to 5.2V, to the EXTVCC pin. Obtain a DC1590B with an LTC3880-1 installed from your Linear Technology Field Applications Engineer.

To use the onboard LDO to drive INTVCC, make the following modifications to the demo board:

- Set JP4 to ON so that U7 provides the drive to EXTVCC. U7 takes the place of the external power supply.
- Install R60.

To accurately measure efficiency of a demo board containing an LTC3880-1,

- Drive INTVCC from an external source through the pin named: INTVCC/EXTVCC.
- Set JP4 to OFF to disable U7.
- Measure V_{IN} across the input ceramic capacitor (C18, C19). Measure V_{OUT} across the output ceramic capacitor (C24, C25).

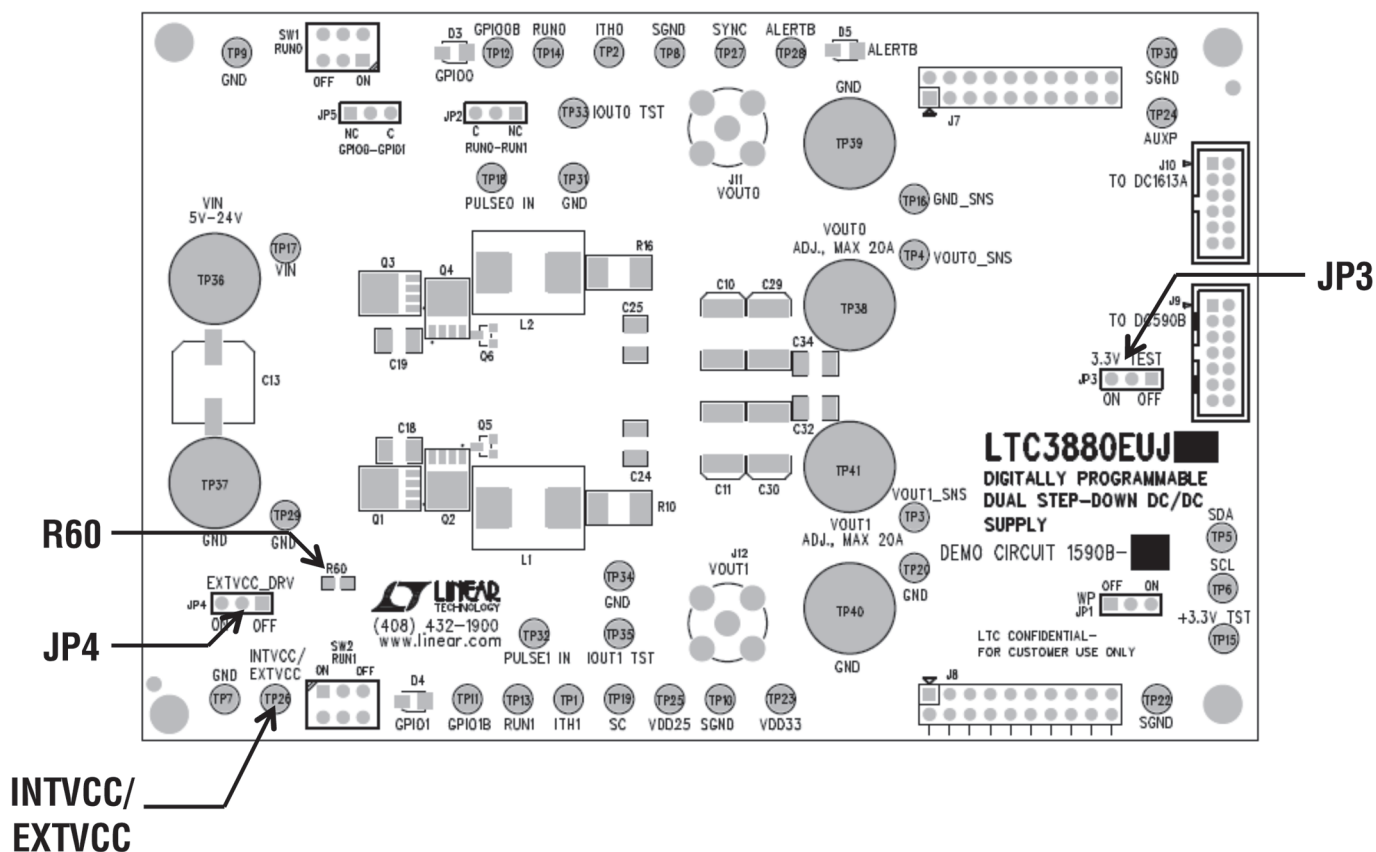

Figure 4 Jumper Locations: JP3, JP4, R60, INTVCC Turret

QUICK START PROCEDURE

Measuring Output Ripple Voltage

An accurate ripple measurement may be performed by using the below configuration across C34 or C32.

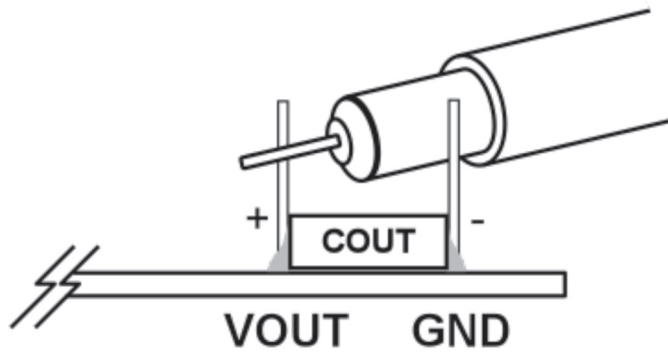
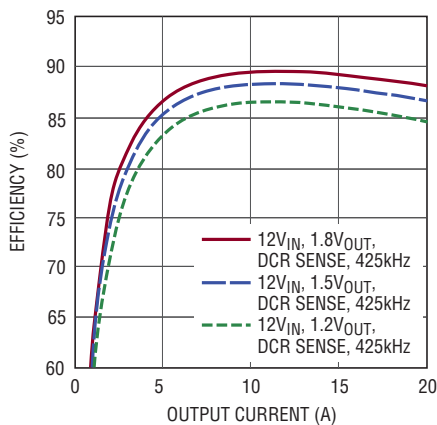
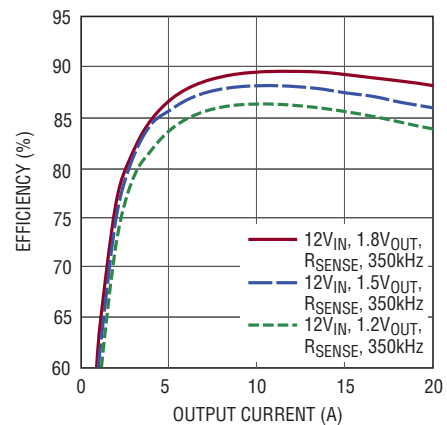

Figure 5. Measuring Output Voltage Ripple



DC1590B F06

Figure 6. Typical Efficiency Curves (DCR Current Sense), 1.8V_{OUT}, 12V_{IN}, f_{SW} = 425kHz



DC1590B F07

Figure 7. Typical Efficiency Curves (R_{SENSE}), 1.8V_{OUT}, 12V_{IN}, f_{SW} = 350kHz

PARTS LIST DC1590B-A

ITEM	QTY	REFERENCE	PART DESCRIPTION	MANUFACTURER/PART NUMBER
Required Circuit Components				
1	2	C21, C22	CAP, X5R, 1000pF, 25V, 10%, 0603	AVX, 06035C102JAT2A
2	3	C1, C2, C6	CAP, X7R, 0.1μF, 50V, 10%, 0603	AVX, 06035C104KAT2A
3	1	C17	CAP, X7R, 0.22μF, 25V, 10%, 0603	TDK, C1608X7R1E224K
4	2	C3, C9	CAP, X7R, 1μF, 16V, 10%, 0603	AVX, 0603YC105KAT2A
5	1	C5	CAP, X5R, 4.7μF, 25V, 0805	TAIYO YUDEN, TMK212BJ475KG-T
6	2	C7, C8	CAP, X7R, 4700PF, 10%, 50V, 0603	AVX, 06035C472KAT2A
7	2	C10, C29	CAP, POSCAP, 330μF, 4V, 7343	SANYO, 4TPF330M9L
8	2	C11, C30	CAP, POSCAP, 330μF, 6.3V, 7343	SANYO, 6TPF330M9L
9	1	C13	CAP, OS-CON, 150μF, 35V	SUNCON, 35HVP150M
10	4	C24, C25, C32, C34	CAP, X5R, 100μF, 6.3V, 1210	AVX, 12106D107MAT2A
11	2	C12, C14	CAP, X7R, 0.01μF, 10%, 50V, 0603	AVX, 06035C103KAT2A
12	2	C15, C16	CAP, X7R, 100PF, 5%, 50V, 0603	AVX, 06035C101KAT2A
13	4	C18, C19, C27, C28	CAP, X5R, 10μF, 35V, 1210	TAIYO YUDEN, GMK325BJ106KN-T
14	1	C48	CAP, X5R, 10μF, 6.3V, 0603	TDK, C1608X5R0J106M
15	2	D1, D2	DIODE, SCHOTTKY, SOD-323	CENTRAL, CMDSH-3TR
16	2	Q1, Q3	MOSFET SPEED SRS 30V 30A LPAK	RENESAS, RJK0305DPB-00#J0
17	2	Q2, Q4	MOSFET JET SERIES 30V 45A LPAK	RENESAS, RJK0330DPB-00#J0
18	2	Q5, Q6	TRANS GP SS PNP 40V SOT-23	ON SEMI, MMBT3906LT1G
19	11	R5, R17, R27, R28, R39, R40-R44, R57	RES., CHIP, 10k, 5%, 0603	VISHAY, CRCW060310K0FKEA
20	11	R6, R8, R9, R19, R20, R25, R29, R30, R34, R56, R59	RES., CHIP, 0Ω, 0603	VISHAY, CRCW06030000Z0EA
21	2	R10, R16	RES., 0.002Ω, 2512	VISHAY, WSL25122L000FEA
22	4	R11, R12, R13, R14	RES., CHIP, 100Ω, 1%, 0603	VISHAY, CRCW0603100RFKEA
23	2	R3, R4	RES., CHIP, 4.87k, 1%, 0603	AAC, CR16-4871FM
24	2	R21, R22	RES., CHIP, 11.3k, 1%, 0603	AAC, CR16-1132FM
25	1	R24	RES., CHIP, 23.2k, 1%, 0603	AAC, CR16-2333FM
26	2	R32, R67	RES., CHIP, 24.9k, 1%, 0603	NIC, NRC06F2492TRF
27	1	R52	RES., CHIP, 2Ω, 1%, 0603	YAGEO, RC0603FR-072RL
28	1	U4	IC, LTC3880EUJ, QFN 6mm × 6mm	LINEAR TECH, LTC3880EUJ#PBF
29	2	L1, L2	INDUCTOR, 0.4μH	VITEC., 59PR9875
Additional Circuit Components				
1	1	C31	CAP, X7R, 0.1μF, 50V, 10%, 0603	AVX, 06035C104KAT2A
2	0	C4, C38	CAP, 0603, OPTION	OPTION
3	1	C49	CAP, X5R, 4.7μF, 10V, 0603	AVX, 0603ZD475KAT2A
4	0	C42-C45	CAP, 7343, OPTION	OPTION
5	2	C26, C33	CAP, X7R, 0.01μF, 10%, 50V, 0603	AVX, 06035C103KAT2A
6	1	C35	CAP, X5R, 10μF, 35V, 1206	TAIYO YUDEN, GMK316BJ106ML-T
7	0	C20, C23	CAP, 1210, OPTION	OPTION
8	1	C36	CAP, TANT, LOW ESR, 3.3μF, 25V, 10%	AVX, TPSB335K025R2000
9	2	C37, C40	CAP, X7R, 1μF, 50V, 1206	NIC, NMC1206X7R105K50TR
10	2	C41, C47	CAP, X7R, 0.22μF, 6.3V, 0805	AVX, 0805YC224KAT2A

DEMO MANUAL DC1590B

PARTS LIST DC1590B-A

ITEM	QTY	REFERENCE	PART DESCRIPTION	MANUFACTURER/PART NUMBER
11	2	D3, D4	LED GREEN S-GW TYPE SMD	PANASONIC, LN1371SGTRP
12	1	D5	LED RED S-TYPE GULL WING SMD	PANASONIC, LN1271RTR
13	2	Q15, Q16	MOSFET, SPEED SRS 30V 30A LFPAK	RENESAS, RJK0305DPB-00#J0
14	0	Q7, Q8, Q9, Q10	MOSFET, LFPAK, OPTION	OPTION
15	1	Q14	MOSFET, P-CH 20V 0.58A SOT-23	VISHAY, TP0101K-T1-E3
16	2	Q12, Q13	MOSFET, N-CH 60V 115MA SOT-23	FAIRCHILD 2N7002A
17	2	R62, R72	RES., CHIP, 10k, 5%, 0603	VISHAY, CRCW060310K0FKEA
18	5	R38, R47, R48, R51, R58	RES., CHIP, 0 Ω , 0603	VISHAY, CRCW06030000Z0EA
19	0	R1, R2, R7, R15, R18, R23, R26, R31	RES., 0603, OPTION	OPTION
20		R33, R49, R69, R70, R73, R74		
21	0	R60, R82, R84	RES., 0805, OPTION	OPTION
22	4	R77, R79, R80, R81	RES., CHIP, 0 Ω , 0805	VISHAY, CRCW08050000Z0EA
23	3	R35, R36, R37	RES., CHIP, 4.99k, 1%, 0603	YAGEO, RC0603FR-074K99L
24	2	R50, R61	RES., CHIP, 100k, 1%, 0603	VISHAY, CRCW0603100KKEA
25	2	R53, R54	RES., CHIP, 200 Ω , 1%, 0603	YAGEO, RC0603FR-07200RL
26	1	R55	RES., CHIP, 12 Ω , 1%, 0603	VISHAY, CRCW0603127RFKEA
27	2	R63, R64	RES., CHIP, 10 Ω , 5%, 0603	YAGEO, RC0603FR-0710RL
28	0	R65, R66	RES., CHIP, 30 Ω , 1%, 1W, 2512, OPTION	VISHAY, CRCW251230R0JNEG, OPTION
29	2	R68, R75	RES., CHIP, 0.01 Ω , 1%, 2010	VISHAY
30	1	U5	IC, 24LC025-I/ST, SOIC	MICROCHIP, 24LC025-I/ST
31	1	U6	IC, LT1129CS8-3.3, S8 PACKAGE	LINEAR TECH, LT1129CS8-3.3
32	1	U7	IC, LT1129CS8-5, S8 PACKAGE	LINEAR TECH, LT1129CS8-5

Hardware

1	5	JP1-JP5	2MM SINGLE ROW HEADER, 3 PIN	SAMTEC, TMM-103-02-L-S
2	5	JP1-JP5	SHUNT	SAMTEC, 2SN-BK-G
3	2	SW1, SW2	CONNECTOR, SUB MINIATURE SLIDE SWITCHES	C&K., JS202011CQN
4	35	TP1-TP20, TP22-TP35	TESTPOINT, TURRET, 0.062"	MILL-MAX, 2308-2-00-80-00-00-07-0
5	6	TP36-TP41	JACK, BANANA	KEYSTONE, 575-4
6	1	J7	CONN SOCKET 20 DUAL ROW RA, OPTION	MILL-MAX, 803-93-020-20-001, OPTION
7	1	J8	PIN HEADER 20 DUAL ROW RA, OPTION	MILL-MAX, 802-40-020-20-0001, OPTION
8	0	J9	HEADER 14POS 2MM VERT GOLD, OPTION	MOLEX, 87831-1420, OPTION
9	1	J10	CONN HEADER 12POS 2MM STR DL PCB	FCI, 98414-G06-12ULF
10	2	J11, J12	CONN, BNC, 5 PINS	CONNEX, 112404
11	5	(STAND-OFF)	STAND-OFF, NYLON 0.50" tall	KEYSTONE, 8833 (SNAP ON)

PARTS LIST DC1590B-B

ITEM	QTY	REFERENCE	PART DESCRIPTION	MANUFACTURER/PART NUMBER
Required Circuit Components				
1	3	C1, C2, C6	CAP, X7R, 0.1µF, 50V, 10%, 0603	AVX, 06035C104KAT2A
2	2	C21, C22	CAP, X5R, 0.22µF, 25V, 10%, 0603	AVX, 06033D224KAT2A
3	1	C17	CAP, X7R, 0.22µF, 25V, 10%, 0603	TDK, C1608X7R1E224K
4	2	C4, C38	CAP, X5R, 1µF, 25V, 10%, 0603	AVX, 06033D105KAT2A
5	2	C3, C9	CAP, X7R, 1µF, 16V, 10%, 0603	AVX, 0603YC105KAT2A
6	1	C5	CAP, X5R, 4.7µF, 25V, 0805	TAIYO YUDEN, TMK212BJ475KG-T
7	2	C7, C8	CAP, X7R, 4700PF, 10%, 50V, 0603	AVX, 06035C472KAT2A
8	2	C10, C29	CAP, POSCAP, 330µF, 4V, 7343	SANYO, 4TPF330M9L
9	2	C11, C30	CAP, POSCAP, 330µF, 6.3V, 7343	SANYO, 6TPF330M9L
10	1	C13	CAP, OS-CON, 150µF, 35V	SUNCON, 35HVP150M
11	4	C24, C25, C32, C34	CAP, X5R, 100µF, 6.3V, 1210	AVX, 12106D107MAT2A
12	2	C12, C14	CAP, X7R, 0.01µF, 10%, 50V, 0603	AVX, 06035C103KAT2A
13	2	C15, C16	CAP, X7R, 100PF, 5%, 50V, 0603	AVX, 06035C101KAT2A
14	4	C18, C19, C27, C28,	CAP, X5R, 10µF, 35V, 1210	TAIYO YUDEN, GMK325BJ106KN-T
15	1	C48	CAP, X5R, 10µF, 6.3V, 0603	TDK, C1608X5R0J106M
16	2	D1, D2	DIODE, SCHOTTKY, SOD-323	CENTRAL CMDSH-3TR
17	2	Q1, Q3	MOSFET SPEED SRS 30V 30A LFPAK	RENESAS RJK0305DPB-00#J0
18	2	Q2, Q4	MOSFET JET SERIES 30V 45A LFPAK	RENESAS RJK0330DPB-00#J0
19	2	Q5, Q6	TRANS GP SS PNP 40V SOT-23	ON SEMI MMBT3906LT1G
20	11	R5, R17, R27, R28, R39, R40-R44, R57	RES., CHIP, 10k, 5%, 0603	VISHAY, CRCW060310K0FKEA
21	7	R8, R9, R19, R20, R25, R56, R59	RES., CHIP, 0Ω, 0603	VISHAY, CRCW06030000Z0EA
22	4	R7, R15, R11, R13	RES., CHIP, 0Ω, 0603	YAGEO, RC0603FR-070RL
23	2	R10, R16	RES., CHIP, 0Ω, 1W, 2512	TEPRO, RN5326
24	4	R1, R2, R12, R14	RES., X5R, 1.4k, 1%, 0603	VISHAY, CRCW06031K40FKEA
25	2	R3, R4	RES., CHIP, 4.87k, 1%, 0603	AAC, CR16-4871FM
26	2	R21, R22	RES., CHIP, 11.3k, 1%, 0603	AAC, CR16-1132FM
27	1	R18	RES., CHIP, 16.2k, 1%, 0603	VISHAY, CRCW060316K2FKEA
28	1	R23	RES., CHIP 17.4k 1% 0603	AAC, CR16-1742FM
29	1	R24	RES., CHIP, 23.2k, 1%, 0603	AAC, CR16-2333FM
30	2	R32, R67	RES., CHIP, 24.9k, 1%, 0603	NIC, NRC06F2492TRF
31	1	R52	RES., CHIP, 2Ω, 1%, 0603	YAGEO, RC0603FR-072RL
32	1	U4	IC, LTC3880EUJ, QFN 6mm × 6mm	LINEAR TECH, LTC3880EUJ#PBF
33	2	L1, L2	INDUCTOR, 0.56µH	VISHAY, IHLP-4040-DZ-01
Additional Circuit Components				
1	1	C31	CAP, X7R, 0.1µF, 50V, 10%, 0603	AVX, 06035C104KAT2A
2	1	C49	CAP, X5R, 4.7µF, 10V, 0603	AVX, 0603ZD475KAT2A
3	0	C42-C45	CAP, 7343, OPTION	OPTION
4	2	C26, C33	CAP, X7R, 0.01µF, 10%, 50V, 0603	AVX, 06035C103KAT2A
5	1	C35	CAP, X5R, 10µF, 35V, 1206	TAIYO YUDEN, GMK316BJ106ML-T
6	0	C20, C23	CAP, 1210, OPTION	OPTION
7	1	C36	CAP, TANT, LOW ESR, 3.3µF, 25V, 10%	AVX, TPSB335K025R2000

DEMO MANUAL DC1590B

PARTS LIST DC1590B-B

ITEM	QTY	REFERENCE	PART DESCRIPTION	MANUFACTURER/PART NUMBER
8	2	C37, C40	CAP, X7R 1 μ F 50V 1206	NIC, NMC1206X7R105K50TR
9	2	C41, C47	CAP, X7R 0.22 μ F 6.3V 0805	AVX, 0805YC224KAT2A
10	2	D3, D4	LED GREEN S-GW TYPE SMD	PANASONIC LN1371SGTRP
11	1	D5	LED RED S-TYPE GULL WING SMD	PANASONIC LN1271RTR
12	2	Q15, Q16	MOSFET SPEED SRS 30V 30A LPAK	RENESAS RJK0305DPB-00#J0
13	0	Q7, Q8, Q9, Q10	MOSFET, LPAK,OPTION	OPTION
14	1	Q14	MOSFET P-CH 20V 0.58A SOT-23	VISHAY TP0101K-T1-E3
15	2	Q12, Q13	MOSFET N-CH 60V 115MA SOT-23	FAIRCHILD 2N7002A
16	2	R62, R72	RES., CHIP, 10k, 5%, 0603	VISHAY, CRCW060310K0FKEA
17	5	R38, R47, R48, R51, R58	RES., CHIP, 0 Ω , 0603	VISHAY, CRCW06030000Z0EA
18	0	R6, R26, R29, R30, R31, R33, R34, R49 R69, R70, R73, R74	RES., 0603, OPTION	OPTION
19	0	R60, R82, R84	RES., 0805, OPTION	OPTION
20	4	R77, R79, R80, R81	RES., CHIP 0 Ω , 0805	VISHAY, CRCW08050000Z0EA
21	3	R35, R36, R37	RES., CHIP, 4.99k, 1%, 0603	YAGEO, RC0603FR-074K99L
22	2	R50, R61	RES., CHIP, 1.5k, 1%, 0603	AAC, CR16-1504FM
23	2	R53, R54	RES., CHIP, 200 Ω , 1%, 0603	YAGEO, RC0603FR-07200RL
24	1	R55	RES., CHIP, 127 Ω , 1%, 0603	VISHAY, CRCW0603127RFKEA
25	2	R63, R64	RES., CHIP, 10 Ω , 5%, 0603	YAGEO, RC0603FR-0710RL
26	0	R65, R66	RES., CHIP, 30 Ω , 1%, 1W 2512, OPTION	VISHAY, CRCW251230R0JNEG,OPTION
27	2	R68, R75	RES., CHIP, 0.01 Ω , 1%, 2010	VISHAY
28	1	U5	IC, 24LC025-I/ST, SOIC	MICROCHIP, 24LC025-I/ST
29	1	U6	IC, LT1129CS8-3.3 S8 PACKAGE	LINEAR TECH, LT1129CS8-3.3
30	1	U7	IC, LT1129CS8-5, S8 PACKAGE	LINEAR TECH, LT1129CS8-5

Hardware

1	5	JP1-JP5	2MM SINGLE ROW HEADER, 3 PIN	SAMTEC, TMM-103-02-L-S
2	5	JP1-JP5	SHUNT	SAMTEC, 2SN-BK-G
3	2	SW1, SW2	CONNECTOR, SUB MINIATURE SLIDE SWITCHES	C&K., JS202011CQN
4	35	TP1-TP20, TP22-TP35	TESTPOINT, TURRET, 0.062"	MILL-MAX, 2308-2-00-80-00-00-07-0
5	6	TP36-TP41	JACK, BANANA	KEYSTONE 575-4
6	1	J7	CONN SOCKET 20 DUAL ROW RA, OPTION	MILL-MAX 803-93-020-20-001,OPTION
7	1	J8	PIN HEADER 20 DUAL ROW RA, OPTION	MILL-MAX 802-40-020-20-0001,OPTION
8	0	J9	HEADER 14POS 2MM VERT GOLD, OPTION	MOLEX 87831-1420,OPTION
9	1	J10	CONN HEADER 12POS 2MM STR DL PCB	FCI 98414-G06-12ULF
10	2	J11, J12	CONN, BNC, 5 PINS	CONNEX, 112404
11	5	(STAND-OFF)	STAND-OFF, NYLON 0.50" tall	KEYSTONE, 8833(SNAP ON)

SCHEMATIC DIAGRAMS

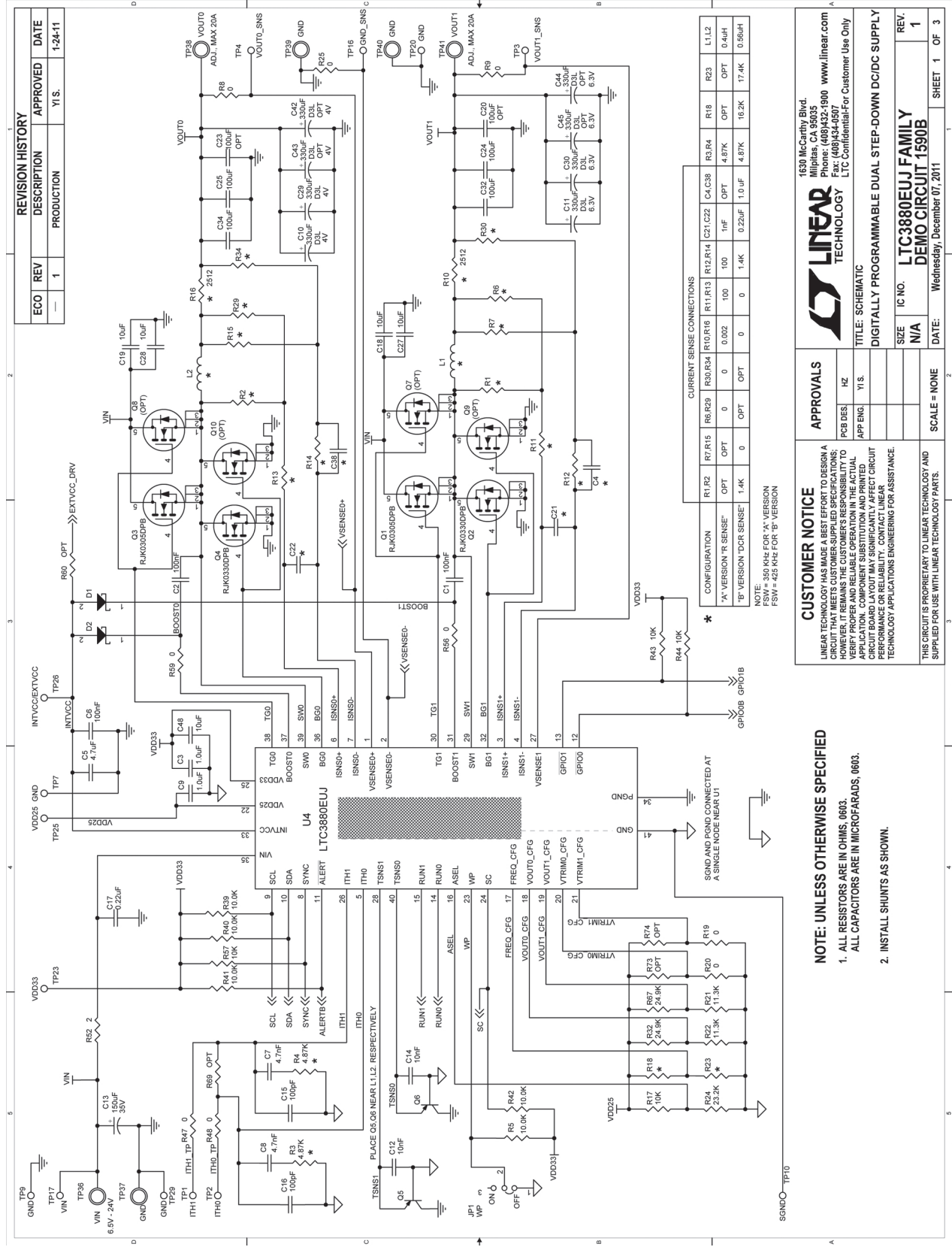

REVISION HISTORY			
ECO	REV	DESCRIPTION	APPROVED DATE
—	1	PRODUCTION	YI S. 1-24-11

LINEAR TECHNOLOGY
 1630 McCarthy Blvd.
 Milpitas, CA 95035
 Phone: (408)432-1900 www.linear.com
 Fax: (408)434-0907
 LTC Confidential-For Customer Use Only

APPROVALS

PCB DES	Hz
APP ENG	YI S.

TITLE: SCHEMATIC
 DIGITALLY PROGRAMMABLE DUAL STEP-DOWN DC/DC SUPPLY

SIZE IC NO. **LTC3880EUJ FAMILY**
DATE: Wednesday, December 07, 2011
REV. 1
SHEET 1 OF 3

CUSTOMER NOTICE
 LINEAR TECHNOLOGY HAS MADE A BEST EFFORT TO DESIGN A CIRCUIT THAT MEETS CUSTOMER-SUPPLIED SPECIFICATIONS; HOWEVER, IT REMAINS THE CUSTOMER'S RESPONSIBILITY TO VERIFY THE PERFORMANCE OF THE CIRCUIT IN THEIR FINAL APPLICATION. COMPONENT SUBSTITUTION AND PRINTED CIRCUIT BOARD LAYOUT MAY SIGNIFICANTLY AFFECT CIRCUIT PERFORMANCE OR RELIABILITY. CONTACT LINEAR TECHNOLOGY APPLICATIONS ENGINEERING FOR ASSISTANCE.

NOTE: UNLESS OTHERWISE SPECIFIED

- ALL RESISTORS ARE IN OHMS. 0603.
- ALL CAPACITORS ARE IN MICROFARADS. 0603.
- INSTALL SHUNTS AS SHOWN.

THIS CIRCUIT IS PROPRIETARY TO LINEAR TECHNOLOGY AND SUPPLIED FOR USE WITH LINEAR TECHNOLOGY PARTS.



DEMO MANUAL DC1590B

SCHEMATIC DIAGRAMS

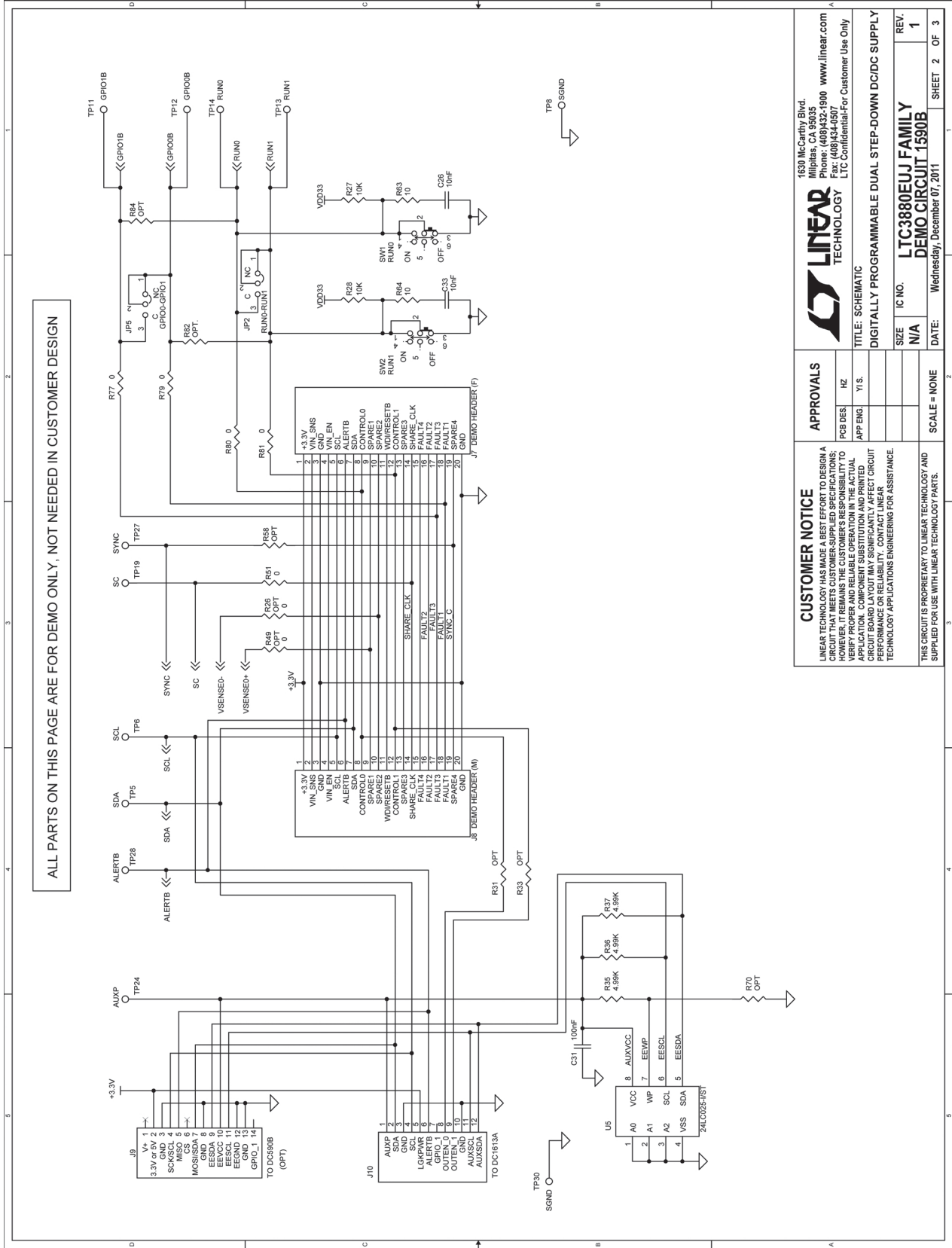

dc1590bf

SCHEMATIC DIAGRAMS

ALL PARTS ON THIS PAGE ARE FOR DEMO ONLY, NOT NEEDED IN CUSTOMER DESIGN

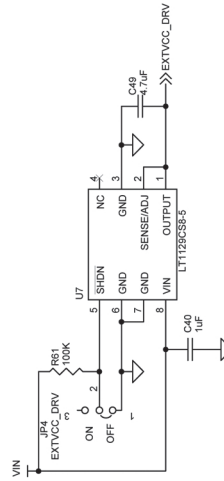
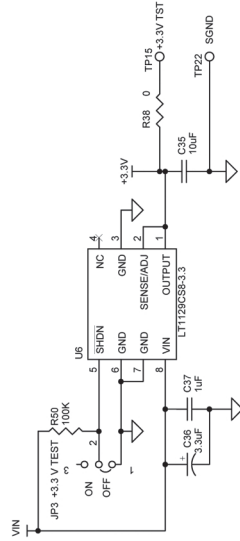
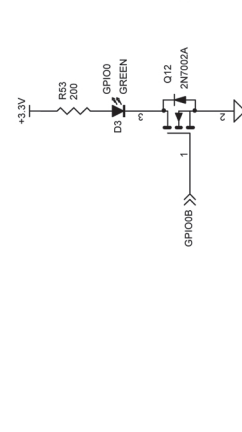
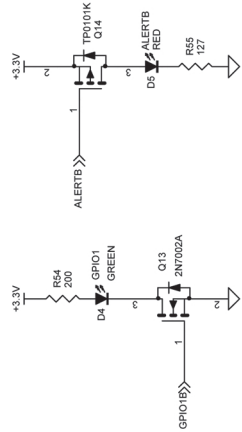
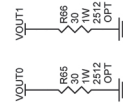
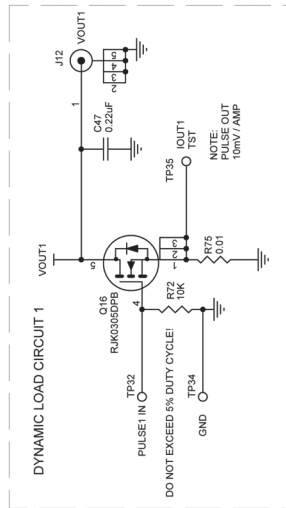
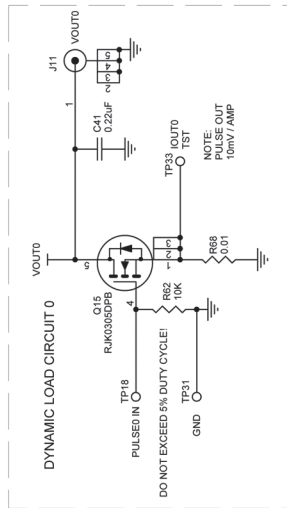

CUSTOMER NOTICE		APPROVALS	
LINEAR TECHNOLOGY HAS MADE A BEST EFFORT TO DESIGN A CIRCUIT THAT MEETS CUSTOMER-SUPPLIED SPECIFICATIONS. HOWEVER, IT REMAINS THE CUSTOMER'S RESPONSIBILITY TO VERIFY PROPER AND RELIABLE OPERATION IN THE ACTUAL APPLICATION. COMPONENT SUBSTITUTION AND PRINTED CIRCUIT BOARD MANUFACTURING VARIATIONS MAY AFFECT CIRCUIT PERFORMANCE OR RELIABILITY. CONTACT LINEAR TECHNOLOGY APPLICATIONS ENGINEERING FOR ASSISTANCE.		PCB DES:	Hz
THIS CIRCUIT IS PROPRIETARY TO LINEAR TECHNOLOGY AND SUPPLIED FOR USE WITH LINEAR TECHNOLOGY PARTS.		APP ENG:	Y1.S.
		SCALE:	NONE
		IC NO.:	N/A
		REV.:	1
		DATE:	Wednesday, December 07, 2011
		SHEET:	3 OF 3

1630 McCarthy Blvd.
Folsom, CA 95635
Phone: (916) 444-0000
Fax: (916) 444-0907
www.linear.com
LTC Confidential-For Customer Use Only

LINEAR TECHNOLOGY

DIGITALLY PROGRAMMABLE DUAL STEP-DOWN DC/DC SUPPLY

LTC3880EIJ FAMILY

DEMO CIRCUIT 1590B

TITLE: SCHEMATIC

DEMO MANUAL DC1590B

DEMONSTRATION BOARD IMPORTANT NOTICE

Linear Technology Corporation (LTC) provides the enclosed product(s) under the following **AS IS** conditions:

This demonstration board (DEMO BOARD) kit being sold or provided by Linear Technology is intended for use for **ENGINEERING DEVELOPMENT OR EVALUATION PURPOSES ONLY** and is not provided by LTC for commercial use. As such, the DEMO BOARD herein may not be complete in terms of required design-, marketing-, and/or manufacturing-related protective considerations, including but not limited to product safety measures typically found in finished commercial goods. As a prototype, this product does not fall within the scope of the European Union directive on electromagnetic compatibility and therefore may or may not meet the technical requirements of the directive, or other regulations.

If this evaluation kit does not meet the specifications recited in the DEMO BOARD manual the kit may be returned within 30 days from the date of delivery for a full refund. **THE FOREGOING WARRANTY IS THE EXCLUSIVE WARRANTY MADE BY THE SELLER TO BUYER AND IS IN LIEU OF ALL OTHER WARRANTIES, EXPRESSED, IMPLIED, OR STATUTORY, INCLUDING ANY WARRANTY OF MERCHANTABILITY OR FITNESS FOR ANY PARTICULAR PURPOSE. EXCEPT TO THE EXTENT OF THIS INDEMNITY, NEITHER PARTY SHALL BE LIABLE TO THE OTHER FOR ANY INDIRECT, SPECIAL, INCIDENTAL, OR CONSEQUENTIAL DAMAGES.**

The user assumes all responsibility and liability for proper and safe handling of the goods. Further, the user releases LTC from all claims arising from the handling or use of the goods. Due to the open construction of the product, it is the user's responsibility to take any and all appropriate precautions with regard to electrostatic discharge. Also be aware that the products herein may not be regulatory compliant or agency certified (FCC, UL, CE, etc.).

No License is granted under any patent right or other intellectual property whatsoever. **LTC assumes no liability for applications assistance, customer product design, software performance, or infringement of patents or any other intellectual property rights of any kind.**

LTC currently services a variety of customers for products around the world, and therefore this transaction **is not exclusive**.

Please read the DEMO BOARD manual prior to handling the product. Persons handling this product must have electronics training and observe good laboratory practice standards. **Common sense is encouraged.**

This notice contains important safety information about temperatures and voltages. For further safety concerns, please contact a LTC application engineer.

Mailing Address:

Linear Technology
1630 McCarthy Blvd.
Milpitas, CA 95035

Copyright © 2004, Linear Technology Corporation