

Evaluation Kit

for 3D Magnetic Sensor

TLV493D-A1B6

3D Magnetic Sensor 2 Go Kit

User's Manual

Rev. 1.1 2016-01

Sense & Control

Table of Contents

1	Introduction	3
1.1	EvalKit content	3
1.2	Software	3
1.3	Magnet heads	4
2	EvalBoard description	5
2.1	Optional external power supply	5
2.2	Pin header connector	6
2.3	EvalBoard Schematic	7
3	Software installation	10
4	3D magnetic sensor evaluation	17
4.1	Application views with the magnet heads	20
5	Revision History	22

Introduction

1 Introduction

Infineon's **3D Magnetic sensor 2 Go** is a compact evaluation kit (EvalKit) to familiarize the user with the 3D magnetic sensor and enable measurements for product evaluations. The EvalKit contains all the required hardware. The software can be downloaded free of charge at the Infineon web.

This user's manual defines the different parts of the EvalKit, describes the software installation process and clarifies how the Graphical User Interface (GUI) has to be used to take measurements.

This user's manual is meant for the software version v 2.0.1 which is compatible with the EvalBoard versions starting from V 2.0 upwards.

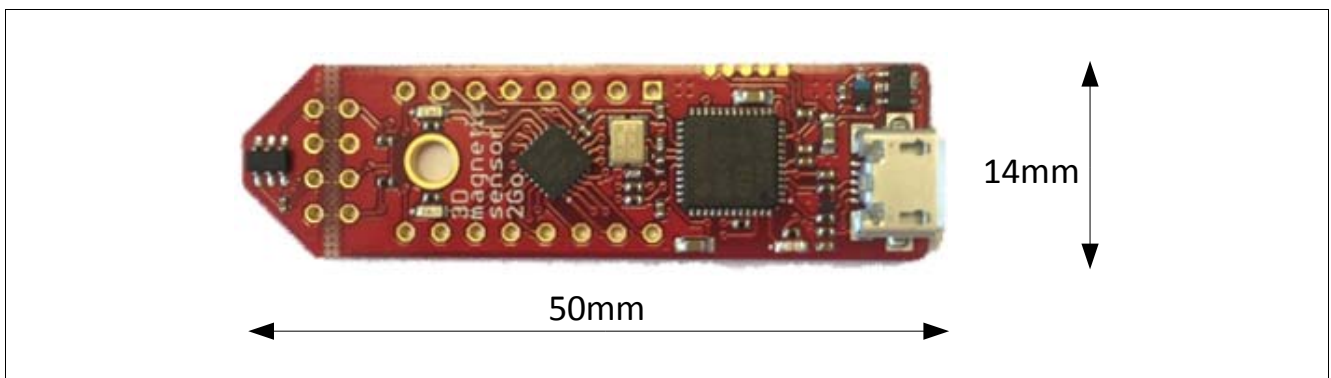

Figure 1 3D Magnetic sensor 2 Go EvalBoard

1.1 EvalKit content

The evaluation kit (EvalKit) contains:

- The 3D evaluation board (EvalBoard); a ready-to-use printed circuit board (PCB) with the 3D sensor.
- A standalone magnet.

The EvalKit references for ordering are provided in [Table 1](#).

To use the EvalKit the user has to acquire a USB cable with a micro USB connection-end for the EvalBoard side and a conventional USB connection for the PC side.

1.2 Software

The required software to run the 3D Magnetic sensor 2 Go EvalBoard can be found at the Infineon site under <http://www.infineon.com/sensors2go> by clicking at "3D Magnetic Sensor 2GO".

The software package contains:

- Graphical User Interface (GUI) to be installed on the PC for user evaluation.
- Firmware to be flashed into the microcontroller to enable communication with the 3D sensor.
- USB driver J-Link from Segger to enable connection between PC and EvalBoard.

This software was designed to be used with Windows 7 and it is compatible with both 32-bit and 64-bit system types. It has also been used with Windows 10 at 64 bits. Other versions may also work, but have not been tested.

The USB protocols capabilities are defined by the Segger driver. Versions USB 2.0 and USB 3.0 should be compatible.

Introduction

The software version v 2.0.1 can be used in EvalBoard versions starting from V 2.0 upwards. The software version v 1.0 was for the first EvalBoard version V 1.0, which is no longer supported. An overview of the EvalBoard and Software versions compatibility can be found in [Table 1](#).

The software **Infineon 3D Magnetic Sensor 2 Go** will be used to enable a communication between the sensor and to set the different possible modes. In those modes the update rate of the magnetic field measured (X, Y and Z components) and current consumption vary. The modes can be changed in the GUI with a menu, providing the bytes for proper sensor configuration.

The hardware is based on the XMC2Go-Kit. More technical documents and detailed description you can find at <http://www.infineon.com/xmc2go>.

1.3 Magnet heads

As described in [Chapter 1.1](#), a standalone magnet is provided with the EvalKit. This can be manually placed to a desired position and carry 3D measurements.

In addition, Infineon offers magnet heads which can be mounted on the EvalBoard. Two magnet heads are currently available and can be ordered separately:

- Joystick
- Rotate knob (rotate and push button control element)



Figure 2 Magnet heads for the 3D Magnetic sensor 2 Go EvalBoard

Table 1 EvalKit ordering code

EvalKit version	SP Number	Software version
V 1.0	No longer supported	v 1.0
V 2.0	Small modification lead to V 3.0	v 2.0.1
V 3.0	SP001353754	v 2.0.1

Table 2 Magnet heads ordering code

Magnet head for 3D 2 Go EvalBoard	SP Number
Joystick for 3D 2 Go EvalBoard	SP001491834
Rotate knob for 3D 2 Go EvalBoard	SP001504602

EvalBoard description

2 EvalBoard description

The evaluation board (EvalBoard) is a ready-to-use printed circuit board (PCB) which contains:

- 3D magnetic sensor (TLV493D-A1B6 or other model depending on the order code)
- XMC1100 microcontroller based on ARM Cortex™-M0 at 48MHz frequency connected to the 3D sensor.
- XMC4200 microcontroller based on ARM Cortex™-M4 at 144MHz frequency used for the debugging and the USB communication.
- Micro USB connector for power supply and communication with the Graphical User Interface (GUI).
- LED for indication of power supply and debugging.
- Two LEDs for user configuration.
- Voltage regulator, reverse current protection diode and ESD protection diode.
- Pin Headers to access data lines (e.g. via oscilloscope, external microcontroller).

The different components and its location are shown in **Figure 3**. The 3D magnetic sensor can be separated from the rest of the EvalBoard by cutting the break line.

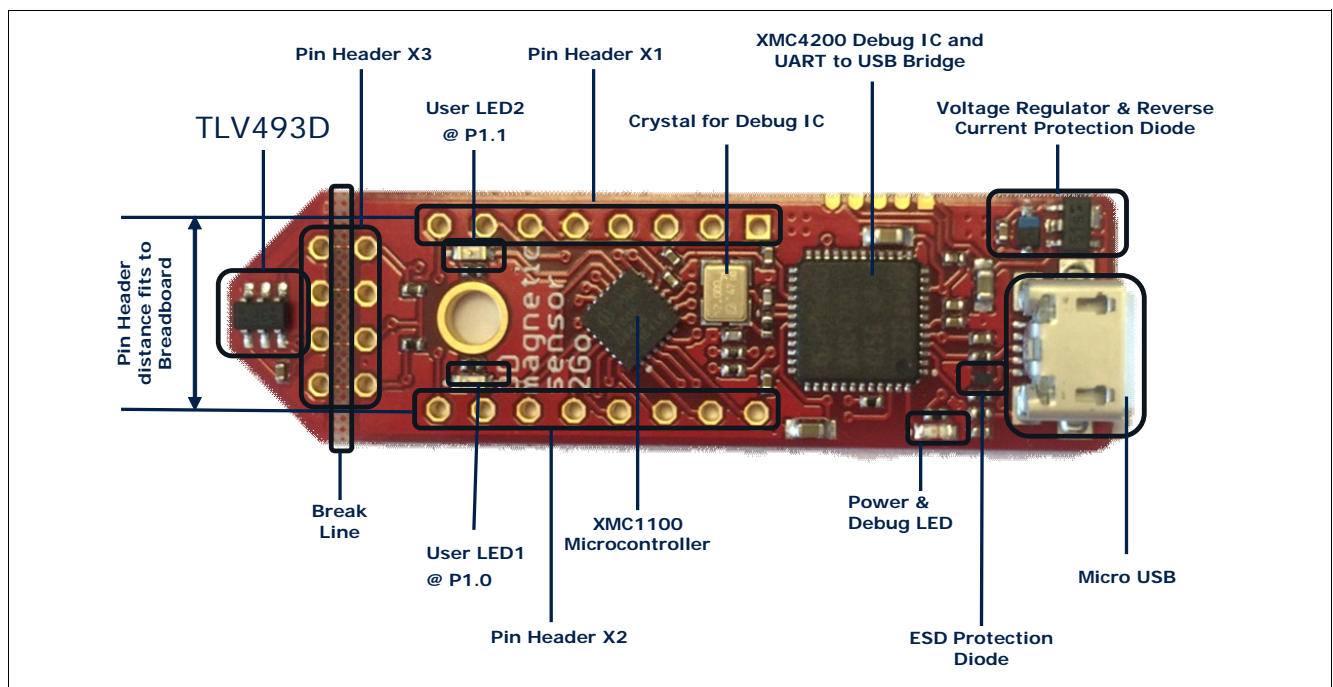

Figure 3 EvalBoard and its components

2.1 Optional external power supply

The 3D Magnetic Sensor 2 Go EvalBoard is supplied via the USB cable. It is also possible to provide an external power supply. If this is the case, a few considerations must be taken into account as described below.

The 3D Magnetic Sensor 2 Go EvalBoard must be supplied by external 5 Volt DC power supply connected to the micro USB plug. The voltage regulator shifts the voltage level to 3.3V for the microcontrollers and the 3D magnetic sensor. The Power & Debug LED indicates that the presence of the generated 3.3V supply voltage.

Out of the box with the pre-programmed application and the on-board debugger in operation the EvalBoard typically draws about 75 mA. This current can be delivered via the USB plug of a PC, which is specified to deliver up to 500 mA. An on-board reverse current protection diode will ensure safe operation and protects the USB port of the Laptop/PC in case power is provided through the pin header X1.

EvalBoard description

It is not recommended to apply an additional power supply to the V_{DD} pin of X1 (3.3V) when the board is powered via USB, because the 3.3V supply could drive against the on-board power supply. The V_{DD} pin can be used to power an external circuit. But care must be taken not to draw more current than 150mA, which is the maximum current the on-board voltage regulator can deliver. After power-up the Debug LED starts blinking. In case there is connection to a PC via the Debug USB plug and the USB Debug Device drivers are installed on this PC, the Debug LED will turn from blinking to constant illumination.

2.2 Pin header connector

The pin headers X1 and X2 can be used to extend the evaluation board or to perform measurements on the XMC1100. The order of pins available at X1 and X2 corresponds to the pinning schema of the XMC1100 Microcontroller in the TSSOP-16 pin package. The pinning table is also printed onto the bottom side of the PCB (depending on the version). The pin header X3 can be used to access directly the 3D magnetic sensor pins.

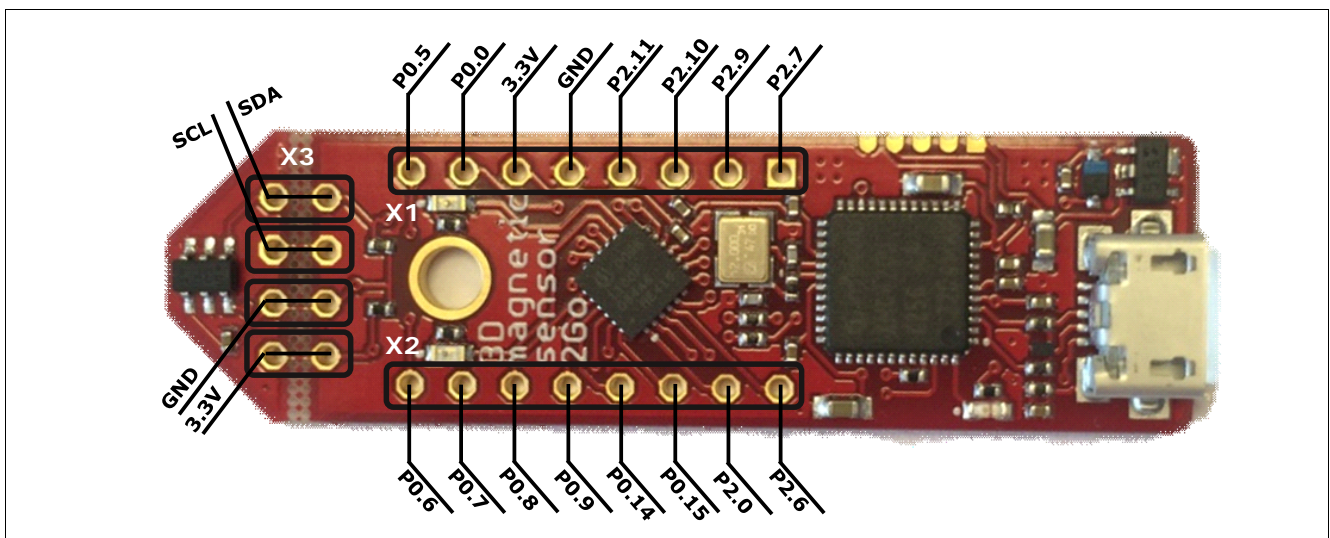

Figure 4 EvalBoard pin header connectors

The different 3D sensor pins can be accessed via the pin headers in the EvalBoard as shown in [Table 3](#).

Table 3 Pin headers description for the 3D magnetic sensor

3D sensor pin No.	Name	Pin header / port	Description 3D magnetic sensor
1	SCL	P2.11	Interface serial clock pin (input)
3	GND	GND	Ground pin
4	V_{DD}	3.3V	Supply pin
6	SDA	P2.10	Interface serial data pin (input/output), open drain

The XMC1100 port pins P1.0 and P1.1 are exclusively connected to LEDs, and not to pin headers.

Table 4 Pins Used for the User LEDs

LED	Port pin
LED1	P1.0
LED2	P1.1

EvalBoard description

2.3 EvalBoard Schematic

Schematics of the different blocks from the EvalBoard are provided in case further details are required. The 3D magnetic sensor user can also re-use these schematics to design customized PCBs for evaluation purposes. The user (integrator) is responsible for the correct functioning on system level as well as for the validation and testing.

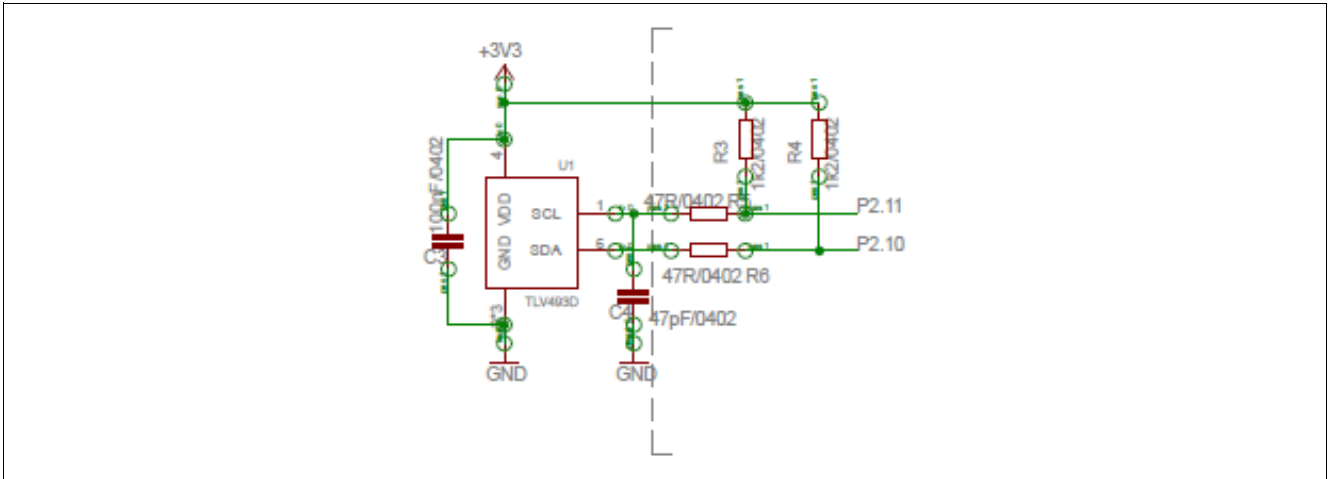

Figure 5 EvalBoard schematic: 3D magnetic sensor

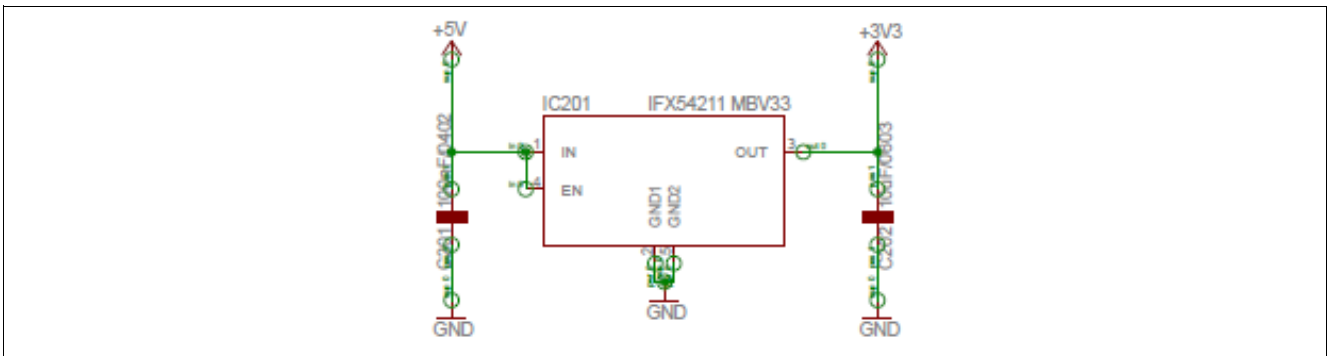

Figure 6 EvalBoard schematic: the voltage regulator (for the power supply)

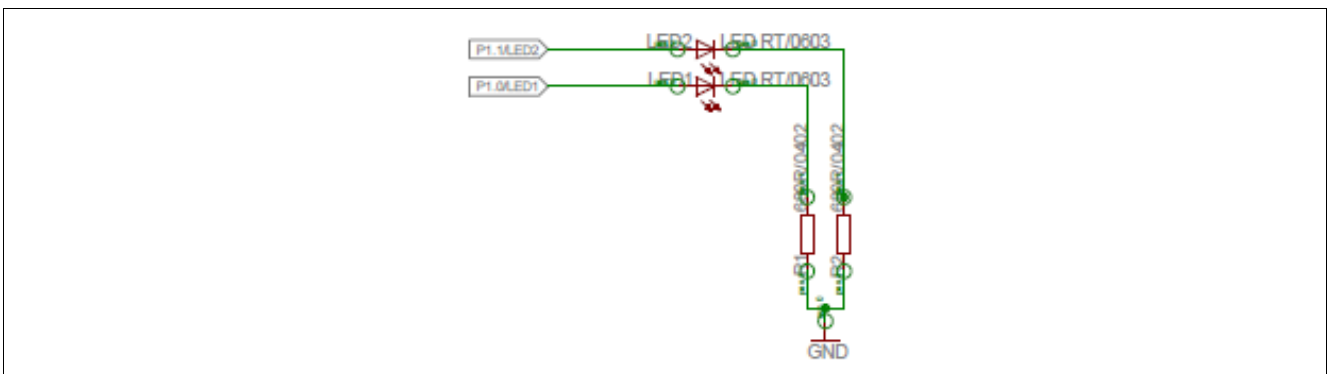

Figure 7 EvalBoard schematic: the LEDs for user configuration (connected to XMC1100 pins)

EvalBoard description

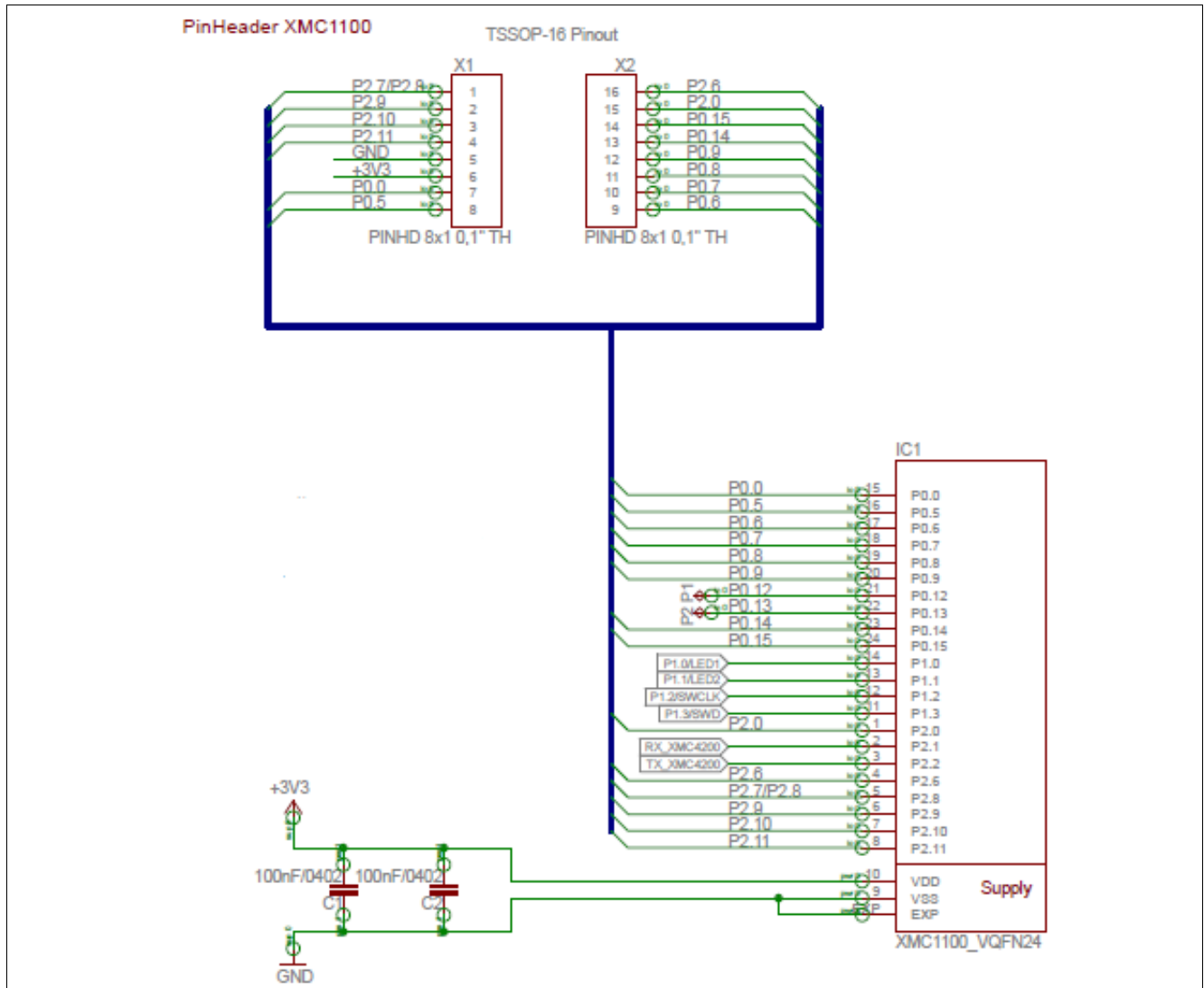

Figure 8 EvalBoard schematic: the XMC1100 microcontroller and pin headers

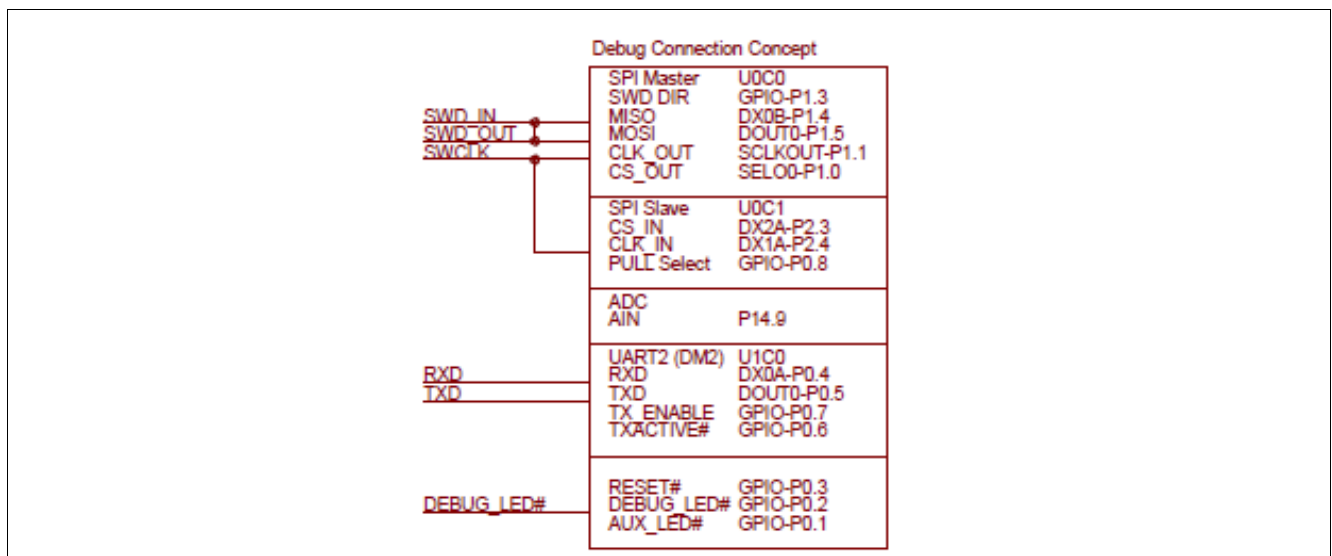

Figure 9 EvalBoard schematic: the Debug connection

Software installation

3 Software installation

In this chapter the installation of the software will be described. Make sure to have administration rights on your PC before starting the installation.

Step 1: Enter the Infineon web to access the software. The link to the software is mentioned in **Chapter 1.2**, the web looks like in **Figure 11**. Double click to the software link to start the download.

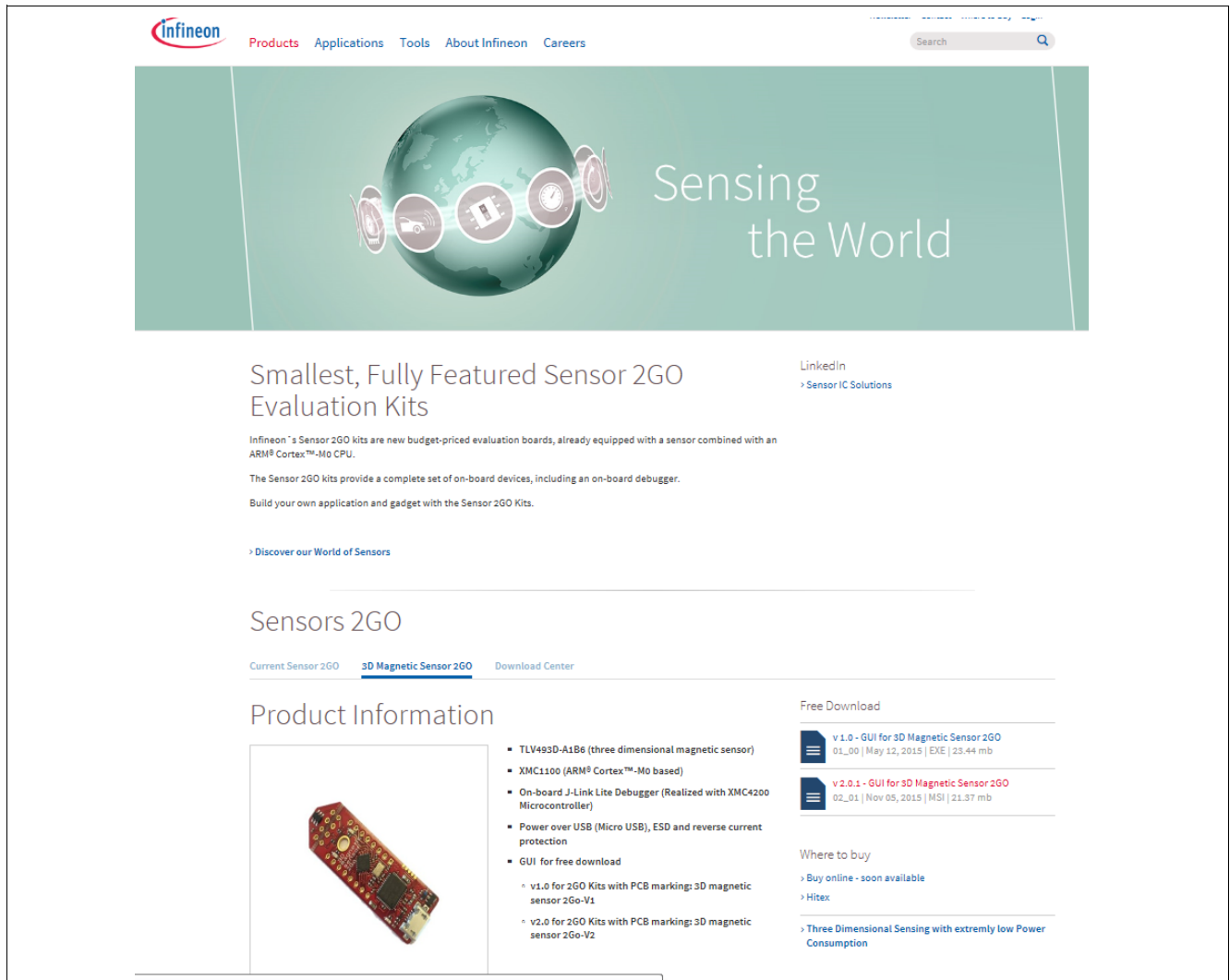

Figure 11 Download “3D Magnetic Sensor 2 Go” software

Step 2: Save the file in your computer.



Figure 12 Save the software

Software installation

Step 3: Open the folder where the software was saved. Double click the .msi icon and the screen from **Figure 13** will appear. Click “Next”.

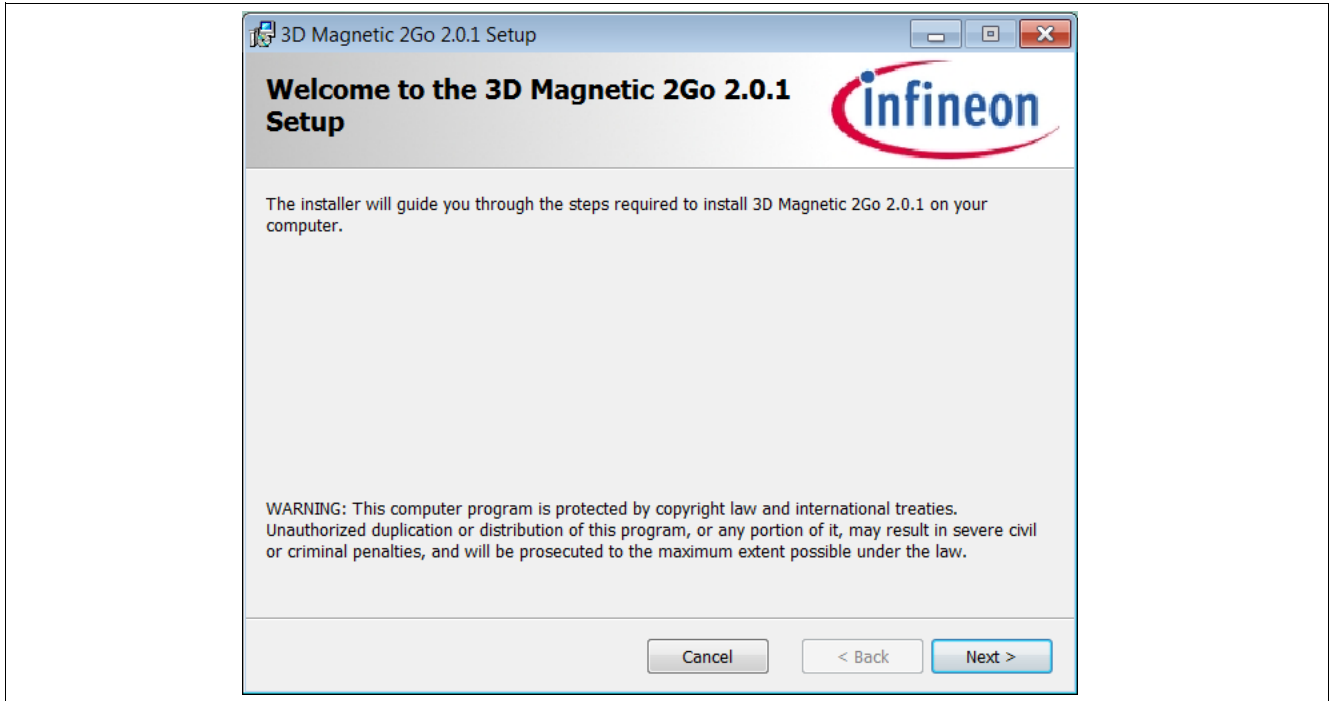

Figure 13 Start software installation

Step 4: Read the license agreement and tick the box to accept the terms. It is also possible to print the license agreement. Click “Next” to continue with the installation.

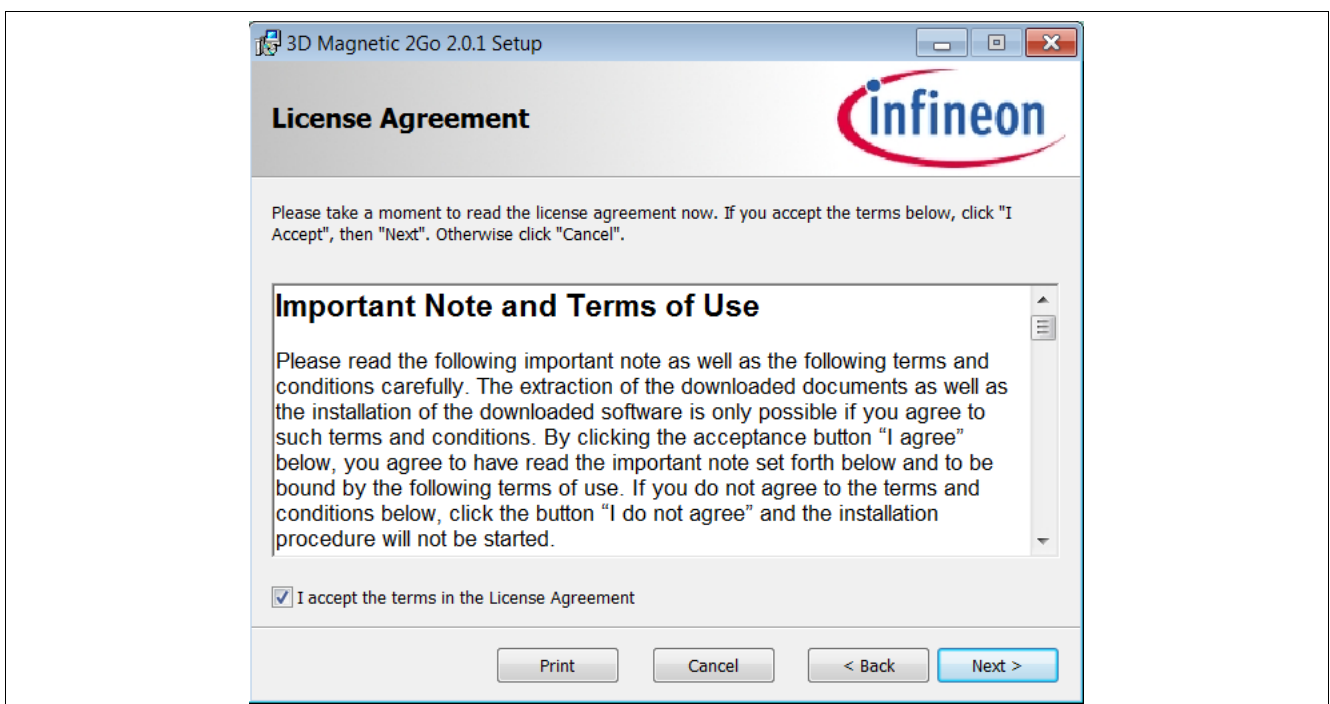

Figure 14 Accept license agreement

Software installation

Step 5: Select the folder where the software should be installed. It is recommended to use the default folder suggested by the system.

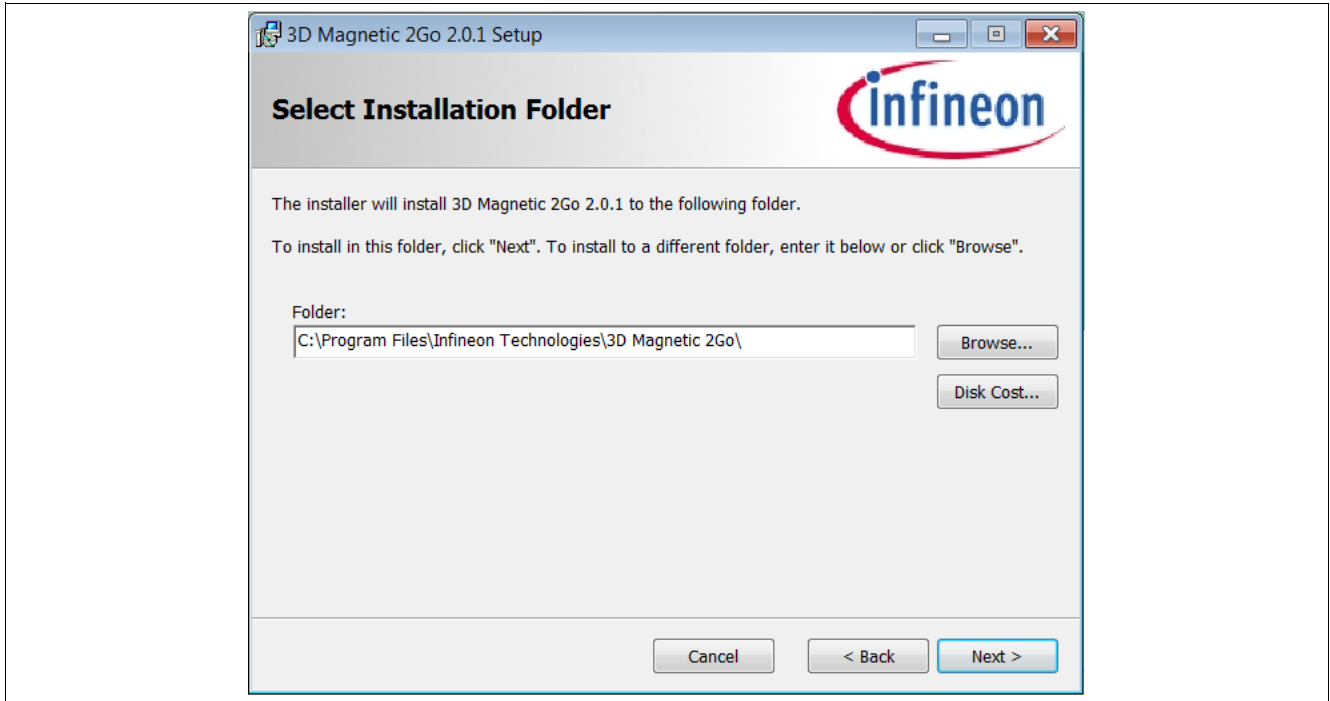

Figure 15 Select installation folder

Step 6: Confirm installation

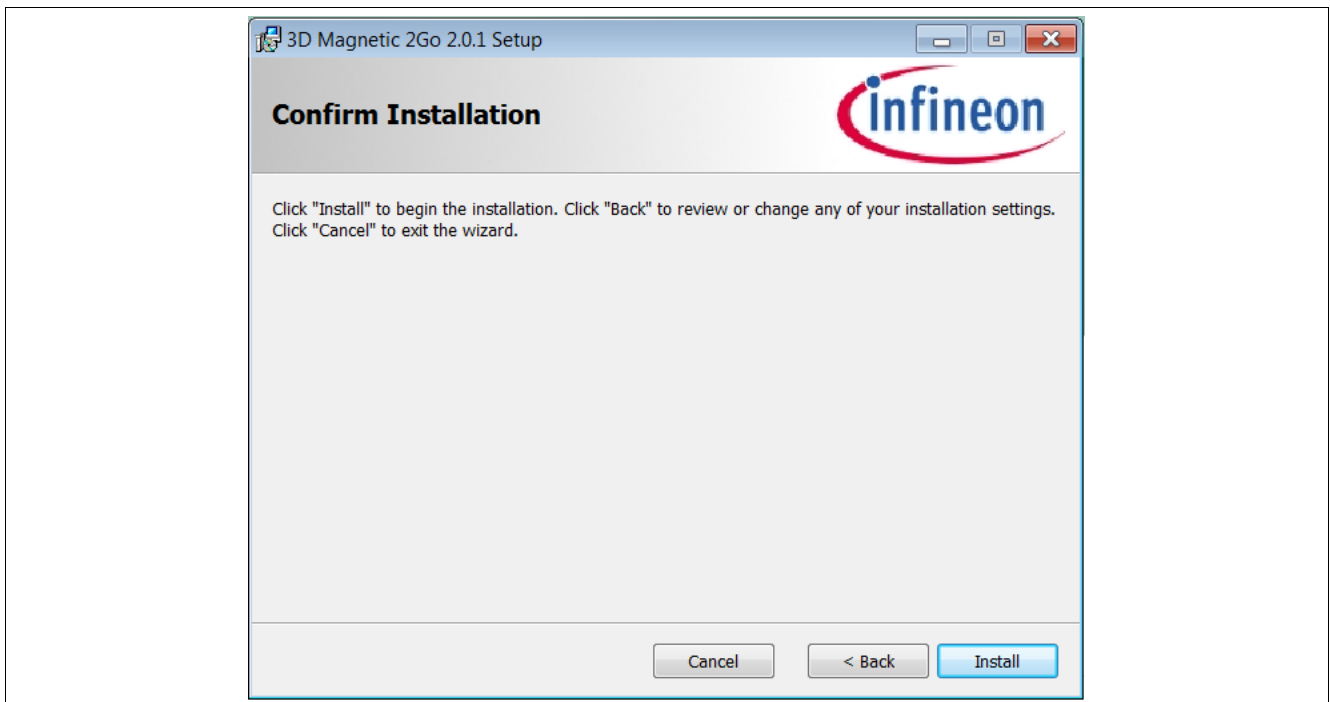

Figure 16 confirm installation

Software installation

Step 7: The setup for the installation is complete.

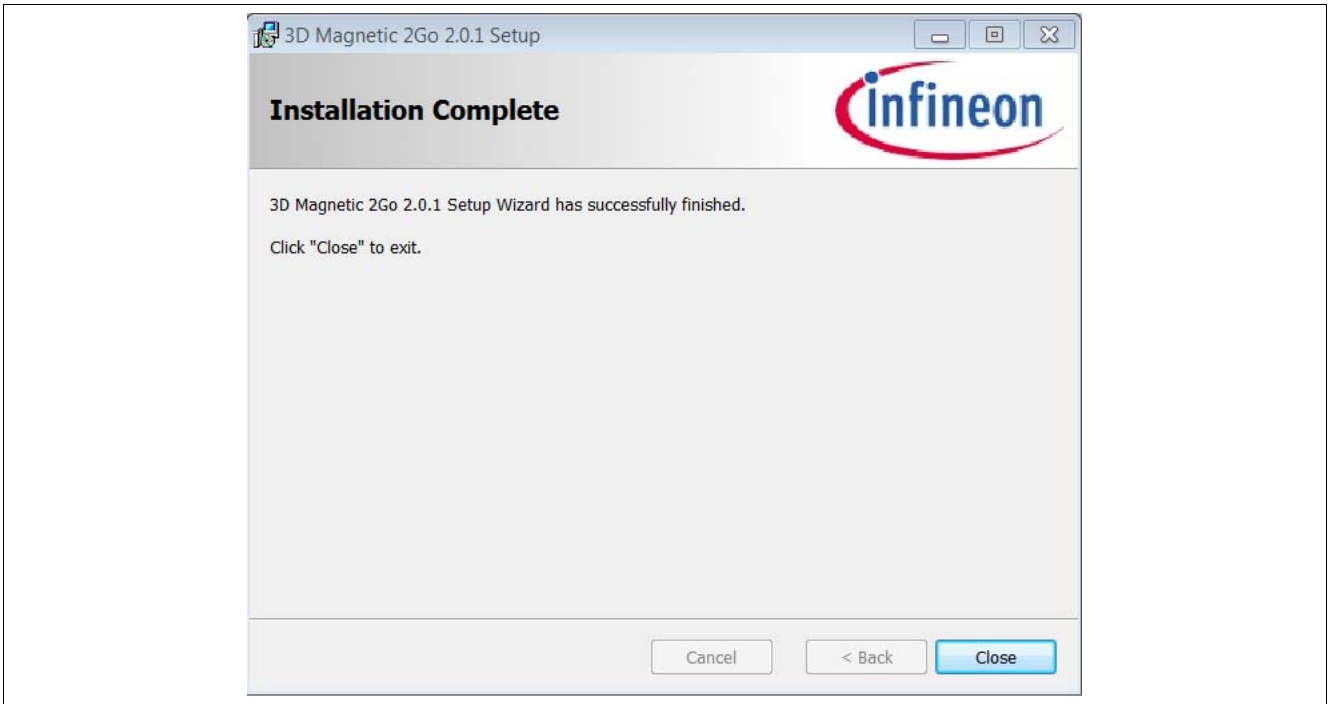

Figure 17 Setup Wizard completed

The 3D Magnetic 2Go Graphical User Interface (GUI) is successfully installed. A shortcut to the GUI can be found in the Windows Start menu. Still, before using it the software installation must continue, since a USB driver has to be installed as well.

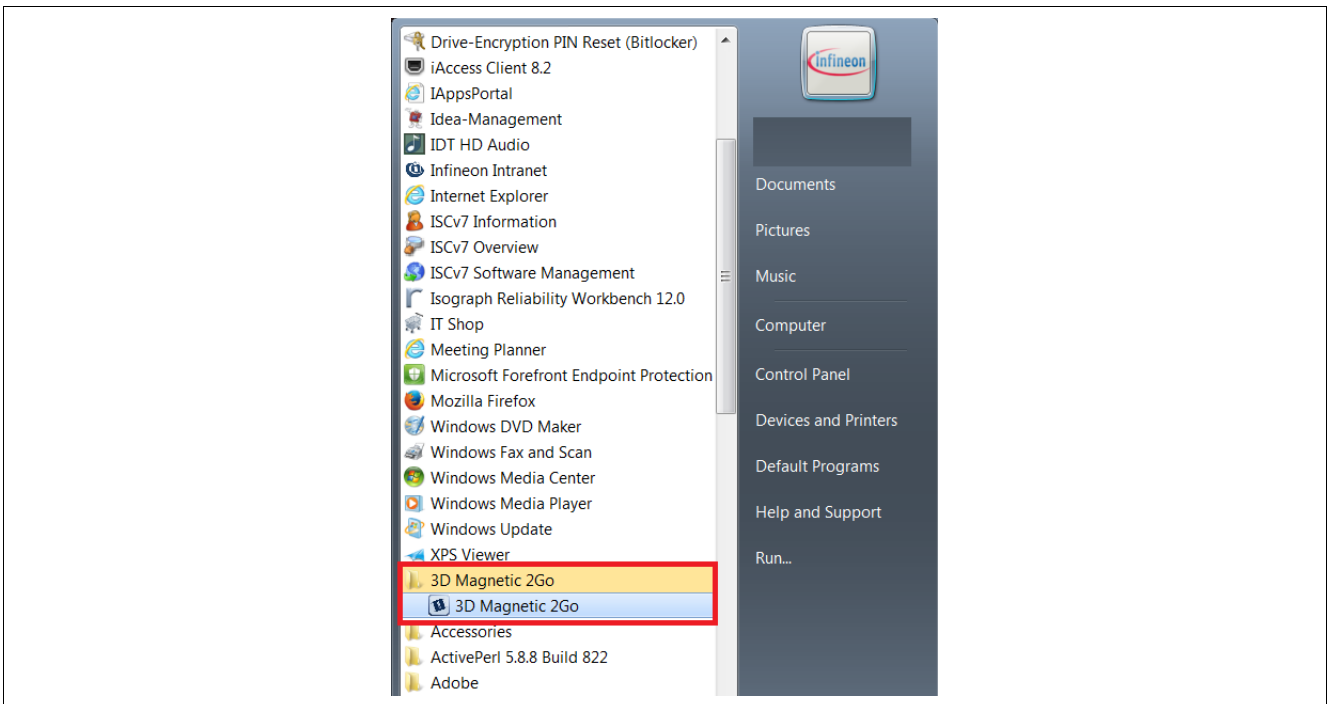

Figure 18 Shortcut to the 3D Magnetic 2Go GUI

Software installation

Step 8: Start the installation of the required USB driver from Segger. The window shown in **Figure 19** is automatically opened.



Figure 19 Driver installation

Step 9: Read the license agreement of the driver and click “I Agree” to accept the terms.

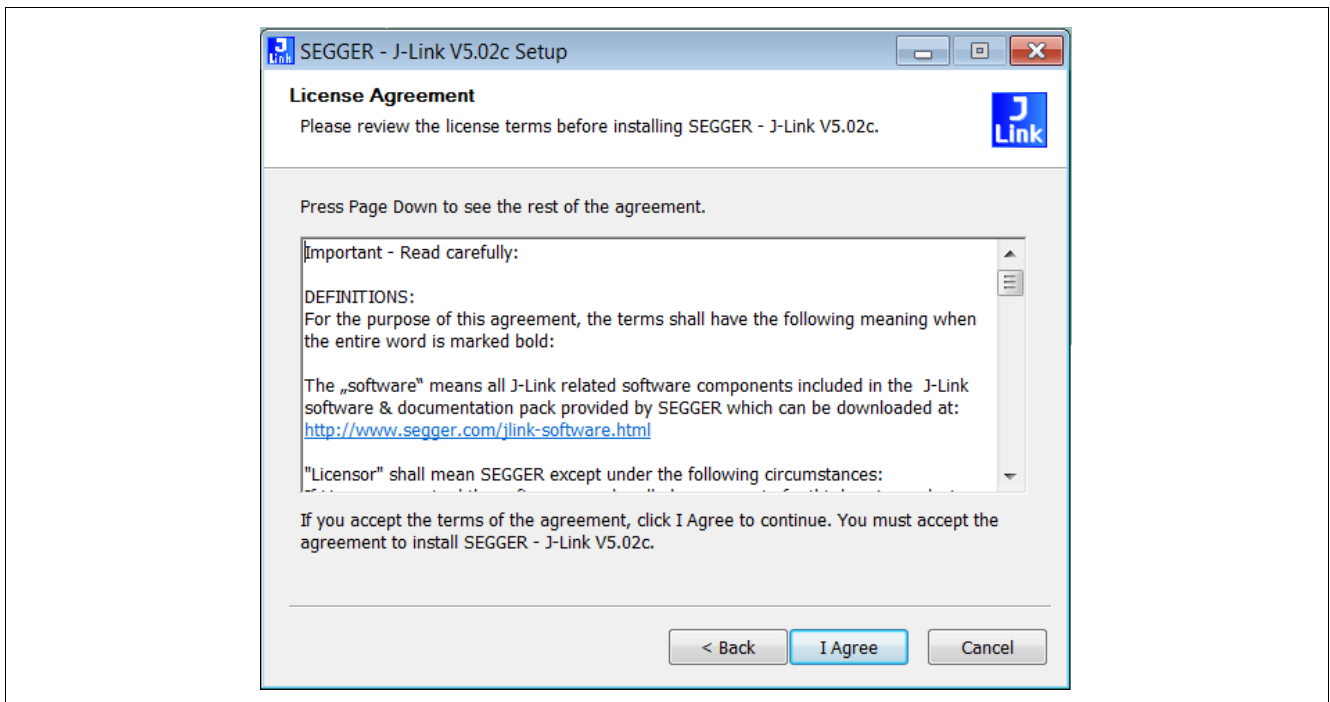

Figure 20 Accept the driver’s license agreement

Software installation

Step 10: Install the USB Driver for J-Link (box by default ticked). By default a shortcut to the driver will be created (“Create entry in start menu”). This can be unticked if desired by the user.

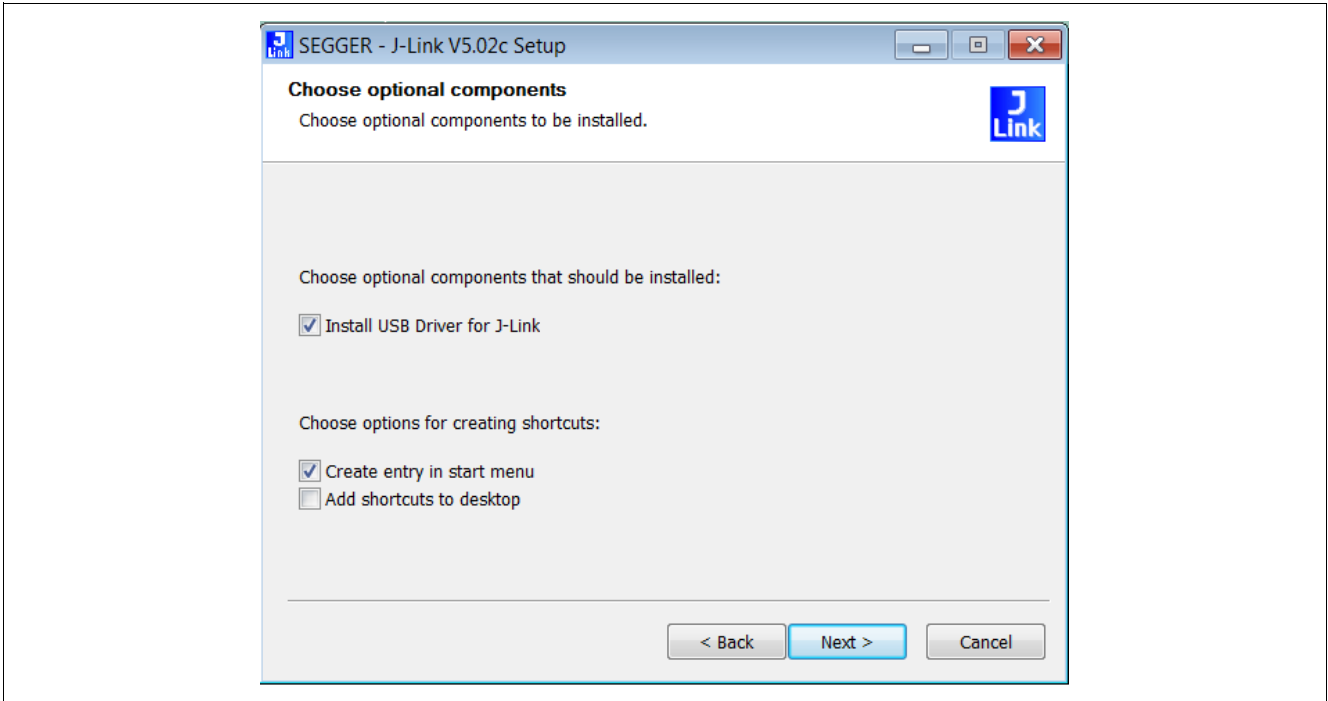

Figure 21 Accept the driver’s license agreement

Step 11: Select the folder where the driver should be installed. It is recommended to use the default folder suggested by the system.

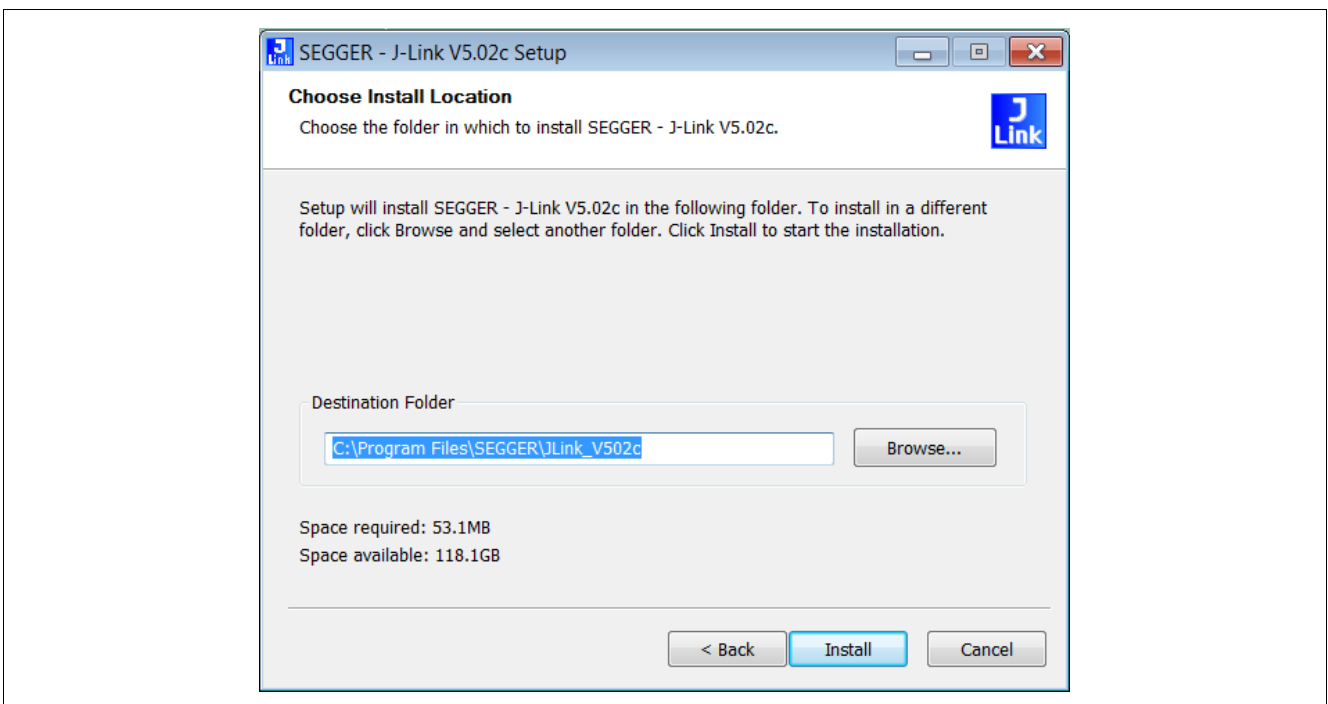

Figure 22 Select driver’s installation folder

Software installation

Step 12: Click “Ok” for the J-Link DLL.

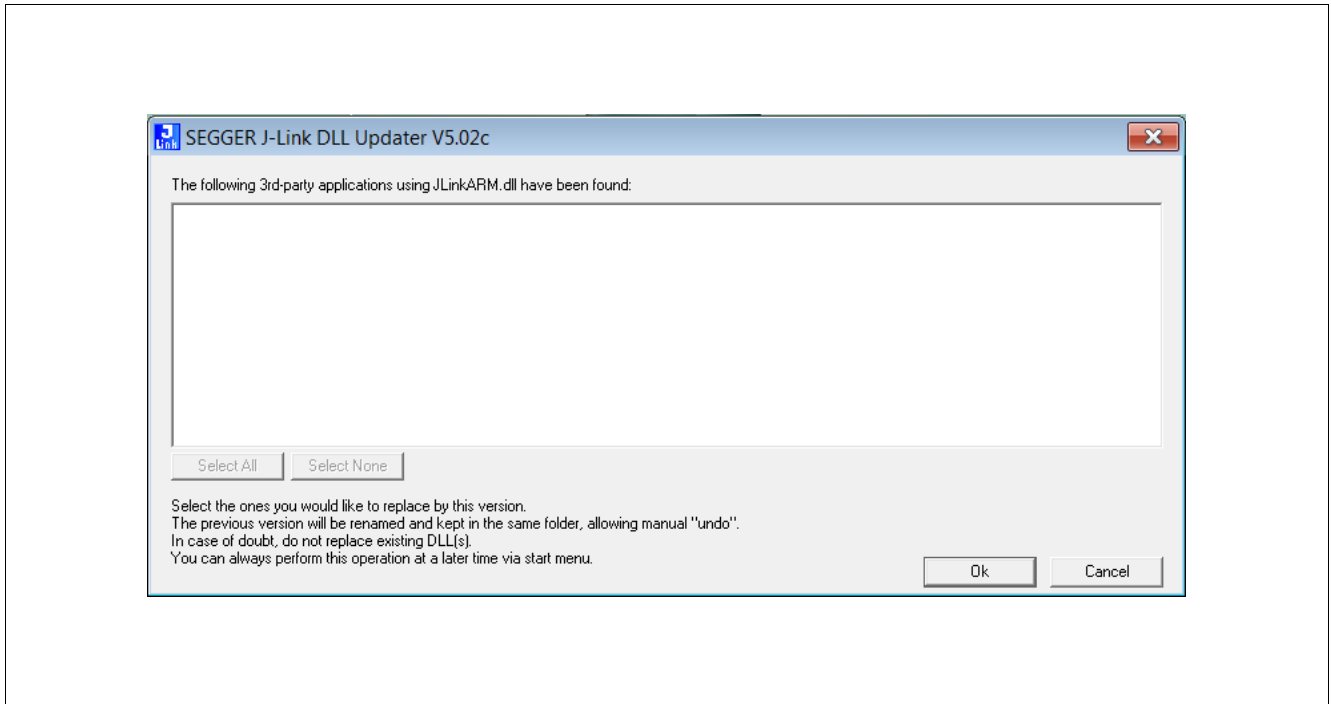

Figure 23 Accept DLL

Step 13: USB driver installation completed



Figure 24 USB driver installation completed

3D magnetic sensor evaluation

4 3D magnetic sensor evaluation

This chapter details how to use the Graphical User Interface (GUI) to start the 3D magnetic sensor evaluation.

Step 1: Connect the EvalBoard to the PC via the USB cable. Use the Micro USB port for the EvalBoard and USB port for the PC. A LED in the EvalBoard will switch on indicating the EvalBoard is supplied with enough power.

Step 2: Open the 3D Magnetic 2Go GUI by clicking the shortcut in the start menu as shown previously in [Figure 18](#). On the top left side click “Flash MCU”. A sub-menu with the option “Flash” appear. Click “Flash” to flash the microcontroller firmware required to run the 3D sensor. The LED blinks while the firmware is being flashed. Flashing the firmware is only required the first time that an EvalBoard is used.

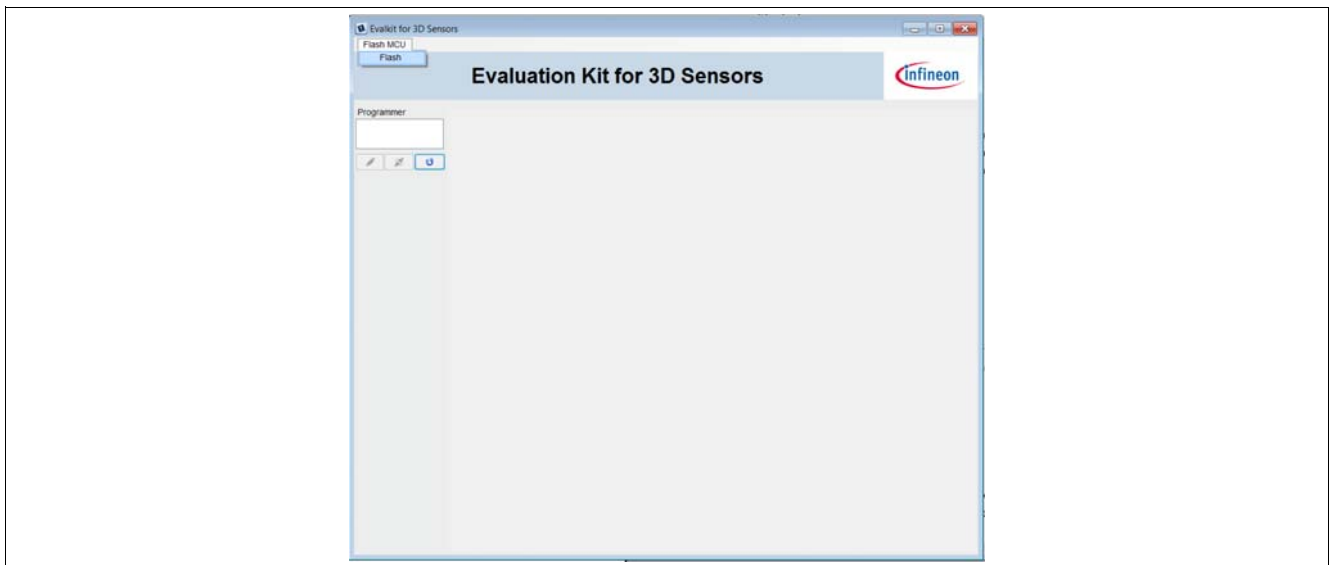

Figure 25 Flash the firmware

Step 3: Once the firmware has been flashed a programmer (the EvalBoard) will appear in the list. If this is not the case click the “Refresh” button (the curved arrow placed on the right bottom corner of the “Programmer” box). Once the programmer has been selected click the “Connect” button (placed on the left bottom corner of the “Programmer” box). The connection between PC and EvalBoard has now been established.

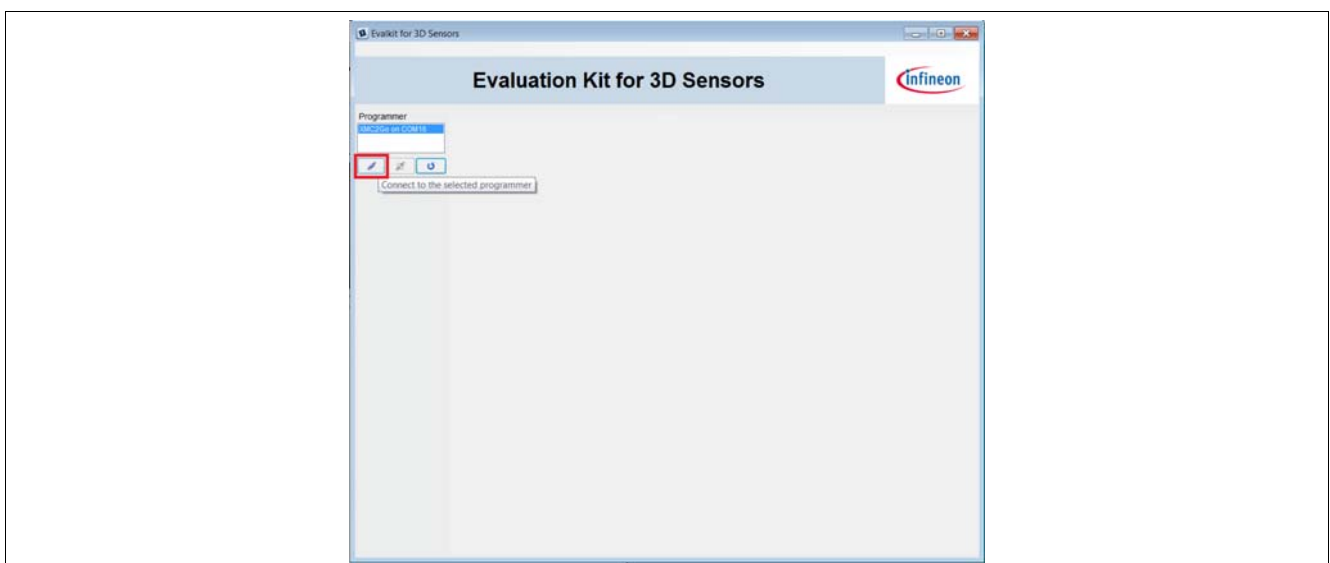

Figure 26 Connect to the EvalBoard

3D magnetic sensor evaluation

Step 4: Select the sensor to evaluate.

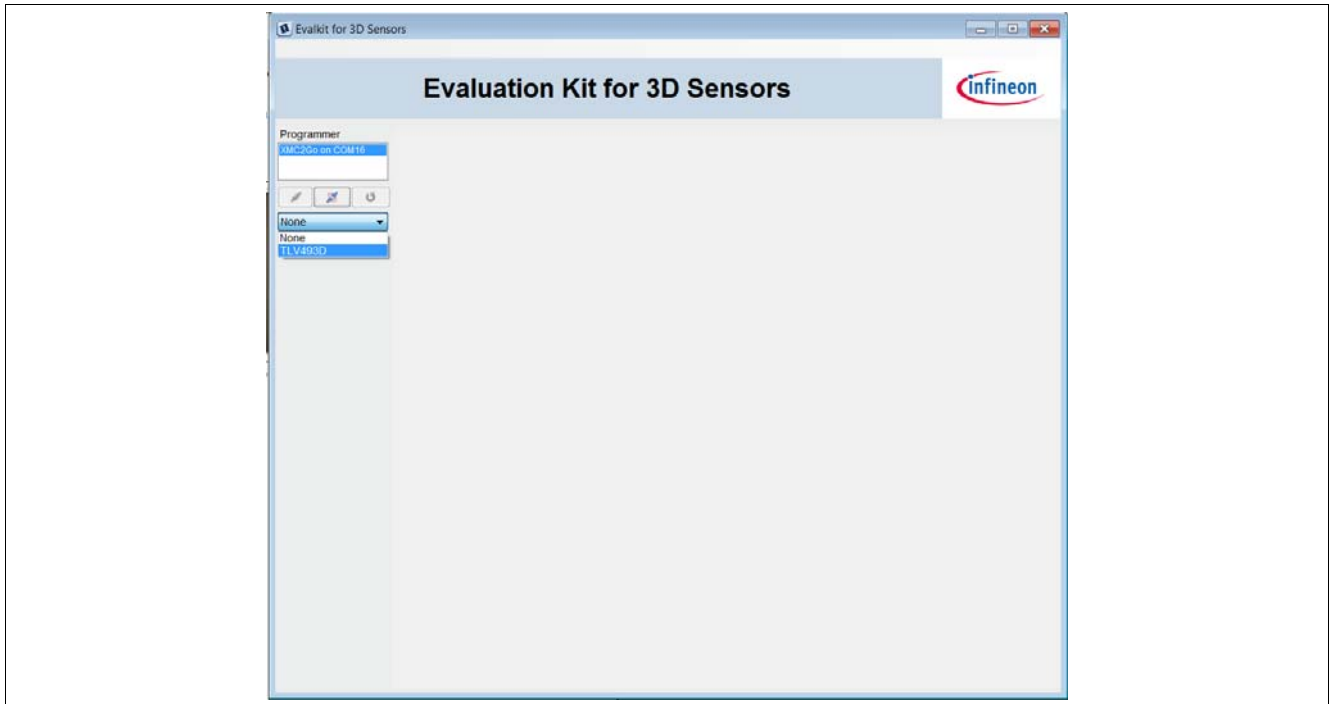

Figure 27 3D sensor selection

Step 5: Select the 3D configuration on the menu on the left-hand side. As the TLV493D has been selected in the previous step, the default mode is power-down. In power-down mode no measurements are taken. Therefore the user can select the ultra low power mode, the low power mode, the fast mode or the master controlled mode. After selecting the mode, click “Start” to start measurements.

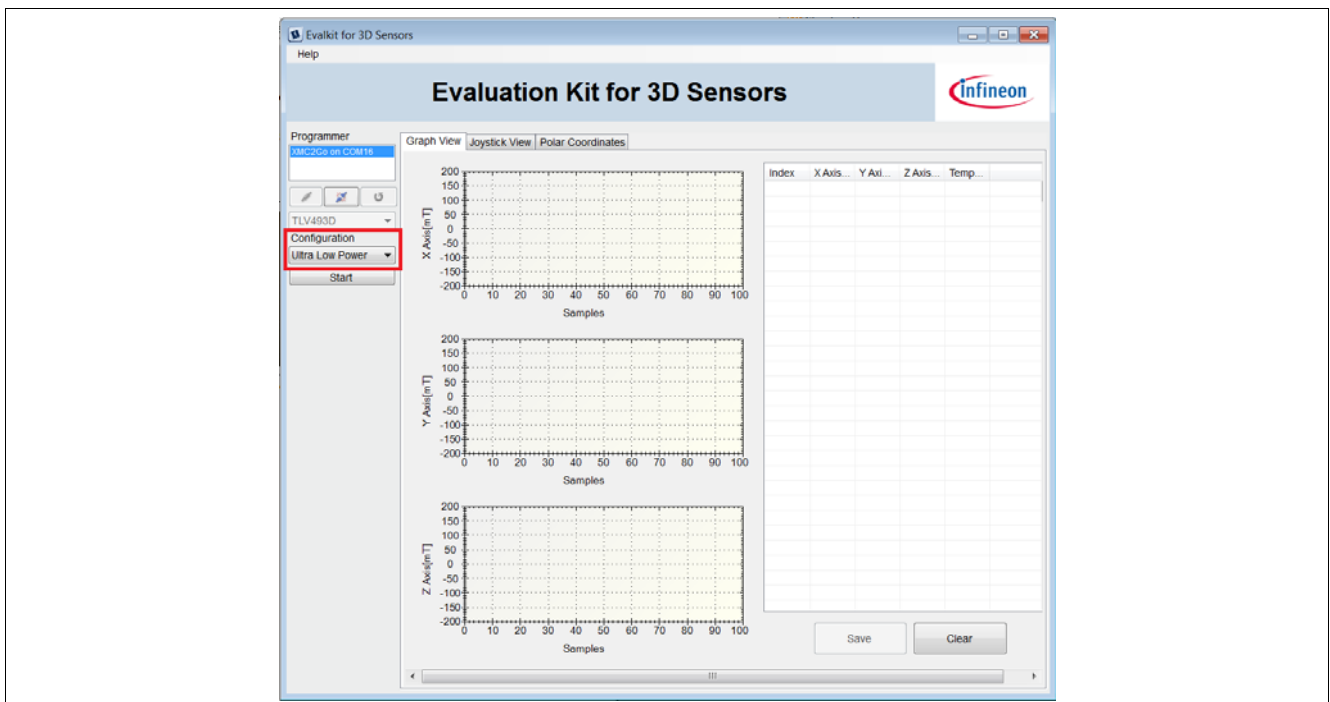

Figure 28 Select 3D configuration

3D magnetic sensor evaluation

Step 6: The X, Y and Z values will be plotted in three separate graphs. The Y-axis of these graphs represents the magnetic field from -200mT to 200mT. On the X-axis each sample is plotted. Additionally a table is provided with the X, Y, Z and Temperature values. This table can be saved for further evaluations by clicking “Save” on the bottom of the table. Be aware that for the fast mode, no temperature values are provided in the GUI (although by default the 3D magnetic sensor does take temperature measurements).

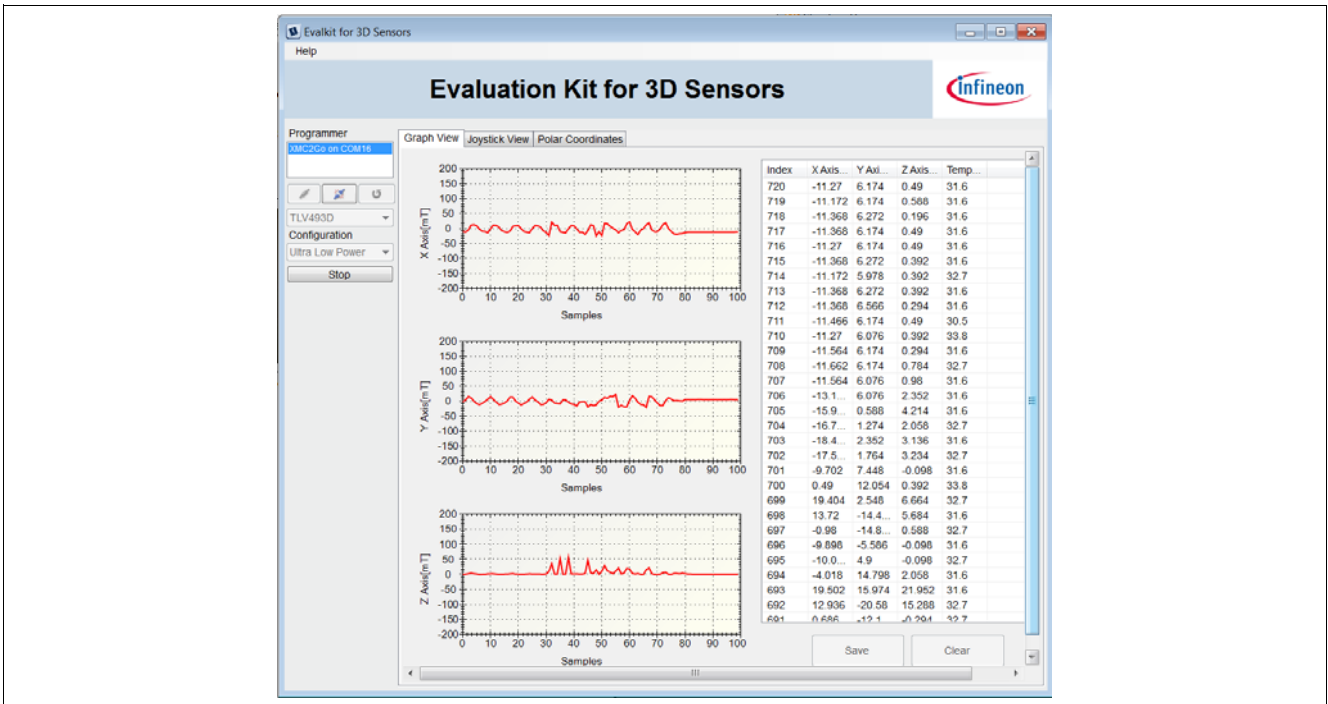

Figure 29 3D measurements

Step 7: If a new mode wants to be evaluated click “Stop” on the left side. “Save” the data and “Clear” it. Select a new configuration and press “Start” again.

3D magnetic sensor evaluation

4.1 Application views with the magnet heads

Additional views representing real case applications can also be visualized. These views are purely graphical. The magnet heads mentioned in [Chapter 1.3](#) can be used for this purpose.

In the “Joystick View” a 3D space will be represented with a stick in it. As a magnet moves in any direction around the 3D magnetic sensor EvalBoard, so will the stick.

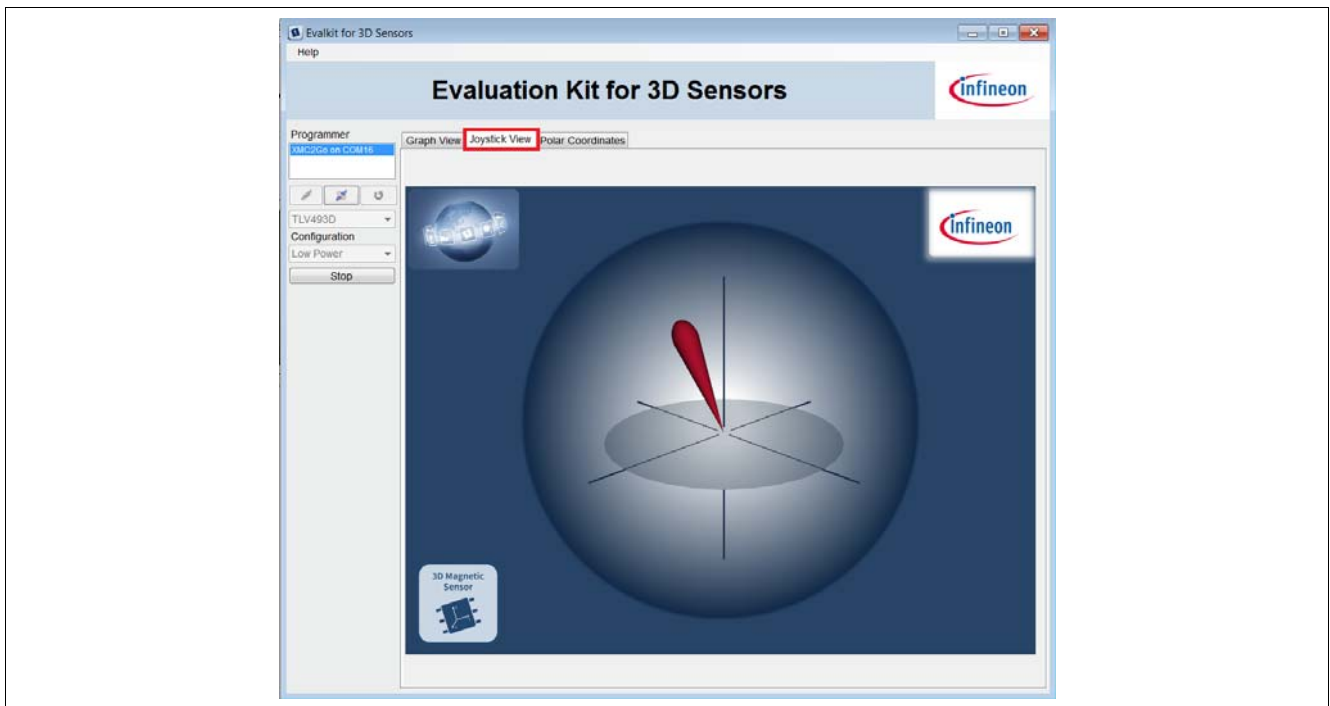

Figure 30 Joystick View

The magnet used in the Joystick magnet head is an axial magnetized magnet. The magnet material is ferrite, of class Y35, which is equivalent to a remanence of between 400 and 410mT. The magnet disk has a size of 5mm diameter and 5mm thickness.

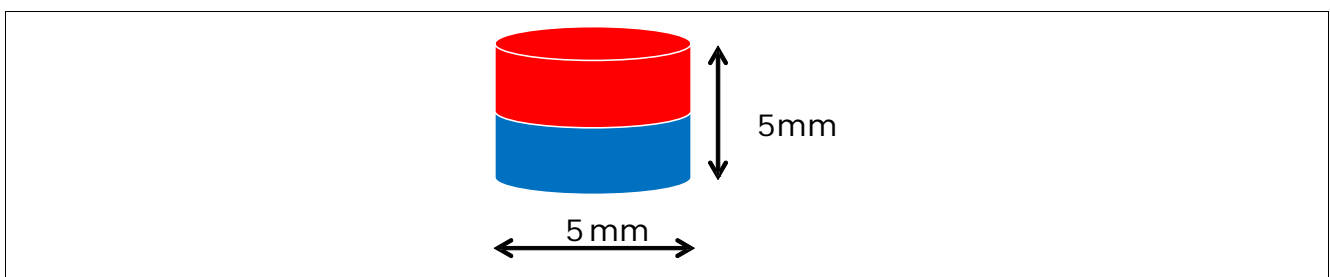

Figure 31 Magnet used in the Joystick magnet head

3D magnetic sensor evaluation

In the “Polar Coordinates” a rotate knob will be represented. The knob is a control element with which the user can do two kind of movements: turn it (clockwise or counterclockwise) and push it.

When the user turns the knobs, the 3D magnetic sensor measures the X and Y magnetic field components to which can be used to determine the position through 360° degrees, therefore the 3D magnetic sensor is used to detect a rotation movement. When this happens the white stripe on the knob represented on the GUI will turn accordingly to the knob from the magnet head.

When the user pushes the knob, the 3D magnetic sensor measures the Z magnetic field component, therefore a linear movement is detected. The ring around the knob represented on the GUI will change colour.

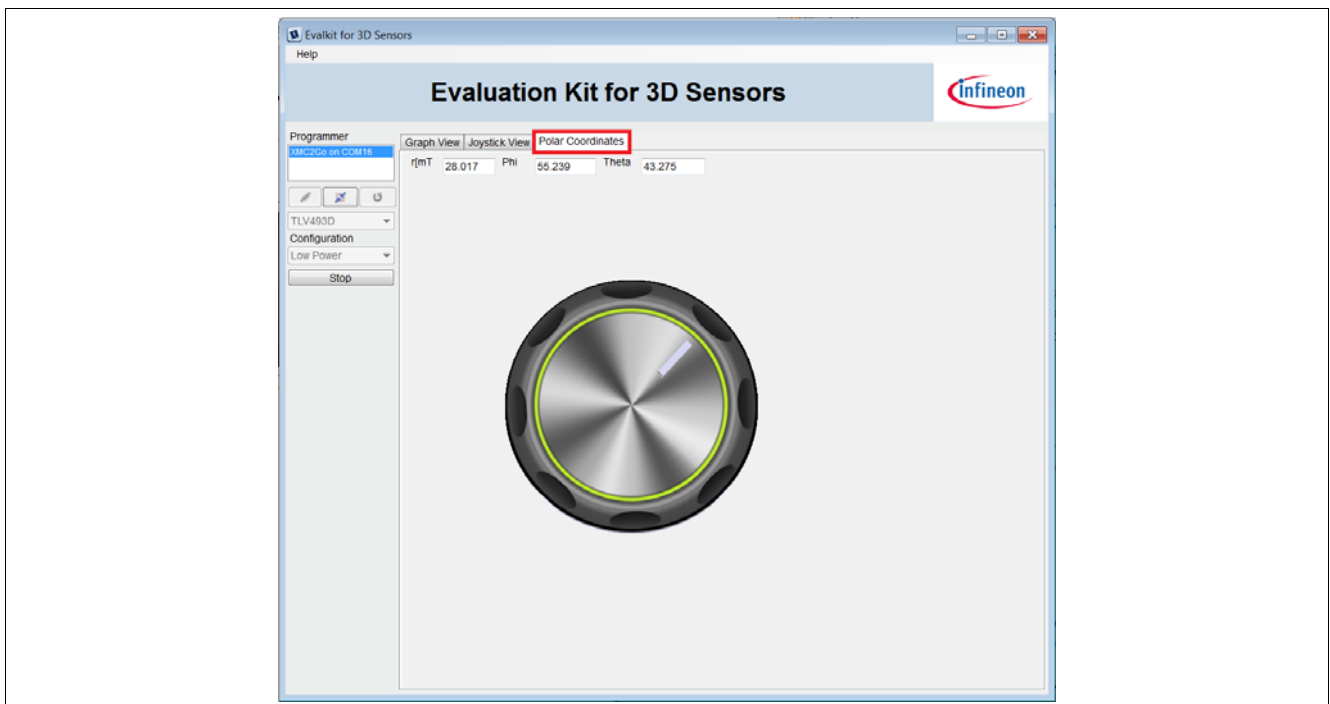

Figure 32 Polar Coordinates

The magnet used in the Rotate Knob magnet head is a diametrically magnetized magnet. The magnet material is Neodymium Iron Boron (NdFeB) of class N45. The magnet is protected against corrosion with Nickel coating (Ni-Cu-Ni). The magnet size is 4mm diameter and 10mm thickness.

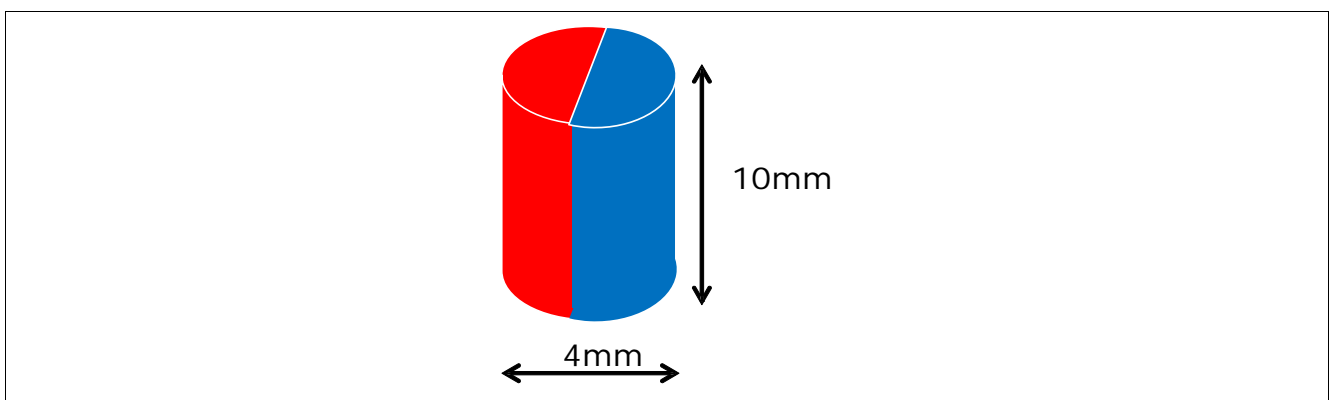

Figure 33 Magnet used in the Rotate Knob magnet head

Revision History

5 Revision History

Revision	Date	Changes
1.0	2015-05	Initial version
1.1	2016-01	New version based on GUI version 2.0.1

Trademarks of Infineon Technologies AG

AURIX™, C166™, CanPAK™, CIPOS™, CoolGaN™, CoolMOS™, CoolSET™, CoolSiC™, CORECONTROL™, CROSSAVE™, DAVE™, DI-POL™, DrBLADE™, EasyPIM™, EconoBRIDGE™, EconoDUAL™, EconoPACK™, EconoPIM™, EiceDRIVER™, eupec™, FCOS™, HITFET™, HybridPACK™, Infineon™, ISOFACE™, IsoPACK™, i-Wafer™, MIPAQ™, ModSTACK™, my-d™, NovalithIC™, OmniTune™, OPTIGA™, OptiMOS™, ORIGA™, POWERCODE™, PRIMARION™, PrimePACK™, PrimeSTACK™, PROFET™, PRO-SIL™, RASIC™, REAL3™, ReverSave™, SatRIC™, SIEGET™, SIPMOST™, SmartLEWIS™, SOLID FLASH™, SPOC™, TEMPFET™, thinQ!™, TRENCHSTOP™, TriCore™.

Other Trademarks

Advance Design System™ (ADS) of Agilent Technologies, AMBA™, ARM™, MULTI-ICE™, KEIL™, PRIMECELL™, REALVIEW™, THUMB™, µVision™ of ARM Limited, UK. ANSI™ of American National Standards Institute. AUTOSAR™ of AUTOSAR development partnership. Bluetooth™ of Bluetooth SIG Inc. CAT-iq™ of DECT Forum. CIPURSE™ of OSPT Alliance. COLOSSUS™, FirstGPS™ of Trimble Navigation Ltd. EMV™ of EMVCo, LLC (Visa Holdings Inc.). EPCOS™ of Epcos AG. FLEXGO™ of Microsoft Corporation. HYPERTERMINAL™ of Hilgraeve Incorporated. MCS™ of Intel Corp. IEC™ of Commission Electrotechnique Internationale. IrDA™ of Infrared Data Association Corporation. ISO™ of INTERNATIONAL ORGANIZATION FOR STANDARDIZATION. MATLAB™ of MathWorks, Inc. MAXIM™ of Maxim Integrated Products, Inc. MICROTEC™, NUCLEUS™ of Mentor Graphics Corporation. MIPI™ of MIPI Alliance, Inc. MIPS™ of MIPS Technologies, Inc., USA. muRata™ of MURATA MANUFACTURING CO., MICROWAVE OFFICE™ (MWO) of Applied Wave Research Inc., OmniVision™ of OmniVision Technologies, Inc. Openwave™ of Openwave Systems Inc. RED HAT™ of Red Hat, Inc. RFMD™ of RF Micro Devices, Inc. SIRIUS™ of Sirius Satellite Radio Inc. SOLARIS™ of Sun Microsystems, Inc. SPANSION™ of Spansion LLC Ltd. Symbian™ of Symbian Software Limited. TAIYO YUDEN™ of Taiyo Yuden Co. TEAKLITE™ of CEVA, Inc. TEKTRONIX™ of Tektronix Inc. TOKO™ of TOKO KABUSHIKI KAISHA TA. UNIX™ of X/Open Company Limited. VERILOG™, PALLADIUM™ of Cadence Design Systems, Inc. VLYNQ™ of Texas Instruments Incorporated. VXWORKS™, WIND RIVER™ of WIND RIVER SYSTEMS, INC. ZETEX™ of Diodes Zetex Limited.

Trademarks Update 2014-11-12

www.infineon.com

Edition 2016-01

Published by

Infineon Technologies AG

81726 Munich, Germany

© 2014 Infineon Technologies AG.

All Rights Reserved.

Do you have a question about any aspect of this document?

Email: erratum@infineon.com

Document reference

Doc_Number

Legal Disclaimer

THE INFORMATION GIVEN IN THIS APPLICATION NOTE (INCLUDING BUT NOT LIMITED TO CONTENTS OF REFERENCED WEBSITES) IS GIVEN AS A HINT FOR THE IMPLEMENTATION OF THE INFINEON TECHNOLOGIES COMPONENT ONLY AND SHALL NOT BE REGARDED AS ANY DESCRIPTION OR WARRANTY OF A CERTAIN FUNCTIONALITY, CONDITION OR QUALITY OF THE INFINEON TECHNOLOGIES COMPONENT. THE RECIPIENT OF THIS APPLICATION NOTE MUST VERIFY ANY FUNCTION DESCRIBED HEREIN IN THE REAL APPLICATION. INFINEON TECHNOLOGIES HEREBY DISCLAIMS ANY AND ALL WARRANTIES AND LIABILITIES OF ANY KIND (INCLUDING WITHOUT LIMITATION WARRANTIES OF NON-INFRINGEMENT OF INTELLECTUAL PROPERTY RIGHTS OF ANY THIRD PARTY) WITH RESPECT TO ANY AND ALL INFORMATION GIVEN IN THIS APPLICATION NOTE.

Information

For further information on technology, delivery terms and conditions and prices, please contact the nearest Infineon Technologies Office (www.infineon.com).

Warnings

Due to technical requirements, components may contain dangerous substances. For information on the types in question, please contact the nearest Infineon Technologies Office. Infineon Technologies components may be used in life-support devices or systems only with the express written approval of Infineon Technologies, if a failure of such components can reasonably be expected to cause the failure of that life-support device or system or to affect the safety or effectiveness of that device or system. Life support devices or systems are intended to be implanted in the human body or to support and/or maintain and sustain and/or protect human life. If they fail, it is reasonable to assume that the health of the user or other persons may be endangered.