

**General Safety Instructions:**

READ SAFETY INSTRUCTIONS

**Servicing:**

These products are not customer serviceable TDK-Lambda UK LTD and their authorised agents only are permitted to carry out repairs.

**Critical Components:**

These products are not authorised for use as critical components in nuclear control systems, life support systems or equipment for use in hazardous environments without the express written approval of the Managing Director of TDK-Lambda EMEA.

**Product Usage:**

These products are designed for use within a host equipment which restricts access to authorised competent personnel.

This product is a component power supply and is only to be installed by qualified persons within other equipment and must be not operated as a stand alone product.

This product is for sale to business to business customers and can be obtained via distribution channels. It is not intended for sale to end users.

This product is a component power supply and does not fall within the scope of the EMC directive. Compliance with the EMC directive must be considered in the final installation. Please contact your local TDK-Lambda office.

**Environmental:**

These products are IPX0, and therefore chemicals/solvents, cleaning agents and other liquids must not be used.

**Environment:**

This power supply is a switch mode power supply for use in applications within a Pollution Degree 2, overvoltage category II environment. Material Group IIIb PCB's are used within it.

**Output Loading:**

The output power taken from the power supply must not exceed the rating stated on the power supply label, except as stated in the product limitations in this handbook.

**Input Parameters:**

This product must be operated within the input parameters stated in the product limitations in this handbook.

**End of Life Disposal:**

The unit contains components that require special disposal. Make sure that the unit is properly disposed of at the end of its service life and in accordance with local regulations.



RISK OF ELECTRIC SHOCK

**High Voltage Warning:**

Dangerous voltages are present within the power supply. The professional installer must protect service personnel from inadvertent contact with these dangerous voltages in the end equipment.

**WARNING:** When installed in a Class 1 end equipment, this product must be reliably earthed and professionally installed.

The (+) or (-) output(s) can be earthed or left floating.

The unit cover(s)/chassis (where applicable) must not be made user accessible.

The mains input connector is not acceptable for use as field wiring terminals.

For encased products, do not use mounting screws, which penetrate the unit more than; See drawings.

Internal fuses protect the unit and must not be replaced by the user. In case of internal defect, the unit must be returned to TDK-Lambda UK LTD or one of their authorised agents.

A suitable mechanical, electrical and fire enclosure must be provided by the end use equipment for mechanical, electric shock and fire hazard protection.

The unit cover/chassis, where applicable, is designed to protect skilled personnel from hazards. They must not be used as part of the external covers of any equipment where they may be accessible to operators, since under full load conditions, part or parts of the unit chassis may reach temperatures in excess of those considered safe for operator access.

**Allgemeine Sicherheitsvorschriften:**

LESEN SIE DIE SICHERHEITSVORSCHRIFTEN

**Wartung:**

Diese Produkte können nicht durch den Kunden gewartet werden. Nur TDK-Lambda UK LTD. und deren zugelassene Vertriebshändler sind zur Durchführung von Reparaturen berechtigt.

**Kritische Komponenten:**

Diese Produkte sind nicht für die Verwendung als kritische Komponenten in nuklearen Kontrollsystemen, Lebenserhaltungssystemen oder Geräten in gefährlichen Umgebungen geeignet, sofern dies nicht ausdrücklich und in Schriftform durch den Geschäftsführer von TDK-Lambda EMEA genehmigt wurde.

**Produktverwendung:**

Diese Produkte sind zur Verwendung innerhalb von Host-Anlagen gedacht, die einen auf das Fachpersonal beschränkten Zugang haben.

Dieses Produkt ist eine Stromversorgungs-Komponente und sie darf nur von qualifiziertem Personal in andere Geräte eingebaut werden und sie darf NICHT als eigenständiges ("Stand-Alone") Gerät betrieben werden.

Dieses Produkt ist für den Verkauf an Geschäftskunden entwickelt worden und es kann über Distributionskanäle bezogen werden.

Es ist NICHT für den Verkauf an Endkunden gedacht und konzipiert.

Dieses Produkt ist eine Stromversorgungsbaugruppe und sie fällt NICHT in den Bereich der EMV Direktive.

Die Konformität mit der EMV Richtlinie muss in der finalen Gesamtinstallation betrachtet werden.

Bitte kontaktieren Sie Ihr regionales TDK-Lambda Vertriebsbüro im Falle von Rückfragen.

**Umwelt:**

Diese Produkte sind IPX0, aus diesem Grund dürfen keine Chemikalien/Lösungsmittel, Reinigungsmittel und andere Flüssigkeiten verwendet werden.

**Umgebung:**

Dieses Netzteil ist ein Schaltnetzteil zur Verwendung in einer Umgebung mit einem Verschmutzungsgrad 2, Überspannungskategorie II. Materialgruppe IIIb mit darin verwendeten PCBs.

**Ausgangsstrom:**

Der Ausgangsstrom des Netzteiles darf die Leistung, die auf dem Label des Netzteiles vermerkt ist, nur dann überschreiten, wenn dies in den Produktgrenzen dieses Handbuches ausgezeichnet ist.

**Eingangsparameter:**

Dieses Produkt muss innerhalb der Eingangsparameter, die in den Produktgrenzen dieses Handbuches angegeben sind, betrieben werden.

**Entsorgung am Ende der Betriebszeit:**

Das Gerät enthält Komponenten die unter Sondermüll fallen. Das Gerät muss am Ende der Betriebszeit ordnungsgemäß und in Übereinstimmung mit den regionalen Bestimmungen entsorgt werden.

**GEFAHR DURCH ELEKTRISCHEN SCHLAG****Hochspannungswarnung:**

Innerhalb des Netzteiles gibt es gefährliche Spannungen. Der Elektroinstallateur muss das Wartungspersonal vor versehentlichem Kontakt mit den gefährlichen Spannungen im Endgerät schützen.

**WARNUNG!** Falls Sie unser Netzgerät in eine Anwendung mit Schutzklasse 1 eingebaut haben, stellen Sie sicher, dass es fachgerecht installiert und zuverlässig geerdet ist.

Die (+) oder (-) Ausgänge können geerdet werden oder unangeschlossen bleiben.

Die Abdeckung des Gerätes/das Gehäuse darf für den Benutzer nicht zugänglich sein.

Der Haupteingangsanschluss ist nicht für die Verwendung als Feldverdrahtungsanschluss geeignet.

Für ummantelt Produkte, verwenden Sie keine Schrauben, die das Gerät mehr als durchdringen; siehe Zeichnung. Eine interne Sicherung schützt das Gerät und darf durch den Benutzer nicht ausgetauscht werden. Im Fall von internen Defekten muss das Gerät an TDK-Lambda UK LTD oder einen der autorisierten Vertriebshändler zurückgeschickt werden.

Ein geeignetes mechanisches, elektrisches und brandgeschütztes Gehäuse muss als Schutz vor der Gefahr von mechanischen Risiken, Stromschlägen und Brandschutz in dem Endgerät vorgesehen werden.

Die Geräteabdeckung/das Gehäuse ist so entworfen, dass das Fachpersonal vor Gefahren geschützt wird. Sie dürfen nicht als Teil der externen Abdeckung für Geräte verwendet werden, die für den Betreiber zugänglich sein müssen, da Teile oder das gesamte Gerätegehäuse unter voller Auslastung übermäßige Temperaturen erreichen kann, die für den Zugang des Betreibers nicht mehr als sicher betrachtet werden.

**Consignes générales de sécurité:**

LIRE LES CONSIGNES DE SECURITE

**Entretien:**

Ces produits ne peuvent pas être réparés par l'utilisateur. Seuls, TDK-Lambda UK LTD et ses agents agréés sont autorisés à effectuer des réparations.

**Composants critiques:**

Ces produits ne doivent pas être utilisés en tant que composants critiques dans des systèmes de commande nucléaire, dans des systèmes de sauvetage ou dans des équipements utilisés dans des environnements dangereux, sans l'autorisation écrite expresse du directeur général de TDK-Lambda EMEA.

**Utilisation du produit:**

Ces produits sont conçus pour être utilisés dans un équipement hôte dont l'accès n'est autorisé qu'aux personnes compétentes.

Ce produit est une alimentation considérée comme un composant devant être installé par des personnes qualifiées, dans un autre équipement. Il ne doit pas être utilisé en tant que produit fini.

Ce produit est destiné à la vente entre entreprises et peut être obtenu via des canaux de distribution.

Il n'est pas prévu à la vente pour les particuliers.

Ce produit est une alimentation considérée comme un composant, il ne relève pas du champ d'application de la directive CEM. Le respect de la directive CEM doit être pris en compte dans l'installation finale. Veuillez contacter votre bureau TDK-Lambda le plus proche.

**Environnement:**

Ces produits sont IPX0, et donc on ne doit pas utiliser des produits chimiques/solvants, des produits de nettoyage et d'autres liquides.

**Environnement fonctionnel :**

Cette alimentation fonctionne en mode commutation pour utilisation dans des applications fonctionnant dans un environnement avec Degré de Pollution 2 et catégorie de surtension II. Elle utilise des cartes des circuits imprimés (PCB) de Groupe IIIb.

**Intensité soutirée:**

L'intensité soutirée de l'alimentation ne doit pas dépasser l'intensité nominale marquée sur la plaque signalétique, sauf indications contraires dans les limitations du produit décrit dans ce manuel.

**Paramètres d'entrée:**

Ce produit doit être utilisé à l'intérieur des paramètres d'entrée indiqués dans les limitations du produit dans ce manuel.

**Elimination en fin de vie:**

L'alimentation contient des composants nécessitant des dispositions spéciales pour leur élimination. Vérifiez que cette alimentation est mise au rebut correctement en fin de vie utile et conformément aux réglementations locales en vigueur.



RISQUE DE CHOC ELECTRIQUE

**Attention-Danger haute tension:**

Des tensions dangereuses sont présentes dans l'alimentation. L'installateur doit protéger le personnel d'entretien contre un contact involontaire avec ces tensions dangereuses dans l'équipement final.

**AVERTISSEMENT:** Si ce produit est installé dans un équipement final de classe I, il doit être mis à la terre de manière fiable et installé par un professionnel averti.

Les sorties (+) ou (-) peuvent être raccordées à la terre ou laissées flottantes.

Le couvercle/châssis de l'alimentation ne doit pas être accessible à l'utilisateur. Le connecteur d'entrée d'alimentation principale ne doit pas être utilisé comme borne de raccordement.

N'utilisez pas de vis pénétrant dans le module sur une profondeur supérieure à : Voir dessins.

Un fusible interne protège le module et ne doit pas être remplacé par l'utilisateur. En cas de défaut interne, le module doit être renvoyé à TDK-Lambda UK LTD ou l'un de ses agents agréés.

Une enceinte appropriée doit être prévue par l'utilisateur final pour assurer la protection contre les chocs mécaniques, les chocs électriques et l'incendie.

Le couvercle et le châssis du module sont conçus pour protéger des personnels expérimentés. Ils ne doivent pas être utilisés comme couvercles extérieurs d'un équipement, accessible aux opérateurs car en condition de puissance maximum, des parties du châssis peuvent atteindre des températures considérées comme dangereuses pour l'opérateur.

**Norme generali di sicurezza:**

SI PREGA DI LEGGERE LE NORME DI SICUREZZA

**Manutenzione:**

Il cliente non può eseguire alcuna manutenzione su questi prodotti. L'esecuzione delle eventuali riparazioni è consentita solo a TDK-Lambda UK LTD e ai suoi agenti autorizzati.

**Componenti critici:**

Non si autorizza l'uso di questi prodotti come componenti critici all'interno di sistemi di controllo nucleari, sistemi necessari alla sopravvivenza o apparecchiature destinate all'impiego in ambienti pericolosi, senza l'esplicita approvazione scritta dell'Amministratore Delegato di TDK-Lambda EMEA.

**Uso dei prodotti:**

Questi prodotti sono progettati per l'uso all'interno di un'apparecchiatura ospite che limiti l'accesso al solo personale competente e autorizzato.

Questo prodotto è da considerarsi come un alimentatore professionale componente e come tale deve essere installato da personale qualificato all'interno di altre apparecchiature e non può essere utilizzato come prodotto indipendente.

Questo prodotto non è inteso per la vendita al dettaglio o agli utilizzatori finali.

Questo alimentatore è da considerarsi come un componente e come tale non è assoggettato dagli scopi della direttiva EMC. Conformità alla direttiva EMC deve essere considerata nell'installazione finale di utilizzo. Gli uffici di TDK-Lambda Sas Succursale Italiana sono a vostra disposizione per ulteriori raggugli.

**Condizioni ambientali:**

Questi prodotti sono classificati come IPX0, dunque non devono essere utilizzati sostanze chimiche/solventi, prodotti per la pulizia o liquidi di altra natura.

**Ambiente:**

Questo prodotto è un alimentatore a commutazione, destinato all'uso in applicazioni rientranti in ambienti con le seguenti caratteristiche: Livello inquinamento 2, Categoria sovratensione II. Questo prodotto contiene schede di circuiti stampati in materiali di Gruppo IIIb.

**Carico in uscita:**

La potenza in uscita ottenuta dall'alimentatore non deve superare la potenza nominale indicata sulla targhetta dell'alimentatore, fatto salvo dove indicato nei limiti per il prodotto specificati in questo manuale.

**Parametri di alimentazione:**

Questo prodotto deve essere utilizzato entro i parametri di alimentazione indicati nei limiti per il prodotto, specificati in questo manuale.

**Smaltimento:**

L'unità contiene componenti che richiedono procedure speciali di smaltimento. Accertarsi che l'unità venga smaltita in modo corretto al termine della vita utile e nel rispetto delle normative locali.



RISCHIO DI SCOSSA ELETTRICA

**Avvertimento di alta tensione:**

All'interno dell'alimentatore sono presenti tensioni pericolose. Gli installatori professionali devono proteggere il personale di manutenzione dal rischio di contatto accidentale con queste tensioni pericolose all'interno dell'apparecchiatura finale.

**ATTENZIONE:** Se installato in un'attrezzatura di classe I, questo prodotto deve essere collegato a terra in modo affidabile ed installato in modo professionale.

Le uscite (+) o (-) possono essere messa a terra o lasciate isolate.

I coperchi/il telaio dell'unità non devono essere accessibili da parte dell'utente.

Il connettore dell'alimentazione principale non può essere utilizzato come terminale di collegamento di campo.

Non utilizzare viti che penetrano nell'unità per più di : Vedi disegni

Un fusibile interno protegge l'unità e non deve essere sostituito dall'utente. Nell'eventualità di un difetto interno, restituire l'unità a TDK-Lambda UK LTD o a uno dei suoi agenti autorizzati.

L'apparecchiatura finale deve includere una recinzione meccanica, elettrica e antincendio per proteggere dai pericoli di natura meccanica, dalle scosse elettriche e dai pericoli di incendio.

Il coperchio/telaio dell'unità è realizzato per proteggere il personale esperto dai pericoli. Non deve essere usato come parte degli involucri esterni di qualsiasi apparecchiatura, se risulta accessibile da parte degli addetti, poiché è possibile che in condizioni di pieno carico una o più parti del telaio dell'unità giunga/giungano a temperature superiori ai limiti considerati sicuri per l'accesso da parte degli addetti.



**Instrucciones generales de seguridad:**

LEA LAS INSTRUCCIONES DE SEGURIDAD

**Servicio:**

Estos productos no pueden ser reparados por los clientes. TDK-Lambda UK LTD. y sus agentes autorizados son los únicos que pueden llevar a cabo las reparaciones.

**Componentes fundamentales:**

Estos productos no pueden ser utilizados como componentes fundamentales en sistemas de control nuclear, sistemas de soporte vital o equipos a utilizar en entornos peligrosos sin el consentimiento expreso por escrito del Director General de TDK-Lambda EMEA.

**Uso de los productos:**

Estos productos han sido diseñados para ser utilizados en un equipo central que restrinja el acceso al personal cualificado autorizado.

Este producto es una fuente de alimentación y sólo puede ser instalado por personal cualificado dentro de otros equipos y no debe ser tratado como un producto independiente. Este producto debe ser vendido entre empresas profesionales y solo puede obtenerse a través de los canales de distribución. No está destinado para la venta a usuarios finales.

Este producto es una fuente de alimentación y no se ve afectada por la directiva EMC. El cumplimiento de la directiva EMC se debe considerar en la instalación final. Por favor, póngase en contacto con su oficina local de TDK – Lambda.

**Medioambiental:**

Estos productos son IPX0 y, por tanto, no pueden utilizarse sustancias químicas/disolventes, agentes de limpieza ni otros líquidos.

**Medio ambiente:**

Esta fuente de alimentación es una fuente de alimentación de modo conmutado a utilizar en aplicaciones dentro de un entorno con un Grado de contaminación 2 y una Categoría de sobretensión II. En él se utilizan policloruros de bifenilo del Grupo de materiales IIIb.

**Carga de salida:**

La potencia de salida tomada de la fuente de alimentación no puede sobrepasar el valor nominal indicado en la etiqueta de la fuente de alimentación, excepto en los casos indicados en las limitaciones del producto en este manual.

**Parámetros de entrada:**

Este producto debe ser utilizado dentro de los parámetros de entrada indicados en las limitaciones del producto en este manual.

**Desecho de la unidad:**

La unidad contiene componentes que deben ser desechados de una manera especial. Asegúrese de desechar correctamente la unidad al final de su vida útil y conforme a las normas locales vigentes.



PELIGRO DE DESCARGAS ELÉCTRICAS

**Advertencia de alta tensión:**

En esta fuente de alimentación hay tensiones peligrosas. El instalador profesional debe proteger al personal de servicio contra cualquier contacto accidental con estas tensiones peligrosas en el equipo final.

**ADVERTENCIA:** La instalación de este producto en un equipo de clase I la deben llevar a cabo profesionales y el producto debe estar conectado a tierra.

La salida o salidas (+) o (-) pueden conectarse a tierra o se las puede dejar flotando.

Debe impedirse el acceso de los usuarios a la cubierta o cubiertas y al chasis de la unidad.

El conector de entrada de la red no es apto para ser utilizado a modo de bornes de cableado de campo.

No utilice tornillos de montaje susceptibles de penetrar en la unidad más de: Ver dibujos.

Un fusible interno protege la unidad y este no debe ser nunca reemplazado por el usuario. En caso de existir algún defecto interno, la unidad debe ser enviada a TDK-Lambda UK LTD o a uno de sus agentes autorizados.

El equipo de uso final debe constituir un recinto de protección mecánica, eléctrica y contra incendios de protección mecánica, contra descargas eléctricas y contra el peligro de incendios.

La cubierta/chasis de la unidad ha sido diseñada para que proteja a las personas cualificadas de los peligros. No deben ser utilizadas como parte de las cubiertas externas de cualquier equipo al que pueden acceder los operarios, ya que bajo unas condiciones de carga completa, la pieza o piezas del chasis de la unidad pueden alcanzar temperaturas superiores a las consideradas seguras para el acceso de los operarios.

**Instruções gerais de segurança:**

LEIA AS INSTRUÇÕES DE SEGURANÇA

**Manutenção:**

Estes produtos não são podem ser submetidos a manutenção por parte do cliente. Apenas a TDK-Lambda UK LTD e os seus agentes autorizados têm permissão para realizar reparações.

**Componentes essenciais:**

Não é autorizada a utilização destes produtos como componentes essenciais de sistemas de controlo nuclear, sistemas de suporte de vida ou equipamento para utilização em ambientes perigosos sem a expressa autorização por escrito do Director-Geral da TDK-Lambda EMEA.

**Utilização do produto:**

Estes produtos foram concebidos para utilização dentro de um equipamento de alojamento que apenas permita o acesso a pessoal qualificado autorizado.

Este produto é uma alimentação considerado com um componente para ser instalado por pessoas qualificadas, em outros equipamentos. Não deve ser usado como um produto acabado.

Este produto é destinado para venda entre as empresas e pode ser obtido através de canais de distribuição. Não se destina à venda aos particulares.

Este produto é uma alimentação considerado com um componente, não é dentro do application âmbito da directiva CEM.

Conformidade com a directiva CEM devem ser considerados na instalação final.

Entre em contacto com seu escritório TDK-Lambda mais próximo.

**Ambiental:**

Estes produtos são IPX0 e, como tal, não se devem utilizar químicos/solventes, agentes de limpeza e outros líquidos.

**Ambiente:**

Esta fonte de alimentação é uma fonte de alimentação do modo de comutação para utilização em aplicações com um Nível de Poluição 2 e ambientes da categoria de sobretensão II. São utilizadas placas de circuitos impressos do grupo de materiais IIIb.

**Carga de saída:**

A potência de saída extraída da fonte de alimentação não deve exceder a classificação assinalada na etiqueta da fonte de alimentação, excepto quando indicado nas limitações do produto neste guia.

**Parâmetros de entrada:**

Este produto deve ser utilizado dentro dos parâmetros de entrada indicados nas limitações do produto neste guia.

**Eliminação no fim de vida:**

A unidade contém componentes que necessitam de procedimentos especiais de eliminação. Certifique-se de que a unidade é devidamente eliminada no fim da sua vida útil e que tal é feito em conformidade com os regulamentos locais.



RISCO DE CHOQUE ELÉCTRICO

**Aviso de alta tensão:**

Estão presentes tensões perigosas dentro da fonte de alimentação. O profissional que realizar a instalação deve proteger o pessoal de assistência contra contactos inadvertidos com estas tensões perigosas do equipamento final.

**AVISO:** Quando instalado num equipamento de Classe I, este produto deve ser ligado à terra de forma fiável e instalado por um profissional.

As saídas (+) e (-) podem ser ligadas à terra ou deixadas soltas.

O chassis/cobertura(s) da unidade não deve estar acessível ao utilizador.

O conector de entrada de alimentação não deve ser utilizado como terminal de cablagens no local.

Não utilize parafusos de montagem, uma vez que estes penetrarão na unidade em mais do que: Veja os desenhos

Existe um fusível interno que protege a unidade e que não deve ser substituído pelo utilizador. Em caso de defeito interno, a unidade deve ser devolvida à TDK-Lambda UK LTD ou a um dos seus agentes autorizados.

O equipamento de utilização final deve fornecer um bastidor com protecção mecânica, eléctrica e contra incêndios adequada.

O chassis/cobertura da unidade está concebido de forma a proteger o pessoal especializado de perigos. Não devem ser utilizados como parte das coberturas externas de qualquer equipamento em que possam estar acessíveis aos operadores, uma vez que em condições de carga máxima, algumas peças do chassis da unidade podem atingir temperaturas superiores às consideradas seguras para o acesso do operador.

## **TDK-Lambda**

TDK-Lambda UK Ltd  
Kingsley Avenue, Ilfracombe  
Devon, EX34 8ES  
Telephone - Sales and Service +44 (0)1271 856666  
Head Office and Works +44 (0)1271 856600  
Facsimile +44 (0)1271 864894  
WEBSITE: [www.uk.tdk-lambda.com](http://www.uk.tdk-lambda.com)

# HWS 30A-150A/ME Series

## Instruction Manual

### BEFORE USING THE POWER SUPPLY UNIT

Be sure to read this instruction manual thoroughly before using this product. Pay attention to all cautions and warnings before using this product. Incorrect usage could lead to an electrical shock, damage to the unit or a fire hazard.

#### DANGER

Never use this product in locations where flammable gas or ignitable substances are present. There are risks of igniting these substances and exploding by an arcing.

#### WARNING

- Do not touch this product or its internal components while circuit is live, or shortly after shutdown. There may be high voltage or high temperature present and you may receive an electric shock or burn.
- While this product is operating, keep your hands and face away from it as you may be injured by an unexpected situation.
- Do not make unauthorized changes to this product, otherwise you may receive an electric shock and void your warranty.
- Do not drop or insert anything into this product. It might cause a failure, fire and electric shock.
- Do not use this product under unusual condition such as emission of smoke or abnormal smell and sound etc. It might lead to fire and electric shock. In such cases, please contact us. Do not attempt repair by yourself, as it is dangerous for the user.
- Do not operate these products in the presence of condensation. It might lead fire and electric shock.

#### CAUTION

- This power supply is designed and manufactured for use within an end product such that it is accessible to SERVICE ENGINEERS only.
- Confirm connections to input/output terminals and signal terminal are correct as indicated in the instruction manual before switching on.
- Input voltage, Output current, Output power, ambient temperature and ambient humidity should be kept within specifications, otherwise the product will be damaged.
- Do not operate and store this product in an environment where condensation might occur. In such case, waterproof treatment is necessary.
- Do not use this product in environment with a strong electromagnetic field, corrosive gas or conductive substances.
- For applications, which require very high reliability (Nuclear related equipment, medical equipment, traffic control equipment, etc.), it is necessary to provide a fail-safe mechanism in the end equipment.
- Do not inject abnormal voltages into the output or signal of this product. The injection of reverse voltage or over voltage exceeding nominal output voltage into the output or signal terminals might cause damage to internal components.
- Never operate the product under over current or short-circuit conditions, or outside its specified Input Voltage Range. Insulation failure, smoking, burning or other damage may occur.
- This product contains a printed circuit board utilizing surface mounted devices. PCB stress such as bending, twisting etc. could cause damage. Therefore, please handle with care.
- This power supply has possibility that hazardous voltage may occur in output terminal depending on failure mode. The output of these products must be protected in the end use equipment to maintain SELV.
- The information in this document is subject to change without prior notice. Please refer to the latest version of the data sheet, etc., for the most up-to date specifications of the product.
- No part of this document may be copied or reproduced in any form without prior written consent of TDK-Lambda.

#### Note : CE MARKING

CE Marking when applied to a product covered by this handbook indicates compliance with the low voltage directive (2006/95/EC) in that it complies with EN60950-1.

## Important safety instructions

### Servicing

These products are not customer serviceable. Repairs may only be carried out by TDK-Lambda Corp. or their authorised agents. These products are not authorised for use as critical components in nuclear control systems, life support systems or equipment for use in hazardous environments without the express written approval of the Managing Director of TDK-Lambda Corp..

### Safety Class of Protection

These products are designed for the following parameters : Material Group IIIb, Pollution Degree 2, Overvoltage Category II, Class I (earthed), Indoor use as part of an overall equipment such that the product is accessible to service engineers only.

## EMC performance

### Immunity (IEC61000-6-2)

Test	Standard
Electrostatic discharge	IEC61000-4-2
Electromagnetic field	IEC61000-4-3
Fast / burst transient	IEC61000-4-4
Surge immunity	IEC61000-4-5
Conducted RF immunity	IEC61000-4-6
Power frequency magnetic field	IEC61000-4-8
Voltage dips, variations, interruptions	IEC61000-4-11

### Emissions

Test	Standard	Comments
Radiated electric field	EN55022	Class B (as per CISPR 22)
Conducted emissions	EN55022	Class B (as per CISPR 22)
Conducted harmonics	IEC61000-3-2	Compliant
Flicker	IEC61000-3-3	Compliant

### **General installation instructions**

- 1) These products are Class I and must therefore be reliably earthed and professionally installed in accordance with the prevailing electrical wiring regulations and the safety standards covered herein.
- 2) The degree of protection against harmful ingress of water is: Ordinary, IPX0. Therefore chemicals/solvents, cleaning agents and other liquids must not be used.
- 3) The first protective earth connection in the final installation must be marked with the protective earth symbol.

### **Special Instructions for IEC/EN/ES/CSA 60601-1**

- 1) These products are designed for continuous operation within an overall enclosure, and must be mounted such that access to the mains terminals is restricted. See Clause 8, IEC/EN/ES/CSA60601-1.
- 2) These products are suitable for use in the presence of a flammable anesthetics mixture with air or oxygen or with nitrous oxide: No
- 3) These products are classed as ordinary equipment according to IEC/EN/ES/CSA60601-1 and are NOT protected against the ingress of water.
- 4) The output circuit has not evaluated for connecting to Applied Parts. For end products intended to connect the output circuit to Applied Parts, suitable evaluation of the separation, leakage current, dielectric voltage withstand, and related requirements should be conducted.
- 5) The input circuit includes only one fuse in the Line conductor. Consideration shall be given in the end-use product regarding addition of the second fuse having the same or better characteristics in order to comply with fusing requirements of Clause 8.11.5 of the Standard.
- 6) These products provide the following MOOP (means of operator protection): 2 MOOP between Primary and Secondary. No means of patient protection (MOPP) are provided.
- 7) When the PSU is installed within medical equipment an all pole mains input disconnect device must be fitted.
- 8) Reference should be made to local regulations concerning the disposal of these products at the of their useful life.

## 1. Model name identification method

### HWS 30A – 5 /ME

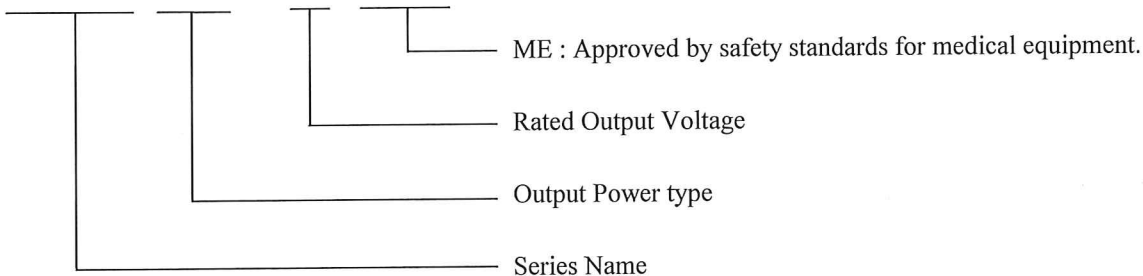

## 2. Terminal Explanation

### HWS30A/ME, HWS50A/ME

- ① +V : + Output terminal  
(15A max. / terminal)
- ② -V : - Output terminal  
(15A max. / terminal)
- ③ FG : Frame Ground
- ④ L : Input terminal Live line (Fuse in line)
- ⑤ N : Input terminal Neutral line
- ⑥ Output voltage adjustment trimmer
- ⑦ Output monitoring indicator (Green LED)

\*All screws size is M3.5

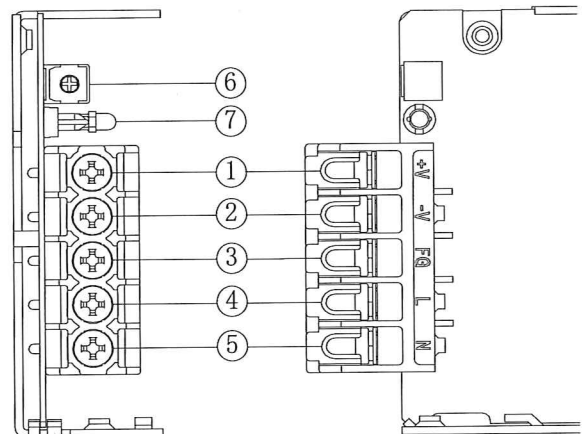

### HWS100A/ME, HWS150A/ME

- ① +V : + Output terminal  
(30A max. / terminal)
- ② -V : - Output terminal  
(30A max. / terminal)
- ③ FG : Frame Ground
- ④ L : Input terminal Live line (Fuse in line)
- ⑤ N : Input terminal Neutral line
- ⑥ +S : + Remote sensing terminal
- ⑦ -S : - Remote sensing terminal
- ⑧ Output voltage adjustment trimmer
- ⑨ Output monitoring indicator (Green LED)

\*All screws size is M3.5

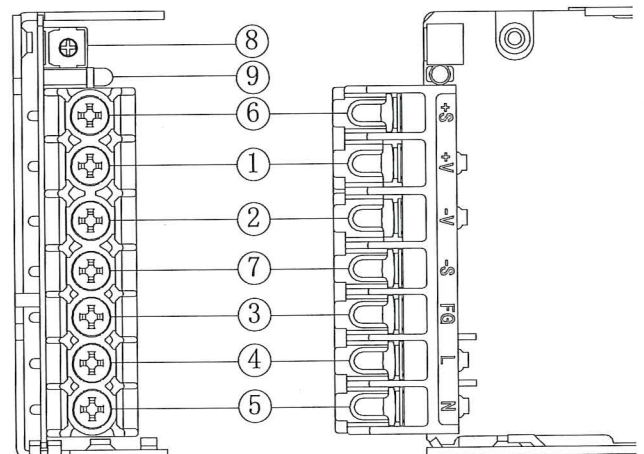



### 3. Connecting method

Pay attention to the input wiring. If it is connected to wrong terminal, the power supply will be damaged.

- Input must be off when making connections.
- Connect FG terminal to earth (frame ground of the equipment etc.) by thick wire for safety and improvement of noise sensitivity.

#### HWS30A/ME, HWS50A/ME

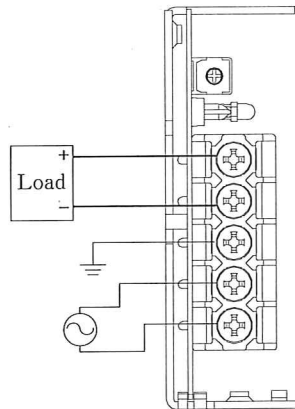

#### HWS100A/ME, HWS150A/ME

##### ▪ Basic connection (Local sensing)

Connect “+S” terminal to “+V” terminal, and “-S” terminal to “-V” terminal with the attached short pieces.

(Short pieces are mounted at time of shipment.)

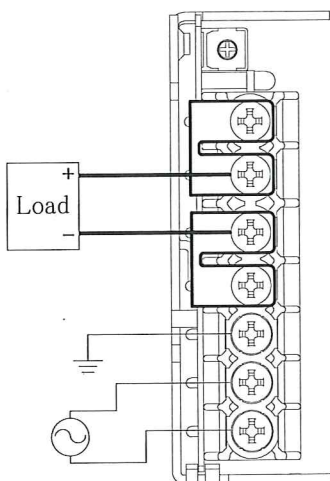

##### ▪ Remote sensing connection

Connect “+S” terminal to “+” terminal of load, and “-S” terminal to “-” terminal of load with wires.

If remote sensing terminals are opened, the output will rise and OVP may be triggered.

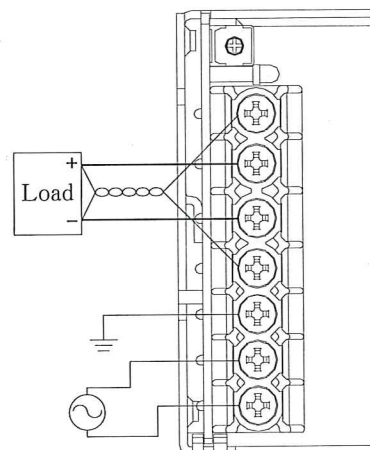

Recommended torque : HWS30A/ME - HWS150A/ME

M3.5 screw 1.0N·m(10.2kgf·cm) - 1.6N·m(16.3kgf·cm)

## 4. Explanation of Functions and Precautions

### 4-1. Input Voltage Range

Input voltage range is single phase 85-265VAC(47-63Hz) or 120-370VDC. Input voltage, which is out of specification, might lead unit damage. For cases where conformance to various safeties required, described as 100-240VAC (50-60Hz).

Note : HWS-A/ME series is able to withstand input of 300VAC for 5 seconds (No damage). Please note that to satisfy the electrical characteristics, the input voltage range must be within 85-265VAC.

### 4-2. Output Voltage Range

Output voltage is set the rated value at shipment. V.ADJ trimmer can adjust the output voltage within the range.

Output voltage range is within +/- 20% (48V : +10%/-20%) of nominal output voltage.

To turn the trimmer clockwise, the output voltage will be increased. Take note when the output voltage is increased excessively, over voltage protection (OVP) function may trigger and voltage will be shut down. Furthermore, when increasing the output voltage reduce the output current so as not to exceed the maximum output power.

### 4-3. Inrush Current

This series equipped Power thermistor to limit the inrush current. This series are Power thermistor method so that higher current will flow at higher ambient temperature or re-input condition. Please select input switch and fuse carefully with the high temperature and re-input the power condition. The inrush current value is under cold start at 25°C in the specification.

### 4-4. Over Voltage Protection (OVP)

The OVP function (Inverter shut down method, manual reset type) is provided. OVP function operates within 5-24V: 125% - 145%, 48V: 115%-135% of nominal output voltage.

When OVP triggers, the output will be shut down. To reset OVP, remove the input of power supply for a few minutes, and then re-input. In addition, the setting value of OVP is fixed and not adjustable. Pay attention not to apply higher voltage externally to the output terminal to avoid unit failure. In case of inductive load, put protective diode in series to the output power line.

### 4-5. Over Current Protection (OCP)

HWS30A/ME, HWS50A/ME : Fold back limit and Hiccup mode with automatic recovery.

HWS100A/ME, HWS150A/ME : Constant current limit and Hiccup with automatic recovery.

OCP function operates when the output current exceeds 105% of maximum DC output current of specification.

The outputs will be automatically recovered when the overload condition is canceled. Never operate the unit under over current or shorted conditions, which may leads damage. OCP setting is fixed and not to be adjusted externally.

**4-6. Remote Sensing (+S, -S terminal)**  
 (For HWS100A/ME, HWS150A/ME)

This function compensates voltage drop of wiring from output terminals to load terminals. Connect “+S” terminal to “+” terminal of load and “-S” terminal to “-” terminal of load with sensing wires.

The total line voltage drop (+ side line and - side line) shall be less than 0.3V.

In case that sensing line is too long, it is necessary to put an electrolytic capacitor in following 3 placed;

- 1) Across the load terminal,
- 2) Between “+S” terminal and “+V” terminal,
- 3) Between “-S” terminal and “-V” terminal.

If remote sensing terminals are opened, the output will rise and OVP may be triggered.

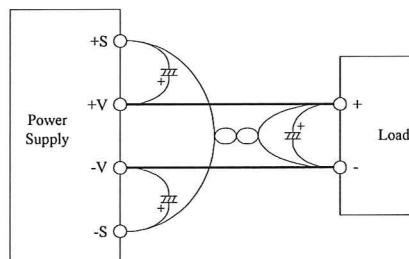

**4-7. Output Ripple & Noise**

The standard specification for maximum ripple value is measured according to measurement circuit specified by JEITA RC-9131B. When load lines are longer, ripple will become larger. In this case, electrolytic capacitor, film capacitor, etc. might be necessary to use across the load terminal.

The output ripple cannot be measured accurately if the probe ground lead of oscilloscope is too long.

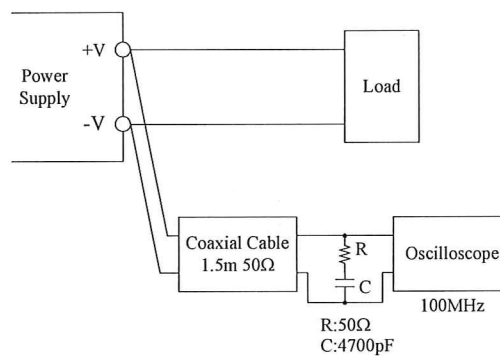

#### 4-8. Series Operation

For series operation, either method ( A ) or ( B ) is possible.

Method ( A )

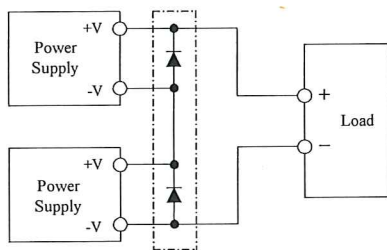

Method ( B )

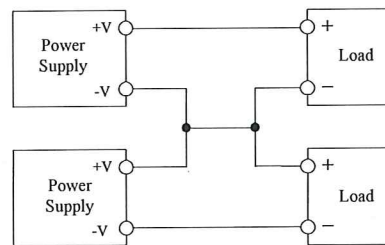

Note : In case of (A), please connect bypass diodes to prevent reverse voltage.

Please select a bypass diode with maximum forward current rating more than output load current.

And maximum reverse voltage must withstand each power supply output voltage.

\*Series operation for HWS100A/ME, HWS150A/ME possible without bypass diode.

Never use when one of the unit not operate, which may leads damage.

#### 4-9. Parallel Operation

(A) Operation to increase the Output Current is not possible.

(B) Operation as a Backup Power Supply is possible as follows.

1. Set the power supply output voltage higher by the amount of forward voltage drop ( VF ) of the diode.
2. Please adjust the output voltage of each power supply to be the same.
3. Please use within the specifications for output voltage and output power.
4. Please select a reverse current prevention diode with maximum forward current rating more than output load current.

(A)

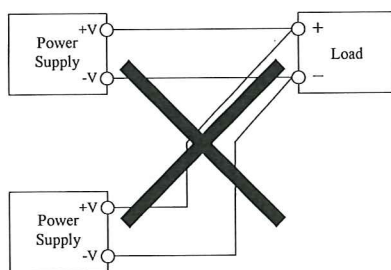

(B)

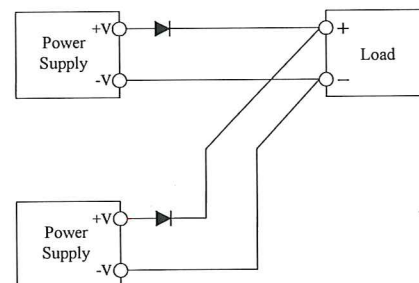

#### 4-10. Isolation Test

Isolation resistance between Output – FG terminal is more than 100MΩ at 500VDC. For safety operation, voltage setting of DC isolation tester must be done before the test. Ensure that the unit is fully discharged after the test.

■ Output – FG terminal : 500VDC More than 100MΩ

( A ) HWS30A/ME, HWS50A/ME

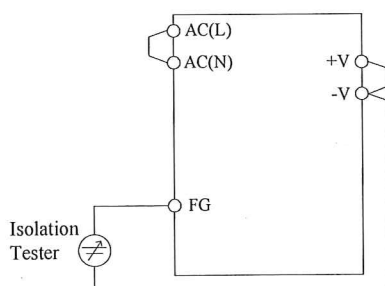

( B ) HWS100A/ME, HWS150A/ME

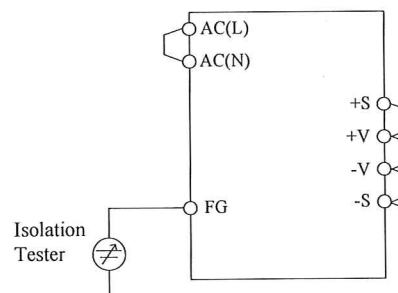

#### 4-11. Withstand Voltage

This series is designed to withstand 3.0kVAC between input and output, 2.0kVAC between input and FG and 500VAC between output and FG each for 1 minute. When testing withstand voltage, set current limit of withstand voltage test equipment at 20mA. The applied voltage must be gradually increased from zero to testing value and then gradually decreased for shut down. When timer is used, the power supply may be damaged by high impulse voltage at timer switch on and off. Connect input and output as follows.

- Input ~ FG (solid line) : 2.0kVAC, 1min (20mA)
- Input ~ Output (dotted line) : 3.0kVAC, 1min (20mA)

( A ) HWS30A/ME, HWS50A/ME

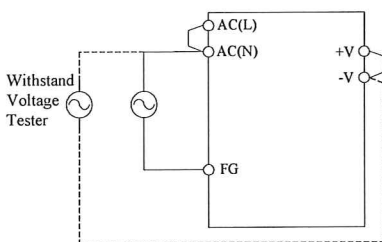

( B ) HWS100A/ME, HWS150A/ME

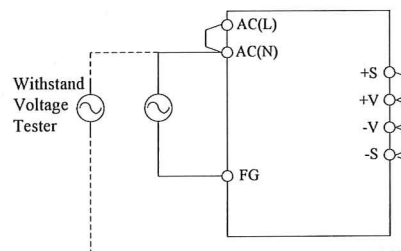

- Output ~ FG : 500VAC, 1min (20mA)

( A ) HWS30A/ME, HWS50A/ME

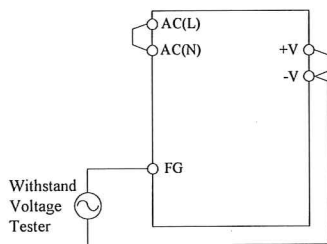

( B ) HWS100A/ME, HWS150A/ME

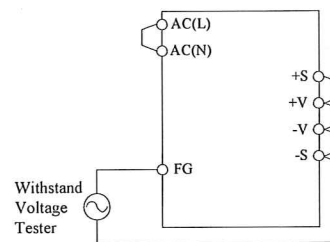

Note1 : This product have monolithic ceramic capacitor in secondary circuit to frame ground.

Some of the withstand voltage tester may generate high voltage at the matching with monolithic ceramic capacitor and may cause the unit damage. So, please check the waveform of test voltage.

Note2 : In case of using external noise filter, capacitance between “Input and FG” might be increased. When testing withstand voltage between “Input and Output”, there is a possibility exceeding withstand voltage between “Output and FG” (500VAC). Please check the voltage between “Output and FG”.

If the voltage exceeding withstand voltage, please add external capacitor to “Output and FG”. It can decrease the voltage.

On the other hand, no need to check the voltage in case of “Output and FG” is shorted.

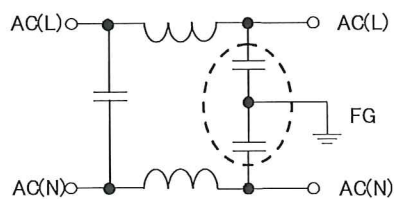

The example of noise filter circuit that may increasing capacitance value between “Input and FG”  
 (Capacitance value in dashed line is added.)

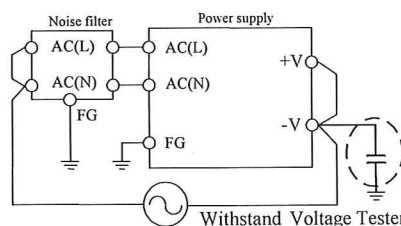

External capacitor adding point or short point.  
 Even in the case of “+V and FG”, There is a similar effect.

## 5. Mounting Method

### 5-1. Mounting Method

- (1) This is convection cooling type power supply. In the consideration for the heat radiation and safety. Please take a distance more than 15mm between the power supply and the peripheral parts. When lining up multiple units, please make sure to place them 15mm or more apart from each other.
- (2) Please take insulation distance (space) more than 5mm for the component side at the open frame type.
- (3) The maximum allowable penetration of mounting screws is 6mm.
- (4) Recommended torque for mounting screw  
 HWS30A/ME ~ HWS150A/ME (M3 screw) : 0.49 N·m ( 5.0 kgf·cm )

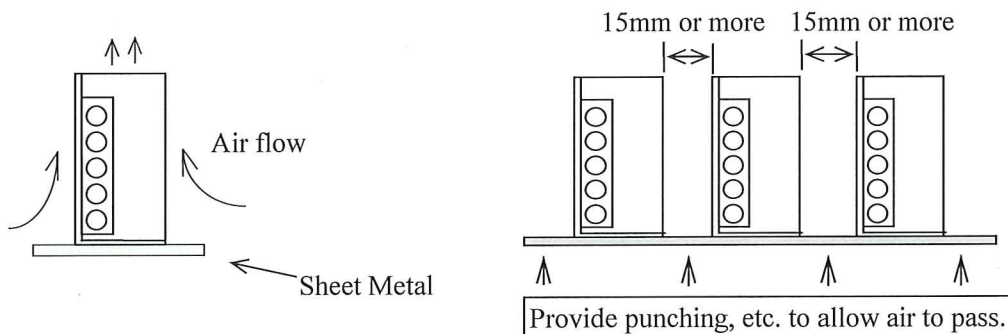

### 5-2. Output Derating according to the Mounting Directions

Recommend standard mounting is direction ( A ). Direction ( B ), ( C ) and ( D ) are also possible. For other mounting directions, please inquire to TDK-Lambda.

Refer to the derating below. Please do not use mounting direction ( E ), where the PCB will be on the topside and heat will be trapped inside the unit. Load (%) is percent of maximum output power or maximum output current, do not exceed its derating of maximum load.

#### ■ Mounting direction

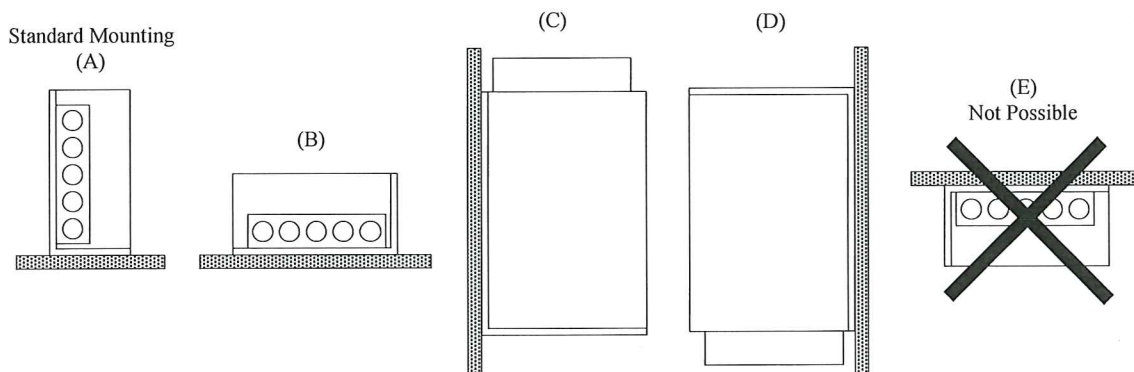

**■ Output Derating**

**HWS30A/ME**

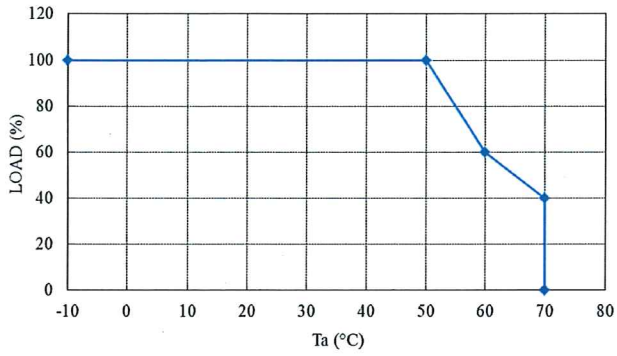

◆ Mounting (A),(B),(C),(D)

Ta (°C)	Load (%)	
	Mounting (A),(B),(C),(D)	
-10 ~ +50	100	
60	60	
70	40	

**HWS50A/ME**

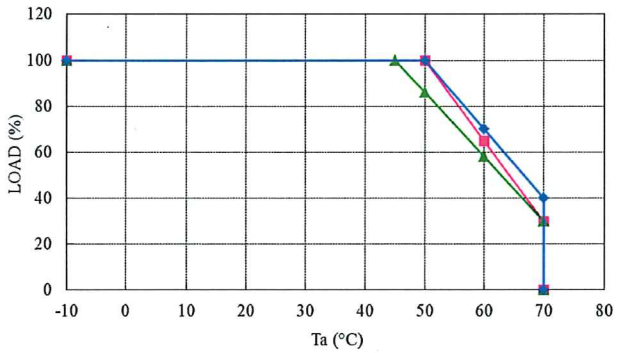

◆ Mounting (A)  
 ■ Mounting (B),(D)  
 ▲ Mounting (C)

Ta (°C)	Load (%)		
	Mounting (A)	Mounting (B),(D)	Mounting (C)
-10 ~ +45	100	100	100
50	100	100	86
60	70	65	58
70	40	30	30

**HWS100A/ME**

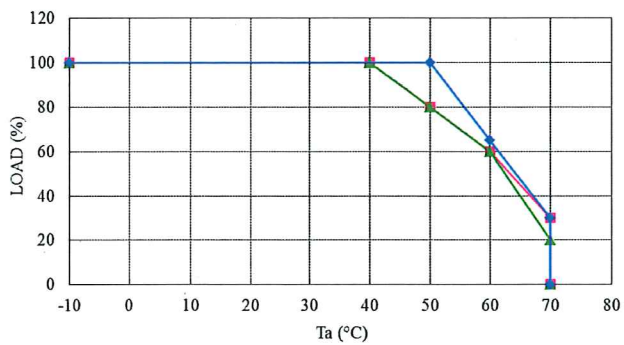

◆ Mounting (A)  
 ■ Mounting (B)  
 ▲ Mounting (C),(D)

Ta (°C)	Load (%)		
	Mounting (A)	Mounting (B)	Mounting (C),(D)
-10 ~ +40	100	100	100
50	100	80	80
60	65	60	60
70	30	30	20

## HWS150A/ME

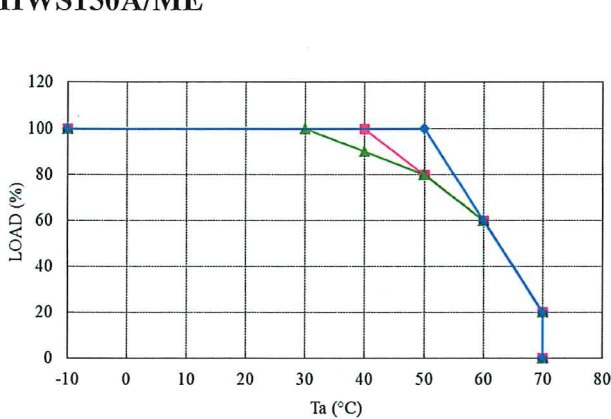

◆ Mounting (A)  
■ Mounting (B)  
▲ Mounting (C),(D)

Ta (°C)	Load (%)		
	Mounting (A)	Mounting (B)	Mounting (C),(D)
-10 ~ +30	100	100	100
40	100	100	90
50	100	80	80
60	60	60	60
70	20	20	20

## 6. Wiring Method

- (1) The output load line and input line shall be separated, and use all lines as thick and short as possible to make lower impedance. The output load line and input line shall be twisted or use shielded wire to improve noise sensitivity.
- (2) Remote sensing lines shall be twisted or use shielded wire, and separated from the output lines.
- (3) Noise can be eliminated by attaching a capacitor to the load terminals.
- (4) The recommended wire type, torque and crimp-type terminal :

MODEL	Recommended Wire	Recommended torque	Recommended crimp-type terminal		
			D (MAX)	t (MAX)	Mounting pieces (MAX)
HWS30A/ME HWS50A/ME	AWG14-22	All terminal M3.5 Screws 1.0N·m (10.2kgf·cm)~1.6N·m (16.3kgf·cm)	6.8mm	0.8mm	2 piece
HWS100A/ME	AWG12-22	Output terminal M3.5 Screws 1.0N·m (10.2kgf·cm)~1.6N·m (16.3kgf·cm)	8.1mm	1.0mm	1 piece
	AWG14-22	Other terminal M3.5 Screws 1.0N·m (10.2kgf·cm)~1.6N·m (16.3kgf·cm)		0.8mm	2 piece
HWS150A/ME	AWG10-22	Output terminal M3.5 Screws 1.0N·m (10.2kgf·cm)~1.6N·m (16.3kgf·cm)	8.1mm	1.0mm	1 piece
	AWG14-22	Other terminal M3.5 Screws 1.0N·m (10.2kgf·cm)~1.6N·m (16.3kgf·cm)		0.8mm	2 piece

Note 1 : When using separate loads, use of two pcs. of 0.8mm thick crimp-type terminal is recommended.

Note 2 : For recommended diameter, refer to wire maker recommended allowable current and voltage drop.

Especially, for 5V model, output current is large. Thick diameter wire is recommended.

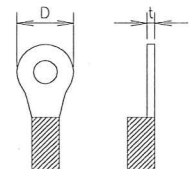



## 7. The life expectancy

The life expectancy of the power supply is as follows.

The life of the power supply depends on the life of the built-in aluminum electrolytic capacitor.

The life expectancy is not a guaranteed value, please consider as a reference.

Please do not use the product which passed over the life expectancy.

There is a risk of unexpected output shutdown and specifications may not be satisfied.

Please contact us for maintenance or exchange the product which passed over the life expectancy.

The life expectancy of power supply is calculated in condition of rated input voltage and 24-hour continuous operation.

Load (%) is percent of maximum output power or maximum output current, do not exceed its derating of maximum load.

### ◇HWS30A/ME

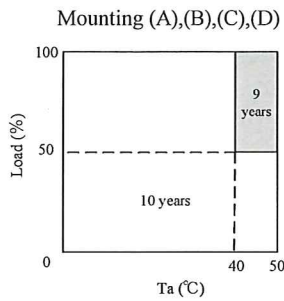

### ◇HWS50A/ME

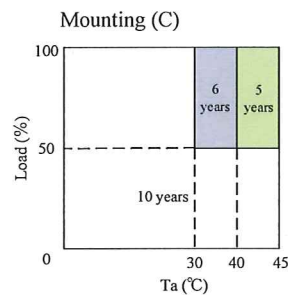
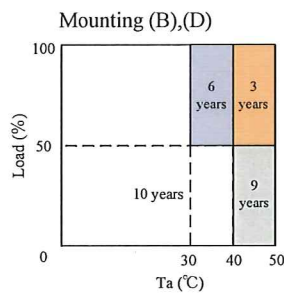
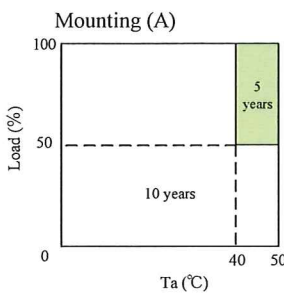

### ◇HWS100A/ME

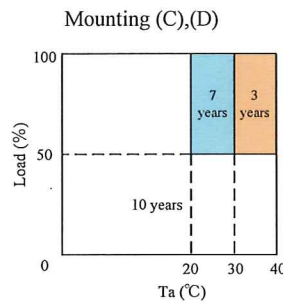
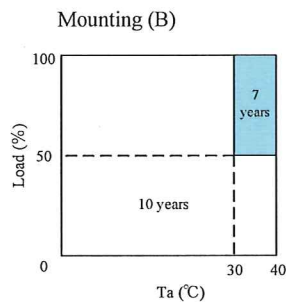
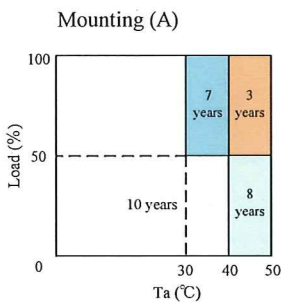

◇ **HWS150A/ME**

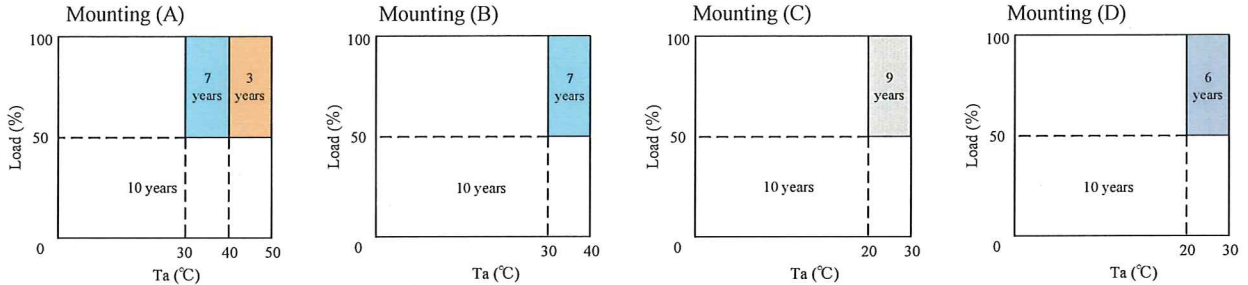

### 8. External Fuse Rating

Refer to the following fuse rating when selecting the external input fuse.  
 Surge current flows when input turn on. Use slow-blow fuse or time-lag fuse. Fast-blow fuse can not be used.  
 Fuse rating is specified by inrush current value at input turn on.  
 Do not select the fuse according to actual input current (rms.) values.

HWS30A/ME-100A/ME : 3.15A  
 HWS150A/ME : 5A

### 9. Before concluding that the unit is at fault...

Before concluding that the unit is at fault, make the following checks.

- (1) Check if the rated input voltage is connected.
- (2) Check if the wiring of input and output is correct.
- (3) Check if the wire size is not too thin.
- (4) Check if the output voltage control (V.ADJ) is properly adjusted.
- (5) Check if the remote sensing terminal is not opened. The output will rise and OVP may be triggered.
- (6) Check if the output current and output power does not over specification.
- (7) Audible noise can be heard when input voltage waveform is not sinusoidal wave.
- (8) Audible noise can be heard during Dynamic-Load operation.
- (9) Ensure that a large capacitor is not connected on the output side.

Please use within maximum capacitance shown below.

If connecting more than the following capacity, conditioning is needed. Please contact us for details.

MODEL	Maximum external capacitance				
	5V	12V	15V	24V	48V
HWS30A/ME, HWS50A/ME	10,000uF	5,000uF		2,000uF	500uF
HWS100A/ME, HWS150A/ME	10,000uF			5,000uF	1,000uF

## 10. Warranty Period

Warranty Period applies for Mounting (A).

For damages occurring at normal operation within this warranty period, repair is free of charge.

For other mounting directions inquire to TDK-Lambda.

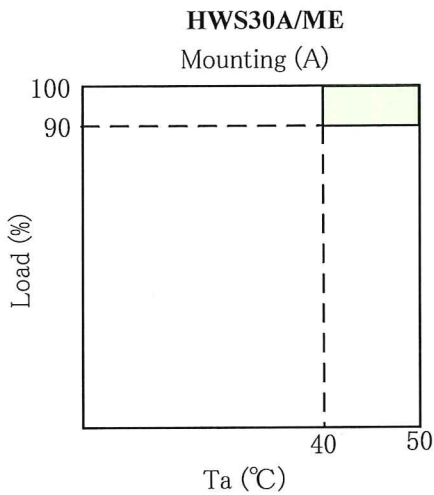

**HWS50A/ME, HWS100A/ME, HWS150A/ME**  
Mounting (A)

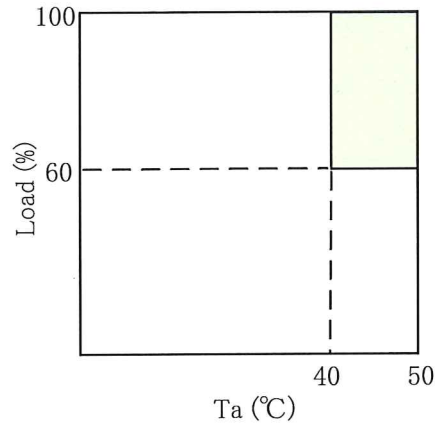

- Warranted for a period of 5 years
- Warranted for a period of 3 years

### Following cases are not covered by warranty

- (1) Improper usage like dropping products, applying shock and defects from operation exceeding specification of the unit.
- (2) Defects resulting from natural disaster (fire, flood etc.)
- (3) Unauthorized modifications or repair.