

PRODUCT NUMBER SEE SHEET 2

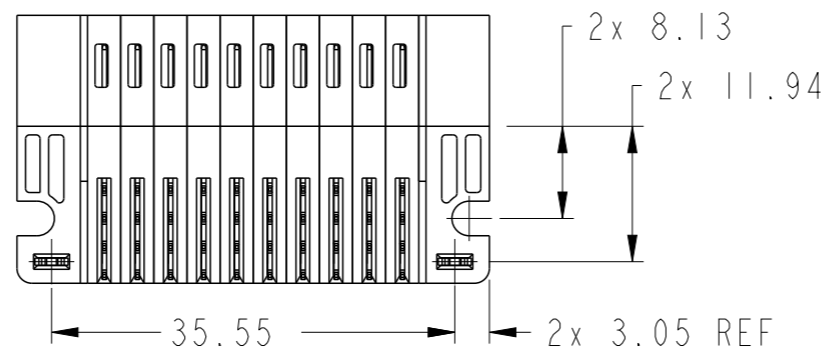

spec ref	*	dr	Rainbow Zhan	2014/08/07	projection	MM	size	A3	scale	3:2
tolerance std	ASME Y14.5	eng	Rainbow Zhan	2014/08/22			ecn no	-	rel level	Released
TOLERANCES UNLESS OTHERWISE SPECIFIED		chr	Li-He	2014/08/20						
surface	<input checked="" type="checkbox"/> linear <input type="checkbox"/> angular	appr	Pei-Ming Zheng	2014/08/22	product family	PwrBlade+	dwg no	10106262-0A00001	rev	A
ASME Y14.5	linear: 0.X ±0.5, 0.XX ±0.25, 0.XXX ±0.10 angular: 0° ±2°	www.fci.com		cat. no.	Product - Customer Drw		sheet 1 of 3			

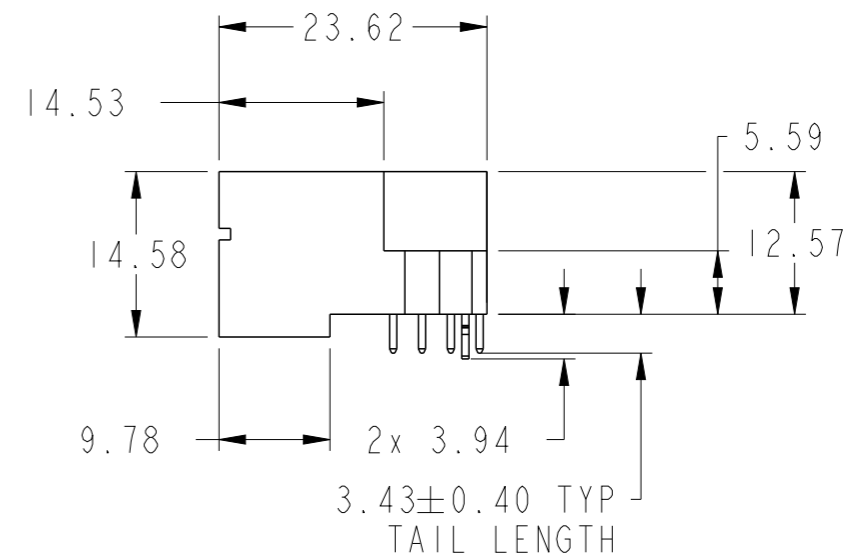
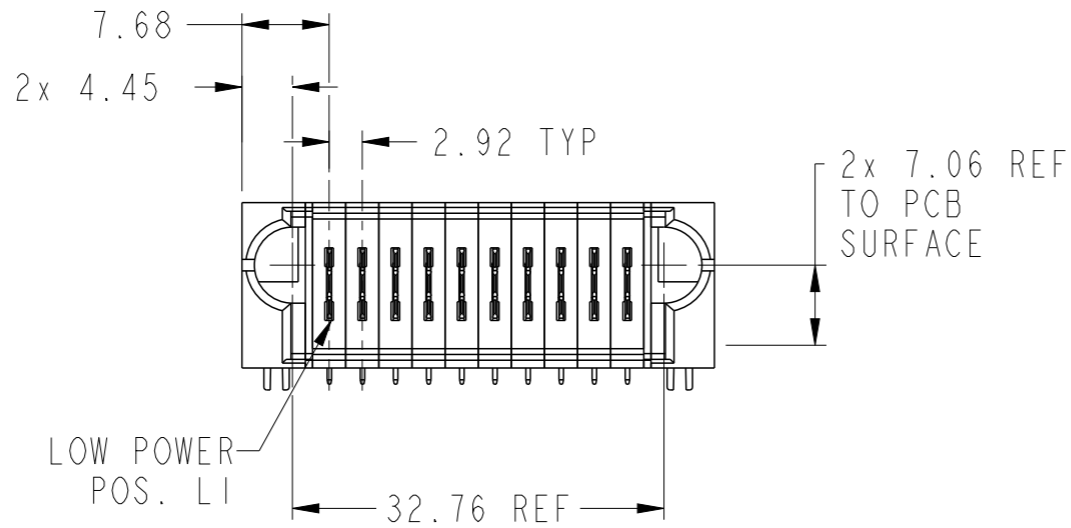
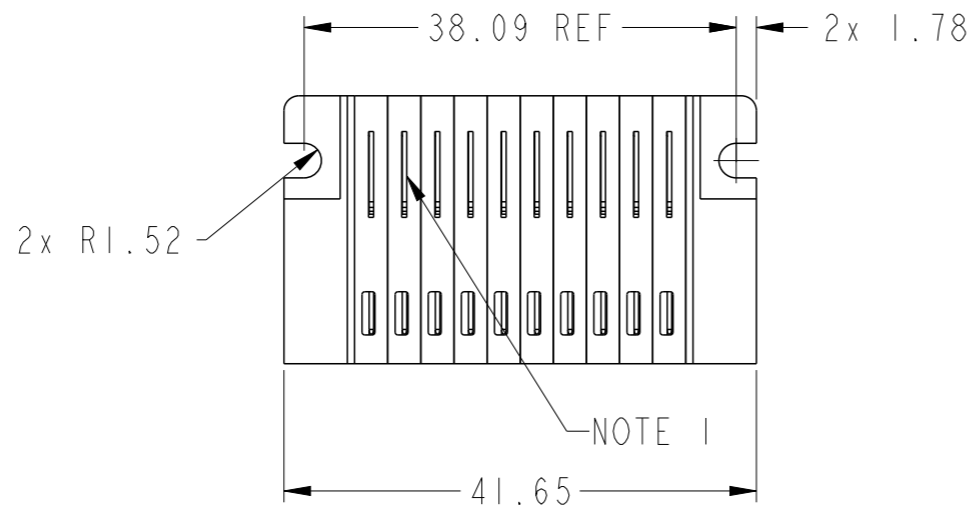

Copyright FCI.

PRODUCT NO.	ROWS	LP									
		E1	P1	P2	P3	P4	P5	P6	P7	P8	P9
10106262-0A00001LF	DCBA	LKLK LKLK LKLK LKLK LKLK LKLK LKLK LKLK LKLK LKLK									

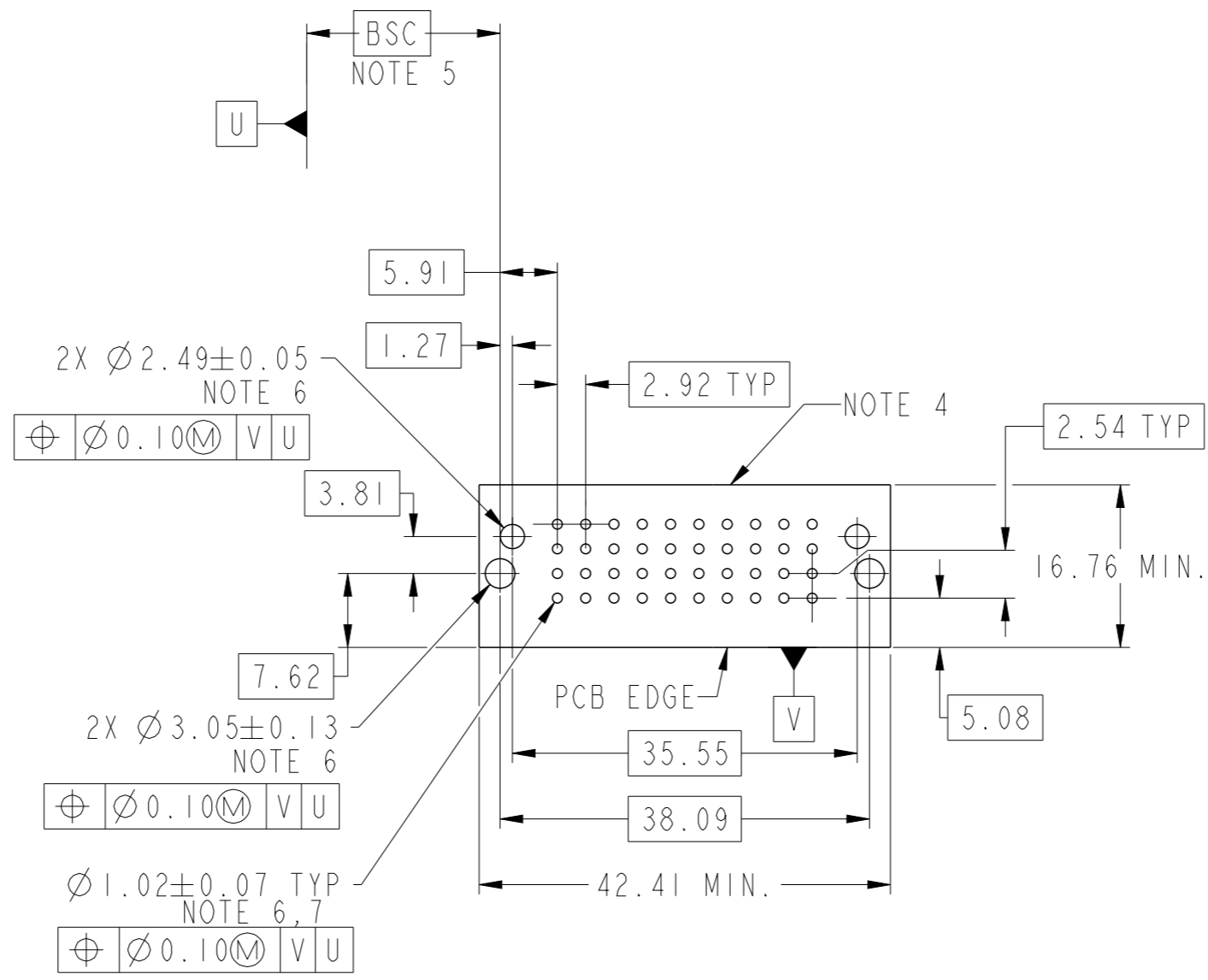

Copyright FCI.

CODE	DESCRIPTION
HA	METAL HOLD DOWN
LK	STD LOW POWER CONTACT (3.43)



dr	Rainbow Zhan	2014/08/07	projection 	MM 	size	A3	scale	3:2
eng	Rainbow Zhan	2014/08/22			ecn no	-		
chr	Li-He	2014/08/20			rel level	Released		
appr	Pei-Ming Zheng	2014/08/22	product family	PwrBlade+				
		title 10LP RA STB HEADER		dwg no 10106262-0A00001	rev A			
www.fci.com			cat. no.	Product - Customer Drw		sheet 2 of 3		

NOTES:

- 1) "FCI", PART NUMBER AND DATE CODE TO BE MARKED ON THIS SURFACE.
THE MARK CAN BE OMITTED IF THERE IS NOT ENOUGH SPACE ON THIS SURFACE.
- 2) MATERIALS:
-HOUSING - GLASS FILLED WITH HIGH TEMP THERMOPLASTIC, UL94V-0.
-SIGNAL CONTACT - COPPER ALLOY.
-POWER CONTACT - HIGH CONDUCTIVITY COPPER ALLOY.
- 3) PLATING SPECIFICATION REFER TO FCI 10116351
- 4) DENOTES CONNECTOR KEEP OUT ZONE.
- 5) DATUM AND BASIC DIMENIONS WERE ESTABLISHED BY CUSTOMER.
- 6) ALL HOLE DIAMETERS ARE FINISHED HOLE SIZES.
- 7) 1.15±0.025MM DRILLED HOLE PLATED WITH 0.00762MM MIN Sn
OVER 0.0254-0.0762MM Cu PLATING TO ACHIEVE A 1.02±0.07MM HOLE.
- 8) PRODUCT SPECIFICATION REFER TO FCI GS-12-658.
APPLICATION SPECIFICATION REFER TO FCI GS-20-141.
PRODUCT PACKAGED IN TRAYS, REFER TO FCI GS-14-1502.

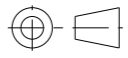
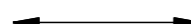

Copyright FCI.

dr	Rainbow Zhan	2014/08/07	projection 	MM 	size	A3	scale	3:2
eng	Rainbow Zhan	2014/08/22			ecn no	-		
chr	Li-He	2014/08/20			rel level	Released		
appr	Pei-Ming Zheng	2014/08/22	product family	PwrBlade+				
		title 10LP RA STB HEADER		dwg no 10106262-0A00001	rev A			
www.fci.com		cat. no.		Product - Customer Drw			sheet 3 of 3	