

Features

Regulated Converters

- 4:1 Wide Input Range
- 3kVAC Reinforced Insulation for 110Vin
2.25kVDC Basic Insulation for 24Vin & 48Vin
- Efficiency up to 90%
- No Minimum Load Required
- EN50155 Certified
- IEC/EN60950-1 Certified



RP120Q-RW

**120 Watt
Quarter
Brick
Single Output**



Description

The quarter-brick RP120Q series DC/DC converters are designed for railway rolling stock and high voltage battery applications. Each series has three 4:1 input voltage range options to cover all input voltages from 9VDC up to 160VDC with isolated and regulated 5V to 48VDC outputs. The converters have high efficiencies and metal base-plates to permit a wide operating temperature range from -40°C to +85°C (when mounted on a suitable heatsink). The case is fitted with threaded inserts to allow secure mounting to the PCB or bulkhead for use in high shock and vibration environments. The converters are EN50155 and IEC/EN60950 certified. The RP120Q-RW series have a three year warranty.

Selection Guide

Part Number	Input Voltage Range [VDC]	Output Voltage [VDC]	Output Current [mA]	Input Current [mA]	Output Power [W]	Efficiency ⁽¹⁾ typ. [%]	Max. Capacitive Load [µF]
RP120Q-2405SRW	9-36	5	24000	5618	120	89	48000
RP120Q-2412SRW	9-36	12	10000	5682	120	88	8300
RP120Q-2415SRW	9-36	15	8000	5618	120	89	5300
RP120Q-2424SRW	9-36	24	5000	5682	120	88	2100
RP120Q-2448SRW	9-36	48	2500	5682	120	88	520
RP120Q-4805SRW	16.5-75	5	24000	2809	120	89	48000
RP120Q-4812SRW	16.5-75	12	10000	2809	120	89	8300
RP120Q-4815SRW	16.5-75	15	8000	2777	120	90	5300
RP120Q-4824SRW	16.5-75	24	5000	2777	120	90	2100
RP120Q-4848SRW	16.5-75	48	2500	2777	120	90	520
RP120Q-11005SRW	40-160	5	24000	1225	120	89	48000
RP120Q-11012SRW	40-160	12	11000	1363	132	88	9170
RP120Q-11015SRW	40-160	15	8600	1317	130	89	5730
RP120Q-11024SRW	40-160	24	5500	1348	132	89	2290
RP120Q-11048SRW	40-160	48	2700	1323	130	89	560

Notes:

Note1: Efficiency is tested by nominal Vin, full load and at 25°C.

Model Numbering

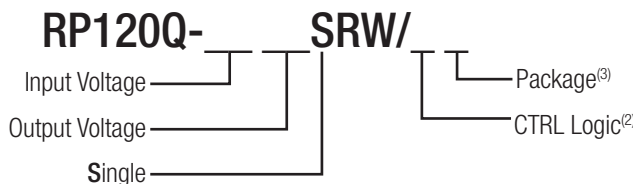

Ordering Examples

- RP120Q-2405SRW/N = 24V Input, 5V Output, Single, Neg. CTRL function
- RP120Q-11012SRW/P = 110V Input, 12V Output, Single, Pos. CTRL function
- RP120Q-2405SRW/N-HC = 24V Input, 5V Output, Single, Neg. CTRL function, with premounted Heat-sink

Notes:

- Note2: standard part is with suffix "P" for positive logic (1=ON, 0=OFF) or add suffix "N" instead for negative logic (0=ON, 1=OFF)
- Note3: add suffix "-HC" for premounted Heat-sink (compatible with all other suffixes)



EN50155 Certified
IEC/EN60950-1 Certified

Specifications measured @ $t_a = 25^\circ\text{C}$, resistive load, nominal V_{in} and rated I_{out} unless otherwise noted

BASIC CHARACTERISTICS					
Parameter	Condition		Min.	Typ.	Max.
Internal Input Filter			Pi-Type		
Input Voltage Range	nom $V_{in} = 24\text{V}$ nom $V_{in} = 48\text{V}$ nom $V_{in} = 110\text{V}$		9VDC 16.5VDC 40VDC	24VDC 48VDC 110VDC	36VDC 75VDC 160VDC
Input Surge Voltage	$V_{in} = 24\text{V}$, 1s max. $V_{in} = 48\text{V}$, 1s max. $V_{in} = 110\text{V}$, 1s max.				50VDC 100VDC 185VDC
Quiescent Current	$V_{in} = 24\text{V}$ $V_{in} = 48\text{V}$ $V_{in} = 110\text{V}$			25ma 15mA 8mA	
Start-up time	Power up ON/OFF Control			75ms 75ms	100ms 100ms
Internal Operating Frequency			270kHz	300kHz	330kHz
Minimum Load			0%		
Ripple and Noise	Measured by 20MHz BW with a 22 μF /25V X7R MLCC with a 22 μF /25V X7R MLCC with a 4.7 μF /50V X7R MLCC with a 2.2 μF /100V X7R MLCC	5 V_{out} 12, 15 V_{out} 24 V_{out} 48 V_{out}		75mVp-p 100mVp-p 200mVp-p 300mVp-p	
Under Voltage Lockout (UVLO)	$V_{in} = 24\text{V}$	DC-DC ON DC-DC OFF	7.3VDC		9VDC 8.1VDC
	$V_{in} = 48\text{V}$	DC-DC ON DC-DC OFF	15.5VDC		18VDC 16.3VDC
	$V_{in} = 110\text{V}$	DC-DC ON DC-DC OFF	33VDC		43VDC 36VDC
ON/OFF Control	Positive Logic	DC-DC ON DC-DC OFF	Open or $3.0\text{V} < V_r < 12\text{V}$ Short or $0\text{V} < V_r < 1.2\text{V}$		
	Negative Logic	DC-DC ON DC-DC OFF	Short or $0\text{V} < V_r < 1.2\text{V}$ Open or $3.0\text{V} < V_r < 12\text{V}$		
Input Current of CTRL pin			-0.5mA		1mA
Standby Current				3mA	
Output Trim			-20%		+10%
Remote Sense	% of set V_{out}				10%

RP120Q-2405SRW

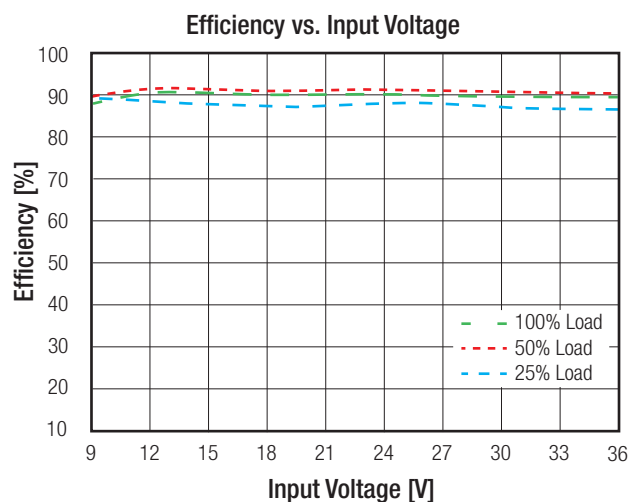
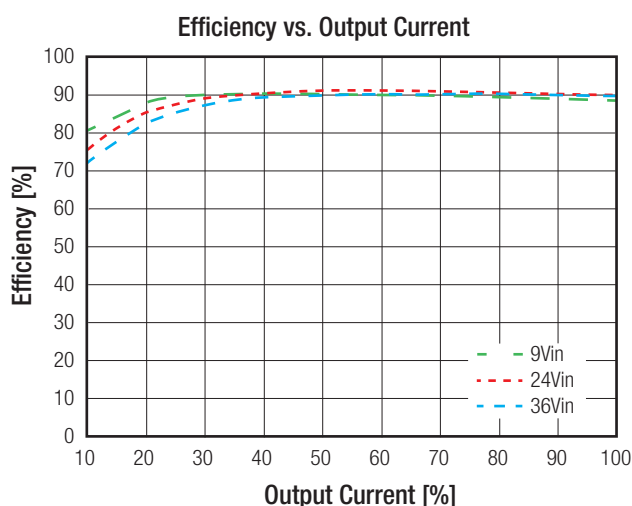

continued on next page

Specifications measured @ $t_a = 25^\circ\text{C}$, resistive load, nominal V_{in} and rated I_{out} unless otherwise noted

RP120Q-2405SRW

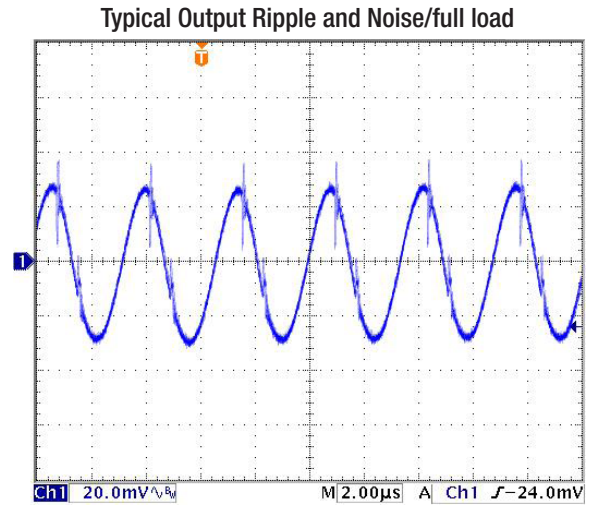
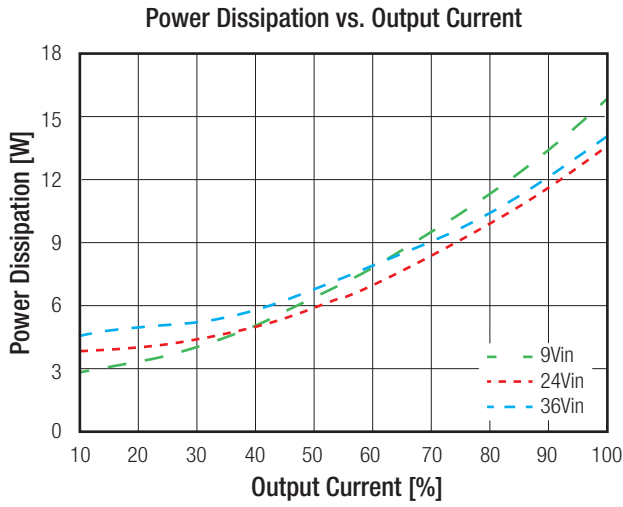

ON/OFF Control Start up Rise Characteristic

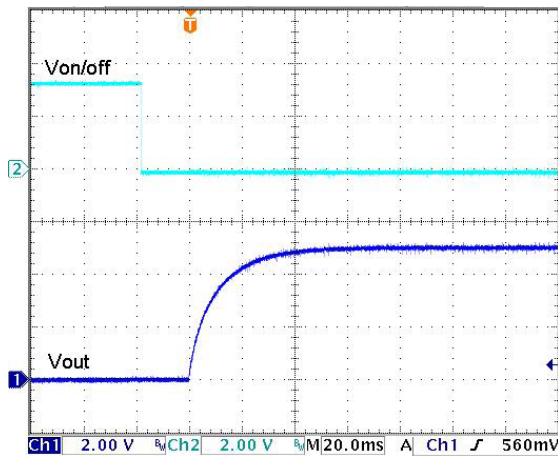

Power up Start-up Rise Characteristic

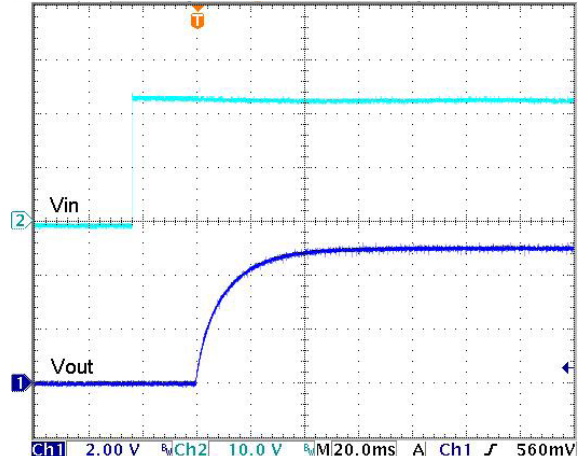

RP120Q-4805SRW

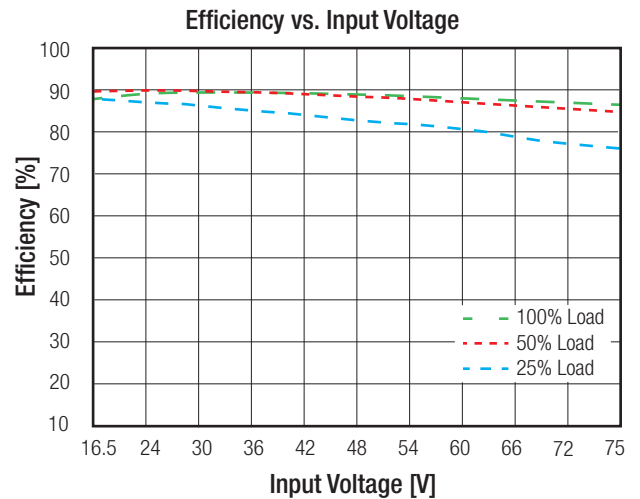
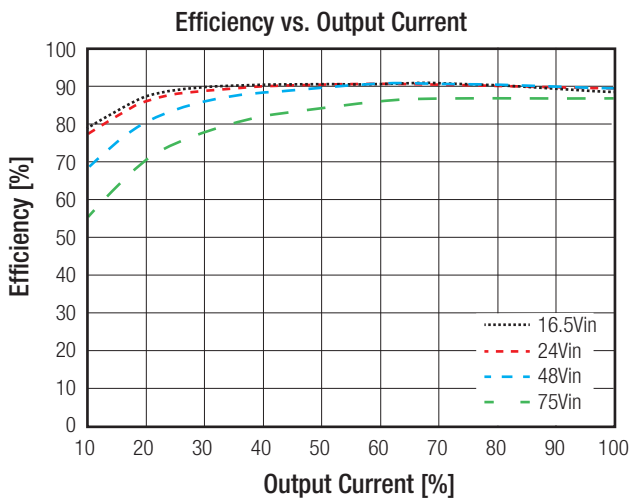

continued on next page

Specifications measured @ $t_a = 25^\circ\text{C}$, resistive load, nominal V_{in} and rated I_{out} unless otherwise noted

RP120Q-4805SRW

Power Dissipation vs. Output Current

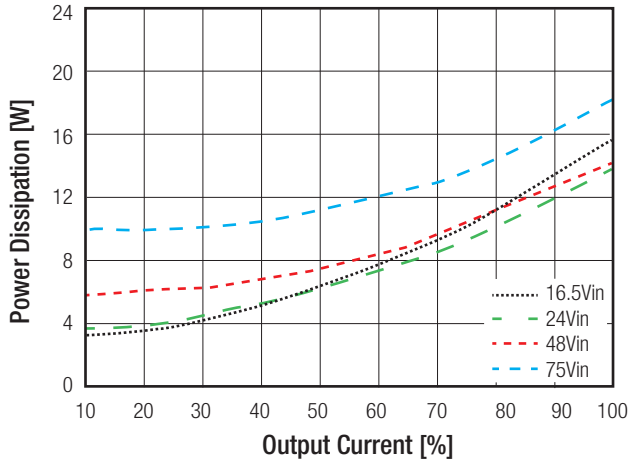

Typical Output Ripple and Noise/full load

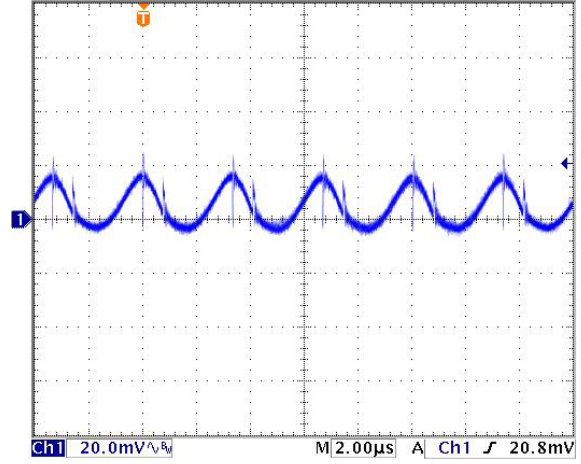

ON/OFF Control Start up Rise Characteristic

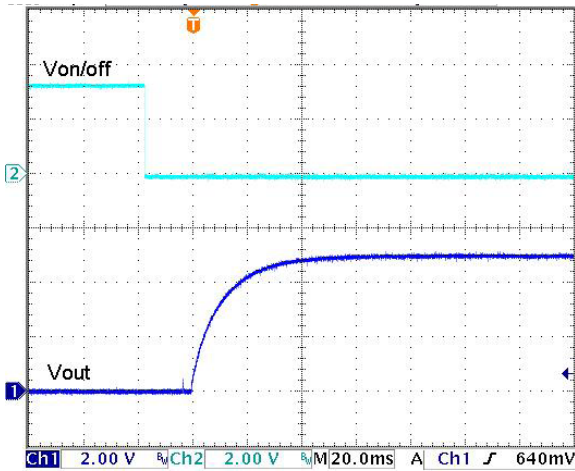

Power up Start-up Rise Characteristic

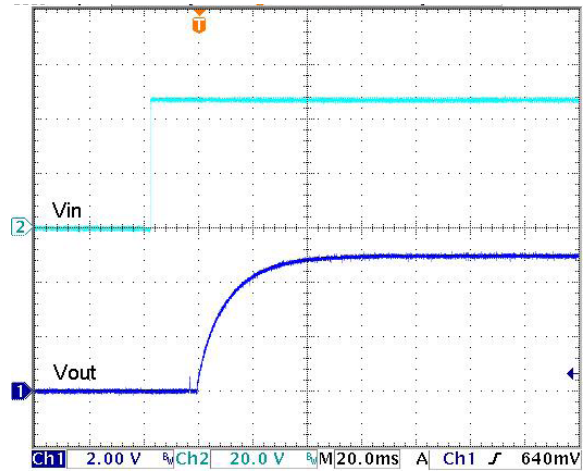

RP120Q-11005SRW

Efficiency vs. Output Current

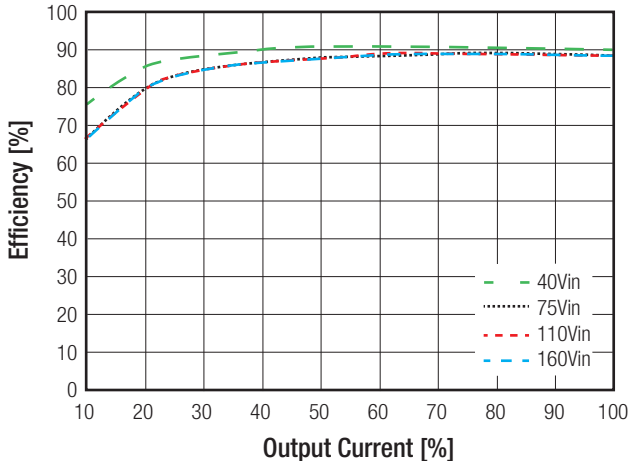

Efficiency vs. Input Voltage

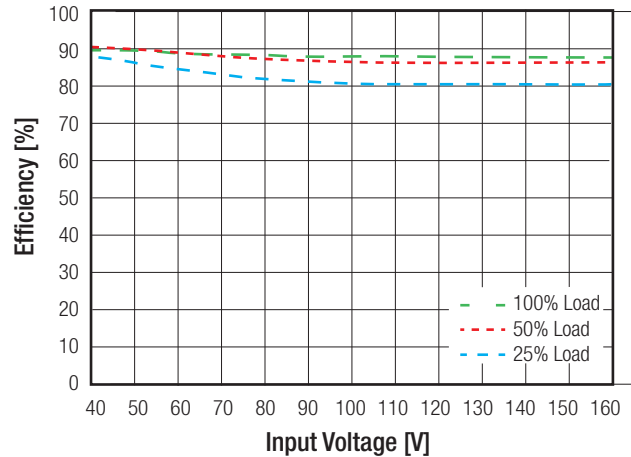

continued on next page

Specifications measured @ $t_a = 25^\circ\text{C}$, resistive load, nominal V_{in} and rated I_{out} unless otherwise noted

RP120Q-11005SRW

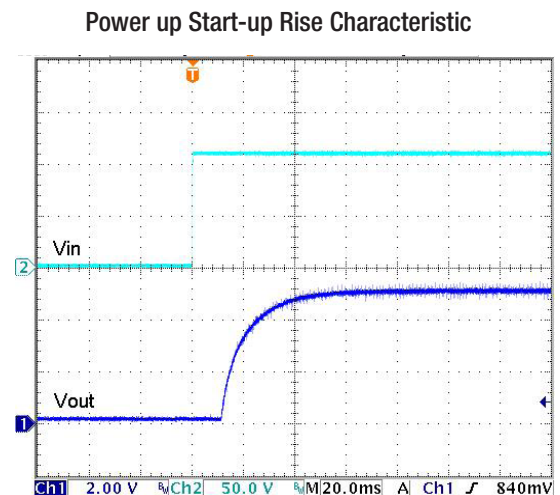
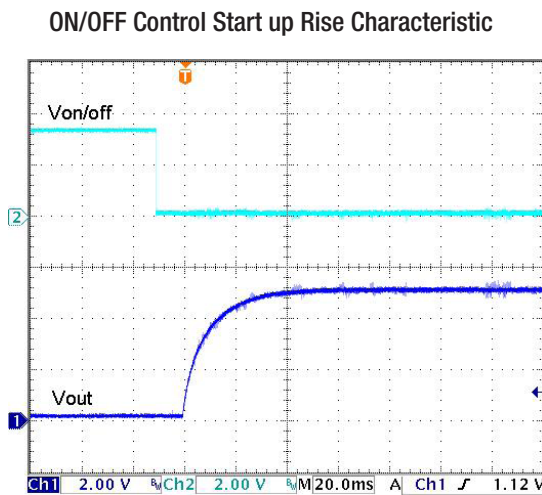
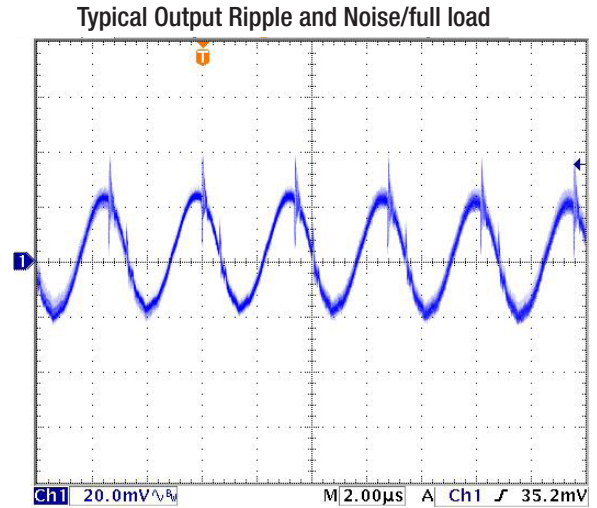
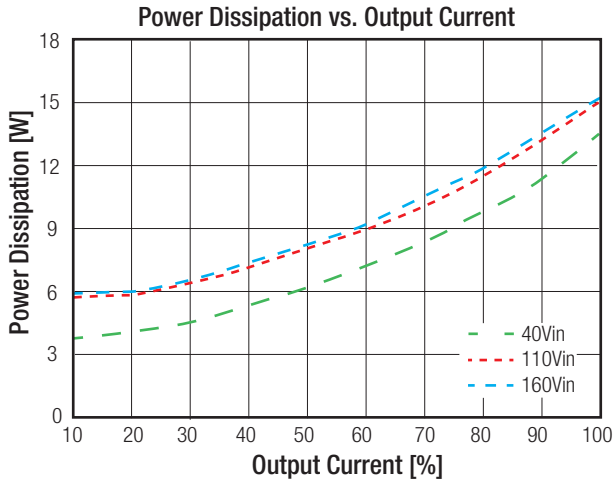

OUTPUT TRIM

Output Voltage Trimming

RP120Q-RW converters offer the feature of trimming the output voltage over a certain range around the nominal value by using external trim resistors. The values for trim resistors shown in trim tables below are according to standard E96 values; therefore, the specified voltage may slightly vary; they also can be calculated with below shown equation.

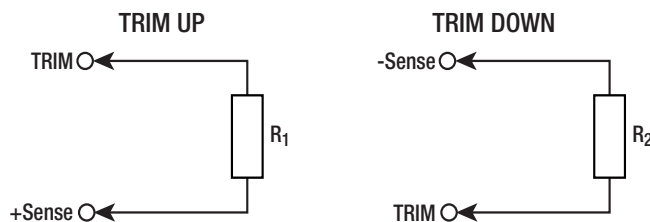

OUTPUT TRIM

Trim Calculation

$$R_1 = \left[\frac{511 \cdot V_{out} + 5.11 \Delta V_{out} \cdot V_{out}}{1.225 \cdot \Delta V_{out}} - \frac{(511 + 10.22 \Delta V_{out})}{\Delta V_{out}} \right] k\Omega$$

$$R_2 = \left[\frac{511}{\Delta V_{out}} - 10.22 \right] k\Omega$$

Vout = Output Voltage
 ΔVout = Output Voltage Trim in %
 R1 = trim up resistor
 R2 = trim down resistor

Practical Example:
Trim Up:

Vout = 5V, ΔVout = 10% (5.5V)

$$R_1 = \left[\frac{511 \cdot V_{out} + 5.11 \Delta V_{out} \cdot V_{out}}{1.225 \cdot \Delta V_{out}} - \frac{(511 + 10.22 \Delta V_{out})}{\Delta V_{out}} \right] k\Omega = \frac{511 \cdot 5 + 5.11 \cdot 10 \cdot 5}{1.225 \cdot 10} - \frac{511 + 10.22 \cdot 10}{10} = 229.43 - 61.32 = 169 k\Omega$$

Trim down:

Vout = 5V, ΔVout = -10% (4.5V)

$$R_2 = \left[\frac{511}{\Delta V_{out}} - 10.22 \right] k\Omega = \frac{511}{10} - 10.22 = 41.2 k\Omega$$

RP120Q-xx05SRW

Trim up	1	2	3	4	5	6	7	8	9	10	%
Vout =	5.05	5.10	5.15	5.20	5.25	5.30	5.35	5.4	5.45	5.50	Volts
R ₁ =	1580	806	536	402	324	247	237	205	187	169	KOhms

RP120Q-xx12SRW

Trim up	1	2	3	4	5	6	7	8	9	10	%
Vout =	12.12	12.24	12.36	12.48	12.60	12.72	12.84	12.96	13.08	13.20	Volts
R ₁ =	4530	2320	1540	1150	931	787	681	604	536	487	KOhms

RP120Q-xx15SRW

Trim up	1	2	3	4	5	6	7	8	9	10	%
Vout =	15.15	15.30	15.45	15.60	15.75	15.90	16.05	16.20	16.35	16.50	Volts
R ₁ =	5760	2940	1960	1470	1210	1020	866	768	698	619	KOhms

RP120Q-xx24SRW

Trim up	1	2	3	4	5	6	7	8	9	10	%
Vout =	24.24	24.48	24.72	24.96	25.20	25.44	25.68	25.92	26.16	26.40	Volts
R ₁ =	9530	4870	3240	2940	2000	1690	1470	1270	1150	1050	KOhms

RP120Q-xx48SRW

Trim up	1	2	3	4	5	6	7	8	9	10	%
Vout =	48.48	48.96	49.44	49.92	50.40	50.88	51.36	51.84	52.32	52.80	Volts
R ₁ =	19600	9945	6650	5110	4120	3400	3010	2610	2370	2150	KOhms

Trim Down all Vout's

Trim down	1	2	3	4	5	6	7	8	9	10	%
R ₂ =	499	243	162	118	909	75	63.4	53.6	46.4	41.2	KOhms
Trim down	11	12	13	14	15	16	17	18	19	20	%
R ₂ =	36.5	32.4	28.7	26.1	23.7	21.5	19.6	18.2	16.5	15.4	KOhms

continued on next page

Specifications (measured @ $t_a = 25^\circ\text{C}$, nominal input voltage, full load and after warm-up)

Remote Sense

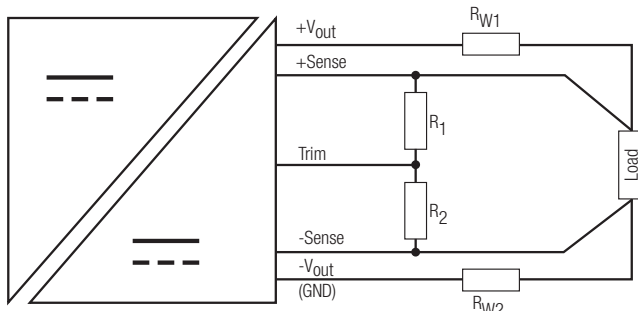

The output voltage can be adjusted by both trim and remote sense. The maximum combined adjustment range $\pm 10\%$. Derate the maximum output power if using the trim or sense function.

R_{W1} ... wire losses +
 R_{W2} ... wire losses -
 R_1 ... trim up resistor
 R_2 ... trim down resistor

REGULATIONS

Parameter	Condition	Value
Output Accuracy		$\pm 1.0\%$
Line Regulation	low line to high line at full load	$\pm 0.1\%$
Load Regulation	0% to 100% load	$\pm 0.2\%$
	5Vout others	$\pm 0.1\%$
Transient Response	25% load step change	250 μs typ.

Transient Response to Dynamic Load Change from 100% to 75% to 100% of Full Load at nom. Vin

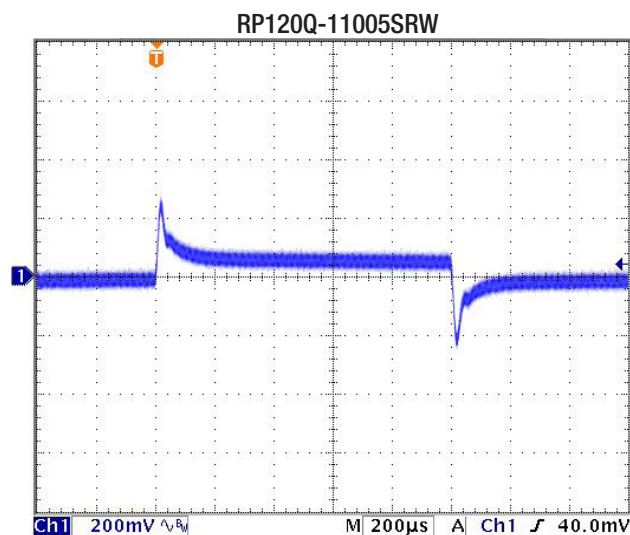
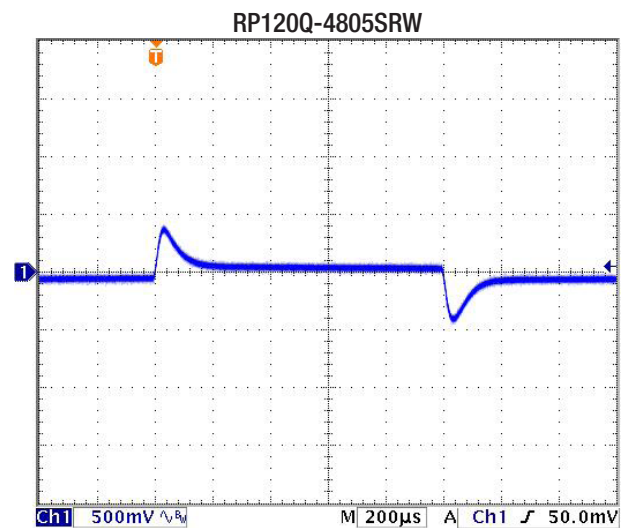
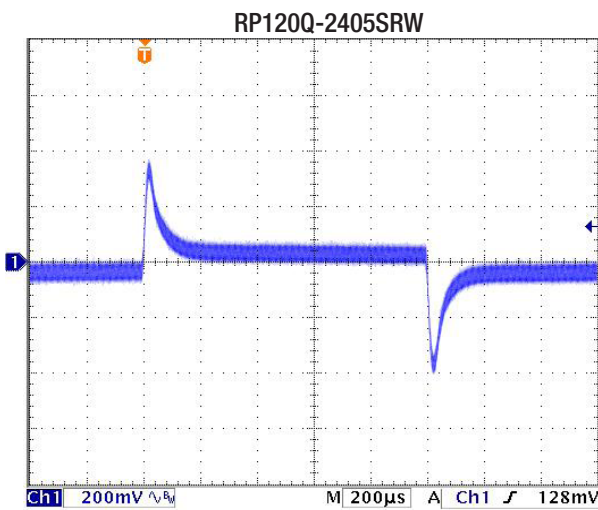

Specifications (measured @ $t_a = 25^\circ\text{C}$, nominal input voltage, full load and after warm-up)

PROTECTIONS		
Parameter	Condition	Value
Short Circuit Protection (SCP)	below 100mΩ	continuous, automatic recovery
Over Voltage Protection (OVP)	% of nom. Vout	115%-130%, Hiccup Mode
Over Load Protection (OLP)	% Iout rated	110%-140%, Hiccup Mode
Over Temperature Protection (OTP)		+110°C
Isolation Voltage	110Vin	I/P to O/P I/P or O/P to Baseplate
	24Vin, 48Vin	I/P to O/P I/P or O/P to Baseplate
		3kVDC/1minute 1.5kVDC/1minute 2.25kVDC/1minute 2.25kVDC/1minute
Isolation Resistance	500 VDC	1GΩ min.
Isolation Capacitance		1500pF max.
Isolation Grade	110Vin	Reinforced Insulation
	24Vin, 48Vin	Basic Insulation

Notes:

Note4: An input fuse is required if the mains supply isn't over-current protected. Recommended fuse: T50A slow blow.

ENVIRONMENTAL

Parameter	Condition	Value
Operating Baseplate Temperature Range		-40°C to +100°C
Maximum Case Temperature		100°C
Temperature Coefficient		±0.02%/°C max.
Thermal Impedance	vertical direction by natural convection (0.1m/s) without Heat-sink	9°C/W
	vertical direction by natural convection (0.1m/s) with Heat-sink	7.1°C/W
Operating Humidity		5% - 95% RH
Pollution Degree		PD2
Shock		according to EN61373 standard
Thermal Shock		according to MIL-STD-810F standard
Vibration		according to EN61373 standard
Fire protection on railway vehicles		according to EN45545-2, 2013 standard
MTBF	according to MIL-HDBK-217F standard, 25°C	507.0 x 10 ³ hours

Thermal Calculation

$$R_{th\text{case-ambient}} = 9^\circ\text{C/W (vertical)}$$

$$R_{th\text{case-ambientHC}} = 7.1^\circ\text{C/W (vertical)}$$

$$R_{th\text{case-ambient}} = \frac{T_{\text{case}} - T_{\text{ambient}}}{P_{\text{dissipation}}}$$

$$P_{\text{dissipation}} = P_{\text{IN}} - P_{\text{OUT}} = \frac{P_{\text{OUTapp}}}{\eta} - P_{\text{OUTapp}}$$

T_{case} = Case Temperature

T_{ambient} = Environment Temperature

$P_{\text{dissipation}}$ = Internal losses

P_{IN} = Input Power

P_{OUT} = Output Power

η = Efficiency under given Operating Conditions

$R_{th\text{case-ambient}}$ = Thermal Impedance

Practical Example:

Take the RP120Q-2405SRW with 9V input Voltage and 50% load. What is the maximum ambient operating temperature? Use converter vertical in application without airflow.

$$\text{Eff}_{\text{min}} = 91\% @ V_{\text{nom}}$$

$$P_{\text{OUT}} = 120\text{W}$$

$$P_{\text{OUTapp}} = 120 \times 0.5 = 60\text{W}$$

$$\eta = 91\% \text{ (Efficiency vs. Load Graph)}$$

$$P_{\text{dissipation}} = \frac{60}{0.91} - 60 = 5.93\text{W}$$

without Heat-sink

$$R_{\text{th}} = \frac{T_{\text{casemax}} - T_{\text{amb}}}{P_{\text{dissipation}}} \rightarrow 9^\circ\text{C/W} = \frac{100 - T_{\text{amb}}}{5.93\text{W}}$$

$$T_{\text{amb}} = 46^\circ\text{C}$$

with Heat-sink

$$R_{\text{thHC}} = \frac{T_{\text{casemax}} - T_{\text{amb}}}{P_{\text{dissipation}}} \rightarrow 7.5^\circ\text{C/W} = \frac{100 - T_{\text{amb}}}{5.93\text{W}}$$

$$T_{\text{ambHC}} = 57^\circ\text{C}$$

continued on next page

Specifications (measured @ $t_a = 25^\circ\text{C}$, nominal input voltage, full load and after warm-up)

Derating Graph⁽⁵⁾

(@ Chamber - tested with forced convection)

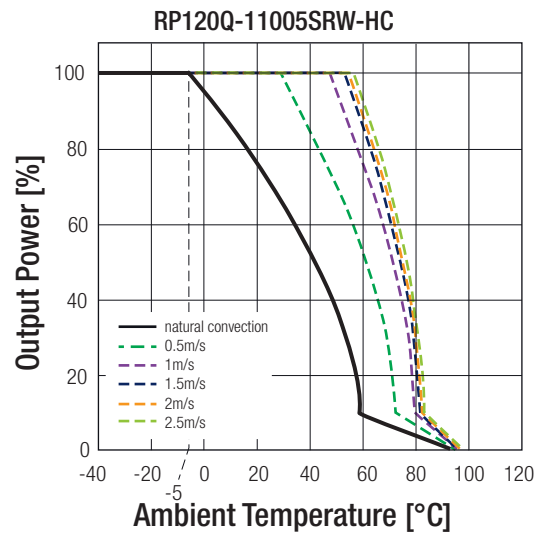
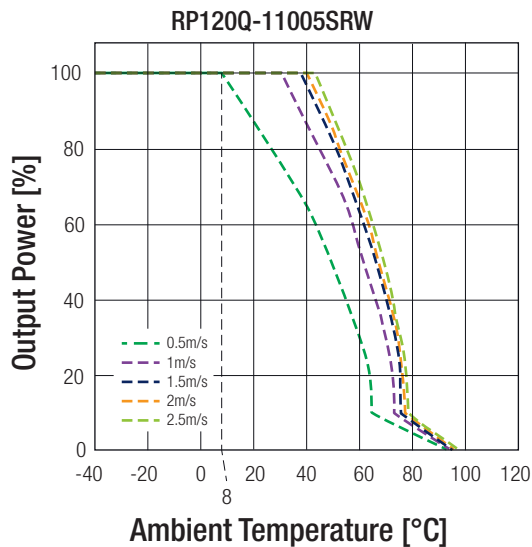
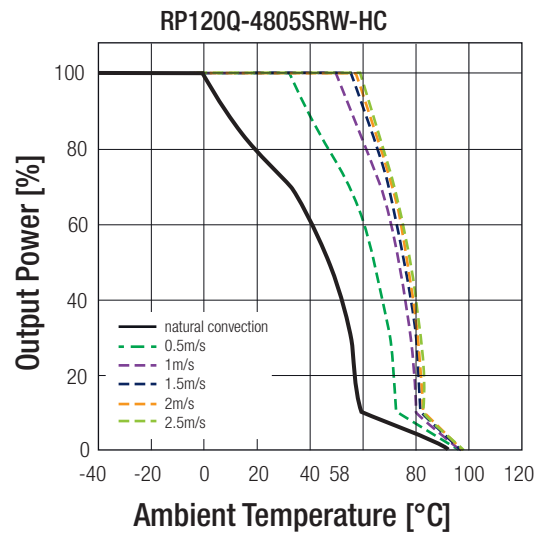
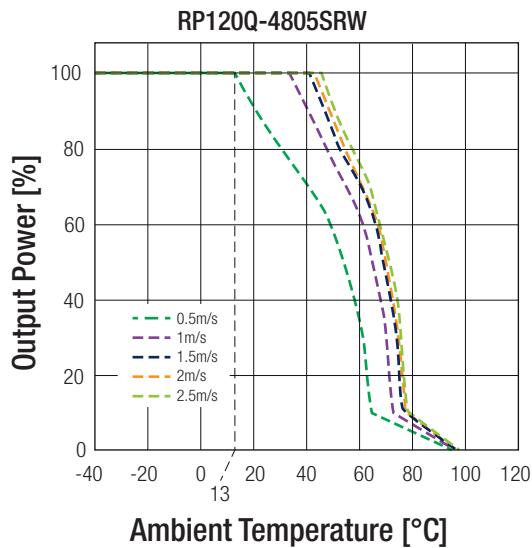
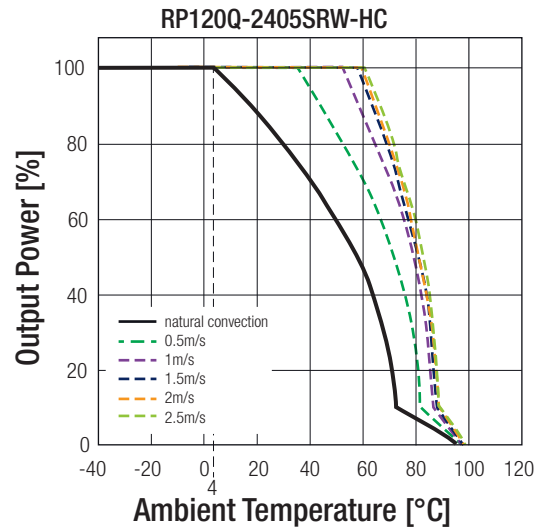
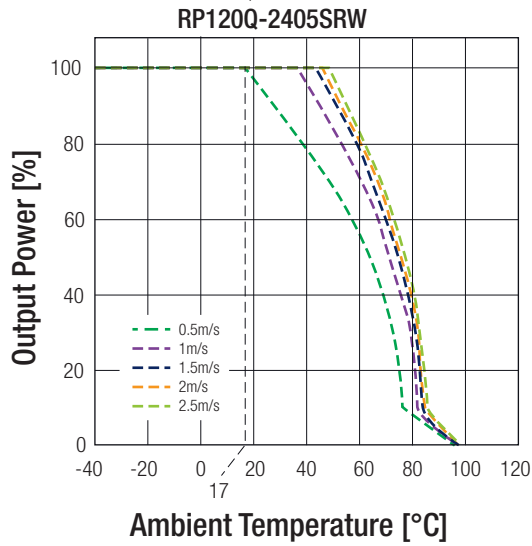

Notes:

Note5: Derating graphs are valid only for the shown part numbers. If you need detailed derating-information about a part-number not shown here please contact our technical support service at techsupportAT@recom-power.com

Specifications (measured @ $t_a = 25^\circ\text{C}$, nominal input voltage, full load and after warm-up)

SAFETY AND CERTIFICATIONS

Certificate Type (Safety)	Report / File Number	Standard
IEC/EN Information Technology Equipment - General Requirements for Safety	TW1608086-001	IEC/EN60950-1, 2nd Edition, 2005
Railway Applications - Electrical Equipment used on rolling stock	TW1608078-001	EN50155, 2007

EMI Compliance	Condition	Standard / Criterion
Information technology equipment - Radio disturbance characteristics - Limits and methods of measurement	with external filter	EN55022, Class A and Class B
Industrial, scientific and medical equipment - Radio frequency disturbance characteristics - Limits and methods of measurement		EN55011, Class A and Class B
ESD Electrostatic discharge immunity test	Air $\pm 8\text{kV}$ and Contact $\pm 6\text{kV}$ 20 V/m $\pm 2\text{kV}$ EN55024 & EN50155 $\pm 2\text{kV}$ 10 Vr.m.s 100A/m continuous; 1000A/m 1s	EN61000-4-2, Criteria A
Radiated, radio-frequency, electromagnetic field immunity test		EN61000-4-3, Criteria A
Fast Transient and Burst Immunity ⁽⁶⁾		EN61000-4-4, Criteria A
Surge Immunity ⁽⁶⁾		EN61000-4-5, Criteria A
Immunity to conducted disturbances, induced by radio-frequency fields		EN61000-4-6, Criteria A
Power Magnetic Field Immunity		EN61000-4-8, Criteria A

Notes:

Note6: An external input filter capacitor is required if the module has to meet EN61000-4-4 and EN61000-4-5.

The **24Vin** and **48Vin** version recommend 2pcs of aluminium electrolytic capacitor to connect in parallel.
Recom suggest: Nippon Chemi-con KY series, 220 μF /100V.

The **110Vin** version recommend 2pcs of aluminium electrolytic capacitor to connect in parallel.
Recom suggest: Nippon Chemi-con KXJ series, 150 μF /200V

EMI Filtering according to EN55022/11 Class A and EN50121-1 (24Vin and 48Vin)

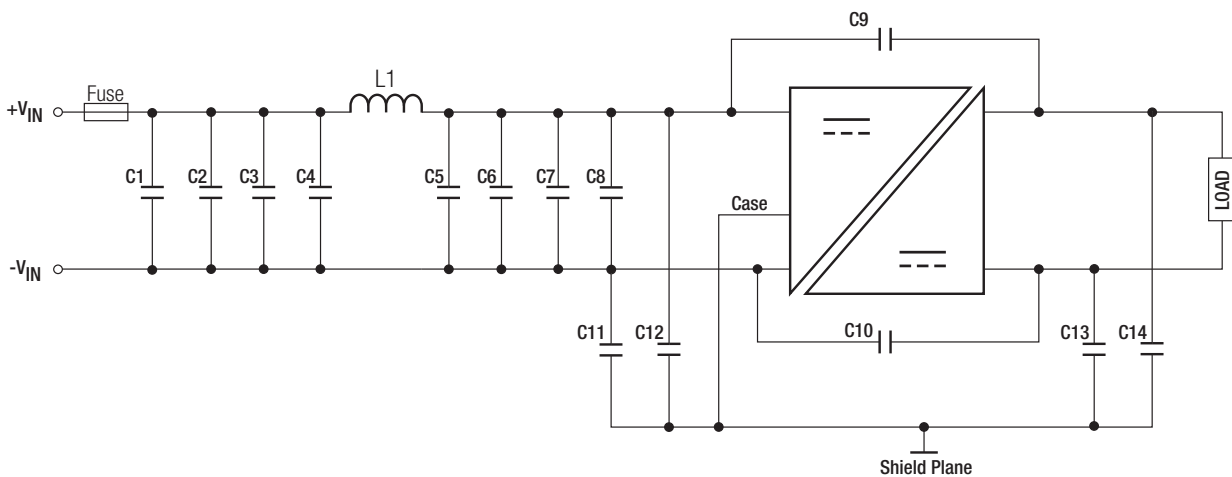

MODEL	C1	C2, C3, C4	C5	C6, C7, C8	C9 to C14	L1
RP120Q-24xxSRW	N/A	6.8 μF , 50V 1812 MLCC	N/A	6.8 μF , 50V 1812 MLCC	1000pF, 3kV 1808 MLCC	0.68 μH , 17A SMD Inductor
RP120Q-48xxSRW	4.7 μF , 100V 1812 MLCC	4.7 μF , 100V 1812 MLCC	4.7 μF , 100V 1812 MLCC	4.7 μF , 100V 1812 MLCC	1000pF, 3kV 1808 MLCC	3.3 μH , 10A SMD Inductor

continued on next page

Specifications (measured @ ta= 25°C, nominal input voltage, full load and after warm-up)

RP120Q-2405SRW

Conducted Emission EN55022 Class A

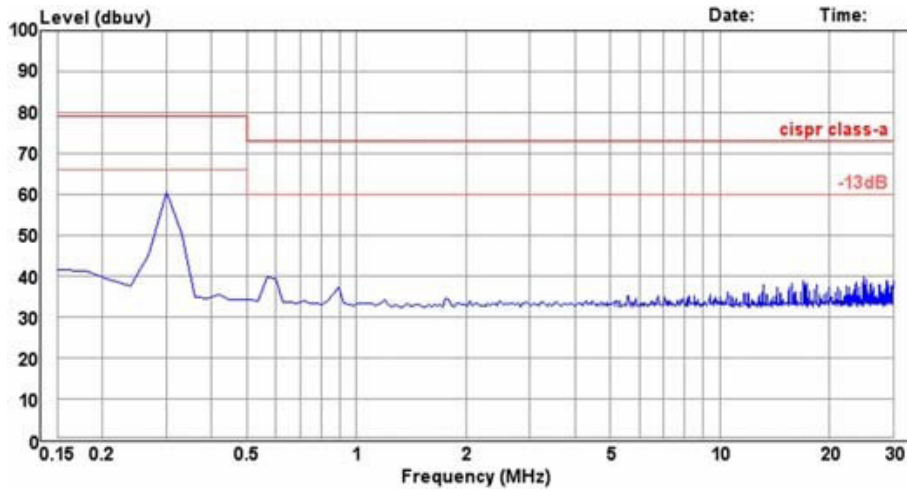

RP120Q-4805SRW

Conducted Emission EN55022 Class A

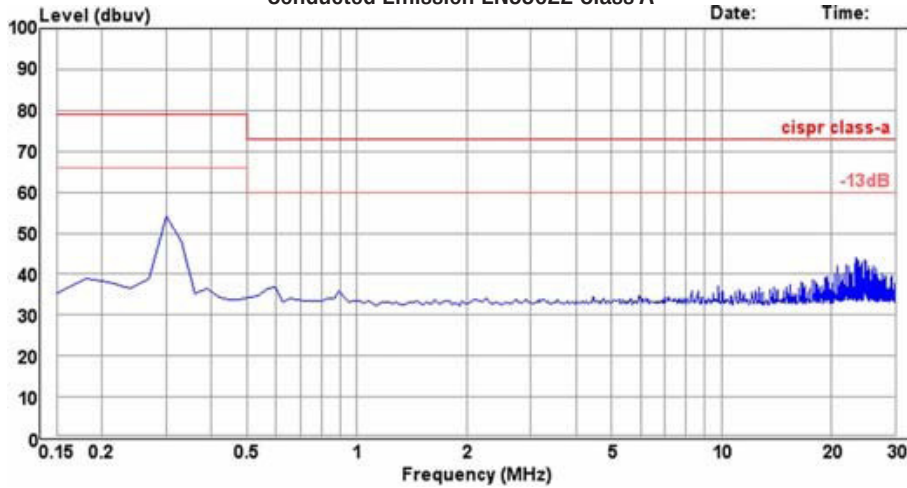

EMI Filtering according to EN55022/11 Class A and EN50121-1 (110Vin)

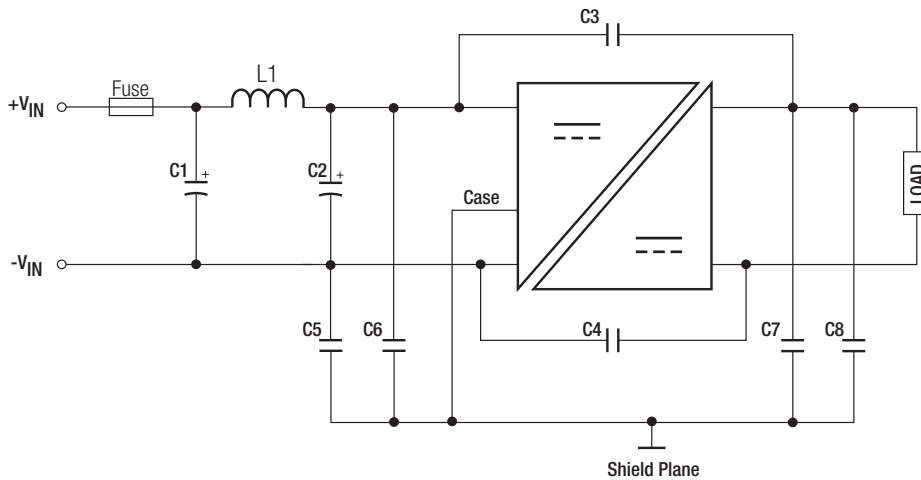

MODEL	C1, C2	C3 to C8	L1
RP120Q-110xxSRW	39µF, 250V Al cap. (lie down) Rubycon BXF	1000pF, 3kV 1808 MLCC	30.1µH, 5A SMD Inductor

continued on next page

Specifications (measured @ $t_a = 25^\circ\text{C}$, nominal input voltage, full load and after warm-up)

RP120Q-11005SRW

Conducted Emission EN55022 Class A

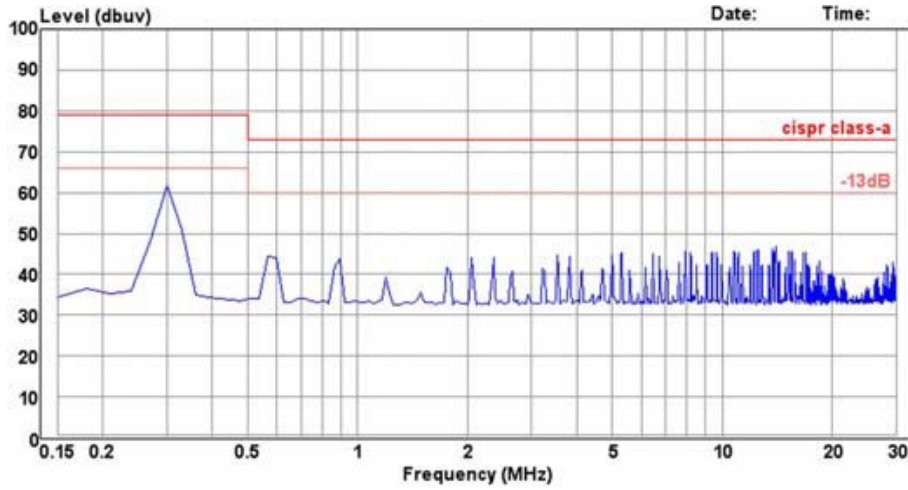

EMI Filtering according to EN55022/11 Class B (24Vin)

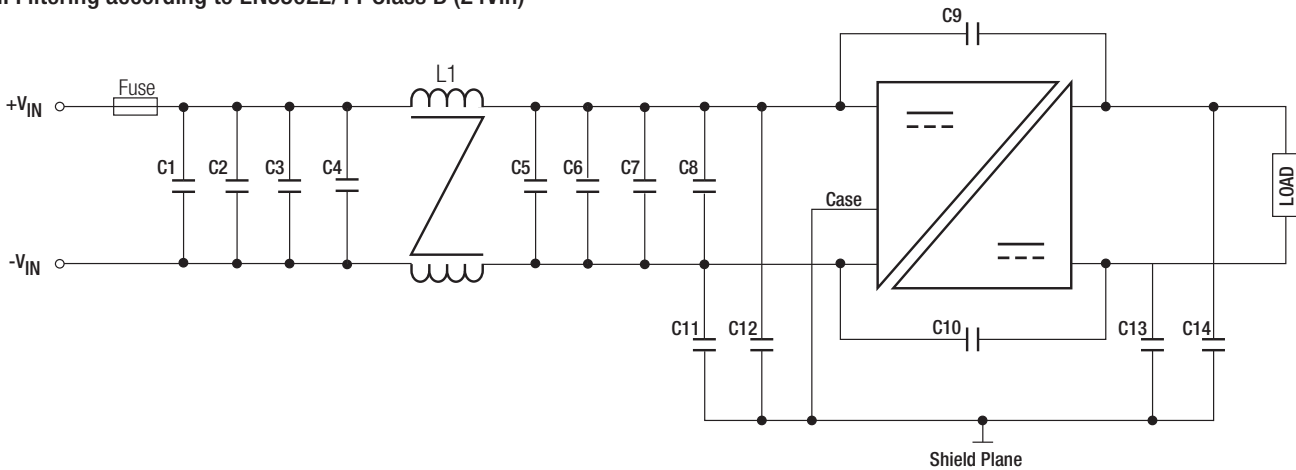

MODEL	C1 to C8	C9, C10, C13, C14	C11, C12	L1
RP120Q-24xxSRW	10 μF , 50V 1812 MLCC	1000pF, 3kV 1808 MLCC	2200pF, 3kV 1812 MLCC	285 μH CMC

RP120Q-2405SRW

Conducted Emission EN55022 Class B

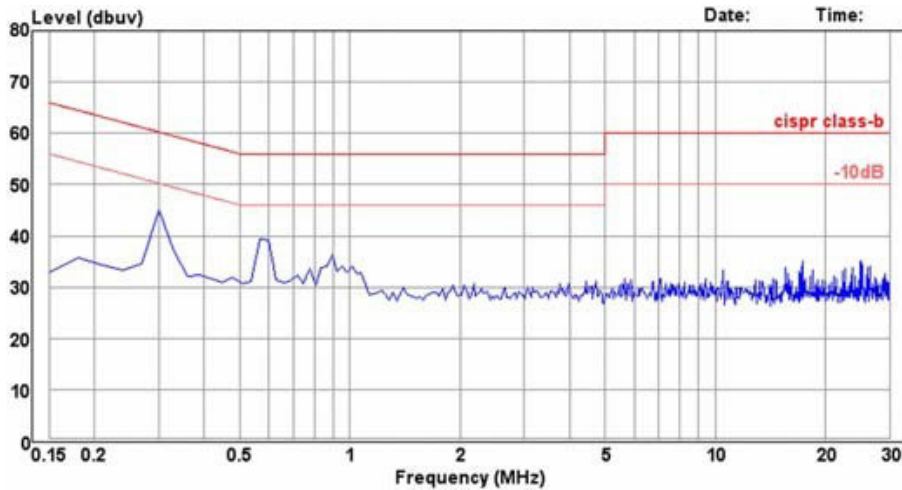

continued on next page

Specifications (measured @ $t_a = 25^\circ\text{C}$, nominal input voltage, full load and after warm-up)

EMI Filtering according to EN55022/11 Class B (48Vin)

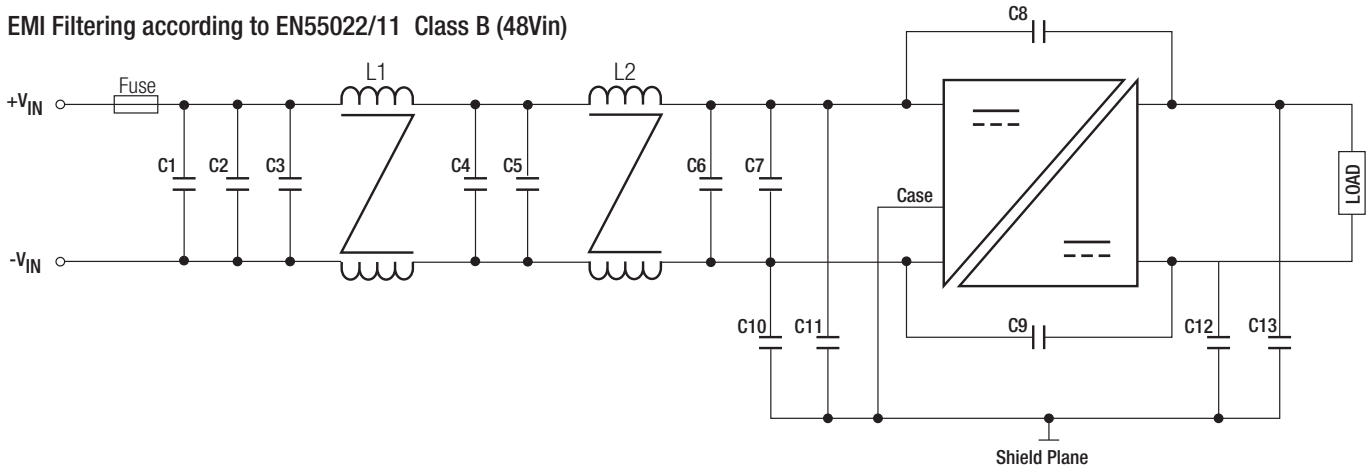

MODEL	C1 to C7	C8 to C13	L1	L2
RP120Q-48xxSRW	4.7 μF , 100V 1812 MLCC	1000pF, 3kV 1808 MLCC	620 μH CMC	285 μH CMC

RP120Q-4805SRW

Conducted Emission EN55022 Class B

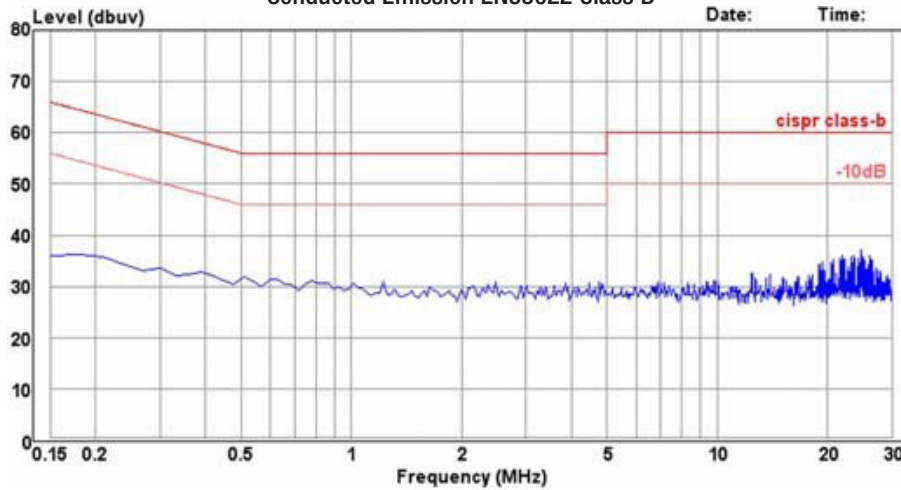

EMI Filtering according to EN55022/11 Class B (110Vin)

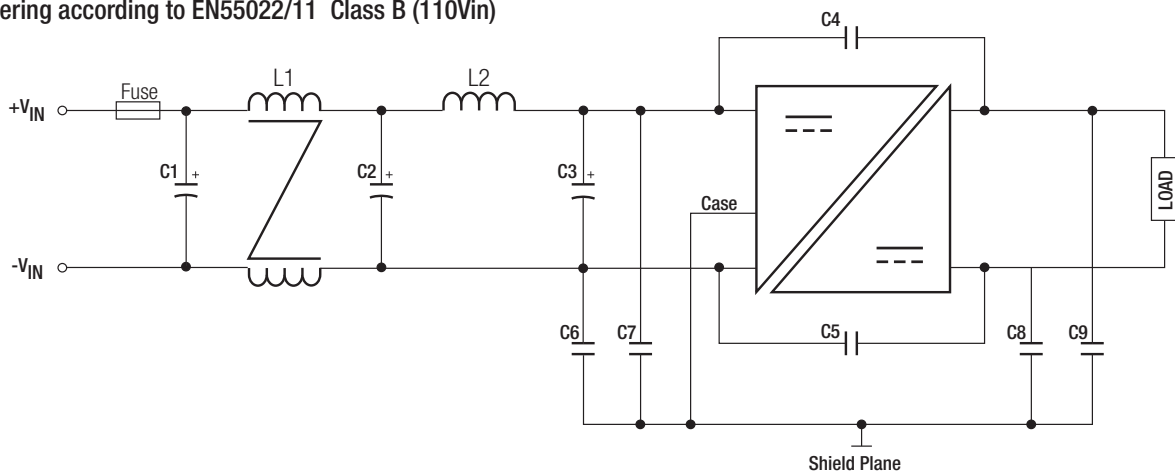

MODEL	C1, C2, C3	C4 to C9	L1	L2
RP120Q-110xxSRW	39 μF , 250V Al cap. (lie down) Rubycon BXF	1000pF, 3kV 1808 MLCC	735 μH CMC	30.1 μH , 5A SMD Inductor

continued on next page

Specifications (measured @ $t_a = 25^\circ\text{C}$, nominal input voltage, full load and after warm-up)

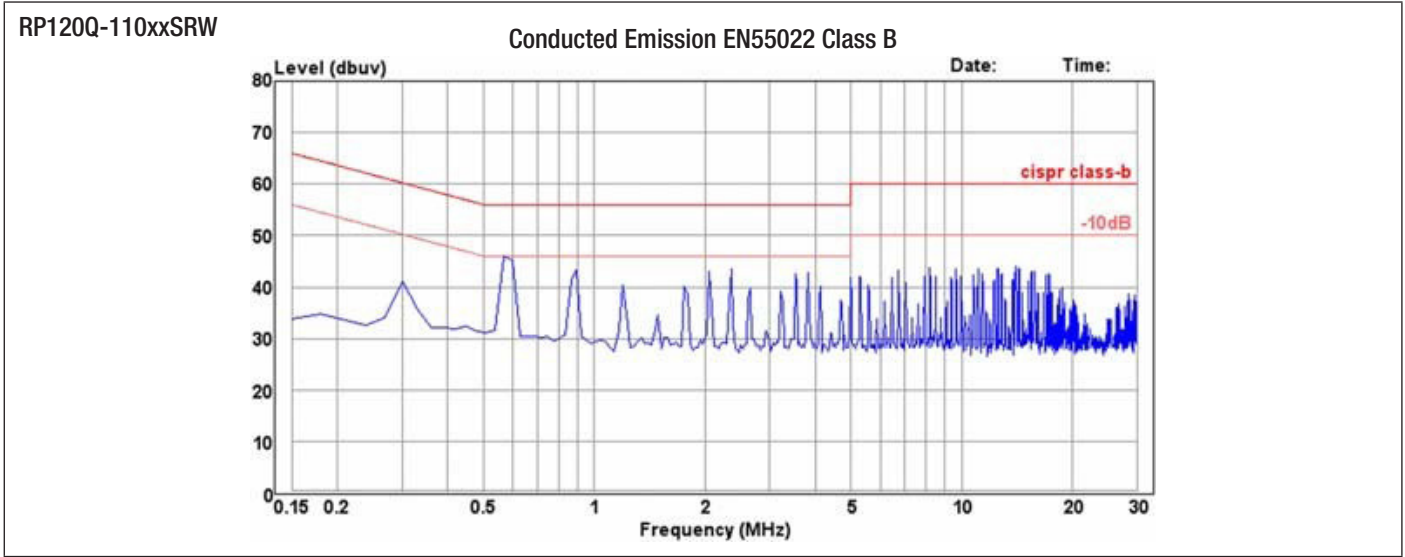

DIMENSIONS and PHYSICAL CHARACTERISTICS

Parameter	Type	Value
Material	Case	Plastic
	Baseplate	Aluminium
	Potting	Silicone (UL94 V-0)
Packaging Dimension (LxWxH)	without Heat-sink	57.9 x 36.6 x 12.7mm
	with Heat-sink	57.9 x 36.6 x 18.8mm
Packaging Weight	without Heat-sink	64g
	with Heat-sink	88g

Dimension Drawing (mm)

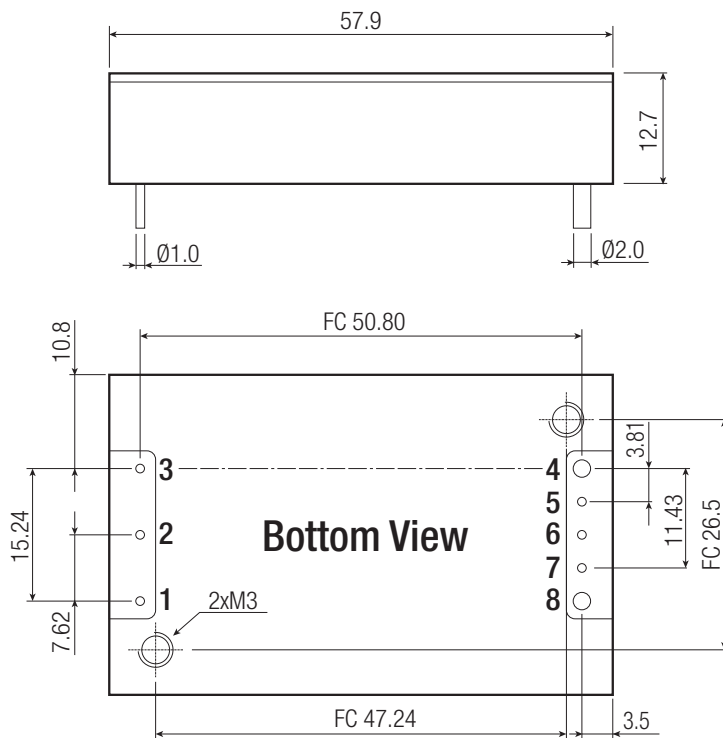

Pin Connections

Pin #	Single
1	+Vin
2	CTRL
3	-Vin
4	-Vout
5	-Sense
6	Trim
7	+Sense
8	+Vout

FC= Fixing Centers for Heat-sink
Pin Pitch Tolerance $\pm 0.25\text{mm}$
Pin Dimension Tolerance $\pm 0.1\text{mm}$
XX.X $\pm 0.5\text{mm}$
XX.XX $\pm 0.25\text{mm}$

continued on next page

Specifications (measured @ ta= 25°C, nominal input voltage, full load and after warm-up)

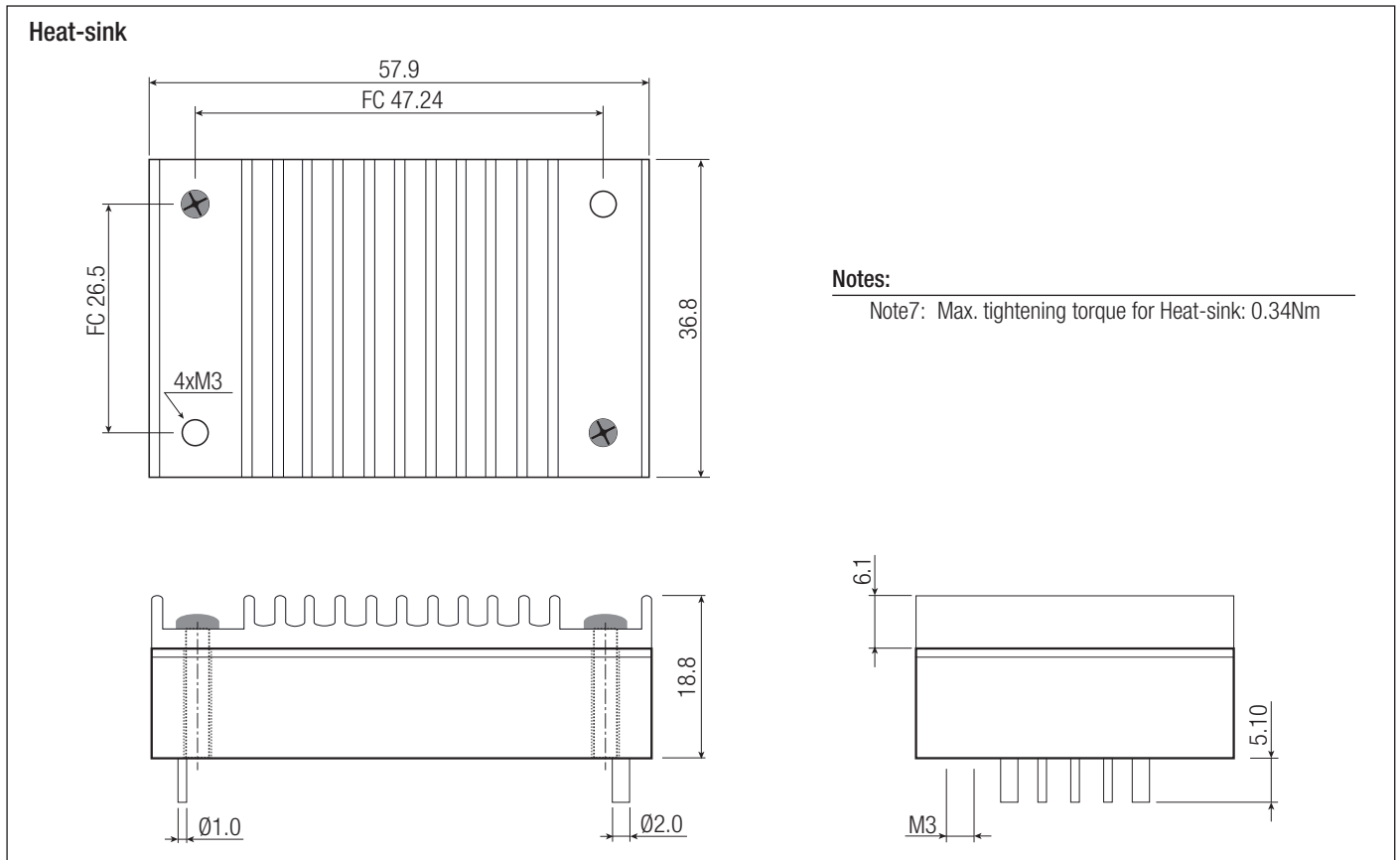

PACKAGING INFORMATION

Parameter	Type		Value
Packaging Dimension	Tray	without Heat-sink	157.0 x 88.0 x 12.8mm
		with Heat-sink	157.0 x 88.0 x 24.8mm
Packaging Quantity			2pcs
Storage Temperature Range			-55°C to +125°C
Storage Humidity			5% - 95% RH

The product information and specifications are subject to change without prior notice. RECOM products are not authorized for use in safety-critical applications (such as life support) without RECOM's explicit written consent. A safety-critical application is defined as an application where a failure of a RECOM product may reasonably be expected to endanger or cause loss of life, inflict bodily harm or damage property. The buyer shall indemnify and hold harmless RECOM, its affiliated companies and its representatives against any damage claims in connection with the unauthorized use of RECOM products in such safety-critical applications.