

REV. Status

ISSUE 1  
02/14/96

A. Electrical Specifications (Ta = +25°C)

1. Rated Voltage:  
250V AC 50/60 Hz
2. Rated Current: 0.5A AC
3. Inductance (@ 1 KHz 1V): 33 mH MIN
4. Insulation Resistance:  
DC 500V 100MΩ MIN  
Between Winding to Winding  
Between Winding to Core
5. Hi-Pot Test:  
Winding to Winding AC 2.0 KV  
Winding to Core
6. DC Resistance: 1.76Ω MAX

B. Marking; 6330 and date code

C. Schematic Diagram:

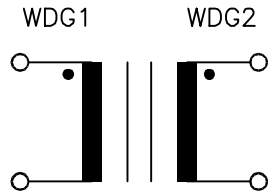

D. Mechanical Specifications:

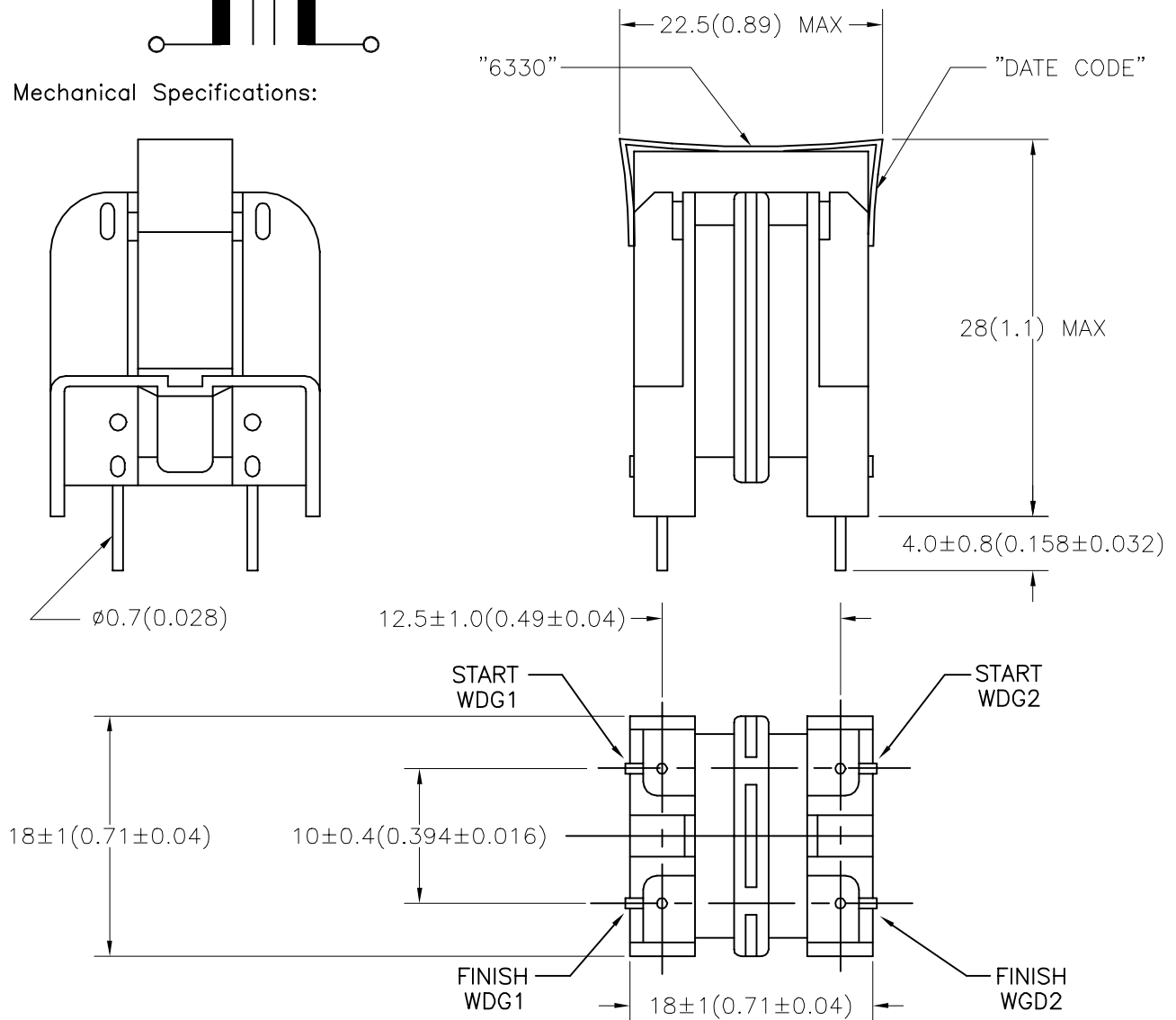

TOLERANCES (mm)	
≤ 4	± 0.2
4 ≤ 20	± 0.3
20 ≤ 50	± 0.4

PREPARED BY:

K. Brennan

ENGINEER:

T. Shiozawa

QUALITY CONTROL:

V. Casey

APPROVED:

V. Casey

DWG CONTROL NO.  
P-A4-11532  
ACAD\MXFMR\A4115321.DWG

REV  
—

COIL  
COMMON MODE

**TAMURA CORPORATION OF AMERICA**  
43352 BUSINESS PARK DRIVE, TEMECULA, CA. 92590-6624  
(909) 699-1270 FAX 9096769482

**CMF-6330**

MODEL SPECIFICATION

DIM: mm(In) SCL: 2/1 SH: 1 OF 1

PROPRIETARY NOTICE: THIS DRAWING PRINT OR DOCUMENT AND SUBJECT MATTER DISCLOSED HEREIN ARE PROPRIETARY ITEMS TO WHICH TAMURA RETAINS THE EXCLUSIVE RIGHT OF DISSEMINATION, REPRODUCTION, MANUFACTURE AND SALE. THIS DRAWING, PRINT OR DOCUMENT IS SUBMITTED IN CONFIDENCE FOR CONSIDERATION BY THE RECIPIENT ALONE UNLESS PERMISSION FOR FURTHER DISCLOSURE IS EXPRESSLY GRANTED IN WRITING.

MODEL NUMBER

**CMF-6330**