

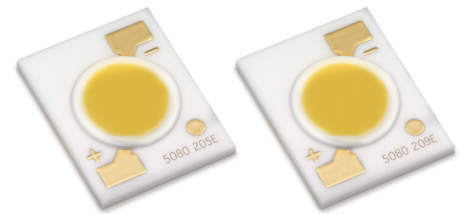

LUXEON CoB Compact Range (Gen 2)

Unsurpassed light quality and CBCP due to small LES



The second generation of LUXEON CoB Compact Range represents a new breakthrough in performance for arrays. It has up to 16% higher efficiency and lumen output at the same drive currents as existing LUXEON CoB Compact Range LEDs. This array offers the industry's smallest Light Emitting Surface (LES) that enables easier and less expensive designs and provides good Center Beam Candle Power (CBCP) for crisp light beams with the best luminance and color uniformity. LUXEON CoB Compact parts are available in 3-step (80CRI and 90CRI) MacAdam ellipse, ensuring uniform optical performance in retrofit lamps and spotlight applications. LUXEON CoB Compact Range LEDs are all hot-tested at 85°C—real world operating conditions—which means that luminaire design is simplified and testing can be minimized.

FEATURES AND BENEFITS

- Highest flux densities with industry's smallest LES, 6.5mm
- Industry leading thermal resistance allows for smaller heatsinks
- Ceramic substrate that offers better protection in Hi Pot testing
- Supported by a comprehensive optical, mechanical and electrical ecosystem
- 3-step MacAdam ellipse color definition: *Freedom from Binning* for color consistency from luminaire to luminaire
- Tested at $T_j=85^\circ\text{C}$ for accurate color in application

PRIMARY APPLICATIONS

- Downlights
- High Bay & Low Bay
- Lamps
 - Directional
- Spotlights

Table of Contents

General Product Information	2
Nomenclature Test Conditions	2
Part Number Nomenclature	2
Lumen Maintenance	2
Environmental Compliance	2
Performance Characteristics	3
Product Selection Guide	3
Optical Characteristics	3
Electrical and Thermal Characteristics	4
Absolute Maximum Ratings	4
Characteristics Curves	5
Spectral Distribution Characteristics	5
Light Output Characteristics	6
Forward Current Characteristics	7
Radiation Patterns	9
Color Bin Definitions	10
Mechanical Dimensions	11
Packaging and Labeling Information	12
Tube	12
Inner Box	13
Outer Box	14

General Product Information

Nomenclature Test Conditions

LUXEON CoB Compact Range (Gen 2) LEDs are tested and binned with a DC drive current specified below at a junction temperature, T_j , of 85°C.

- 150mA – LUXEON CoB 205
- 250mA – LUXEON CoB 209

Part Number Nomenclature

Part numbers for LUXEON CoB Compact Range (Gen 2) follow the convention below:

L 2 C 3 – **A A B B D 0 F** E 0 6 0 0 0

Where:

- A A** – designates nominal ANSI CCT (22=2200K, 27=2700K, 30=3000K, 35=3500K, 40=4000K, 50=5000K, 57=5700K)
- B B** – designates minimum CRI (80=80CRI, 90=90CRI)
- D** – designates product generation (2=Gen 2)
- F** – designates product wattage (5=5W, 9=9W)

Therefore, the following part number is used for a LUXEON CoB Gen 2, 5W, 3000K 80CRI:

L 2 C 3 – **3 0 8 0 2 0 5** E 0 6 0 0 0

Lumen Maintenance

Lumen maintenance for solid-state lighting devices (LEDs) is typically defined in terms of the percentage of initial light output remaining after a specified period of time. Based on historical data Lumileds projects that LUXEON CoB Compact Range (Gen 2) will deliver—on average—70% lumen maintenance (L70) at 50,000 hours of operation at its nominal, tested conditions. Observation of design limits included in this data sheet is required in order to achieve this projected lumen maintenance.

Environmental Compliance

Lumileds LLC is committed to providing environmentally friendly products to the solid-state lighting market. LUXEON LEDs are compliant to the European Union directives on the restriction of hazardous substances in electronic equipment, namely the RoHS Directive 2011/65/EU and REACH Regulation (EC) 1907/2006. Lumileds LLC will not intentionally add the following restricted material to its products: lead, mercury, cadmium, hexavalent chromium, polybrominated biphenyls (PBB) or polybrominated diphenyl ethers (PBDE).

Performance Characteristics

Product Selection Guide

Table 1. Product performance of LUXEON CoB Compact Range (Gen 2) at specified test current, $T_j=85^\circ\text{C}$.

PRODUCT	NOMINAL CCT	MINIMUM CRI ^[1, 2, 3]	LUMINOUS FLUX ^[1] (lm)		TYPICAL LUMINOUS EFFICACY (lm/W)	TEST CURRENT (mA)	LES ^[4] (mm)	PART NUMBER	
			MINIMUM	TYPICAL					
LUXEON CoB 205	2200	80	510	567	105	150	6.5	L2C3-2280205E06000	
	2700	80	585	650	120	150	6.5	L2C3-2780205E06000	
	3000	80	622	691	128	150	6.5	L2C3-3080205E06000	
	3500	80	635	705	131	150	6.5	L2C3-3580205E06000	
	4000	80	653	726	134	150	6.5	L2C3-4080205E06000	
	5000	80	653	726	134	150	6.5	L2C3-5080205E06000	
	5700	80	653	725	134	150	6.5	L2C3-5780205E06000	
	2200K ^[5]	90	452	502	93	150	6.5	L2C3-2290205E06000	
	2700	90	506	562	104	150	6.5	L2C3-2790205E06000	
	3000	90	542	602	111	150	6.5	L2C3-3090205E06000	
	3500	90	573	637	118	150	6.5	L2C3-3590205E06000	
	4000	90	581	646	120	150	6.5	L2C3-4090205E06000	
	LUXEON CoB 209	2200	80	826	918	103	250	6.5	L2C3-2280209E06000
		2700	80	972	1080	122	250	6.5	L2C3-2780209E06000
3000		80	1008	1120	126	250	6.5	L2C3-3080209E06000	
3500		80	1028	1142	129	250	6.5	L2C3-3580209E06000	
4000		80	1058	1176	133	250	6.5	L2C3-4080209E06000	
5000		80	1058	1176	133	250	6.5	L2C3-5080209E06000	
5700		80	1072	1191	134	250	6.5	L2C3-5780209E06000	
2200K ^[5]		90	757	841	95	250	6.5	L2C3-2290209E06000	
2700		90	828	920	104	250	6.5	L2C3-2790209E06000	
3000		90	902	1002	113	250	6.5	L2C3-3090209E06000	
3500		90	933	1037	117	250	6.5	L2C3-3590209E06000	
4000		90	961	1068	120	250	6.5	L2C3-4090209E06000	

Notes for Table 1:

1. Lumileds maintains a tolerance of ± 2 on CRI and $\pm 6.5\%$ on luminous flux measurements.
2. Typical CRI is approximately 2 points higher than the minimum CRI specified, but this is not guaranteed.
3. R9 value of 90CRI products is >50 .
4. Light Emitting Surface (LES) is the inner diameter (phosphor area) inside the dam.
5. AtmoSphere Technology creates the ideal ambiance for restaurants and other hospitality venues.

Optical Characteristics

Table 2. Optical characteristics for LUXEON CoB Compact Range (Gen 2) at specified test current, $T_j=85^\circ\text{C}$.

PART NUMBER	TYPICAL TOTAL INCLUDED ANGLE ^[1]	TYPICAL VIEWING ANGLE ^[2]
L2C3-xxxx20xE06000	135°	115°

Notes for Table 2:

1. Total angle at which 90% of total luminous flux is captured.
2. Viewing angle is the off axis angle from LED centerline where the luminous intensity is $\frac{1}{2}$ of the peak value.

Electrical and Thermal Characteristics

Table 3. Electrical and thermal characteristics for LUXEON CoB Compact Range (Gen 2) at specified test current, $T_j=85^\circ\text{C}$.

PART NUMBER	TEST CURRENT (mA)	FORWARD VOLTAGE ^[1] (V_f)			TYPICAL TEMPERATURE COEFFICIENT OF FORWARD VOLTAGE ^[2] (mV/°C)	TYPICAL THERMAL RESISTANCE—JUNCTION TO CASE ^[3] (°C/W)
		MINIMUM	TYPICAL	MAXIMUM		
L2C3-xxxx205E06000	150	33.6	36.0	39.0	-16	2.2
L2C3-xxxx209E06000	250	32.8	35.2	38.0	-16	1.5

Notes for Table 3:

1. Lumileds maintains a tolerance of $\pm 10\%$ on forward voltage measurements.
2. Measured between 25°C and 85°C for coefficient of forward voltage.
3. Thermal resistance is measured between junction and the bottom of the LUXEON CoB substrate.

Absolute Maximum Ratings

Table 4. Absolute maximum ratings for LUXEON CoB Compact Range (Gen 2).

PARAMETER	MAXIMUM PERFORMANCE
DC Forward Current ^[1,2]	LUXEON CoB 205: 300mA LUXEON CoB 209: 400mA
LED Junction Temperature ^[1] (DC & Pulse)	125°C
ESD Sensitivity (ANSI/ESDA/JEDEC JS-001-2012)	Class 3B
Operating Case Temperature ^[1]	-40°C to 105°C
LED Storage Temperature	-40°C to 105°C
Reverse Voltage (V_{reverse})	LUXEON LEDs are not designed to be driven in reverse bias

Notes for 4:

1. Proper current derating must be observed to maintain junction temperature below the maximum allowable junction temperature.
2. Residual periodic variations due to power conversion from alternating current (AC) to direct current (DC), also called "ripple," are acceptable if the following conditions are met:
 - The frequency of the ripple current is 100Hz or higher
 - The average current for each cycle does not exceed the maximum allowable DC forward current
 - The maximum amplitude of the ripple does not exceed 15% of the maximum allowable DC forward current

Characteristics Curves

Spectral Distribution Characteristics

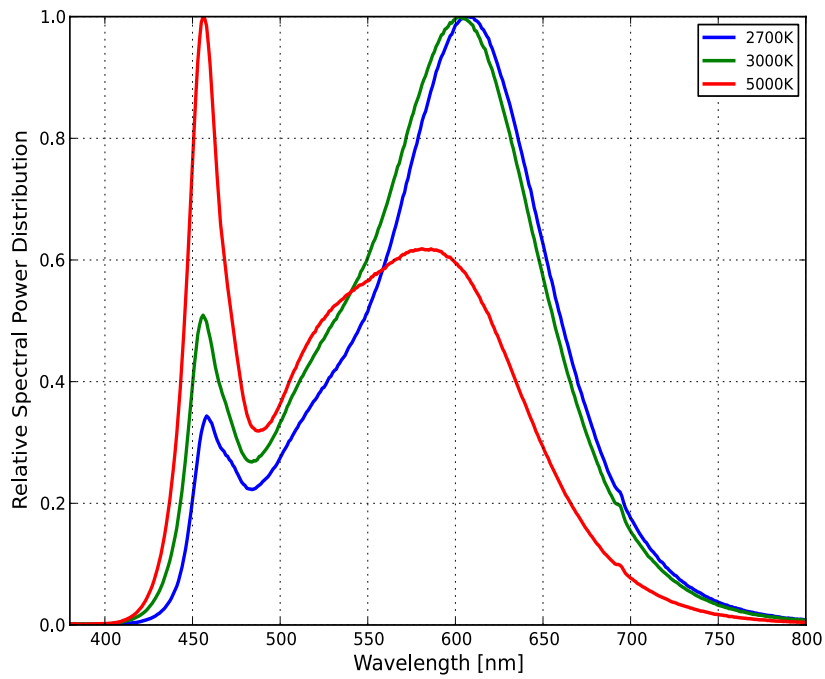

Figure 1a. Typical normalized power vs. wavelength for L2C3-xx8020xE06000 at test current, $T_j=85^{\circ}\text{C}$.

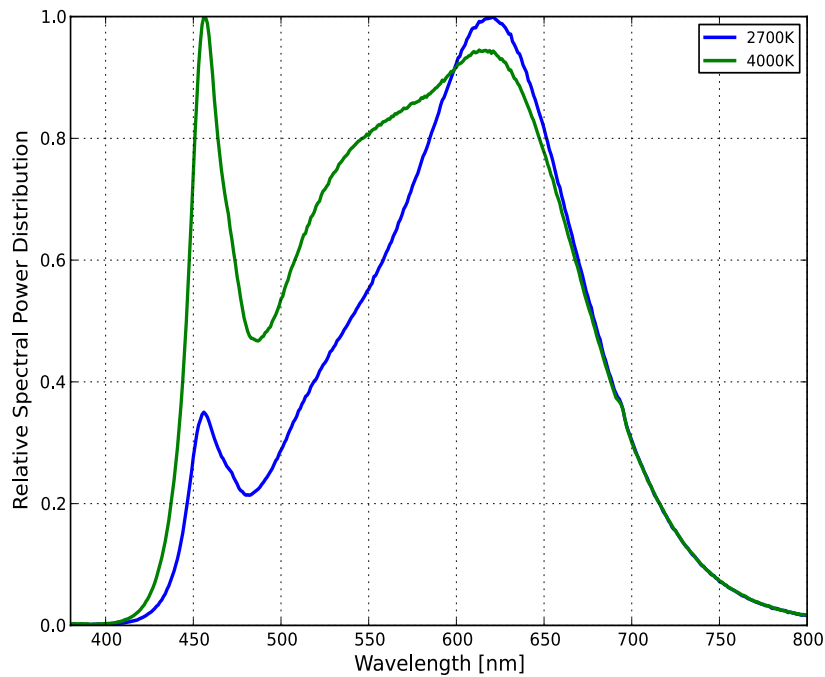

Figure 1b. Typical normalized power vs. wavelength for L2C3-xx9020xE06000 at test current, $T_j=85^{\circ}\text{C}$.

Light Output Characteristics

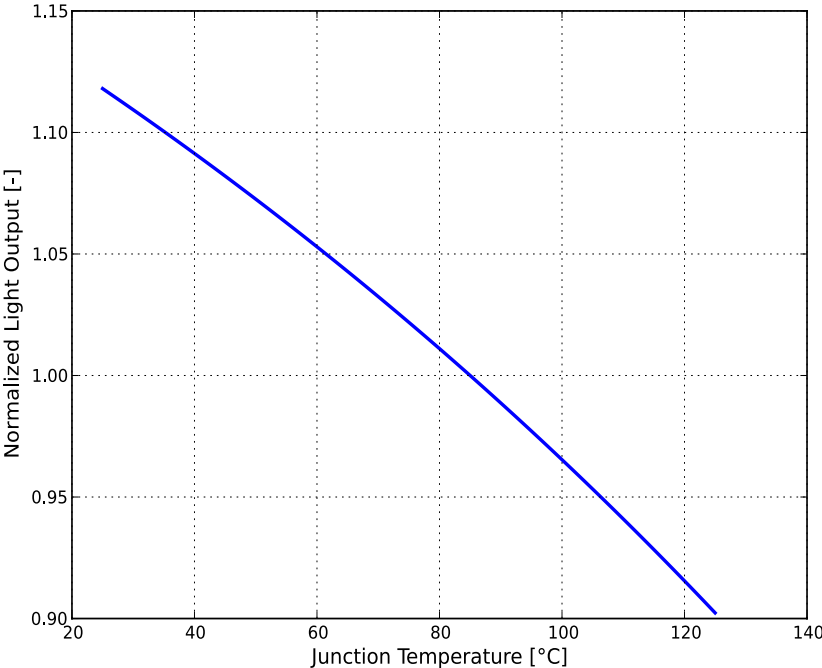

Figure 2. Typical normalized light output vs. junction temperature for L2C3-xxxx20xE06000 at test current.

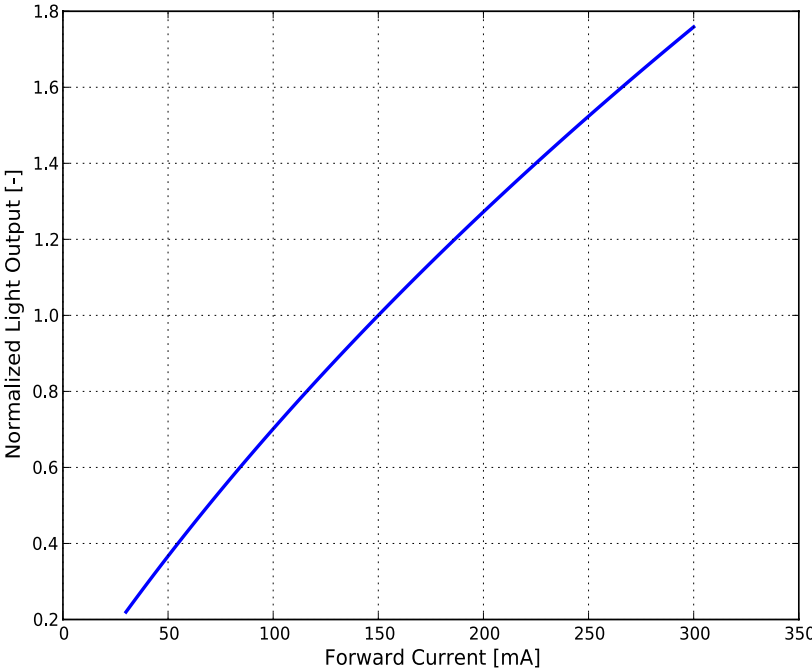

Figure 3a. Typical normalized light output vs. forward current for L2C3-xxxx205E06000 at $T_j=85^\circ\text{C}$.

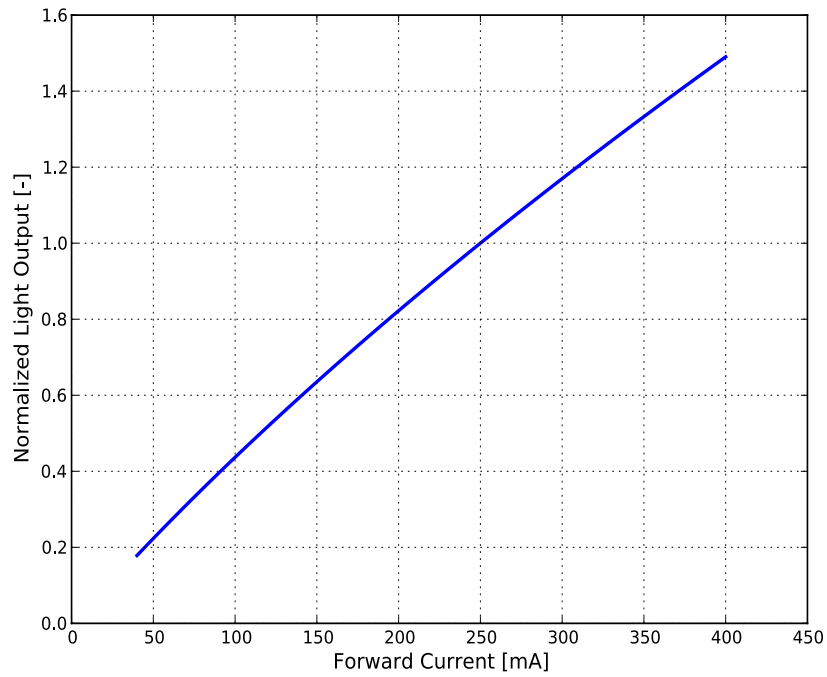

Figure 3b. Typical normalized light output vs. forward current for L2C3-xxxx209E06000 at $T_j=85^\circ\text{C}$.

Forward Current Characteristics

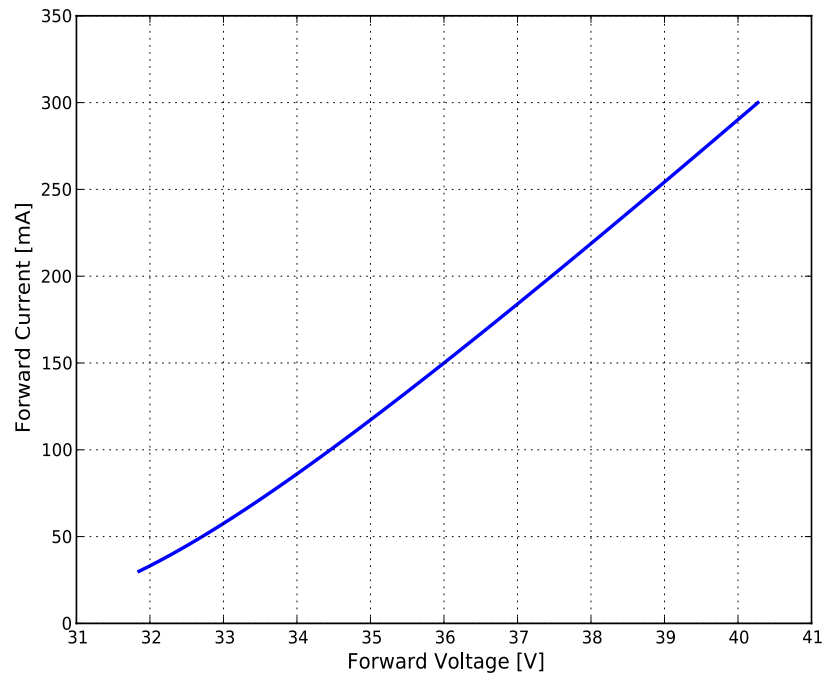

Figure 4a. Typical forward current vs. forward voltage for L2C3-xxxx205E06000 at $T_j=85^\circ\text{C}$.

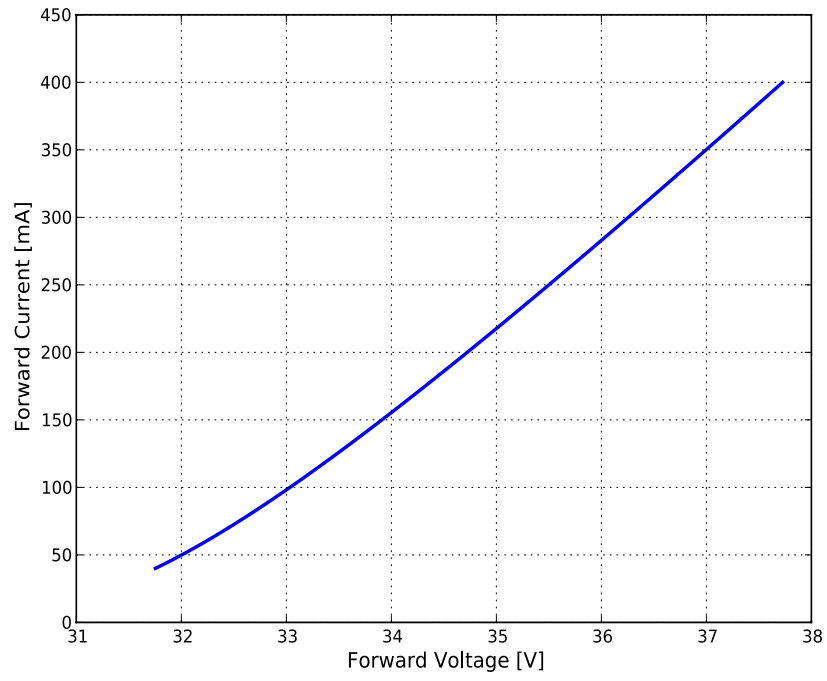

Figure 4b. Typical forward current vs. forward voltage for L2C3-xxxx209E06000 at $T_j=85^\circ\text{C}$.

Radiation Patterns

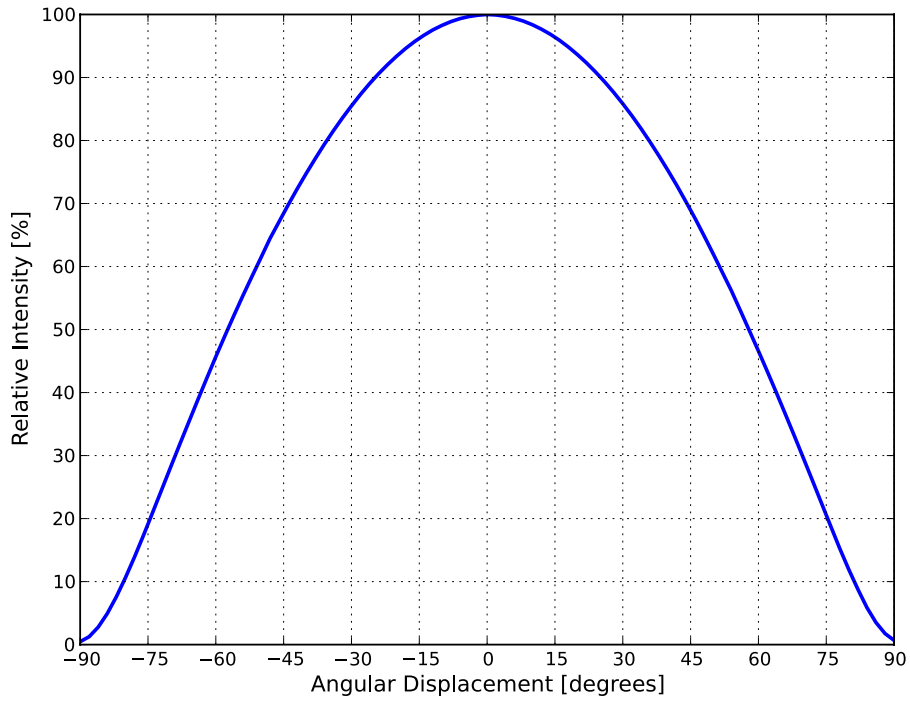

Figure 5. Typical radiation pattern for L2C3-xxxx20xE06000 at test current, $T_j=85^\circ\text{C}$.

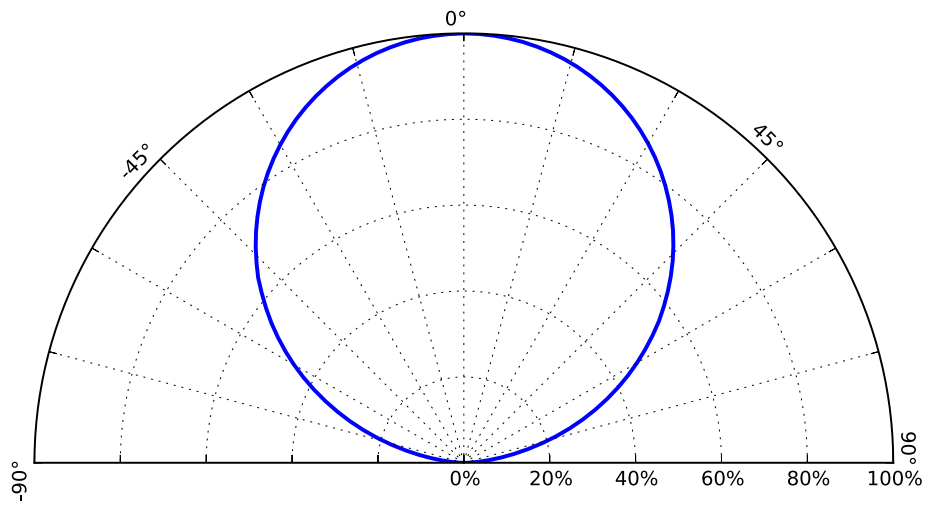

Figure 6. Typical polar radiation pattern for L2C3-xxxx20xE06000 at test current, $T_j=85^\circ\text{C}$.

Color Bin Definitions

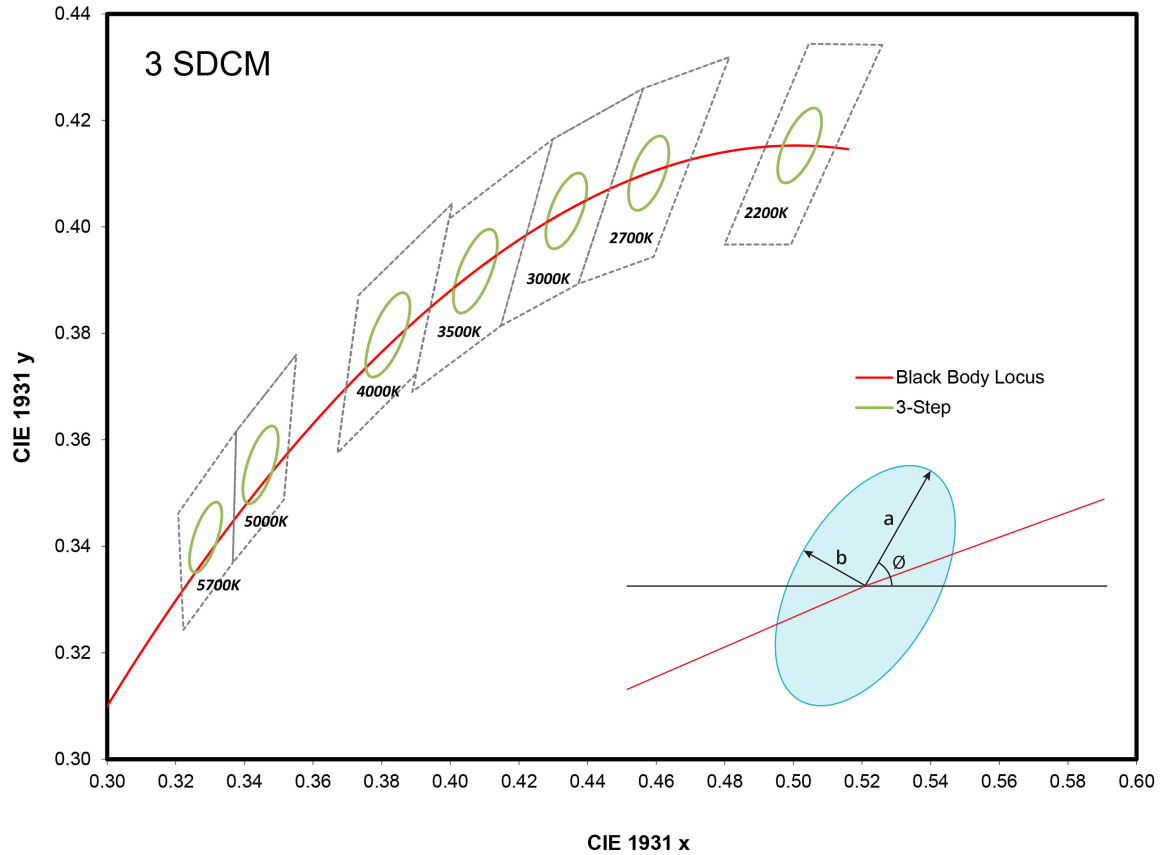

Figure 7. 3-step MacAdam ellipse illustration for Table 5.

Table 5. 3-step MacAdam ellipse color bin definitions for LUXEON CoB Compact Range (Gen 2) at test current, $T_j=85^\circ\text{C}$.

NOMINAL CCT	COLOR SPACE	CENTER POINT ⁽¹⁾ (cx, cy)	MAJOR AXIS, a	MINOR AXIS, b	ELLIPSE ROTATION ANGLE, θ
2200K	Single 3-step MacAdam ellipse	(0.5020, 0.4155)	0.00862	0.00397	49.3°
2700K	Single 3-step MacAdam ellipse	(0.4578, 0.4101)	0.00810	0.00420	53.7°
3000K	Single 3-step MacAdam ellipse	(0.4338, 0.4030)	0.00834	0.00408	53.2°
3500K	Single 3-step MacAdam ellipse	(0.4073, 0.3917)	0.00927	0.00414	54.0°
4000K	Single 3-step MacAdam ellipse	(0.3818, 0.3797)	0.00939	0.00402	53.7°
5000K	Single 3-step MacAdam ellipse	(0.3447, 0.3553)	0.00822	0.00354	59.6°
5700K	Single 3-step MacAdam ellipse	(0.3287, 0.3417)	0.00745	0.00320	59.1°

Notes for Table 5:

1. Lumileds maintains a tolerance of ± 0.005 on x and y coordinates in the CIE 1931 color space.

Mechanical Dimensions

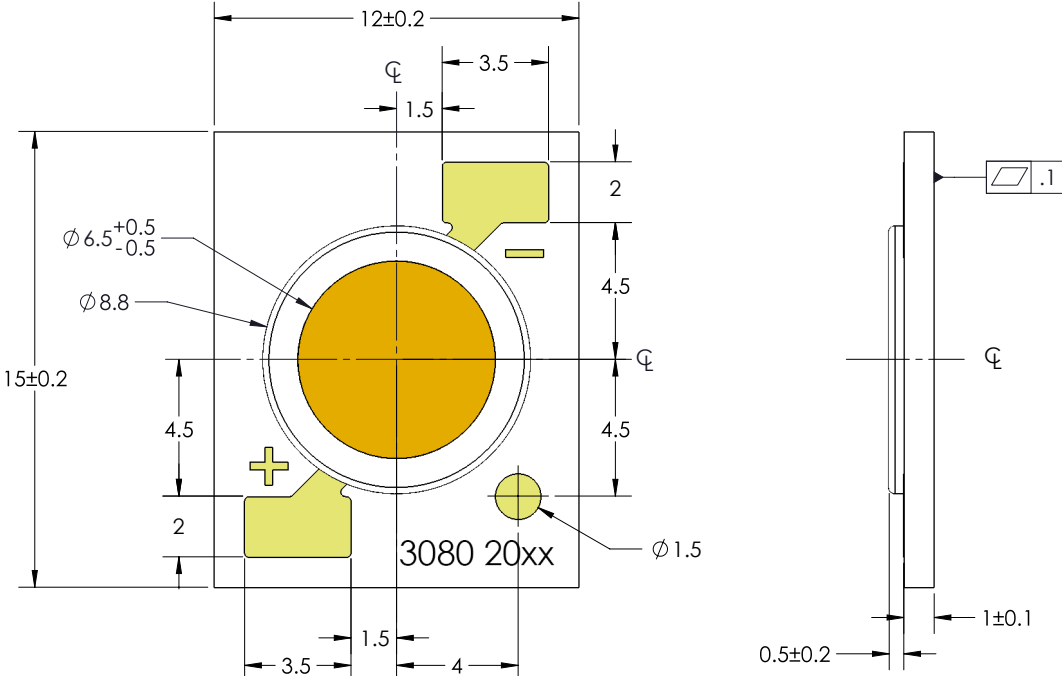

Figure 8. Mechanical dimensions for LUXEON CoB Compact Range (Gen 2).

- Notes for Figure 8:
1. Drawings are not to scale.
 2. All dimensions are in millimeters.

Packaging and Labeling Information

LUXEON CoB Compact Range (Gen 2) LEDs are packaged in tubes then in a carton box. Each tube contains a specified number of LEDs. The LEDs in each tube come from a single category code, ensuring they are all well-matched for light output, color, and forward voltage. Each tube contains a rubber stopper at one end. The tube label has both alphanumeric and bar code information. The carton box have printed information providing part numbers with CAT codes that indicate that indicate luminous flux, color and forward voltage bins.

Table 6. Package information for LUXEON CoB Compact Range (Gen 2).

PART NUMBER	TOTAL UNITES PER TUBE	TOTAL TUBES PER INNER BOX	TOTAL UNITS PER INNER BOX
L2C3-xxxx205E06000	20	5	100
L2C3-xxxx209E06000	20	5	100

Tube

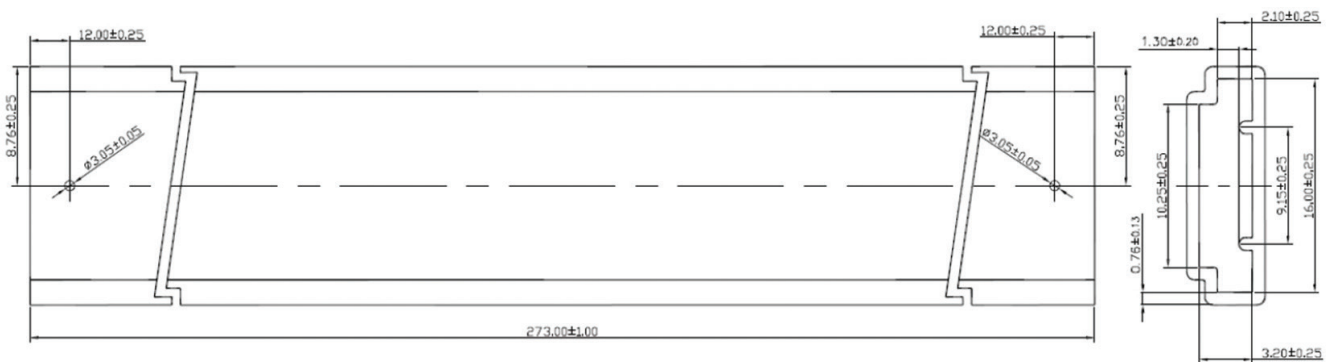

Figure 9. Tube dimensions for LUXEON CoB Compact Range (Gen 2).

Notes for Figure 9:

1. Drawings are not to scale.
2. All dimensions are in millimeters.

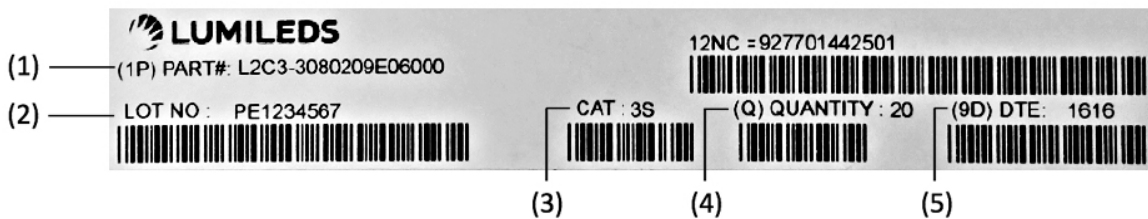

Figure 10. Example of a tube label for LUXEON CoB Compact Range (Gen 2).

Notes for Figure 10 – Tube Label descriptions for customer use:

Field labels not described are for Lumileds internal use only.

1. Lumileds part number.
2. Unique production lot identification number. This number is required for traceability purpose.
3. Product category code.
4. Number of LED emitters in a tube.
5. LED test date in YYWW format.

Inner Box

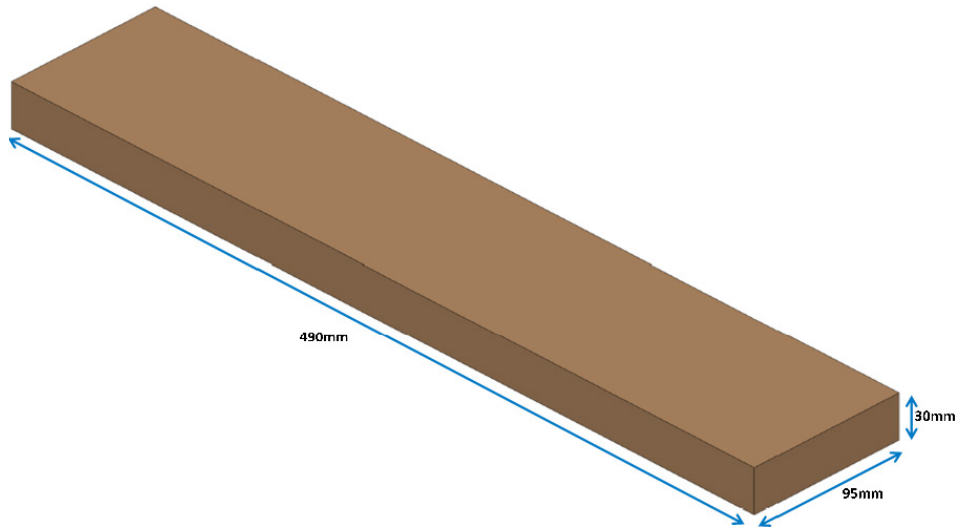

Figure 11. Dimensions for inner box packaging for LUXEON CoB Compact Range (Gen 2).

Table 7. Inner box information for LUXEON CoB Compact Range (Gen 2).

BOX TYPE	DIMENSIONS (mm)			AVERAGE WEIGHT (100pcs/box)
	H	L	W	
Inner Box	30	490	95	0.225kg



Figure 12. Example of inner box label for LUXEON CoB Compact Range (Gen 2).

Notes for Figure 12 – Inner Box Label descriptions for customer use:
Field labels not described are for Lumileds internal use only.

1. Lumileds part number.
2. Number of LED emitters in a box.
3. LED test date in YYWW format.
4. Customer part number for custom requests only.
5. Unique production lot identification number. This number is required for traceability purpose.
6. Product category code.

Outer Box

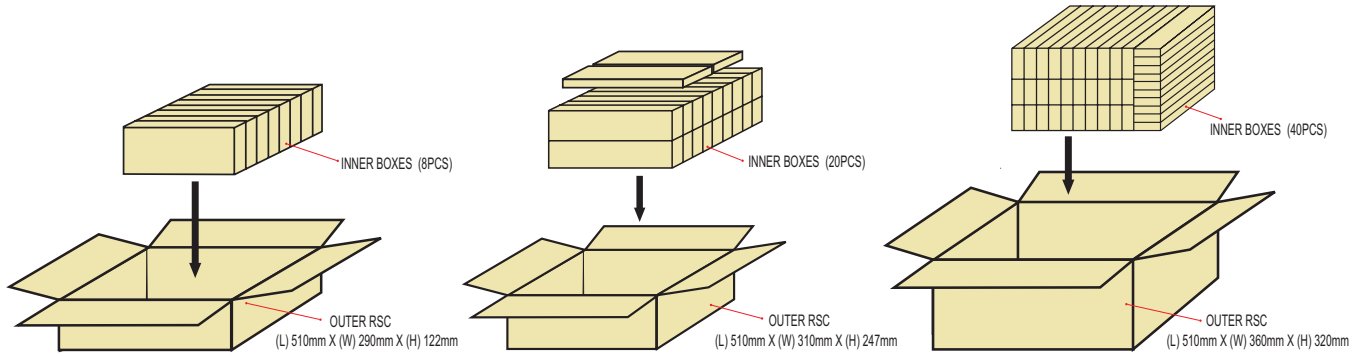

Figure 13. Dimensions for outer box packaging for LUXEON CoB Compact Range (Gen 2).

Table 8. Outer box information for LUXEON CoB Compact Range (Gen 2).

BOX TYPE	DIMENSIONS (mm)			MAXIMUM INNER BOXES PER OUTER BOX	MAXIMUM QUANTITY PER OUTER BOX	AVERAGE WEIGHT
	H	L	W			
Outer Box 8 PCS	122	510	290	8	800	2.13kg
Outer Box 20 PCS	247	510	310	20	2000	5.24kg
Outer Box 40 PCS	320	510	360	40	4000	10.46kg

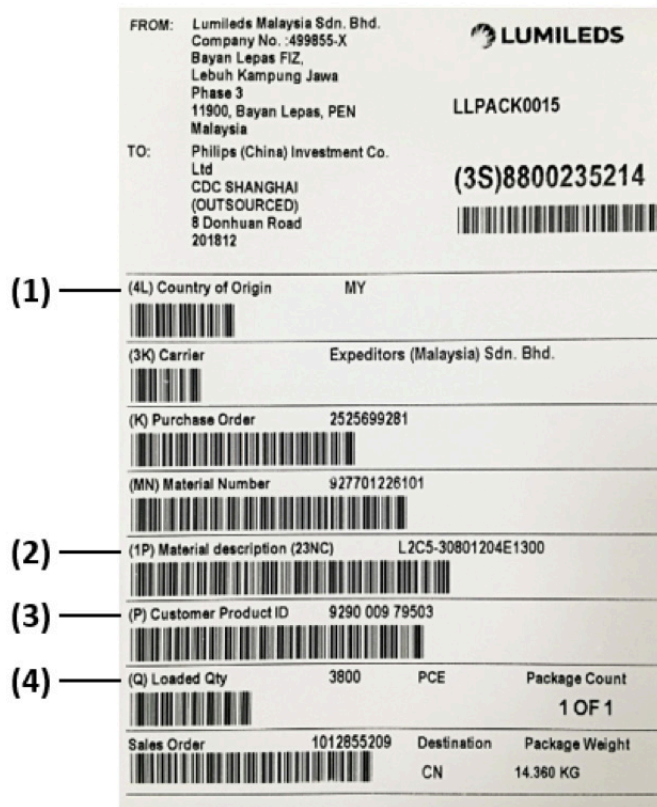

Figure 14. Example of outer box label for LUXEON CoB Compact Range (Gen 2).

Notes for Figure 14 – Outer Box Label descriptions for customer use:

Field labels not described are for Lumileds internal use only.

1. Country code of origin of manufacturing of parts (e.g. MY for Malaysia, CN for China) according to ISO 3166-1 alpha-2 document.
2. Lumileds part number.
3. Customer part number for custom requests only.
4. Total number of LED emitters in a shipment box.

About Lumileds

Lumileds is the global leader in light engine technology. The company develops, manufactures and distributes groundbreaking LEDs and automotive lighting products that shatter the status quo and help customers gain and maintain a competitive edge.

With a rich history of industry “firsts,” Lumileds is uniquely positioned to deliver lighting advancements well into the future by maintaining an unwavering focus on quality, innovation and reliability.

To learn more about our portfolio of light engines, visit lumileds.com.



©2016 Lumileds Holding B.V. All rights reserved.
LUXEON is a registered trademark of the Lumileds Holding B.V.
in the United States and other countries.

lumileds.com

Neither Lumileds Holding B.V. nor its affiliates shall be liable for any kind of loss of data or any other damages, direct, indirect or consequential, resulting from the use of the provided information and data. Although Lumileds Holding B.V. and/or its affiliates have attempted to provide the most accurate information and data, the materials and services information and data are provided “as is,” and neither Lumileds Holding B.V. nor its affiliates warrants or guarantees the contents and correctness of the provided information and data. Lumileds Holding B.V. and its affiliates reserve the right to make changes without notice. You as user agree to this disclaimer and user agreement with the download or use of the provided materials, information and data.