

SHARP

SPEC. No. DG-072023A

ISSUE Dec-20-07

COMPOUND SEMICONDUCTOR SYSTEMS DIVISION

ELECTRONIC COMPONENTS(ELECOM) GROUP

SHARP CORPORATION

SPECIFICATIONS

REFERENCE

DEVICE SPECIFICATION FOR
LIGHT EMITTING DIODE
MODEL No. GM1WA55311A

CUSTOMERS' APPROVAL

Date _____

By _____

PRESENTED

Date Dec. 20. 07

By S. Yokota

S. Yokota
Department General Manager
LED Business Development Center
Compound Semiconductor Systems Division
Electronic Components (ELECOM) Group
SHARP CORPORATION

PRODUCT NAME

Chip LED

MODEL No.

GM1WA55311A

REFERENCE

1. These specification sheets include materials protected under the copyright of Sharp Corporation ("Sharp"). Please do not reproduce or cause anyone to reproduce them without Sharp's consent.
2. When using this product, please observe the absolute maximum ratings and the instructions for use outlined in these specification sheets, as well as the precautions mentioned below. Sharp assumes no responsibility for any damage resulting from use of the product which does not comply with the absolute maximum ratings and the instructions included in these specification sheets, and the precautions mentioned below.

(Precautions)

- (1) This products is designed for use in the following application areas;

* OA equipment	* Audio visual equipment	* Home appliance
* Telecommunication equipment (Terminal)	* Measuring equipment	
* Tooling machines	* Computers	

If the use of the product in the above application areas is for equipment listed in paragraphs (2) or (3), please be sure to observe the precautions given in those respective paragraphs.

- (2) Appropriate measures, such as fail-safe design and redundant design considering the safety design of the overall system and equipment, should be taken to ensure reliability and safety when this product is used for equipment which demands high reliability and safety in function and precision, such as ;

* Transportation control and safety equipment (aircraft, train, automobile etc.)
* Traffic signals * Gas leakage sensor breakers * Rescue and security equipment
* Other safety equipment

- (3) Please do not use this product for equipment which require extremely high reliability and safety in function and precision, such as ;

* Space equipment	* Telecommunication equipment (for trunk lines)
* Nuclear power control equipment	* Medical equipment

- (4) Please contact and consult with a Sharp sales representative if there are any questions regarding interpretation of the above three paragraphs.

3. Please contact and consult with a Sharp sales representative for any questions about this product.

SHARP**REFERENCE**GM1WA55311A specification

1. Application

This specification applies to the light emitting diode device Model No. GM1WA55311A.
[InGaN/SiC blue, InGaN/SiC green, AlGaInP/GaAs red : RGB 3 color chip LED device]
This product is designed for various kinds of general indication devices.

2. External dimensions and equivalent circuitRefer to Page3.

3. Ratings and characteristicsRefer to Page4~8.

- 3-1. Absolute maximum ratings
- 3-2. Electro-optical characteristics
- 3-3. Derating Curve
- 3-4. Characteristics Diagram (TYP.)

4. ReliabilityRefer to Page9.

- 4-1. Test items and test conditions
- 4-2. Failure criteria

5. Quality levelRefer to Page10.

- 5-1. Applied standard
- 5-2. Sampling method
- 5-3. Inspection items and defect criteria

6. SupplementsRefer to Page10~13.

- 6-1. Taping
- 6-2. Packing
- 6-3. Label
- 6-4. Luminous intensity rank table
- 6-5. Information on environmental impact substances

7. PrecautionsRefer to Page14~15.

- 7-1. General handling
- 7-2. Soldering
- 7-3. Cleaning

REFERENCE

SHARP

2. External dimensions and equivalent circuit

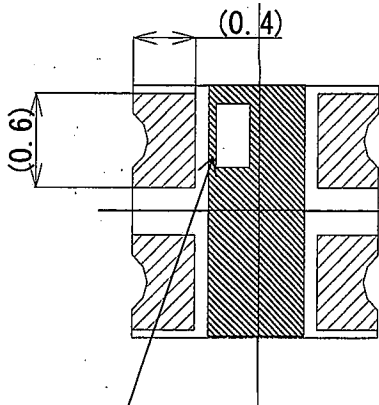
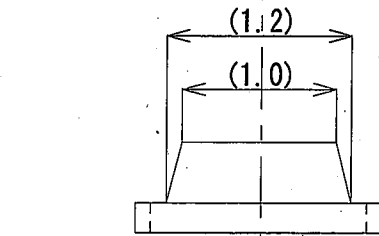
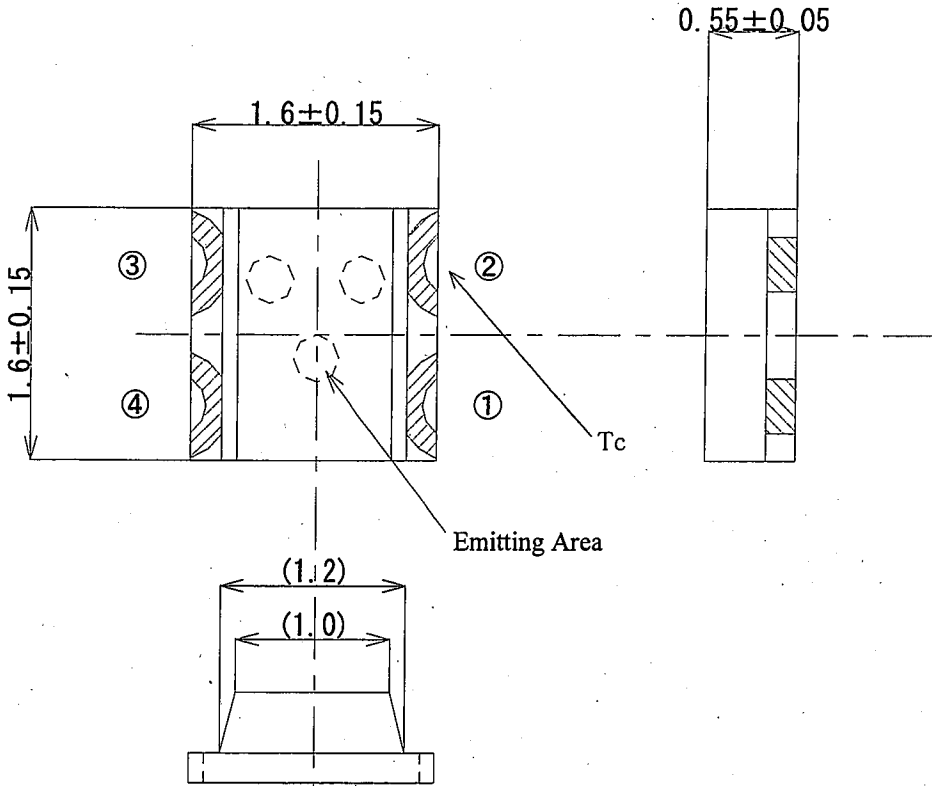

[Note]

1. Plated area

Resist area

2. Terminal Connection

① Green Cathode

② Red Cathode

③ Blue Cathode

④ Anode Common

3. Unspecified tolerance to be ± 0.1 mm.

4. Value inside the parenthesis is a reference value.

5. Tc: Measurement point of Case Temperature

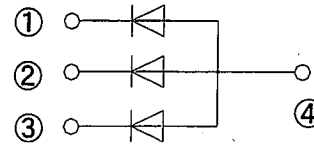
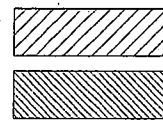

Polarity Mark

Unit	Materials	Finish	Drawing No.
m m	PWB: Glass epoxy Resin: Epoxy resin	Au plated	51902016

SHARP**REFERENCE**

3. Ratings and characteristics

3-1. Absolute maximum ratings

(T_c=25°C)

Parameter	Symbol	Rating			Unit
		BC (Blue)	GC (Green)	JJ (Red)	
Power dissipation	P	45.5			mW
Forward current(*1)	I _F	10	10	10	mA
Peak forward current (*2)	I _{FM}	20	20	20	mA
Derating factor	DC	0.13	0.13	0.13	mA/°C
	Pulse	0.27	0.27	0.27	mA/°C
Reverse voltage	V _R	5.0			V
Operating temperature	T _c (*3)	-20 ~ +80			°C
Storage temperature	T _{stg}	-40 ~ +100			°C
Soldering temperature(*4)	T _{sol}	290			°C

(*1) Rating is prescribed by each color chip. In operating three color chips simultaneously, be sure not to exceed the rating of power dissipation.

(*2) Duty ratio=1/10, Pulse width=0.1ms

(*3) As for case temperature, please refer to Page 3/15, Outline dimensions and terminal connections

(*4) Each terminal must be soldered with the soldering iron of capacity below 30W within 3 seconds under 290°C.

3-2. Electro-optical characteristics

(T_c=25°C)

Parameter	Symbol	Color	Conditions	MIN.	TYP.	MAX.	Unit
Forward voltage	V _F	BC	I _F =5mA	-	2.9	3.2	V
		GC		-	3.0	3.3	
		JJ		-	1.9	2.3	
Luminous intensity (*5)	I _v	BC	I _F =5mA	10	23	47	mcd
		GC		36	70	190	
		JJ		9.8	20	51	
Dominant wavelength (*6)	λ _d	BC	I _F =5mA	470	473	480	nm
		GC		516	527	540	
		JJ		610.5	616	623.5	
Spectrum radiation bandwidth	Δλ	BC	I _F =5mA	-	23	-	nm
		GC		-	35	-	
		JJ		-	18	-	
Reverse current	I _R	BC	V _R =4V	-	-	100	μA
		GC		-	-	100	
		JJ		-	-	100	

(*5) Measured by SHARP EG&G MODEL550(Radiometer/Photometersystem) (after 20ms drive) (Tolerance:±15%)

(*6) Measured by Ohtsuka electronics MODEL MCPD-2000 (after 20ms drive)

The values of this table are the typical data classified under the conditions in the above table and are not guaranteed data.

(*7) Refer to 6-4. Luminous intensity rank table.

SHARP

REFERENCE

3-3. Derating Curve

· BC, GC, JJ

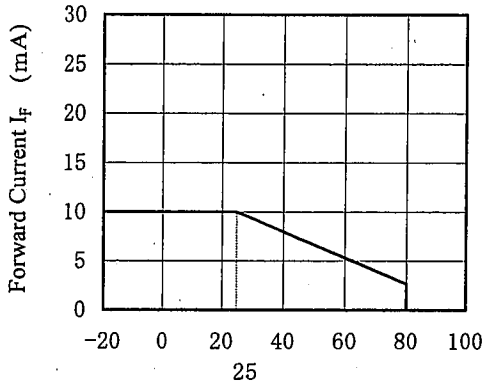

Forward Current Derating Curve

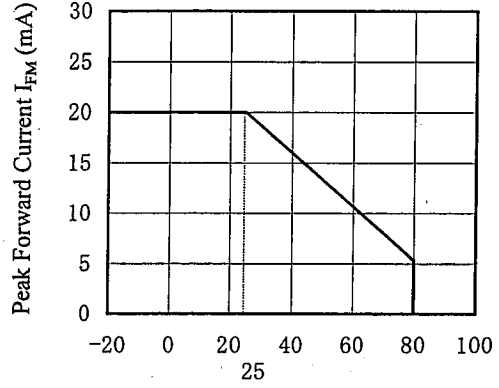

Peak Forward Current Derating Curve

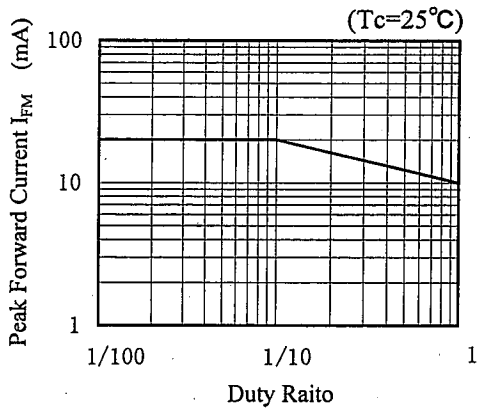

Peak Forward Current vs. Duty Ratio

SHARP

REFERENCE

3-4. Characteristics Diagram (TYP.)

3-4-1. Characteristics Diagram of BC

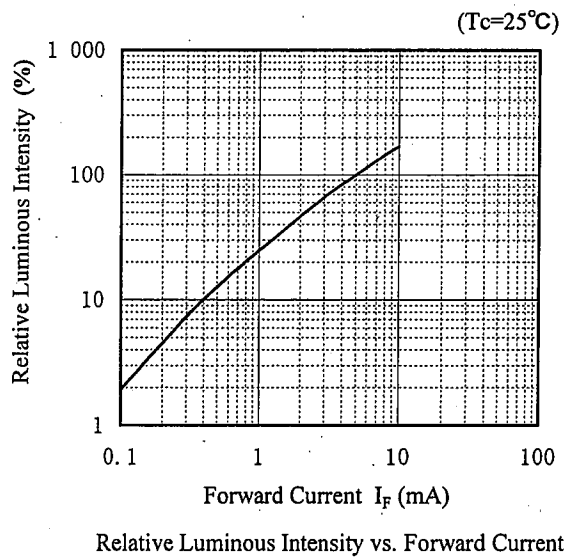
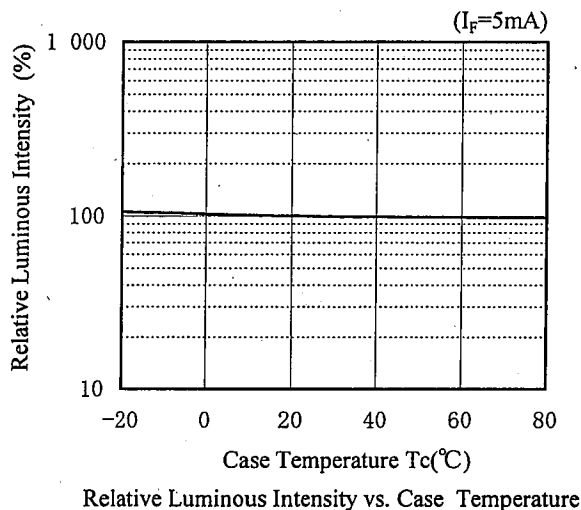
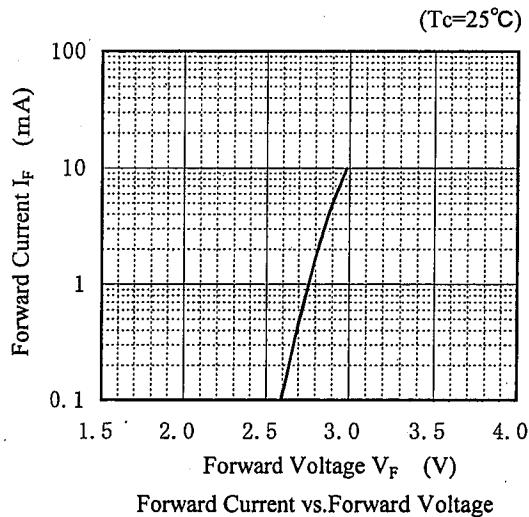

(*)Characteristics data above are typical data and are not guaranteed data.



REFERENCE

3-4. Characteristics Diagram (TYP.)

3-4-2. Characteristics Diagram of GC

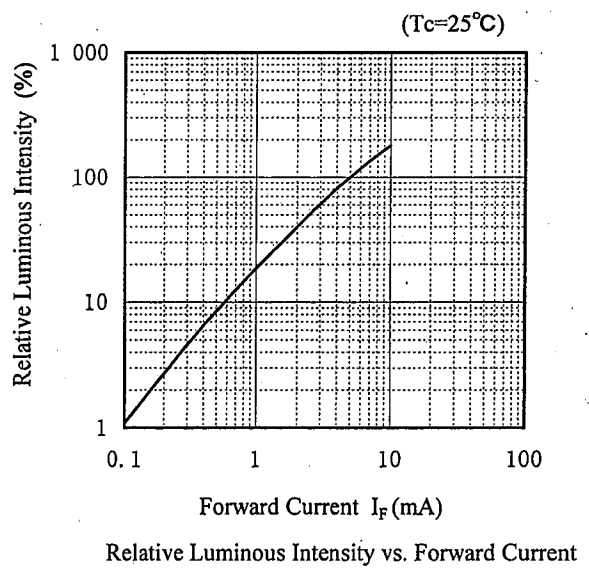
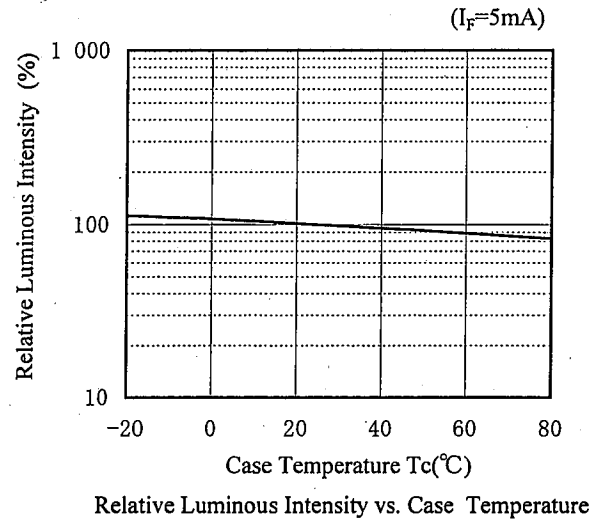
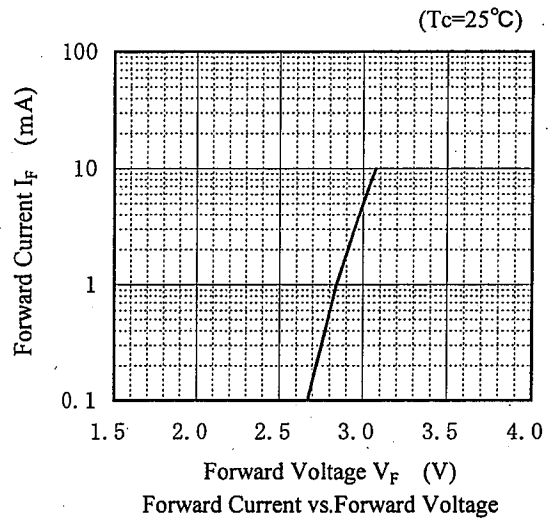

(*) Characteristics data above are typical data and are not guaranteed data.

SHARP

REFERENCE

3-4. Characteristics Diagram (TYP.)

3-4-3. Characteristics Diagram of JJ

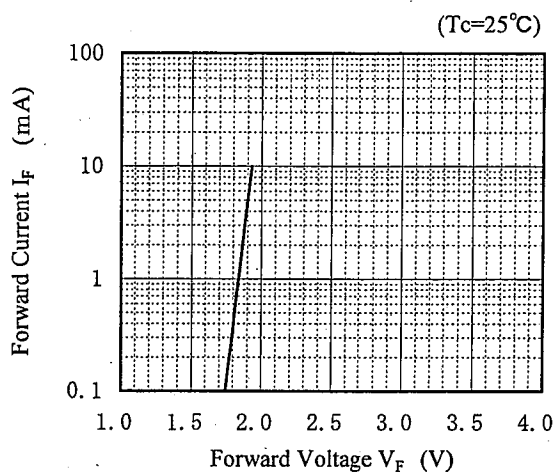

Forward Current vs. Forward Voltage

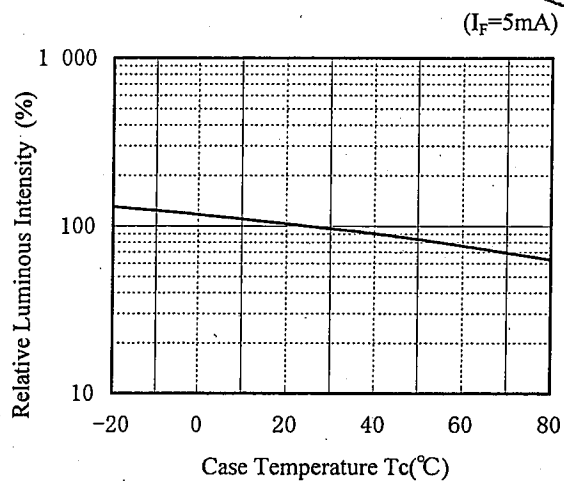

Relative Luminous Intensity vs. Case Temperature

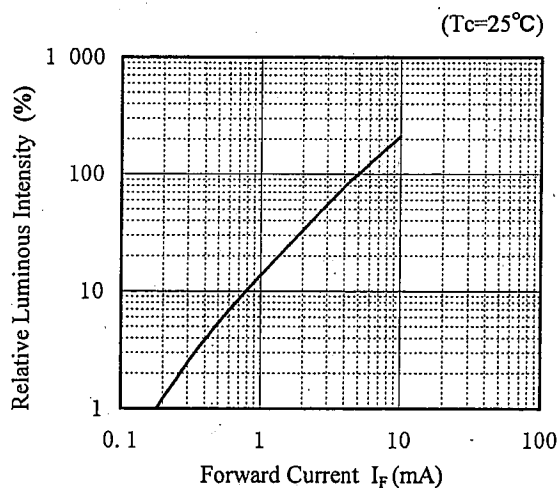

Relative Luminous Intensity vs. Forward Current

(*)Characteristics data above are typical data and are not guaranteed data.

SHARP

REFERENCE

4. Reliability

The reliability of product shall be satisfied with the contents listed below.

4-1. Test items and test conditions

Confidence level: 90%

No.	Test items	Test conditions	Samples n	Defective C	LTPD (%)
1	Temperature cycle	-40 °C(30 min)~+100 °C(30 min), 30 times	22	0	10
2	High temp and high humidity storage	Tstg=+60 °C, RH=90%, t=500 h	22	0	10
3	High temperature storage	Tstg= +100°C, t=500 h	22	0	10
4	Low temperature storage	Tstg=-40°C, t=500 h	22	0	10
5	Operating test	Tc=25 °C, I _F =5mA, t=500 h (3 color-chip simultaneous operation)	22	0	10
6	Mechanical shock	Tc=25 °C, 15 000 m/s ² , 0.5 ms X·Y·Z directions, 3 times respectively	11	0	20
7	Variable frequency vibration	Tc=25 °C, 200 m/s ² , 100~2 000~100 Hz / sweep for 4 min. X·Y·Z directions, 4 times respectively	11	0	20
8	Soldering heat	Twice, refer to Page 14	11	0	20
9	Solder ability (Dip Method) (*1)	240 ± 5°C, 5 ± 1s (Solder/Flux : M705/ESR250 (SENJU METAL INDUSTRY))	11	0	20

4-2. Failure criteria (*2)

Temperature cycle , High temp and high humidity storage , High temperature storage ,
Low temperature storage , Operating test , Mechanical shock test , Variable frequency vibration ,
Soldering heat

No.	Parameter	Symbol	Failure judgment criteria (*3)
1	Forward voltage	V _F	V _F > U.S.L × 1.2
2	Reverse current	I _R	I _R > U.S.L × 2.0
3	Luminous intensity	I _V	I _v < Initial value × 0.5, I _v > Initial value × 2.0

(*1): Solderability failure criteria

•Bottom parts of the product : Refer to the following figure (Solderability judgment area).
If more than 90% of shaded portions are not soldered, it is to be failure.

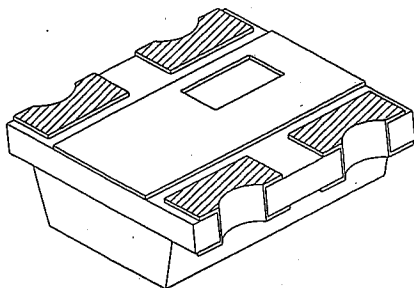

(*2): Measuring conditions accord with the specification.

(*3): U.S.L. stands for Upper Specification Limit.

SHARP**REFERENCE**

5. Quality level

5-1. Applied standard
ISO2859-1

5-2. Sampling method

A single sampling plan, normal inspection level S-4.

5-3. Inspection items and defect criteria

No.	Inspection items	Criteria	Defect	AQL
1	Radiation color	Different from the color prescribed in the page 4/15	Major defect	0.1%
2	Taping	Inserted in wrong direction		
3	Electro-optical characteristics	Not satisfied with specification value (page 4/15), for V_F , I_R , I_V .	Minor defect	0.4%
4	Outline dimensions	Not satisfied with specification value (page 3/15), for outline dimension.		
5	Appearance	More than $\phi 0.6\text{mm}$ of foreign substances, flaws, bubbles. Resin burr which is over dimension tolerance. The defect of resin and the terminals, which are over 0.4mm		

SHARP

REFERENCE

6. Supplements

6-1. Taping

6-1-1. Shape and dimension of tape (Ref.)

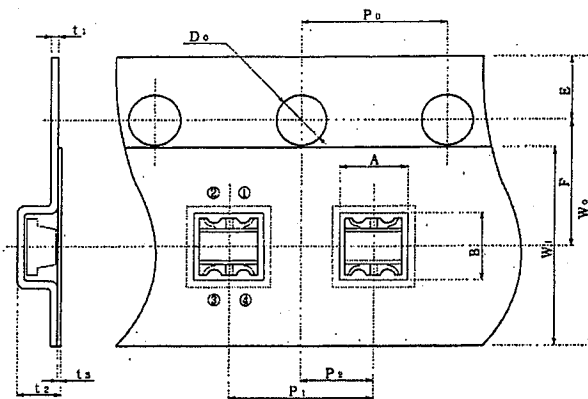

Parameter	Symbol	Dimension [mm]	Remarks		
Concave square hole for parts insertion	Vertical	A	Dimension excluded corner R at the bottom inside.		
	Horizontal	B			
	Pitch	P ₁		4.0	
Round sprocket hole	Diameter	D ₀	1.5		
	Pitch	P ₀	4.0	Accumulated error ±0.5mm/10 pitch	
	Position	E	1.75	Distance between the edge of the tape and the center of the hole	
Center to center distance	Vertical	P ₂	2.0	Distance between center line of the concave square hole and round sprocket hole	
	Horizontal	F	3.5		
Cover tape	Horizontal	W ₁	5.5		
	Thickness	t ₃	0.1		
Carrier tape	Width	W ₀	8.0		
	Thickness	t ₁	0.2		
Thickness of entire unit			t ₂	1.0	With cover tape and carrier tape combined

※Both Carrier tape and Cover tape prevent static electricity.

6-1-2. Shape and dimension of reel (Ref.)

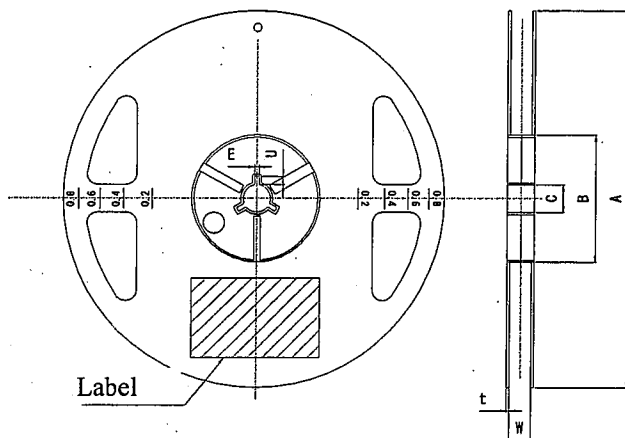

Parameter	Symbol	Dimensions(mm)	Remarks	
Flange	Diameter	A	φ180	
	Thickness	t	1.5	
	Inner space direction	W	10	Dimension of shaft core
Hub	External diameter	B	φ60	
	Spindle hole diameter	C	φ13	
	Key slit	Width	E	2
		Depth	U	4.5
Notation for part name etc.			Labeled on the side of the flange. (part name, quantity, LOT No.)	

※ Material : Reel...Polystyrene

SHARP**REFERENCE****6-1-3. Taping specification**

(1) Lead tape: Applied standard: JIS C0806

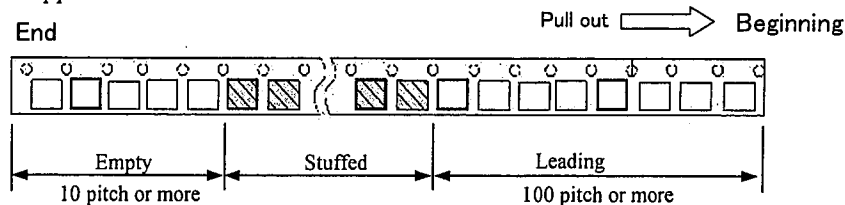
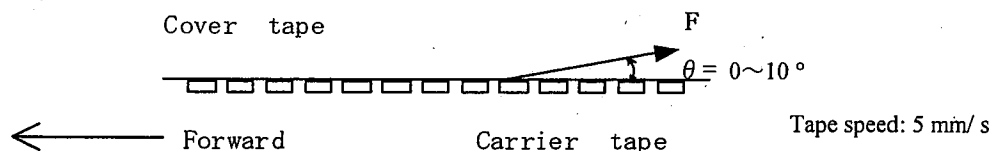
(2) Cover tape strength against peeling: $F = 0.1 \sim 0.8 \text{ N}$ ($\theta = 10^\circ$ or less)

(3) Tape strength against bending:

The radius of curvature should be more than 30mm. If it is warped at under 30mm, the cover may peel off.

(4) Joint of the tape: There should not be joint of cover tape or carrier tape.

(5) Quantity: 5 000 pcs. per reel (standard)

(6) Mass: Approx. 100 g per reel (standard)

(7) Product mass: Approx. 3 mg

- (8) Others:
- ① There is no continuous empty pockets.
 - ② The quantity of the products lacking should be less than 0.1% of total product quantity.
 - ③ Products should be easily taken out.
 - ④ Products should not be attached to the cover tape when it peeled off.

6-2. Packing

In order to avoid the absorption of humidity while transport and storage, the devices are kept in moisture proof aluminum packages.

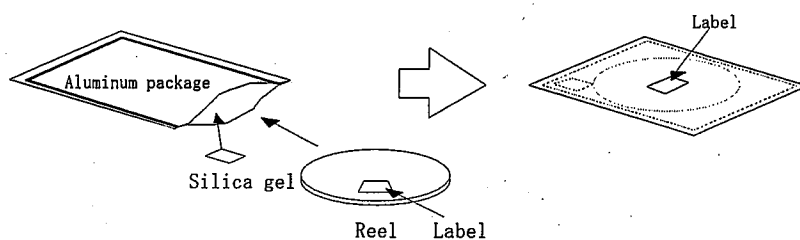
**6-2-1. Storage conditions**

Temperature : 5 to 30 °C Relative humidity : 60% or less

6-2-2. Handling method after opening the packages

① Please give the soldering process under the conditions mentioned below within 7 days after opening the packages.

Temperature : 5 to 30 °C, Relative humidity : 60% or less

② In case that the devices are not used for a long time after opened, the storage in a dry box is recommended. It is also recommended to repack the devices with a desiccative by the sealer and keep them under the same storage conditions as 6-2-1. (within 30days)

③ Please give the following baking treatment before soldering if the blue color of the silica gel indicator changes its color or fades.

(Recommended condition) •In taping

Temperature: 60 °C to 65 °C, Time: 36 to 48 hours



•In individual (on PCB or metallic tray)

Temperature: 100 °C to 120 °C, Time: 2 to 3 hours

REFERENCE

SHARP

6-3. Label

SHARP CORPORATION		
PART No. GM1WA55311A		← Model number
QUANTITY 5000		← Quantity of products
		← EIAJ C-3 Bar code
		← EIAJ C-3 Bar code
LOT No. KA07J24 RANK ○○○		← Indication example of LOT number and rank
<EIAJ C-3> MADE IN JAPAN		← Indication example of production country

1) Lot number

K
A
0
7
J
2
4

①
②
③
④

- ① Production plant code (to be indicated alphabetically)
- ② Year of production (the last two figures of the year)
- ③ Month of production
(to be indicated alphabetically with January corresponding to A)
- ④ Date of production (01~31)

2) RANK○○○ : (Left) Red (Middle)Green (Right)Blue

6-4. Luminous intensyt rank table※

BC (Tc=25°C)

Rank	Luminous intensity	Unit	Condition
A	10 ~ 25	mcd	I _F =5mA
B	19 ~ 47		

(Tolerance ; ±15%)

GC (Tc=25°C)

Rank	Luminous intensity	Unit	Condition
A	36 ~ 77	mcd	I _F =5mA
B	56 ~ 121		
C	89 ~ 190		

(Tolerance ; ±15%)

JJ (Tc=25°C)

Rank	Luminous intensity	Unit	Condition
A	9.8 ~ 26	mcd	I _F =5mA
B	19.0 ~ 51		

※Quantity-ratio of the ranks are decided by Sharp. (Tolerance ; ±15%)

6-5. Information on environmental impact substances

6-5-1. RoHS compliant product

This product is manufactured in accordance with RoHS directive.
(Applied to the products manufactured in and after April of 2001.)

6-5-2. Ozone Depleting Substances

- (1) This product doesn't contain the following Ozone Depleting Substances.
- (2) This product doesn't have a production line whose process requires the following Ozone Depleting Substances.
Restricted substances: CFCs, Halones, CCl₄, 1, 1, 1-Trichloroethane (Methyl chloroform)

SHARP**REFERENCE**

7. Precautions

7-1. General handling

- In designing a circuit, please make sure not to give reverse voltage to the LEDs at any time.
- Since the LEDs are very small, they are easily damaged by external stress.

Please be careful in handling the products not to apply stress to them after the assemblies.

- Please avoid locating the conductor on the top of the resin, since the Au wire is near under the resin surface.
- The LEDs can be damaged by static electricity or surge voltage. Please equip yourself with a wrist band or anti-electricity gloves in handling the LEDs.

Also, make sure that all the devices and equipments must be grounded.

- Materials with high thermal conductivity is used for this device in order to allow generated heat to escape effectively out of the LED. Avoid locating other heat sources (ex. resistance, etc.) near the LED on the circuit board. Those heat sources will damage the devices.

Therefore, the circuit board should be designed in a way that other heat sources are located away from the LED and that the heat generated from the circuit board can easily escape out of the circuit board.

7-2. Soldering

7-2-1. Reflow

- (1) Please handle the products under the condition that package temperature is followed by the reflow profile. (refer to the Fig. below)

However, since external stress and force may cause damage on the internal packages even when it is under the profile condition (refer to the Fig. below), please pay attention to the condition of your reflow machine.

- (2) In case of giving reflow process twice, the second reflow process should be given as soon as possible after the first one. (Storage in a dry box is recommended between the processes.)
- (3) N2 Reflow is also available.
- (4) Temperature profile

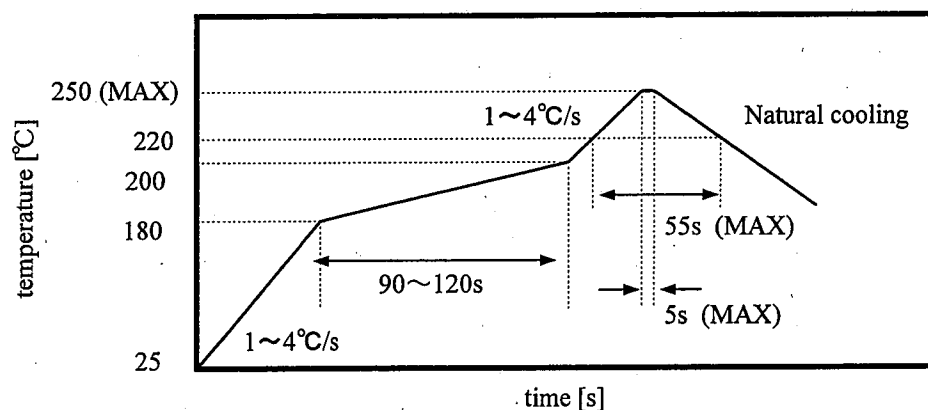

As for Reflow Soldering Temperature Profile, in order to maintain the products quality, it is recommended that the peak temperature should be lower, and cool down should be taken longer, and that the gradient of cooldown temperature should be as low as possible. Moreover, since the thermal conduction to the LEDs depends on the specification of the reflow machine, and the size and layout of the PWBs, please check your solder conditions carefully.

SHARP**REFERENCE****(5) Recommended solder pad design**

Solder ability depends on the reflow condition, solder paste and materials of the PCBs etc.
Please check and study actual solder ability before usage.

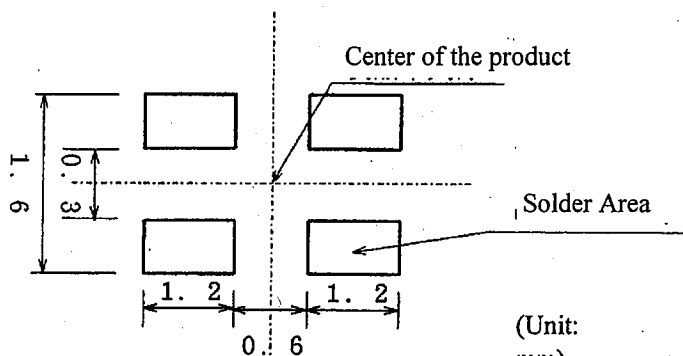
**7-3. Cleaning**

- Please use the soldering paste without need of cleaning.
- If the PCB needs cleaning, please follow the recommended conditions of ultrasonic cleaning.

① Recommended Conditions: R.T. 40kHz, 30W/l, 3 to 5 minutes

② Recommended Solvents: Water, methyl alcohol, ethyl alcohol, or isopropyl alcohol

The affect on the device depends on the conditions such as the size of ultrasonic bath, ultrasonic output, duration, the size of PCB and device mounting method.

Please check and test the cleaning method under the actual conditions before use.