

**User Manual**



# **ARK-6322**

## **Fanless Embedded Box PC**

**ADVANTECH**

*Enabling an Intelligent Planet*

---

## Attention!

This package contains a hard-copy user manual in Chinese for China CCC certification. Please disregard the printed Chinese copy of the user manual if the product is not to be sold and/or installed in China.

## Copyright

The documentation and the software included with this product are copyrighted 2015 by Advantech Co., Ltd. All rights are reserved. Advantech Co., Ltd. reserves the right to make improvements in the products described in this manual at any time without notice. No part of this manual may be reproduced, copied, translated or transmitted in any form or by any means without the prior written permission of Advantech Co., Ltd. Information provided in this manual is intended to be accurate and reliable. However, Advantech Co., Ltd. assumes no responsibility for its use, nor for any infringements of the rights of third parties, which may result from its use.

## Acknowledgements

Award is a trademark of Award Software International, Inc.

VIA is a trademark of VIA Technologies, Inc.

IBM, PC/AT, PS/2 and VGA are trademarks of International Business Machines Corporation.

Intel® and Pentium® are trademarks of Intel Corporation.

Microsoft Windows® is a registered trademark of Microsoft Corp.

RTL is a trademark of Realtek Semi-Conductor Co., Ltd.

ESS is a trademark of ESS Technology, Inc.

UMC is a trademark of United Microelectronics Corporation.

SMI is a trademark of Silicon Motion, Inc.

Creative is a trademark of Creative Technology LTD.

CHRONTEL is a trademark of Chrontel Inc.

All other product names or trademarks are properties of their respective owners.

For more information about this and other Advantech products, please visit our website at:

<http://www.advantech.com/>

<http://www.advantech.com/ePlatform/>

For technical support and service, please visit our support website at:

<http://support.advantech.com.tw/support/>

---

## Product Warranty (2 years)

Advantech warrants to you, the original purchaser, that each of its products will be free from defects in materials and workmanship for two years from the date of purchase.

This warranty does not apply to any products which have been repaired or altered by persons other than repair personnel authorized by Advantech, or which have been subject to misuse, abuse, accident or improper installation. Advantech assumes no liability under the terms of this warranty as a consequence of such events.

Because of Advantech's high quality-control standards and rigorous testing, most of our customers never need to use our repair service. If an Advantech product is defective, it will be repaired or replaced at no charge during the warranty period. For out-of-warranty repairs, you will be billed according to the cost of replacement materials, service time and freight. Please consult your dealer for more details.

If you think you have a defective product, follow these steps:

1. Collect all the information about the problem encountered. (For example, CPU speed, Advantech products used, other hardware and software used, etc.) Note anything abnormal and list any onscreen messages you get when the problem occurs.
2. Call your dealer and describe the problem. Please have your manual, product, and any helpful information readily available.
3. If your product is diagnosed as defective, obtain an RMA (return merchandise authorization) number from your dealer. This allows us to process your return more quickly.
4. Carefully pack the defective product, a fully-completed Repair and Replacement Order Card and a photocopy proof of purchase date (such as your sales receipt) in a shippable container. A product returned without proof of the purchase date is not eligible for warranty service.
5. Write the RMA number visibly on the outside of the package and ship it prepaid to your dealer.

## Declaration of Conformity

### FCC Class A

Note: This equipment has been tested and found to comply with the limits for a Class A digital device, pursuant to part 15 of the FCC Rules. These limits are designed to provide reasonable protection against harmful interference when the equipment is operated in a commercial environment. This equipment generates, uses, and can radiate radio frequency energy and, if not installed and used in accordance with the instruction manual, may cause harmful interference to radio communications. Operation of this equipment in a residential area is likely to cause harmful interference in which case the user will be required to correct the interference at his own expense.

## Technical Support and Assistance

1. Visit the Advantech web site at [www.advantech.com/support](http://www.advantech.com/support) where you can find the latest information about the product.
2. Contact your distributor, sales representative, or Advantech's customer service center for technical support if you need additional assistance. Please have the following information ready before you call:
  - Product name and serial number
  - Description of your peripheral attachments
  - Description of your software (operating system, version, application software, etc.)
  - A complete description of the problem
  - The exact wording of any error messages

## Warnings, Cautions and Notes

**Warning!** *Warnings indicate conditions, which if not observed, can cause personal injury!*



**Caution!** *Cautions are included to help you avoid damaging hardware or losing data.*



**Note!** *Notes provide optional additional information.*



---

## Safety Instructions

1. Read these safety instructions carefully.
2. Keep this User Manual for later reference.
3. Disconnect this equipment from any AC outlet before cleaning. Use a damp cloth. Do not use liquid or spray detergents for cleaning.
4. For plug-in equipment, the power outlet socket must be located near the equipment and must be easily accessible.
5. Keep this equipment away from humidity.
6. Put this equipment on a reliable surface during installation. Dropping it or letting it fall may cause damage.
7. The openings on the enclosure are for air convection. Protect the equipment from overheating. **DO NOT COVER THE OPENINGS.**
8. Make sure the voltage of the power source is correct before connecting the equipment to the power outlet.
9. Position the power cord so that people cannot step on it. Do not place anything over the power cord.
10. All cautions and warnings on the equipment should be noted.
11. If the equipment is not used for a long time, disconnect it from the power source to avoid damage by transient overvoltage.
12. Never pour any liquid into an opening. This may cause fire or electrical shock.
13. Never open the equipment. For safety reasons, the equipment should be opened only by qualified service personnel.
14. If one of the following situations arises, get the equipment checked by service personnel:
  - The power cord or plug is damaged.
  - Liquid has penetrated into the equipment.
  - The equipment has been exposed to moisture.
  - The equipment does not work well, or you cannot get it to work according to the user's manual.
  - The equipment has been dropped and damaged.
  - The equipment has obvious signs of breakage.
15. **DO NOT LEAVE THIS EQUIPMENT IN AN ENVIRONMENT WHERE THE STORAGE TEMPERATURE MAY GO BELOW 0° C (32° F) OR ABOVE 50° C (122° F). THIS COULD DAMAGE THE EQUIPMENT. THE EQUIPMENT SHOULD BE IN A CONTROLLED ENVIRONMENT.**
16. **CAUTION: DANGER OF EXPLOSION IF BATTERY IS INCORRECTLY REPLACED. REPLACE ONLY WITH THE SAME OR EQUIVALENT TYPE RECOMMENDED BY THE MANUFACTURER, DISCARD USED BATTERIES ACCORDING TO THE MANUFACTURER'S INSTRUCTIONS.**
17. **CAUTION:** Any unverified component could cause unexpected damage. To ensure the correct installation, please always use the components (ex. screws) provided with the accessory box.

**ATTENTION:** Tout composant non vérifié pourrait causer des dommages inattendus. Pour garantir une installation correcte, s'il vous plaît utilisez toujours les composants (vis ex.) fournies avec la boîte d'accessoires.
18. **CAUTION:** The computer is provided with a battery-powered real-time clock circuit. There is a danger of explosion if battery is incorrectly replaced. Replace only with same or equivalent type recommended by the manufacturer. Discard used batteries according to the manufacturer's instructions.

**ATTENTION:** L'ordinateur est muni d'un circuit en temps réel de l'horloge alimentée par batterie. Il y a un danger d'explosion si la pile est remplacée de

façon incorrecte. Remplacez uniquement par un type identique ou équivalent vii ARK-6322 User Manual recommandé par le fabricant. Jetez les piles usag

19. CAUTION: Always completely disconnect the power cord from your chassis whenever you work with the hardware. Do not make connections while the power is on. Sensitive electronic components can be damaged by sudden power surges.

ATTENTION: Toujours débrancher complètement le cordon d'alimentation de votre châssis lorsque vous travaillez avec le matériel. Ne pas effectuer les raccordements lorsque l'appareil est sur. Composants électroniques sensibles peuvent être endommagés par les surtensions soudaines.

The sound pressure level at the operator's position according to IEC 704-1:1982 is no more than 70 dB (A).

DISCLAIMER: This set of instructions is given according to IEC 704-1. Advantech disclaims all responsibility for the accuracy of any statements contained herein.

## Packing list

Before installation, please ensure the following items have been shipped:

- 1 x ARK-6322 unit
- 1 x Simplified Chinese user manual
- 1 x China RoHS declarations
- 1 x 2-year warranty card
- 1 x Utility CD
- 1 x Thermal pad for 2.5" HDD and 1 x thermal pad for 3.5" HDD
- 1 x Power bracket and 1 x idoor module bracket

## Ordering Information

Model Number	Description
ARK-6322-Q0A1E	Intel Celeron J1900 QC with 6 COM and 8 USB

## Optional Items

Part Number	Description
1757003934	AC-to-DC Adapter, DC 12V/5A 60W, with DC Jack Plug, 0 ~ 40° C for Home and Office Use
1702002600-01	Power cable 3-pin 183 cm, USA type
1700018705	Power cable 3-pin 183 cm, Europe type
1700018704	Power cable 3-pin 183 cm, UK type
1700000237-01	Power cable 3-pin 183 cm, PSE type
AMK-V008E	VESA mounting kit
AMK-W002E	Wall mounting kit
1700024047-01	F Cable 2*5P-2.0/D-SUB 9P(F) 15CM
MOS-2230-Z1201E	CANBus module, 2-Ch, USB I/F,
MOS-2220-X1101E	Parallel LPT module, 1-Ch, USB I/F,
MOS-2220-Z1101E	High Speed Serial COM module, 1-Ch, USB I/F,
MOS-2120-Z1101E	Giga LAN Ethernet module, 1-Ch, PCIe I/F,
MOS-1120Y-0201E	Isolated RS-232, 2-Ch, DB9, PCIe I/F
MOS-1121Y-0201E	Isolated RS-422/485, 2-Ch, DB9, PCIe I/F
MOS-1120Y-1401E	Non-Isolated RS-232, DB37, 4-Ch, PCIe I/F
MOS-1121Y-1401E	Non-Isolated RS-422/485, DB37, 4-Ch, PCIe I/F
MOS-1130Y-0201E	Isolated CANBus, 2-Ch, DB9, PCIe I/F
MOS-1110Y-0101E	Isolated 16 DI/8 DO, 1-Ch, DB37, PCIe I/F



# Contents

<b>Chapter 1</b>	<b>General Introduction .....</b>	<b>1</b>
1.1	Introduction .....	2
1.2	Features .....	2
1.3	Specifications .....	2
1.3.1	General .....	2
1.3.2	Display .....	3
1.3.3	Ethernet .....	3
1.3.4	Power Requirement .....	3
1.4	Environmental Specifications .....	3
1.5	Mechanical Specifications .....	4
1.5.1	ARK-6322 Dimensions.....	4
	Figure 1.1 ARK-6322 mechanical dimension drawing.....	4
<b>Chapter 2</b>	<b>General Information .....</b>	<b>5</b>
2.1	Jumpers .....	6
2.1.1	Jumper Options.....	6
2.1.2	Setting Jumper on main board.....	6
2.1.3	CMOS Mode Selection (JRTCTEST1).....	6
	Table 2.1: CMOS Mode Selection (JRTCTEST1) .....	6
2.1.4	COM3 RS-232/422/485 Mode Selector (JSETCOM3).....	7
	Table 2.2: COM3 RS-232/422/485 Mode Selector (JSETCOM3).....	7
	Table 2.3: COM3 RS-232/422/485 Mode Selector (JSETCOM3).....	7
2.1.5	RS-485/422 Terminal Resistor Jumper (SW_422_1) .....	8
	Table 2.4: RS-485/422 Terminal Resistor Jumper (SW_422_1) .....	8
2.1.6	JOBS1 + JWDT1: OBS Beep and Watchdog Timer Output .....	8
	Table 2.5: JOBS1 + JWDT1: OBS Beep and Watchdog Timer Output.....	8
2.2	ARK-6322 I/O Indication .....	9
2.2.1	Front I/O Indication .....	9
2.2.2	Rear I/O Indication .....	9
2.3	I/O Connectors .....	10
2.3.1	DC-IN Adaptor Connector (DCIN1).....	10
2.3.2	Display Port Connector (DP1).....	10
2.3.3	VGA Connector (VGA1).....	11
2.3.4	USB3.0 + USB2.0 Stack Connector (USB0102).....	11
2.3.5	USB2.0 * 2 Stack Connector (USB0304).....	12
2.3.6	USB2.0 * 4 Connector (USB05060708).....	12
2.3.7	RJ45 (LAN1 + LAN2) Connector (LAN12) .....	12
2.3.8	COM Ports .....	13
2.3.9	HD Analog Audio Interface (AUDIO1).....	13
2.3.10	Digital Connector (Reserved).....	14
2.4	Installation .....	14
2.4.1	Memory Installation .....	14
2.4.2	MiniPCIe device Installation.....	15
2.4.3	HDD Installation .....	16
<b>Chapter 3</b>	<b>BIOS Operation .....</b>	<b>19</b>
3.1	Introduction .....	20
3.2	BIOS Setup .....	20
3.2.1	Main Menu .....	21
3.2.2	Advanced BIOS Features .....	22

3.2.3	Chipset.....	33
3.2.4	Security.....	36
3.2.5	Boot .....	37
3.2.6	Save and Exit.....	38

## **Appendix A      Programming the Watchdog Timer . 39**

A.1	Programming the Watchdog Timer .....	40
A.1.1	Watchdog Timer Overview .....	40
A.1.2	Programming the Watchdog Timer.....	40
	Table A.1: Watchdog Timer Registers.....	42
A.1.3	Example Program .....	43

# Chapter 1

## General Introduction

This chapter gives background information on ARK-6322.

## 1.1 Introduction

ARK-6322 fanless embedded box computer is a value, intelligent and application-focus system powered by an Intel Celeron J1900 Quad Core processor with multiple I/O ports. The solid aluminum top cover and sealed chassis offers vibration, shock and dust resistance with a passive cooling solution which provides quiet and reliable operation.

### Computing system with multiple I/O ports

ARK-6322 uses an Intel Celeron J1900 Quad Core processor at 2.0GHz default setting and up to 2.41GHz with turbo boost setting on. Memory supports a maximum 8G DDR3L 1333Mhz. Compared to Intel Atom D510/D525 processors, the CPU performance increase is 150% and the graphic performance offers significant improvement. ARK-6322 not only provides dual display, VGA and display port, six COM ports, eight USB ports including one USB 3.0, dual LAN ports and one reserved DIO, but also provides dual storage, mSATA and a hard drive of either 2.5 or 3.5 inch HDD for massive data storage.

### Easy customization with MOS modules

ARK-6322 reserves a mechanical door to meet customized requirements. There are ten kinds of MOS modules such as isolated/non-isolated serial ports, CANBus, Parallel LPT port and LAN as extended connectors on the front bezel to satisfy customer applications. These modules are full-size miniPCIe modules with connectors which pass CCC, EMI and safety certification with our system.

### Self-sensing management application- SUSIAccess

ARK-6322 provides self-sensing and management capabilities for remote monitoring and control, self-diagnosis and correction; and automatically sends alerts by email. Acronis executes backup and storage to save valuable data if the system encounters problems or crashes. McAfee white-listing screening allows only pre-authorized programs to run and also provides an encryption lock to prevent theft and helps avoid programs and assets being copied to another computer.

## 1.2 Features

- Reliable fanless operation powered by Intel® Celeron J1900 QC 2.0GHz SoC processor.
- Multiple I/O ports with dual display VGA and display port, dual storage mSATA and 2.5"/3.5" hard drive bay, dual LANs, six serial ports, one USB 3.0 and seven USB 2.0.
- Mechanical flexible design reserved for idoor modules with extended I/Os and easy customization.
- Low power consumption and application-ready system.
- Suitable for VESA/Desk mounting kits.

## 1.3 Specifications

### 1.3.1 General

- **CPU:** Intel® Celeron J1900 QC 2.0GHz SoC Processor
- **BIOS:** AMI 16 Mbit SPI
- **System Memory:** Up to 8G DDR3L 1333GHZ SODIMM

- **Watchdog Timer:** 255-level interval timer, setup by software
- **Serial Ports:** 5 x RS-232 & 1 x RS-232/422/485 (COM3, BIOS selectable)
- **USB:** 1 x USB 3.0 & 7 x USB 2.0
- **Audio:** Realtek ALC892, Line-out or mic-in
- **Expansion Interface:** 1 x half-size miniPCIe for WLAN or WWAN and 1 x full-size miniPCIe slot for WLAN, WWAN or mSATA

### 1.3.2 Display

- **Controller:** Embedded Gen7, Gfx frequency 688 MHz
- **Display memory:** Shared system memory of up to 224 MB dynamically
- **VGA:** Display resolution up to 2560 x 1600 @ 60 Hz
- **DisplayPort 1.2:** Display resolution up to 2560 x 1600 @ 60 Hz
- **Dual Display:** VGA + DP

### 1.3.3 Ethernet

- **Controller:**
  - LAN1: Realtek 8111E;
  - LAN2: Realtek 8111E
- **Speed:** Supports dual 10/100/1000 Mbps Ethernet port (s) via PCI Express x1 bus which provides a data transmission rate of 500 MB/s
- **Interface:** 2 x RJ45

### 1.3.4 Power Requirement

- **Power Input Voltage:** DC 12V
- **Power Adapter:** AC to DC, DC12 V/ 5A, 60W with lockable design
- **RTC battery:** BATTERY 3V/210 mAh with WIRE

## 1.4 Environmental Specifications

- **Operating temperature:**
  - 0 ~ 40°C With standard temperature 3.5"HDD
  - 0 ~ 45°C With standard temperature 2.5"HDD
  - 0 ~ 50°C With standard temperature mSATA/SSD
- **Relative humidity:** 95% @ 40°C (non-condensing)
- **Storage temperature:** -40 ~ 85°C (-40 ~ 185°F)
- **Vibration loading during operation:** With HDD: 0.5 Grms, IEC 60068-2-64, random, 5 ~ 500 Hz, 1 hr/axis
- **Shock during operation:** With HDD: 10 G, IEC 60068-2-27, half sine, 11 ms duration
- **Safety:** UL,CB,CCC,BSMI
- **EMC:** CE, FCC Class A, BSMI, CCC

## 1.5 Mechanical Specifications

### 1.5.1 ARK-6322 Dimensions

Unit:mm

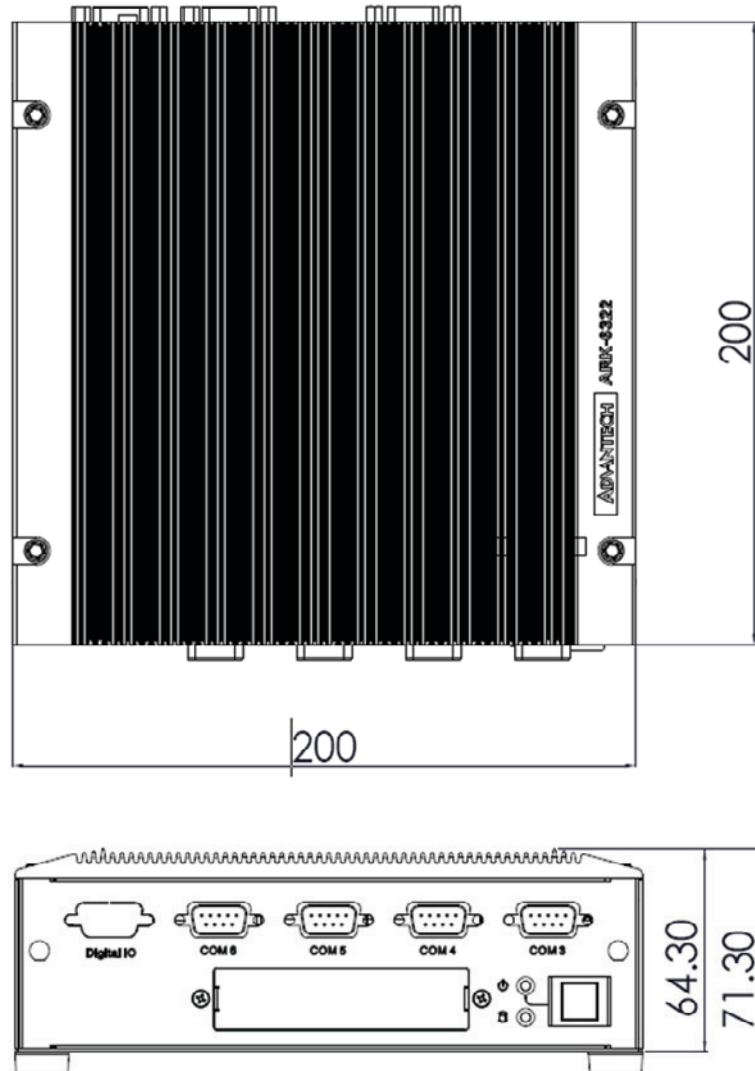

Figure 1.1 ARK-6322 mechanical dimension drawing

# Chapter 2

General Information

## 2.1 Jumpers

### 2.1.1 Jumper Options

This section provides instructions on how to configure the motherboard by setting jumpers, and also outlines the default motherboard settings and options for each jumper.

### 2.1.2 Setting Jumper on main board

The motherboard can be configured according to the application requirements with the setting of jumpers. A jumper is a metal bridge used to close an electrical circuit.

Jumpers typically consist of two metal pins and a small metal clip (often protected by a plastic cover) that slides over the pins to connect them. To “close” (or turn ON) a jumper, connect the pins with the clip. To “open” (or turn OFF) a jumper, simply remove the clip. Some jumpers comprise a set of three pins, labeled 1, 2, and 3. With these jumpers, simply connect either Pins 1 and 2, or Pins 2 and 3. A pair of needle nose pliers may be necessary for setting jumpers.

### 2.1.3 CMOS Mode Selection (JRTCCTEST1)

The jumper can erase CMOS data and reset the system BIOS information. This jumper is typically set with Pins 1 and 2 being closed. To reset the CMOS data, set J1 to Pins 2 and 3 as closed for a few seconds before moving the jumper back to Pins 1 and 2 as closed. This procedure resets the CMOS to its default settings.

**Table 2.1: CMOS Mode Selection (JRTCCTEST1)**

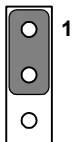
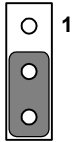
Function	Setting
Normal (Default)	
Clear CMOS	



## 2.1.4 COM3 RS-232/422/485 Mode Selector (JSETCOM3)

Users can select between the RS-232/422/485 modes for COM3 using JSETCOM3. The default setting is “RS-232”.

**Table 2.2: COM3 RS-232/422/485 Mode Selector (JSETCOM3)**

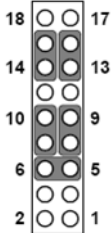
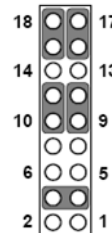
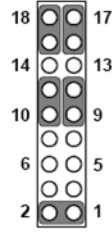
Function	Setting
Set COM3 as RS-232 (default)	
Set COM3 as RS-422	
Set COM3 as RS-485	

**Table 2.3: COM3 RS-232/422/485 Mode Selector (JSETCOM3)**

Function	Jumper Settings
RS-232*	(5-6) + (7-9) + (8-10) + (13-15) + (14-16) closed
RS-422	(3-4) + (9-11) + (10-12) + (15-17) + (16-18) closed
RS-485	(1-2) + (9-11) + (10-12) + (15-17) + (16-18) closed
*default	

## 2.1.5 RS-485/422 Terminal Resistor Jumper (SW\_422\_1)

**Table 2.4: RS-485/422 Terminal Resistor Jumper (SW\_422\_1)**

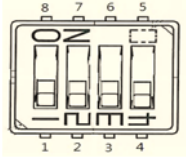
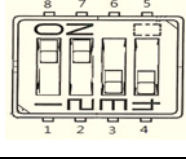
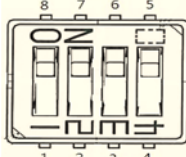
Function	Settings
Default	
Add RS-485 terminator	
Add RS-422 terminator	

## 2.1.6 JOBS1 + JWDT1: OBS Beep and Watchdog Timer Output

**Table 2.5: JOBS1 + JWDT1: OBS Beep and Watchdog Timer Output**

Closed Pins	Result
2-3*	Watchdog reset
4-5*	OBS alarm

\*default

Function	Settings										
Watchdog Timer Output (2-3) (default) OBS BEEP (4-5) (default)	<table border="1"> <tr> <td>1</td> <td>2</td> <td>3</td> <td>4</td> <td>5</td> </tr> <tr> <td></td> <td>●</td> <td>●</td> <td>●</td> <td>●</td> </tr> </table>	1	2	3	4	5		●	●	●	●
1	2	3	4	5							
	●	●	●	●							
Watchdog Timer disabled (1-2) OBS BEEP (4-5) (default)	<table border="1"> <tr> <td>1</td> <td>2</td> <td>3</td> <td>4</td> <td>5</td> </tr> <tr> <td>●</td> <td>●</td> <td>○</td> <td>●</td> <td>●</td> </tr> </table>	1	2	3	4	5	●	●	○	●	●
1	2	3	4	5							
●	●	○	●	●							

## 2.2 ARK-6322 I/O Indication

### 2.2.1 Front I/O Indication

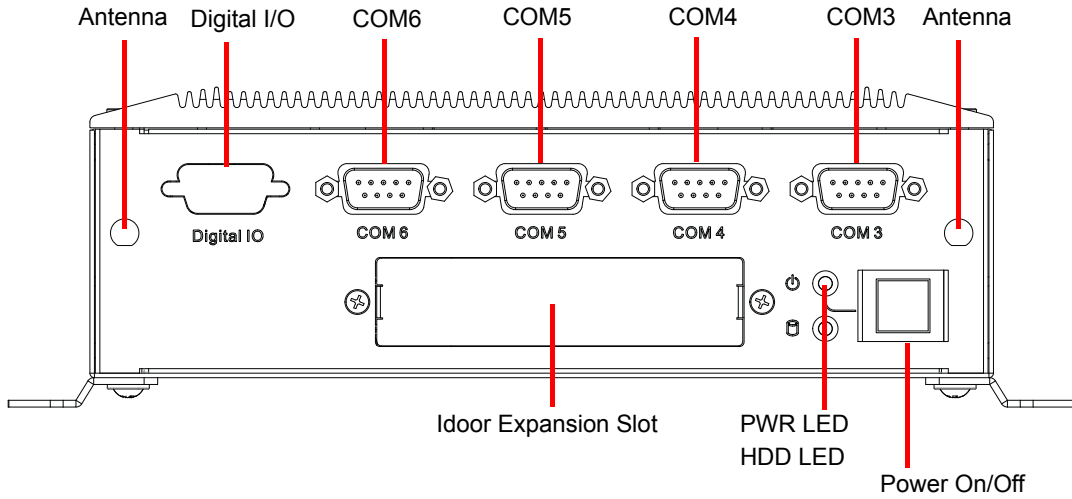

### 2.2.2 Rear I/O Indication

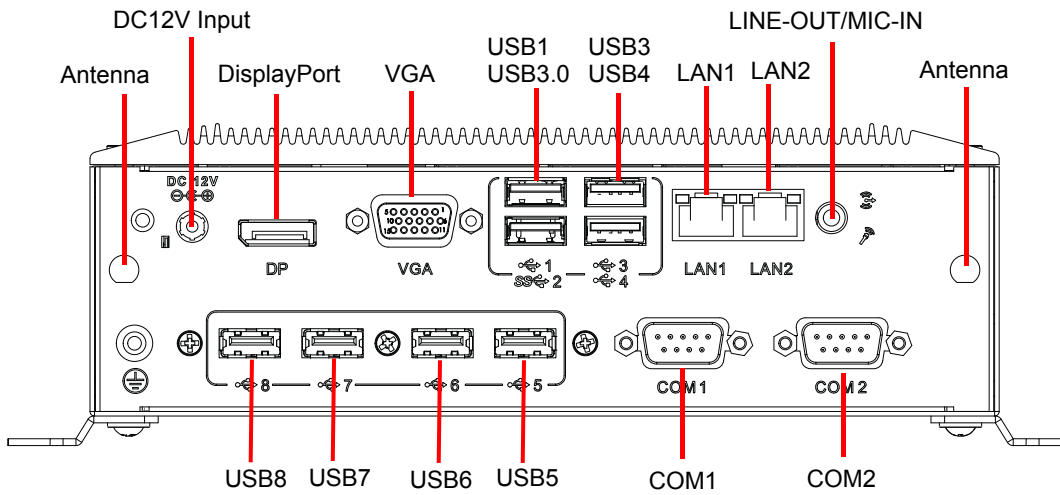

## 2.3 I/O Connectors

### 2.3.1 DC-IN Adaptor Connector (DCIN1)

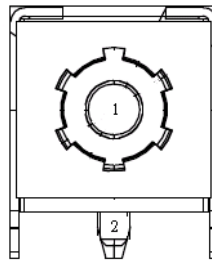

Pin	Signal	Pin	Signal
1	VCC	2	VCC

### 2.3.2 Display Port Connector (DP1)

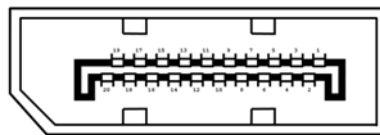

Pin	Signal	Pin	Signal
1	ML_LANE0+	2	GND
3	ML_LANE0-	4	ML_LANE1+
5	GND	6	ML_LANE1-
7	ML_LANE2+	8	GND
9	ML_LANE2-	10	ML_LANE3+
11	GND	12	ML_LANE3-
13	Config 1	14	GND
15	AUX_CH+	16	GND
17	AUX_CH-	18	Hot Plug Detect
19	GND	20	+3.3V

### 2.3.3 VGA Connector (VGA1)

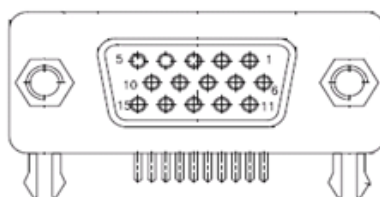

Pin	Signal	Pin	Signal
1	RED	9	VCC
2	GREEN	10	SGND
3	BLUE	11	N.C.
4	GND	12	SDA
5	VCC	13	HSYNC
6	RED GND	14	VSYNC
7	GREEN GND	15	SCL
8	BLUE GND		

### 2.3.4 USB3.0 + USB2.0 Stack Connector (USB0102)

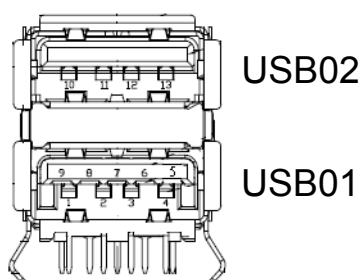

Pin	Signal	Pin	Signal
1	VBUS_2	8	StdA_SSTX-
2	D-_2	9	StdA_SSTX+
3	D+_2	10	VBUS_1
4	GND_2	11	D-_1
5	StdA_SSRX-	12	D+_1
6	StdA_SSRX+	13	GND_1
7	GND_DRAIN	14	

### 2.3.5 USB2.0 \* 2 Stack Connector (USB0304)

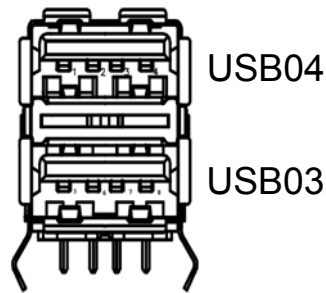

Pin	Signal	Pin	Signal
1	VCC_USB0	5	VCC_USB1
2	USB-0_B	6	USB-1_B
3	USB+0_B	7	USB+1_B
4	GND_1	8	GND_2

### 2.3.6 USB2.0 \* 4 Connector (USB05060708)

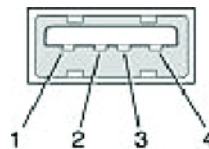

Pin	Signal	Pin	Signal
1	+5V	2	USB_data-
3	USB_data+	4	GND

### 2.3.7 RJ45 (LAN1 + LAN2) Connector (LAN12)

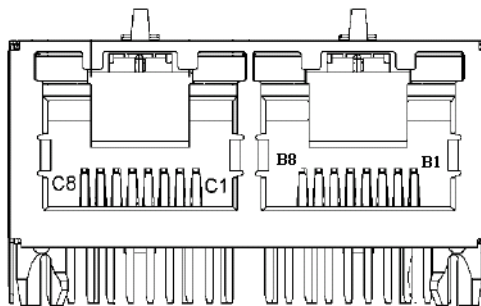

Pin	Signal	Pin	Signal
B1	LAN1_MID0+	C1	LAN2_MID0+
B2	LAN1_MID0-	C2	LAN2_MID0-
B3	LAN1_MID1+	C3	LAN2_MID1+
B4	LAN1_MID1-	C4	LAN2_MID1-
B5	LAN1_MID2+	C5	LAN2_MID2+
B6	LAN1_MID2-	C6	LAN2_MID2-

B7	LAN1_MID3+	C7	LAN2_MID3+
B8	LAN1_MID3-	C8	LAN2_MID3-

### 2.3.8 COM Ports

ARK-6322 offers six D-sub 9-pin serial ports. COM1/2/4/5/6 support RS-232 and COM3 supports RS-232/422/485. Default setting is RS-232, if you want to use RS-422/485, please change BIOS setting and jumper setting (see 2.1.4).

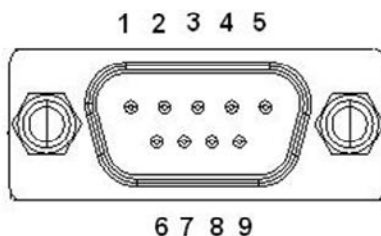

	RS-232	RS-422	RS-485
Pin	Signal Name	Signal Name	Signal Name
1	DCD	Tx-	DATA-
2	RxD	Tx+	DATA+
3	TxD	Rx+	NC
4	DTR	Rx-	NC
5	GND	GND	GND
6	DSR	NC	NC
7	RTS	NC	NC
8	CTS	NC	NC
9	RI	NC	NC

### 2.3.9 HD Analog Audio Interface (AUDIO1)

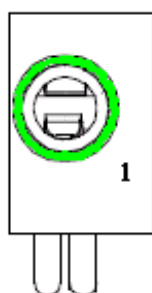

Pin	Signal
1	LINE OUT

## 2.3.10 Digital Connector (Reserved)

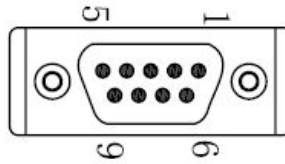

Pin	Signal
1	DIO bit0
2	DIO bit1
3	DIO bit2
4	DIO bit3
5	DIO bit4
6	DIO bit5
7	DIO bit6
8	DIO bit7
9	GND

## 2.4 Installation

### 2.4.1 Memory Installation

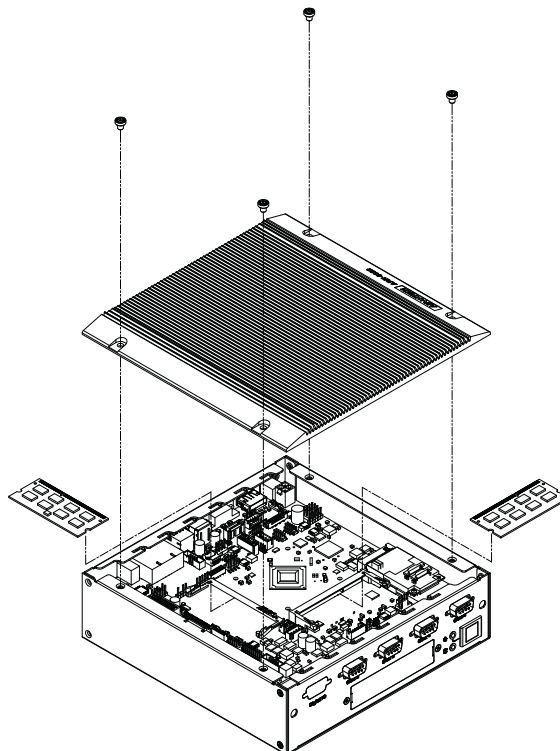

1. Unscrew 4 screws on top cover.
2. Install DDR3L memory.



3. Screw 4 screws on top cover

**Note!** *If there is only one memory, please install on DIMMA socket.*



## 2.4.2 MiniPCle device Installation

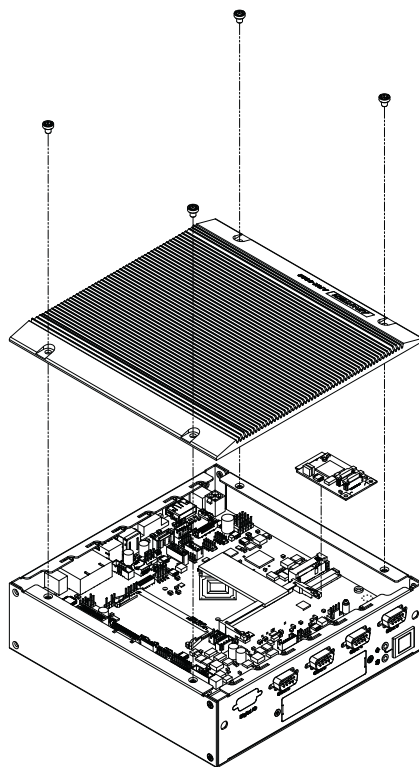

1. Unscrew 4 screws on the top cover.
2. Install the miniPCle device and attach with the miniPCle nuts.
3. Screw the 4 screws on the top cover.

**Note!** *Full-size miniPCle supports colay with mSATA.*



## 2.4.3 HDD Installation

### 2.4.3.1 2.5 inch HDD installation

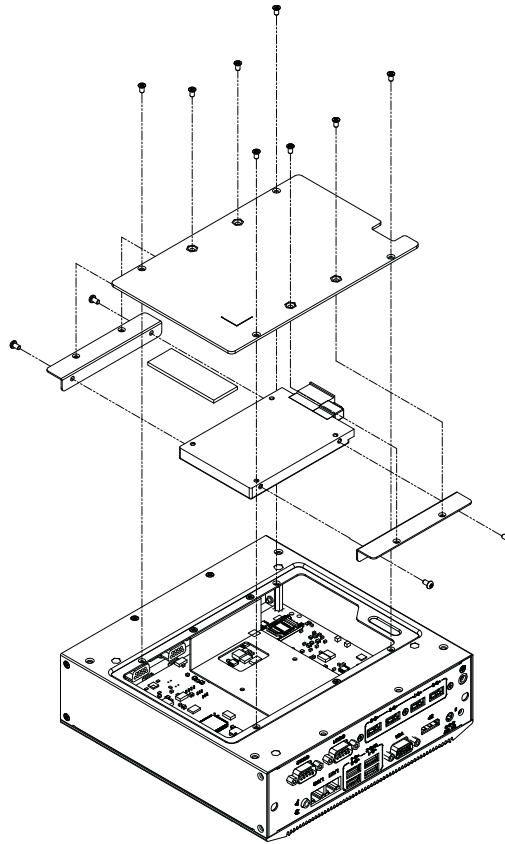

1. Unscrew the 4 screws on the bottom cover.
2. Attach the thermal pad 64 x 23 x 2.5 mm (in the accessory box) for 2.5" HDD
3. Attach the 4 screws with 2.5" HDD bracket on the bottom cover.
4. Screw the 4 screws onto the bottom cover.

**Note!** Please refer to your HDD datasheet for thermal pad location.



### 2.4.3.2 3.5 inch HDD installation

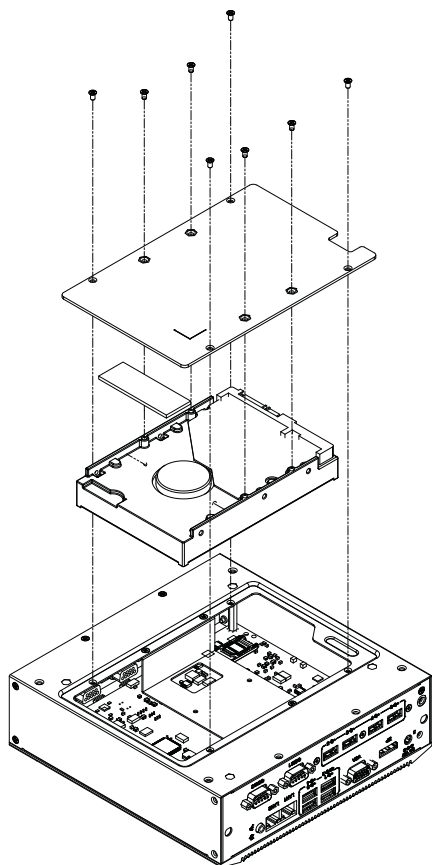

1. Unscrew the 4 screws on the bottom cover.
2. Uninstall the HDD bracket.
3. Attach the thermal pad 48.7x42x1.5mm (in the accessory box) for a 3.5" HDD which supports a maximum height of 26.1mm.
4. Install the 4 screws on the bottom cover.

**Note!** Please refer to HDD datasheet for thermal pad location.





# Chapter 3

BIOS Operation

## 3.1 Introduction

With the AMI BIOS Setup program, users can modify the BIOS settings and control the special system features. The Setup program comprises of several menus with options for adjusting or turning special features on or off. This chapter describes the basic navigation of the ARK-6322 BIOS setup menu pages.

## 3.2 BIOS Setup

The ARK-6322 is equipped with built-in AMI BIOS and a CMOS Setup Utility that allows users to configure specific settings or activate certain system features.

The CMOS Setup Utility saves the configuration in the CMOS RAM of the motherboard. When the system power is turned off, the battery on the board supplies the necessary power to preserve the CMOS RAM.

When the power is turned on, press the <Del> button during the BIOS power-on self-test (POST) to access the CMOS Setup Utility screen.

---

### Control Keys

---

<Enter>	Select item
<Esc>	Main Menu - Quit without saving changes to the CMOS Sub Menu - Exit current page and return to the Main Menu
<Page Up/+>	Increase the numeric value or make changes
<Page Down/->	Decrease the numeric value or make changes
<F1>	General help, for Setup Sub Menu
<F2>	Item help
<F5>	Load previous values
<F7>	Load setup defaults
<F10>	Save all CMOS changes

---

### 3.2.1 Main Menu

Press <Del> to enter the AMI BIOS CMOS Setup Utility, the Main Menu will appear on the screen. Use the arrow keys to select items and press <Enter> to access the submenu.

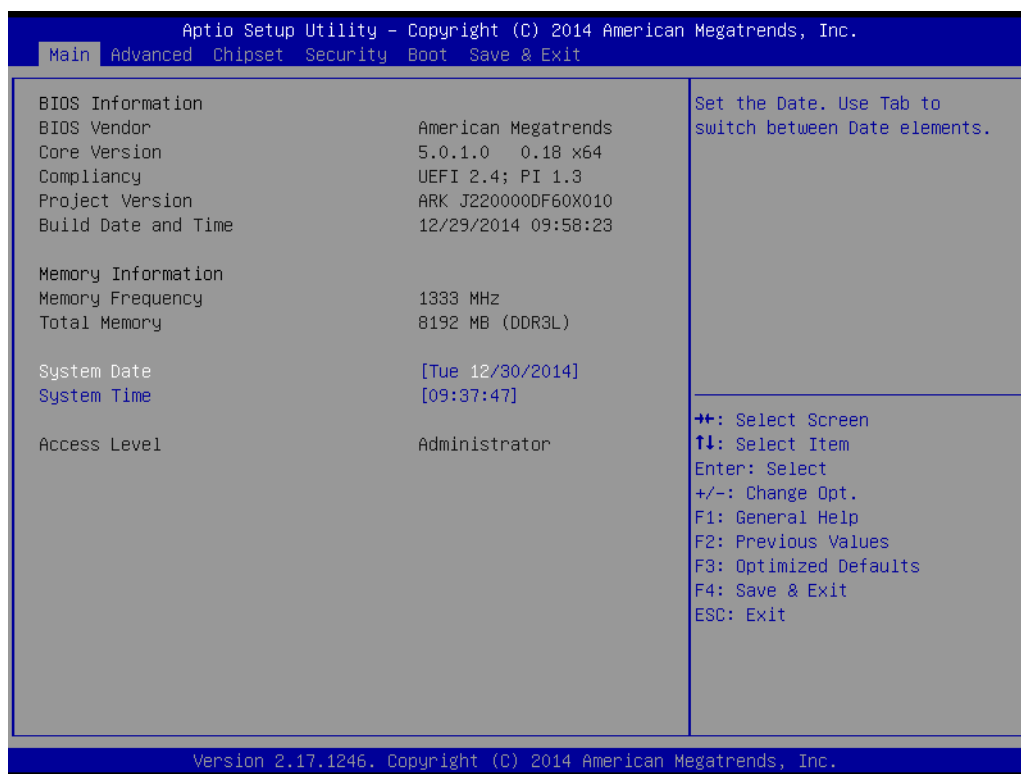

The Main BIOS Setup page comprises two main frames. The left frame displays all configurable options. Grayed-out options cannot be configured, whereas the options displayed in blue can be. The right frame also displays the key legend.

The area above the key legend is reserved for text messages. When an option is selected in the left frame, the display text changes to white and is often accompanied by a text message.

#### ■ System Time/System Date

Use this option to change the system time and date. Highlight the System Time or System Date using the <Arrow> keys. Enter new values via the keyboard. Press the <Tab> or <Arrow> keys to move between fields. The date must be entered in MM/DD/YY format. The time must be entered in HH:MM:SS format.

### 3.2.2 Advanced BIOS Features

Select the Advanced tab from ARK-6322 Setup menu to enter the Advanced BIOS Setup page. Users can select any item in the left frame of the screen, such as CPU Configuration, to access the submenu for that item. Select an Advanced BIOS Setup option by highlighting the text using the <Arrow> keys. All Advanced BIOS Setup options are described in this section. The Advanced BIOS Setup menu screen is shown below. The submenus are described in the following pages.

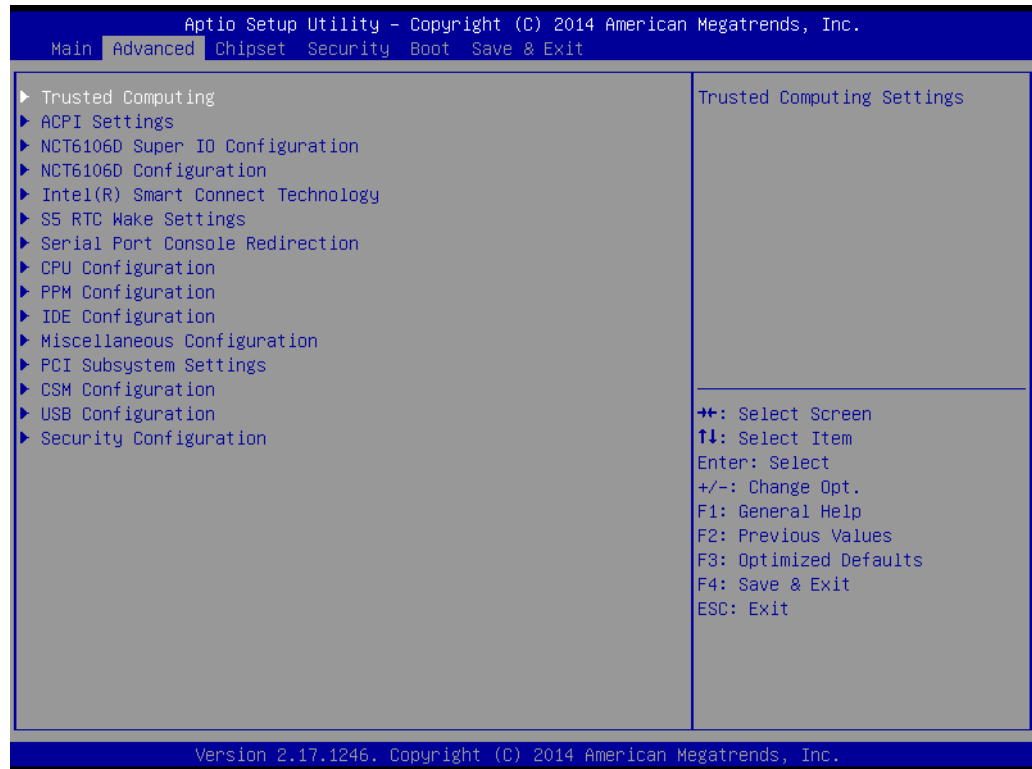



### 3.2.2.1 ACPI Settings

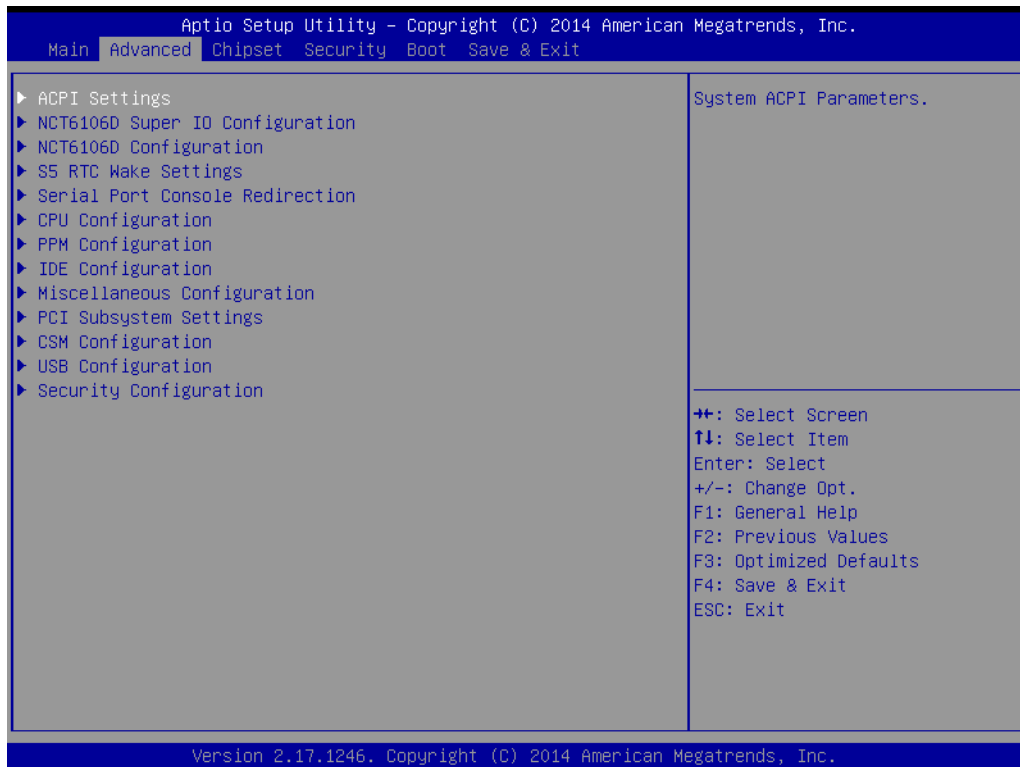

- **Enable ACPI Auto Configuration**  
This item allows users to enable or disable ACPI auto configuration.
- **Enable Hibernation**  
This item allows users to enable or disable hibernation.
- **ACPI Sleep State**  
This item allows users to set the ACPI sleep state.
- **Lock Legacy Resources**  
This item allows users to lock legacy device resources.

### 3.2.2.2 PC Health Status

This page shows ARK-6322 PC health status.

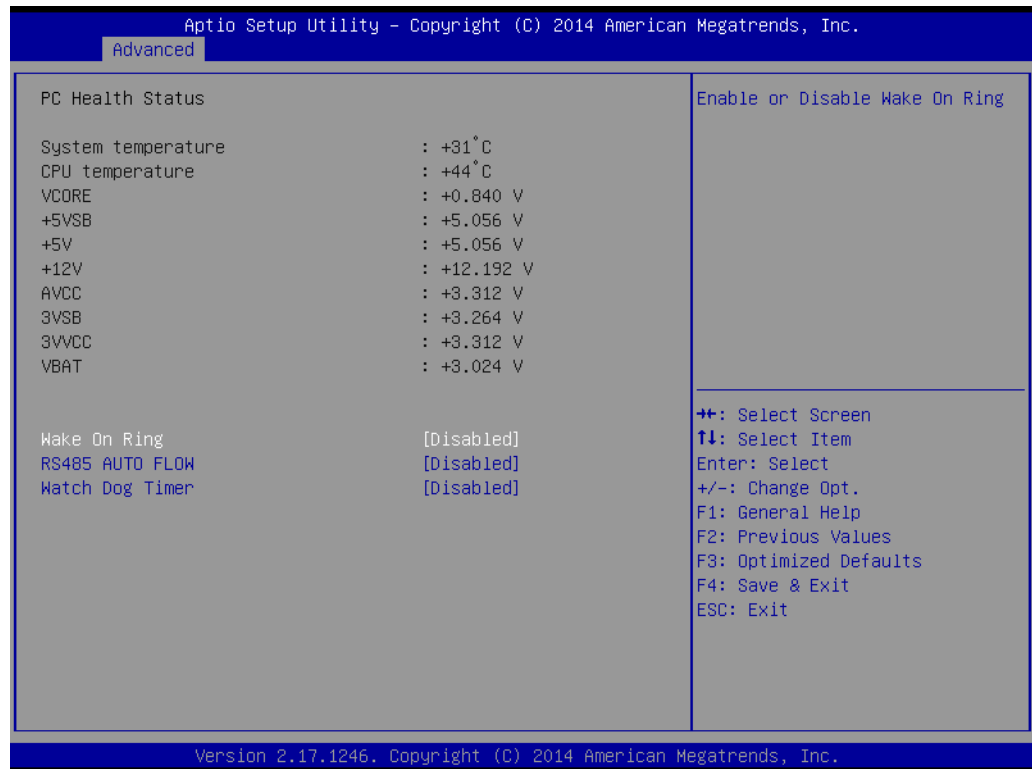

- **CPU Warning Temperature**  
This item allows users to set the CPU temperature threshold. When the system CPU reaches the threshold temperature, a buzzer will emit a warning alert.
- **Wake On Ring**  
This item allows users to enable or disable Wake On Ring functionality.
- **RS-485 AUTO FLOW**  
This item allows users to enable or disable the RS-485 AUTO FLOW function.
- **Watchdog Timer**  
This item allows users to enable or disable the Watchdog timer.

### 3.2.2.3 S5 RTC Wake Settings

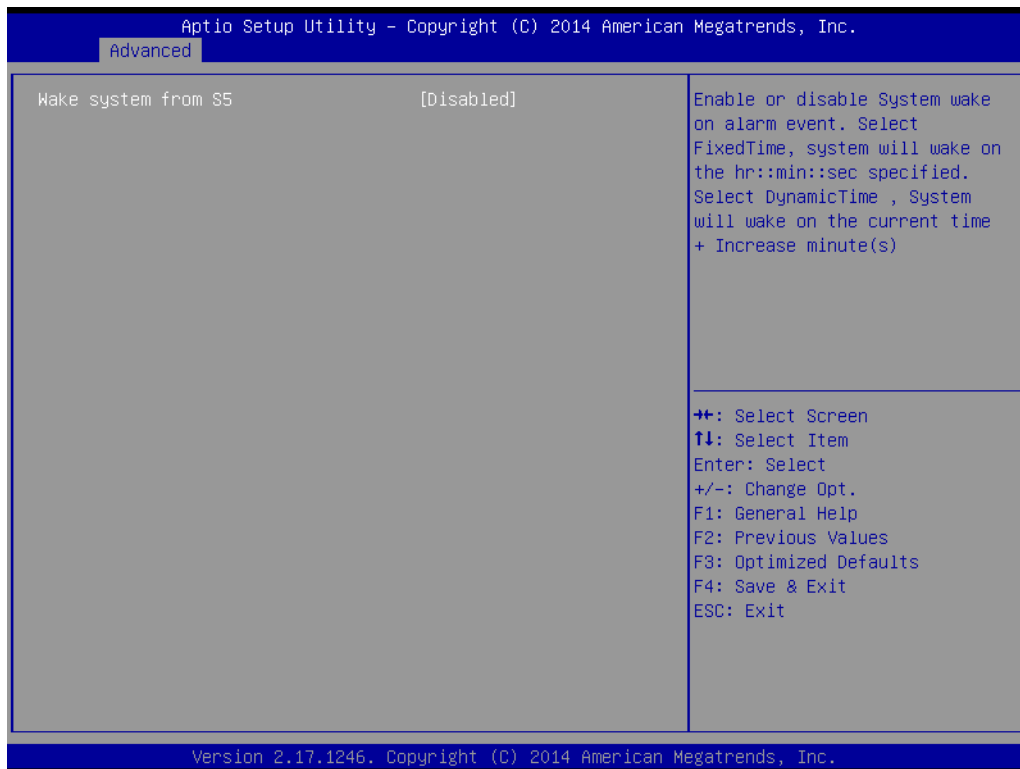

- Wake System From S5**  
 This item allows users to enable or disable system wake on alarm event.

### 3.2.2.4 Serial Port Console Redirection

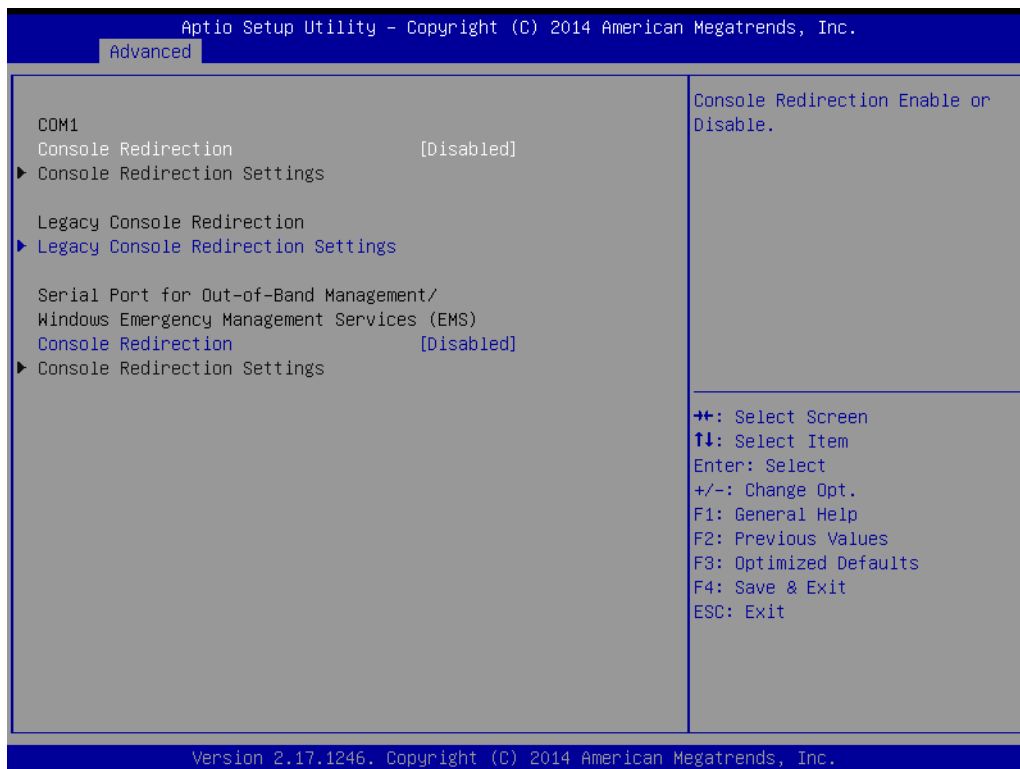

- **Console Redirection**

This item allows users to enable or disable console redirection.

### 3.2.2.5 CPU Configuration

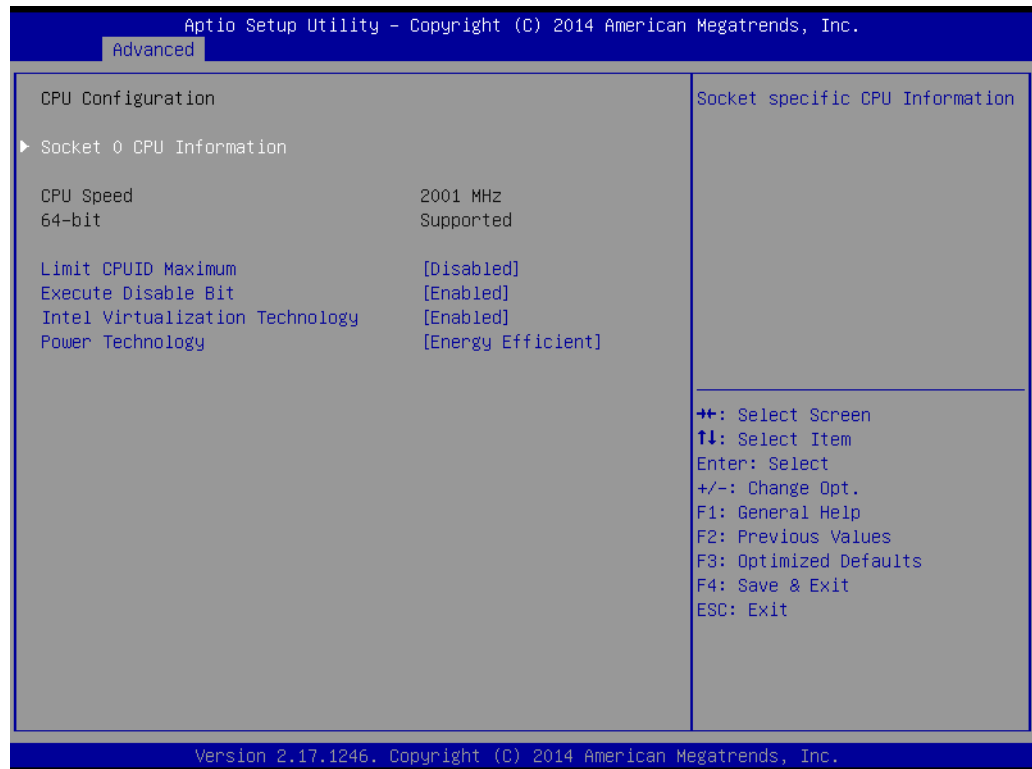

- **Limit CPUID Maximum**

This item allows users to enable or disable the ability to limit the CPUID maximum.

- **Execute Disable Bit**

This item allows users to enable or disable the Execute Disable Bit function.

- **Intel Virtualization Technology**

This item allows users to enable or disable Intel® Virtualization Technology.

- **Power Technology**

Enable the power management features.

This page shows the CPU information.

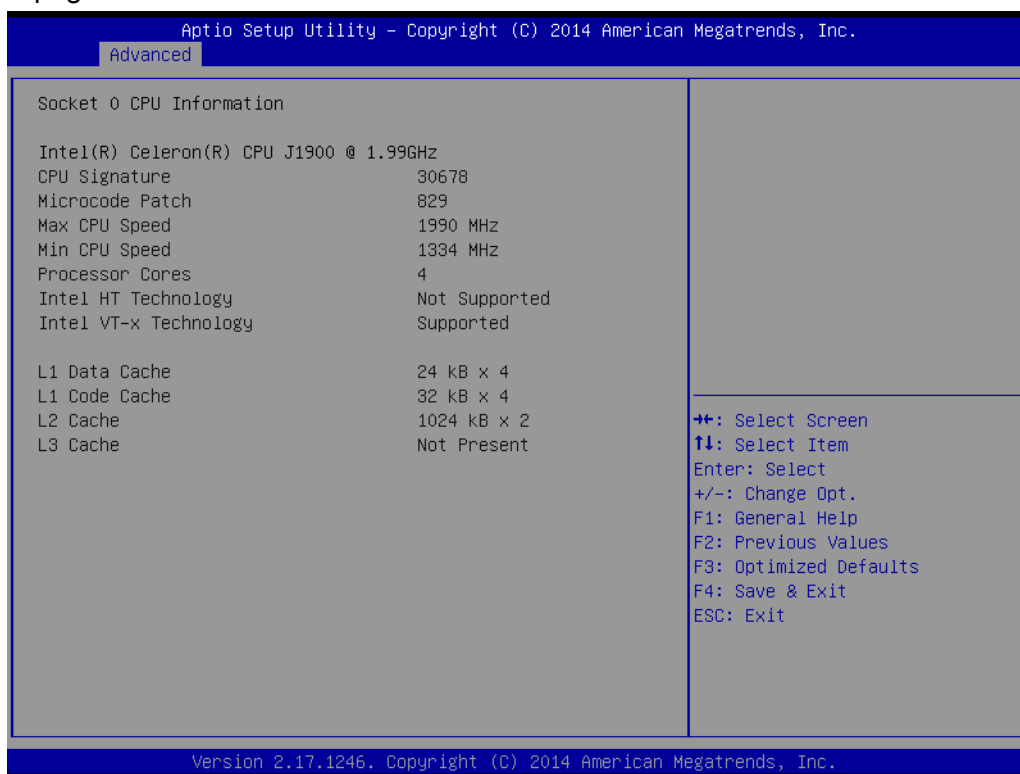

### 3.2.2.6 PPM Configuration

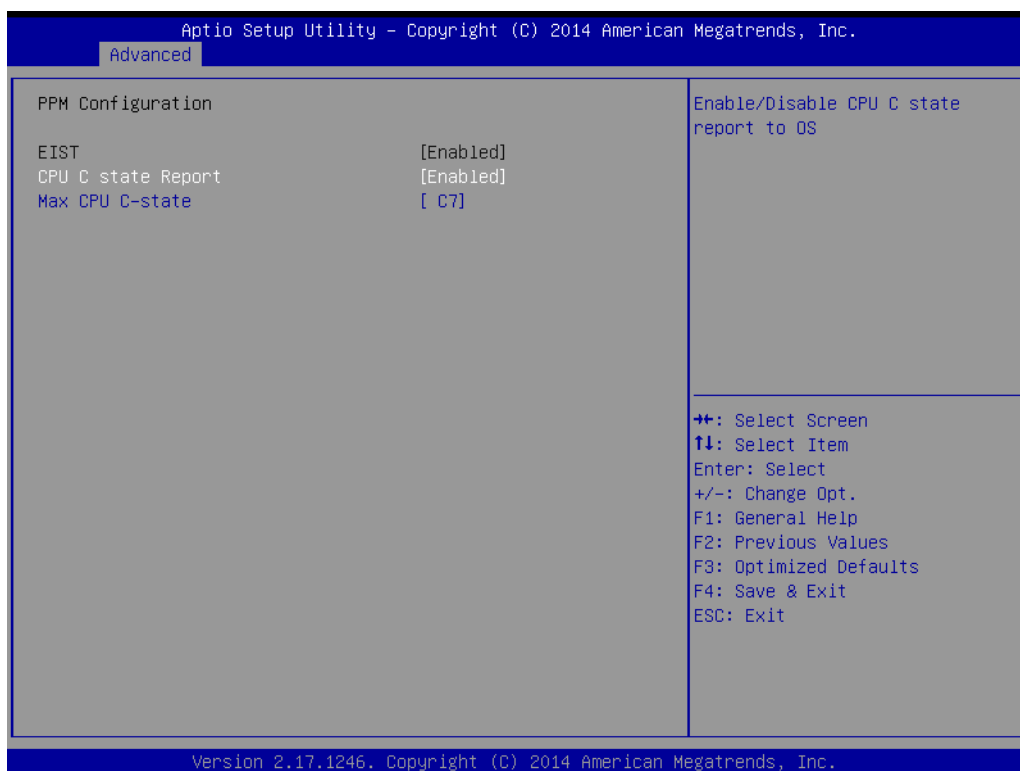

- **EIST**  
To enable or disable Intel SpeedStep.
- **CPU C state Report**  
To enable or disable CPU C state report to OS.

- **Max CPU C-state**  
This option controls Max C state that the processor will support.

### 3.2.2.7 IDE Configuration

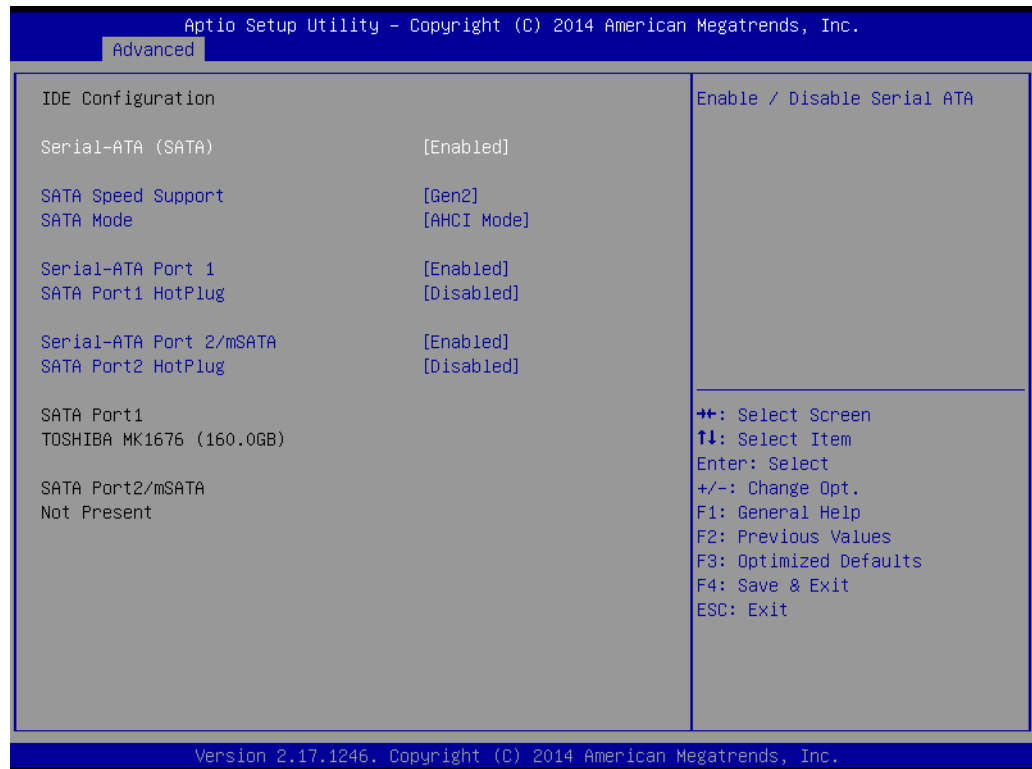

- **Serial-ATA (SATA)**  
This item allows users to enable or disable the SATA device.
- **SATA Speed Support**  
This item allows users to select the SATA speed (Gen1 or Gen2).
- **SATA ODD Port**  
This item allows users to set Port 1 or 2 to have ODD functionality.
- **SATA Mode**  
This item allows users to select the mode for SATA controller(s).
- **Serial-ATA Port 1**  
This item allows users to enable or disable the Serial-ATA Port 1 device.
- **SATA Port 1 Hot Plug**  
This item allows users to enable or disable the SATA Port 1 hot plug.
- **Serial-ATA Port 2**  
This item allows users to enable or disable the Serial-ATA Port 2 / mSATA device.
- **SATA Port 2 Hot Plug**  
This item allows users to enable or disable the SATA Port 2 hot plug.

### 3.2.2.8 Miscellaneous Configuration



- **High Precision Timer**  
This item allows users to enable or disable the high-precision timer.
- **PCI Express Dynamic Clock Gating**  
This item allows users to enable or disable the PCI Express Dynamic Clock Gating function.
- **OS Selection**  
This item allows users to set the OS as Windows 7 or Windows 8.x.

### 3.2.2.9 Compatibility Support Module Configuration

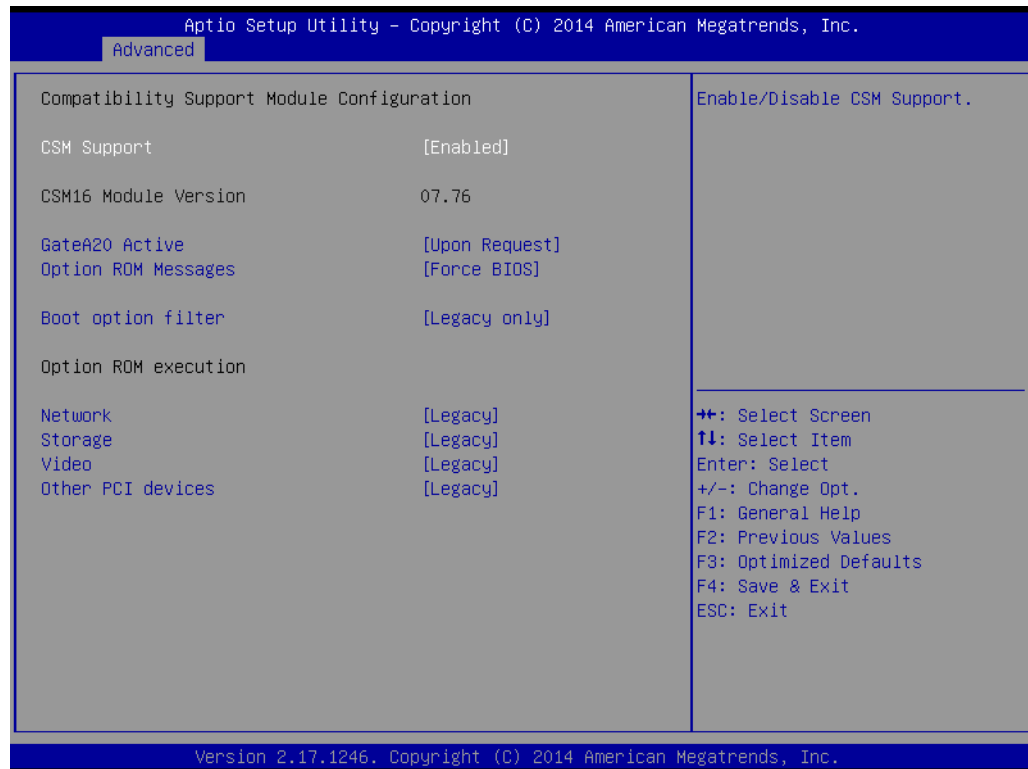

- **CSM Support**  
This item allows users to enable or disable CSM support.
- **GateA20 Active**  
Upon request - GA20 can be disabled using BIOS services. Never allow disabling of GA20; this option is useful when any RT code is executed above 1MB.
- **Option ROM Messages**  
This item allows users to set the display mode for Option ROM.
- **INT19 Trap Response**  
This item allows users to set the BIOS reaction to INT19 trapping by Option ROM: "Immediate" - execute the trap right away; "postponed" - execute the trap during legacy boot.
- **Boot Options Filter**  
This item allows users to control the Legacy/UEFI ROM priority.
- **Option ROM Execution**
  - **Network**  
Controls the execution of UEFI and Legacy PXE OpROM.
  - **Storage**  
Controls the execution of UEFI and Legacy Storage OpROM.
  - **Video**  
Controls the execution of UEFI and Legacy Video OpROM.
  - **Other PCI devices**  
Determines the OpROM execution policy for devices other than network, storage, and/or video devices.



### 3.2.2.10 USB Configuration

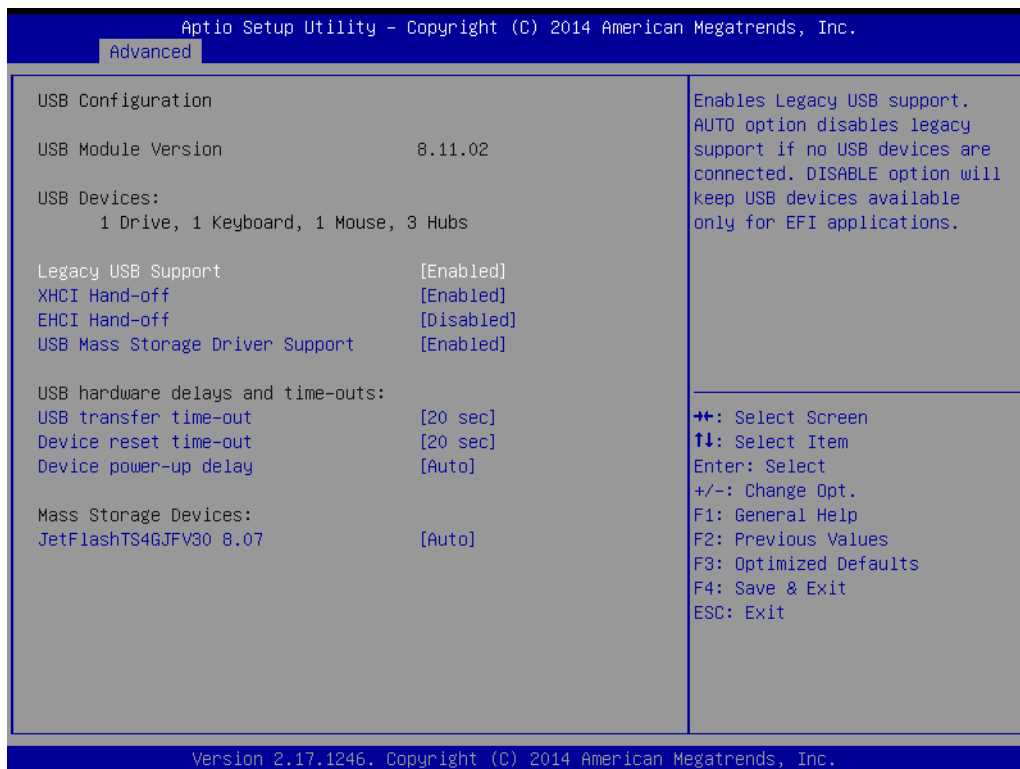

- **Legacy USB support**  
This item allows users to enable or disable support for legacy USB. The “Auto” option disables legacy support if no USB devices are connected.
- **XHCI Hands Off**  
This is a workaround for OS without XHCI hands-off support. The change in XHCI ownership should be claimed by the XHCI driver.
- **EHCI Hands Off**  
This is a workaround for OS without EHCI hands-off support. The change in EHCI ownership should be claimed by the EHCI driver.
- **USB Mass Storage Driver Support**  
This item allows users to enable or disable the USB mass storage driver.
- **USB Transfer Timeouts**  
This item allows users to determine the timeout values for control, bulk, and interrupt transfers.
- **Device Reset Timeout**  
This item allows users to set the USB mass storage device unit command time-out value.
- **Device Power-up Delay**  
Maximum time before the device issues a self-report to the host controller.
- **Mass Storage Device**  
This item allows users to determine the mass storage device emulation type. The “Auto” option enumerates devices according to their media format. Optical drives are emulated as CDROMs, and drives with no media are emulated according to the drive type.

**Note!** When the selected OS is Windows 7, users must install a USB 3.0 XHCI driver.



### 3.2.2.11 Intel® TXE and Anti-Theft Technology Configuration

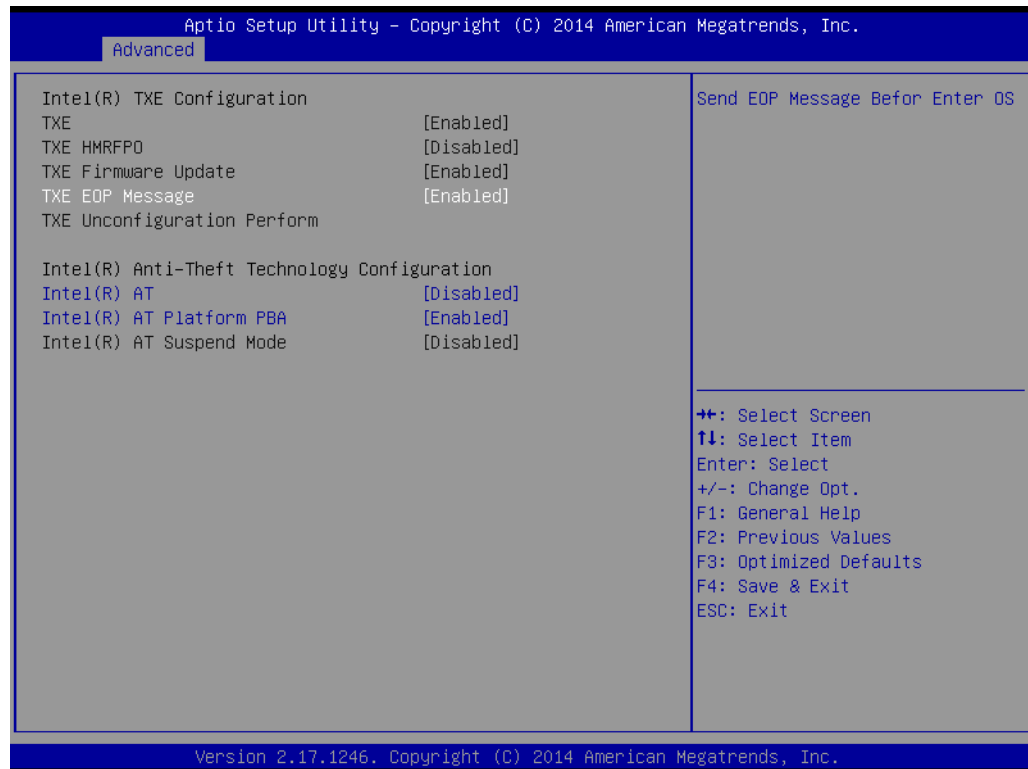

- **TXE**  
This item allows users to enable or disable TXE.
- **TXE HMRFPD**  
This item allows users to enable or disable TXE HMRFPD.
- **TXE Firmware Update**  
This item allows users to enable or disable TXE firmware updates.
- **TXE EOP Message**  
This item allows users to send EOP messages before entering the OS.
- **Intel® AT**  
This item allows users to enable or disable the BIOS AT code from running.
- **Intel® AT Platform PBA**  
This item allows users to enable or disable the BIOS AT code from running.
- **Enter Intel® AT Suspend Mode**  
This item allows users to request that a platform enter AT Suspend mode (this option is only available when AT enrolled).

### 3.2.3 Chipset

This page provides information of the chipset on ARK-6322.

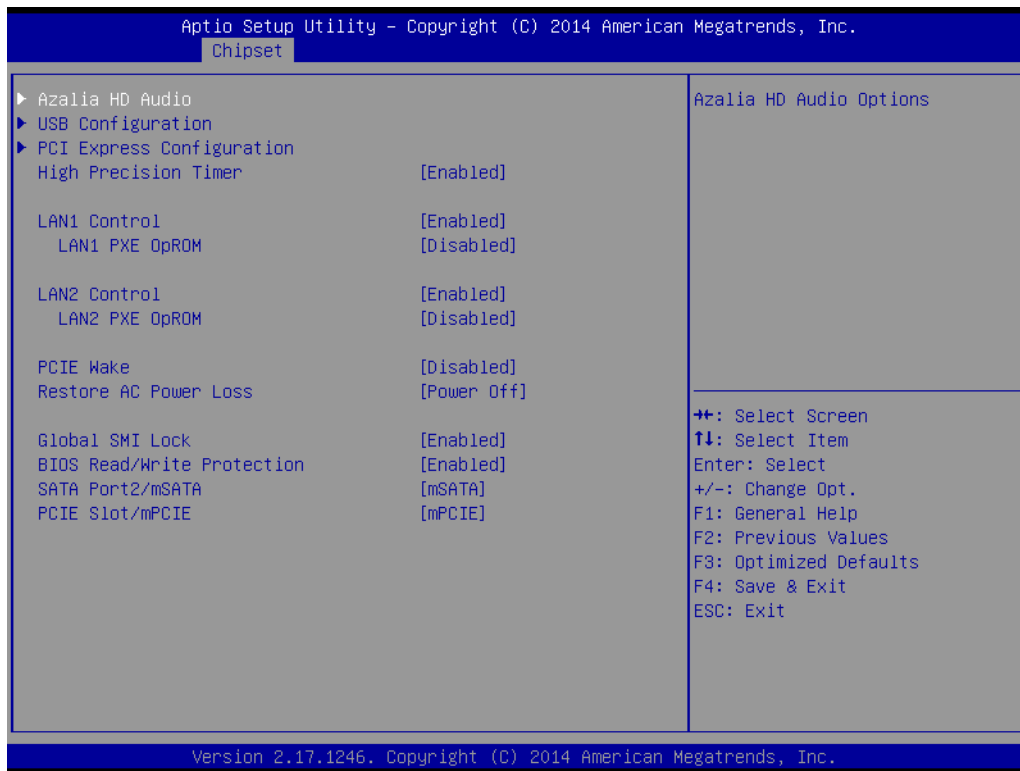

- **Azalia HD Audio**  
This item allows users to adjust the Azalia HD audio options.
- **USB Configuration**  
This item allows users to adjust the USB configuration.
- **PCI Express Configuration**  
This item allows users to adjust the PCI Express configuration.
- **High Precision Timer**  
This item allows users to enable or disable the high-precision timer.
- **LAN 1 controller**  
This item allows users to enable or disable the LAN 1 controller.
- **LAN 1 PXE OpROM**  
This item allows users to enable or disable the LAN 1 option-ROM.
- **LAN 2 controller**  
This item allows users to enable or disable the LAN 2 controller.
- **LAN 2 PXE OpROM**  
This item allows users to enable or disable the LAN 2 option-ROM.
- **PCle Wake**  
This item allows users to enable or disable the PCIe System Wakeup from S5 function.
- **Restore AC Power Loss**  
The configuration options for this item are “Off”, “On”, and “Last State”.
- **Global SMI Lock**  
This item allows users to enable or disable the Global SMI Lock function.
- **BIOS Read/Write Protection**  
This item allows users to enable or disable BIOS Read/Write Protection.

- **SATA Port 2/mSATA**  
This item allows users to specify SATA Port 2 or mSATA for use.
- **PCIe Slot/mPCIe**  
This item allows users to specify PCIe x1 Port or miniPCIe2 for use.

## LCD Control

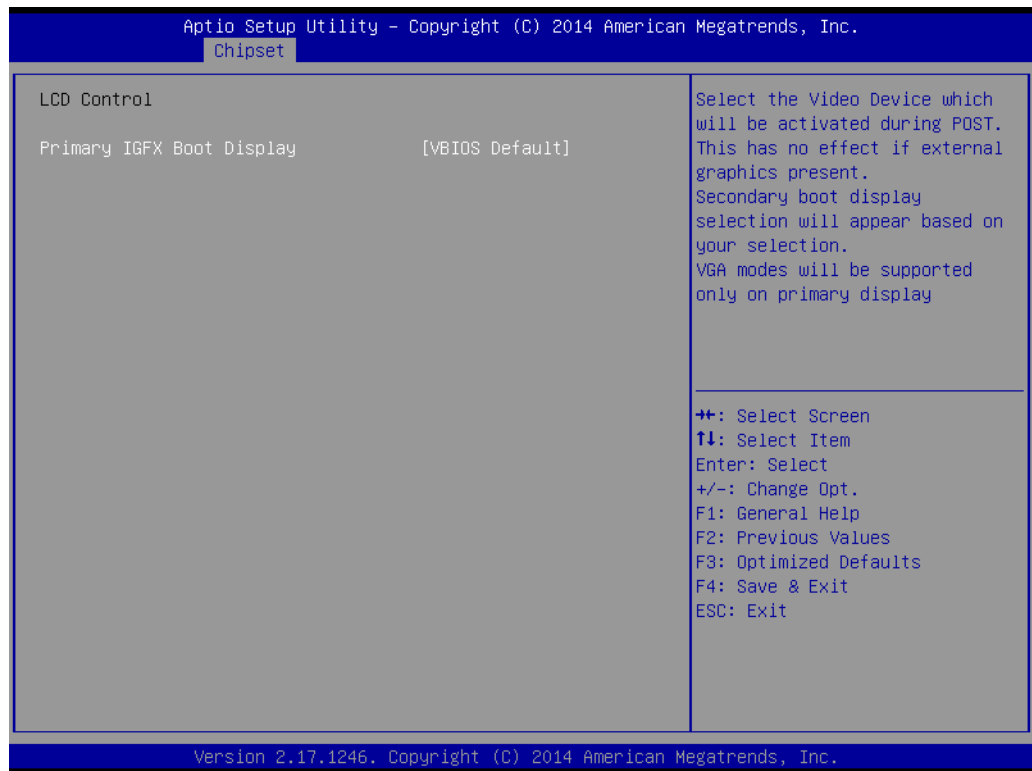

- **Primary IGFX Boot Display (VBIOS Default)**  
This item allows users to select the video device activated during POST. Secondary boot display options are presented according to users' selection.

## Audio Configuration



- **Audio Controller**  
This item allows users to enable or disable the audio controller.

## USB Configuration

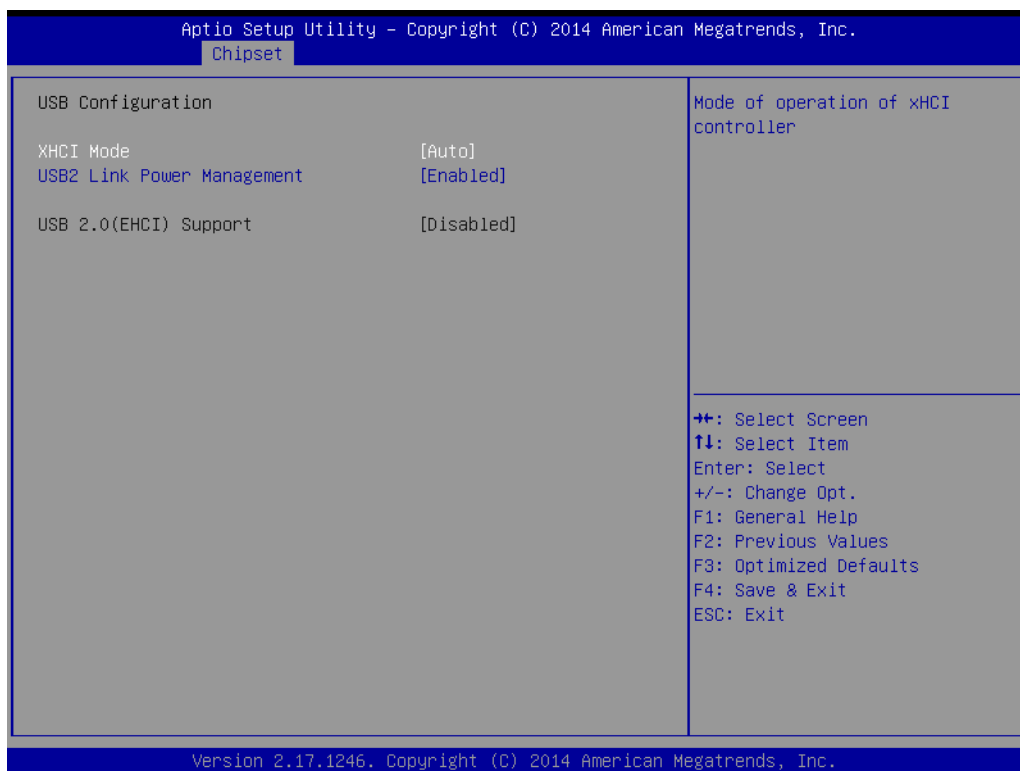

- **XHCI Mode**  
This item allows users to enable or disable XHCI mode.
- **USB2 Link Power Management**  
This item allows users to enable or disable USB2 link power management.
- **USB 2.0 (EHCI) Support**  
This item allows users to enable or disable USB 2.0 (EHCI) support.

**Note!** When the selected OS is Windows 7, users must install a USB 3.0 XHCI driver.



### 3.2.4 Security

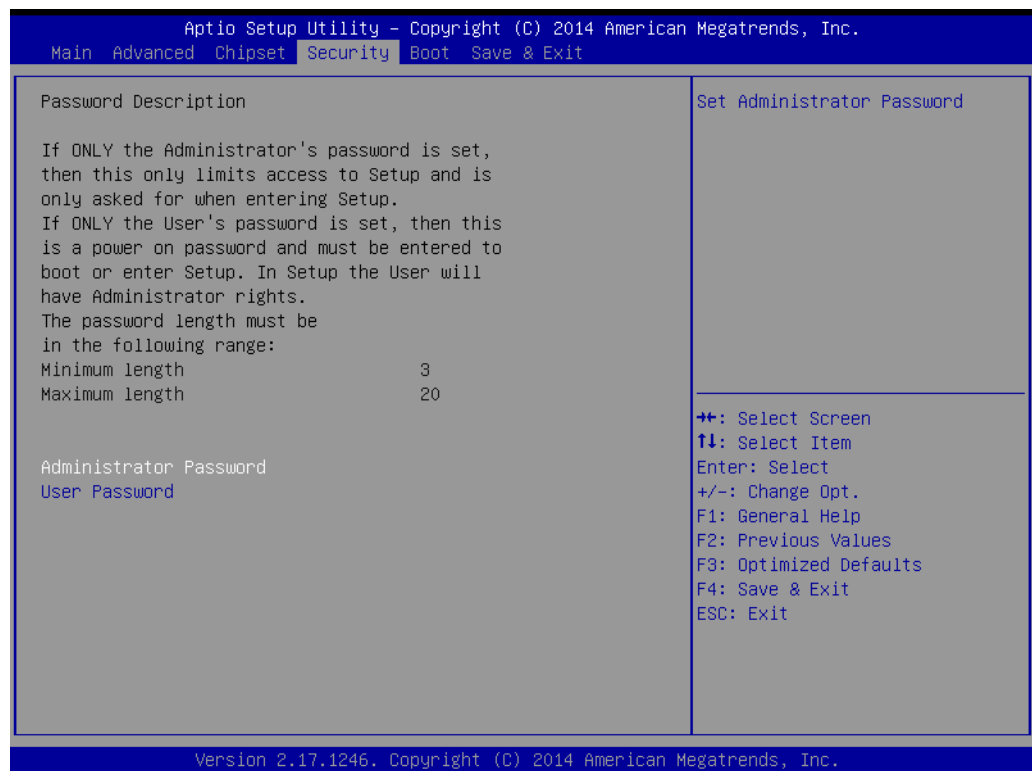

Select the Security tab from the ARK-6322 BIOS Setup Utility main setup menu. All Security options, such as password protection and virus protection, are described in this section. To access the submenus for the “Change Administrator” and “User Password” items, select the item and press <Enter>.

### 3.2.5 Boot

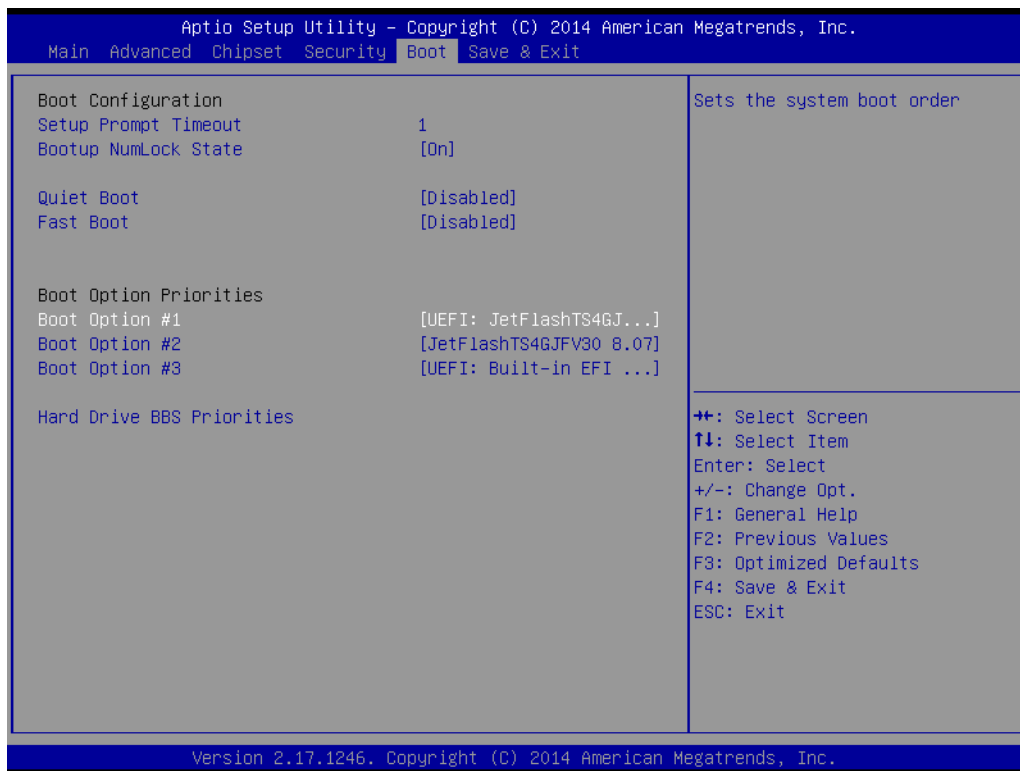

- **Setup Prompt Timeout**  
This item allows users to specify the number of seconds the system should wait for a setup activation key.
- **Bootup NumLock State**  
This item allows users to select the power-on state for Numlock.
- **Quiet Boot**  
If this item is set to “Disabled”, the BIOS displays standard POST messages. If set to “Enabled”, an OEM logo is shown instead of POST messages.
- **Fast Boot**  
This item allows users to enable or disable boot initialization with the minimum number of devices necessary to launch the active boot option. These settings have no effects for BBS boot options.
- **Boot Option Priorities**  
This item allows users to set the system boot order.

## 3.2.6 Save and Exit

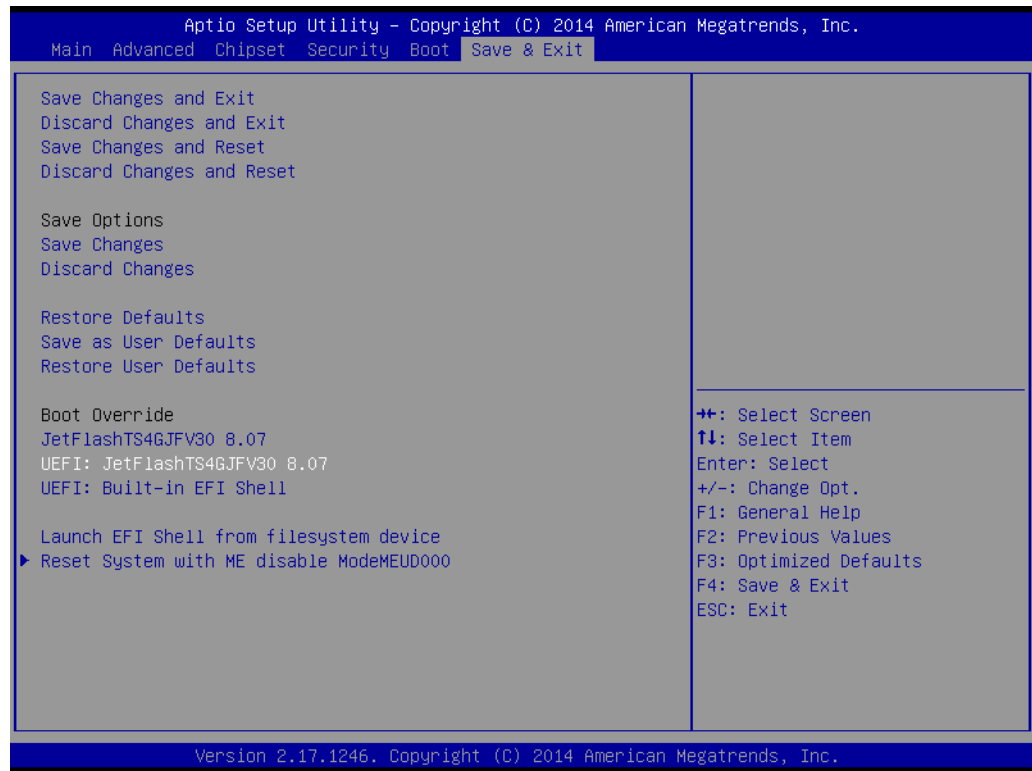

- **Save Changes and Exit**  
This item allows users to save changes and exit the system setup page.
- **Discard Changes and Exit**  
This item allows users to exit the system setup without saving changes.
- **Save Changes and Reset**  
This item allows users to reset the system setup after saving changes.
- **Discard Changes and Reset**  
This item allows users to reset the system setup without saving changes.
- **Save Changes**  
This item allows users to save changes to all options.
- **Discard Changes**  
This item allows users to discard changes to all options.
- **Restore Defaults**  
This item allows users to restore/load the default values for all options.
- **Save as User Defaults**  
This item allows users to save changes as user defaults.
- **Restore User Defaults**  
This item allows users to restore the user defaults for all options.
- **Boot Override**  
This item allows users to override boot priority with a selected boot device.
- **Launch EFI Shell From a Filesystem Device**  
This item allows users to launch an EFI Shell application (Shellx64.efi) from an available filesystem device.



# Appendix **A**

Programming the  
Watchdog Timer

---

## A.1 Programming the Watchdog Timer

The AIMB-215 B1 watchdog timer can be used to monitor system software operations and execute corrective actions if the software fails to function within the programmed period. The operations and procedures for programming the watchdog timer are described in this section.

### A.1.1 Watchdog Timer Overview

The watchdog timer is built into the NCT6106D super I/O controller, and facilitates the following user-programmable functions:

- Can be enabled and disabled via a user program
- The timer interval can be set as 1 to 255 seconds or 1 to 255 minutes
- Generates an interrupt or reset signal if the software fails to reset the timer before timeout

### A.1.2 Programming the Watchdog Timer

The I/O port base addresses for the watchdog timer are 2E (hex) and 2F (hex), where 2E (hex) is the address port, and 2F (hex) is the data port. Users must first assign register addresses by inputting an address value into address port 2E (hex) before writing/reading data to/from the assigned register through data port 2F (hex).

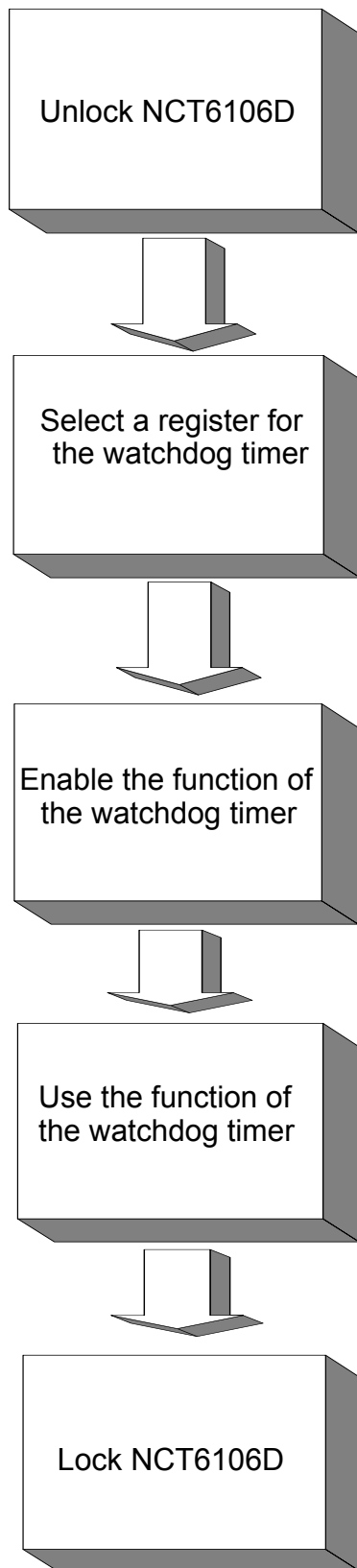

**Table A.1: Watchdog Timer Registers**

<b>Register Address (2E)</b>	<b>Attribute</b>	
Read/Write	Value (2F) and description	
87 (hex)	-----	Write this address to I/O address port 2E (hex) twice to unlock NCT6106D.
07 (hex)	write	Write 08 (hex) to the selected watchdog timer register.
30 (hex)	write	Write 01 (hex) to enable the function of the watchdog timer. The default setting is "Disabled".
F0 (hex)	write	Set the timer unit as seconds or minutes. Write 0 to bit 3: set the unit of measurement as seconds (default). Write 1 to bit 3: set the unit of measurement as minutes.
F1 (hex)	write	0: stop timer (default) 01~FF (hex): The timer value, in seconds or minutes, depends on the value set in Register F5 (hex). This value determines how long the watchdog timer waits for the strobe before generating an interrupt or reset signal. Writing a new value to this register resets the timer to count using the new value.
F2 (hex)	read/write	Bit 7: Write 1 to enable the mouse to reset the timer, or 0 to disable this function (default). Bit 6: Write 1 to enable the keyboard to reset the timer, or 0 to disable this function (default). Bit 5: Write 1 to immediately generate a timeout signal before automatically returning to 0 (default = 0). Bit 4: Read the watchdog timer status, 1 means the timer has reach timeout.
AA (hex)	-----	Write this address to I/O port 2E (hex) to lock the watchdog timer.

### A.1.3 Example Program

1. Enable the watchdog timer and set the timeout interval as 10 seconds

```

;-----
Mov dx,2eh; unlock NCT6106D
Mov al,87h
Out dx,al
Out dx,al
;-----
Mov al,07h; select the watchdog timer registers
Out dx,al
Inc dx
Mov al,08h
Out dx,al
;-----
Dec dx; enable the watchdog timer function
Mov al,30h
Out dx,al
Inc dx
Mov al,01h
Out dx,al
;-----
Dec dx; set the unit of measurement as seconds
Mov al,0f0h
Out dx,al
Inc dx
In al,dx
And al,not 08h
Out dx,al
;-----
Dec dx; set the timeout interval as 10 seconds and start counting
Mov al,0f1h
Out dx,al
Inc dx
Mov al,10
Out dx,al
;-----
Dec dx; lock NCT6106D
Mov al,0aah
Out dx,al

```

2. Enable the watchdog timer and set the timeout interval as 5 minutes

```

;-----
Mov dx,2eh; unlock NCT6106D
Mov al,87h
Out dx,al
Out dx,al

```

```

;-----
Mov al,07h; select the watchdog timer registers
Out dx,al
Inc dx
Mov al,08h
Out dx,al
;-----
Dec dx; enable the watchdog timer function
Mov al,30h
Out dx,al
Inc dx
Mov al,01h
Out dx,al
;-----
Dec dx; set the unit of measurement as minutes
Mov al,0f0h
Out dx,al
Inc dx
In al,dx
Or al,08h
Out dx,al
;-----
Dec dx; set the timeout interval as 5 minutes and start counting
Mov al,0f1h
Out dx,al
Inc dx
Mov al,5
Out dx,al
;-----
Dec dx; lock NCT6106D
Mov al,0aah
Out dx,al
3. Enable the watchdog timer to be reset using a mouse
;-----
Mov dx,2eh; unlock NCT6106D
Mov al,87h
Out dx,al
Out dx,al
;-----
Mov al,07h; select the watchdog timer registers
Out dx,al
Inc dx
Mov al,08h
Out dx,al
;-----

```

```

Dec dx; enable the watchdog timer function
Mov al,30h
Out dx,al
Inc dx
Mov al,01h
Out dx,al
;-----
Dec dx; enable the watchdog timer to be reset using a mouse
Mov al,0f2h
Out dx,al
Inc dx
In al,dx
Or al,80h
Out dx,al
;-----
Dec dx; lock NCT6106D
Mov al,0aah
Out dx,al
4. Enable the watchdog timer to be reset using a keyboard
;-----
Mov dx,2eh; unlock NCT6106D
Mov al,87h
Out dx,al
Out dx,al
;-----
Mov al,07h; select the watchdog timer registers
Out dx,al
Inc dx
Mov al,08h
Out dx,al
;-----
Dec dx; enable the watchdog timer function
Mov al,30h
Out dx,al
Inc dx
Mov al,01h
Out dx,al
;-----
Dec dx; enable the watchdog timer to be strobed reset using a keyboard
Mov al,0f2h
Out dx,al
Inc dx
In al,dx
Or al,40h
Out dx,al

```

```

;-----
Dec dx; lock NCT6106D
Mov al,0aah
Out dx,al
5. Generate a timeout signal without the timer counting
;-----
Mov dx,2eh; unlock NCT6106D
Mov al,87h
Out dx,al
Out dx,al
;-----
Mov al,07h; select the watchdog timer registers
Out dx,al
Inc dx
Mov al,08h
Out dx,al
;-----
Dec dx; enable the watchdog timer function
Mov al,30h
Out dx,al
Inc dx
Mov al,01h
Out dx,al
;-----
Dec dx; generate a timeout signal
Mov al,0f2h
Out dx,al; write 1 to Bit 5 of Register F7
Inc dx
In al,dx
Or al,20h
Out dx,al
;-----
Dec dx; lock NCT6106D
Mov al,0aah
Out dx,al

```



**ADVANTECH**

*Enabling an Intelligent Planet*

**[www.advantech.com](http://www.advantech.com)**

Please verify specifications before quoting. This guide is intended for reference purpOS only.

All product specifications are subject to change without notice.

No part of this publication may be reproduced in any form or by any means, electronic, photocopying, recording or otherwise, without prior written permission of the publisher.

All brand and product names are trademarks or registered trademarks of their respective companies.

© Advantech Co., Ltd. 2015