

SECTION A-A
(WITH CAP)

SECTION A-A
(WITHOUT CAP)

NOTES:

- MATERIAL:
HOUSING: NYLON, GLASS FILLED, UL94 V-0,
COLOR - SEE TABLE.
CAP: NYLON, GLASS FILLED, UL94V-0
COLOR: BEIGE.
PINS: BRASS ALLOY, C26000, P/N87437-8083.
- PLATING: 2.54µM. MIN. TIN OVER 1.27µM MIN. NICKEL.
- DRAWING SHOWS PLUG WITH 5 CIRCUITS.
- HEADER TO BE USED WITH CRIMP HOUSING, P/N 87439
AND CRIMP TERMINAL, P/N 87421.
- PARTS TO BE PACKED IN MOISTURE BAG.

ADD MOIST BAG NOTE EC NO: S2007-1049 DRWNS:KANG CHKD:ATSEE APPR:MLONG	2007/06/22 2007/06/22 2007/06/22	DESCRIPTION D7	QUALITY SYMBOLS	GENERAL TOLERANCES (UNLESS SPECIFIED)	DIMENSION STYLE	SCALE	DESIGN UNITS	THIRD ANGLE PROJECTION
			$\nabla=0$ $\sphericalangle=0$	mm INCH 4 PLACES ± --- ± --- 3 PLACES ± --- ± --- 2 PLACES ± 0.20 ± --- 1 PLACE ± --- ± --- ANGULAR ± 3°	MM ONLY	NTS	METRIC	
				DRAWN BY: KCLING DATE: 1994/04/08 CHECKED BY: SKTOH DATE: 1994/04/21 APPROVED BY: RWONG DATE: 1994/04/21	TITLE	1.50MM PITCH, W-T-B HEADER, VERTICAL, SMT		
			DRAFT WHERE APPLICABLE MUST REMAIN WITHIN DIMENSIONS	SEE TABLE	MATERIAL NO. DOCUMENT NO.	MOLEX INCORPORATED SD-87437-***31	SHEET NO. 1 OF 4	

10 9 8 7 6 5 4 3 2 1



CIRCUIT SIZE	A	B	C	D	E
02	1.50	3.30	3.70	4.30	1.70
03	3.00	4.80	5.20	5.80	3.20
04	4.50	6.30	6.70	7.30	4.70
05	6.00	7.80	8.20	8.80	6.20
06	7.50	9.30	9.70	10.30	7.70
07	9.00	10.80	11.20	11.80	9.20
08	10.50	12.30	12.70	13.30	10.70
09	12.00	13.80	14.20	14.80	12.20
10	13.50	15.30	15.70	16.30	13.70
11	15.00	16.80	17.20	17.80	15.20
12	16.50	18.30	18.70	19.30	16.70
13	18.00	19.80	20.20	20.80	18.20
14	19.50	21.30	21.70	22.30	19.70
15	21.00	22.80	23.20	23.80	21.20

PART NUMBER ASSIGNMENT

87437-XXXX

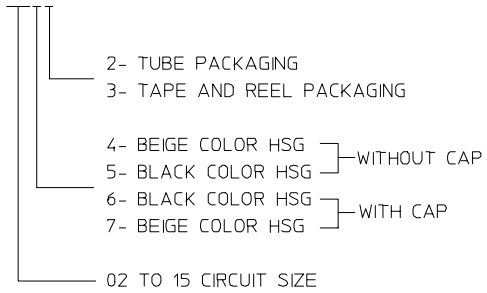

F
E
D
C
B
A

F
E
D
C
B
A

ADD MOIST BAG NOTE EC NO: S2007-1049 DRWN:SKANG CHKD:ATSEE APPR:MLONG	2007/06/22 2007/06/22 2007/06/22	DESCRIPTION REV	QUALITY SYMBOLS ▽=0 ▽=0	GENERAL TOLERANCES (UNLESS SPECIFIED) <table border="1"> <thead> <tr> <th></th> <th>mm</th> <th>INCH</th> </tr> </thead> <tbody> <tr><td>4 PLACES</td><td>± ---</td><td>± ---</td></tr> <tr><td>3 PLACES</td><td>± ---</td><td>± ---</td></tr> <tr><td>2 PLACES</td><td>± 0.20</td><td>± ---</td></tr> <tr><td>1 PLACE</td><td>± ---</td><td>± ---</td></tr> </tbody> </table> ANGULAR ± 3 °		mm	INCH	4 PLACES	± ---	± ---	3 PLACES	± ---	± ---	2 PLACES	± 0.20	± ---	1 PLACE	± ---	± ---	DIMENSION STYLE MM ONLY DRAWN BY DATE KCL ING 1994/04/08 CHECKED BY DATE SKTOH 1994/04/21 APPROVED BY DATE RWONG 1994/04/21	SCALE NTS DESIGN UNITS METRIC THIRD ANGLE PROJECTION	TITLE 1.50MM PITCH, W-T-B HEADER, VERTICAL, SMT
				mm	INCH																	
			4 PLACES	± ---	± ---																	
			3 PLACES	± ---	± ---																	
2 PLACES	± 0.20	± ---																				
1 PLACE	± ---	± ---																				
DRAFT WHERE APPLICABLE MUST REMAIN WITHIN DIMENSIONS		MATERIAL NO. SEE TABLE	DOCUMENT NO. SD-87437-**31	SHEET NO. 2 OF 4																		
SIZE A3		THIS DRAWING CONTAINS INFORMATION THAT IS PROPRIETARY TO MOLEX INCORPORATED AND SHOULD NOT BE USED WITHOUT WRITTEN PERMISSION																				
D7																						

9 8 7 6 5 4 3 2 1

10 9 8 7 6 5 4 3 2 1

EMBOSSED CARRIER TAPE PACKING DETAILS FOR PARTS WITHOUT CAP

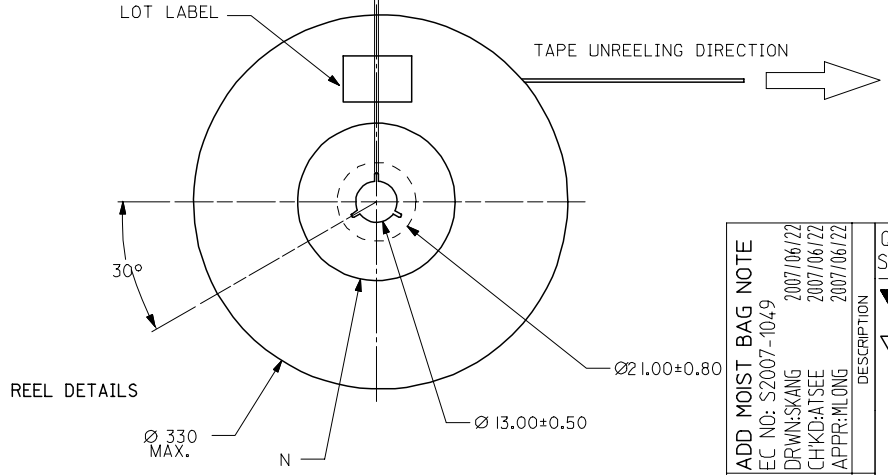
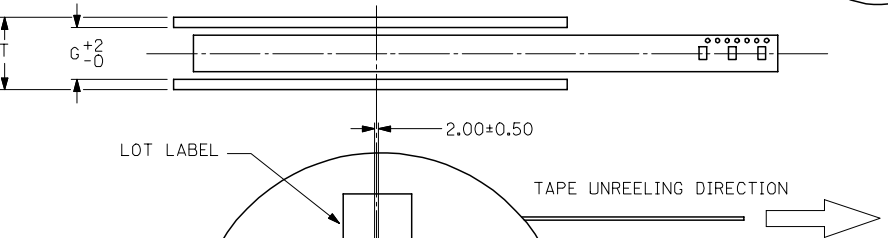
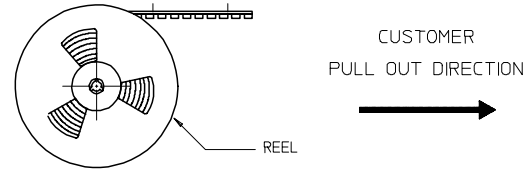
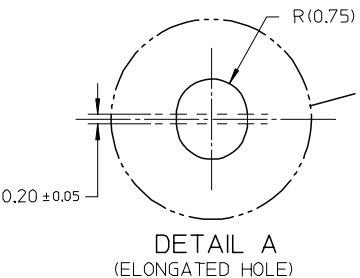

ADD MOIST BAG NOTE	DESCRIPTION
EC NO: S2007-1049	REV
DRWN:SKANG	D7
CHKD:ATSEE	
APPR:MLONG	
2007/06/22	
2007/06/22	
2007/06/22	

QUALITY SYMBOLS	$\nabla=0$
	$\sphericalangle=0$
GENERAL TOLERANCES (UNLESS SPECIFIED)	mm
	INCH
4 PLACES	\pm ---
3 PLACES	\pm ---
2 PLACES	± 0.20
1 PLACE	\pm ---
ANGULAR $\pm 3^\circ$	
DRAFT WHERE APPLICABLE MUST REMAIN WITHIN DIMENSIONS	

DIMENSION STYLE		SCALE	DESIGN UNITS	THIRD ANGLE PROJECTION
MM ONLY		NTS	METRIC	$\odot \square$
DRAWN BY	DATE	TITLE		
KCLING	1994/04/08	1.50MM PITCH, W-T-B HEADER, VERTICAL, SMT		
CHECKED BY	DATE	MOLEX INCORPORATED		
SKTOH	1994/04/21			
APPROVED BY	DATE	DOCUMENT NO.		
RWONG	1994/04/21	SD-87437-***31		
MATERIAL NO.		SEE TABLE		SHEET NO.
				3 OF 4
THIS DRAWING CONTAINS INFORMATION THAT IS PROPRIETARY TO MOLEX INCORPORATED AND SHOULD NOT BE USED WITHOUT WRITTEN PERMISSION				

9 8 7 6 5 4 3 2 1

EMBOSSED CARRIER TAPE PACKING DETAILS FOR PARTS WITH CAP

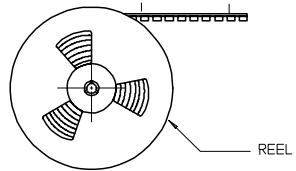
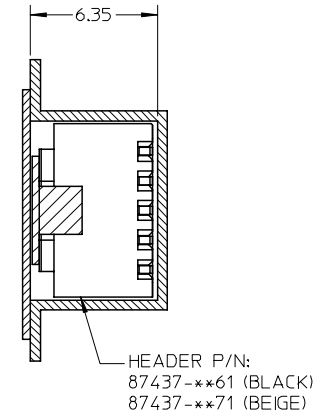
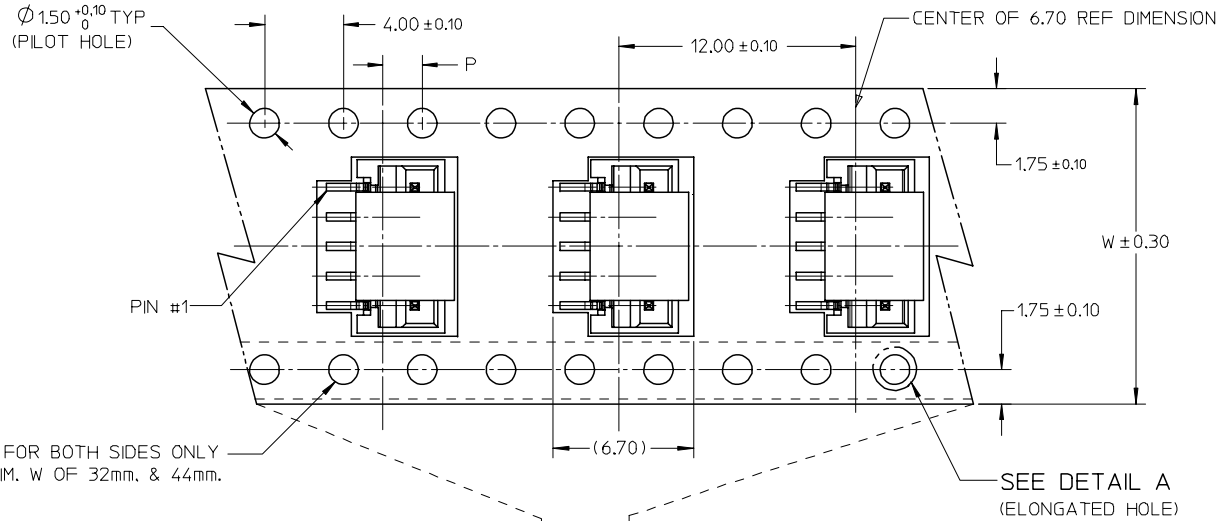

NOTES:

1. LEADER AND TRAILER TAPE

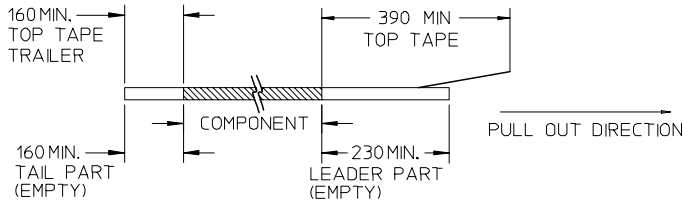

2. PEELING OFF FORCE OF THE TOP TAPE: 20-80gf. (PEELING DIRECTION AS SHOWN IN FOLLOWING FIGURE)

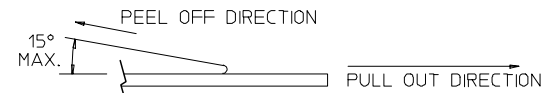

- 3. THE TAPE IS TREATED FOR ANTI-STATIC.
- 4. PACKAGING STANDARD IS AS PER EIA-481.
- 5. TAPE & REEL QUANTITY = 1000PCS/REEL (WITHOUT CAP)
TAPE & REEL QUANTITY = 900PCS/REEL (WITH CAP)

15	44	20.20±0.15	100	44.40	50.40	2.00±0.15
11, 12, 13, 14	32	14.20±0.10	100	32.40	38.40	2.00±0.10
7, 8, 9, 10	24	11.50±0.10	100	24.40	30.40	2.00±0.10
2, 3, 4, 5, 6	16	7.50±0.10	100	16.40	22.40	2.00±0.10
CIRCUIT SIZE	W	F	N	G	T MAX	P

ADD MOIST BAG NOTE EC NO: S2007-1049 DRWNS:KANG CHKD:ATSEE APPR:MLONG	2007/06/22 2007/06/22 2007/06/22	QUALITY SYMBOLS ▽=0 ▽=0	GENERAL TOLERANCES (UNLESS SPECIFIED)		DIMENSION STYLE MM ONLY		SCALE NTS	DESIGN UNITS METRIC	THIRD ANGLE PROJECTION	
					DRAWN BY KCLING		DATE 1994/04/08	TITLE 1.50MM PITCH, W-T-B HEADER, VERTICAL, SMT		
					CHECKED BY SKTOH		DATE 1994/04/21	APPROVED BY RWONG		
					APPROVED BY RWONG		DATE 1994/04/21	MATERIAL NO. SEE TABLE		
DRAFT WHERE APPLICABLE MUST REMAIN WITHIN DIMENSIONS			SIZE A3		DOCUMENT NO. SD-87437-**-31			SHEET NO. 4 OF 4		