

Low IR "E Series"

●Surface-Mount

V _{RM} (V)	I _F (AV) (A)	Package Axial (Body Diameter/Lead Diameter)	Part Number	I _{FSM} (A)	T _j (°C)	T _{stg} (°C)	V _F (V) max	I _F (A)	I _R (mA)	I _{R(H)} (mA)	T _j (°C)	R _{th(j-l)} R _{th(j-c)} (°C/W)	Mass (g)
				50Hz Single Half Sine Wave					V _{R=V_{RM}} max	V _{R=V_{RM}} max			
30	2.0	Surface-Mount (SJP)	SJPE-H3*	40	-40 to +150		0.55	2.0	0.2	70	150(Ta)	20	0.072
40	2.0	Surface-Mount (SJP)	SJPE-H4	40	-40 to +150		0.6	2.0	0.05	20	150	20	0.072

*Under development

●Thru-Hole

V _{RM} (V)	I _F (AV) (A)	Package	Part Number	I _{FSM} (A)	T _j (°C)	T _{stg} (°C)	V _F (V) max	I _F (A)	I _R (mA)	I _{R(H)} (mA)	T _j (°C)	R _{th(j-l)} R _{th(j-c)} (°C/W)	Mass (g)
				50Hz Single Half Sine Wave					V _{R=V_{RM}} max	V _{R=V_{RM}} max			
80	20	TO-220F(Center-tap)	FMEN-2208	120	-40 to +150		0.76	10	0.2	100	150	4.0	2.1
	30	TO-220F(Center-tap)	FMEN-2308	150	-40 to +150		0.765	15	0.3	150	150	4.0	2.1
100	10	TO-220F(Center-tap)	FMEN-210A	100	-40 to +150		0.85	5.0	0.1	50	150	4.0	2.1
	15	TO-220F(Center-tap)	FMEN-215A*	100	-40 to +150		0.85	7.5	0.15	75	150	4.0	2.1
	20	TO-220F(Center-tap)	FMEN-220A	120	-40 to +150		0.85	10	0.2	100	150	4.0	2.1
	20	TO-3PF(Center-tap)	FMEN-420A	120	-40 to +150		0.85	10	0.2	100	150	2.0	6.5
	30	TO-220F(Center-tap)	FMEN-230A	150	-40 to +150		0.85	15	0.3	150	150	4.0	2.1
	30	TO-262	MPEN-230AF	150	-40 to +150		0.90	15	0.25	125	150	1.5	1.55
	30	TO-3PF(Center-tap)	FMEN-430A	150	-40 to +150		0.85	15	0.3	150	150	2.0	6.5
150	10	TO-220F(Center-tap)	FMEN-210B	100	-40 to +150		0.92	5.0	0.1	25	150	4.0	2.1
	20	TO-220F(Center-tap)	FMEN-220B	120	-40 to +150		0.92	10	0.2	50	150	4.0	2.1
	20	TO-3PF(Center-tap)	FMEN-420B	120	-40 to +150		0.85	10	0.2	100	150	2.0	6.5
	30	TO-220F(Center-tap)	FMEN-230B	150	-40 to +150		0.92	15	0.3	75	150(Ta)	4.0	2.1

*Under development

Low V_F/Low I_R Balance "J Series"

●Surface-Mount

V _{RM} (V)	I _F (AV) (A)	Package	Part Number	I _{FSM} (A)	T _j (°C)	T _{stg} (°C)	V _F (V) max	I _F (A)	I _R (mA)	I _{R(H)} (mA)	T _j (°C)	R _{th(j-l)} R _{th(j-c)} (°C/W)	Mass (g)
				50Hz Single Half Sine Wave					V _{R=V_{RM}} max	V _{R=V_{RM}} max			
30	1.0	Surface-Mount (SJP)	SJPJ-D3	30	-40 to +150		0.45	1.0	0.1	35	150	20	0.072
	2.0	Surface-Mount (SJP)	SJPJ-H3*	50	-40 to +150		0.45	2.0	0.2	70	150	20	0.072
	3.0	Surface-Mount (SJP)	SJPJ-L3	60	-40 to +150		0.45	3.0	0.3	150	150	20	0.072

*Under development

●Thru-Hole

V _{RM} (V)	I _F (AV) (A)	Package Axial (Body Diameter/Lead Diameter)	Part Number	I _{FSM} (A)	T _j (°C)	T _{stg} (°C)	V _F (V) max	I _F (A)	I _R (mA)	I _{R(H)} (mA)	T _j (°C)	R _{th(j-l)} R _{th(j-c)} (°C/W)	Mass (g)
				50Hz Single Half Sine Wave					V _{R=V_{RM}} max	V _{R=V_{RM}} max			
30	3.0	Axial(φ6.5/φ1.4)	RJ 43	50	-40 to +150		0.45	3.0	3.0	100	150	8.0	1.2
	10	TO-220F(Center-tap)	FMJ-23L	100	-40 to +150		0.45	5.0	5.0	175	150(Ta)	4.0	2.1
	30	TO-220F(Center-tap)	FMJ-2303	150	-40 to +150		0.48	15	15	500	150	4.0	2.1

Package Type (Dimensions)

• No. 1 Surface-Mount (SJP)

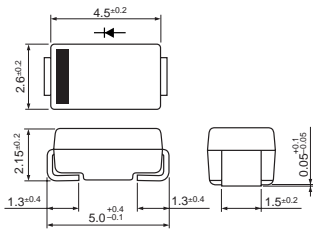

• No. 2 Surface-Mount (D pack)

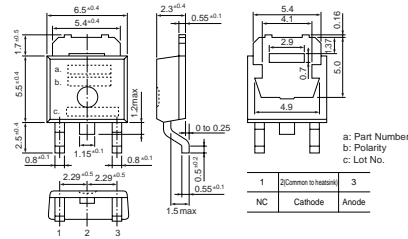

• No. 3 Surface-Mount (D pack) Center-tap

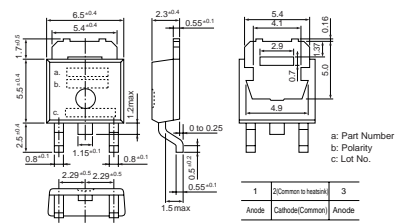

• No. 4 Surface-Mount (TO263)

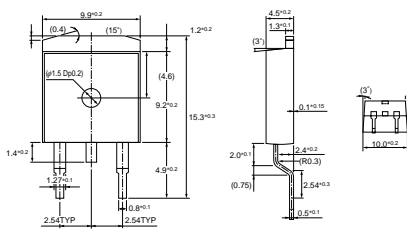

• No. 5 Surface-Mount (TO220S)
MPL-102S, MP2-202S, MPL-1036

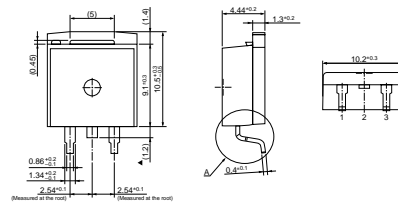

• No. 6 Surface-Mount (TO220S)

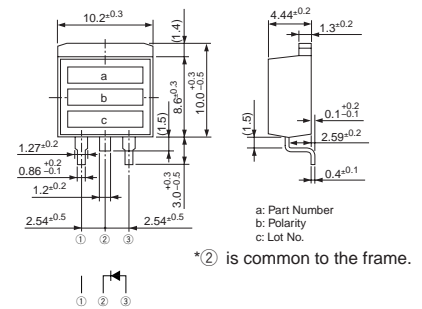

• No. 7 Surface-Mount (TO220S) Center-tap

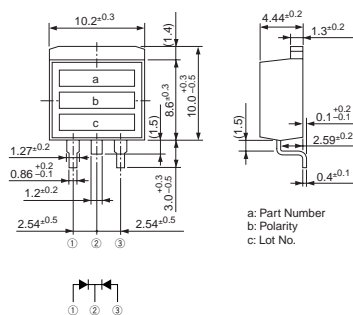

• No. 8 Surface-Mount (SZ-10)

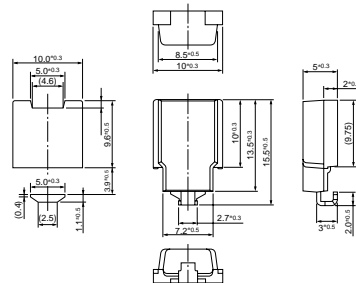

• No. 9 Axial (φ2.4/φ0.6)

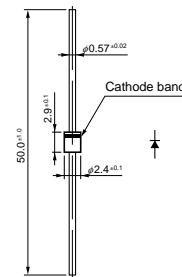

• No. 10 Axial (φ2.7/φ0.6)

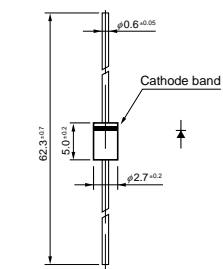

• No. 11 Axial (φ2.7/φ0.6)
Silicon Varistors (Symmetrical)

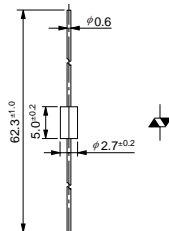

• No. 12 Axial (φ2.7/φ0.78)

