

## HEXFRED<sup>®</sup> Ultrafast Diodes, 300 A (INT-A-PAK Power Modules)

**INT-A-PAK**
**FEATURES**

- Electrically isolated: DCB base plate
- Standard JEDEC<sup>®</sup> package
- Simplified mechanical designs, rapid assembly
- High surge capability
- Large creepage distances
- Case style INT-A-PAK
- Designed and qualified for industrial level
- Material categorization: for definitions of compliance please see [www.vishay.com/doc?99912](http://www.vishay.com/doc?99912)

**RoHS  
COMPLIANT**
**PRODUCT SUMMARY**

$V_R$	1200 V
$V_F$ (typical) at 300 A at 25 °C	2.18 V
$t_{rr}$ (typical) at 45 A	233 ns
$I_{F(DC)}$ at $T_C$	300 A at 60 °C
Package	INT-A-PAK
Circuit	Single diode

**REMARKS**

- Product reliability results valid for  $T_J = 150$  °C
- Recommended operation temperature  $T_{op} = 150$  °C

**ABSOLUTE MAXIMUM RATINGS**

PARAMETER	SYMBOL	TEST CONDITIONS	VALUES	UNITS
Cathode to anode voltage	$V_R$		1200	V
Continuous forward current	$I_F$	$T_C = 25$ °C	375	A
		$T_C = 60$ °C	300	
Single pulse forward current	$I_{FSM}$	$T_J = 25$ °C	2400	
Maximum power dissipation	$P_D$	$T_C = 25$ °C	1040	W
		$T_C = 60$ °C	750	
RMS isolation voltage	$V_{ISOL}$	50 Hz, circuit to base, all terminal shorted, $t = 1$ s	3500	V
Junction temperature range	$T_J$		-40 to +150	°C
Storage temperature range	$T_{Stg}$		-40 to +150	

**ELECTRICAL SPECIFICATIONS PER LEG ( $T_J = 25$  °C unless otherwise specified)**

PARAMETER	SYMBOL	TEST CONDITIONS	MIN.	TYP.	MAX.	UNITS
Cathode to anode breakdown voltage	$V_{BR}$	$I_R = 500$ $\mu$ A	1200	-	-	V
Maximum forward voltage	$V_{FM}$	$I_F = 300$ A	-	2.18	2.23	
		$I_F = 300$ A, $T_J = 150$ °C	-	2.24	2.47	
Maximum reverse leakage current	$I_{RM}$	$V_R = 1200$ V	-	0.06	0.2	mA
		$T_J = 150$ °C, $V_R = 1200$ V	-	-	20	



DYNAMIC RECOVERY CHARACTERISTICS (T <sub>J</sub> = 25 °C unless otherwise specified)							
PARAMETER	SYMBOL	TEST CONDITIONS		MIN.	TYP.	MAX.	UNITS
Diode reverse recovery charge	Q <sub>rr</sub>	T <sub>J</sub> = 25 °C	I <sub>F</sub> = 45 A V <sub>R</sub> = 400 V di <sub>F</sub> /dt = 500 A/μs	-	3.5	-	μC
		T <sub>J</sub> = 125 °C		-	10.4	-	
Reverse recovery time	t <sub>rr</sub>	T <sub>J</sub> = 25 °C		-	233	-	ns
		T <sub>J</sub> = 125 °C		-	396	-	
Reverse recovery current	I <sub>rr</sub>	T <sub>J</sub> = 25 °C		-	30	-	A
		T <sub>J</sub> = 125 °C		-	53	-	

THERMAL - MECHANICAL SPECIFICATIONS					
PARAMETER	SYMBOL	TEST CONDITIONS	VALUES	UNITS	
Maximum internal thermal resistance, junction to case per leg	R <sub>thJC</sub>	DC operation	0.12	°C/W	
Typical thermal resistance, case to heatsink per module	R <sub>thCS</sub>	Mounting surface flat, smooth and greased	0.05		
Mounting torque ± 10 %	to heatsink	A mounting compound is recommended and the torque should be rechecked after a period of 3 hours to allow for the spread of the compound.	4	Nm	
	busbar		6		
Approximate weight				200	g
				7.1	oz.
Case style			New INT-A-PAK		

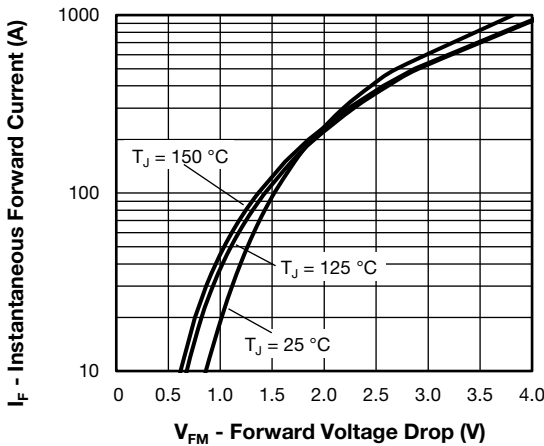

Fig. 1 - Typical Forward Voltage Drop Characteristics

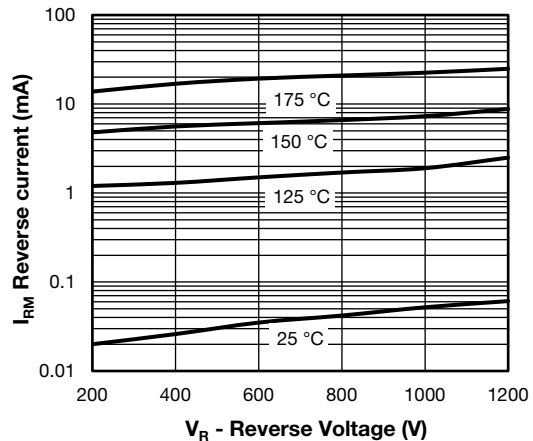

Fig. 2 - Typical Value of Reverse Current vs. Reverse Voltage

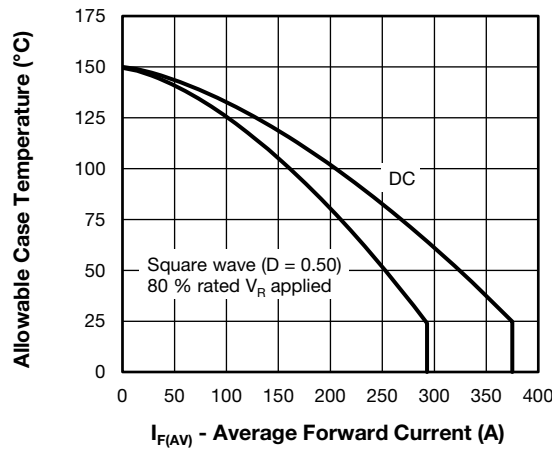

Fig. 3 - Maximum Allowable Case Temperature vs. Average Forward Current

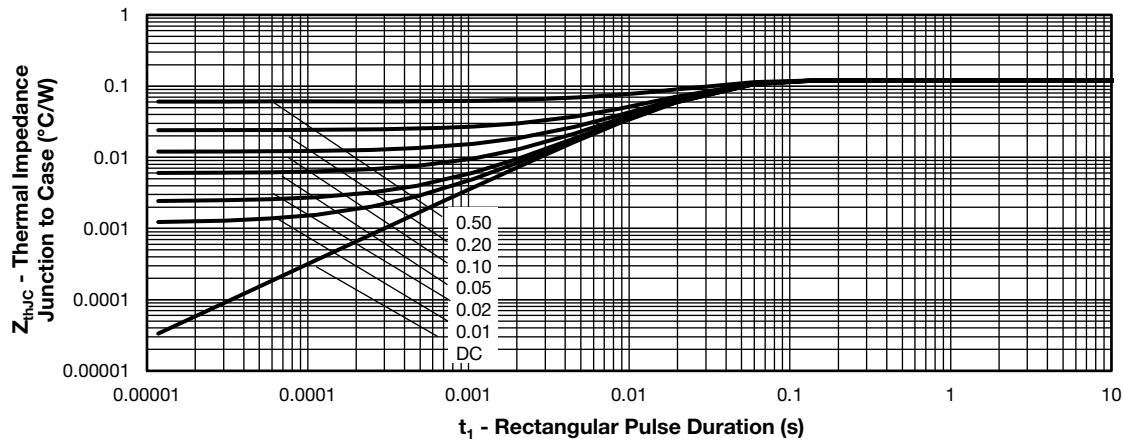

Fig. 4 - Maximum Thermal Impedance  $R_{thJC}$  Characteristics

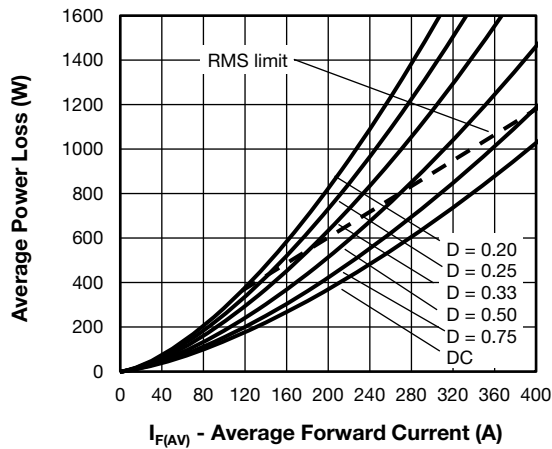

Fig. 5 - Forward Power Loss Characteristics

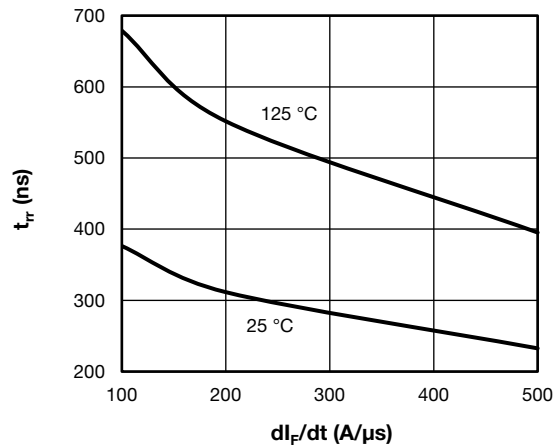

Fig. 6 - Typical Reverse Recovery Time vs.  $di_F/dt$

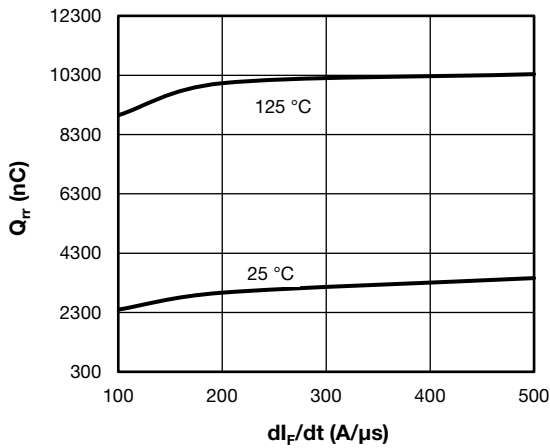

Fig. 7 - Typical Reverse Recovery Charge vs.  $di_F/dt$

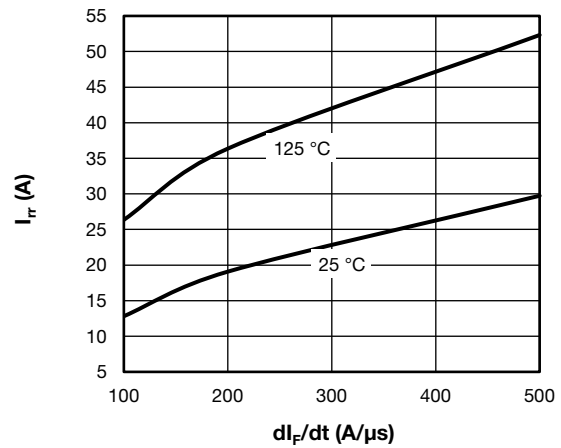

Fig. 8 - Typical Reverse Recovery Current vs.  $di_F/dt$

**ORDERING INFORMATION TABLE**

Device code	<b>VS-VS</b>	<b>KE</b>	<b>U</b>	<b>300</b>	<b>/</b>	<b>12</b>	<b>PbF</b>
	①	②	③	④		⑤	⑥
	<b>1</b>	-	Vishay Semiconductors product				
	<b>2</b>	-	KE = circuit configuration				
	<b>3</b>	-	U = ultrafast diode				
	<b>4</b>	-	Current rating 300 = 300 A				
	<b>5</b>	-	Voltage rating (12 = 1200 V)				
	<b>6</b>	-	PbF = lead (Pb)-free				

**CIRCUIT CONFIGURATION**





**DIMENSIONS** in (inches) millimeters **INT-A-PAK DBC**

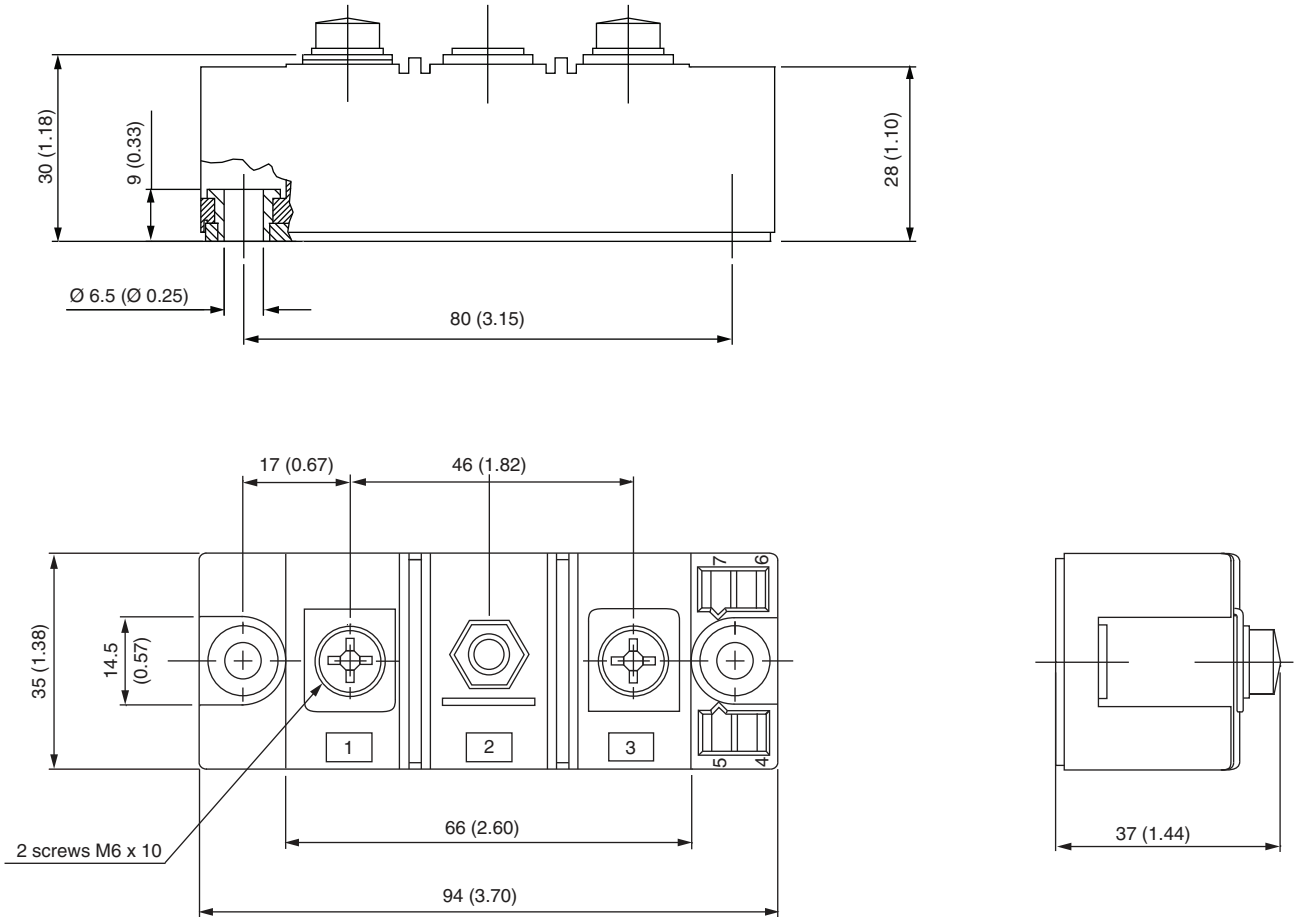



## **Disclaimer**

ALL PRODUCT, PRODUCT SPECIFICATIONS AND DATA ARE SUBJECT TO CHANGE WITHOUT NOTICE TO IMPROVE RELIABILITY, FUNCTION OR DESIGN OR OTHERWISE.

Vishay Intertechnology, Inc., its affiliates, agents, and employees, and all persons acting on its or their behalf (collectively, "Vishay"), disclaim any and all liability for any errors, inaccuracies or incompleteness contained in any datasheet or in any other disclosure relating to any product.

Vishay makes no warranty, representation or guarantee regarding the suitability of the products for any particular purpose or the continuing production of any product. To the maximum extent permitted by applicable law, Vishay disclaims (i) any and all liability arising out of the application or use of any product, (ii) any and all liability, including without limitation special, consequential or incidental damages, and (iii) any and all implied warranties, including warranties of fitness for particular purpose, non-infringement and merchantability.

Statements regarding the suitability of products for certain types of applications are based on Vishay's knowledge of typical requirements that are often placed on Vishay products in generic applications. Such statements are not binding statements about the suitability of products for a particular application. It is the customer's responsibility to validate that a particular product with the properties described in the product specification is suitable for use in a particular application. Parameters provided in datasheets and / or specifications may vary in different applications and performance may vary over time. All operating parameters, including typical parameters, must be validated for each customer application by the customer's technical experts. Product specifications do not expand or otherwise modify Vishay's terms and conditions of purchase, including but not limited to the warranty expressed therein.

Except as expressly indicated in writing, Vishay products are not designed for use in medical, life-saving, or life-sustaining applications or for any other application in which the failure of the Vishay product could result in personal injury or death. Customers using or selling Vishay products not expressly indicated for use in such applications do so at their own risk. Please contact authorized Vishay personnel to obtain written terms and conditions regarding products designed for such applications.

No license, express or implied, by estoppel or otherwise, to any intellectual property rights is granted by this document or by any conduct of Vishay. Product names and markings noted herein may be trademarks of their respective owners.