

EMIPAK-2B PressFit Power Module 3-Levels Half-Bridge Inverter Stage, 75 A



EMIPAK-2B
(package example)

FEATURES

- Trench IGBT technology
- FRED Pt® clamping diodes
- PressFit pins technology
- Exposed Al₂O₃ substrate with low thermal resistance
- Short circuit rated
- Square RBSOA
- Integrated thermistor
- Low internal inductances
- Low switching loss
- PressFit pins locking technology. Patent # US.263.820 B2
- UL approved file E78996
- Material categorization: for definitions of compliance please see www.vishay.com/doc?99912



RoHS
COMPLIANT

PRODUCT SUMMARY	
Q1 - Q4 IGBT STAGE	
V _{CES}	600 V
V _{CE(ON)} typical at I _C = 75 A	1.7 V
I _C at T _C = 89 °C	75 A
Q2 - Q3 IGBT STAGE	
V _{CES}	600 V
V _{CE(ON)} typical at I _C = 75 A	1.56 V
I _C at T _C = 122 °C	75 A
Speed	8 kHz to 30 kHz
Package	EMIPAK-2B
Circuit	3-levels half bridge inverter stage

DESCRIPTION

VS-ETF075Y60U is an integrated solution for a multi level inverter stage in a single package. The EMIPAK-2B package is easy to use thanks to the PressFit pins and the exposed substrate provides improved thermal performance. The optimized layout also helps to minimize stray parameters, allowing for better EMI performance.

ABSOLUTE MAXIMUM RATINGS				
PARAMETER	SYMBOL	TEST CONDITIONS	MAX.	UNITS
Operating junction temperature	T _J		175	°C
Storage temperature range	T _{Stg}		-40 to +150	
RMS isolation voltage	V _{ISOL}	T _J = 25 °C, all terminals shorted, f = 50 Hz, t = 1 s	3500	V
Q1 - Q4 IGBT				
Collector to emitter voltage	V _{CES}		600	V
Gate to emitter voltage	V _{GES}		20	
Pulsed collector current	I _{CM}		200	A
Clamped inductive load current	I _{LM} ⁽¹⁾		200	
Continuous collector current	I _C	T _C = 25 °C	109	A
		T _C = 80 °C	80	
		T _{SINK} = 80 °C	40	
Power dissipation	P _D	T _C = 25 °C	294	W
		T _C = 80 °C	186	

PATENT(S): www.vishay.com/patents

This Vishay product is protected by one or more United States and International patents.



ABSOLUTE MAXIMUM RATINGS				
PARAMETER	SYMBOL	TEST CONDITIONS	MAX.	UNITS
Q2 - Q3 IGBT				
Collector to emitter voltage	V_{CES}		600	V
Gate to emitter voltage	V_{GES}		20	
Pulsed collector current	I_{CM}		250	A
Clamped inductive load current	$I_{LM}^{(1)}$		250	
Continuous collector current	I_C	$T_C = 25\text{ }^\circ\text{C}$	154	A
		$T_C = 80\text{ }^\circ\text{C}$	113	
		$T_{SINK} = 80\text{ }^\circ\text{C}$	50	
Power dissipation	P_D	$T_C = 25\text{ }^\circ\text{C}$	405	W
		$T_C = 80\text{ }^\circ\text{C}$	257	
D5 - D6 CLAMPING DIODE				
Repetitive peak reverse voltage	V_{RRM}		600	V
Single pulse forward current	I_{FSM}	10 ms sine or 6 ms rectangular pulse, $T_J = 25\text{ }^\circ\text{C}$	270	A
Diode continuous forward current	I_F	$T_C = 25\text{ }^\circ\text{C}$	78	
		$T_C = 80\text{ }^\circ\text{C}$	55	
		$T_{SINK} = 80\text{ }^\circ\text{C}$	28	
Power dissipation	P_D	$T_C = 25\text{ }^\circ\text{C}$	174	W
		$T_C = 80\text{ }^\circ\text{C}$	110	
D1 - D2 - D3 - D4 AP DIODE				
Single pulse forward current	I_{FSM}	10 ms sine or 6 ms rectangular pulse, $T_J = 25\text{ }^\circ\text{C}$	250	A
Diode continuous forward current	I_F	$T_C = 25\text{ }^\circ\text{C}$	72	
		$T_C = 80\text{ }^\circ\text{C}$	70	
		$T_{SINK} = 80\text{ }^\circ\text{C}$	31	
Power dissipation	P_D	$T_C = 25\text{ }^\circ\text{C}$	107	W
		$T_C = 80\text{ }^\circ\text{C}$	68	

Notes

- Absolute Maximum Ratings indicate sustained limits beyond which damage to the device may occur.
- ⁽¹⁾ $V_{CC} = 300\text{ V}$, $V_{GE} = 15\text{ V}$, $L = 500\text{ }\mu\text{H}$, $R_g = 4.7\text{ }\Omega$, $T_J = 175\text{ }^\circ\text{C}$



ELECTRICAL SPECIFICATIONS ($T_J = 25\text{ }^\circ\text{C}$ unless otherwise noted)						
PARAMETER	SYMBOL	TEST CONDITIONS	MIN.	TYP.	MAX.	UNITS
Q1 - Q4 IGBT						
Collector to emitter breakdown voltage	BV_{CES}	$V_{GE} = 0\text{ V}, I_C = 100\text{ }\mu\text{A}$	600	-	-	V
Collector to emitter voltage	$V_{CE(ON)}$	$V_{GE} = 15\text{ V}, I_C = 60\text{ A}$	-	1.57	1.8	V
		$V_{GE} = 15\text{ V}, I_C = 75\text{ A}$	-	1.7	1.93	
		$V_{GE} = 15\text{ V}, I_C = 60\text{ A}, T_J = 125\text{ }^\circ\text{C}$	-	1.7	-	
		$V_{GE} = 15\text{ V}, I_C = 75\text{ A}, T_J = 125\text{ }^\circ\text{C}$	-	1.86	-	
Gate threshold voltage	$V_{GE(th)}$	$V_{CE} = V_{GE}, I_C = 2.1\text{ mA}$	3.6	5.6	7.1	
Temperature coefficient of threshold voltage	$\Delta V_{GE(th)}/\Delta T_J$	$V_{CE} = V_{GE}, I_C = 1\text{ mA}$ (25 °C to 125 °C)	-	-12	-	mV/°C
Forward transconductance	g_{fe}	$V_{CE} = 20\text{ V}, I_C = 75\text{ A}$	-	51	-	S
Transfer characteristics	V_{GE}	$V_{CE} = 20\text{ V}, I_C = 75\text{ A}$	-	9.6	-	V
Zero gate voltage collector current	I_{CES}	$V_{GE} = 0\text{ V}, V_{CE} = 600\text{ V}$	-	0.0002	0.1	mA
		$V_{GE} = 0\text{ V}, V_{CE} = 600\text{ V}, T_J = 125\text{ }^\circ\text{C}$	-	0.01	-	
Gate to emitter leakage current	I_{GES}	$V_{GE} = \pm 20\text{ V}, V_{CE} = 0\text{ V}$	-	-	± 200	nA
Q2 - Q3 IGBT						
Collector to emitter breakdown voltage	BV_{CES}	$V_{GE} = 0\text{ V}, I_C = 500\text{ }\mu\text{A}$	600	-	-	V
Collector to emitter voltage	$V_{CE(ON)}$	$V_{GE} = 15\text{ V}, I_C = 60\text{ A}$	-	1.45	1.62	V
		$V_{GE} = 15\text{ V}, I_C = 75\text{ A}$	-	1.56	1.73	
		$V_{GE} = 15\text{ V}, I_C = 60\text{ A}, T_J = 125\text{ }^\circ\text{C}$	-	1.52	-	
		$V_{GE} = 15\text{ V}, I_C = 75\text{ A}, T_J = 125\text{ }^\circ\text{C}$	-	1.67	-	
Gate threshold voltage	$V_{GE(th)}$	$V_{CE} = V_{GE}, I_C = 5.6\text{ mA}$	3.6	5.3	7.1	
Temperature coefficient of threshold voltage	$\Delta V_{GE(th)}/\Delta T_J$	$V_{CE} = V_{GE}, I_C = 1.4\text{ mA}$ (25 °C to 125 °C)	-	-18	-	mV/°C
Forward transconductance	g_{fe}	$V_{CE} = 20\text{ V}, I_C = 75\text{ A}$	-	72	-	S
Transfer characteristics	V_{GE}	$V_{CE} = 20\text{ V}, I_C = 75\text{ A}$	-	8.3	-	V
Zero gate voltage collector current	I_{CES}	$V_{GE} = 0\text{ V}, V_{CE} = 600\text{ V}$	-	0.0005	0.1	mA
		$V_{GE} = 0\text{ V}, V_{CE} = 600\text{ V}, T_J = 125\text{ }^\circ\text{C}$	-	0.065	-	
Gate to emitter leakage current	I_{GES}	$V_{GE} = \pm 20\text{ V}, V_{CE} = 0\text{ V}$	-	-	± 400	nA
D5 - D6 CLAMPING DIODE						
Cathode to anode blocking voltage	V_{BR}	$I_R = 100\text{ }\mu\text{A}$	600	-	-	V
Forward voltage drop	V_{FM}	$I_F = 40\text{ A}$	-	1.83	2.35	
		$I_F = 40\text{ A}, T_J = 125\text{ }^\circ\text{C}$	-	1.51	-	
Reverse leakage current	I_{RM}	$V_R = 600\text{ V}$	-	0.0002	0.1	mA
		$V_R = 600\text{ V}, T_J = 125\text{ }^\circ\text{C}$	-	0.028	-	
D1 - D2 - D3 - D4 AP DIODE						
Forward voltage drop	V_{FM}	$I_F = 30\text{ A}$	-	1.2	1.41	V
		$I_F = 30\text{ A}, T_J = 125\text{ }^\circ\text{C}$	-	1.06	-	



SWITCHING CHARACTERISTICS ($T_J = 25\text{ }^\circ\text{C}$ unless otherwise noted)						
PARAMETER	SYMBOL	TEST CONDITIONS	MIN.	TYP.	MAX.	UNITS
Q1 - Q4 IGBT (WITH D5 - D6 CLAMPING DIODE)						
Total gate charge (turn-on)	Q_g	$I_C = 75\text{ A}$ $V_{CC} = 400\text{ V}$ $V_{GE} = 15\text{ V}$	-	150	-	nC
Gate to emitter charge (turn-on)	Q_{ge}		-	40	-	
Gate to collector charge (turn-on)	Q_{gc}		-	60	-	
Turn-on switching loss	E_{ON}	$I_C = 75\text{ A}$ $V_{CC} = 300\text{ V}$ $V_{GE} = 15\text{ V}$ $R_g = 4.7\text{ }\Omega$ $L = 500\text{ }\mu\text{H}^{(1)}$	-	0.94	-	mJ
Turn-off switching loss	E_{OFF}		-	1.1	-	
Total switching loss	E_{TOT}		-	2.04	-	
Turn-on delay time	$t_{d(on)}$	$R_g = 4.7\text{ }\Omega$ $L = 500\text{ }\mu\text{H}^{(1)}$	-	78	-	ns
Rise time	t_r		-	72	-	
Turn-off delay time	$t_{d(off)}$		-	101	-	
Fall time	t_f		-	65	-	
Turn-on switching loss	E_{ON}		-	1.13	-	
Turn-off switching loss	E_{OFF}	$I_C = 75\text{ A}$ $V_{CC} = 300\text{ V}$ $V_{GE} = 15\text{ V}$ $R_g = 4.7\text{ }\Omega$ $L = 500\text{ }\mu\text{H}$ $T_J = 125\text{ }^\circ\text{C}^{(1)}$	-	1.61	-	mJ
Total switching loss	E_{TOT}		-	2.74	-	
Turn-on delay time	$t_{d(on)}$		-	78	-	
Rise time	t_r	$L = 500\text{ }\mu\text{H}$ $T_J = 125\text{ }^\circ\text{C}^{(1)}$	-	72	-	ns
Turn-off delay time	$t_{d(off)}$		-	106	-	
Fall time	t_f		-	107	-	
Input capacitance	C_{ies}	$V_{GE} = 0\text{ V}$ $V_{CC} = 30\text{ V}$ $f = 1\text{ MHz}$	-	4440	-	pF
Output capacitance	C_{oes}		-	245	-	
Reverse transfer capacitance	C_{res}		-	130	-	
Reverse bias safe operating area	RBSOA	$T_J = 175\text{ }^\circ\text{C}$, $I_C = 200\text{ A}$, $V_{CC} = 300\text{ V}$, $V_P = 600\text{ V}$, $R_g = 4.7\text{ }\Omega$, $V_{GE} = 15\text{ V to }0\text{ V}$	Fullsquare			
Short circuit safe operating area	SCSOA	$R_g = 10\text{ }\Omega$, $V_{CC} = 400\text{ V}$, $V_P = 600\text{ V}$ $V_{GE} = 15\text{ V to }0$	-	-	5	μs
Q2 - Q3 IGBT (WITH FREEWHEELING EXTERNAL TO-247 DIODE DISCRETE 30ETH06)						
Total gate charge (turn-on)	Q_g	$I_C = 120\text{ A}$ $V_{CC} = 400\text{ V}$ $V_{GE} = 15\text{ V}$	-	240	-	nC
Gate to emitter charge (turn-on)	Q_{ge}		-	69	-	
Gate to collector charge (turn-on)	Q_{gc}		-	90	-	
Turn-on switching loss	E_{ON}	$I_C = 75\text{ A}$ $V_{CC} = 300\text{ V}$ $V_{GE} = 15\text{ V}$ $R_g = 4.7\text{ }\Omega$ $L = 500\text{ }\mu\text{H}^{(1)}$	-	0.85	-	mJ
Turn-off switching loss	E_{OFF}		-	1.54	-	
Total switching loss	E_{TOT}		-	2.39	-	
Turn-on delay time	$t_{d(on)}$	$R_g = 4.7\text{ }\Omega$ $L = 500\text{ }\mu\text{H}^{(1)}$	-	111	-	ns
Rise time	t_r		-	81	-	
Turn-off delay time	$t_{d(off)}$		-	130	-	
Fall time	t_f		-	74	-	
Turn-on switching loss	E_{ON}		-	1.0	-	
Turn-off switching loss	E_{OFF}	$I_C = 75\text{ A}$ $V_{CC} = 300\text{ V}$ $V_{GE} = 15\text{ V}$ $R_g = 4.7\text{ }\Omega$ $L = 500\text{ }\mu\text{H}$ $T_J = 125\text{ }^\circ\text{C}^{(1)}$	-	1.83	-	mJ
Total switching loss	E_{TOT}		-	2.83	-	
Turn-on delay time	$t_{d(on)}$		-	111	-	
Rise time	t_r	$L = 500\text{ }\mu\text{H}$ $T_J = 125\text{ }^\circ\text{C}^{(1)}$	-	83	-	ns
Turn-off delay time	$t_{d(off)}$		-	140	-	
Fall time	t_f		-	104	-	
Input capacitance	C_{ies}	$V_{GE} = 0\text{ V}$ $V_{CC} = 30\text{ V}$ $f = 1\text{ MHz}$	-	7750	-	pF
Output capacitance	C_{oes}		-	550	-	
Reverse transfer capacitance	C_{res}		-	225	-	
Reverse bias safe operating area	RBSOA	$T_J = 175\text{ }^\circ\text{C}$, $I_C = 250\text{ A}$, $V_{CC} = 300\text{ V}$, $V_P = 600\text{ V}$, $R_g = 4.7\text{ }\Omega$, $V_{GE} = 15\text{ V to }0\text{ V}$	Fullsquare			
Short circuit safe operating area	SCSOA	$R_g = 10\text{ }\Omega$, $V_{CC} = 400\text{ V}$, $V_P = 600\text{ V}$ $V_{GE} = 15\text{ V to }0$	-	-	5	μs



SWITCHING CHARACTERISTICS (T _J = 25 °C unless otherwise noted)						
PARAMETER	SYMBOL	TEST CONDITIONS	MIN.	TYP.	MAX.	UNITS
D5 - D6 CLAMPING DIODE						
Diode reverse recovery time	t _{rr}	V _R = 200 V	-	59	-	ns
Diode peak reverse current	I _{rr}	I _F = 50 A	-	8.5	-	A
Diode recovery charge	Q _{rr}	di/dt = 500 A/μs	-	257	-	nC
Diode reverse recovery time	t _{rr}	V _R = 200 V	-	110	-	ns
Diode peak reverse current	I _{rr}	I _F = 50 A	-	18.5	-	A
Diode recovery charge	Q _{rr}	di/dt = 500 A/μs, T _J = 125 °C	-	1020	-	nC
D1 - D2 - D3 - D4 AP DIODE						
Diode reverse recovery time	t _{rr}	V _R = 200 V	-	108	-	ns
Diode peak reverse current	I _{rr}	I _F = 50 A	-	19.5	-	A
Diode recovery charge	Q _{rr}	di/dt = 500 A/μs	-	1062	-	nC
Diode reverse recovery time	t _{rr}	V _R = 200 V	-	174	-	ns
Diode peak reverse current	I _{rr}	I _F = 50 A	-	31	-	A
Diode recovery charge	Q _{rr}	di/dt = 500 A/μs, T _J = 125 °C	-	2716	-	nC

Note

(1) Energy losses include “tail” and diode reverse recovery.

INTERNAL NTC - THERMISTOR SPECIFICATIONS				
PARAMETER	SYMBOL	TEST CONDITIONS	VALUE	UNITS
Resistance	R ₂₅	T _C = 25 °C	5000	Ω
	R ₁₀₀	T _C = 100 °C	493 ± 5 %	
B-value	B _{25/50}	R ₂ = R ₂₅ exp. [B _{25/50} (1/T ₂ - 1/(298.15 K))]	3375 ± 5 %	K
Maximum operating temperature			220	°C
Dissipation constant			2	mW/°C
Thermal time constant			8	s

THERMAL AND MECHANICAL SPECIFICATIONS					
PARAMETER	SYMBOL	MIN.	TYP.	MAX.	UNITS
Q1 - Q4 IGBT - Junction to case thermal resistance (per switch)	R _{thJC}	-	-	0.51	°C/W
Q2 - Q3 IGBT - Junction to case thermal resistance (per switch)		-	-	0.37	
D5 - D6 Clamping diode - Junction to case thermal resistance (per diode)		-	-	0.86	
D1 - D2 - D3 - D4 AP diode - Junction to case thermal resistance (per diode)		-	-	1.4	
Q1 - Q4 IGBT - Case to sink thermal resistance (per switch)	R _{thCS} ⁽¹⁾	-	0.84	-	
Q2 - Q3 IGBT - Case to sink thermal resistance (per switch)		-	0.8	-	
D5 - D6 Clamping diode - Case to sink thermal resistance (per diode)		-	1.16	-	
D1 - D2 - D3 - D4 AP diode - Case to sink thermal resistance (per diode)		-	1.12	-	
Case to sink thermal resistance per module		-	0.1	-	°C/W
Mounting torque (M4)		2	-	3	Nm
Weight		-	45	-	g

Note

(1) Mounting surface flat, smooth, and greased

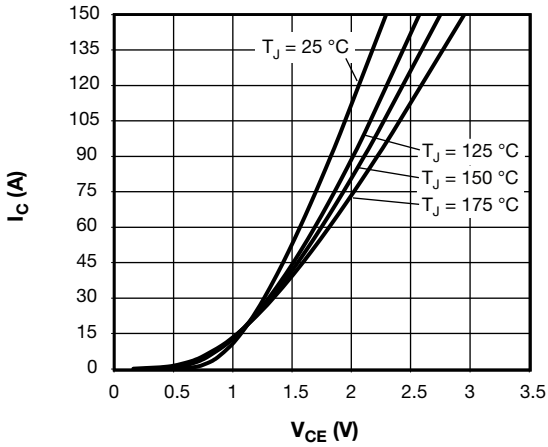

Fig. 1 - Typical Q1 - Q4 Trench IGBT Output Characteristics
 $V_{GE} = 15\text{ V}$

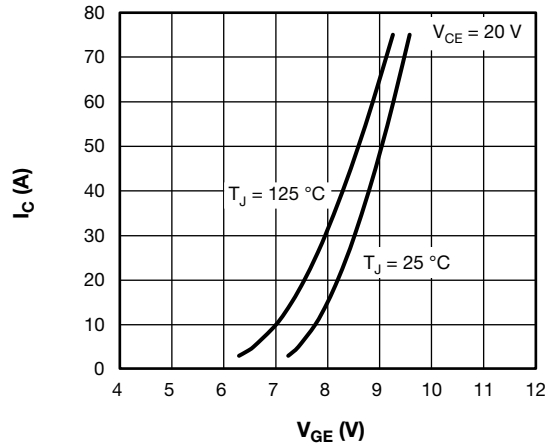

Fig. 4 - Typical Q1 - Q4 Trench IGBT Transfer Characteristics

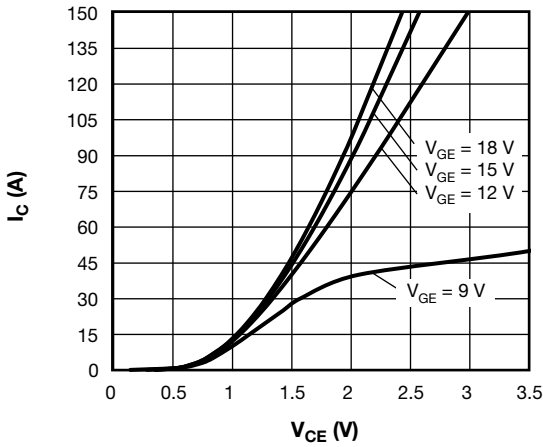

Fig. 2 - Typical Q1 - Q4 Trench IGBT Output Characteristics
 $T_J = 125\text{ °C}$

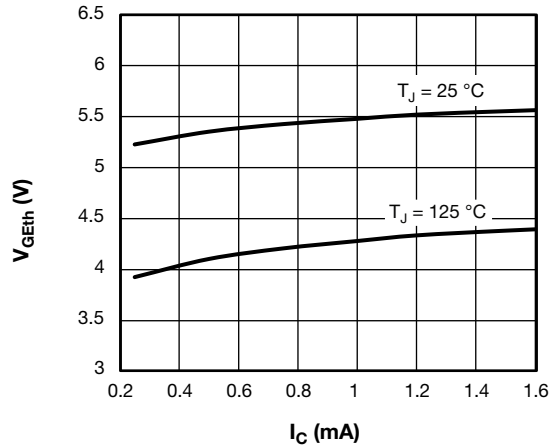

Fig. 5 - Typical Q1 - Q4 Trench IGBT Gate Threshold Voltage

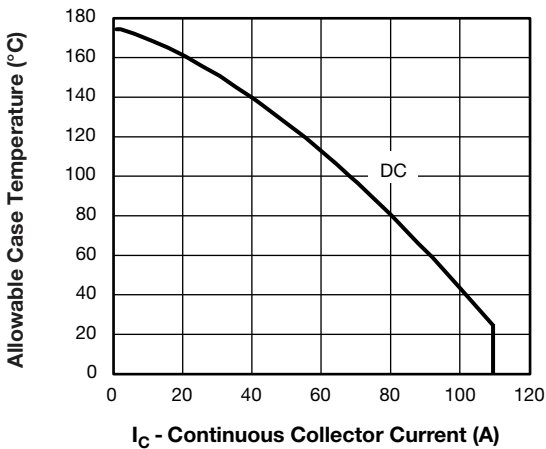

Fig. 3 - Maximum Q1 - Q4 Trench IGBT Continuous Collector Current vs. Case Temperature

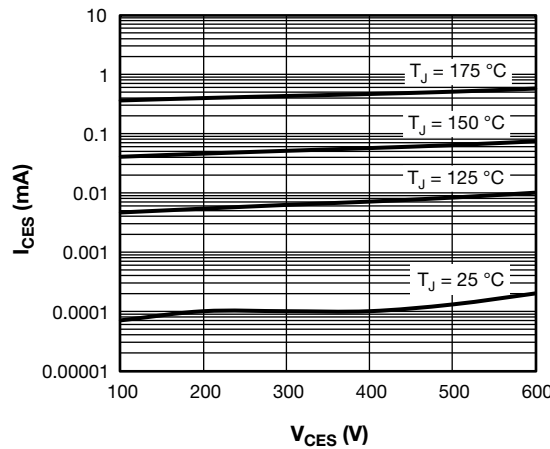

Fig. 6 - Typical Q1 - Q4 Trench IGBT Zero Gate Voltage Collector Current

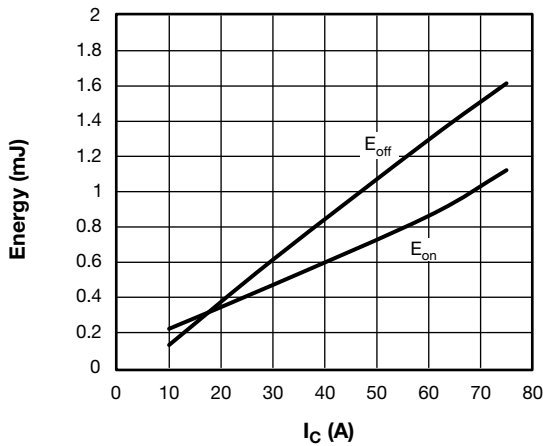

Fig. 7 - Typical Q1 - Q4 Trench IGBT Energy Loss vs. I_C (with D5 - D6 Clamping Diode)
 $T_J = 125^\circ\text{C}$, $V_{CC} = 300\text{ V}$, $R_g = 4.7\ \Omega$, $V_{GE} = 15\text{ V}$, $L = 500\ \mu\text{H}$

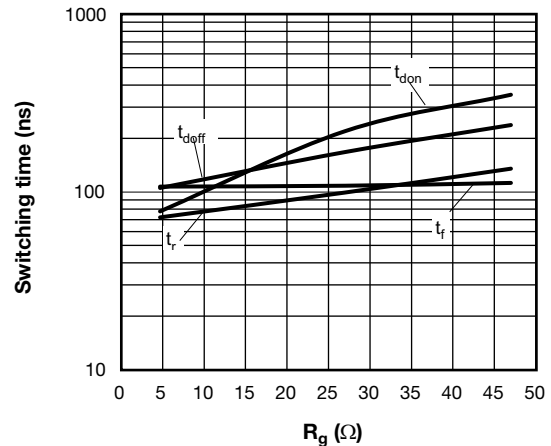

Fig. 10 - Typical Q1 - Q4 Trench IGBT Switching Time vs. R_g (with D5 - D6 Clamping Diode)
 $T_J = 125^\circ\text{C}$, $V_{CC} = 300\text{ V}$, $I_C = 75\text{ A}$, $V_{GE} = 15\text{ V}$, $L = 500\ \mu\text{H}$

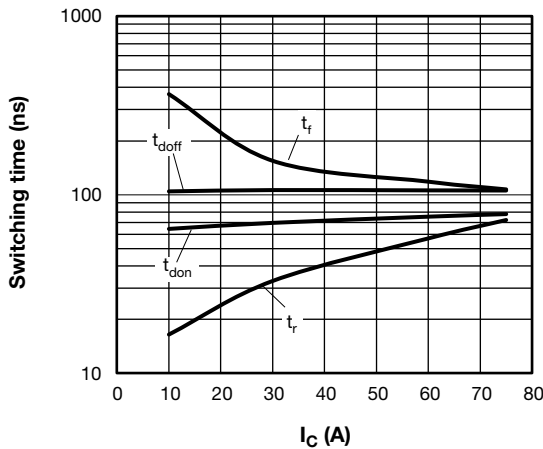

Fig. 8 - Typical Q1 - Q4 Trench IGBT Switching Loss vs. I_C (with D5 - D6 Clamping Diode)
 $T_J = 125^\circ\text{C}$, $V_{CC} = 300\text{ V}$, $R_g = 4.7\ \Omega$, $V_{GE} = 15\text{ V}$, $L = 500\ \mu\text{H}$

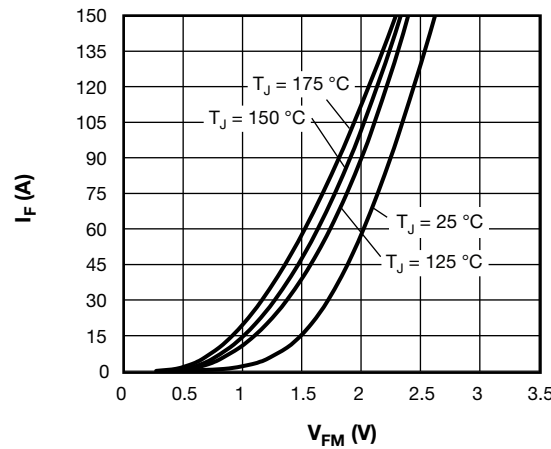

Fig. 11 - Typical D5 - D6 Clamping Diode Forward Characteristics

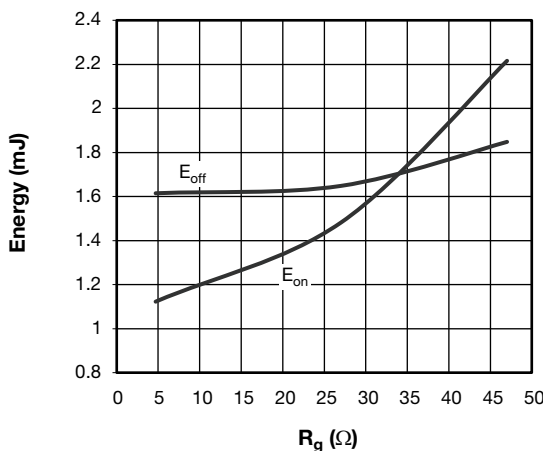

Fig. 9 - Typical Q1 - Q4 Trench IGBT Energy Loss vs. R_g (with D5 - D6 Clamping Diode)
 $T_J = 125^\circ\text{C}$, $V_{CC} = 300\text{ V}$, $I_C = 75\text{ A}$, $V_{GE} = 15\text{ V}$, $L = 500\ \mu\text{H}$

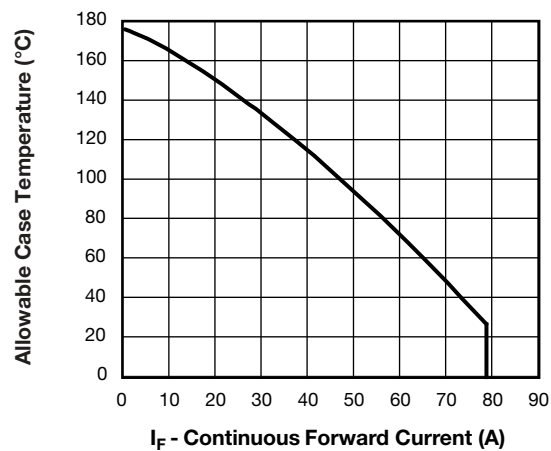

Fig. 12 - Maximum D5 - D6 Clamping Diode Forward Current vs. Case Temperature

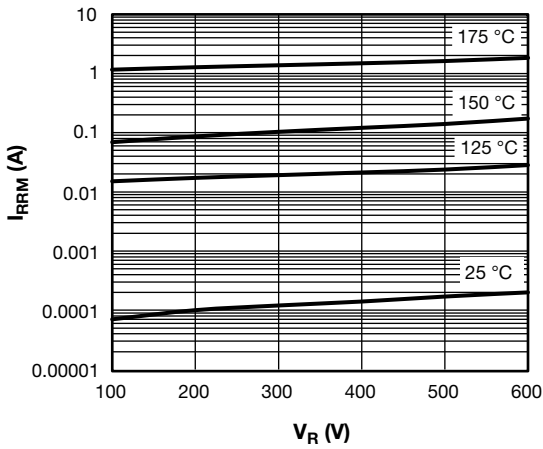

Fig. 13 - Typical D5 - D6 Clamping Diode Reverse Leakage Current

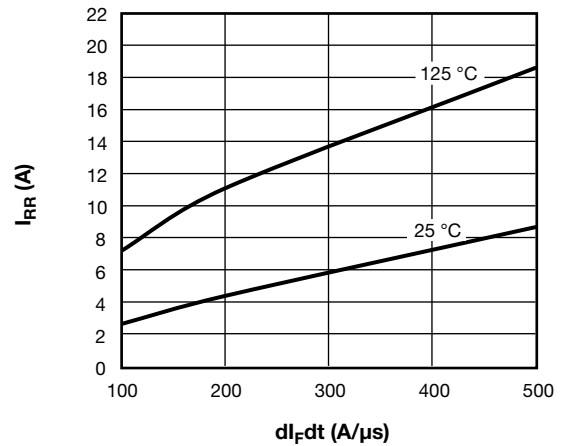

Fig. 15 - Typical D5 - D6 Clamping Diode Reverse Recovery Current vs. di_F/dt , $V_{rr} = 200$ V, $I_F = 50$ A

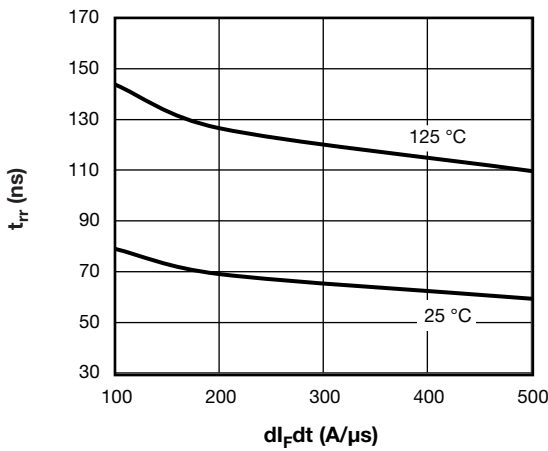

Fig. 14 - Typical D5 - D6 Clamping Diode Reverse Recovery Time vs. di_F/dt , $V_{rr} = 200$ V, $I_F = 50$ A

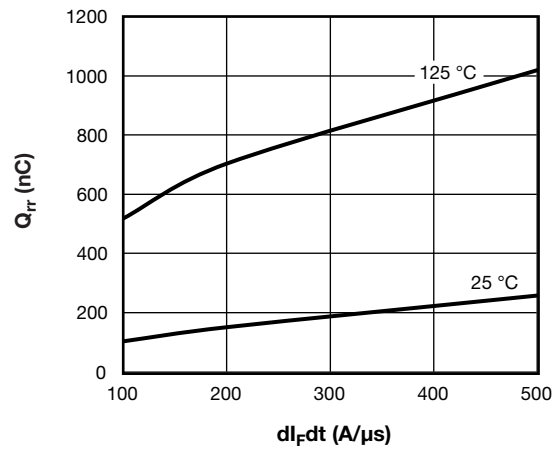

Fig. 16 - Typical D5 - D6 Clamping Diode Reverse Recovery Charge vs. di_F/dt , $V_{rr} = 200$ V, $I_F = 50$ A

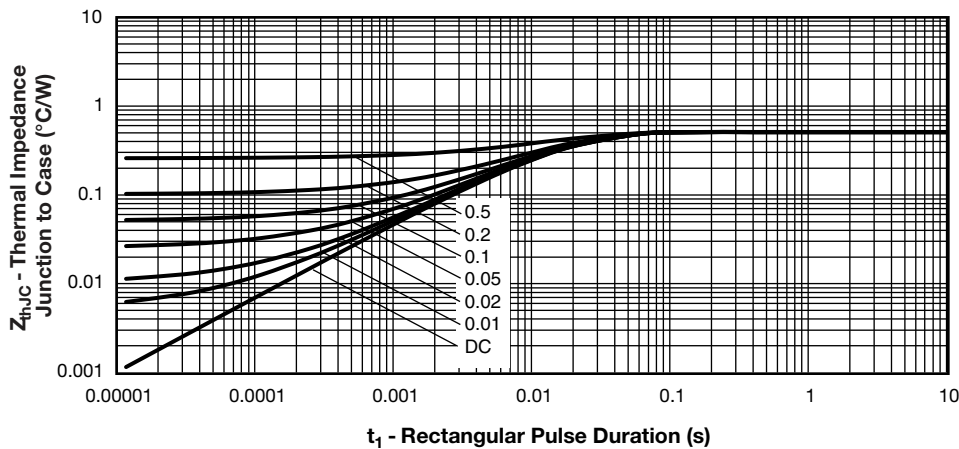

Fig. 17 - Maximum Thermal Impedance Z_{thJc} Characteristics (Q1 - Q4 Trench IGBT)

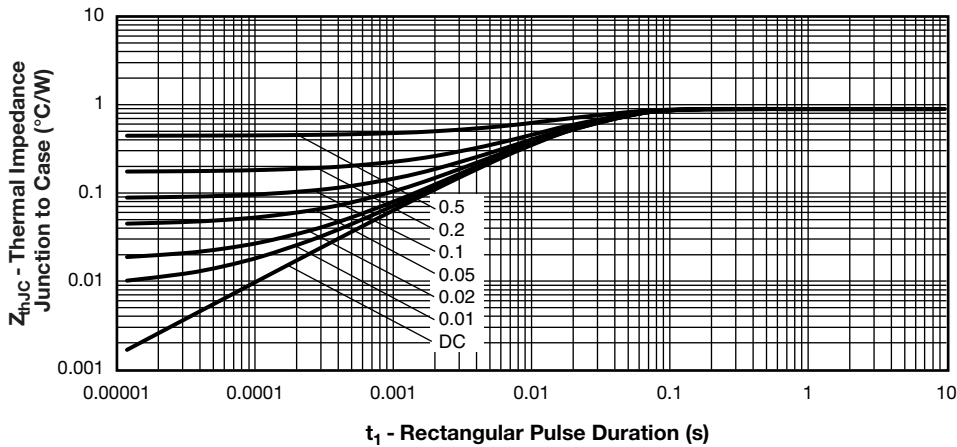

Fig. 18 - Maximum Thermal Impedance Z_{thJC} Characteristics (D5 - D6 Clamping Diode)

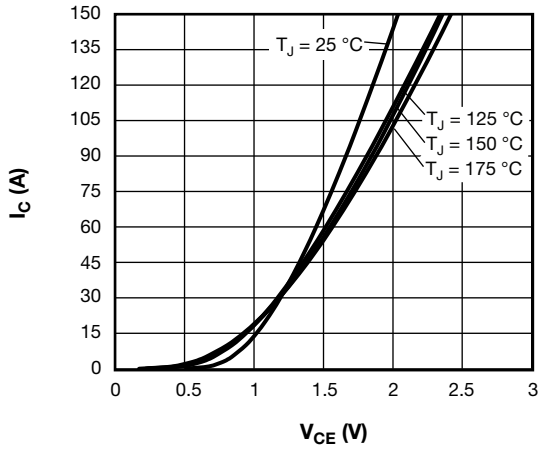

Fig. 19 - Typical Q2 - Q3 Trench IGBT Output Characteristics
 $V_{GE} = 15\text{ V}$

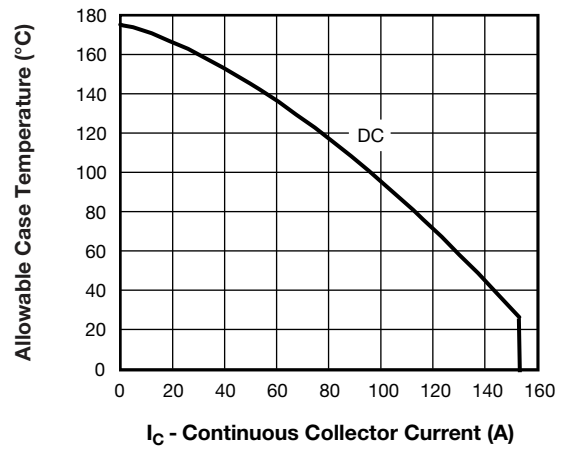

Fig. 21 - Maximum Q2 - Q3 Trench IGBT Continuous Collector Current vs. Case Temperature

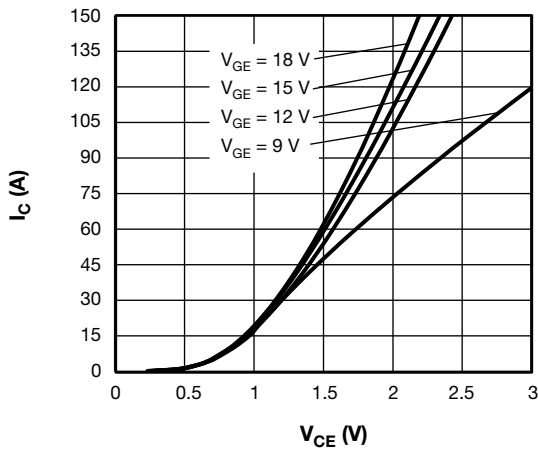

Fig. 20 - Typical Q2 - Q3 Trench IGBT Output Characteristics
 $T_J = 125\text{ °C}$

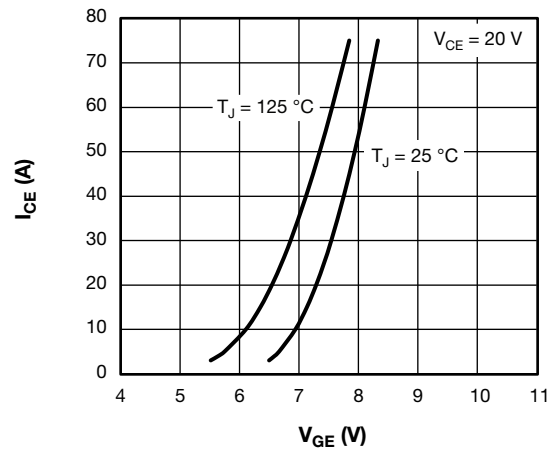

Fig. 22 - Typical Q2 - Q3 Trench IGBT Transfer Characteristics

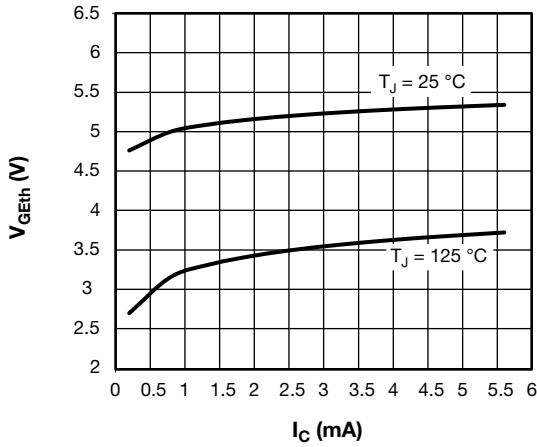

Fig. 23 - Typical Q2 - Q3 Trench IGBT Gate Threshold Voltage

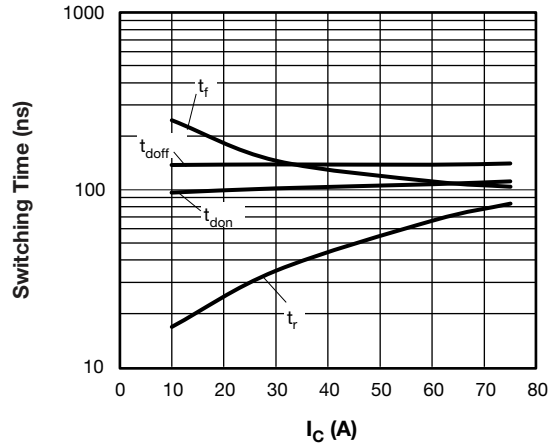

Fig. 26 - Typical Q2 - Q3 Trench IGBT Switching Time vs. I_C (with Freewheeling External TO-247 Diode Discrete 30ETH06), $T_J = 125\text{ }^\circ\text{C}$, $V_{CC} = 300\text{ V}$, $R_g = 4.7\text{ }\Omega$, $V_{GE} = 15\text{ V}$, $L = 500\text{ }\mu\text{H}$

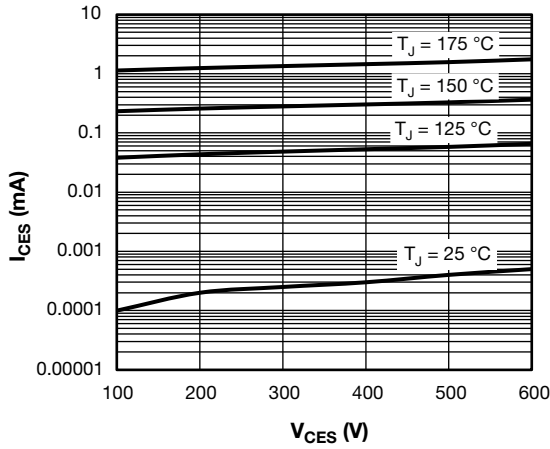

Fig. 24 - Typical Q2 - Q3 Trench IGBT Zero Gate Voltage Collector Current

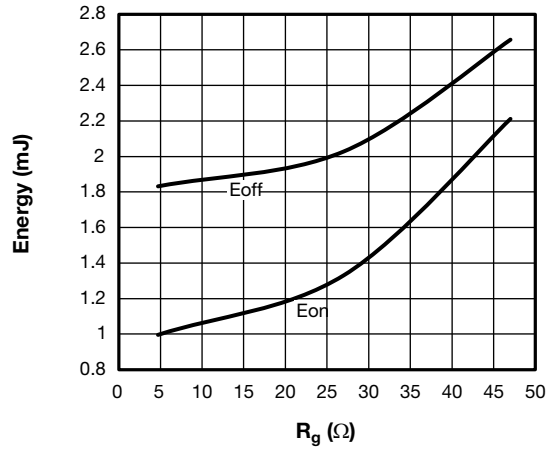

Fig. 27 - Typical Q2 - Q3 Trench IGBT Energy Loss vs. R_g (with Freewheeling External TO-247 Diode Discrete 30ETH06), $T_J = 125\text{ }^\circ\text{C}$, $V_{CC} = 300\text{ V}$, $I_C = 75\text{ A}$, $V_{GE} = 15\text{ V}$, $L = 500\text{ }\mu\text{H}$

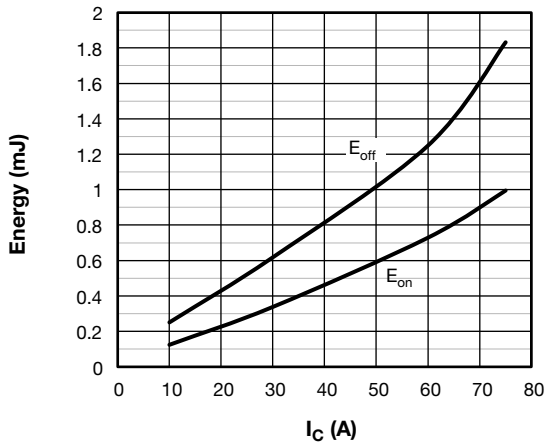

Fig. 25 - Typical Q2 - Q3 Trench IGBT Energy Loss vs. I_C (with Freewheeling External TO-247 Diode Discrete 30ETH06), $T_J = 125\text{ }^\circ\text{C}$, $V_{CC} = 300\text{ V}$, $R_g = 4.7\text{ }\Omega$, $V_{GE} = 15\text{ V}$, $L = 500\text{ }\mu\text{H}$

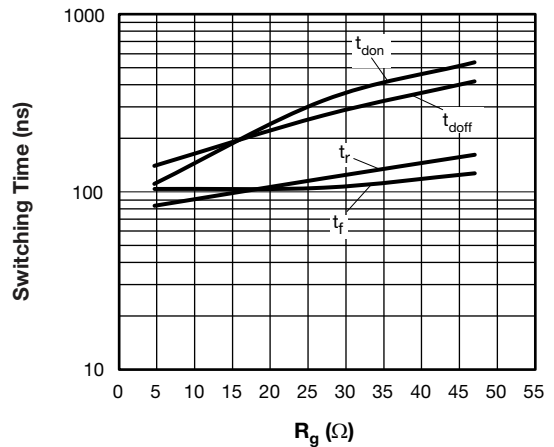

Fig. 28 - Typical Q2 - Q3 Trench IGBT Switching Time vs. R_g (with Freewheeling External TO-247 Diode Discrete 30ETH06), $T_J = 125\text{ }^\circ\text{C}$, $V_{CC} = 300\text{ V}$, $I_C = 75\text{ A}$, $V_{GE} = 15\text{ V}$, $L = 500\text{ }\mu\text{H}$

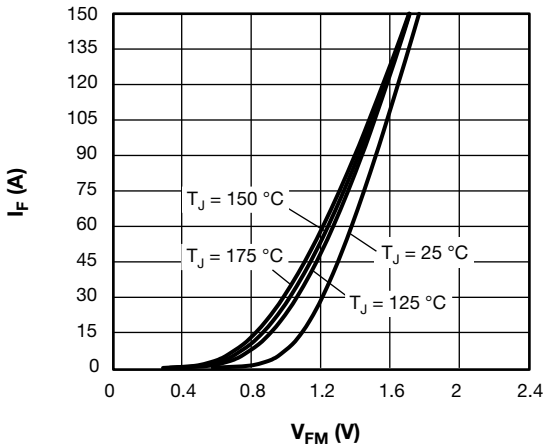

Fig. 29 - Typical D1 - D2 - D3 - D4 Antiparallel Diode Forward Characteristics

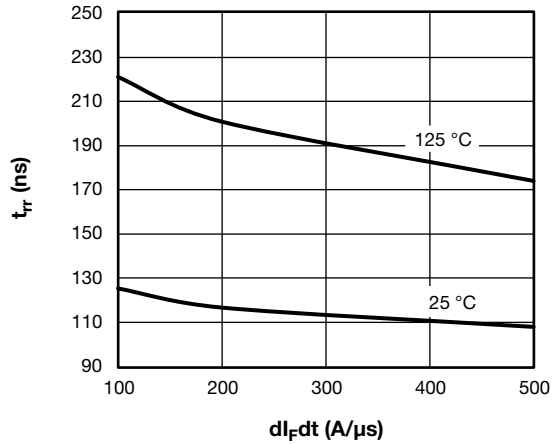

Fig. 31 - Typical D1 - D2 - D3 - D4 Antiparallel Diode Reverse Recovery Time vs. dI_F/dt
 $V_{rr} = 200\text{ V}$, $I_F = 50\text{ A}$

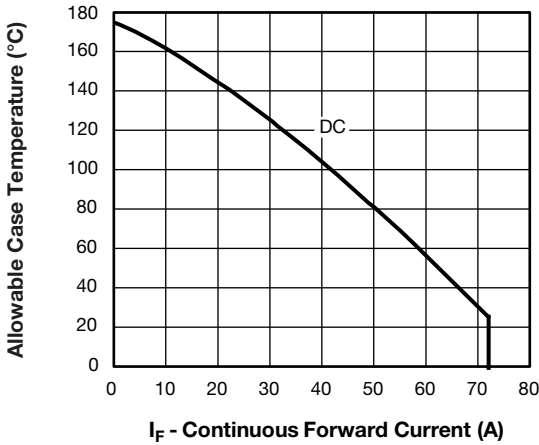

Fig. 30 - Maximum D1 - D2 - D3 - D4 Antiparallel Diode Forward Current vs. Case Temperature

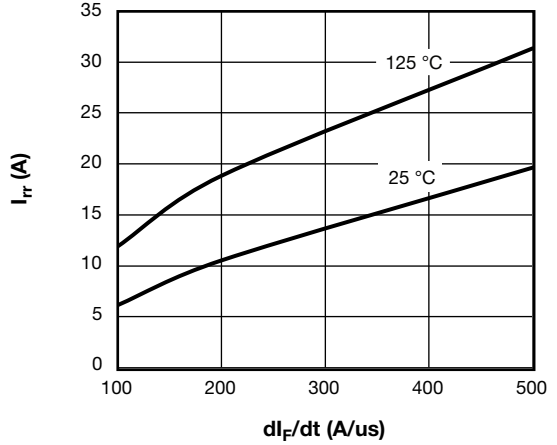

Fig. 32 - Typical D1 - D2 - D3 - D4 Antiparallel Diode Reverse Recovery Current vs. dI_F/dt
 $V_{rr} = 200\text{ V}$, $I_F = 50\text{ A}$

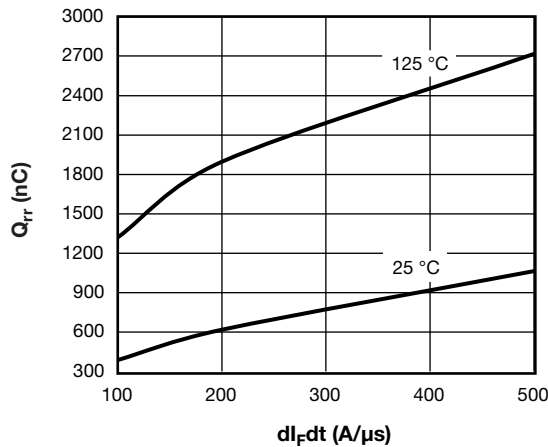

Fig. 33 - Typical D1 - D2 - D3 - D4 Antiparallel Diode Reverse Recovery Charge vs. dI_F/dt
 $V_{rr} = 200\text{ V}$, $I_F = 50\text{ A}$

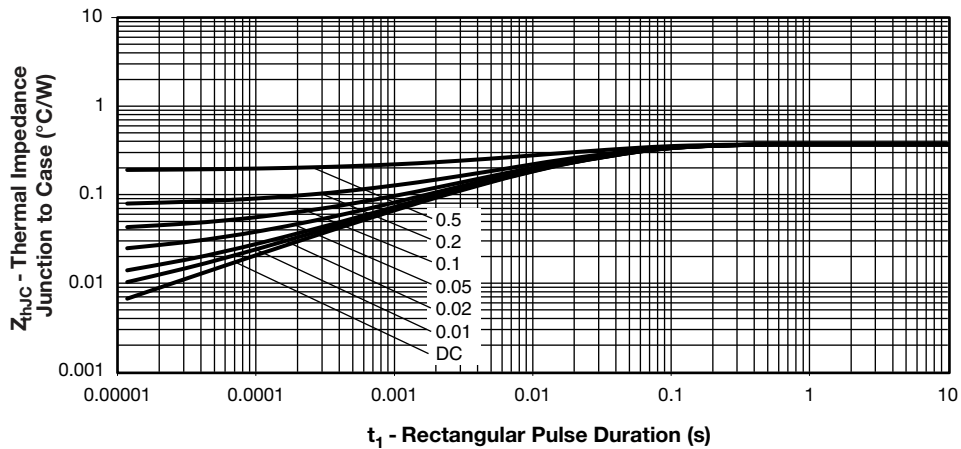

Fig. 34 - Maximum Thermal Impedance Z_{thJC} Characteristics (Q2 - Q3 Trench IGBT)

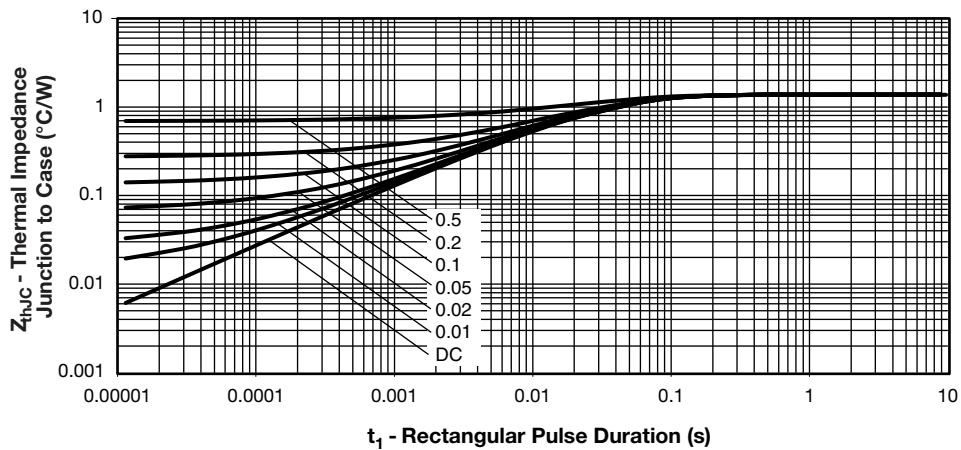

Fig. 35 - Maximum Thermal Impedance Z_{thJC} Characteristics (D1 - D2 - D3 - D4 Antiparallel Diode)

ORDERING INFORMATION TABLE

Device code	VS-	ET	F	075	Y	60	U
	①	②	③	④	⑤	⑥	⑦

- 1** - Vishay Semiconductors product
- 2** - Package indicator (ET = EMIPAK-2B)
- 3** - Circuit configuration (F = 3-levels half-bridge inverter stage)
- 4** - Current rating (075 = 75 A)
- 5** - Switch die technology (Y = trench IGBT)
- 6** - Voltage rating (60 = 600 V)
- 7** - Diode die technology (U = ultrafast diode)

CIRCUIT CONFIGURATION

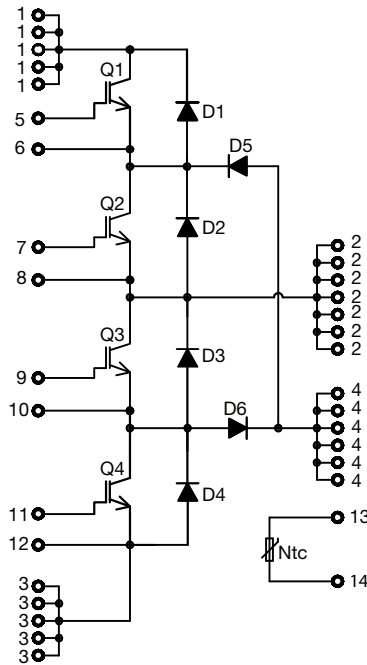

PACKAGE

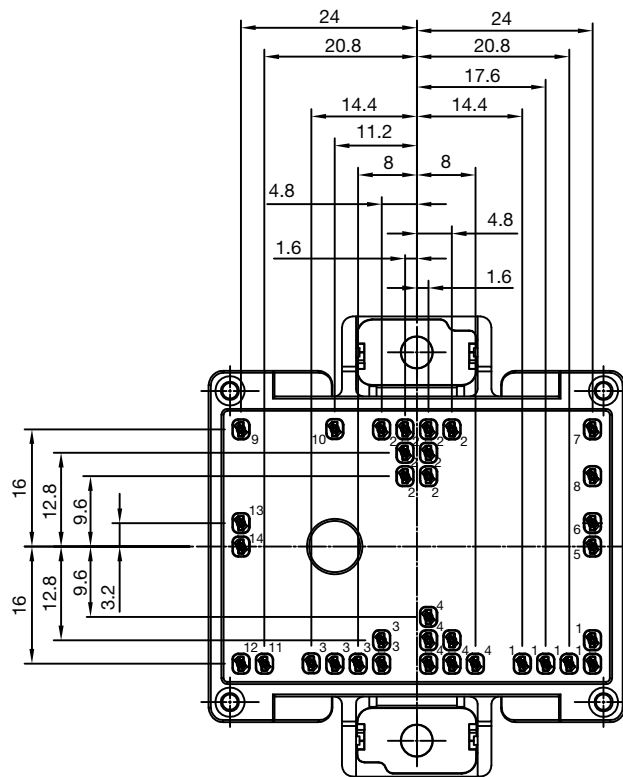

LINKS TO RELATED DOCUMENTS

Dimensions	www.vishay.com/doc?95559
------------	--



EMIPAK-2B PressFit

DIMENSIONS in millimeters

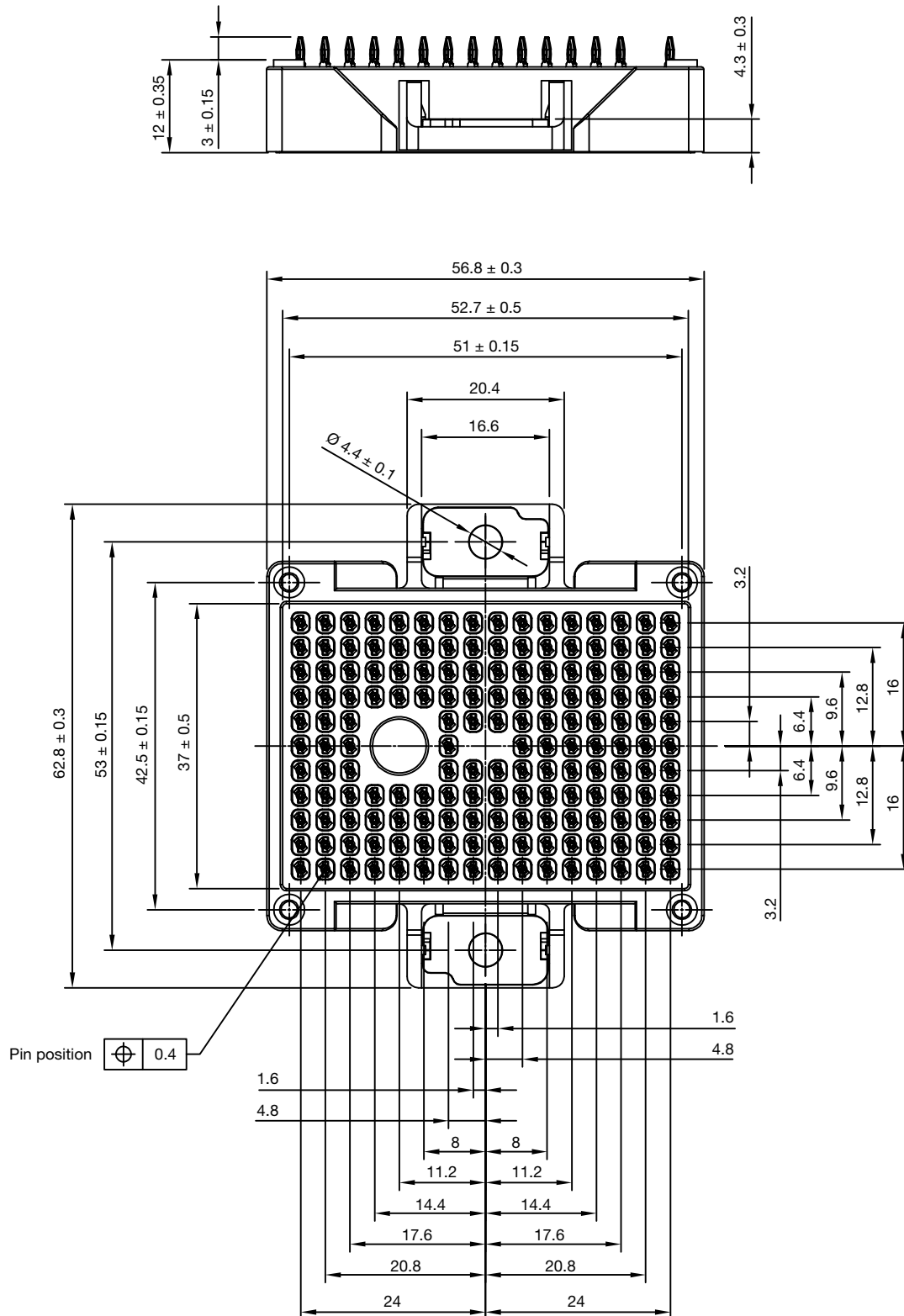



Disclaimer

ALL PRODUCT, PRODUCT SPECIFICATIONS AND DATA ARE SUBJECT TO CHANGE WITHOUT NOTICE TO IMPROVE RELIABILITY, FUNCTION OR DESIGN OR OTHERWISE.

Vishay Intertechnology, Inc., its affiliates, agents, and employees, and all persons acting on its or their behalf (collectively, "Vishay"), disclaim any and all liability for any errors, inaccuracies or incompleteness contained in any datasheet or in any other disclosure relating to any product.

Vishay makes no warranty, representation or guarantee regarding the suitability of the products for any particular purpose or the continuing production of any product. To the maximum extent permitted by applicable law, Vishay disclaims (i) any and all liability arising out of the application or use of any product, (ii) any and all liability, including without limitation special, consequential or incidental damages, and (iii) any and all implied warranties, including warranties of fitness for particular purpose, non-infringement and merchantability.

Statements regarding the suitability of products for certain types of applications are based on Vishay's knowledge of typical requirements that are often placed on Vishay products in generic applications. Such statements are not binding statements about the suitability of products for a particular application. It is the customer's responsibility to validate that a particular product with the properties described in the product specification is suitable for use in a particular application. Parameters provided in datasheets and / or specifications may vary in different applications and performance may vary over time. All operating parameters, including typical parameters, must be validated for each customer application by the customer's technical experts. Product specifications do not expand or otherwise modify Vishay's terms and conditions of purchase, including but not limited to the warranty expressed therein.

Except as expressly indicated in writing, Vishay products are not designed for use in medical, life-saving, or life-sustaining applications or for any other application in which the failure of the Vishay product could result in personal injury or death. Customers using or selling Vishay products not expressly indicated for use in such applications do so at their own risk. Please contact authorized Vishay personnel to obtain written terms and conditions regarding products designed for such applications.

No license, express or implied, by estoppel or otherwise, to any intellectual property rights is granted by this document or by any conduct of Vishay. Product names and markings noted herein may be trademarks of their respective owners.