

DV 5212 N

DC diagonal compact fan

sickle-shaped blades (S series)



ebm-papst St. Georgen GmbH & Co. KG

Hermann-Papst-Str. 1

D-78112 St. Georgen

Phone +49 (0) 7724 81-0

Fax +49 (0) 7724 81-1309

info2@de.ebmpapst.com

www.ebmpapst.com

Nominal data

Type	DV 5212 N	
Nominal voltage	VDC	12
Nominal voltage range	VDC	9 .. 15
Speed (rpm)	min ⁻¹	5000
Power consumption	W	21.0
Min. ambient temperature	°C	-20
Max. ambient temperature	°C	65
Air flow	m ³ /h	270
Sound power level	B	6.4
Sound pressure level	dB(A)	56

ml = Max. load · me = Max. efficiency · fa = Free air · cs = Customer specification · ce = Customer equipment
Subject to change



Technical description

General description	* Power consumption when wide open; these values may be considerably higher at the operating point.
Housing material	Glass-fiber reinforced PBT plastic
Impeller material	Glass-fiber reinforced PA plastic
Weight	0.415 kg
Dimensions	127 x 127 x 38 mm
Airflow direction	Exhaust over struts
Direction of rotation	Counterclockwise, viewed toward rotor
Storage	Ball bearing
Service life L10 at 40 °C	70000 h
Service life L10 at maximum temperature	40000 h
Cable	Leads AWG 22, TR 64, stripped and tin-plated.
Motor protection	Protection against reverse polarity and blocked rotor.
Locked-rotor protection	With electronic locked-rotor and overload protection
Approval	VDE, CSA, UL, CE
Option	Speed signal

DV 5212 N

DC diagonal compact fan

sickle-shaped blades (S series)

Product drawing

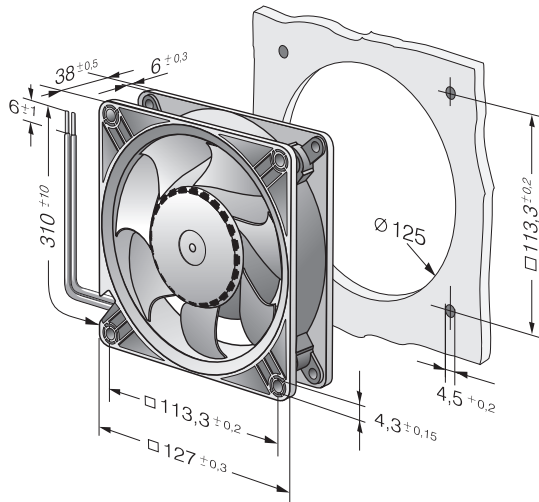

Curves: Air performance

