

# AMPHENOL PART NUMBER CONFIGURATION

U95-Z105-XXX1-3X1

### CAGE & CONNECTOR CONTACT PLATING

4 = 0.76 µm MIN. GOLD OVER 1.27-3.81 µm OF NICKEL ON MATING AREA  
 0.381-1.52 µm OF MATTE TIN OVER 1.27-3.81 µm OF NICKEL ON PRESS FIT TAIL AREA.  
 Ni PLATING FOR CAGE  
 (RoHS COMPLIANT PER RoHS DIRECTIVE 2011/65/EU)

### OPTIONAL DUST COVER

0 = WITHOUT DUST COVER  
 D = WITH DUST COVER

### VENT HOLES AND EMI COVER

0 = WITH LARGE VENT HOLES & WITH EMI COVER  
 2 = WITH SMALL VENT HOLES & WITH EMI COVER  
 4 = WITH RECTANGULAR VENT HOLES & WITH EMI COVER

### EMI FINGERS

3 = THROUGH THE BEZEL

### OPTIONAL LIGHT PIPES

6 = WITH LIGHT PIPE (TRIANGULAR OUTLET)  
 LEFT ARROW POINTING BOTTOM PORT &  
 RIGHT ARROW POINTING TOP PORT  
 7 = WITHOUT LIGHT PIPE  
 8 = WITH LIGHT PIPE (REVERSED DIRECTION)  
 LEFT ARROW POINTING TOP PORT &  
 RIGHT ARROW POINTING BOTTOM PORT

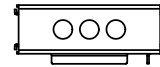
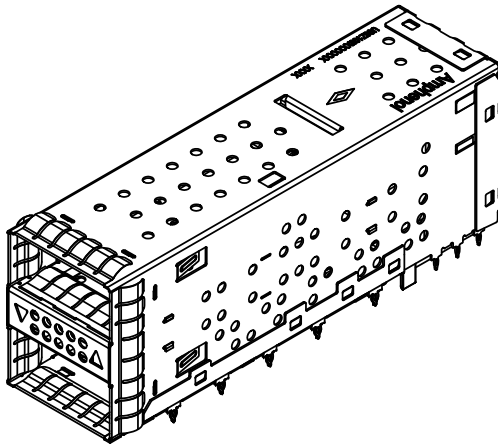

VENT HOLE FOR PART NUMBER  
 U95-Z105-XX71-301

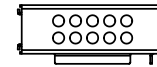

VENT HOLE FOR PART NUMBER  
 U95-Z105-XX71-321

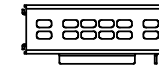

VENT HOLE FOR PART NUMBER  
 U95-Z105-XX71-341

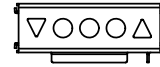

VENT HOLE FOR PART NUMBER  
 U95-Z105-XX61-301

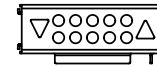

VENT HOLE FOR PART NUMBER  
 U95-Z105-XX61-321

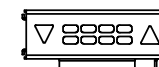

VENT HOLE FOR PART NUMBER  
 U95-Z105-XX61-341

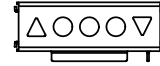

VENT HOLE FOR PART NUMBER  
 U95-Z105-XX81-301

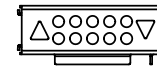

VENT HOLE FOR PART NUMBER  
 U95-Z105-XX81-321



VENT HOLE FOR PART NUMBER  
 U95-Z105-XX81-341

### NOTES:

- MATERIAL  
 CAGE-PRESS FIT: COPPER ALLOY, NICKEL PLATED  
 CONNECTOR-PRESS FIT: PLASTIC HOUSING, FLAMMABILITY RATING UL94 V-0.  
 CONTACTS: PHOSPHOR BRONZE  
 PLATING OPTION: SEE AMPHENOL PART ON CONFIGURATION  
 EMI FINGERS: PHOSPHOR BRONZE WITH NICKEL PLATING  
 LIGHT PIPE: GE LEXAN, OPTICAL GRADE  
 DUST COVER (IF ORDERED) SHIPPED LOOSE



UNLESS SPECIFIED OTHERWISE	DRAWN	Alvin C	APR 18/13
PRIMARY UNITS MILLIMETERS	CHECKED	ZLJ	APR 18/13
SECONDARY MILLIMETERS	M.E. APP'D		
REFERENCE IN PARENTHESES	Q.A. APP'D		
GENERAL TOLERANCES	DWG APP'D		
1 DECIMAL PLACE ±0.25	ENG. REL. NO.		
2 DECIMAL PLACES ±0.15	REF.		
ANGULAR DEGREES ±0.5°	THIRD ANGLE PROJECTION		

<b>Amphenol High Speed Interconnects</b> A Division of Amphenol Corp. <a href="http://www.amphenol-highspeed.com">www.amphenol-highspeed.com</a>			
UltraPort QSFP+ 2X1 STACKED COMBO THROUGH BEZEL 4X25G			
DWG. NO.			REV
P-U95-Z105-XXX1-3X1			H
CODE ID NO.	03554	DWG SIZE: C	SCALE: 1:1 SHEET 1 OF 4

REVISIONS			
REV	DESCRIPTION, ECN, EAR NO.	DATE	APP'D
F	True position tolerance changed plus x-hatch on PCB removed	NOV 11/15	JS
G	Front & Rear EMI pin position added	AUG 29/16	JS
H	Pinout info added	APR 26/17	JS

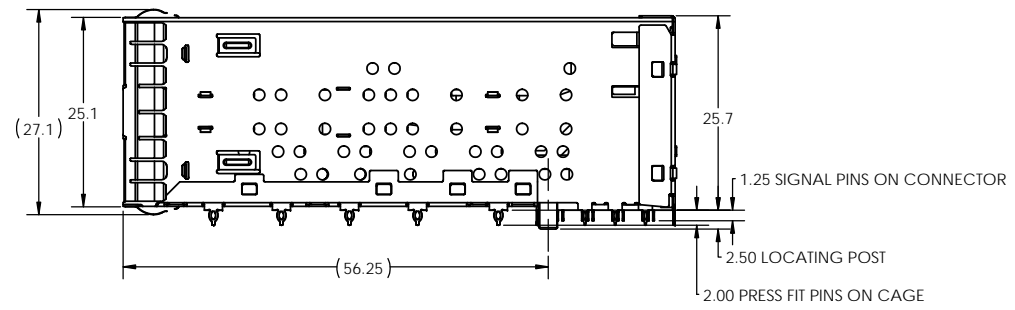
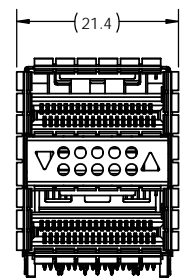
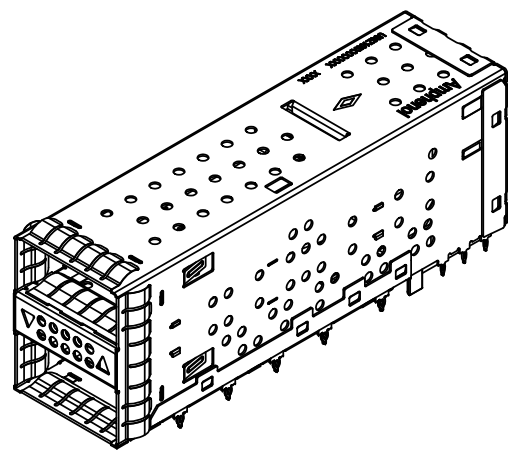
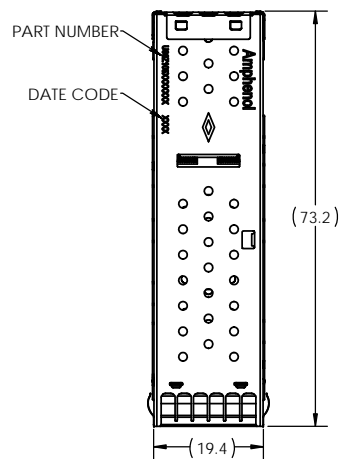

THIS DOCUMENT CONTAINS PROPRIETARY INFORMATION AND SUCH INFORMATION MAY NOT BE DISCLOSED TO OTHERS FOR ANY PURPOSE OR USED FOR MANUFACTURING PURPOSES WITHOUT WRITTEN PERMISSION FROM AMPHENOL CANADA CORP.

UNLESS SPECIFIED OTHERWISE	DRAWN	Alvin C	APR 18/13
PRIMARY UNITS MILLIMETERS	CHECKED	ZLJ	APR 18/13
SECONDARY MILLIMETERS	M.E. APP'D		
REFERENCE IN PARENTHESES	Q.A. APP'D		
GENERAL TOLERANCES	DWG APP'D		
1 DECIMAL PLACE ±0.25	ENG. REL. NO.		
2 DECIMAL PLACES ±0.15	REF.		
ANGULAR DEGREES ±0.5°	THIRD ANGLE PROJECTION		
	DO NOT SCALE DRAWING		

**Amphenol High Speed Interconnects**  
 A Division of Amphenol Corp. [www.amphenol-highspeed.com](http://www.amphenol-highspeed.com)

**UltraPort QSFP+ 2X1  
 STACKED COMBO  
 THROUGH BEZEL  
 4X25G**

DWG. NO. **P-U95-Z105-XXX1-3X1** REV **H**

CODE ID NO. 03554 DWG SIZE: C SCALE: 1:1 SHEET 2 OF 4

REVISIONS			
REV	DESCRIPTION, ECN, EAR NO.	DATE	APP'D
F	True position tolerance changed plus x-hatch on PCB removed	NOV 11/15	JS
G	Front & Rear EMI pin position added	AUG 29/16	JS
H	Pinout info added	APR 26/17	JS

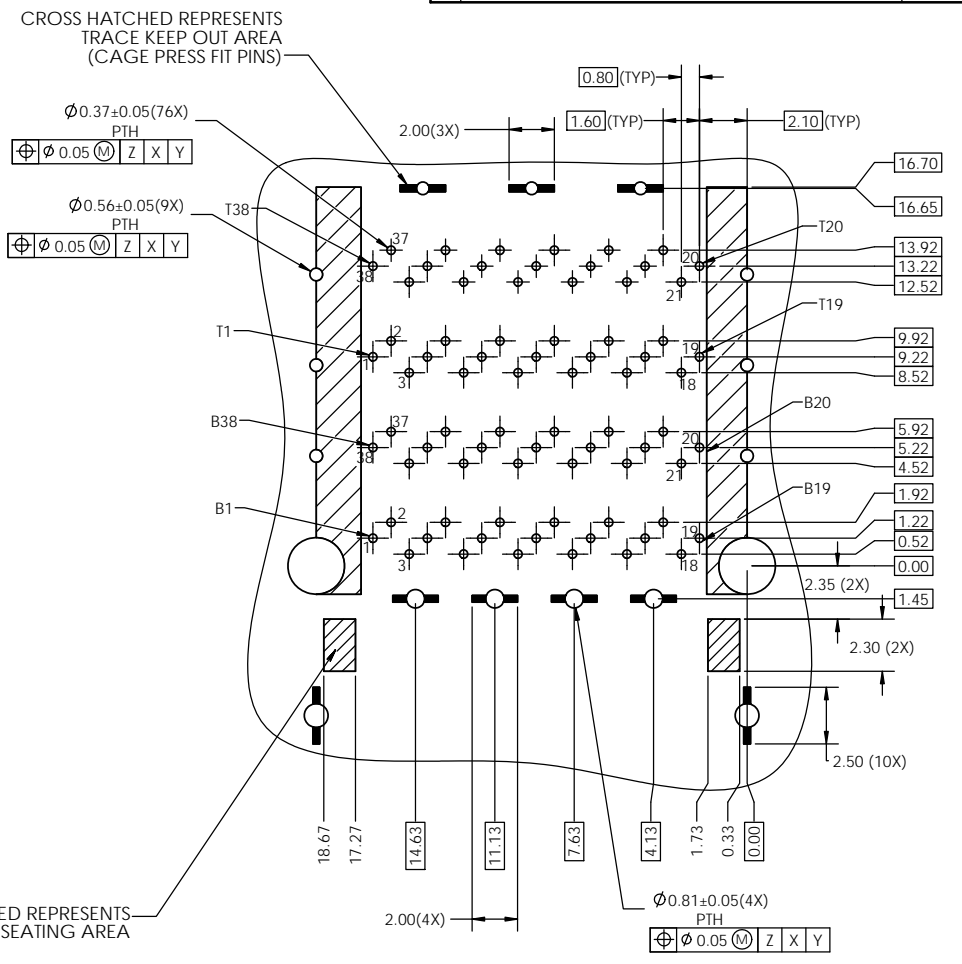
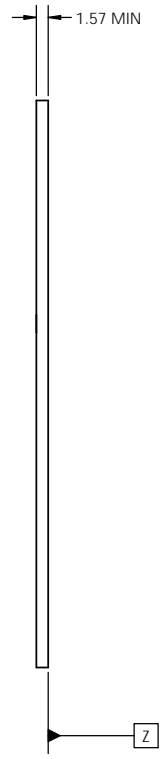
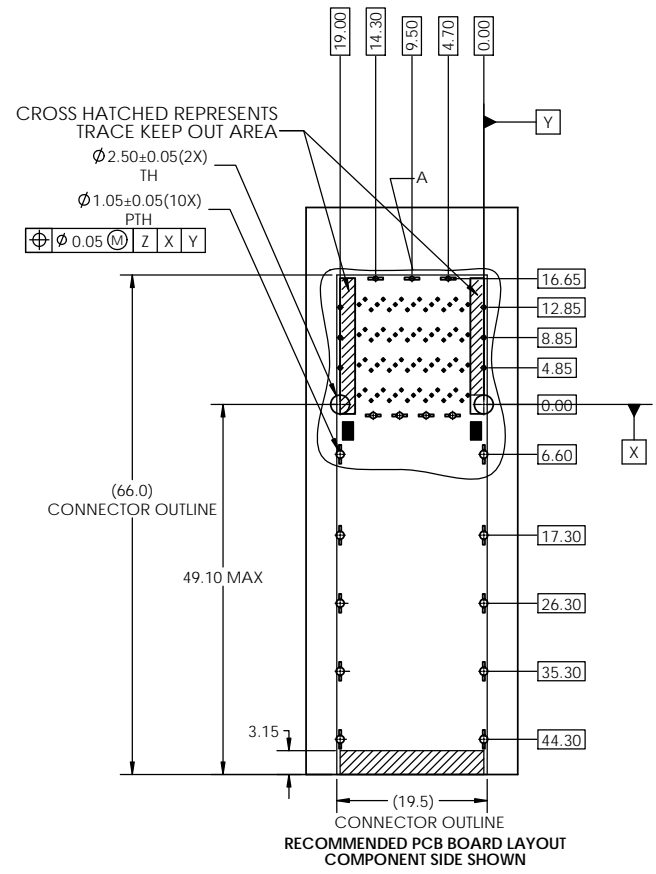

DETAIL A  
SCALE 6:1

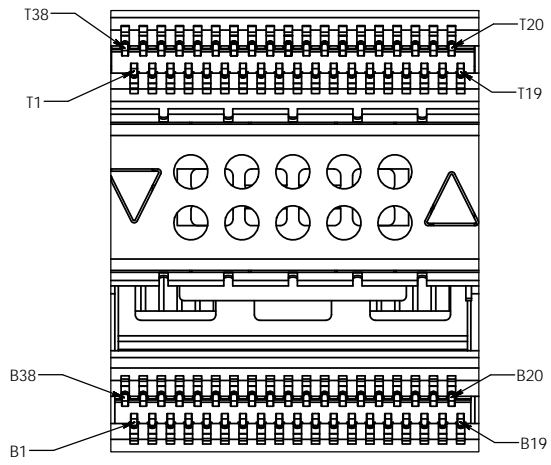

UNLESS SPECIFIED OTHERWISE	DRAWN	Alvin C	APR 18/13
PRIMARY UNITS MILLIMETERS	CHECKED	ZLJ	APR 18/13
SECONDARY MILLIMETERS	M.E. APP'D		
REFERENCE IN PARENTHESES	Q.A. APP'D		
GENERAL TOLERANCES	DWG APP'D		
1 DECIMAL PLACE ±0.25	ENG. REL. NO.		
2 DECIMAL PLACES ±0.15	REF.		
ANGULAR DEGREES ±0.5°	THIRD ANGLE PROJECTION		
	DO NOT SCALE DRAWING		

**Amphenol High Speed Interconnects**  
A Division of Amphenol Corp. [www.amphenol-highspeed.com](http://www.amphenol-highspeed.com)

**UltraPort QSFP+ 2X1 STACKED COMBO THROUGH BEZEL 4X25G**

DWG. NO. **P-U95-Z105-XXX1-3X1** REV **H**

CODE ID NO. 03554 DWG SIZE: C SCALE: 2:1 SHEET 3 OF 4

REVISIONS			
REV	DESCRIPTION, ECN, EAR NO.	DATE	APP'D
F	True position tolerance changed plus x-hatch on PCB removed	NOV 11/15	JS
G	Front & Rear EMI pin position added	AUG 29/16	JS
H	Pinout info added	APR 26/17	JS

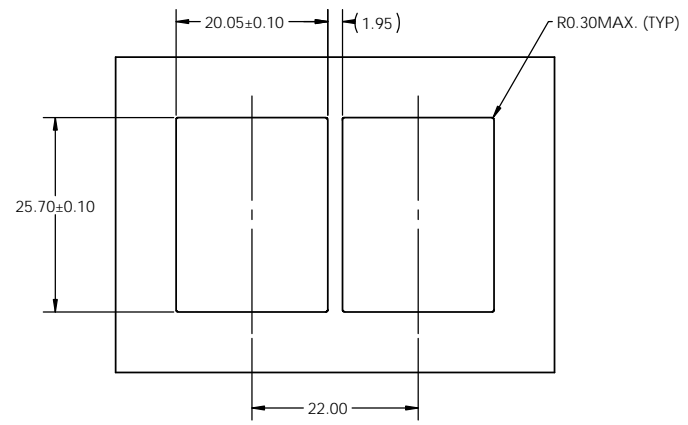
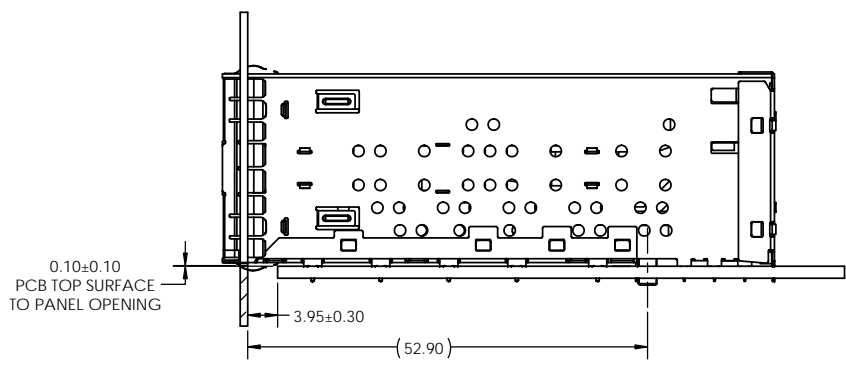

UNLESS SPECIFIED OTHERWISE	DRAWN	Alvin C	APR 18/13
PRIMARY UNITS MILLIMETERS	CHECKED	ZLJ	APR 18/13
SECONDARY MILLIMETERS	M.E. APP'D		
REFERENCE IN PARENTHESES	Q.A. APP'D		
GENERAL TOLERANCES	DWG APP'D		
1 DECIMAL PLACE ±0.25	ENG. REL. NO.		
2 DECIMAL PLACES ±0.15	REF.		
ANGULAR DEGREES ±0.5°	THIRD ANGLE PROJECTION		DO NOT SCALE DRAWING

**Amphenol High Speed Interconnects**  
A Division of Amphenol Corp. [www.amphenol-highspeed.com](http://www.amphenol-highspeed.com)

**UltraPort QSFP+ 2X1  
STACKED COMBO  
THROUGH BEZEL  
4X25G**

DWG. NO. **P-U95-Z105-XXX1-3X1** REV **H**

CODE ID NO. 03554 DWG SIZE: C SCALE: 1:1 SHEET 4 OF 4

THIS DOCUMENT CONTAINS PROPRIETARY INFORMATION AND SUCH INFORMATION MAY NOT BE DISCLOSED TO OTHERS FOR ANY PURPOSE OR USED FOR MANUFACTURING PURPOSES WITHOUT WRITTEN PERMISSION FROM AMPHENOL CANADA CORP.