

Description

The AH3360 is a high sensitivity micropower Unipolar Hall effect switch IC with internal pull up and pull down capability. Designed for battery powered consumer such as cellular phones and portable PCs to home appliance and industrial equipment, the average supply current is only 4.3uA at 1.85V. To support portable equipment the AH3360 can operate over the supply range of 1.6V to 3.6V and uses a hibernating clocking system to minimize the power consumption. To minimize PCB space the AH3360 is available in small low profile SOT553, X1-DFN1216-4 and X2-DFN2015-6 and packages.

The output is activated with a south pole of sufficient magnetic field strength. When the magnetic flux density (B) perpendicular to the package is larger than operate point (Bop), the output will be turned on (pulled low) and held until B is lower than release point (Brp). The output will remain off when there is no magnetic field.

Features

- Unipolar Operation (South pole to part marking side)
- Supply Voltage of 1.6V to 3.6V
- High Sensitivity
- Micropower Operation
- Chopper Stabilized Design Provides:
 - Superior Temperature Stability
 - Minimal Switch Point Drift
 - Enhanced Immunity to Physical Stress
- No External Pull-up Resistors Required
- Good RF Noise Immunity
- -40°C to +85°C Operating Temperature
- High ESD capability of 8kV Human Body Model
- Small Low Profile X1-DFN1216-4, X2-DFN2015-6 and SOT553 Packages
- **Totally Lead-Free & Fully RoHS Compliant (Notes 1 & 2)**
- **Halogen and Antimony Free. "Green" Device (Note 3)**

- Notes:
1. No purposely added lead. Fully EU Directive 2002/95/EC (RoHS) & 2011/65/EU (RoHS 2) compliant.
 2. See http://www.diodes.com/quality/lead_free.html for more information about Diodes Incorporated's definitions of Halogen- and Antimony-free, "Green" and Lead-free.
 3. Halogen- and Antimony-free "Green" products are defined as those which contain <900ppm bromine, <900ppm chlorine (<1500ppm total Br + Cl) and <1000ppm antimony compounds.

Typical Applications Circuit

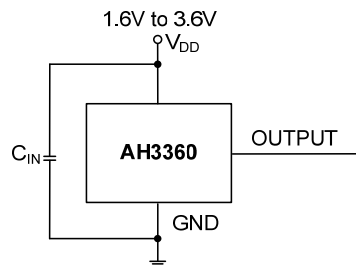

- Note: 4. C_{IN} is for power stabilization and to strengthen the noise immunity, the recommended capacitance is 100nF typical.

Pin Assignments

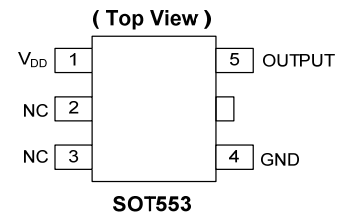
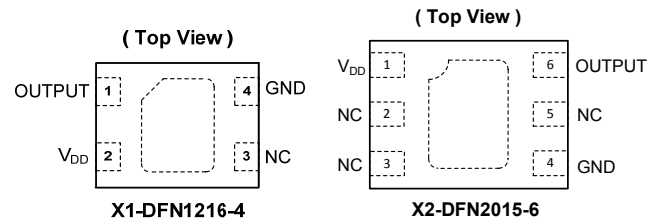

Applications

- Open and Close Detect for Cellular Phones
- Holster or Cover Detect for Cellular Phones and Tablet PCs
- Cover or Display Switch in Portable PCs
- Digital Still, Video Cameras and Handheld Gaming Consoles
- Docking Station Detect
- Door, Lids and Tray Position Switches
- Level, Proximity and Position Switches
- Contact-Less Switches in Home Appliances and Industrial Applications

Pin Descriptions

Package: X1-DFN1216-4

| Pin Number | Pin Name | Function |
|------------|-----------------|------------------------|
| 1 | OUTPUT | Output Pin |
| 2 | V _{DD} | Power Supply Input |
| 3 | NC | No Connection (Note 5) |
| 4 | GND | Ground Pin |

Package: X2-DFN2015-6

| Pin Number | Pin Name | Function |
|------------|-----------------|------------------------|
| 1 | V _{DD} | Power Supply Input |
| 2 | NC | No Connection (Note 5) |
| 3 | NC | No Connection (Note 5) |
| 4 | GND | Ground Pin |
| 5 | NC | No Connection (Note 5) |
| 6 | OUTPUT | Output Pin |

Package: SOT553

| Pin Number | Pin Name | Function |
|------------|-----------------|------------------------|
| 1 | V _{DD} | Power Supply Input |
| 2 | NC | No Connection (Note 5) |
| 3 | NC | No Connection (Note 5) |
| 4 | GND | Ground Pin |
| 5 | OUTPUT | Output Pin |

Note: 5. NC is "No Connection" pin and is not connected internally. This pin can be left open or tied to ground.

Functional Block Diagram

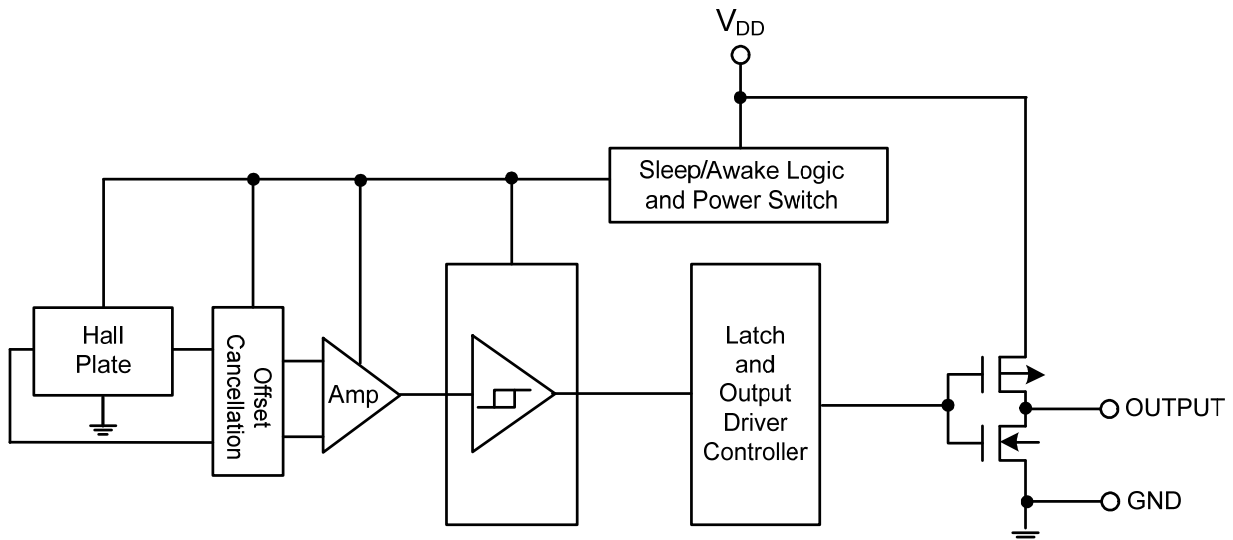

Absolute Maximum Ratings (Note 6) (@ $T_A = +25^\circ\text{C}$, unless otherwise specified.)

| Symbol | Parameter | Rating | Unit | |
|---------------|---------------------------------------|----------------------------|------------------|----|
| V_{DD} | Supply Voltage (Note 7) | 6 | V | |
| V_{DD_REV} | Reverse Supply Voltage | -0.3 | V | |
| I_{OUTPUT} | Output Current (source and sink) | 3 | mA | |
| B | Magnetic Flux Density | Unlimited | | |
| P_D | Package Power Dissipation | X1-DFN1216-4, X2-DFN2015-6 | 230 | mW |
| | | SOT553 | 230 | mW |
| T_s | Storage Temperature Range | -65 to +150 | $^\circ\text{C}$ | |
| T_J | Maximum Junction Temperature | 150 | $^\circ\text{C}$ | |
| ESD HBM | Human Body Model (HBM) ESD Capability | 8 | kV | |

- Notes:
- Stresses greater than the 'Absolute Maximum Ratings' specified above may cause permanent damage to the device. These are stress ratings only; functional operation of the device at these or any other conditions exceeding those indicated in this specification is not implied. Device reliability may be affected by exposure to absolute maximum rating conditions for extended periods of time.
 - The absolute maximum V_{DD} of 6V is a transient stress rating and is not meant as a functional operating condition. It is not recommended to operate the device at the absolute maximum rated conditions for any period of time.

Recommended Operating Conditions (@ $T_A = +25^\circ\text{C}$, unless otherwise specified.)

| Symbol | Parameter | Conditions | Rating | Unit |
|----------|-----------------------------|------------|--------------|------------------|
| V_{DD} | Supply Voltage | Operating | 1.6V to 3.6V | V |
| T_A | Operating Temperature Range | Operating | -40 to +85 | $^\circ\text{C}$ |

Electrical Characteristics (@ $T_A = +25^\circ\text{C}$, $V_{DD} = 1.85\text{V}$, unless otherwise specified.)

| Symbol | Parameter | Conditions | Min | Typ | Max | Unit |
|------------------------|---------------------------|--|----------------|----------------|-----|---------------|
| V_{OL} | Output Low Voltage (on) | $I_{OUT} = 1\text{mA}$ | — | 0.1 | 0.2 | V |
| V_{OH} | Output High Voltage (off) | $I_{OUT} = -1\text{mA}$ | $V_{DD} - 0.2$ | $V_{DD} - 0.1$ | — | V |
| I_{off} | Output Leakage Current | $V_{OUT} = 3.6\text{V}$, Output off | — | < 0.1 | 1 | μA |
| $I_{DD}(\text{awake})$ | Supply Current | During 'awake' period, $T_A = +25^\circ\text{C}$, $V_{DD} = 3\text{V}$ | — | 2.1 | — | mA |
| $I_{DD}(\text{sleep})$ | | During 'sleep' period, $T_A = +25^\circ\text{C}$, $V_{DD} = 3\text{V}$ | — | 2.5 | — | mA |
| $I_{DD}(\text{avg})$ | Average Supply Current | $T_A = +25^\circ\text{C}$, $V_{DD} = 1.85\text{V}$ | — | 4.3 | 8 | μA |
| | | $T_A = +25^\circ\text{C}$, $V_{DD} = 3.6\text{V}$ | — | 7.2 | 13 | μA |
| T_{awake} | Awake Time | (Note 8) | — | 50 | 100 | μs |
| T_{period} | Period | (Note 8) | — | 50 | 100 | ms |
| D.C. | Duty Cycle | | — | 0.1 | — | % |

- Notes:
- When power is initially turned on, the operating V_{DD} (1.6V to 3.6V) must be applied to guaranteed the output sampling. The output state is valid after the second operating cycle (typical 100ms).

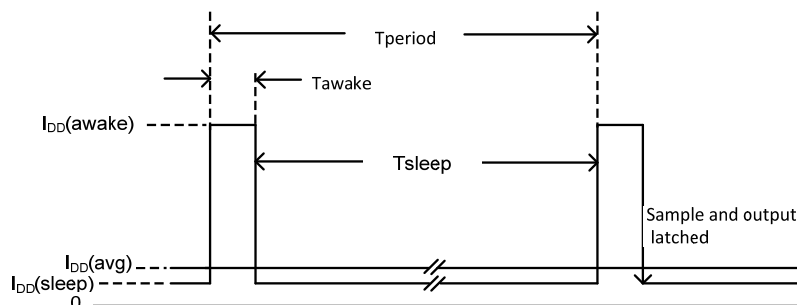

Magnetic Characteristics (Note 9 & 10) ($T_A = 25^\circ\text{C}$, $V_{DD} = 1.85\text{V}$, unless otherwise specified)

(1mT=10 Gauss)

| Symbol | Characteristics | Test Condition | Min | Typ | Max | Unit |
|--|----------------------|--|-----|-----|-----|-------|
| Bops (south pole to part marking side) | Operation Point | $T_A = +25^\circ\text{C}$ | 16 | 30 | 42 | Gauss |
| | | $T_A = -40^\circ\text{C}$ to $+85^\circ\text{C}$ | 14 | 30 | 46 | |
| Brps (south pole to part marking side) | Release Point | $T_A = +25^\circ\text{C}$ | 11 | 20 | 35 | |
| | | $T_A = -40^\circ\text{C}$ to $+85^\circ\text{C}$ | 9 | 20 | 39 | |
| Bhy ($ B_{opx} - B_{rpx} $) | Hysteresis (Note 11) | $T_A = +25^\circ\text{C}$ | 5 | 10 | 15 | |
| | | $T_A = -40^\circ\text{C}$ to $+85^\circ\text{C}$ | 3 | 10 | 17 | |

- Notes:
- Typical data is at $T_A = +25^\circ\text{C}$, $V_{DD} = 1.85\text{V}$.
 - Maximum and minimum parameters values over operating temperature range are not tested in production, they are guaranteed by design, process control and characterization. The magnetic characteristics may vary with supply voltage, operating temperature and after soldering.
 - Maximum and minimum hysteresis is guaranteed by design and characterization.

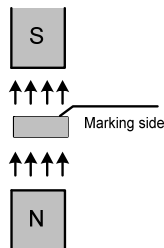
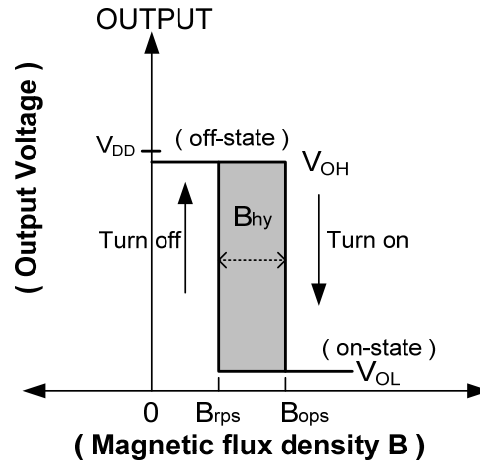

(X1-DFN1216-4 and X2-DFN2015-6)

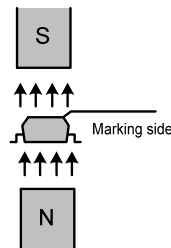

(SOT553)

Typical Operating Characteristics

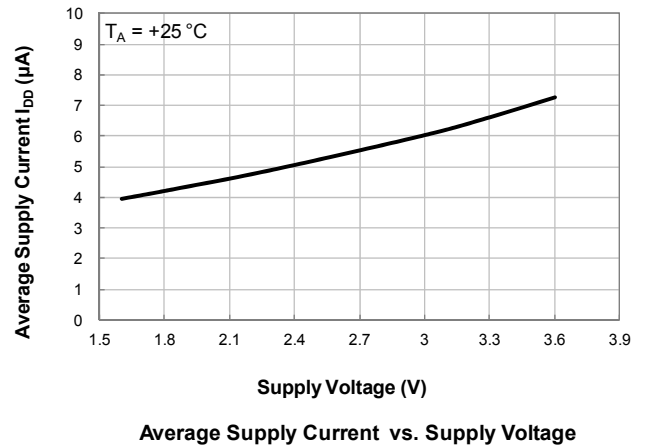
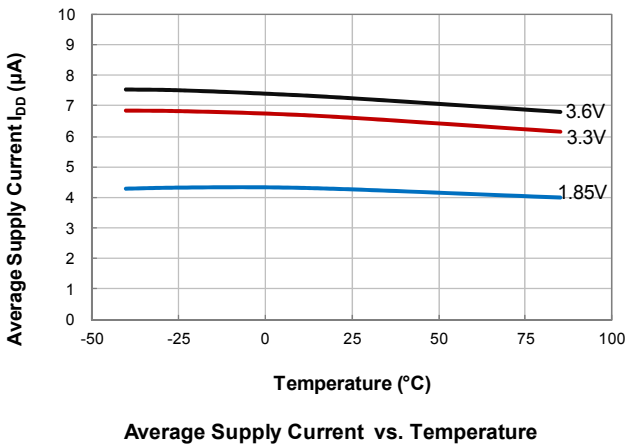
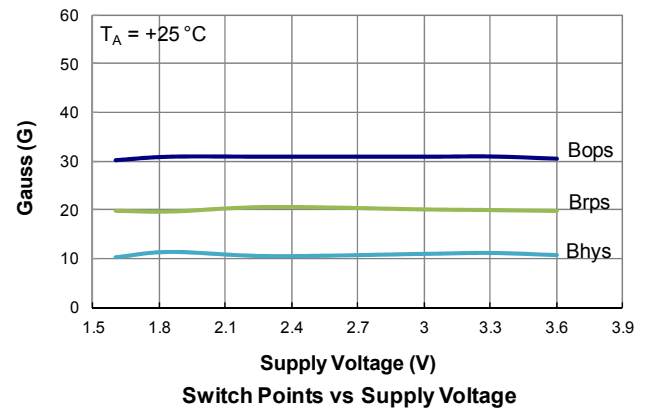
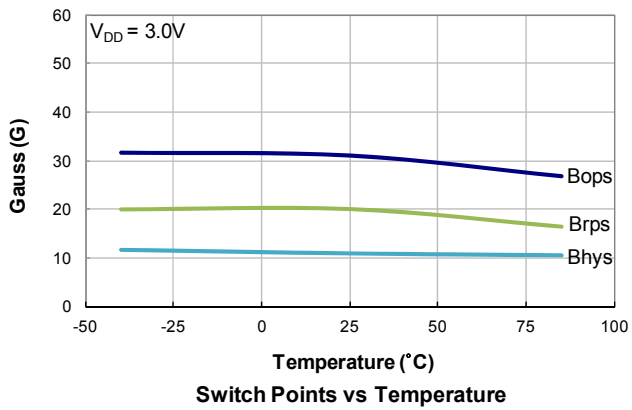
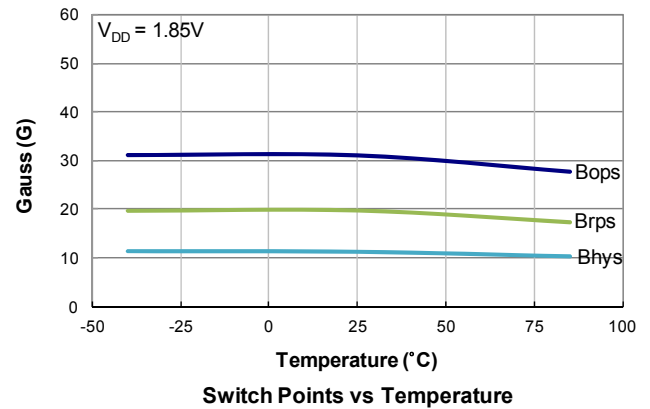
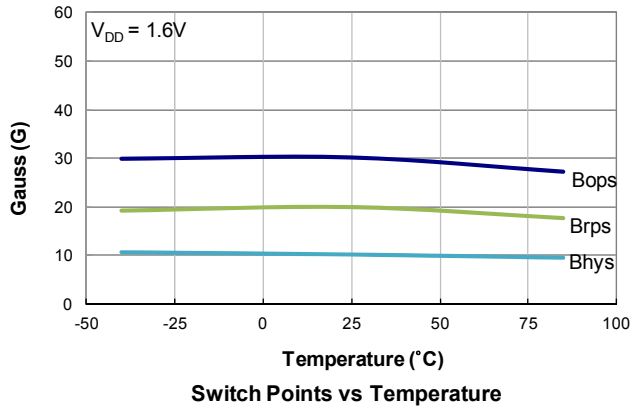

Ordering Information

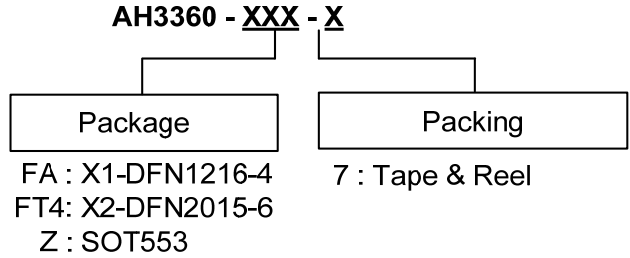

| Part Number | Package Code | Packaging | 7" Tape and Reel | |
|--------------|--------------|--------------|------------------|--------------------|
| | | | Quantity | Part Number Suffix |
| AH3360-FA-7 | FA | X1-DFN1216-4 | 3000/Tape & Reel | -7 |
| AH3360-FT4-7 | FT4 | X2-DFN2015-6 | 3000/Tape & Reel | -7 |
| AH3360-Z-7 | Z | SOT553 | 3000/Tape & Reel | -7 |

Marking Information

(1) Package Type: X1-DFN1216-4 and X2-DFN2015-6

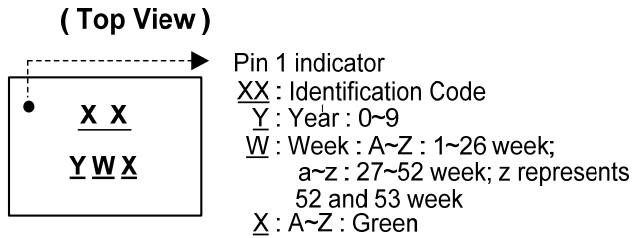

| Part Number | Package | Identification Code |
|--------------|--------------|---------------------|
| AH3360-FA-7 | X1-DFN1216-4 | KZ |
| AH3360-FT4-7 | X2-DFN2015-6 | NZ |

(2) Package Type: SOT553

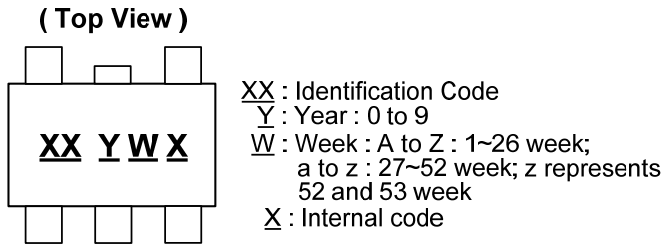

| Part Number | Package | Identification Code |
|-------------|---------|---------------------|
| AH3360-Z-7 | SOT553 | KZ |

Package Outline Dimensions (All dimensions in mm.)

Please see AP02002 at <http://www.diodes.com/datasheets/ap02002.pdf> for latest version.

(1) Package Type: X1-DFN1216-4

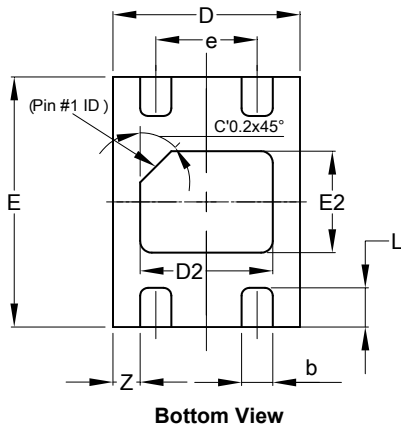
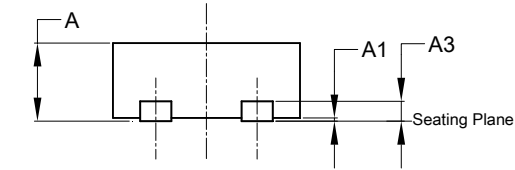

| X1-DFN1216-4 | | | |
|----------------------|------|------|-------|
| Dim | Min | Max | Typ |
| A | 0.47 | 0.53 | 0.50 |
| A1 | 0.00 | 0.05 | 0.02 |
| A3 | -- | -- | 0.13 |
| b | 0.15 | 0.25 | 0.20 |
| D | 1.15 | 1.25 | 1.20 |
| D2 | 0.75 | 0.95 | 0.85 |
| E | 1.55 | 1.65 | 1.60 |
| E2 | 0.55 | 0.75 | 0.65 |
| e | - | - | 0.65 |
| L | 0.20 | 0.30 | 0.25 |
| Z | - | - | 0.175 |
| All Dimensions in mm | | | |

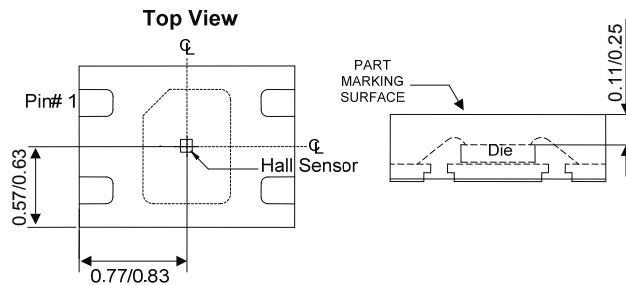

Sensor Location

NEW PRODUCT

Package Outline Dimensions (cont.) (All dimensions in mm.)

Please see AP02002 at <http://www.diodes.com/datasheets/ap02002.pdf> for latest version.

(2) Package Type: X2-DFN2015-6

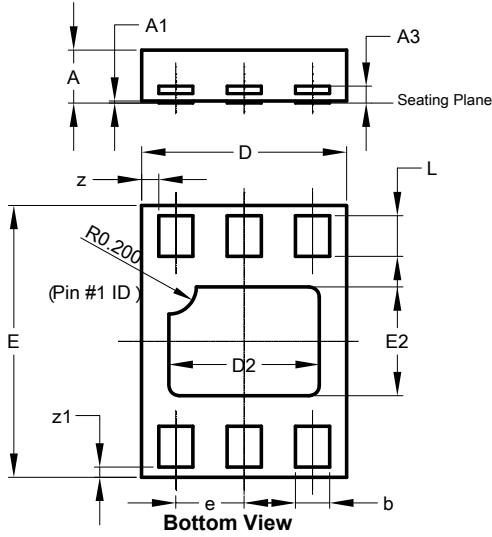

| X2-DFN2015-6 | | | |
|----------------------|-------|-------|-------|
| Dim | Min | Max | Typ |
| A | 0.375 | 0.40 | 0.390 |
| A1 | 0 | 0.05 | 0.02 |
| A3 | - | - | 0.13 |
| b | 0.20 | 0.30 | 0.25 |
| D | 1.45 | 1.575 | 1.50 |
| D2 | 1.00 | 1.20 | 1.10 |
| e | - | - | 0.50 |
| E | 1.95 | 2.075 | 2.00 |
| E2 | 0.70 | 0.90 | 0.80 |
| L | 0.25 | 0.35 | 0.30 |
| Z | - | - | 0.125 |
| Z1 | - | - | 0.075 |
| All Dimensions in mm | | | |

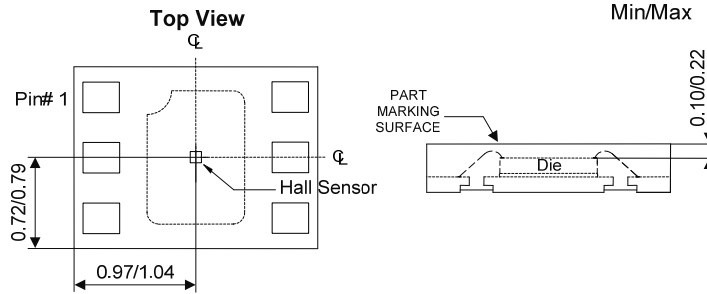

Sensor Location

NEW PRODUCT

Package Outline Dimensions (cont.) (All dimensions in mm.)

Please see AP02002 at <http://www.diodes.com/datasheets/ap02002.pdf> for latest version.

(3) Package Type: SOT553

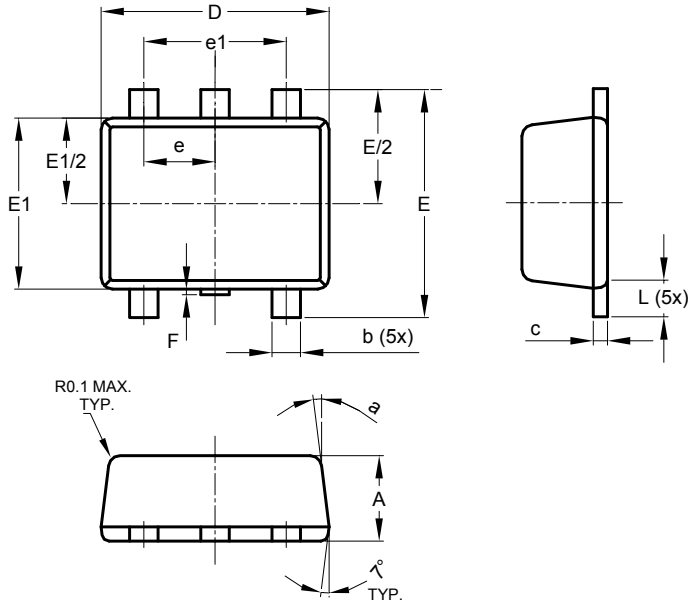

| SOT553 | | | |
|----------------------|----------|------|------|
| Dim | Min | Max | Typ |
| A | 0.55 | 0.62 | 0.60 |
| b | 0.15 | 0.30 | 0.20 |
| c | 0.10 | 0.18 | 0.15 |
| D | 1.50 | 1.70 | 1.60 |
| E | 1.55 | 1.70 | 1.60 |
| E1 | 1.10 | 1.25 | 1.20 |
| e | 0.50 BSC | | |
| e1 | 1.00 BSC | | |
| F | 0.00 | 0.10 | — |
| L | 0.10 | 0.30 | 0.20 |
| a | 6° | 8° | 7° |
| All Dimensions in mm | | | |

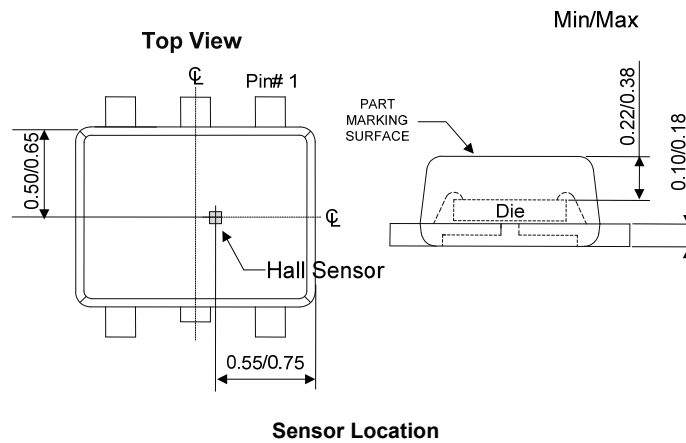

Suggested Pad Layout

Please see AP02001 at <http://www.diodes.com/datasheets/ap02001.pdf> for the latest version.

(1) Package Type: X1-DFN1216-4

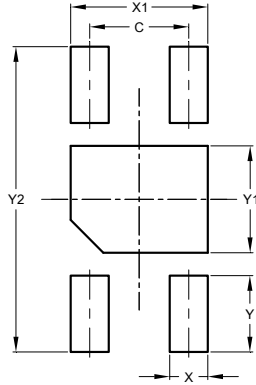

| X1-DFN1216-4 | |
|----------------------|-------|
| Dimensions | Value |
| C | 0.65 |
| X | 0.25 |
| X1 | 0.90 |
| Y | 0.50 |
| Y1 | 0.70 |
| Y2 | 2.00 |
| All Dimensions in mm | |

(2) Package Type: X2-DFN2015-6

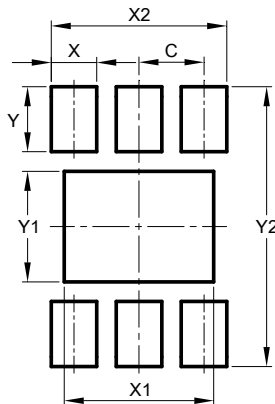

| X2-DFN2015-6 | |
|----------------------|-------|
| Dimensions | Value |
| C | 0.500 |
| X | 0.350 |
| X1 | 1.150 |
| X2 | 1.350 |
| Y | 0.500 |
| Y1 | 0.850 |
| Y2 | 2.150 |
| All Dimensions in mm | |

(3) Package Type: SOT553

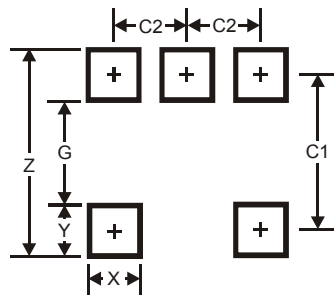

| SOT553 | |
|----------------------|-------|
| Dimensions | Value |
| Z | 2.2 |
| G | 1.2 |
| X | 0.375 |
| Y | 0.5 |
| C1 | 1.7 |
| C2 | 0.5 |
| All Dimensions in mm | |

IMPORTANT NOTICE

DIODES INCORPORATED MAKES NO WARRANTY OF ANY KIND, EXPRESS OR IMPLIED, WITH REGARDS TO THIS DOCUMENT, INCLUDING, BUT NOT LIMITED TO, THE IMPLIED WARRANTIES OF MERCHANTABILITY AND FITNESS FOR A PARTICULAR PURPOSE (AND THEIR EQUIVALENTS UNDER THE LAWS OF ANY JURISDICTION).

Diodes Incorporated and its subsidiaries reserve the right to make modifications, enhancements, improvements, corrections or other changes without further notice to this document and any product described herein. Diodes Incorporated does not assume any liability arising out of the application or use of this document or any product described herein; neither does Diodes Incorporated convey any license under its patent or trademark rights, nor the rights of others. Any Customer or user of this document or products described herein in such applications shall assume all risks of such use and will agree to hold Diodes Incorporated and all the companies whose products are represented on Diodes Incorporated website, harmless against all damages.

Diodes Incorporated does not warrant or accept any liability whatsoever in respect of any products purchased through unauthorized sales channel. Should Customers purchase or use Diodes Incorporated products for any unintended or unauthorized application, Customers shall indemnify and hold Diodes Incorporated and its representatives harmless against all claims, damages, expenses, and attorney fees arising out of, directly or indirectly, any claim of personal injury or death associated with such unintended or unauthorized application.

Products described herein may be covered by one or more United States, international or foreign patents pending. Product names and markings noted herein may also be covered by one or more United States, international or foreign trademarks.

This document is written in English but may be translated into multiple languages for reference. Only the English version of this document is the final and determinative format released by Diodes Incorporated.

LIFE SUPPORT

Diodes Incorporated products are specifically not authorized for use as critical components in life support devices or systems without the express written approval of the Chief Executive Officer of Diodes Incorporated. As used herein:

A. Life support devices or systems are devices or systems which:

1. are intended to implant into the body, or
2. support or sustain life and whose failure to perform when properly used in accordance with instructions for use provided in the labeling can be reasonably expected to result in significant injury to the user.

B. A critical component is any component in a life support device or system whose failure to perform can be reasonably expected to cause the failure of the life support device or to affect its safety or effectiveness.

Customers represent that they have all necessary expertise in the safety and regulatory ramifications of their life support devices or systems, and acknowledge and agree that they are solely responsible for all legal, regulatory and safety-related requirements concerning their products and any use of Diodes Incorporated products in such safety-critical, life support devices or systems, notwithstanding any devices- or systems-related information or support that may be provided by Diodes Incorporated. Further, Customers must fully indemnify Diodes Incorporated and its representatives against any damages arising out of the use of Diodes Incorporated products in such safety-critical, life support devices or systems.

Copyright © 2013, Diodes Incorporated

www.diodes.com