



LUXEON 3535L Color Line

Color LEDs that deliver the perfect amount of color you need.
No more. No less.



The LUXEON 3535L Color Line enables a new era of color lighting. This robust color line provides high performance and is targeted at cost effective designs. Complemented by a broad range of white offerings, the LUXEON 3535L Color Line enables RGBW applications. This product line extends the comprehensive LUXEON Color Family.

FEATURES AND BENEFITS

Industry standard package enables drop-in replacement for existing 3535 packages

Single die and single source architecture for optical control

Common focal length with LUXEON Rebel and LUXEON Z Color LEDs

Full color palette for a wider spectrum range

PRIMARY APPLICATIONS

Architectural & Entertainment

Lamps

– Color Tunable Illumination

Specialty Lighting

– Emergency Vehicle

– Signage

LUXEON 3535L Color Line product performance at 100mA, T_j=25°C.

COLOR	DOMINANT OR PEAK WAVELENGTH ^[1] (nm)		LUMINOUS FLUX ^[2] (lm) OR RADIOMETRIC POWER ^[3] (mW)		PART NUMBER
	MINIMUM	MAXIMUM	MINIMUM	TYPICAL	
Red	620	630	10.0	13.5	L135-R625003500000
Red-Orange	610	620	13.0	15.5	L135-O615003500000
PC Amber	-	-	24.0	35.0	L135-A589003500000
Lime	-	-	44.0	56.0	L135-L567003500000
Green	520	540	21.0	23.0	L135-G525003500000
Blue	469	480	8.2	11.0	L135-B475003500000
Royal Blue	440	455	130	155	L135-U450003500000

Notes:

1. Lumileds maintains a tolerance of ±1nm on dominant wavelength measurements. PC Amber and Lime are binned by chromaticity coordinates. Royal Blue is binned by peak wavelength. All other colors are binned by dominant wavelength.
2. Lumileds maintains a tolerance of ±7.5% on luminous flux measurements.
3. Royal Blue is binned by radiometric power. All other colors are binned by luminous flux.

Mechanical Dimensions.

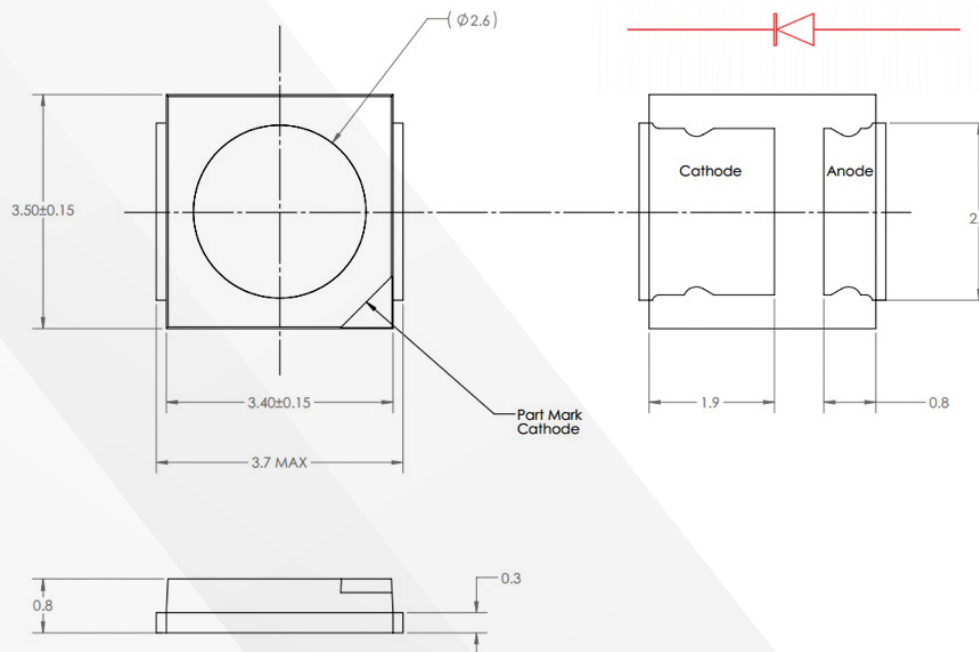

Notes:

1. Drawings are not scale.
2. All dimensions are in millimeters.
3. Tolerance of ±0.1mm for all measurements.