

## Connector - SACC-M12MS-5SC SH - 1512555

Please be informed that the data shown in this PDF Document is generated from our Online Catalog. Please find the complete data in the user's documentation. Our General Terms of Use for Downloads are valid (<http://phoenixcontact.com/download>)



Connector, 5-position, shielded, Plug straight M12, A-coded, Spring-cage connection, knurl material: Nickel-plated brass, external cable diameter 4 mm ... 8 mm

### Why buy this product

- ✓ Safe use in the field, thanks to a high degree of protection
- ✓ Flexible: connectors for on-site assembly
- ✓ Spring-cage connection: connect more securely, even in the case of shock and vibration, thanks to high contact forces
- ✓ Reliable signal transmission - 360° shielding in environments with electromagnetic interference

### Key Commercial Data

Packing unit	1 STK
GTIN	 4 017918 946517
GTIN	4017918946517

### Technical data

#### Dimensions

Wrench size, union nut	13 mm
External cable diameter	4 mm ... 8 mm
Stripping length of the sheath	33 mm
Stripping length of the individual wire	10 mm

#### Ambient conditions

Ambient temperature (operation)	-40 °C ... 85 °C (Plug / socket)
Degree of protection	IP67

#### General

Rated current at 40°C	4 A
Rated voltage	60 V DC
	48 V AC

# Connector - SACC-M12MS-5SC SH - 1512555

## Technical data

### General

Number of positions	5
Insulation resistance	≥ 100 MΩ
Coding	A - standard
Standards/regulations	M12 connector IEC 61076-2-101
	Shock, vibration EN 50155:2001 for conductor cross section of 0.14 mm <sup>2</sup> ... 0.34 mm <sup>2</sup>
Status display	No
Overvoltage category	II
Degree of pollution	3
Connection method	Spring-cage connection
Conductor cross section	0.14 mm <sup>2</sup> ... 0.5 mm <sup>2</sup>
Conductor cross section AWG	26 ... 20
Insertion/withdrawal cycles	≥ 100
Torque	0.4 Nm (M12 knurl)
	0.8 Nm (Connector with coupling sleeve)
	3 Nm (Pressure nut with coupling sleeve)
Assembly instructions	The wires can be connected both with ferrules and without ferrules

### Material

Flammability rating according to UL 94	V0
Contact material	CuSn
Contact surface material	Ni/Au
Contact carrier material	PA 6.6
Material of grip body	Zinc die-cast, nickel-plated
Material, knurls	Nickel-plated brass
Sealing material	NBR

### Standards and Regulations

Standard designation	M12 connector
Standards/regulations	IEC 61076-2-101
Standard designation	Shock, vibration
Standards/regulations	EN 50155:2001
Connection in acc. with standard	CUL
Flammability rating according to UL 94	V0

### Environmental Product Compliance

REACH SVHC	Lead 7439-92-1
China RoHS	Environmentally Friendly Use Period = 50
	For details about hazardous substances go to tab "Downloads", Category "Manufacturer's declaration"

## Drawings

# Connector - SACC-M12MS-5SC SH - 1512555

Schematic diagram

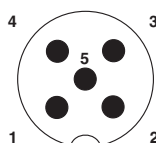

Pin assignment M12 male connector, 5-pos., A-coded, male side

Functional drawing

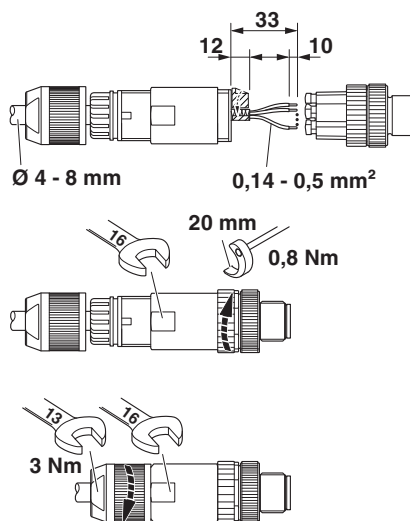

Slide the pressure nut and sleeve housing along the cable, strip the cable, shorten the shield, strip the single wires, connect the wires, in the case of a straight sleeve housing gently twist the wires together, stick the shielding foil around the shortened shield, in the case of a cable outside diameter < 6 mm stick an additional shielding foil around the wire pack, screw the sleeve housing to the plug insert, screw the pressure nut tight.

Dimensional drawing

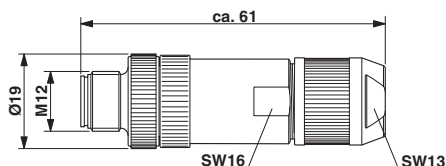

Plug, M12 x 1, straight, shielded

## Approvals

Approvals

Approvals

UL Recognized / cUL Recognized / EAC / EAC / cULus Recognized

Ex Approvals

## Approval details

# Connector - SACC-M12MS-5SC SH - 1512555

## Approvals

UL Recognized		<a href="http://database.ul.com/cgi-bin/XYV/template/LISEXT/1FRAME/index.htm">http://database.ul.com/cgi-bin/XYV/template/LISEXT/1FRAME/index.htm</a>	FILE E 118976
Nominal voltage UN		125 V	
Nominal current IN		4 A	

cUL Recognized		<a href="http://database.ul.com/cgi-bin/XYV/template/LISEXT/1FRAME/index.htm">http://database.ul.com/cgi-bin/XYV/template/LISEXT/1FRAME/index.htm</a>	FILE E 118976
Nominal voltage UN		125 V	
Nominal current IN		4 A	

EAC		EAC-Zulassung
-----	--	---------------

EAC		RU C- DE.AI30.B.01102
-----	---	--------------------------

cULus Recognized		<a href="http://database.ul.com/cgi-bin/XYV/template/LISEXT/1FRAME/index.htm">http://database.ul.com/cgi-bin/XYV/template/LISEXT/1FRAME/index.htm</a>
------------------	---	---

Phoenix Contact 2018 © - all rights reserved  
<http://www.phoenixcontact.com>

PHOENIX CONTACT GmbH & Co. KG  
Flachsmarktstr. 8  
32825 Blomberg  
Germany  
Tel. +49 5235 300  
Fax +49 5235 3 41200  
<http://www.phoenixcontact.com>