

GAAS MMIC SP4T NON-REFLECTIVE SWITCH, DC - 8 GHz

Typical Applications

This switch is suitable for usage in DC - 8.0 GHz 50-Ohm or 75-Ohm systems:

- Broadband
- Fiber Optics
- Switched Filter Banks
- Wireless below 8 GHz

Features

- Broadband Performance: DC - 8 GHz
- High Isolation: 36 dB@ 6 GHz
- Low Insertion Loss: 1.7 dB@ 6 GHz
- Integrated 2:4 TTL Decoder
- 16 Lead 3x3mm QFN Package: 9 mm²

Functional Diagram

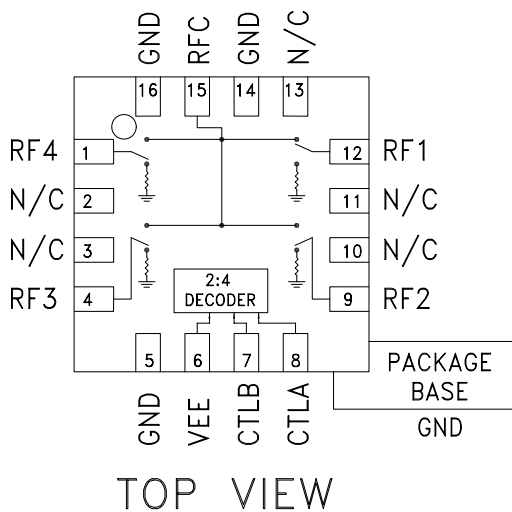

General Description

The HMC344ALP3E is a broadband non-reflective GaAs MESFET SP4T switch in a low cost leadless surface mount packages. Covering DC to 8 GHz, this switch offers high isolation and low insertion loss and extends the frequency coverage of Hittite's SP4T switch product line. This switch also includes an on board binary decoder circuit which reduces the required logic control lines to two. The switch operates using a negative control voltage of 0/-5V, and requires a fixed bias of -5V.

Electrical Specifications, $T_A = +25^\circ \text{C}$, With 0/-5V Control, 50 Ohm System

Parameter	Frequency	Min.	Typ.	Max.	Units	
Insertion Loss	DC - 2.0 GHz		1.4	2.0	dB	
	DC - 6.0 GHz		1.7	2.2	dB	
	DC - 8.0 GHz		2.1	2.5	dB	
Isolation	DC - 2.0 GHz	39	43		dB	
	DC - 4.0 GHz	33	37		dB	
	DC - 6.0 GHz	32	36		dB	
	DC - 8.0 GHz	28	32		dB	
Return Loss	"On State"	DC - 2.0 GHz	12	16		dB
		DC - 4.0 GHz	12	16		dB
		DC - 6.0 GHz	11	16		dB
		DC - 8.0 GHz	6	11		dB
Return Loss	"Off State"	DC - 8.0 GHz	11	16		dB
Input Power for 1 dB Compression	0.5 - 8.0 GHz	23	28		dBm	
Input Third Order Intercept (Two-Tone Input Power = +10 dBm Each Tone)	0.5 - 8.0 GHz	40	44		dBm	
Switching Characteristics	DC - 8.0 GHz	tRISE, tFALL (10/90% RF)		35		ns
		tON, tOFF (50% CTL to 10/90% RF)		75		ns

GAAS MMIC SP4T NON-REFLECTIVE SWITCH, DC - 8 GHz

Insertion Loss vs. Temperature

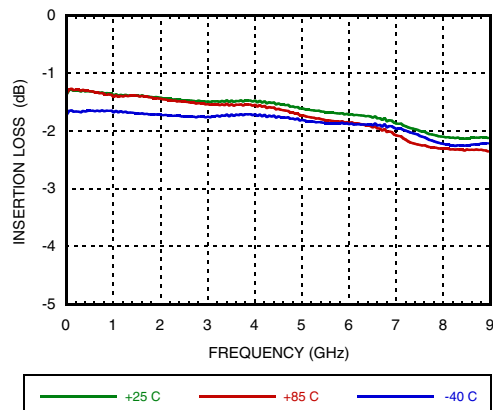

Isolation

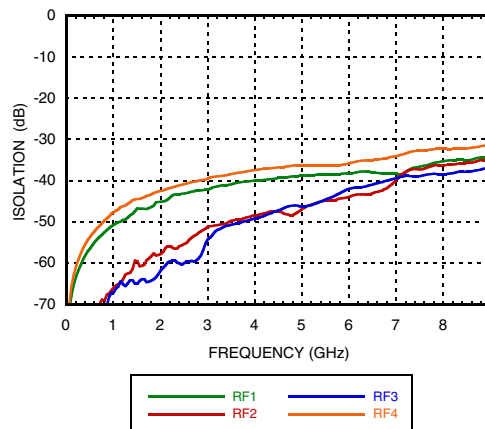

Return Loss

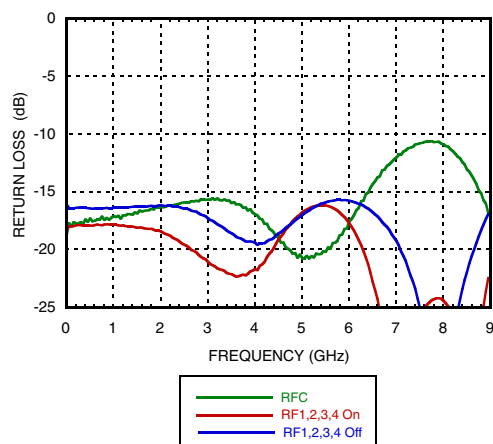

0.1 and 1 dB Input Compression Point

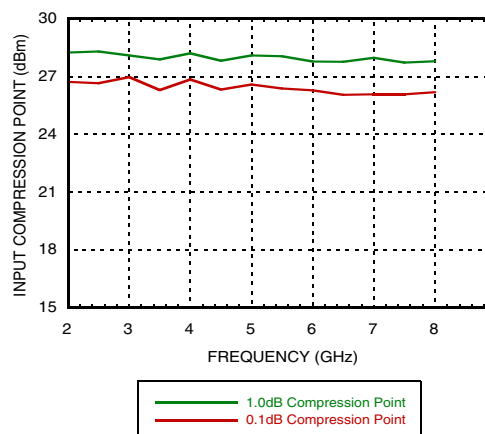

Input Third Order Intercept Point

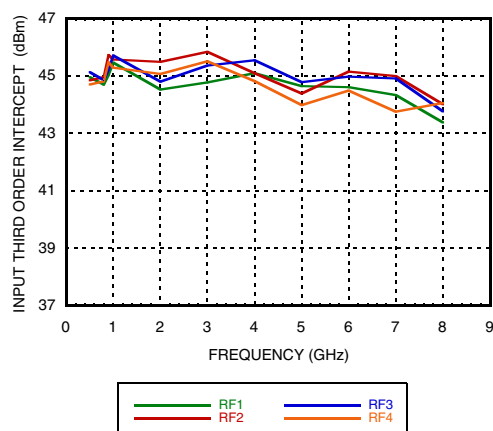

Bias Voltage & Current

Vee Range = -5.0 Vdc ± 10%		
Vee (Vdc)	Iee (Typ.) (mA)	Iee (Max.) (mA)
-5.0	2.5	6.0

Control Voltages

State	Bias Condition
Low	-3V to 0 Vdc @ 40 μ A Typical
High	-5 to -4.2 Vdc @ 0.10 μ A Typical

GAAS MMIC SP4T NON-REFLECTIVE SWITCH, DC - 8 GHz

Absolute Maximum Ratings

Bias Voltage Range (Vee)	-7.0 Vdc
Control Voltage Range (A & B)	Vee -0.5V to +1.0 Vdc
Channel Temperature	150 °C
Thermal Resistance (Insertion Loss Path)	107 °C/W
Thermal Resistance (Terminated Path)	137 °C/W
Storage Temperature	-65 to +150 °C
Operating Temperature	-40 to +85 °C
Maximum Input Power	+28 dBm
ESD Sensitivity (HBM)	Class 1A

Truth Table

Control Input		Signal Path State
A	B	RFCOM to:
High	High	RF1
Low	High	RF2
High	Low	RF3
Low	Low	RF4



ELECTROSTATIC SENSITIVE DEVICE
OBSERVE HANDLING PRECAUTIONS

Outline Drawing

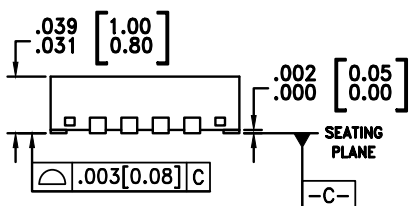
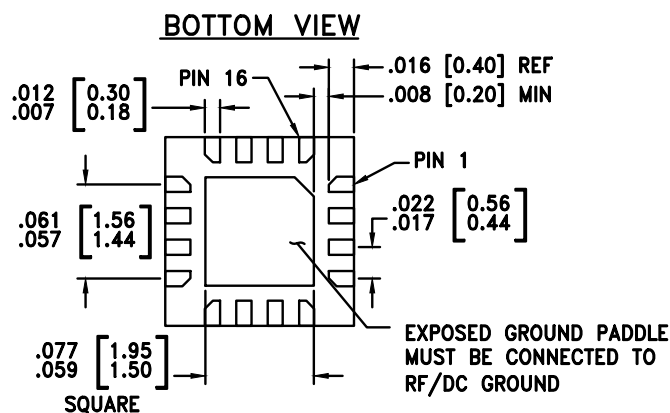
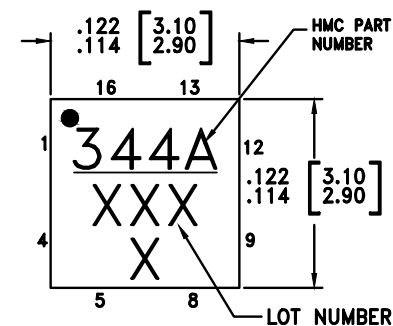

NOTES:

- LEADFRAME MATERIAL: COPPER ALLOY
- DIMENSIONS ARE IN INCHES [MILLIMETERS].
- LEAD SPACING TOLERANCE IS NON-CUMULATIVE
- PAD BURR LENGTH SHALL BE 0.15mm MAXIMUM.
PAD BURR HEIGHT SHALL BE 0.05mm MAXIMUM.
- PACKAGE WARP SHALL NOT EXCEED 0.05mm.
- ALL GROUND LEADS AND GROUND PADDLE MUST BE SOLDERED TO PCB RF GROUND.
- REFER TO HITTITE APPLICATION NOTE FOR SUGGESTED PCB LAND PATTERN.

Package Information



Part Number	Package Body Material	Lead Finish	MSL Rating	Package Marking ^[2]
HMC344ALP3E	RoHS-compliant Low Stress Injection Molded Plastic	100% matte Sn	MSL3 ^[1]	344A XXXX

[1] Max peak reflow temperature of 260 °C

[2] 4-Digit lot number XXXX

GAAS MMIC SP4T NON-REFLECTIVE SWITCH, DC - 8 GHz

Pin Descriptions

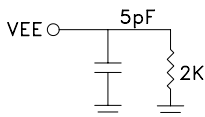
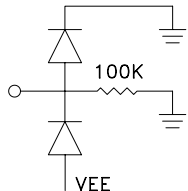
Pin Number	Function	Description	Interface Schematic
1, 4, 9, 12, 15	RF4, RF3, RF2, RF1, RFC	This pin is DC coupled and matched to 50 Ohm. Blocking capacitors are required if RF line potential is not equal to 0V.	
2, 3, 10, 11, 13	N/C	This pin should be connected to PCB RF ground to maximize isolation.	
5, 14, 16	GND	Package bottom has exposed metal paddle that must also be connected to PCB RF ground.	
6	VEE	Supply Voltage -5V ± 10%	
7	CTLB	See truth table and control voltage table.	
8	CTLA	See truth table and control voltage table.	

**GAAS MMIC SP4T NON-REFLECTIVE
SWITCH, DC - 8 GHz**

TTL Interface Circuit

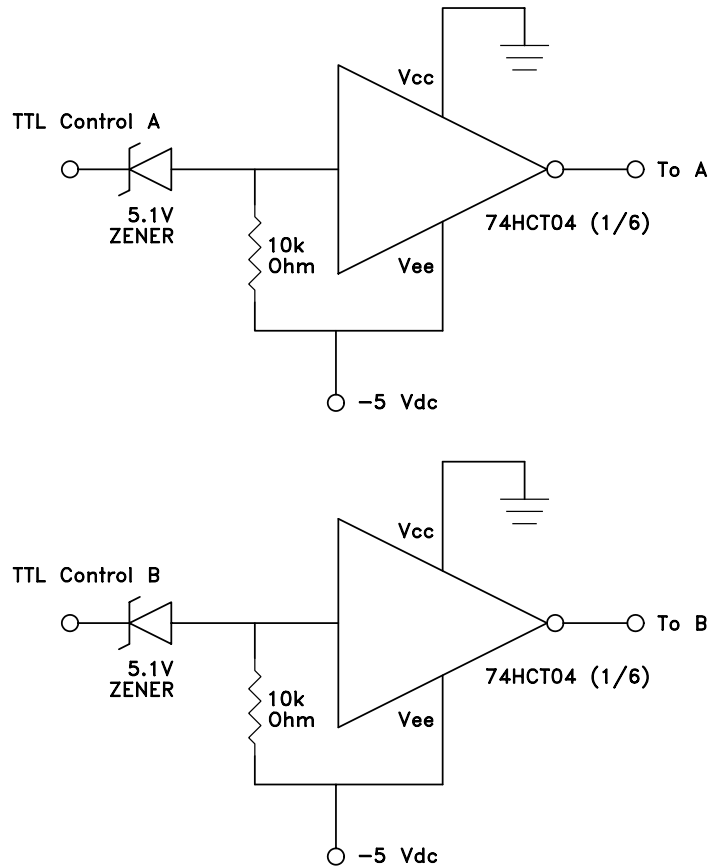

GAAS MMIC SP4T NON-REFLECTIVE SWITCH, DC - 8 GHz

Evaluation PCB

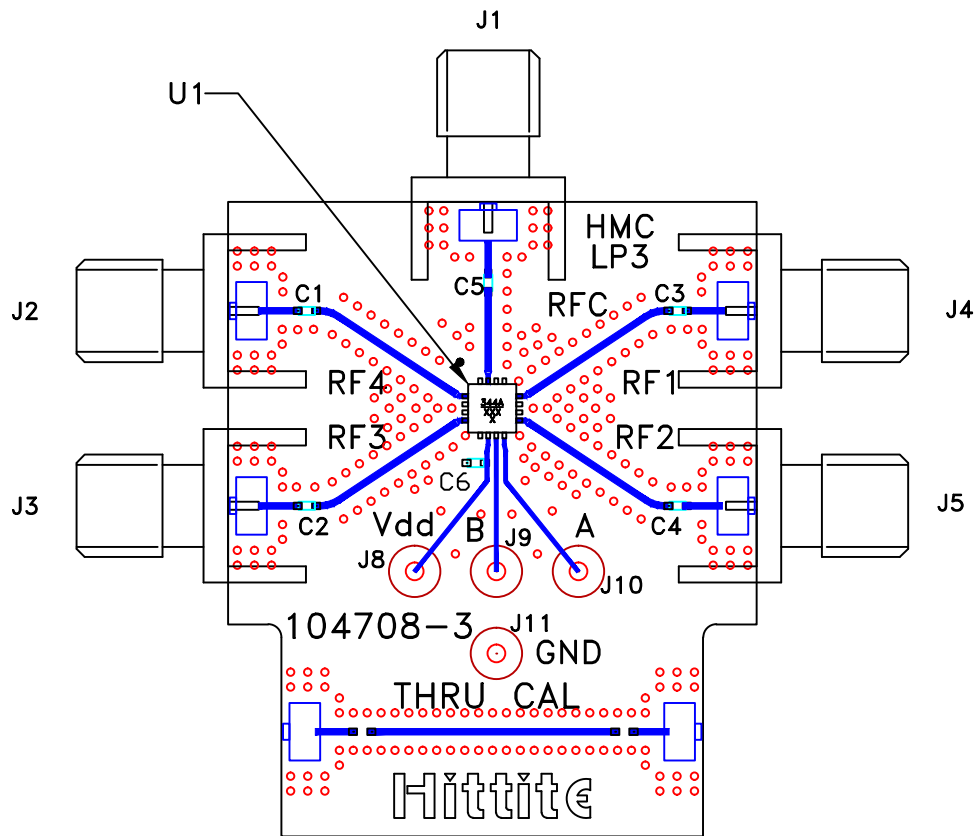

List of Materials for Evaluation PCB EV1HMC344ALP3^[1]

Item	Description
J1 - J5	PCB Mount SMA RF Connector
J8 - J11	DC Pin
C1 - C5	Zero Ohms Res, 0402 Pkg.
C6	1k pF Capacitor, 0402 Pkg.
U1	HMC344ALP3E SP4T Switch
PCB [2]	104708 Evaluation PCB 1.29"x1.55"

[1] Reference this number when ordering complete evaluation PCB

[2] Circuit Board Material: Rogers 4350

The circuit board used in the final application should be generated with proper RF circuit design techniques. Signal lines at the RF port should have 50 ohm impedance and the package ground leads and backside ground slug should be connected directly to the ground plane similar to that shown above. The evaluation circuit board shown above is available from Analog Devices Inc. upon request.