MKW41Z/31Z/21Z Reference Manual

Bluetooth Low Energy, IEEE 802.15.4 and Generic FSK System on a
Chip (SoC) Reference Manual

Document Number: MKW41Z512RM
Rev. 3, 03/2018





Contents

| Section number | Title | Page |
|--|--|------|
| Chapter 1 | | |
| Introduction | | |
| 1.1 | Introduction..... | 57 |
| 1.2 | Features Overview..... | 58 |
| 1.3 | Feature Summary..... | 61 |
| 1.4 | Block Diagram..... | 64 |
| Chapter 2 | | |
| Signal Multiplexing and Signal Descriptions | | |
| 2.1 | Pinouts..... | 65 |
| 2.2 | Signal Multiplexing and Pin Assignments..... | 66 |
| 2.3 | KW41 Signal Descriptions..... | 70 |
| 2.4 | Module Signal Description Tables..... | 73 |
| 2.4.1 | Core Modules..... | 73 |
| 2.4.2 | Radio Modules..... | 74 |
| 2.4.3 | System Modules..... | 75 |
| 2.4.4 | Clock Modules..... | 75 |
| 2.4.5 | Analog Modules..... | 76 |
| 2.4.6 | Timer Modules..... | 77 |
| 2.4.7 | Communication Interfaces..... | 78 |
| 2.4.8 | Human-Machine Interfaces(HMI)..... | 79 |
| Chapter 3 | | |
| Chip Configuration | | |
| 3.1 | Introduction..... | 81 |
| 3.2 | Module to module interconnects..... | 81 |
| 3.2.1 | Module to Module Interconnects..... | 81 |
| 3.3 | Core modules..... | 83 |
| 3.3.1 | ARM Cortex-M0+ core configuration..... | 83 |
| 3.3.1.1 | ARM Cortex M0+ core | 84 |

| Section number | Title | Page |
|----------------|---|------|
| 3.3.1.2 | Buses, Interconnects, and Interfaces..... | 85 |
| 3.3.1.3 | System Tick Timer..... | 85 |
| 3.3.1.4 | Debug Facilities..... | 85 |
| 3.3.1.5 | Core Privilege Levels..... | 86 |
| 3.3.2 | Nested Vectored Interrupt Controller (NVIC) Configuration..... | 86 |
| 3.3.2.1 | Interrupt priority levels..... | 86 |
| 3.3.2.2 | Non-maskable interrupt..... | 87 |
| 3.3.2.3 | Interrupt channel assignments..... | 87 |
| 3.3.2.4 | Serialization of memory operations when clearing interrupt flags..... | 89 |
| 3.3.3 | Asynchronous wake-up interrupt controller (AWIC) configuration..... | 90 |
| 3.3.3.1 | Wake-up sources..... | 90 |
| 3.4 | System modules..... | 91 |
| 3.4.1 | SIM configuration..... | 91 |
| 3.4.2 | System mode controller (SMC) configuration..... | 92 |
| 3.4.3 | PMC configuration..... | 93 |
| 3.4.4 | DCDC configuration..... | 94 |
| 3.4.4.1 | Buck Mode..... | 94 |
| 3.4.4.2 | Boost Mode..... | 97 |
| 3.4.4.3 | Bypass Mode..... | 99 |
| 3.4.5 | Low-Leakage Wake-up Unit (LLWU) Configuration..... | 100 |
| 3.4.5.1 | LLWU interrupt..... | 101 |
| 3.4.5.2 | Wake-up Sources..... | 101 |
| 3.4.6 | MCM configuration..... | 102 |
| 3.4.7 | Crossbar-light switch configuration..... | 103 |
| 3.4.7.1 | Crossbar-Light Switch Master Assignments..... | 104 |
| 3.4.7.2 | Crossbar Switch Slave Assignments..... | 105 |
| 3.4.8 | Peripheral bridge configuration..... | 105 |
| 3.4.8.1 | Number of peripheral bridges..... | 105 |
| 3.4.8.2 | Memory maps..... | 105 |

| Section number | Title | Page |
|----------------|---|------|
| 3.4.9 | DMA request multiplexer configuration..... | 106 |
| 3.4.9.1 | DMA MUX Request Sources..... | 106 |
| 3.4.9.2 | DMA transfers via PIT trigger..... | 108 |
| 3.4.10 | DMA Controller Configuration..... | 108 |
| 3.4.11 | Computer operating properly (COP) watchdog configuration..... | 109 |
| 3.4.11.1 | COP clocks..... | 110 |
| 3.4.11.2 | COP watchdog operation..... | 110 |
| 3.4.11.3 | Clock Gating..... | 112 |
| 3.5 | Clock modules..... | 112 |
| 3.5.1 | MCG configuration..... | 112 |
| 3.5.1.1 | MCG Instantiation Information..... | 113 |
| 3.5.1.2 | MCG FLL modes..... | 113 |
| 3.5.2 | 32kHz OSC Configuration..... | 113 |
| 3.5.2.1 | 32kHz OSC Instantiation Information..... | 114 |
| 3.5.3 | Reference Oscillator Configuration..... | 114 |
| 3.5.3.1 | Reference Oscillator Instantiation Information..... | 115 |
| 3.6 | Memories and memory interfaces..... | 116 |
| 3.6.1 | Flash Memory Configuration..... | 116 |
| 3.6.1.1 | Flash Memory Sizes..... | 116 |
| 3.6.1.2 | Flash Memory Map..... | 116 |
| 3.6.1.3 | Flash Security..... | 117 |
| 3.6.1.4 | Flash Modes..... | 118 |
| 3.6.1.5 | Erase All Flash Contents..... | 118 |
| 3.6.1.6 | FTFA_FOFT Register..... | 118 |
| 3.6.2 | Flash Memory Controller Configuration..... | 118 |
| 3.6.3 | SRAM Configuration..... | 119 |
| 3.6.3.1 | SRAM Sizes..... | 120 |
| 3.6.3.2 | SRAM Ranges..... | 120 |
| 3.6.3.3 | SRAM retention in low power modes..... | 121 |

| Section number | Title | Page |
|----------------|--|------|
| 3.6.4 | System Register File Configuration..... | 121 |
| | 3.6.4.1 System Register file..... | 121 |
| 3.7 | Security..... | 121 |
| | 3.7.1 TRNG configuration..... | 122 |
| | 3.7.2 LTC configuration..... | 122 |
| 3.8 | Analog..... | 123 |
| | 3.8.1 Analog reference options..... | 123 |
| | 3.8.2 16-bit SAR ADC configuration..... | 124 |
| | 3.8.2.1 ADC Instantiation Information..... | 124 |
| | 3.8.2.2 DMA Support on ADC..... | 125 |
| | 3.8.2.3 ADC0 Connections/Channel Assignment..... | 125 |
| | 3.8.2.4 Alternate clock..... | 126 |
| | 3.8.3 CMP Configuration..... | 126 |
| | 3.8.3.1 CMP Instantiation Information..... | 127 |
| | 3.8.3.2 CMP input connections..... | 128 |
| | 3.8.3.3 CMP external references..... | 128 |
| | 3.8.3.4 CMP trigger mode..... | 128 |
| | 3.8.4 12-bit DAC configuration..... | 129 |
| | 3.8.4.1 12-bit DAC Instantiation Information..... | 129 |
| | 3.8.4.2 12-bit DAC Output..... | 129 |
| | 3.8.4.3 12-bit DAC Analog Supply Connections..... | 129 |
| | 3.8.4.4 12-bit DAC Reference..... | 130 |
| | 3.8.5 Voltage Reference (VREF)..... | 130 |
| | 3.8.5.1 VREF Overview..... | 130 |
| 3.9 | Radio..... | 131 |
| | 3.9.1 Radio module configuration..... | 131 |
| | 3.9.1.1 Radio Overview..... | 132 |
| 3.10 | Timers..... | 132 |
| | 3.10.1 Timer/TPM Configuration..... | 132 |

| Section number | Title | Page |
|----------------|---|------|
| 3.10.1.1 | TPM Instantiation Information..... | 132 |
| 3.10.1.2 | Clock Options..... | 133 |
| 3.10.1.3 | Trigger Options..... | 133 |
| 3.10.1.4 | Global timebase..... | 134 |
| 3.10.1.5 | Interrupts..... | 134 |
| 3.10.2 | PIT Configuration..... | 135 |
| 3.10.2.1 | PIT/DMA Periodic Trigger Assignments | 135 |
| 3.10.2.2 | PIT/ADC Triggers..... | 135 |
| 3.10.2.3 | PIT/FTM Triggers..... | 136 |
| 3.10.2.4 | PIT/DAC Triggers..... | 136 |
| 3.10.3 | Low-power timer configuration..... | 136 |
| 3.10.3.1 | LPTMR Instantiation Information..... | 136 |
| 3.10.3.2 | LPTMR pulse counter input options..... | 137 |
| 3.10.3.3 | LPTMR prescaler/glitch filter clocking options..... | 137 |
| 3.10.4 | RTC configuration..... | 137 |
| 3.10.4.1 | RTC Instantiation Information..... | 138 |
| 3.10.4.2 | RTC_CLKOUT options..... | 138 |
| 3.11 | Communication interfaces..... | 139 |
| 3.11.1 | SPI configuration..... | 139 |
| 3.11.1.1 | SPI Instantiation Information..... | 139 |
| 3.11.2 | I2C Configuration..... | 140 |
| 3.11.2.1 | I2C Instantiation Information..... | 140 |
| 3.11.3 | LPUART Configuration..... | 141 |
| 3.11.3.1 | LPUART instantiation information..... | 141 |
| 3.12 | Human-machine interfaces (HMI)..... | 142 |
| 3.12.1 | GPIO Configuration..... | 142 |
| 3.12.1.1 | GPIO Instantiation Information..... | 142 |
| 3.12.1.2 | Port control and interrupt summary..... | 143 |
| 3.12.1.3 | GPIO accessibility in the memory map..... | 143 |

| Section number | Title | Page |
|----------------|------------------------------------|------|
| 3.12.2 | TSI Configuration..... | 144 |
| 3.12.2.1 | TSI Instantiation Information..... | 144 |
| 3.12.2.2 | TSI Interrupts..... | 144 |

Chapter 4 Memory Map

| | | |
|-------|--|-----|
| 4.1 | Introduction..... | 147 |
| 4.2 | System memory map..... | 147 |
| 4.3 | Alternate Non-Volatile IRC User Trim Description..... | 148 |
| 4.4 | SRAM memory map..... | 148 |
| 4.5 | Bit Manipulation Engine..... | 149 |
| 4.6 | Peripheral bridge (AIPS-Lite) memory map..... | 149 |
| 4.6.1 | Read-after-write sequence and required serialization of memory operations..... | 150 |
| 4.6.2 | Peripheral Bridge (AIPS-Lite) Memory Map..... | 150 |
| 4.6.3 | Modules Restricted Access in User Mode..... | 153 |
| 4.7 | Private Peripheral Bus (PPB) memory map..... | 154 |

Chapter 5 Clock Distribution

| | | |
|-------|--|-----|
| 5.1 | Introduction..... | 155 |
| 5.2 | Programming model..... | 155 |
| 5.3 | High-Level device clocking diagram..... | 155 |
| 5.4 | Clock definitions..... | 156 |
| 5.4.1 | Device clock summary..... | 157 |
| 5.5 | Internal clocking requirements..... | 158 |
| 5.5.1 | Clock divider values after reset..... | 159 |
| 5.5.2 | VLPR mode clocking..... | 159 |
| 5.6 | Reference Oscillator Enable Sources..... | 160 |
| 5.7 | Clock Gating..... | 161 |
| 5.8 | Module clocks..... | 161 |
| 5.8.1 | PMC 1 kHz LPO clock..... | 162 |

| Section number | Title | Page |
|----------------|----------------------|------|
| 5.8.2 | COP clocking..... | 162 |
| 5.8.3 | RTC clocking..... | 163 |
| 5.8.4 | LPTMR clocking..... | 163 |
| 5.8.5 | TPM clocking..... | 164 |
| 5.8.6 | LPUART clocking..... | 164 |

Chapter 6 Reset and Boot

| | | |
|---------|---|-----|
| 6.1 | Introduction..... | 167 |
| 6.2 | Reset..... | 167 |
| 6.2.1 | Power-on reset (POR)..... | 168 |
| 6.2.2 | System reset sources..... | 168 |
| 6.2.2.1 | External pin reset (RESET_b)..... | 168 |
| 6.2.2.2 | Low-voltage detect (LVD)..... | 169 |
| 6.2.2.3 | Computer operating properly (COP) watchdog timer..... | 170 |
| 6.2.2.4 | Low leakage wakeup (LLWU)..... | 170 |
| 6.2.2.5 | Multipurpose clock generator loss-of-clock (LOC)..... | 170 |
| 6.2.2.6 | Stop mode acknowledge error (SACKERR) | 171 |
| 6.2.2.7 | Software reset (SW)..... | 171 |
| 6.2.2.8 | Lockup reset (LOCKUP)..... | 171 |
| 6.2.2.9 | MDM-AP system reset request..... | 171 |
| 6.2.3 | MCU resets..... | 172 |
| 6.2.3.1 | POR Only | 172 |
| 6.2.3.2 | Chip POR not VLLS | 172 |
| 6.2.3.3 | Chip POR | 172 |
| 6.2.3.4 | Chip Reset not VLLS | 172 |
| 6.2.3.5 | Chip Reset not VLLS3/2..... | 172 |
| 6.2.3.6 | Early Chip Reset | 173 |
| 6.2.3.7 | Chip Reset | 173 |
| 6.2.4 | RESET_b pin | 173 |

| Section number | Title | Page |
|----------------|------------------------|------|
| 6.3 | Boot..... | 173 |
| 6.3.1 | Boot sources..... | 174 |
| 6.3.2 | FOPT boot options..... | 174 |
| 6.3.3 | Boot sequence..... | 175 |

Chapter 7 Kinetis Flashloader

| | | |
|-------|---|-----|
| 7.1 | Chip-Specific Information..... | 177 |
| 7.2 | Introduction..... | 177 |
| 7.3 | Functional Description..... | 179 |
| 7.3.1 | Memory Maps..... | 179 |
| 7.3.2 | Start-up Process..... | 180 |
| 7.3.3 | Clock Configuration..... | 180 |
| 7.3.4 | Flashloader Protocol..... | 181 |
| | 7.3.4.1 Command with no data phase..... | 181 |
| | 7.3.4.2 Command with incoming data phase..... | 182 |
| | 7.3.4.3 Command with outgoing data phase..... | 184 |
| 7.3.5 | Flashloader Packet Types..... | 186 |
| | 7.3.5.1 Ping packet..... | 186 |
| | 7.3.5.2 Ping Response Packet..... | 187 |
| | 7.3.5.3 Framing Packet..... | 187 |
| | 7.3.5.4 Command packet..... | 189 |
| | 7.3.5.5 Data packet..... | 190 |
| | 7.3.5.6 Response packet..... | 191 |
| 7.3.6 | Flashloader Command API..... | 193 |
| | 7.3.6.1 Call command..... | 193 |
| | 7.3.6.2 GetProperty command..... | 194 |
| | 7.3.6.3 SetProperty command..... | 196 |
| | 7.3.6.4 FlashEraseAll command..... | 198 |
| | 7.3.6.5 FlashEraseRegion command..... | 199 |

| Section number | Title | Page |
|-----------------------|---|-------------|
| 7.3.6.6 | FlashEraseAllUnsecure command..... | 201 |
| 7.3.6.7 | FillMemory command..... | 202 |
| 7.3.6.8 | FlashProgramOnce command..... | 203 |
| 7.3.6.9 | FlashReadOnce command..... | 205 |
| 7.3.6.10 | FlashReadResource command..... | 206 |
| 7.3.6.11 | WriteMemory command..... | 208 |
| 7.3.6.12 | Read memory command..... | 210 |
| 7.3.6.13 | Execute command..... | 212 |
| 7.3.6.14 | Reset command..... | 212 |
| 7.4 | Peripherals Supported..... | 213 |
| 7.4.1 | I2C Peripheral..... | 213 |
| 7.4.2 | SPI Peripheral..... | 215 |
| 7.4.3 | LPUART Peripheral..... | 217 |
| 7.5 | Get/SetProperty Command Properties..... | 220 |
| 7.5.1 | Property Definitions..... | 221 |
| 7.5.1.1 | CurrentVersion Property..... | 222 |
| 7.5.1.2 | AvailablePeripherals Property..... | 222 |
| 7.5.1.3 | AvailableCommands Property..... | 222 |
| 7.5.1.4 | TargetVersion Property..... | 223 |
| 7.6 | Kinetis Flashloader Status Error Codes..... | 223 |

Chapter 8 Power Management

| | | |
|-------|------------------------|-----|
| 8.1 | Introduction..... | 225 |
| 8.2 | Clocking Modes..... | 225 |
| 8.2.1 | Partial Stop..... | 225 |
| 8.2.2 | DMA Wakeup..... | 226 |
| 8.2.3 | Compute Operation..... | 227 |
| 8.2.4 | Peripheral Doze..... | 228 |
| 8.2.5 | Clock Gating..... | 229 |

| Section number | Title | Page |
|----------------|--|------|
| 8.3 | Power modes..... | 229 |
| 8.4 | Entering and exiting power modes..... | 231 |
| 8.5 | Module Operation in Low Power Modes..... | 232 |

Chapter 9 Security

| | | |
|-------|---|-----|
| 9.1 | Introduction..... | 237 |
| 9.2 | Flash security..... | 237 |
| 9.3 | Security interactions with other modules..... | 237 |
| 9.3.1 | Security interactions with Debug..... | 238 |
| 9.3.2 | Firmware Distribution Protection | 238 |

Chapter 10 Debug

| | | |
|--------|---------------------------------------|-----|
| 10.1 | Introduction..... | 239 |
| 10.2 | Debug port pin descriptions..... | 239 |
| 10.3 | SWD status and control registers..... | 239 |
| 10.3.1 | MDM-AP Control Register..... | 241 |
| 10.3.2 | MDM-AP Status Register..... | 243 |
| 10.4 | Debug Resets..... | 244 |
| 10.5 | Micro Trace Buffer (MTB)..... | 245 |
| 10.6 | Debug in low-power modes..... | 245 |
| 10.7 | Debug and security..... | 246 |

Chapter 11 Port control and interrupt (PORT)

| | | |
|----------|-------------------------|-----|
| 11.1 | Introduction..... | 247 |
| 11.2 | Overview..... | 247 |
| 11.2.1 | Features..... | 247 |
| 11.2.2 | Modes of operation..... | 248 |
| 11.2.2.1 | Run mode..... | 248 |
| 11.2.2.2 | Wait mode..... | 248 |
| 11.2.2.3 | Stop mode..... | 248 |

| Section number | Title | Page |
|----------------|---|------|
| 11.2.2.4 | Debug mode..... | 248 |
| 11.3 | External signal description..... | 248 |
| 11.4 | Detailed signal description..... | 249 |
| 11.5 | Memory map and register definition..... | 249 |
| 11.5.1 | Pin Control Register n (PORTx_PCRn)..... | 253 |
| 11.5.2 | Global Pin Control Low Register (PORTx_GPCLR)..... | 256 |
| 11.5.3 | Global Pin Control High Register (PORTx_GPCHR)..... | 256 |
| 11.5.4 | Interrupt Status Flag Register (PORTx_ISFR)..... | 257 |
| 11.6 | Functional description..... | 257 |
| 11.6.1 | Pin control..... | 257 |
| 11.6.2 | Global pin control..... | 258 |
| 11.6.3 | External interrupts..... | 258 |

Chapter 12 System Integration Module (SIM)

| | | |
|---------|---|-----|
| 12.1 | Introduction..... | 261 |
| 12.1.1 | Features..... | 261 |
| 12.2 | Memory map and register definition..... | 261 |
| 12.2.1 | System Options Register 1 (SIM_SOPT1)..... | 263 |
| 12.2.2 | System Options Register 2 (SIM_SOPT2)..... | 264 |
| 12.2.3 | System Options Register 4 (SIM_SOPT4)..... | 265 |
| 12.2.4 | System Options Register 5 (SIM_SOPT5)..... | 267 |
| 12.2.5 | System Options Register 7 (SIM_SOPT7)..... | 268 |
| 12.2.6 | System Device Identification Register (SIM_SDID)..... | 270 |
| 12.2.7 | System Clock Gating Control Register 4 (SIM_SCGC4)..... | 271 |
| 12.2.8 | System Clock Gating Control Register 5 (SIM_SCGC5)..... | 273 |
| 12.2.9 | System Clock Gating Control Register 6 (SIM_SCGC6)..... | 276 |
| 12.2.10 | System Clock Gating Control Register 7 (SIM_SCGC7)..... | 278 |
| 12.2.11 | System Clock Divider Register 1 (SIM_CLKDIV1)..... | 279 |
| 12.2.12 | Flash Configuration Register 1 (SIM_FCFG1)..... | 280 |

| Section number | Title | Page |
|----------------|--|------|
| 12.2.13 | Flash Configuration Register 2 (SIM_FCFG2)..... | 282 |
| 12.2.14 | Unique Identification Register Mid-High (SIM_UIDMH)..... | 283 |
| 12.2.15 | Unique Identification Register Mid Low (SIM_UIDML)..... | 283 |
| 12.2.16 | Unique Identification Register Low (SIM_UIDL)..... | 284 |
| 12.2.17 | COP Control Register (SIM_COPC)..... | 284 |
| 12.2.18 | Service COP (SIM_SRVCOP)..... | 286 |

Chapter 13 System Mode Controller (SMC)

| | | |
|----------|--|-----|
| 13.1 | Introduction..... | 287 |
| 13.2 | Modes of operation..... | 287 |
| 13.3 | Memory map and register descriptions..... | 289 |
| 13.3.1 | Power Mode Protection register (SMC_PMPROT)..... | 290 |
| 13.3.2 | Power Mode Control register (SMC_PMCTRL)..... | 291 |
| 13.3.3 | Stop Control Register (SMC_STOPCTRL)..... | 292 |
| 13.3.4 | Power Mode Status register (SMC_PMSTAT)..... | 294 |
| 13.4 | Functional description..... | 294 |
| 13.4.1 | Power mode transitions..... | 295 |
| 13.4.2 | Power mode entry/exit sequencing..... | 297 |
| 13.4.2.1 | Stop mode entry sequence..... | 298 |
| 13.4.2.2 | Stop mode exit sequence..... | 298 |
| 13.4.2.3 | Aborted stop mode entry..... | 299 |
| 13.4.2.4 | Transition to wait modes..... | 299 |
| 13.4.2.5 | Transition from stop modes to Debug mode..... | 299 |
| 13.4.3 | Run modes..... | 299 |
| 13.4.3.1 | RUN mode..... | 300 |
| 13.4.3.2 | Very-Low Power Run (VLPR) mode..... | 300 |
| 13.4.4 | Wait modes..... | 301 |
| 13.4.4.1 | WAIT mode..... | 301 |
| 13.4.4.2 | Very-Low-Power Wait (VLPW) mode..... | 301 |

| Section number | Title | Page |
|----------------|--|------|
| 13.4.5 | Stop modes..... | 302 |
| 13.4.5.1 | STOP mode..... | 302 |
| 13.4.5.2 | Very-Low-Power Stop (VLPS) mode..... | 303 |
| 13.4.5.3 | Low-Leakage Stop (LLSx) modes..... | 303 |
| 13.4.5.4 | Very-Low-Leakage Stop (VLLSx) modes..... | 304 |
| 13.4.6 | Debug in low power modes..... | 305 |

Chapter 14 Power Management Controller (PMC)

| | | |
|--------|--|-----|
| 14.1 | Introduction..... | 307 |
| 14.2 | Features..... | 307 |
| 14.3 | Low-voltage detect (LVD) system..... | 307 |
| 14.3.1 | LVD reset operation..... | 308 |
| 14.3.2 | LVD interrupt operation..... | 308 |
| 14.3.3 | Low-voltage warning (LVW) interrupt operation..... | 308 |
| 14.4 | I/O retention..... | 309 |
| 14.5 | Memory map and register descriptions..... | 309 |
| 14.5.1 | Low Voltage Detect Status And Control 1 register (PMC_LVDSC1)..... | 310 |
| 14.5.2 | Low Voltage Detect Status And Control 2 register (PMC_LVDSC2)..... | 311 |
| 14.5.3 | Regulator Status And Control register (PMC_REGSC)..... | 312 |

Chapter 15 DCDC Converter (DCDC)

| | | |
|--------|---|-----|
| 15.1 | Introduction..... | 315 |
| 15.2 | Features..... | 315 |
| 15.3 | Block diagram..... | 316 |
| 15.4 | Functional Description..... | 316 |
| 15.5 | Application Requirements..... | 317 |
| 15.6 | Assumptions..... | 318 |
| 15.7 | Memory map and register definition..... | 319 |
| 15.7.1 | DCDC Register Descriptions..... | 319 |

| Section number | Title | Page |
|----------------|----------------------------------|------|
| 15.7.2 | DCDC REGISTER 0 (DCDC_REG0)..... | 320 |
| 15.7.3 | DCDC REGISTER 1 (DCDC_REG1)..... | 324 |
| 15.7.4 | DCDC REGISTER 2 (DCDC_REG2)..... | 325 |
| 15.7.5 | DCDC REGISTER 3 (DCDC_REG3)..... | 327 |
| 15.7.6 | DCDC REGISTER 4 (DCDC_REG4)..... | 331 |
| 15.7.7 | DCDC REGISTER 6 (DCDC_REG6)..... | 332 |
| 15.7.8 | DCDC REGISTER 7 (DCDC_REG7)..... | 333 |

Chapter 16 Low-Leakage Wakeup Unit (LLWU)

| | | |
|----------|--|-----|
| 16.1 | Introduction..... | 335 |
| 16.1.1 | Features..... | 335 |
| 16.1.2 | Modes of operation..... | 336 |
| 16.1.2.1 | LLS mode..... | 336 |
| 16.1.2.2 | VLLS modes..... | 336 |
| 16.1.2.3 | Non-low leakage modes..... | 336 |
| 16.1.2.4 | Debug mode..... | 336 |
| 16.1.3 | Block diagram..... | 337 |
| 16.2 | LLWU signal descriptions..... | 338 |
| 16.3 | Memory map/register definition..... | 338 |
| 16.3.1 | LLWU Pin Enable 1 register (LLWU_PE1)..... | 339 |
| 16.3.2 | LLWU Pin Enable 2 register (LLWU_PE2)..... | 340 |
| 16.3.3 | LLWU Pin Enable 3 register (LLWU_PE3)..... | 341 |
| 16.3.4 | LLWU Pin Enable 4 register (LLWU_PE4)..... | 342 |
| 16.3.5 | LLWU Module Enable register (LLWU_ME)..... | 343 |
| 16.3.6 | LLWU Flag 1 register (LLWU_F1)..... | 345 |
| 16.3.7 | LLWU Flag 2 register (LLWU_F2)..... | 347 |
| 16.3.8 | LLWU Flag 3 register (LLWU_F3)..... | 348 |
| 16.3.9 | LLWU Pin Filter 1 register (LLWU_FILT1)..... | 350 |
| 16.3.10 | LLWU Pin Filter 2 register (LLWU_FILT2)..... | 351 |

| Section number | Title | Page |
|----------------|-----------------------------|------|
| 16.4 | Functional description..... | 352 |
| 16.4.1 | LLS mode..... | 353 |
| 16.4.2 | VLLS modes..... | 353 |
| 16.4.3 | Initialization..... | 353 |

Chapter 17 Reset Control Module (RCM)

| | | |
|--------|---|-----|
| 17.1 | Introduction..... | 355 |
| 17.2 | Reset memory map and register descriptions..... | 355 |
| 17.2.1 | System Reset Status Register 0 (RCM_SRS0)..... | 356 |
| 17.2.2 | System Reset Status Register 1 (RCM_SRS1)..... | 357 |
| 17.2.3 | Reset Pin Filter Control register (RCM_RPFC)..... | 358 |
| 17.2.4 | Reset Pin Filter Width register (RCM_RPFW)..... | 359 |

Chapter 18 Bit Manipulation Engine (BME)

| | | |
|----------|---|-----|
| 18.1 | Introduction..... | 361 |
| 18.1.1 | Overview..... | 362 |
| 18.1.2 | Features..... | 363 |
| 18.1.3 | Modes of operation..... | 363 |
| 18.2 | Memory map and register definition..... | 363 |
| 18.3 | Functional description..... | 364 |
| 18.3.1 | BME decorated stores..... | 364 |
| 18.3.1.1 | Decorated store logical AND (AND)..... | 366 |
| 18.3.1.2 | Decorated store logical OR (OR)..... | 367 |
| 18.3.1.3 | Decorated store logical XOR (XOR)..... | 368 |
| 18.3.1.4 | Decorated store bit field insert (BFI)..... | 369 |
| 18.3.2 | BME decorated loads..... | 371 |
| 18.3.2.1 | Decorated load: load-and-clear 1 bit (LAC1)..... | 374 |
| 18.3.2.2 | Decorated Load: Load-and-Set 1 Bit (LAS1)..... | 375 |
| 18.3.2.3 | Decorated load unsigned bit field extract (UBFX)..... | 376 |

| Section number | Title | Page |
|----------------|--|------|
| 18.3.3 | Additional details on decorated addresses and GPIO accesses..... | 377 |
| 18.4 | Application information..... | 378 |

Chapter 19 Miscellaneous Control Module (MCM)

| | | |
|--------|--|-----|
| 19.1 | Introduction..... | 381 |
| 19.1.1 | Features..... | 381 |
| 19.2 | Memory map/register descriptions..... | 381 |
| 19.2.1 | Crossbar Switch (AXBS) Slave Configuration (MCM_PLASC)..... | 382 |
| 19.2.2 | Crossbar Switch (AXBS) Master Configuration (MCM_PLAMC)..... | 383 |
| 19.2.3 | Platform Control Register (MCM_PLACR)..... | 383 |
| 19.2.4 | Compute Operation Control Register (MCM_CPO)..... | 386 |

Chapter 20 Micro Trace Buffer (MTB)

| | | |
|----------|---|-----|
| 20.1 | Introduction..... | 389 |
| 20.1.1 | Overview..... | 389 |
| 20.1.2 | Features..... | 392 |
| 20.1.3 | Modes of operation..... | 393 |
| 20.2 | External signal description..... | 393 |
| 20.3 | Memory map and register definition..... | 394 |
| 20.3.1 | MTB_RAM Memory Map..... | 394 |
| 20.3.1.1 | MTB Position Register (MTB_POSITION)..... | 396 |
| 20.3.1.2 | MTB Master Register (MTB_MASTER)..... | 398 |
| 20.3.1.3 | MTB Flow Register (MTB_FLOW)..... | 399 |
| 20.3.1.4 | MTB Base Register (MTB_BASE)..... | 401 |
| 20.3.1.5 | Integration Mode Control Register (MTB_MODECTRL)..... | 402 |
| 20.3.1.6 | Claim TAG Set Register (MTB_TAGSET)..... | 402 |
| 20.3.1.7 | Claim TAG Clear Register (MTB_TAGCLEAR)..... | 403 |
| 20.3.1.8 | Lock Access Register (MTB_LOCKACCESS)..... | 403 |
| 20.3.1.9 | Lock Status Register (MTB_LOCKSTAT)..... | 404 |

| Section number | Title | Page |
|----------------|---|------|
| 20.3.1.10 | Authentication Status Register (MTB_AUTHSTAT)..... | 404 |
| 20.3.1.11 | Device Architecture Register (MTB_DEVICEARCH)..... | 405 |
| 20.3.1.12 | Device Configuration Register (MTB_DEVICECFG)..... | 405 |
| 20.3.1.13 | Device Type Identifier Register (MTB_DEVICETYPID)..... | 406 |
| 20.3.1.14 | Peripheral ID Register (MTB_PERIPHID _n)..... | 406 |
| 20.3.1.15 | Component ID Register (MTB_COMPID _n)..... | 407 |
| 20.3.2 | MTB_DWT Memory Map..... | 407 |
| 20.3.2.1 | MTB DWT Control Register (MTBDWT_CTRL)..... | 408 |
| 20.3.2.2 | MTB_DWT Comparator Register (MTBDWT_COMP _n)..... | 409 |
| 20.3.2.3 | MTB_DWT Comparator Mask Register (MTBDWT_MASK _n)..... | 410 |
| 20.3.2.4 | MTB_DWT Comparator Function Register 0 (MTBDWT_FCT0)..... | 411 |
| 20.3.2.5 | MTB_DWT Comparator Function Register 1 (MTBDWT_FCT1)..... | 413 |
| 20.3.2.6 | MTB_DWT Trace Buffer Control Register (MTBDWT_TBCTRL)..... | 414 |
| 20.3.2.7 | Device Configuration Register (MTBDWT_DEVICECFG)..... | 416 |
| 20.3.2.8 | Device Type Identifier Register (MTBDWT_DEVICETYPID)..... | 416 |
| 20.3.2.9 | Peripheral ID Register (MTBDWT_PERIPHID _n)..... | 417 |
| 20.3.2.10 | Component ID Register (MTBDWT_COMPID _n)..... | 417 |
| 20.3.3 | System ROM Memory Map..... | 417 |
| 20.3.3.1 | Entry (ROM_ENTRY _n)..... | 419 |
| 20.3.3.2 | End of Table Marker Register (ROM_TABLEMARK)..... | 420 |
| 20.3.3.3 | System Access Register (ROM_SYSACCESS)..... | 420 |
| 20.3.3.4 | Peripheral ID Register (ROM_PERIPHID _n)..... | 421 |
| 20.3.3.5 | Component ID Register (ROM_COMPID _n)..... | 421 |

Chapter 21 Crossbar Switch Lite (AXBS-Lite)

| | | |
|--------|---------------------------------------|-----|
| 21.1 | Introduction..... | 423 |
| 21.1.1 | Features..... | 423 |
| 21.2 | Memory Map / Register Definition..... | 423 |
| 21.3 | Functional Description..... | 424 |

| Section number | Title | Page |
|----------------|---|------|
| 21.3.1 | General operation..... | 424 |
| 21.3.2 | Arbitration..... | 424 |
| 21.3.2.1 | Arbitration during undefined length bursts..... | 425 |
| 21.3.2.2 | Fixed-priority operation..... | 425 |
| 21.3.2.3 | Round-robin priority operation..... | 426 |
| 21.4 | Initialization/application information..... | 426 |

Chapter 22 Peripheral Bridge (AIPS-Lite)

| | | |
|--------|---|-----|
| 22.1 | Introduction..... | 427 |
| 22.1.1 | Features..... | 427 |
| 22.1.2 | General operation..... | 427 |
| 22.2 | Memory map/register definition..... | 428 |
| 22.2.1 | Master Privilege Register A (AIPS_MPRA)..... | 428 |
| 22.2.2 | Peripheral Access Control Register (AIPS_PACR _n)..... | 431 |
| 22.2.3 | Peripheral Access Control Register (AIPS_PACR _n)..... | 436 |
| 22.3 | Functional description..... | 440 |
| 22.3.1 | Access support..... | 441 |

Chapter 23 Direct Memory Access Multiplexer (DMAMUX)

| | | |
|--------|--|-----|
| 23.1 | Introduction..... | 443 |
| 23.1.1 | Overview..... | 443 |
| 23.1.2 | Features..... | 444 |
| 23.1.3 | Modes of operation..... | 444 |
| 23.2 | External signal description..... | 445 |
| 23.3 | Memory map/register definition..... | 445 |
| 23.3.1 | Channel Configuration register (DMAMUX _x _CHCFG _n)..... | 445 |
| 23.4 | Functional description..... | 446 |
| 23.4.1 | DMA channels with periodic triggering capability..... | 447 |
| 23.4.2 | DMA channels with no triggering capability..... | 449 |

| Section number | Title | Page |
|----------------|--|------|
| 23.4.3 | Always-enabled DMA sources..... | 449 |
| 23.4.4 | DMA sources with cancel_rewind capability..... | 450 |
| 23.5 | Initialization/application information..... | 450 |
| 23.5.1 | Reset..... | 450 |
| 23.5.2 | Enabling and configuring sources..... | 451 |

Chapter 24 DMA Controller Module

| | | |
|---------|---|-----|
| 24.1 | Introduction..... | 453 |
| 24.1.1 | eDMA system block diagram..... | 453 |
| 24.1.2 | Block parts..... | 454 |
| 24.1.3 | Features..... | 455 |
| 24.2 | Modes of operation..... | 456 |
| 24.3 | Memory map/register definition..... | 457 |
| 24.3.1 | TCD memory..... | 457 |
| 24.3.2 | TCD initialization..... | 457 |
| 24.3.3 | TCD structure..... | 457 |
| 24.3.4 | Reserved memory and bit fields..... | 458 |
| 24.3.5 | Control Register (DMA_CR)..... | 462 |
| 24.3.6 | Error Status Register (DMA_ES)..... | 465 |
| 24.3.7 | Enable Request Register (DMA_ERQ)..... | 467 |
| 24.3.8 | Enable Error Interrupt Register (DMA_EEI)..... | 468 |
| 24.3.9 | Clear Enable Error Interrupt Register (DMA_CEEI)..... | 469 |
| 24.3.10 | Set Enable Error Interrupt Register (DMA_SEEI)..... | 470 |
| 24.3.11 | Clear Enable Request Register (DMA_CERQ)..... | 471 |
| 24.3.12 | Set Enable Request Register (DMA_SERQ)..... | 472 |
| 24.3.13 | Clear DONE Status Bit Register (DMA_CDNE)..... | 473 |
| 24.3.14 | Set START Bit Register (DMA_SSRT)..... | 474 |
| 24.3.15 | Clear Error Register (DMA_CERR)..... | 475 |
| 24.3.16 | Clear Interrupt Request Register (DMA_CINT)..... | 476 |

| Section number | Title | Page |
|----------------|---|------|
| 24.3.17 | Interrupt Request Register (DMA_INT)..... | 477 |
| 24.3.18 | Error Register (DMA_ERR)..... | 478 |
| 24.3.19 | Hardware Request Status Register (DMA_HRS)..... | 479 |
| 24.3.20 | Enable Asynchronous Request in Stop Register (DMA_EARS)..... | 481 |
| 24.3.21 | Channel n Priority Register (DMA_DCHPRIn)..... | 482 |
| 24.3.22 | TCD Source Address (DMA_TCDn_SADDR)..... | 483 |
| 24.3.23 | TCD Signed Source Address Offset (DMA_TCDn_SOFF)..... | 483 |
| 24.3.24 | TCD Transfer Attributes (DMA_TCDn_ATTR)..... | 484 |
| 24.3.25 | TCD Minor Byte Count (Minor Loop Mapping Disabled) (DMA_TCDn_NBYTES_MLNO)..... | 485 |
| 24.3.26 | TCD Signed Minor Loop Offset (Minor Loop Mapping Enabled and Offset Disabled) (DMA_TCDn_NBYTES_MLOFFNO)..... | 485 |
| 24.3.27 | TCD Signed Minor Loop Offset (Minor Loop Mapping and Offset Enabled) (DMA_TCDn_NBYTES_MLOFFYES)..... | 487 |
| 24.3.28 | TCD Last Source Address Adjustment (DMA_TCDn_SLAST)..... | 488 |
| 24.3.29 | TCD Destination Address (DMA_TCDn_DADDR)..... | 489 |
| 24.3.30 | TCD Signed Destination Address Offset (DMA_TCDn_DOFF)..... | 489 |
| 24.3.31 | TCD Current Minor Loop Link, Major Loop Count (Channel Linking Enabled) (DMA_TCDn_CITER_ELINKYES)..... | 490 |
| 24.3.32 | TCD Current Minor Loop Link, Major Loop Count (Channel Linking Disabled) (DMA_TCDn_CITER_ELINKNO)..... | 491 |
| 24.3.33 | TCD Last Destination Address Adjustment/Scatter Gather Address (DMA_TCDn_DLASTSGA)..... | 492 |
| 24.3.34 | TCD Control and Status (DMA_TCDn_CSR)..... | 493 |
| 24.3.35 | TCD Beginning Minor Loop Link, Major Loop Count (Channel Linking Enabled) (DMA_TCDn_BITER_ELINKYES)..... | 495 |
| 24.3.36 | TCD Beginning Minor Loop Link, Major Loop Count (Channel Linking Disabled) (DMA_TCDn_BITER_ELINKNO)..... | 496 |
| 24.4 | Functional description..... | 497 |
| 24.4.1 | eDMA basic data flow..... | 497 |
| 24.4.2 | Fault reporting and handling..... | 500 |
| 24.4.3 | Channel preemption..... | 503 |

| Section number | Title | Page |
|----------------|---|------|
| 24.4.4 | Performance..... | 503 |
| 24.4.4.1 | Peak transfer rates..... | 503 |
| 24.4.4.2 | Peak request rates..... | 504 |
| 24.4.4.3 | eDMA performance example..... | 506 |
| 24.5 | Initialization/application information..... | 507 |
| 24.5.1 | eDMA initialization..... | 507 |
| 24.5.2 | Programming errors..... | 509 |
| 24.5.3 | Arbitration mode considerations..... | 510 |
| 24.5.3.1 | Fixed channel arbitration..... | 510 |
| 24.5.3.2 | Round-robin channel arbitration..... | 510 |
| 24.5.4 | Performing DMA transfers..... | 510 |
| 24.5.4.1 | Single request..... | 510 |
| 24.5.4.2 | Multiple requests..... | 512 |
| 24.5.4.3 | Using the modulo feature..... | 514 |
| 24.5.5 | Monitoring transfer descriptor status..... | 514 |
| 24.5.5.1 | Testing for minor loop completion..... | 514 |
| 24.5.5.2 | Reading the transfer descriptors of active channels..... | 515 |
| 24.5.5.3 | Checking channel preemption status..... | 516 |
| 24.5.6 | Channel Linking..... | 516 |
| 24.5.7 | Dynamic programming..... | 517 |
| 24.5.7.1 | Dynamically changing the channel priority..... | 517 |
| 24.5.7.2 | Dynamic channel linking..... | 518 |
| 24.5.7.3 | Dynamic scatter/gather..... | 518 |
| 24.5.8 | Suspend/resume a DMA channel with active hardware service requests..... | 521 |
| 24.5.8.1 | Suspend an active DMA channel..... | 521 |
| 24.5.8.2 | Resume a DMA channel..... | 521 |
| 24.5.9 | Lockstep..... | 522 |
| 24.5.9.1 | Initialization..... | 522 |
| 24.5.9.2 | Errors..... | 523 |

| Section number | Title | Page |
|---|--|------|
| Chapter 25 | | |
| Multipurpose Clock Generator (MCG) | | |
| 25.1 | Introduction..... | 525 |
| 25.1.1 | Features..... | 525 |
| 25.1.2 | Modes of Operation..... | 527 |
| 25.2 | External Signal Description..... | 527 |
| 25.3 | Memory Map/Register Definition..... | 528 |
| 25.3.1 | MCG Control 1 Register (MCG_C1)..... | 529 |
| 25.3.2 | MCG Control 2 Register (MCG_C2)..... | 530 |
| 25.3.3 | MCG Control 3 Register (MCG_C3)..... | 531 |
| 25.3.4 | MCG Control 4 Register (MCG_C4)..... | 532 |
| 25.3.5 | MCG Control 5 Register (MCG_C5)..... | 533 |
| 25.3.5 | MCG Control 6 Register (MCG_C6)..... | 533 |
| 25.3.6 | MCG Status Register (MCG_S)..... | 534 |
| 25.3.7 | MCG Status and Control Register (MCG_SC)..... | 535 |
| 25.3.8 | MCG Auto Trim Compare Value High Register (MCG_ATCVH)..... | 536 |
| 25.3.9 | MCG Auto Trim Compare Value Low Register (MCG_ATCVL)..... | 537 |
| 25.3.10 | MCG Control 7 Register (MCG_C7)..... | 537 |
| 25.3.11 | MCG Control 8 Register (MCG_C8)..... | 538 |
| 25.3.12 | MCG Control 12 Register (MCG_C12)..... | 539 |
| 25.3.12 | MCG Status 2 Register (MCG_S2)..... | 539 |
| 25.3.12 | MCG Test 3 Register (MCG_T3)..... | 539 |
| 25.4 | Functional description..... | 540 |
| 25.4.1 | MCG mode state diagram..... | 540 |
| 25.4.1.1 | MCG modes of operation..... | 540 |
| 25.4.1.2 | MCG mode switching..... | 542 |
| 25.4.2 | Low-power bit usage..... | 543 |
| 25.4.3 | MCG Internal Reference Clocks..... | 543 |
| 25.4.3.1 | MCG Internal Reference Clock..... | 543 |

| Section number | Title | Page |
|-----------------------|---|-------------|
| 25.4.4 | External Reference Clock..... | 543 |
| 25.4.5 | MCG Auto TRIM (ATM)..... | 544 |
| 25.5 | Initialization / Application information..... | 545 |
| 25.5.1 | MCG module initialization sequence..... | 545 |
| 25.5.1.1 | Initializing the MCG..... | 546 |
| 25.5.2 | Using a 32.768 kHz reference..... | 548 |
| 25.5.3 | MCG mode switching..... | 548 |

Chapter 26

32 kHz Oscillator (32kRTC)

| | | |
|--------|---------------------------------------|-----|
| 26.1 | Introduction..... | 551 |
| 26.1.1 | Features and Modes..... | 551 |
| 26.1.2 | Block Diagram..... | 551 |
| 26.2 | RTC Signal Descriptions..... | 552 |
| 26.2.1 | EXTAL32 — Oscillator Input..... | 552 |
| 26.2.2 | XTAL32 — Oscillator Output..... | 552 |
| 26.3 | External Crystal Connections..... | 552 |
| 26.4 | Memory Map/Register Descriptions..... | 553 |
| 26.5 | Functional Description..... | 553 |
| 26.6 | Reset Overview..... | 553 |
| 26.7 | Interrupts..... | 554 |

Chapter 27

Flash Memory Controller (FMC)

| | | |
|--------|---|-----|
| 27.1 | Introduction..... | 555 |
| 27.1.1 | Overview..... | 555 |
| 27.1.2 | Features..... | 555 |
| 27.2 | Modes of operation..... | 556 |
| 27.3 | External signal description..... | 556 |
| 27.4 | Memory map and register descriptions..... | 556 |
| 27.5 | Flash Access Control (FAC) Function..... | 556 |

| Section number | Title | Page |
|----------------|---|------|
| 27.5.1 | Memory map and register definitions..... | 557 |
| 27.5.2 | FAC functional description..... | 557 |
| 27.5.2.1 | Interface Signals..... | 559 |
| 27.5.2.2 | Flash Command Impact..... | 560 |
| 27.5.2.3 | Core Platform Impact..... | 560 |
| 27.5.2.4 | Software considerations..... | 561 |
| 27.5.2.5 | Access Check Evaluation..... | 561 |
| 27.5.2.6 | FAC application tips..... | 562 |
| 27.6 | Initialization and application information..... | 562 |

Chapter 28 Flash Memory Module (FTFA)

| | | |
|----------|--|-----|
| 28.1 | Introduction..... | 565 |
| 28.1.1 | Features..... | 565 |
| 28.1.1.1 | Program Flash Memory Features..... | 566 |
| 28.1.1.2 | Other Flash Memory Module Features..... | 566 |
| 28.1.2 | Block Diagram..... | 566 |
| 28.1.3 | Glossary..... | 567 |
| 28.2 | External Signal Description..... | 568 |
| 28.3 | Memory Map and Registers..... | 568 |
| 28.3.1 | Flash Configuration Field Description..... | 569 |
| 28.3.2 | Program Flash IFR Map..... | 569 |
| 28.3.2.1 | Program Once Field..... | 570 |
| 28.3.3 | Register Descriptions..... | 570 |
| 28.3.3.1 | Flash Status Register (FTFA_FSTAT)..... | 572 |
| 28.3.3.2 | Flash Configuration Register (FTFA_FCENFG)..... | 574 |
| 28.3.3.3 | Flash Security Register (FTFA_FSEC)..... | 575 |
| 28.3.3.4 | Flash Option Register (FTFA_FOPT)..... | 576 |
| 28.3.3.5 | Flash Common Command Object Registers (FTFA_FCCOB n)..... | 577 |
| 28.3.3.6 | Program Flash Protection Registers (FTFA_FPROT n)..... | 578 |

| Section number | Title | Page |
|----------------|---|------|
| 28.3.3.7 | Execute-only Access Registers (FTFA_XACC <i>n</i>)..... | 580 |
| 28.3.3.8 | Supervisor-only Access Registers (FTFA_SACC <i>n</i>)..... | 581 |
| 28.3.3.9 | Flash Access Segment Size Register (FTFA_FACSS)..... | 582 |
| 28.3.3.10 | Flash Access Segment Number Register (FTFA_FACSN)..... | 583 |
| 28.4 | Functional Description..... | 583 |
| 28.4.1 | Flash Protection..... | 584 |
| 28.4.2 | Flash Access Protection..... | 584 |
| 28.4.3 | Interrupts..... | 586 |
| 28.4.4 | Flash Operation in Low-Power Modes..... | 587 |
| 28.4.4.1 | Wait Mode..... | 587 |
| 28.4.4.2 | Stop Mode..... | 587 |
| 28.4.5 | Functional Modes of Operation..... | 587 |
| 28.4.6 | Flash Reads and Ignored Writes..... | 587 |
| 28.4.7 | Read While Write (RWW)..... | 588 |
| 28.4.8 | Flash Program and Erase..... | 588 |
| 28.4.9 | Flash Command Operations..... | 588 |
| 28.4.9.1 | Command Write Sequence..... | 588 |
| 28.4.9.2 | Flash Commands..... | 591 |
| 28.4.9.3 | Flash Commands by Mode..... | 593 |
| 28.4.9.4 | Allowed Simultaneous Flash Operations..... | 593 |
| 28.4.10 | Margin Read Commands..... | 594 |
| 28.4.11 | Flash Command Description..... | 595 |
| 28.4.11.1 | Read 1s Block Command..... | 596 |
| 28.4.11.2 | Read 1s Section Command..... | 596 |
| 28.4.11.3 | Program Check Command..... | 597 |
| 28.4.11.4 | Read Resource Command..... | 599 |
| 28.4.11.5 | Program Longword Command..... | 600 |
| 28.4.11.6 | Erase Flash Block Command..... | 601 |
| 28.4.11.7 | Erase Flash Sector Command..... | 602 |

| Section number | Title | Page |
|----------------|--|------|
| 28.4.11.8 | Read 1s All Blocks Command..... | 607 |
| 28.4.11.9 | Read Once Command..... | 608 |
| 28.4.11.10 | Program Once Command..... | 609 |
| 28.4.11.11 | Erase All Blocks Command..... | 610 |
| 28.4.11.12 | Verify Backdoor Access Key Command..... | 612 |
| 28.4.11.13 | Erase All Blocks Unsecure Command..... | 613 |
| 28.4.11.14 | Read 1s All Execute-only Segments Command..... | 614 |
| 28.4.11.15 | Erase All Execute-only Segments Command..... | 616 |
| 28.4.12 | Security..... | 616 |
| 28.4.12.1 | Flash Memory Access by Mode and Security..... | 617 |
| 28.4.12.2 | Changing the Security State..... | 617 |
| 28.4.13 | Reset Sequence..... | 619 |

Chapter 29 Analog-to-digital converter (ADC)

| | | |
|--------|---|-----|
| 29.1 | Introduction..... | 621 |
| 29.1.1 | Features..... | 621 |
| 29.1.2 | Block diagram..... | 622 |
| 29.2 | ADC signal descriptions..... | 623 |
| 29.2.1 | Analog Power (VDDA)..... | 624 |
| 29.2.2 | Analog Ground (VSSA)..... | 624 |
| 29.2.3 | Voltage Reference Select..... | 624 |
| 29.2.4 | Analog Channel Inputs (ADx)..... | 625 |
| 29.2.5 | Differential Analog Channel Inputs (DADx)..... | 625 |
| 29.3 | Memory map and register definitions..... | 625 |
| 29.3.1 | ADC Status and Control Registers 1 (ADCx_SC1n)..... | 626 |
| 29.3.2 | ADC Configuration Register 1 (ADCx_CFG1)..... | 630 |
| 29.3.3 | ADC Configuration Register 2 (ADCx_CFG2)..... | 631 |
| 29.3.4 | ADC Data Result Register (ADCx_Rn)..... | 632 |
| 29.3.5 | Compare Value Registers (ADCx_CVn)..... | 634 |

| Section number | Title | Page |
|----------------|--|------|
| 29.3.6 | Status and Control Register 2 (ADCx_SC2)..... | 635 |
| 29.3.7 | Status and Control Register 3 (ADCx_SC3)..... | 637 |
| 29.3.8 | ADC Offset Correction Register (ADCx_OFS)..... | 638 |
| 29.3.9 | ADC Plus-Side Gain Register (ADCx_PG)..... | 639 |
| 29.3.10 | ADC Minus-Side Gain Register (ADCx_MG)..... | 639 |
| 29.3.11 | ADC Plus-Side General Calibration Value Register (ADCx_CLPD)..... | 640 |
| 29.3.12 | ADC Plus-Side General Calibration Value Register (ADCx_CLPS)..... | 641 |
| 29.3.13 | ADC Plus-Side General Calibration Value Register (ADCx_CLP4)..... | 641 |
| 29.3.14 | ADC Plus-Side General Calibration Value Register (ADCx_CLP3)..... | 642 |
| 29.3.15 | ADC Plus-Side General Calibration Value Register (ADCx_CLP2)..... | 642 |
| 29.3.16 | ADC Plus-Side General Calibration Value Register (ADCx_CLP1)..... | 643 |
| 29.3.17 | ADC Plus-Side General Calibration Value Register (ADCx_CLP0)..... | 643 |
| 29.3.18 | ADC Minus-Side General Calibration Value Register (ADCx_CLMD)..... | 644 |
| 29.3.19 | ADC Minus-Side General Calibration Value Register (ADCx_CLMS)..... | 644 |
| 29.3.20 | ADC Minus-Side General Calibration Value Register (ADCx_CLM4)..... | 645 |
| 29.3.21 | ADC Minus-Side General Calibration Value Register (ADCx_CLM3)..... | 645 |
| 29.3.22 | ADC Minus-Side General Calibration Value Register (ADCx_CLM2)..... | 646 |
| 29.3.23 | ADC Minus-Side General Calibration Value Register (ADCx_CLM1)..... | 646 |
| 29.3.24 | ADC Minus-Side General Calibration Value Register (ADCx_CLM0)..... | 647 |
| 29.4 | Functional description..... | 647 |
| 29.4.1 | Clock select and divide control..... | 648 |
| 29.4.2 | Voltage reference selection..... | 649 |
| 29.4.3 | Hardware trigger and channel selects..... | 649 |
| 29.4.4 | Conversion control..... | 650 |
| 29.4.4.1 | Initiating conversions..... | 650 |
| 29.4.4.2 | Completing conversions..... | 651 |
| 29.4.4.3 | Aborting conversions..... | 651 |
| 29.4.4.4 | Power control..... | 652 |
| 29.4.4.5 | Sample time and total conversion time..... | 652 |

| Section number | Title | Page |
|----------------|---|------|
| 29.4.4.6 | Conversion time examples..... | 655 |
| 29.4.4.7 | Hardware average function..... | 657 |
| 29.4.5 | Automatic compare function..... | 658 |
| 29.4.6 | Calibration function..... | 659 |
| 29.4.7 | User-defined offset function..... | 661 |
| 29.4.8 | Temperature sensor..... | 662 |
| 29.4.9 | MCU wait mode operation..... | 663 |
| 29.4.10 | MCU Normal Stop mode operation..... | 663 |
| 29.4.10.1 | Normal Stop mode with ADACK disabled..... | 663 |
| 29.4.10.2 | Normal Stop mode with ADACK enabled..... | 664 |
| 29.4.11 | MCU Low-Power Stop mode operation..... | 664 |
| 29.5 | Initialization information..... | 665 |
| 29.5.1 | ADC module initialization example..... | 665 |
| 29.5.1.1 | Initialization sequence..... | 665 |
| 29.5.1.2 | Pseudo-code example..... | 665 |
| 29.6 | Application information..... | 667 |
| 29.6.1 | External pins and routing..... | 667 |
| 29.6.1.1 | Analog supply pins..... | 667 |
| 29.6.1.2 | Analog voltage reference pins..... | 668 |
| 29.6.1.3 | Analog input pins..... | 669 |
| 29.6.2 | Sources of error..... | 669 |
| 29.6.2.1 | Sampling error..... | 669 |
| 29.6.2.2 | Pin leakage error..... | 670 |
| 29.6.2.3 | Noise-induced errors..... | 670 |
| 29.6.2.4 | Code width and quantization error..... | 671 |
| 29.6.2.5 | Linearity errors..... | 672 |
| 29.6.2.6 | Code jitter, non-monotonicity, and missing codes..... | 672 |

Chapter 30 Comparator (CMP)

| Section number | Title | Page |
|----------------|--|------|
| 30.1 | Introduction..... | 675 |
| 30.1.1 | CMP features..... | 675 |
| 30.1.2 | 6-bit DAC key features..... | 676 |
| 30.1.3 | ANMUX key features..... | 676 |
| 30.1.4 | CMP, DAC and ANMUX diagram..... | 677 |
| 30.1.5 | CMP block diagram..... | 678 |
| 30.2 | Memory map/register definitions..... | 679 |
| 30.2.1 | CMP Control Register 0 (CMP _x _CR0)..... | 680 |
| 30.2.2 | CMP Control Register 1 (CMP _x _CR1)..... | 681 |
| 30.2.3 | CMP Filter Period Register (CMP _x _FPR)..... | 682 |
| 30.2.4 | CMP Status and Control Register (CMP _x _SCR)..... | 683 |
| 30.2.5 | DAC Control Register (CMP _x _DACCR)..... | 684 |
| 30.2.6 | MUX Control Register (CMP _x _MUXCR)..... | 684 |
| 30.3 | Functional description..... | 685 |
| 30.3.1 | CMP functional modes..... | 686 |
| 30.3.1.1 | Disabled mode (# 1)..... | 687 |
| 30.3.1.2 | Continuous mode (#s 2A & 2B)..... | 687 |
| 30.3.1.3 | Sampled, Non-Filtered mode (#s 3B)..... | 688 |
| 30.3.1.4 | Sampled, Filtered mode (#s 4B)..... | 689 |
| 30.3.2 | Power modes..... | 689 |
| 30.3.2.1 | Wait mode operation..... | 689 |
| 30.3.2.2 | Stop mode operation..... | 690 |
| 30.3.2.3 | Low-Leakage mode operation..... | 690 |
| 30.3.2.4 | Background Debug Mode Operation..... | 690 |
| 30.3.3 | Startup and operation..... | 690 |
| 30.3.4 | Low-pass filter..... | 691 |
| 30.3.4.1 | Enabling filter modes..... | 691 |
| 30.3.4.2 | Latency issues..... | 692 |
| 30.4 | CMP interrupts..... | 692 |

| Section number | Title | Page |
|----------------|--------------------------------------|------|
| 30.5 | DMA support..... | 693 |
| 30.6 | CMP Asynchronous DMA support..... | 693 |
| 30.7 | Digital-to-analog converter..... | 694 |
| 30.8 | DAC functional description..... | 694 |
| 30.8.1 | Voltage reference source select..... | 694 |
| 30.9 | DAC resets..... | 695 |
| 30.10 | DAC clocks..... | 695 |
| 30.11 | DAC interrupts..... | 695 |
| 30.12 | CMP Trigger Mode..... | 695 |

Chapter 31 12-bit digital-to-analog converter (DAC)

| | | |
|----------|--|-----|
| 31.1 | Introduction..... | 697 |
| 31.2 | Features..... | 697 |
| 31.3 | Block diagram..... | 697 |
| 31.4 | Memory map/register definition..... | 698 |
| 31.4.1 | DAC Data Low Register (DACx_DATnL)..... | 699 |
| 31.4.2 | DAC Data High Register (DACx_DATnH)..... | 699 |
| 31.4.3 | DAC Status Register (DACx_SR)..... | 700 |
| 31.4.4 | DAC Control Register (DACx_C0)..... | 701 |
| 31.4.5 | DAC Control Register 1 (DACx_C1)..... | 702 |
| 31.4.6 | DAC Control Register 2 (DACx_C2)..... | 703 |
| 31.5 | Functional description..... | 703 |
| 31.5.1 | DAC data buffer operation..... | 704 |
| 31.5.1.1 | DAC data buffer interrupts..... | 704 |
| 31.5.1.2 | Modes of DAC data buffer operation..... | 704 |
| 31.5.2 | DMA operation..... | 705 |
| 31.5.3 | Resets..... | 705 |
| 31.5.4 | Low-Power mode operation..... | 705 |

Chapter 32

| Section number | Title | Page |
|--------------------------------|---|------|
| Voltage Reference(VREF) | | |
| 32.1 | Introduction..... | 707 |
| 32.1.1 | Overview..... | 708 |
| 32.1.2 | Features..... | 708 |
| 32.1.3 | Modes of Operation..... | 708 |
| 32.1.4 | VREF Signal Descriptions..... | 709 |
| 32.2 | Memory Map and Register Definition..... | 709 |
| 32.2.1 | VREF Trim Register (VREF_TRM)..... | 709 |
| 32.2.2 | VREF Status and Control Register (VREF_SC)..... | 710 |
| 32.3 | Functional Description..... | 711 |
| 32.3.1 | Voltage Reference Disabled, SC[VREFEN] = 0..... | 712 |
| 32.3.2 | Voltage Reference Enabled, SC[VREFEN] = 1..... | 712 |
| | 32.3.2.1 SC[MODE_LV]=00..... | 712 |
| | 32.3.2.2 SC[MODE_LV] = 01..... | 713 |
| | 32.3.2.3 SC[MODE_LV] = 10..... | 713 |
| | 32.3.2.4 SC[MODE_LV] = 11..... | 713 |
| 32.4 | Initialization/Application Information..... | 714 |

Chapter 33 Timer/PWM Module (TPM)

| | | |
|--------|---|-----|
| 33.1 | Introduction..... | 715 |
| 33.1.1 | TPM Philosophy..... | 715 |
| 33.1.2 | Features..... | 715 |
| 33.1.3 | Modes of operation..... | 716 |
| 33.1.4 | Block diagram..... | 716 |
| 33.2 | TPM Signal Descriptions..... | 717 |
| 33.2.1 | TPM_EXTCLK — TPM External Clock..... | 718 |
| 33.2.2 | TPM_CHn — TPM Channel (n) I/O Pin..... | 718 |
| 33.3 | Memory Map and Register Definition..... | 718 |
| 33.3.1 | Status and Control (TPMx_SC)..... | 720 |

| Section number | Title | Page |
|----------------|---|------|
| 33.3.2 | Counter (TPM _x _CNT)..... | 722 |
| 33.3.3 | Modulo (TPM _x _MOD)..... | 722 |
| 33.3.4 | Channel (n) Status and Control (TPM _x _CnSC)..... | 723 |
| 33.3.5 | Channel (n) Value (TPM _x _CnV)..... | 725 |
| 33.3.6 | Capture and Compare Status (TPM _x _STATUS)..... | 726 |
| 33.3.7 | Combine Channel Register (TPM _x _COMBINE)..... | 728 |
| 33.3.8 | Channel Polarity (TPM _x _POL)..... | 729 |
| 33.3.9 | Filter Control (TPM _x _FILTER)..... | 730 |
| 33.3.10 | Quadrature Decoder Control and Status (TPM _x _QDCTRL)..... | 731 |
| 33.3.11 | Configuration (TPM _x _CONF)..... | 732 |
| 33.4 | Functional description..... | 735 |
| 33.4.1 | Clock domains..... | 735 |
| 33.4.1.1 | Counter Clock Mode..... | 735 |
| 33.4.2 | Prescaler..... | 736 |
| 33.4.3 | Counter..... | 736 |
| 33.4.3.1 | Up counting..... | 736 |
| 33.4.3.2 | Up-down counting..... | 737 |
| 33.4.3.3 | Counter Reset..... | 738 |
| 33.4.3.4 | Global time base (GTB)..... | 738 |
| 33.4.3.5 | Counter trigger..... | 738 |
| 33.4.4 | Input Capture Mode..... | 739 |
| 33.4.5 | Output Compare Mode..... | 740 |
| 33.4.6 | Edge-Aligned PWM (EPWM) Mode..... | 741 |
| 33.4.7 | Center-Aligned PWM (CPWM) Mode..... | 743 |
| 33.4.8 | Combine PWM mode..... | 745 |
| 33.4.9 | Combine Input Capture mode..... | 748 |
| 33.4.10 | Input Capture Filter..... | 749 |
| 33.4.11 | Deadtime insertion..... | 750 |
| 33.4.12 | Quadrature Decoder mode..... | 751 |

| Section number | Title | Page |
|----------------|---|------|
| 33.4.13 | Registers Updated from Write Buffers..... | 755 |
| 33.4.13.1 | MOD Register Update..... | 755 |
| 33.4.13.2 | CnV Register Update..... | 755 |
| 33.4.14 | DMA..... | 756 |
| 33.4.15 | Output triggers..... | 756 |
| 33.4.16 | Reset Overview..... | 757 |
| 33.4.17 | TPM Interrupts..... | 757 |
| 33.4.17.1 | Timer Overflow Interrupt..... | 757 |
| 33.4.17.2 | Channel (n) Interrupt..... | 757 |

Chapter 34 Periodic interrupt timer (PIT)

| | | |
|----------|--|-----|
| 34.1 | Introduction..... | 759 |
| 34.1.1 | Block diagram..... | 759 |
| 34.1.2 | Features..... | 760 |
| 34.2 | Signal description..... | 760 |
| 34.3 | Memory map/register description..... | 761 |
| 34.3.1 | PIT Module Control Register (PIT_MCR)..... | 761 |
| 34.3.2 | PIT Upper Lifetime Timer Register (PIT_LTMR64H)..... | 762 |
| 34.3.3 | PIT Lower Lifetime Timer Register (PIT_LTMR64L)..... | 763 |
| 34.3.4 | Timer Load Value Register (PIT_LDVAL n)..... | 763 |
| 34.3.5 | Current Timer Value Register (PIT_CVAL n)..... | 764 |
| 34.3.6 | Timer Control Register (PIT_TCTRL n)..... | 764 |
| 34.3.7 | Timer Flag Register (PIT_TFLG n)..... | 765 |
| 34.4 | Functional description..... | 766 |
| 34.4.1 | General operation..... | 766 |
| 34.4.1.1 | Timers..... | 766 |
| 34.4.1.2 | Debug mode..... | 767 |
| 34.4.2 | Interrupts..... | 767 |
| 34.4.3 | Chained timers..... | 768 |

| Section number | Title | Page |
|----------------|---|------|
| 34.5 | Initialization and application information..... | 768 |
| 34.6 | Example configuration for chained timers..... | 769 |
| 34.7 | Example configuration for the lifetime timer..... | 770 |

Chapter 35 Low-power timer (LPTMR)

| | | |
|----------|--|-----|
| 35.1 | Introduction..... | 771 |
| 35.1.1 | Features..... | 771 |
| 35.1.2 | Modes of operation..... | 771 |
| 35.2 | LPTMR signal descriptions..... | 772 |
| 35.2.1 | Detailed signal descriptions..... | 772 |
| 35.3 | Memory map and register definition..... | 772 |
| 35.3.1 | Low Power Timer Control Status Register (LPTMR _x _CSR)..... | 773 |
| 35.3.2 | Low Power Timer Prescale Register (LPTMR _x _PSR)..... | 774 |
| 35.3.3 | Low Power Timer Compare Register (LPTMR _x _CMR)..... | 776 |
| 35.3.4 | Low Power Timer Counter Register (LPTMR _x _CNR)..... | 776 |
| 35.4 | Functional description..... | 777 |
| 35.4.1 | LPTMR power and reset..... | 777 |
| 35.4.2 | LPTMR clocking..... | 777 |
| 35.4.3 | LPTMR prescaler/glitch filter..... | 778 |
| 35.4.3.1 | Prescaler enabled..... | 778 |
| 35.4.3.2 | Prescaler bypassed..... | 778 |
| 35.4.3.3 | Glitch filter..... | 778 |
| 35.4.3.4 | Glitch filter bypassed..... | 779 |
| 35.4.4 | LPTMR compare..... | 779 |
| 35.4.5 | LPTMR counter..... | 779 |
| 35.4.6 | LPTMR hardware trigger..... | 780 |
| 35.4.7 | LPTMR interrupt..... | 780 |

Chapter 36 Real Time Clock (RTC)

| Section number | Title | Page |
|----------------|---|------|
| 36.1 | Introduction..... | 781 |
| 36.1.1 | Features..... | 781 |
| 36.1.2 | Modes of operation..... | 781 |
| 36.1.3 | RTC signal descriptions..... | 781 |
| 36.1.3.1 | RTC clock output..... | 782 |
| 36.2 | Register definition..... | 782 |
| 36.2.1 | RTC Time Seconds Register (RTC_TSR)..... | 782 |
| 36.2.2 | RTC Time Prescaler Register (RTC_TPR)..... | 783 |
| 36.2.3 | RTC Time Alarm Register (RTC_TAR)..... | 783 |
| 36.2.4 | RTC Time Compensation Register (RTC_TCR)..... | 784 |
| 36.2.5 | RTC Control Register (RTC_CR)..... | 785 |
| 36.2.6 | RTC Status Register (RTC_SR)..... | 787 |
| 36.2.7 | RTC Lock Register (RTC_LR)..... | 788 |
| 36.2.8 | RTC Interrupt Enable Register (RTC_IER)..... | 789 |
| 36.3 | Functional description..... | 790 |
| 36.3.1 | Power, clocking, and reset..... | 790 |
| 36.3.1.1 | Oscillator control..... | 790 |
| 36.3.1.2 | Software reset..... | 790 |
| 36.3.1.3 | Supervisor access..... | 790 |
| 36.3.2 | Time counter..... | 791 |
| 36.3.3 | Compensation..... | 791 |
| 36.3.4 | Time alarm..... | 792 |
| 36.3.5 | Update mode..... | 792 |
| 36.3.6 | Register lock..... | 793 |
| 36.3.7 | Interrupt..... | 793 |

Chapter 37 Serial Peripheral Interface (SPI)

| | | |
|--------|--------------------|-----|
| 37.1 | Introduction..... | 795 |
| 37.1.1 | Block Diagram..... | 795 |

| Section number | Title | Page |
|----------------|---|------|
| 37.1.2 | Features..... | 796 |
| 37.1.3 | Interface configurations..... | 798 |
| 37.1.3.1 | SPI configuration..... | 798 |
| 37.1.4 | Modes of Operation..... | 798 |
| 37.1.4.1 | Master Mode..... | 799 |
| 37.1.4.2 | Slave Mode..... | 799 |
| 37.1.4.3 | Module Disable Mode..... | 799 |
| 37.1.4.4 | External Stop Mode..... | 799 |
| 37.1.4.5 | Debug Mode..... | 800 |
| 37.2 | Module signal descriptions..... | 800 |
| 37.2.1 | PCS0/SS—Peripheral Chip Select/Slave Select..... | 800 |
| 37.2.2 | PCS1–PCS3—Peripheral Chip Selects 1–3..... | 801 |
| 37.2.3 | SCK—Serial Clock..... | 801 |
| 37.2.4 | SIN—Serial Input..... | 801 |
| 37.2.5 | SOUT—Serial Output..... | 801 |
| 37.3 | Memory Map/Register Definition..... | 802 |
| 37.3.1 | Module Configuration Register (SPLx_MCR)..... | 804 |
| 37.3.2 | Transfer Count Register (SPLx_TCR)..... | 807 |
| 37.3.3 | Clock and Transfer Attributes Register (In Master Mode) (SPLx_CTAR _n)..... | 808 |
| 37.3.4 | Clock and Transfer Attributes Register (In Slave Mode) (SPLx_CTAR _n _SLAVE)..... | 813 |
| 37.3.5 | Status Register (SPLx_SR)..... | 814 |
| 37.3.6 | DMA/Interrupt Request Select and Enable Register (SPLx_RSER)..... | 817 |
| 37.3.7 | PUSH TX FIFO Register In Master Mode (SPLx_PUSHR)..... | 819 |
| 37.3.8 | PUSH TX FIFO Register In Slave Mode (SPLx_PUSHR_SLAVE)..... | 821 |
| 37.3.9 | POP RX FIFO Register (SPLx_POPR)..... | 821 |
| 37.3.10 | Transmit FIFO Registers (SPLx_TXFR _n)..... | 822 |
| 37.3.11 | Receive FIFO Registers (SPLx_RXFR _n)..... | 822 |
| 37.4 | Functional description..... | 823 |
| 37.4.1 | Start and Stop of module transfers..... | 824 |

| Section number | Title | Page |
|----------------|--|------|
| 37.4.2 | Serial Peripheral Interface SPI configuration..... | 824 |
| 37.4.2.1 | Master mode..... | 825 |
| 37.4.2.2 | Slave mode..... | 825 |
| 37.4.2.3 | FIFO disable operation..... | 826 |
| 37.4.2.4 | Transmit First In First Out (TX FIFO) buffering mechanism..... | 826 |
| 37.4.2.5 | Receive First In First Out (RX FIFO) buffering mechanism..... | 827 |
| 37.4.3 | Module baud rate and clock delay generation..... | 828 |
| 37.4.3.1 | Baud rate generator..... | 828 |
| 37.4.3.2 | PCS to SCK Delay (tCSC)..... | 829 |
| 37.4.3.3 | After SCK Delay (tASC)..... | 829 |
| 37.4.3.4 | Delay after Transfer (tDT)..... | 830 |
| 37.4.4 | Transfer formats..... | 830 |
| 37.4.4.1 | Classic SPI Transfer Format (CPHA = 0)..... | 831 |
| 37.4.4.2 | Classic SPI Transfer Format (CPHA = 1)..... | 832 |
| 37.4.4.3 | Modified SPI Transfer Format (MTFE = 1, CPHA = 0)..... | 833 |
| 37.4.4.4 | Modified SPI Transfer Format (MTFE = 1, CPHA = 1)..... | 836 |
| 37.4.4.5 | Continuous Selection Format..... | 837 |
| 37.4.5 | Continuous Serial Communications Clock..... | 839 |
| 37.4.6 | Slave Mode Operation Constraints..... | 841 |
| 37.4.7 | Interrupts/DMA requests..... | 841 |
| 37.4.7.1 | End Of Queue interrupt request..... | 842 |
| 37.4.7.2 | Transmit FIFO Fill Interrupt or DMA Request..... | 842 |
| 37.4.7.3 | Transfer Complete Interrupt Request..... | 843 |
| 37.4.7.4 | Transmit FIFO Underflow Interrupt Request..... | 843 |
| 37.4.7.5 | Receive FIFO Drain Interrupt or DMA Request..... | 843 |
| 37.4.7.6 | Receive FIFO Overflow Interrupt Request..... | 843 |
| 37.4.8 | Power saving features..... | 844 |
| 37.4.8.1 | Stop mode (External Stop mode)..... | 844 |
| 37.4.8.2 | Module Disable mode..... | 844 |

| Section number | Title | Page |
|----------------|--|------|
| 37.5 | Initialization/application information..... | 845 |
| 37.5.1 | How to manage queues..... | 845 |
| 37.5.2 | Switching Master and Slave mode..... | 846 |
| 37.5.3 | Initializing Module in Master/Slave Modes..... | 846 |
| 37.5.4 | Baud rate settings..... | 846 |
| 37.5.5 | Delay settings..... | 847 |
| 37.5.6 | Calculation of FIFO pointer addresses..... | 848 |
| 37.5.6.1 | Address Calculation for the First-in Entry and Last-in Entry in the TX FIFO..... | 849 |
| 37.5.6.2 | Address Calculation for the First-in Entry and Last-in Entry in the RX FIFO..... | 849 |

Chapter 38 Inter-Integrated Circuit (I2C)

| | | |
|---------|---|-----|
| 38.1 | Introduction..... | 851 |
| 38.1.1 | Features..... | 851 |
| 38.1.2 | Modes of operation..... | 852 |
| 38.1.3 | Block diagram..... | 852 |
| 38.2 | I2C signal descriptions..... | 853 |
| 38.3 | Memory map/register definition..... | 853 |
| 38.3.1 | I2C Address Register 1 (I2Cx_A1)..... | 855 |
| 38.3.2 | I2C Frequency Divider register (I2Cx_F)..... | 855 |
| 38.3.3 | I2C Control Register 1 (I2Cx_C1)..... | 856 |
| 38.3.4 | I2C Status register (I2Cx_S)..... | 858 |
| 38.3.5 | I2C Data I/O register (I2Cx_D)..... | 860 |
| 38.3.6 | I2C Control Register 2 (I2Cx_C2)..... | 860 |
| 38.3.7 | I2C Programmable Input Glitch Filter Register (I2Cx_FLT)..... | 861 |
| 38.3.8 | I2C Range Address register (I2Cx_RA)..... | 863 |
| 38.3.9 | I2C SMBus Control and Status register (I2Cx_SMB)..... | 863 |
| 38.3.10 | I2C Address Register 2 (I2Cx_A2)..... | 865 |
| 38.3.11 | I2C SCL Low Timeout Register High (I2Cx_SLTH)..... | 865 |
| 38.3.12 | I2C SCL Low Timeout Register Low (I2Cx_SLTL)..... | 866 |

| Section number | Title | Page |
|----------------|--|------|
| 38.3.13 | I2C Status register 2 (I2Cx_S2)..... | 866 |
| 38.4 | Functional description..... | 867 |
| 38.4.1 | I2C protocol..... | 867 |
| 38.4.1.1 | START signal..... | 868 |
| 38.4.1.2 | Slave address transmission..... | 868 |
| 38.4.1.3 | Data transfers..... | 869 |
| 38.4.1.4 | STOP signal..... | 869 |
| 38.4.1.5 | Repeated START signal..... | 869 |
| 38.4.1.6 | Arbitration procedure..... | 870 |
| 38.4.1.7 | Clock synchronization..... | 870 |
| 38.4.1.8 | Handshaking..... | 871 |
| 38.4.1.9 | Clock stretching..... | 871 |
| 38.4.1.10 | I2C divider and hold values..... | 871 |
| 38.4.2 | 10-bit address..... | 872 |
| 38.4.2.1 | Master-transmitter addresses a slave-receiver..... | 873 |
| 38.4.2.2 | Master-receiver addresses a slave-transmitter..... | 873 |
| 38.4.3 | Address matching..... | 874 |
| 38.4.4 | System management bus specification..... | 875 |
| 38.4.4.1 | Timeouts..... | 875 |
| 38.4.4.2 | FAST ACK and NACK..... | 877 |
| 38.4.5 | Resets..... | 877 |
| 38.4.6 | Interrupts..... | 877 |
| 38.4.6.1 | Byte transfer interrupt..... | 878 |
| 38.4.6.2 | Address detect interrupt..... | 878 |
| 38.4.6.3 | Stop Detect Interrupt..... | 879 |
| 38.4.6.4 | Exit from low-power/stop modes..... | 879 |
| 38.4.6.5 | Arbitration lost interrupt..... | 879 |
| 38.4.6.6 | Timeout interrupt in SMBus..... | 879 |
| 38.4.7 | Programmable input glitch filter..... | 880 |

| Section number | Title | Page |
|----------------|---|------|
| 38.4.8 | Address matching wake-up..... | 880 |
| 38.4.9 | DMA support..... | 881 |
| 38.4.10 | Double buffering mode..... | 881 |
| 38.5 | Initialization/application information..... | 882 |

Chapter 39

Low Power Universal Asynchronous Receiver/Transmitter (LPUART0)

| | | |
|----------|--|-----|
| 39.1 | Introduction..... | 887 |
| 39.1.1 | Features..... | 887 |
| 39.1.2 | Modes of operation..... | 888 |
| 39.1.2.1 | Wait mode..... | 888 |
| 39.1.3 | Signal Descriptions..... | 888 |
| 39.1.4 | Block diagram..... | 888 |
| 39.2 | Register definition..... | 890 |
| 39.2.1 | LPUART Baud Rate Register (LPUARTx_BAUD)..... | 891 |
| 39.2.2 | LPUART Status Register (LPUARTx_STAT)..... | 893 |
| 39.2.3 | LPUART Control Register (LPUARTx_CTRL)..... | 897 |
| 39.2.4 | LPUART Data Register (LPUARTx_DATA)..... | 902 |
| 39.2.5 | LPUART Match Address Register (LPUARTx_MATCH)..... | 904 |
| 39.2.6 | LPUART Modem IrDA Register (LPUARTx_MODIR)..... | 904 |
| 39.3 | Functional description..... | 906 |
| 39.3.1 | Baud rate generation..... | 906 |
| 39.3.2 | Transmitter functional description..... | 907 |
| 39.3.2.1 | Send break and queued idle..... | 908 |
| 39.3.2.2 | Hardware flow control..... | 909 |
| 39.3.2.3 | Transceiver driver enable..... | 909 |
| 39.3.2.4 | Transceiver driver enable using LPUART_RTS..... | 910 |
| 39.3.3 | Receiver functional description..... | 910 |
| 39.3.3.1 | Data sampling technique..... | 911 |
| 39.3.3.2 | Receiver wakeup operation..... | 912 |

| Section number | Title | Page |
|----------------|---|------|
| 39.3.3.3 | Hardware flow control..... | 916 |
| 39.3.3.4 | Infrared decoder..... | 916 |
| 39.3.4 | Additional LPUART functions..... | 917 |
| 39.3.4.1 | 8-bit, 9-bit and 10-bit data modes..... | 917 |
| 39.3.4.2 | Idle length..... | 918 |
| 39.3.4.3 | Loop mode..... | 918 |
| 39.3.4.4 | Single-wire operation..... | 919 |
| 39.3.5 | Infrared interface..... | 919 |
| 39.3.5.1 | Infrared transmit encoder..... | 920 |
| 39.3.5.2 | Infrared receive decoder..... | 920 |
| 39.3.6 | Interrupts and status flags..... | 920 |
| 39.4 | LPUART changes..... | 921 |

Chapter 40 Carrier Modulator Transmitter (CMT)

| | | |
|----------|--|-----|
| 40.1 | Introduction..... | 923 |
| 40.2 | Features..... | 923 |
| 40.3 | Block diagram..... | 924 |
| 40.4 | Modes of operation..... | 925 |
| 40.4.1 | Wait mode operation..... | 926 |
| 40.4.2 | Stop mode operation..... | 926 |
| 40.4.2.1 | Normal Stop mode operation..... | 926 |
| 40.4.2.2 | Low-Power Stop mode operation..... | 926 |
| 40.5 | CMT external signal descriptions..... | 926 |
| 40.5.1 | CMT_IRO — Infrared Output..... | 927 |
| 40.6 | Memory map/register definition..... | 927 |
| 40.6.1 | CMT Carrier Generator High Data Register 1 (CMT_CGH1)..... | 928 |
| 40.6.2 | CMT Carrier Generator Low Data Register 1 (CMT_CGL1)..... | 929 |
| 40.6.3 | CMT Carrier Generator High Data Register 2 (CMT_CGH2)..... | 929 |
| 40.6.4 | CMT Carrier Generator Low Data Register 2 (CMT_CGL2)..... | 930 |

| Section number | Title | Page |
|----------------|--|------|
| 40.6.5 | CMT Output Control Register (CMT_OC)..... | 930 |
| 40.6.6 | CMT Modulator Status and Control Register (CMT_MSC)..... | 931 |
| 40.6.7 | CMT Modulator Data Register Mark High (CMT_CMD1)..... | 933 |
| 40.6.8 | CMT Modulator Data Register Mark Low (CMT_CMD2)..... | 934 |
| 40.6.9 | CMT Modulator Data Register Space High (CMT_CMD3)..... | 934 |
| 40.6.10 | CMT Modulator Data Register Space Low (CMT_CMD4)..... | 935 |
| 40.6.11 | CMT Primary Prescaler Register (CMT_PPS)..... | 935 |
| 40.6.12 | CMT Direct Memory Access Register (CMT_DMA)..... | 936 |
| 40.7 | Functional description..... | 937 |
| 40.7.1 | Clock divider..... | 937 |
| 40.7.2 | Carrier generator..... | 937 |
| 40.7.3 | Modulator..... | 940 |
| 40.7.3.1 | Time mode..... | 941 |
| 40.7.3.2 | Baseband mode..... | 942 |
| 40.7.3.3 | FSK mode..... | 943 |
| 40.7.4 | Extended space operation..... | 944 |
| 40.7.4.1 | EXSPC operation in Time mode..... | 944 |
| 40.7.4.2 | EXSPC operation in FSK mode..... | 945 |
| 40.8 | CMT interrupts and DMA..... | 946 |

Chapter 41 General-purpose input/output (GPIO)

| | | |
|----------|---|-----|
| 41.1 | Introduction..... | 949 |
| 41.1.1 | Features..... | 949 |
| 41.1.2 | Modes of operation..... | 950 |
| 41.1.3 | GPIO signal descriptions..... | 950 |
| 41.1.3.1 | Detailed signal description..... | 950 |
| 41.2 | Memory map and register definition..... | 951 |
| 41.2.1 | Port Data Output Register (GPIOx_PDOR)..... | 952 |
| 41.2.2 | Port Set Output Register (GPIOx_PSOR)..... | 953 |

| Section number | Title | Page |
|----------------|---|------|
| 41.2.3 | Port Clear Output Register (GPIOx_PCOR)..... | 953 |
| 41.2.4 | Port Toggle Output Register (GPIOx_PTOR)..... | 954 |
| 41.2.5 | Port Data Input Register (GPIOx_PDIR)..... | 954 |
| 41.2.6 | Port Data Direction Register (GPIOx_PDDR)..... | 955 |
| 41.3 | FGPIO memory map and register definition..... | 955 |
| 41.3.1 | Port Data Output Register (FGPIOx_PDOR)..... | 957 |
| 41.3.2 | Port Set Output Register (FGPIOx_PSOR)..... | 957 |
| 41.3.3 | Port Clear Output Register (FGPIOx_PCOR)..... | 958 |
| 41.3.4 | Port Toggle Output Register (FGPIOx_PTOR)..... | 958 |
| 41.3.5 | Port Data Input Register (FGPIOx_PDIR)..... | 959 |
| 41.3.6 | Port Data Direction Register (FGPIOx_PDDR)..... | 959 |
| 41.4 | Functional description..... | 959 |
| 41.4.1 | General-purpose input..... | 959 |
| 41.4.2 | General-purpose output..... | 960 |
| 41.4.3 | IOPORT..... | 960 |

Chapter 42 Touch Sensing Input (TSI)

| | | |
|--------|---|-----|
| 42.1 | Introduction..... | 961 |
| 42.1.1 | Features..... | 961 |
| 42.1.2 | Modes of operation..... | 962 |
| 42.1.3 | Block diagram..... | 962 |
| 42.2 | External signal description..... | 963 |
| 42.2.1 | TSI[15:0]..... | 963 |
| 42.3 | Register definition..... | 964 |
| 42.3.1 | TSI General Control and Status Register (TSIx_GENCS)..... | 964 |
| 42.3.2 | TSI DATA Register (TSIx_DATA)..... | 969 |
| 42.3.3 | TSI Threshold Register (TSIx_TSHD)..... | 970 |
| 42.4 | Functional description..... | 970 |
| 42.4.1 | Capacitance measurement..... | 971 |

| Section number | Title | Page |
|----------------|--|------|
| 42.4.1.1 | TSI electrode oscillator..... | 971 |
| 42.4.1.2 | Electrode oscillator and counter module control..... | 972 |
| 42.4.1.3 | TSI reference oscillator..... | 973 |
| 42.4.2 | TSI measurement result..... | 974 |
| 42.4.3 | Enable TSI module..... | 974 |
| 42.4.4 | Software and hardware trigger..... | 974 |
| 42.4.5 | Scan times..... | 975 |
| 42.4.6 | Clock setting..... | 975 |
| 42.4.7 | Reference voltage..... | 975 |
| 42.4.8 | Current source..... | 976 |
| 42.4.9 | End of scan..... | 976 |
| 42.4.10 | Out-of-range interrupt..... | 976 |
| 42.4.11 | Wake up MCU from low power modes..... | 977 |
| 42.4.12 | DMA function support..... | 977 |
| 42.4.13 | Noise detection mode..... | 977 |
| 42.4.13.1 | Automatic noise mode..... | 983 |
| 42.4.13.2 | Single threshold noise modes..... | 985 |

Chapter 43 LP Trusted Cryptography (LTC)

| | | |
|----------|---|-----|
| 43.1 | LP Trusted Cryptography Block Diagram..... | 987 |
| 43.2 | Feature summary..... | 987 |
| 43.3 | AES accelerator (AESA) functionality..... | 988 |
| 43.3.1 | Differences between the AES encrypt and decrypt keys..... | 988 |
| 43.3.2 | AESA modes of operation..... | 989 |
| 43.3.3 | AESA use of registers..... | 989 |
| 43.3.4 | AES ECB mode..... | 990 |
| 43.3.4.1 | AES ECB mode use of the Mode Register..... | 990 |
| 43.3.4.2 | AES ECB mode use of the Context Register..... | 990 |
| 43.3.4.3 | AES ECB Mode use of the Data Size Register | 990 |

| Section number | Title | Page |
|----------------|--|------|
| 43.3.4.4 | AES ECB Mode use of the Key Register..... | 990 |
| 43.3.4.5 | AES ECB Mode use of the Key Size Register..... | 991 |
| 43.3.5 | AES CBC mode..... | 991 |
| 43.3.5.1 | AES CBC mode use of the Mode Register..... | 991 |
| 43.3.5.2 | AES CBC mode use of the Context Register..... | 991 |
| 43.3.5.3 | AES CBC mode use of the Data Size Register..... | 992 |
| 43.3.5.4 | AES CBC mode use of the Key Register..... | 992 |
| 43.3.5.5 | AES CBC mode use of the Key Size Register..... | 992 |
| 43.3.6 | AES CTR mode..... | 993 |
| 43.3.6.1 | AES CTR mode use of the Mode Register..... | 993 |
| 43.3.6.2 | AES CTR mode use of the Context Register..... | 993 |
| 43.3.6.3 | AES CTR mode use of the Data Size Register..... | 994 |
| 43.3.6.4 | AES CTR mode use of the Key Register..... | 994 |
| 43.3.6.5 | AES CTR mode use of the Key Size Register..... | 994 |
| 43.3.7 | AES XCBC-MAC and CMAC modes..... | 994 |
| 43.3.7.1 | AES XCBC-MAC and CMAC modes use of the Mode Register..... | 995 |
| 43.3.7.2 | AES XCBC-MAC and CMAC Modes use of the Context Register..... | 996 |
| 43.3.7.3 | AES XCBC-MAC and CMAC modes use of the ICV Size Register..... | 997 |
| 43.3.7.4 | AES XCBC-MAC and CMAC modes use of the Data Size Register..... | 997 |
| 43.3.7.5 | AES XCBC-MAC and CMAC modes use of the Key Register..... | 997 |
| 43.3.7.6 | AES XCBC-MAC and CMAC modes use of the Key Size Register..... | 998 |
| 43.3.7.7 | ICV checking in AES XCBC-MAC and CMAC modes..... | 998 |
| 43.3.8 | AESA CCM and CCM* modes..... | 998 |
| 43.3.8.1 | Generation encryption..... | 998 |
| 43.3.8.2 | Decryption verification..... | 999 |
| 43.3.8.3 | AES CCM and CCM* mode use of the Mode Register..... | 999 |
| 43.3.8.4 | AES CCM and CCM* modes use of the Context Register..... | 1000 |
| 43.3.8.5 | AES CCM and CCM* mode use of the Data Size Register..... | 1002 |
| 43.3.8.6 | AES CCM and CCM* mode use of the Key Register..... | 1002 |

| Section number | Title | Page |
|----------------|---|------|
| 43.3.8.7 | AES CCM and CCM* mode use of the Key Size Register..... | 1002 |
| 43.3.8.8 | AES CCM and CCM* mode use of the ICV check..... | 1002 |
| 43.4 | LTC Register Descriptions..... | 1003 |
| 43.4.1 | LTC Memory Map..... | 1003 |
| 43.4.2 | LTC Mode (LTC0_MD)..... | 1004 |
| 43.4.2.1 | Address..... | 1004 |
| 43.4.2.2 | Function..... | 1004 |
| 43.4.2.3 | Diagram..... | 1004 |
| 43.4.2.4 | Fields..... | 1005 |
| 43.4.3 | LTC Key Size (LTC0_KS)..... | 1006 |
| 43.4.3.1 | Address..... | 1006 |
| 43.4.3.2 | Function..... | 1006 |
| 43.4.3.3 | Diagram..... | 1007 |
| 43.4.3.4 | Fields..... | 1007 |
| 43.4.4 | LTC Data Size (LTC0_DS)..... | 1007 |
| 43.4.4.1 | Address..... | 1007 |
| 43.4.4.2 | Function..... | 1007 |
| 43.4.4.3 | Diagram..... | 1008 |
| 43.4.4.4 | Fields..... | 1008 |
| 43.4.5 | LTC ICV Size (LTC0_ICVS)..... | 1008 |
| 43.4.5.1 | Address..... | 1008 |
| 43.4.5.2 | Function..... | 1009 |
| 43.4.5.3 | Diagram..... | 1009 |
| 43.4.5.4 | Fields..... | 1009 |
| 43.4.6 | LTC Command (LTC0_COM)..... | 1009 |
| 43.4.6.1 | Address..... | 1010 |
| 43.4.6.2 | Function..... | 1010 |
| 43.4.6.3 | Diagram..... | 1010 |
| 43.4.6.4 | Fields..... | 1010 |

| Section number | Title | Page |
|----------------|-----------------------------------|------|
| 43.4.7 | LTC Control (LTC0_CTL)..... | 1011 |
| 43.4.7.1 | Address..... | 1011 |
| 43.4.7.2 | Function..... | 1011 |
| 43.4.7.3 | Diagram..... | 1012 |
| 43.4.7.4 | Fields..... | 1012 |
| 43.4.8 | LTC Clear Written (LTC0_CW)..... | 1013 |
| 43.4.8.1 | Address..... | 1013 |
| 43.4.8.2 | Function..... | 1014 |
| 43.4.8.3 | Diagram..... | 1014 |
| 43.4.8.4 | Fields..... | 1014 |
| 43.4.9 | LTC Status (LTC0_STA)..... | 1015 |
| 43.4.9.1 | Address..... | 1015 |
| 43.4.9.2 | Function..... | 1015 |
| 43.4.9.3 | Diagram..... | 1015 |
| 43.4.9.4 | Fields..... | 1015 |
| 43.4.10 | LTC Error Status (LTC0_ESTA)..... | 1017 |
| 43.4.10.1 | Address..... | 1017 |
| 43.4.10.2 | Function..... | 1017 |
| 43.4.10.3 | Diagram..... | 1017 |
| 43.4.10.4 | Fields..... | 1018 |
| 43.4.11 | LTC AAD Size (LTC0_AADSZ)..... | 1018 |
| 43.4.11.1 | Address..... | 1018 |
| 43.4.11.2 | Function..... | 1019 |
| 43.4.11.3 | Diagram..... | 1019 |
| 43.4.11.4 | Fields..... | 1019 |
| 43.4.12 | LTC Context (LTC0_CTX_a)..... | 1020 |
| 43.4.12.1 | Address..... | 1020 |
| 43.4.12.2 | Function..... | 1020 |
| 43.4.12.3 | Diagram..... | 1020 |

| Section number | Title | Page |
|----------------|---------------------------------------|------|
| 43.4.12.4 | Fields..... | 1021 |
| 43.4.13 | LTC Keys (LTC0_KEY_a)..... | 1021 |
| 43.4.13.1 | Address..... | 1021 |
| 43.4.13.2 | Function..... | 1021 |
| 43.4.13.3 | Diagram..... | 1022 |
| 43.4.13.4 | Fields..... | 1022 |
| 43.4.14 | LTC Version ID (LTC0_VID1)..... | 1022 |
| 43.4.14.1 | Address..... | 1022 |
| 43.4.14.2 | Function..... | 1022 |
| 43.4.14.3 | Diagram..... | 1023 |
| 43.4.14.4 | Fields..... | 1023 |
| 43.4.15 | LTC Version ID 2 (LTC0_VID2)..... | 1023 |
| 43.4.15.1 | Address..... | 1023 |
| 43.4.15.2 | Function..... | 1023 |
| 43.4.15.3 | Diagram..... | 1023 |
| 43.4.15.4 | Fields..... | 1024 |
| 43.4.16 | LTC CHA Version ID (LTC0_CHAVID)..... | 1024 |
| 43.4.16.1 | Address..... | 1024 |
| 43.4.16.2 | Function..... | 1024 |
| 43.4.16.3 | Diagram..... | 1024 |
| 43.4.16.4 | Fields..... | 1025 |
| 43.4.17 | LTC FIFO Status (LTC0_FIFOSTA)..... | 1025 |
| 43.4.17.1 | Address..... | 1025 |
| 43.4.17.2 | Function..... | 1025 |
| 43.4.17.3 | Diagram..... | 1026 |
| 43.4.17.4 | Fields..... | 1026 |
| 43.4.18 | LTC Input Data FIFO (LTC0_IFIFO)..... | 1026 |
| 43.4.18.1 | Address..... | 1026 |
| 43.4.18.2 | Function..... | 1027 |

| Section number | Title | Page |
|----------------|--|------|
| 43.4.18.3 | Diagram..... | 1027 |
| 43.4.18.4 | Fields..... | 1027 |
| 43.4.19 | LTC Output Data FIFO (LTC0_OFIFO)..... | 1027 |
| 43.4.19.1 | Address..... | 1027 |
| 43.4.19.2 | Function..... | 1028 |
| 43.4.19.3 | Diagram..... | 1028 |
| 43.4.19.4 | Fields..... | 1028 |

Chapter 44 True Random Number Generator (TRNG)

| | | |
|----------|--|------|
| 44.1 | Standalone True Random Number Generator (SA-TRNG)..... | 1029 |
| 44.1.1 | Standalone True Random Number Generator Block Diagram..... | 1029 |
| 44.1.2 | TRNG Functional Description..... | 1030 |
| 44.1.3 | SA-TRNG hardware functional description..... | 1031 |
| 44.1.3.1 | Software Use Cases for the Stand Alone TRNG..... | 1031 |
| 44.1.3.2 | Register interface (IP Slave bus)..... | 1032 |
| 44.1.3.3 | TRNG0 Register Descriptions..... | 1033 |
| 44.1.4 | Another TRNG usage example..... | 1082 |

Chapter 45 2.4 GHz Multi-Protocol Radio

| | | |
|----------|---|------|
| 45.1 | Introduction..... | 1083 |
| 45.2 | Radio Register Overview..... | 1084 |
| 45.2.1 | RSIM Memory Map and Register Definition..... | 1084 |
| 45.2.1.1 | RSIM Register Descriptions..... | 1085 |
| 45.2.2 | Transceiver Memory Map and Register Definition..... | 1106 |
| 45.2.2.1 | XCVR_TX_DIG Register Descriptions..... | 1106 |
| 45.2.2.2 | XCVR_PLL_DIG Register Descriptions..... | 1116 |
| 45.2.2.3 | XCVR_RX_DIG Register Descriptions..... | 1138 |
| 45.2.2.4 | XCVR_TSM Register Descriptions..... | 1232 |
| 45.2.2.5 | XCVR_MISC Register Descriptions..... | 1318 |

| Section number | Title | Page |
|-----------------------|--|-------------|
| 45.2.2.6 | XCVR_PHY Register Descriptions..... | 1340 |
| 45.2.2.7 | XCVR_ZBDEMOD Register Descriptions..... | 1352 |
| 45.2.3 | Link Layer Memory Map and Register Definition..... | 1359 |
| 45.2.3.1 | BLE Register Descriptions..... | 1359 |
| 45.2.3.2 | BLE_RF Register Descriptions..... | 1486 |
| 45.2.3.3 | ZLL Register Descriptions..... | 1489 |
| 45.2.3.4 | GENERIC_FSK Register Descriptions..... | 1546 |
| 45.3 | Radio System Integration Module..... | 1580 |
| 45.3.1 | Introduction..... | 1580 |
| 45.3.1.1 | Features..... | 1580 |
| 45.3.1.2 | Modes and Operations..... | 1581 |
| 45.3.1.3 | Radio Registers Access (CAUTION)..... | 1581 |
| 45.3.1.4 | Interrupts..... | 1583 |
| 45.3.1.5 | Block diagram..... | 1583 |
| 45.3.1.6 | Radio Clocks diagram..... | 1585 |
| 45.3.2 | Memory Map and Register Definition..... | 1585 |
| 45.3.2.1 | RSIM Register Descriptions..... | 1586 |
| 45.4 | Transceiver Digital..... | 1607 |
| 45.4.1 | Transmitter Digital Module..... | 1607 |
| 45.4.1.1 | Introduction..... | 1607 |
| 45.4.1.2 | Data Pre-Processing..... | 1610 |
| 45.4.1.3 | GFSK Modulator..... | 1612 |
| 45.4.1.4 | FSK Modulator..... | 1614 |
| 45.4.1.5 | Data Post-Processing..... | 1617 |
| 45.4.1.6 | Memory Map and Register Definition..... | 1620 |
| 45.4.2 | PLL Frequency Synthesizer..... | 1630 |
| 45.4.2.1 | About the PLL Frequency Synthesizer..... | 1630 |
| 45.4.2.2 | Carrier Frequency Tuning..... | 1632 |
| 45.4.2.3 | VCO Calibration..... | 1636 |

| Section number | Title | Page |
|-----------------------|---|-------------|
| 45.4.2.4 | High Port Modulation..... | 1637 |
| 45.4.2.5 | Low Port Modulation..... | 1639 |
| 45.4.2.6 | Lock Detector..... | 1641 |
| 45.4.2.7 | Memory Map and Register Definition..... | 1648 |
| 45.4.3 | Receiver Digital Module..... | 1671 |
| 45.4.3.1 | Introduction..... | 1672 |
| 45.4.3.2 | Functional description..... | 1673 |
| 45.4.3.3 | Memory Map and register definition..... | 1719 |
| 45.4.4 | Bit Streaming Mode..... | 1810 |
| 45.4.4.1 | Introduction..... | 1810 |
| 45.4.4.2 | External Signal Descriptions..... | 1812 |
| 45.4.4.3 | Memory Map and Register Definition..... | 1813 |
| 45.4.4.4 | Functional Description..... | 1814 |
| 45.4.5 | Transceiver Sequence Manager..... | 1816 |
| 45.4.5.1 | Introduction..... | 1816 |
| 45.4.5.2 | Functional description..... | 1818 |
| 45.4.5.3 | Memory Map and register definition..... | 1859 |
| 45.4.6 | Transceiver DMA and Packet RAM Debug Modes..... | 1945 |
| 45.4.6.1 | Introduction..... | 1945 |
| 45.4.6.2 | Memory Map and Register Definition..... | 1947 |
| 45.4.6.3 | Functional Description..... | 1950 |
| 45.4.6.4 | Clocks..... | 1965 |
| 45.4.6.5 | Reset..... | 1966 |
| 45.4.6.6 | Interrupts..... | 1966 |
| 45.4.7 | Transceiver Memory Map and Register Definition..... | 1966 |
| 45.4.7.1 | XCVR_MISC Register Descriptions..... | 1966 |
| 45.4.7.2 | XCVR_PHY Register Descriptions..... | 1988 |
| 45.4.7.3 | XCVR_ZBDEMOD Register Descriptions..... | 2000 |
| 45.5 | Transceiver Analog..... | 2007 |

| Section number | Title | Page |
|----------------|---|------|
| 45.5.1 | Introduction..... | 2007 |
| 45.5.1.1 | Features..... | 2007 |
| 45.5.1.2 | Block diagram..... | 2008 |
| 45.5.2 | Functional description..... | 2008 |
| 45.5.2.1 | XO Block..... | 2009 |
| 45.6 | Link Layer..... | 2010 |
| 45.6.1 | BLE Link Layer..... | 2010 |
| 45.6.1.1 | BLE Register Descriptions..... | 2010 |
| 45.6.1.2 | BLE_RF Register Descriptions..... | 2138 |
| 45.6.2 | 802.15.4 Link Layer Controller..... | 2141 |
| 45.6.2.1 | Introduction..... | 2141 |
| 45.6.2.2 | Overview..... | 2141 |
| 45.6.2.3 | Block Diagram..... | 2141 |
| 45.6.2.4 | Functional Description..... | 2142 |
| 45.6.2.5 | Packet Processor..... | 2142 |
| 45.6.2.6 | 802.15.4 Sequence Manager (ZSM)..... | 2184 |
| 45.6.2.7 | Packet Storage..... | 2229 |
| 45.6.2.8 | Memory Mapping..... | 2232 |
| 45.6.2.9 | Event Timer..... | 2233 |
| 45.6.2.10 | Deep Sleep Mode..... | 2240 |
| 45.6.2.11 | CCA/ED/LQI..... | 2244 |
| 45.6.2.12 | Fast Antenna Diversity (FAD)..... | 2251 |
| 45.6.2.13 | Interrupts..... | 2262 |
| 45.6.2.14 | BSM..... | 2270 |
| 45.6.2.15 | ZLL Register Descriptions..... | 2274 |
| 45.6.3 | Generic_FSK Link Layer Controller..... | 2331 |
| 45.6.3.1 | Introduction..... | 2331 |
| 45.6.3.2 | Memory Map and Register Definition..... | 2333 |
| 45.6.3.3 | Functional Description..... | 2374 |

Section number

Title

Page

Chapter 46
Revision History

46.1 Revision History..... 2423



Chapter 1

Introduction

This section provides high-level descriptions of the modules available on the devices covered by this document.

1.1 Introduction

The KW41Z is an ultra low power, highly integrated single-chip device that enables Bluetooth low energy (BLE), IEEE Std. 802.15.4 RF and Generic FSK connectivity for portable, extremely low-power embedded systems. Applications include portable health care devices, wearable sports and fitness devices, AV remote controls, computer keyboards and mice, gaming controllers, access control, security systems, smart energy and home area networks.

The KW41Z SoC integrates a radio transceiver operating in the 2.36GHz to 2.48GHz range supporting a range of FSK/GFSK and O-QPSK modulations, an ARM Cortex-M0+ CPU, up to 512 KB Flash and up to 128 KB SRAM, BLE Link Layer hardware, 802.15.4 packet processor hardware, Generic FSK Link layer controller hardware and peripherals optimized to meet the requirements of the target applications.

The KW41Z's radio frequency transceiver is compliant with Bluetooth version 4.2 for Low Energy (aka Bluetooth Smart or BLE), Generic FSK and the IEEE 802.15.4 standard using O-QPSK in the 2.4 GHz ISM band and the MBAN frequency range spanning from 2.36 GHz to 2.40 GHz. In addition, the KW41Z allows the Bluetooth Low Energy protocol to be used in the MBAN frequency range for proprietary applications.

The KW41Z can be used in applications as a "BlackBox" modem in order to add BLE or IEEE Std. 802.15.4 or Generic FSK connectivity to an existing embedded controller system, or may be used as a stand-alone smart wireless sensor with embedded application where no host controller is required.

KW41Z has 512/256 KB of on-chip Flash and 128/64 KB of on-chip SRAM memory available to be used by customer applications and chosen communication protocol stack using a choice of either NXP or 3rd party software development tools.

The RF section of the KW41Z is optimized to require very few external components, achieving the smallest RF footprint possible on a printed circuit board.

Extremely long battery life is achieved through efficiency of code execution in the Cortex-M0+ CPU core and the multiple low power operating modes of the KW41Z.

Additionally, an integrated DC-DC converter enables a wide operating range from 0.9 V to 4.2 V. The DC-DC in Buck mode allows KW41Z to operate from a single coin cell battery with a significant reduction of peak Rx and Tx current consumption. The DC-DC in boost mode allows a single alkaline battery to be used throughout its entire useful voltage range of 0.9 V to 1.795 V.

Table 1-1. KW41Z/31Z/21Z Part Numbers

| Device | Part Marking | Memory Configuration | Package | Description |
|------------------|---------------|-----------------------------|------------------------|--|
| MKW21Z512VHT4(R) | M21W9VT4 | 512 KB Flash 128 KB SRAM | 48-pin Laminate QFN | IEEE 802.15.4 |
| MKW21Z256VHT4(R) | M21W8VT4 | 256 KB Flash 64 KB SRAM | | |
| MKW31Z512CAT4(R) | MKW31Z512CAT4 | 512 KB Flash 128 KB SRAM | 75-pin WLCSP | Bluetooth Low Energy and Generic FSK |
| MKW31Z512VHT4(R) | M31W9VT4 | 512 KB Flash 128 KB SRAM | 48-pin Laminate QFN | Bluetooth Low Energy and Generic FSK |
| MKW31Z256VHT4(R) | M31W8VT4 | 256 KB Flash 64 KB SRAM | | |
| MKW41Z512CAT4(R) | MKW41Z512CAT4 | 512 KB Flash 128 KB SRAM | 75-pin WLCSP | Bluetooth Low Energy and IEEE 802.15.4 and Generic FSK |
| MKW41Z512VHT4(R) | M41W9VT4 | 512 KB Flash 128 KB SRAM | 48-pin Laminate QFN | Bluetooth Low Energy and IEEE 802.15.4 and Generic FSK |
| MKW41Z256VHT4(R) | M41W8VT4 | 256 KB Flash 64 KB SRAM | | |

1.2 Features Overview

The following section lists the features of the devices.

32-bit Cortex M0+ (enhanced M0) Central Processor Unit (CPU)

- Up to 48 MHz core frequency across temperature range of
 - WLCSP temperature rating: -40 °C to 85 °C
 - QFN temperature rating: -40 °C to 105 °C
- Supports up to 32 interrupt request sources

- 2-stage pipeline microarchitecture for reduced power consumption and improved architectural performance (cycles per instruction)
- Bit Manipulation Engine (BME) for improved bit handling of peripheral modules
- Binary compatible instruction set architecture with the Cortex M0+ core
- Thumb instruction set combines high code density with 32-bit performance
- Serial Wire Debug (SWD) reduces the number of pins required for debugging
- Micro Trace Buffer (MTB) provides lightweight program trace capabilities using system RAM as the destination memory

Input Voltage operation

- DCDC in Buck configurations supports 1.8 V to 4.25 V
- DCDC in Boost configuration supports 0.9 V to 1.795 V.
- Bypass Mode 1.7 V to 3.6 V (1.45 V - 3.6 V for the RF and 32 MHz OSC supplies)

On-chip Memory

- 512 KB of Flash memory, read/program/erase over full operating voltage and temperature
- 128 KB of Low Power Random access memory (SRAM). Memory retention in most low power modes
- Security circuitry to prevent unauthorized access to SRAM and Flash contents

Power-Saving

- Multiple power modes including low leakage state-retention and memory-retention modes
- Peripheral clock enable registers can disable clocks to unused modules, reducing currents.

System Clock Source Options

- Reference Oscillator — crystal reference oscillator, supports 32 MHz
- 32 kHz Oscillator — 32.768 kHz crystal reference oscillator
- Multipurpose Clock Generator(MCG)
 - Frequency-locked loop (FLL) controlled by internal or external reference
 - 20 MHz to 48 MHz FLL output
 - Internal reference clocks — Can be used as a clock source for other on-chip peripherals
 - On-chip RC oscillator range of 31.25 kHz to 39.0625 kHz with 2% accuracy across full temperature range
 - On-chip 4 MHz oscillator with 5% accuracy across full temperature range.

System Protection

- Standard Watchdog reset with option to run from dedicated 1 kHz internal clock source or bus clock
- Low-voltage detection with reset or interrupt; selectable trip points
- HardFault exception on attempts to execute undefined instructions or access to undefined memory space
- LOCKUP reset resource from core
- Flash Read\Write protection
- Firmware distribution protection: Flash can be marked execute-only on a per-segment (8 KB) basis to prevent firmware contents from being read by third parties.

Development Support

- Two-wire Serial Wire Debug interface
- Breakpoint unit supporting up to 2 hardware breakpoints
- Watchpoint unit supporting up to 2 watchpoints
- Micro Trace Buffer provides program trace capabilities

Peripherals

- DMA — 4-channel DMA. Bus master provides very configurable source-to-destination data movement capabilities supporting either software-triggered or peripheral-paced transfers
- ADC — up to 5 external channels, 16-bit resolution analog-to-digit converter, fully functional in the entire voltage range. Performance for the ADC depends on package pinout.
- DAC — 12-bit resolution.
- VREF — Voltage reference supply accurate voltage output that can be trimmed in 0.5 mV steps.
- HSCMP — high speed comparator with internal 6-bit DAC
- PIT — 2-channel 32-bit timer module that can be used to assert interrupts or to provide one more time base.
- LPTPM — One 4-channel, and two 2-channel; Basic TPM function. Timer/Pulse-Width Modulator Module supporting input capture, output compare.
- LPTMR — Low Power Timer that can wakeup CPU from all low power modes
- RTC — Robust 32-bit Real Timer Clock with hardware compensation
- CMT — Carrier Modulation Timer used to drive IR communications.
- AESA — AES-128 Accelerator with DMA support
- TRNG — True Random Number Generator
- LPUART — Serial Communication Interface with DMA support and hardware flow control (RTS\CTS)..
- SPI — Two Serial Peripheral Interfaces with DMA support
- I2C — Two Inter-Integrated Circuit modules with SMBUS 2.0 and DMA support

- GPIO — Port interrupt capability on all the GPIO pins.
- Capacitive Touch Sensing Interface (TSI) with full low-power support and minimal current adder when enabled

Radio

- 2.4GHz ISM band (2400-2483.5 MHz) and MBAN 2360-2400 MHz operation
- Generic FSK and O-QPSK Modulation
- Supported Standards
 - Bluetooth Low Energy ver.4.2 supporting up to 2 simultaneous hardware connections
 - Generic(G) FSK modulation capability in Medical Body Area Network (MBAN) frequency bands spanning from 2360 MHz to 2400 MHz
 - Zigbee 3.0
 - IEEE Std. 802.15.4 compliant with dual-PAN support
- Bluetooth Low Energy Link Layer hardware
- Hardware acceleration for IEEE Std. 802.15.4 packet processing
- 26 MHz (BLE/Generic FSK only) or 32 MHz crystal reference oscillator
- Generic FSK Link Layer hardware
- Single RF port shared by both transmit and receive
- Supports diversity antenna options for 802.15.4
- Supports dual PAN for 802.15.4 with hardware-assisted address matching acceleration
- Low external component count
- Supports external PA and LNA

NOTE

Refer to the latest version of product datasheet for receiver and transmitter performance and other specifications.

1.3 Feature Summary

The following table lists the features integrated on device.

Table 1-2. Feature Summary

| Feature | Device |
|--------------------------|---|
| Hardware Characteristics | |
| Package | 48-pin Laminate QFN (7 x 7 mm, 0.5 mm pitch) 75-pin WLCSP (3.893 x 3.797 mm, 0.4 mm pitch) |
| Voltage range | DCDC in Buck/boost configurations supports 0.9 V to 4.2 V Bypass configuration: 1.71 V to 3.6 V (1.45-3.6 V for RF and OSC supplies) |

Table continues on the next page...

Table 1-2. Feature Summary (continued)

| Feature | Device |
|---|---|
| Temperature range (T _A) | WLCSP temperature rating: -40 °C to 85 °C QFN temperature rating: -40 °C to 105 °C |
| System | |
| Central processing unit (CPU) | ARM Cortex-M0+ core (32 bit) |
| Max. CPU frequency | 48 MHz (4 MHz in VLPR mode) |
| Max. Bus frequency | 24 MHz (1 MHz in VLPR mode) |
| Nested vectored Interrupt controller (NVIC) | 32 vectored interrupts 4 programmable interrupt priority levels |
| Low Power Modes | Run, Wait, Stop and Partial Stop Compute operation mode Very low power run (VLPR), wait (VLPW), and stop (VLPS) Low Leakage Stop (LLS3, LLS2) Very Low Leakage Stop (VLLS3, VLLS2, VLLS1, VLLS0) |
| Low-leakage Wakeup Unit (LLWU) | external wake-up pins with digital glitch filter as well as internal wake-up sources |
| Non-maskable interrupt (NMI) | Yes |
| Software COP (COP) | Yes |
| Debug and Trace | 2-pin serial wire debug (SWD) Micro trace buffer (MTB) + Data Watchpoint and Trace (DWT) |
| Unique Identification (ID) Numbers | 80-bit wide unique device ID Additional 40bit unique value for creating MAC address |
| Memory | |
| Flash memory | Up to 512 KB with 128 byte flash cache |
| Random-access memory (RAM) | Up to 128 KB |
| System Register File | 32 bytes |
| Clocks | |
| Reference crystal oscillator or resonator | Crystal reference oscillator, ability to bypass oscillator with external clock. Supports 26 MHz (BLE/Generic FSK only) or 32 MHz |
| 32 kHz External crystal oscillator | Supports 32 kHz or 32.768 kHz crystal/resonator, or external 32/32.768kHz clock |
| Internal clock references | 31.25 to 39.063 kHz oscillator with ±2% max. deviation across temperature 4MHz oscillator with ±5% max. deviation across temperature 1 kHz oscillator |
| Frequency-locked loop (FLL) | 20 - 48 MHz |
| Human-Machine Interface (HMI) | |
| General-purpose input/output (GPIO) | Default to disabled (no leakage) Hysteresis and configurable pull up/down device on all input pins Configurable drive strength and/or slew rate on some pins up to 10 pins (package dependent) with 20 mA high current drive ability Single cycle GPIO control via IOPORT |

Table continues on the next page...

Table 1-2. Feature Summary (continued)

| Feature | Device |
|---|--|
| Touch Sensor Input (TSI) | Up to 16-channels (package dependent) Selectable single channel wakeup source available in all low power modes DMA support |
| General Purpose Analog | |
| Power management controller (PMC) | Low voltage warning and detect with selectable trip points 1 kHz LPO |
| 16-bit analog-to-digital converter (ADC) | Up to 7 external channels Linear successive approximation algorithm Internal Temp Sensor and Battery Monitor DMA support |
| High speed comparator (HSCMP) with internal 6-bit digital-to-analog converter (DAC) | Up to 5 external channels |
| 12-bit DAC | 2x16bit data buffer DMA support VREFH from on-chip voltage reference |
| Voltage Reference(VREF1) | Supply an accurate 1.2 V voltage output |
| Timers | |
| 16-bit TPM timer (LPTPM x3) | one 4-channel without quadrature decode two 2-channel with quadrature decode basic TPM function PWM generation built in |
| 32-bit Programmable interrupt timer (PIT) | 2 channel |
| Real-time clock (RTC) | 32-bit seconds counter 16-bit prescaler with compensation |
| Low-power Timer (LPTMR) | 1-channel, 16-bit pulse counter or periodic interrupt functional in all power modes |
| Communication Interfaces | |
| Serial peripheral interface (2x SPI) | Two DSPI with 4-entry TX/CMD and RX FIFOs Master mode and slave mode functions Supports multiple chip selects in master mode Programmable transfer lengths DMA Support |
| Inter-Integrated Circuit (2x I2C) | Two I2C modules |
| Universal asynchronous receiver/transmitter (LPUART) | Standard features Tx pin pseudo open drain with enable/disable programmable configurable x4 to x32 oversampling Functional in STOP/VLPS modes |

Table continues on the next page...

Table 1-2. Feature Summary (continued)

| Feature | Device |
|---|--|
| | Hardware Flow Control (RTS/CTS) |
| | DMA Support |
| Carrier Modulation Timer (CMT) | Direct drive of IR LED. |
| Radio | |
| Operating Frequency range | ISM: 2400 - 2483.5 MHz MBAN: 2360 - 2400 MHz |
| Antenna and RF match support | Support for External, PCB and Ceramic chip antenna |
| Common Rx/Tx antenna terminals | Use 1 single end pin for Rx and Tx |
| Extended range options | Capable of supporting an external PA of +30 dB gain Supports +10 dB external LNA |
| Security Support | |
| Encryption | AES-128 Accelerator supporting ECB, CBC, CTR, CCM and CCM*, CMAC, and XCBC-MAC modes |
| TRNG | True Random Number Generator |
| ESD/EFT | |
| Human Body Model (HBM) JEDEC STD 2, method A114 | >+ / -2000 V All package pins, including RF pins. |
| Charge Device Model (CDM) JEDEC STD 2, method C101 | + / -500 V All package pins, including RF pins. |

1.4 Block Diagram

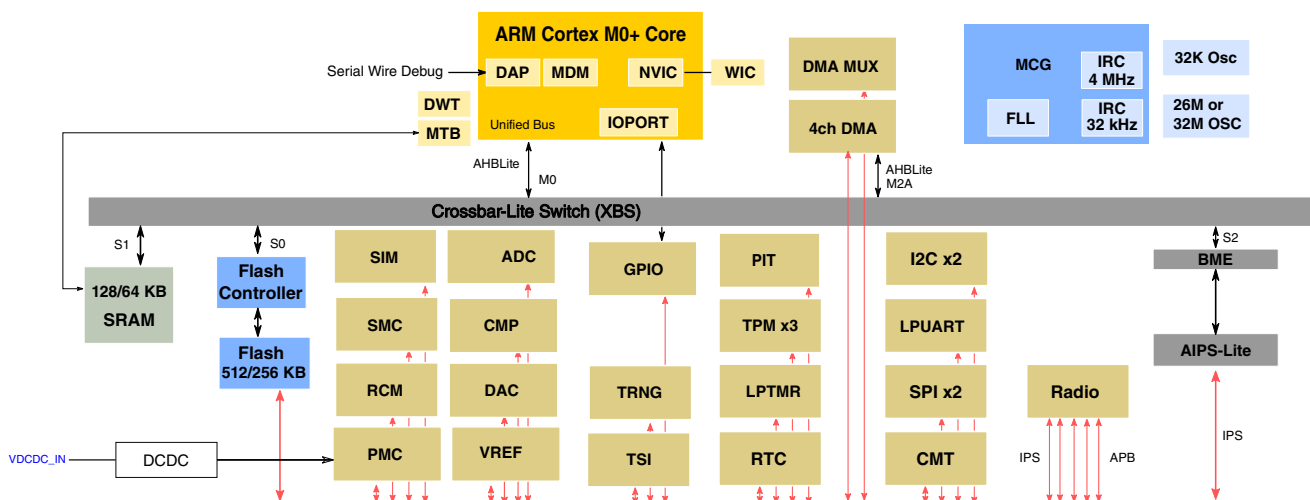

Figure 1-1. KW41Z Detailed Block Diagram

Chapter 2

Signal Multiplexing and Signal Descriptions

This section illustrates which of this device's signals are multiplexed on which external pin.

2.1 Pinouts

Device pinout are shown in figures below.

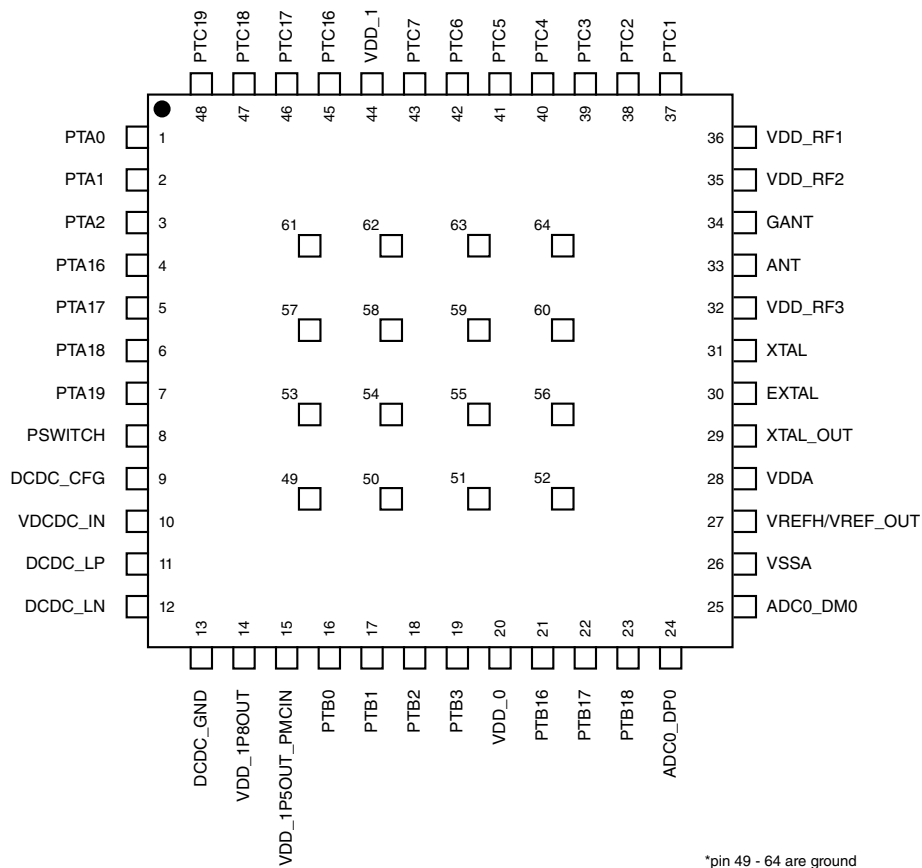

Figure 2-1. 48-pin Laminated QFN pinout diagram

Signal Multiplexing and Pin Assignments

| | 1 | 2 | 3 | 4 | 5 | 6 | 7 | 8 | 9 |
|---|----------|-------------------|---------|---------|-------|-------|-------------------|-----------------|----------|
| A | | | | VSS | PTC3 | PTC4 | PTC7 | PTC16 | PTC18 |
| B | GANT | ANT | VDD_RF2 | VDD_RF1 | VSS | PTC2 | PTC6 | PTC17 | PTA1 |
| C | XTAL | VDD_RF3 | VSS | VSS | PTC0 | PTC1 | PTC5 | PTC19 | PTA2 |
| D | EXTAL | VSS | VSS | VSS | VSS | VSS | VDD_1 | PTA0 | PTA17 |
| E | XTAL_OUT | VSS | VSS | VSS | VSS | VDD_1 | PTA16 | PTA18 | PTA19 |
| F | VDDA | VREFH_VREF OUT | PTB18 | VSS | VSS | VSS | VSS | DCDC_CFG | PSWITCH |
| G | VSSA | VSSA | VSS | VSS | PTB3 | PTB2 | VDD_1P8OUT | DCDC_GND | VDCDC_IN |
| H | ADC0_DM0 | VSS | PTB17 | PTB16 | VSS | PTB1 | VDD_1P5_P MCIN | DCDC_LN | DCDC_LP |
| J | ADC0_DP0 | VSS | | | VDD_0 | PTB0 | VSS | VDD_1P5_C AP | |

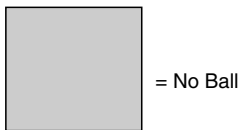

Figure 2-2. KW41 75-pin WLCSP Pinout Diagram

2.2 Signal Multiplexing and Pin Assignments

The following table shows the signals available on each pin and locations of these pins on the packages supported by this device. The Port Control Module is responsible for selecting which ALT functional is available on each PTxy pin.

NOTE

On the 75 WLCSP, VDD_1P5_CAP and VDD_1P5_PMCIN should be tied together external to the device.

Table 2-1. KW41Z Pin Assignments

| KW41 Z(48 LGA / Laminate QFN) | KW41 (WLCSP) | Pin Name | DEFAULT | ALT0 | ALT1 | ALT2 | ALT3 | ALT4 | ALT5 | ALT6 | ALT7 |
|-------------------------------|--------------|------------------|------------------|--------------------|------------------------|-----------|------|------|------------|------|---------|
| 1 | D8 | PTA0 | SWD_DIO | TSIO_CH8 | PTA0 | SPI0_PCS1 | | | TPM1_CH0 | | SWD_DIO |
| 2 | B9 | PTA1 | SWD_CLK | TSIO_CH9 | PTA1 | SPI1_PCS0 | | | TPM1_CH1 | | SWD_CLK |
| 3 | C9 | PTA2 | RESET_b | | PTA2 | | | | TPM0_CH3 | | RESET_b |
| 4 | E7 | PTA16 | DISABLED | TSIO_CH10 | PTA16/LLWU_P4 | SPI1_SOUT | | | TPM0_CH0 | | |
| 5 | D9 | PTA17 | DISABLED | TSIO_CH11 | PTA17/LLWU_P5/RF_RESET | SPI1_SIN | | | TPM_CLKIN1 | | |
| 6 | E8 | PTA18 | DISABLED | TSIO_CH12 | PTA18/LLWU_P6 | SPI1_SCK | | | TPM2_CH0 | | |
| 7 | E9 | PTA19 | DISABLED | TSIO_CH13/ADC0_SE5 | PTA19/LLWU_P7 | SPI1_PCS0 | | | TPM2_CH1 | | |
| 8 | F9 | PSWITCH | PSWITCH | PSWITCH | | | | | | | |
| 9 | F8 | DCDC_CFG | DCDC_CFG | DCDC_CFG | | | | | | | |
| 10 | G9 | VDCDC_IN | VDCDC_IN | VDCDC_IN | | | | | | | |
| 11 | H9 | DCDC_LP | DCDC_LP | DCDC_LP | | | | | | | |
| 12 | H8 | DCDC_LN | DCDC_LN | DCDC_LN | | | | | | | |
| 13 | G8 | DCDC_GND | DCDC_GND | DCDC_GND | | | | | | | |
| 14 | G7 | VDD_1P8OUT | VDD_1P8OUT | VDD_1P8OUT | | | | | | | |
| 15 | | VDD_1P5OUT_PMCIN | VDD_1P5OUT_PMCIN | VDD_1P5OUT_PMCIN | | | | | | | |
| | J8 | VDD_1P5_CAP | VDD_1P5_CAP | VDD_1P5_CAP | | | | | | | |
| | H7 | VDD_1P5_PMCIN | VDD_1P5_PMCIN | VDD_1P5_PMCIN | | | | | | | |

Table continues on the next page...

Table 2-1. KW41Z Pin Assignments (continued)

| KW41Z(48 LGA / Laminate QFN) | KW41 (WLCSP) | Pin Name | DEFAULT | ALT0 | ALT1 | ALT2 | ALT3 | ALT4 | ALT5 | ALT6 | ALT7 |
|------------------------------|--------------|----------------|-------------------|----------------------------|--------------------------|----------------|----------|-------------|----------|------|------------|
| 16 | J6 | PTB0 | DISABLED | | PTB0/LLWU_P8/XTAL_OUT_EN | | I2C0_SCL | CMP0_OUT | TPM0_CH1 | | CLKOUT |
| 17 | H6 | PTB1 | DISABLED | ADC0_SE1/CMP0_IN5 | PTB1 | DTM_RX | I2C0_SDA | LPTMR0_ALT1 | TPM0_CH2 | | CMT_IRO |
| 18 | G6 | PTB2 | DISABLED | ADC0_SE3/CMP0_IN3 | PTB2 | RF_NOT_ALLOWED | DTM_TX | | TPM1_CH0 | | |
| 19 | G5 | PTB3 | DISABLED | ADC0_SE2/CMP0_IN4 | PTB3 | | | CLKOUT | TPM1_CH1 | | RTC_CLKOUT |
| 20 | J5 | VDD_0 | VDD_0 | VDD_0 | | | | | | | |
| 21 | H4 | PTB16 | EXTAL32K | EXTAL32K | PTB16 | | I2C1_SCL | | TPM2_CH0 | | |
| 22 | H3 | PTB17 | XTAL32K | XTAL32K | PTB17 | | I2C1_SDA | | TPM2_CH1 | | BSM_CLK |
| 23 | F3 | PTB18 | NMI_b | DAC0_OUT/ADC0_SE4/CMP0_IN2 | PTB18 | | I2C1_SCL | TPM_CLKIN0 | TPM0_CH0 | | NMI_b |
| 24 | J1 | ADC0_DP0 | ADC0_DP0/CMP0_IN0 | ADC0_DP0/CMP0_IN0 | | | | | | | |
| 25 | H1 | ADC0_DM0 | ADC0_DM0/CMP0_IN1 | ADC0_DM0/CMP0_IN1 | | | | | | | |
| 26 | G1, G2 | VSSA | VSSA | VSSA | | | | | | | |
| 27 | F2 | VREFH/VREF_OUT | VREFH/VREF_OUT | VREFH/VREF_OUT | | | | | | | |
| 28 | F1 | VDDA | VDDA | VDDA | | | | | | | |
| 29 | E1 | XTAL_OUT | XTAL_OUT | XTAL_OUT | | | | | | | |
| 30 | D1 | EXTAL | EXTAL | EXTAL | | | | | | | |
| 31 | C1 | XTAL | XTAL | XTAL | | | | | | | |
| 32 | C2 | VDD_RF3 | VDD_RF3 | VDD_RF3 | | | | | | | |
| 33 | B2 | ANT | ANT | ANT | | | | | | | |
| 34 | B1 | GANT | GANT | GANT | | | | | | | |

Table continues on the next page...

Table 2-1. KW41Z Pin Assignments (continued)

| KW41Z(48 LGA / Laminate QFN) | KW41 (WLCSP) | Pin Name | DEFAULT | ALT0 | ALT1 | ALT2 | ALT3 | ALT4 | ALT5 | ALT6 | ALT7 |
|------------------------------|---|----------|-----------|-----------------|---------------------------|-----------------|--------------|----------------|-----------|------|---------------|
| 35 | B3 | VDD_RF2 | VDD_RF2 | VDD_RF2 | | | | | | | |
| 36 | B4 | VDD_RF1 | VDD_RF1 | VDD_RF1 | | | | | | | |
| | C5 | PTC0 | DISABLE D | | PTC0/LLWU_P9 | ANT_A | I2C0_SCL | LPUART0_CT S_b | TPM0_CH1 | | |
| 37 | C6 | PTC1 | DISABLE D | | PTC1 | ANT_B | I2C0_SDA | LPUART0_RT S_b | TPM0_CH2 | | BLE_RF_ACTIVE |
| 38 | B6 | PTC2 | DISABLE D | TSI0_CH14/DIAG1 | PTC2/LLWU_P10 | TX_SWITCH | I2C1_SCL | LPUART0_RX | CMT_IRO | | DTM_RX |
| 39 | A5 | PTC3 | DISABLE D | TSI0_CH15/DIAG2 | PTC3/LLWU_P11 | RX_SWITCH | I2C1_SDA | LPUART0_TX | TPM0_CH1 | | DTM_TX |
| 40 | A6 | PTC4 | DISABLE D | TSI0_CH0/DIAG3 | PTC4/LLWU_P12 | ANT_A | EXTRG_IN | LPUART0_CT S_b | TPM1_CH0 | | BSM_DATA |
| 41 | C7 | PTC5 | DISABLE D | TSI0_CH1/DIAG4 | PTC5/LLWU_P13 | RF_NOT_ALLO WED | LPTMR0_A LT2 | LPUART0_RT S_b | TPM1_CH1 | | BSM_CLK |
| 42 | B7 | PTC6 | DISABLE D | TSI0_CH2 | PTC6/LLWU_P14/XTAL_OUT_EN | | I2C1_SCL | LPUART0_RX | TPM2_CH0 | | BSM_FRAME |
| 43 | A7 | PTC7 | DISABLE D | TSI0_CH3 | PTC7/LLWU_P15 | SPI0_PCS2 | I2C1_SDA | LPUART0_TX | TPM2_CH1 | | BSM_DATA |
| 44 | E6, D7 | VDD_1 | VDD_1 | VDD_1 | | | | | | | |
| 45 | A8 | PTC16 | DISABLE D | TSI0_CH4 | PTC16/LLWU_P0 | SPI0_SCK | I2C0_SDA | LPUART0_RT S_b | TPM0_CH3 | | |
| 46 | B8 | PTC17 | DISABLE D | TSI0_CH5 | PTC17/LLWU_P1 | SPI0_SOUT | I2C1_SCL | LPUART0_RX | BSM_FRAME | | DTM_RX |
| 47 | A9 | PTC18 | DISABLE D | TSI0_CH6 | PTC18/LLWU_P2 | SPI0_SIN | I2C1_SDA | LPUART0_TX | BSM_DATA | | DTM_TX |
| 48 | C8 | PTC19 | DISABLE D | TSI0_CH7 | PTC19/LLWU_P3 | SPI0_PCS0 | I2C0_SCL | LPUART0_CT S_b | BSM_CLK | | BLE_RF_ACTIVE |
| 49-64 | A4, B5, C3, C4, D2, D3, D4, D5, D6, E2, | Ground | NA | | | | | | | | |

Table 2-1. KW41Z Pin Assignments

| KW41 Z(48 LGA / Laminate QFN) | KW41 (WLCSP) | Pin Name | DEFAULT | ALT0 | ALT1 | ALT2 | ALT3 | ALT4 | ALT5 | ALT6 | ALT7 |
|-------------------------------|--|----------|---------|------|------|------|------|------|------|------|------|
| | E3, E4, E5, F4, F5, F6, F7, G3, G4, H2, H5, J2, J7 | | | | | | | | | | |

2.3 KW41 Signal Descriptions

Table 2-2. KW41 Signal Descriptions

| Signal Name | Description | Type |
|---------------|--|------|
| ADC0_DM0 | ADC Channel 0 Differential Input Negative | A |
| ADC0_DP0 | ADC Channel 0 Differential Input Positive | A |
| ADC0_SE1 | ADC Channel 0 Single-ended Input 1 | A |
| ADC0_SE2 | ADC Channel 0 Single-ended Input 2 | A |
| ADC0_SE3 | ADC Channel 0 Single-ended Input 3 | A |
| ADC0_SE4 | ADC Channel 0 Single-ended Input 4 | A |
| ADC0_SE5 | ADC Channel 0 Single-ended Input 5 | A |
| ANT_A | Fast Antenna Diversity | D |
| ANT_B | Fast Antenna Diversity | D |
| BLE_RF_ACTIVE | Signal to indicate future BLE activity. Refer BLE Link Layer for more details. | D |
| CLKOUT | Internal Clocks Monitoring | D |
| CMP0_IN0 | Comparator0 Input 0 | D |
| CMP0_IN1 | Comparator0 Input 0 | D |
| CMP0_IN2 | Comparator0 Input 0 | D |
| CMP0_IN3 | Comparator0 Input 0 | D |
| CMP0_IN4 | Comparator0 Input 0 | D |
| CMP0_IN5 | Comparator0 Input 0 | D |
| CMP0_OUT | Comparator0 Output | D |
| CMT_IRO | Carrier Modulator Transmitter Infrared Output | D |
| DAC0_OUT | DAC0 Output | A |
| DCDC_CFG | DCDC Switch Mode Select | D |
| DCDC_GND | DCDC Switch Ground | G |
| DCDC_LN | DCDC Switch Inductor Input Negative | A |

Table continues on the next page...

Table 2-2. KW41 Signal Descriptions (continued)

| Signal Name | Description | Type |
|-------------|-------------------------------------|------|
| DCDC_LP | DCDC Switch Inductor Input Positive | A |
| DTM_RX | Direct Test Mode Receive | D |
| DTM_TX | Direct Test Mode Transmit | D |
| EXTAL | 26 MHz or 32 MHz Crystal Input | A |
| EXTAL32K | 32kHz Crystal Input | A |
| EXTRG_IN | TPM or ADC External Trigger Input | D |
| I2C0_SCL | I2C0 SCL | D |
| I2C0_SDA | I2C0 SDA | D |
| I2C1_SCL | I2C1 SCL | D |
| I2C1_SDA | I2C1 SDA | D |
| LPTMR0_ALT1 | Low Power Timer0 ALT1 | D |
| LPTMR0_ALT2 | Low Power Timer0 ALT2 | D |
| NMI_b | Non Maskable Interrupt Request | D |
| PSWITCH | DCDC Switch Enable | D |
| PTA0 | GPIO Port A0 | D |
| PTA1 | GPIO Port A1 | D |
| PTA16 | GPIO Port A16 | D |
| PTA17 | GPIO Port A17 | D |
| PTA18 | GPIO Port A18 | D |
| PTA19 | GPIO Port A19 | D |
| PTA2 | GPIO Port A2 | D |
| PTB0 | GPIO Port B0 | D |
| PTB1 | GPIO Port B1 | D |
| PTB16 | GPIO Port B16 | D |
| PTB17 | GPIO Port B17 | D |
| PTB18 | GPIO Port B18 | D |
| PTB2 | GPIO Port B2 | D |
| PTB3 | GPIO Port B3 | D |
| PTC0 | GPIO Port C0 | D |
| PTC1 | GPIO Port C1 | D |
| PTC16 | GPIO Port C16 | D |
| PTC17 | GPIO Port C17 | D |
| PTC18 | GPIO Port C18 | D |
| PTC19 | GPIO Port C19 | D |
| PTC2 | GPIO Port C2 | D |
| PTC3 | GPIO Port C3 | D |
| PTC4 | GPIO Port C4 | D |
| PTC5 | GPIO Port C5 | D |
| PTC6 | GPIO Port C6 | D |

Table continues on the next page...

Table 2-2. KW41 Signal Descriptions (continued)

| Signal Name | Description | Type |
|----------------|--|------|
| PTC7 | GPIO Port C7 | D |
| RESET_b | MCU Reset | D |
| RTC_CLKOUT | RTC Clock Out | D |
| RF_NOT_ALLOWED | Input signal that allows the external chip (eg. WiFi Chip) to signal the 2.4 GHz radio when BTLE radio operations are not allowed. | D |
| RX_SWITCH | Fast Antenna Diversity | D |
| SPI0_PCS0 | SPI0 PCS0 | D |
| SPI0_PCS1 | SPI0 PCS1 | D |
| SPI0_PCS2 | SPI0 PCS2 | D |
| SPI0_SCK | SPI0 Clock | D |
| SPI0_SIN | SPI0 Input | D |
| SPI0_SOUT | SPI0 Output | D |
| SPI1_PCS0 | SPI1 PCS0 | D |
| SPI1_SCK | SPI1 Clock | D |
| SPI1_SIN | SPI1 Input | D |
| SPI1_SOUT | SPI1 Output | D |
| SWD_CLK | Serial Wire Debug Clock | D |
| SWD_DIO | Serial Wire Debug Data Input and Output | D |
| TPM_CLKIN0 | TPM Clock Input 0 | D |
| TPM_CLKIN1 | TPM Clock Input 1 | D |
| TPM0_CH0 | TPM0 Channel 0 | D |
| TPM0_CH1 | TPM0 Channel 1 | D |
| TPM0_CH2 | TPM0 Channel 2 | D |
| TPM0_CH3 | TPM0 Channel 3 | D |
| TPM1_CH0 | TPM1 Channel 0 | D |
| TPM1_CH1 | TPM1 Channel 1 | D |
| TPM2_CH0 | TPM2 Channel 0 | D |
| TPM2_CH1 | TPM2 Channel 1 | D |
| TSI0_CH0 | TSI0 Channel 0 | A |
| TSI0_CH1 | TSI0 Channel 1 | A |
| TSI0_CH10 | TSI0 Channel 10 | A |
| TSI0_CH11 | TSI0 Channel 11 | A |
| TSI0_CH12 | TSI0 Channel 12 | A |
| TSI0_CH13 | TSI0 Channel 13 | A |
| TSI0_CH14 | TSI0 Channel 14 | A |
| TSI0_CH15 | TSI0 Channel 15 | A |
| TSI0_CH2 | TSI0 Channel 2 | A |
| TSI0_CH3 | TSI0 Channel 3 | A |
| TSI0_CH4 | TSI0 Channel 4 | A |
| TSI0_CH5 | TSI0 Channel 5 | A |

Table continues on the next page...

Table 2-2. KW41 Signal Descriptions (continued)

| Signal Name | Description | Type |
|------------------|---|------|
| TSI0_CH6 | TSI0 Channel 6 | A |
| TSI0_CH7 | TSI0 Channel 7 | A |
| TSI0_CH8 | TSI0 Channel 8 | A |
| TSI0_CH9 | TSI0 Channel 9 | A |
| TX_SWITCH | Fast Antenna DiversityTSM | D |
| LPUART0_CTS_b | LPUART0 Clear To Send | D |
| LPUART0_RTS_b | LPUART0 Request To Send | D |
| LPUART0_RX | LPUART0 Receive | D |
| LPUART0_TX | LPUART0 Transmit | D |
| VDCDC_IN | DCDC Switch Main Supply | P |
| VDD_0 | Power Supply 0 | P |
| VDD_1 | Power Supply 1 | P |
| VDD_1P5OUT_PMCIN | DCDC Pulsed Output 1.5 V Regulated Output or PMC Input when DCDC in bypass mode | P |
| VDD_1P8OUT | DCDC Pulsed 1.8 V Regulated Output | P |
| VDDA | Power Supply - Analog | P |
| VREFH | ADC reference voltage | P |
| VSSA | ADC ground | G |
| XTAL | 26 MHz or 32 MHz Crystal Input | A |
| XTAL32K | 32 kHz Crystal Input | A |

Legend

- A - Analog
- D - Digital
- P - Power Supply
- G - Ground

2.4 Module Signal Description Tables

The following sections correlate the chip-level signal name with the signal name used in the module's chapter. They also briefly describe the signal function and direction.

2.4.1 Core Modules

This section contains tables describing the core module signal descriptions.

Table 2-3. SWD Module Signal Descriptions

| SoC Signal Name | Module Signal Name | Description | I/O |
|-----------------|--------------------|--|-----|
| SWD_DIO | SWD_DIO | Serial Wire Debug Data Input/Output ¹ | I/O |
| SWD_CLK | SWD_CLK | Serial Wire Clock ² | I |

1. Pulled up internally by default
2. Pulled down internally by default

2.4.2 Radio Modules

This section contains tables describing the radio signals.

Table 2-4. Radio Module Signal Descriptions

| SoC Signal Name | Module Signal Name | Description | I/O |
|-----------------|--------------------|--|-----|
| ANT | ANT | Antenna | O |
| GANT | GANT | Antenna ground | I |
| BLE_RF_ACTIVE | BLE_RF_ACTIVE | Signal to indicate future BLE activity. Refer BLE Link Layer for more details. | O |
| RF_NOT_ALLOWED | RF_NOT_ALLOWED | Radio off signal, intended for WiFi coexistence control | I |
| RF_RESET | RF_RESET | Radio reset signal | I |
| DTM_RX | DTM_RX | Direct Test Mode Receive | I |
| DTM_TX | DTM_TX | Direct Test Mode Transmit | O |
| BSM_CLK | BSM_CLK | Bit Streaming Mode (BSM) Clock signal, 802.15.4 packet data stream clock line | O |
| BSM_FRAME | BSM_FRAME | Bit Streaming Mode Frame signal, 802.15.4 packet data stream frame line | O |
| BSM_DATA | BSM_DATA | Bit Streaming Mode Data signal, 802.15.4 packet data stream data line | I/O |
| ANT_A | ANT_A | Antenna selection A for Front End Module support | O |
| ANT_B | ANT_B | Antenna selection B for Front End Module support | O |
| TX_SWITCH | TX_SWITCH | Front End Module Transmit mode signal | O |
| RX_SWITCH | RX_SWITCH | Front End Module Receive mode signal | O |

2.4.3 System Modules

This section contains tables describing the system signals.

Table 2-5. System Module Signal Descriptions

| SoC Signal Name | Module Signal Name | Description | I/O |
|----------------------------|--------------------|---|-----|
| NMI_b | — | Non-maskable interrupt | I |
| RESET_b | — | Reset bidirectional signal | I/O |
| VDD_[1:0] | VDD | Power supply | I |
| Ground | VSS | Ground | I |
| VDD_RF[3:1] | VDD_RF | Radio power supply | I |
| VDCDC_IN | VDCDC_IN | VDCDC_IN | I |
| VDD_1P8OUT | VDD_1P8 | DCDC 1.8 V Regulated Output / Input in bypass | I/O |
| VDD_1P5OUT_PMCIN | VDD_1P5/VDD_PMC | DCDC 1.5 V Regulated Output / PMC Input in bypass (LQFN only) | I/O |
| VDD_1P5_CAP ¹ | VDD_1P5 | DCDC 1.5V Regulated output (WLCSP Only) | O |
| VDD_1P5_PMCIN ¹ | VDD_PMC | PMC Input (WLCSP Only) | I |
| PSWITCH | PSWITCH | DCDC enable switch | I |
| DCDC_CFG | DCDC_CFG | DCDC switch mode select | I |
| DCDC_LP | DCDC_LP | DCDC inductor input positive | I/O |
| DCDC_LN | DCDC_LN | DCDC inductor input negative | I/O |
| DCDC_GND | DCDC_GND | DCDC ground | I |

1. VDD_1P5_CAP and VDD_1P5_PMCIN should always be connected together via PCB trace. System designers should take care to ensure this connection is as short as possible.

Table 2-6. LLWU Module Signal Descriptions

| SoC Signal Name | Module Signal Name | Description | I/O |
|-----------------|--------------------|---------------|-----|
| LLWU_P[15:0] | LLWU_P[15:0] | Wakeup inputs | I |

2.4.4 Clock Modules

This section contains tables for Clock signal descriptions.

Table 2-7. Clock Module Signal Descriptions

| SoC Signal Name | Module Signal Name | Description | I/O |
|-----------------|--------------------|--|-----|
| EXTAL | EXTAL | 26 MHz/32 MHz External clock/Oscillator input | I |
| XTAL | XTAL | 26 MHz/32 MHz Oscillator input | I |
| XTAL_OUT | XTAL_OUT | 26 MHz/32 MHz Clock output | O |
| XTAL_OUT_EN | XTAL_OUT_ENABLE | 26 MHz/32 MHz Clock output enable for XTAL_OUT | I |
| EXTAL32K | EXTAL32K | 32 kHz External clock/Oscillator input | I |
| XTAL32K | XTAL32K | 32 kHz Oscillator input | I |
| CLKOUT | CLKOUT | Internal clocks monitor | O |

2.4.5 Analog Modules

This section contains tables for Analog signal descriptions.

Table 2-8. ADC0 Signal Descriptions

| SoC Signal Name | Module Signal Name | Description | I/O |
|-----------------|--------------------|---|-----|
| ADC0_DM0 | DADM0 | ADC Channel 0 Differential Input Negative | I |
| ADC0_DP0 | DADP0 | ADC Channel 0 Differential Input Positive | I |
| ADC0_SE[5:1] | AD[5:1] | ADC Channel 0 Single-ended Input n | I |
| VREFH | V _{REFSH} | Voltage Reference Select High | I |
| VDDA | V _{DDA} | Analog Power Supply | I |
| VSSA | V _{SSA} | Analog Ground | I |

Table 2-9. CMP0 Signal Descriptions

| SoC Signal Name | Module Signal Name | Description | I/O |
|-----------------|--------------------|-----------------------|-----|
| CMP0_IN[5:0] | IN[5:0] | Analog voltage inputs | I |
| CMP0_OUT | CMP0 | Comparator output | O |

Table 2-10. DAC0 Signal Descriptions

| SoC Signal Name | Module Signal Name | Description | I/O |
|-----------------|--------------------|-------------|-----|
| DAC0_OUT | V _{OUT} | DAC output | O |

Table 2-11. VREF Signal Descriptions

| SoC Signal Name | Module Signal Name | Description | I/O |
|-----------------|--------------------|---|-----|
| VREF_OUT | VREF_OUT | Internally generated voltage reference output | O |

2.4.6 Timer Modules

This section contains tables describing timer module signals.

Table 2-12. TPM0 Module Signal Descriptions

| SoC Signal Name | Module Signal Name | Description | I/O |
|-----------------|--------------------|----------------|-----|
| TPM_CLKIN[1:0] | TPM_EXTCLK | External clock | I |
| TPM0_CH[3:0] | TPM_CH[3:0] | TPM channel | I/O |

Table 2-13. TPM1 Module Signal Descriptions

| SoC Signal Name | Module Signal Name | Description | I/O |
|-----------------|--------------------|----------------|-----|
| TPM_CLKIN[1:0] | TPM_EXTCLK | External clock | I |
| TPM1_CH[1:0] | TPM_CH[1:0] | TPM channel | I/O |

Table 2-14. TPM2 Module Signal Descriptions

| SoC Signal Name | Module Signal Name | Description | I/O |
|-----------------|--------------------|----------------|-----|
| TPM_CLKIN[1:0] | TPM_EXTCLK | External clock | I |
| TPM2_CH[1:0] | TPM_CH[1:0] | TPM channel | I/O |

Table 2-15. LPTMR0 Module Signal Descriptions

| SoC Signal Name | Module Signal Name | Description | I/O |
|-----------------|--------------------|-------------------------|-----|
| LPTMR0_ALT[2:1] | LPTMR0_ALT[2:1] | Pulse counter input pin | I |

Table 2-16. RTC Module Signal Descriptions

| SoC Signal Name | Module Signal Name | Description | I/O |
|-----------------|--------------------|-------------------------|-----|
| RTC_CLKOUT | RTC_CLKOUT | 1 Hz square-wave output | O |

2.4.7 Communication Interfaces

This section contains tables for the signal descriptions for the communication modules.

Table 2-17. SPI0 Module Signal Descriptions

| SoC Signal Name | Module Signal Name | Description | I/O |
|-----------------|--------------------|--------------------------|-----|
| SPI0_PCS0 | PCS0/SS | Chip Select/Slave Select | I/O |
| SPI0_PCS[2:1] | PCS[2:1] | Chip Select | O |
| SPI0_SCK | SCK | Serial Clock | I/O |
| SPI0_SIN | SIN | Data In | I |
| SPI0_SOUT | SOUT | Data Out | O |

Table 2-18. SPI1 Module Signal Descriptions

| SoC Signal Name | Module Signal Name | Description | I/O |
|-----------------|--------------------|--------------------------|-----|
| SPI1_PCS0 | SPI1_PCS0 | Chip Select/Slave Select | I/O |
| SPI1_SCK | SCK | Serial Clock | I/O |
| SPI1_SIN | SIN | Data In | I |
| SPI1_SOUT | SOUT | Data Out | O |

Table 2-19. I2C0 Module Signal Descriptions

| SoC Signal Name | Module Signal Name | Description | I/O |
|-----------------|--------------------|-----------------------|-----|
| I2C0_SCL | SCL | I2C serial clock line | I/O |
| I2C0_SDA | SDA | I2C serial data line | I/O |

Table 2-20. I2C1 Module Signal Descriptions

| SoC Signal Name | Module Signal Name | Description | I/O |
|-----------------|--------------------|-----------------------|-----|
| I2C1_SCL | SCL | I2C serial clock line | I/O |
| I2C1_SDA | SDA | I2C serial data line | I/O |

Table 2-21. LPUART0 Module Signal Descriptions

| SoC Signal Name | Module Signal Name | Description | I/O |
|-----------------|--------------------|----------------------------|-----|
| LPUART0_CTS_b | LPUART CTS | Clear To Send | I |
| LPUART0_RTS_b | LPUART RTS | Request To Send | O |
| LPUART0_RX | LPUART RxD | Receive Data | I |
| LPUART0_TX | LPUART TxD | Transmit Data ¹ | I/O |

1. This pin is normally an output, but is an input (tristated) in single wire mode whenever the transmitter is disabled or transmit direction is configured for receive data

2.4.8 Human-Machine Interfaces(HMI)

This section contains tables describing the HMI signals.

Table 2-22. GPIO Module Signal Descriptions

| SoC Signal Name | Module Signal Name | Description | I/O |
|-----------------|--------------------|------------------------------|-----|
| PTA[19:16][2:0] | PORTA19-16, 2-0 | General Purpose Input/Output | I/O |
| PTB[18:16][3:0] | PORTB18-16, 3-0 | General Purpose Input/Output | I/O |
| PTC[19:16][7:1] | PORTC19-16, 7-1 | General Purpose Input/Output | I/O |

Table 2-23. TSI0 Module Signal Descriptions

| SoC Signal Name | Module Signal Name | Description | I/O |
|-----------------|--------------------|--|-----|
| TSI0_CH[15:0] | TSI[15:0] | Touch Sensing Input capacitive pins | I/O |

Chapter 3

Chip Configuration

This section provides details on the individual modules of the microcontroller.

3.1 Introduction

This chapter provides details on the individual modules of the microcontroller. It includes:

- Module block diagrams showing immediate connections within the device
- Specific module-to-module interactions not necessarily discussed in the individual module chapters
- Links for more information

3.2 Module to module interconnects

3.2.1 Module to Module Interconnects

The below table captures the Module to module interconnections for this device.

Table 3-1. Module to Module Interconnects

| Peripheral | Signal | to Peripheral | Use Case | Control | Comment |
|------------|------------|---------------|--------------------------|--------------------------|---|
| TPM1 | CH0F, CH1F | ADC (Trigger) | ADC Triggering (A AND B) | SOPT7[ADC0ALTT RGEN] = 0 | Ch0 is A, and Ch1 is B, selecting this ADC trigger is for supporting A and B triggering. In Stop and VLPS modes, the second trigger must be set to >10µs after the first trigger. |

Table continues on the next page...

Table 3-1. Module to Module Interconnects (continued)

| Peripheral | Signal | to Peripheral | Use Case | Control | Comment |
|------------|------------------|---------------|--|---|---|
| TPMx | TOF | ADC (Trigger) | ADC Triggering (A OR B) | SOPT7[ADC0TRGSEL], SOPT7[ADC0PRETRGSEL] to select A or B | — |
| LPTMR | Hardware trigger | ADC (Trigger) | ADC Triggering (A OR B) | SOPT7[ADC0TRGSEL], SOPT7[ADC0PRETRGSEL] to select A or B | — |
| PIT CHx | TIF0, TIF1 | ADC (Trigger) | ADC Triggering (A OR B) | SOPT7[ADC0TRGSEL], SOPT7[ADC0PRETRGSEL] to select A or B | — |
| RTC | ALARM or SECONDS | ADC (Trigger) | ADC Triggering (A OR B) | SOPT7[ADC0TRGSEL], SOPT7[ADC0PRETRGSEL] to select A or B | — |
| EXTRG_IN | EXTRG_IN | ADC (Trigger) | ADC Triggering (A OR B) | SOPT7[ADC0TRGSEL], SOPT7[ADC0PRETRGSEL] to select A or B | — |
| CMP0 | CMP0_OUT | ADC (Trigger) | ADC Triggering (A OR B) | SOPT7[ADC0TRGSEL], SOPT7[ADC0PRETRGSEL] to select A or B | — |
| Radio TSM | sar_adc_trig | ADC (Trigger) | ADC Triggering (A OR B). | SOPT7[ADC0TRGSEL], SOPT7[ADC0PRETRGSEL] to select A or B | This could provide a battery voltage or other ADC channel measurement reading at end of warmup or start of warmdown |
| CMP0 | CMP0_OUT | LPTMR_ALT0 | Count CMP events | LPTMR_CSR[TPS] | |
| CMP0 | CMP0_OUT | TPM1 CH0 | Input capture | SOPT4[TPM1CH0SRC] | |
| CMP0 | CMP0_OUT | TPM2 CH0 | Input capture | SOPT4[TPM2CH0SRC] | |
| CMP0 | CMP0_OUT | LPUART0_RX | IR interface | SOPT5[LPUART0RXSRC] | |
| LPTMR | Hardware trigger | CMP0 | Low power triggering of the comparator | CMP_CR1[TRIGM] | |
| LPTMR | Hardware trigger | TPMx | TPM Trigger input | TPMx_CONF[TRGSEL] | — |

Table continues on the next page...

Table 3-1. Module to Module Interconnects (continued)

| Peripheral | Signal | to Peripheral | Use Case | Control | Comment |
|------------|---------------------------|-----------------------|---------------------------|-------------------------|--|
| TPMx | TOF | TPMx | TPM Trigger input | TPMx_CONF[TRG SEL] | — |
| PIT CHx | TIF0, TIF1 | TPMx | TPM Trigger input | TPMx_CONF[TRG SEL] | If PIT is triggering the TPM, the TPM clock must be faster than Bus clock. |
| RTC | ALARM or SECONDS | TPMx | TPM Trigger input | TPMx_CONF[TRG SEL] | — |
| EXTRG_IN | EXTRG_IN | TPMx | TPM Trigger input | TPMx_CONF[TRG SEL] | — |
| CMP0 | CMP0_OUT | TPMx | TPM Trigger input | TPMx_CONF[TRG SEL] | — |
| Radio TSM | sar_adc_trig ¹ | TPMx | TPM Trigger input | TPMx_CONF[TRG SEL] | — |
| TPM1 | Timebase | TPMx | TPM Global timebase input | TPMx_CONF[GTB EEN] | — |
| LPTMR | Hardware trigger | TSI | TSI triggering | TSI selects HW trigger | — |
| LPUART0 | LPUART0_TX | Modulated by TPM1 CH0 | LPUART modulation | SOPT5[LPUART0T XSRC] | — |
| LPUART0 | LPUART0_TX | Modulated by TPM2 CH0 | LPUART modulation | SOPT5[LPUART0T XSRC] | — |
| PIT | TIF0 | DAC | Advance DAC FIFO | DAC HWTRG Select | — |
| PIT | TIF0 | DMA CH0 | DMA HW Trigger | DMA MUX register option | — |
| PIT | TIF1 | DMA CH1 | DMA HW Trigger | DMA MUX register option | — |

1. This is the same TSM signal as shown above providing a trigger to the ADC. Triggering a TPM could provide a time-delayed offset for the TPM to trigger the ADC, or could be used for other purposes.

3.3 Core modules

3.3.1 ARM Cortex-M0+ core configuration

This section summarizes how the module has been configured in the chip. Full documentation for this module is provided by Arm and can be found at arm.com.

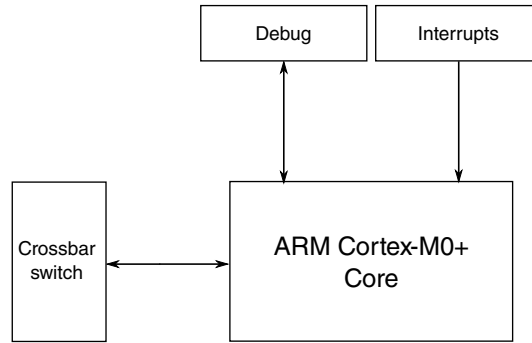

Figure 3-1. Core configuration

Table 3-2. Reference links to related information

| Topic | Related module | Reference |
|------------------------------------|---|---|
| Full description | ARM Cortex-M0+ core, r0p1 | ARM Cortex-M0+ Technical Reference Manual |
| System memory map | | System memory map |
| Clocking | | Clock distribution |
| Power management | | Power management |
| System/instruction/data bus module | Crossbar switch | Crossbar switch |
| Debug | Serial wire debug (SWD) | Debug |
| Interrupts | Nested vectored interrupt controller (NVIC) | NVIC |
| Private Peripheral Bus | Miscellaneous control module (MCM) | MCM |

3.3.1.1 ARM Cortex M0+ core

The ARM Cortex M0+ parameter settings are as follows:

Table 3-3. ARM Cortex-M0+ parameter settings

| Parameter | Value | Description |
|------------------------|-------------|---|
| Arch Clock Gating | 1 = Present | Implements architectural clock gating |
| DAP Slave Port Support | 1 | Supports any AHB debug access port (like the CM4 DAP) |
| DAP ROM Table Base | 0xF000_2003 | Base address for DAP ROM table |
| Endianness | 0 | Little endian control for data transfers |
| Breakpoints | 2 | Implements 2 breakpoints |
| Debug Support | 1 = Present | — |

Table continues on the next page...

Table 3-3. ARM Cortex-M0+ parameter settings (continued)

| Parameter | Value | Description |
|------------------------------|--------------|---|
| Halt Event Support | 1 = Present | — |
| I/O Port | 1 = Present | Implements single-cycle ld/st accesses to special address space |
| IRQ Mask Enable | 0x00000000 | Assume all 32 IRQs are used (set if IRQ is disabled) |
| Debug Port Protocol | 0 = SWD | SWD protocol, not JTAG |
| Core Memory Protection | 0 = Absent | No MPU |
| Number of IRQs | 32 | Assume full NVIC request vector |
| Reset all registers | 0 = Standard | Do not force all registers to be async reset |
| Multiplier | 0 = Fast Mul | Implements single-cycle multiplier |
| Multi-drop Support | 0 = Absent | Do not include serial wire support for multi-drop |
| System Tick Timer | 1 = Present | Implements system tick timer (for CM4 compatibility) |
| DAP Target ID | 0 | — |
| User/Privileged | 1 = Present | Implements processor operating modes |
| Vector Table Offset Register | 1 = Present | Implements relocation of exception vector table |
| WIC Support | 1 = Present | Implements WIC interface |
| WIC Requests | 34 | Exact number of wake-up IRQs is 34 |
| Watchpoints | 2 | Implements two watchpoints |

For details on the ARM Cortex-M0+ processor core, see the ARM website: arm.com.

3.3.1.2 Buses, Interconnects, and Interfaces

The ARM Cortex-M0+ core has two bus interfaces:

- single 32-bit AMBA-3 AHB-Lite system interface that provides connections to peripherals and all system memory, which includes flash and RAM.
- single 32-bit I/O port bus interfacing to the GPIO with 1-cycle loads and stores.

3.3.1.3 System Tick Timer

The CLKSOURCE bit in SysTick Control and Status register selects either the core clock (when CLKSOURCE = 1) or a divide-by-16 of the core clock (when CLKSOURCE = 0). Because the timing reference is a variable frequency, the TENMS bit in the SysTick Calibration Value Register is always zero.

3.3.1.4 Debug Facilities

This device supports standard ARM 2-pin SWD debug port.

3.3.1.5 Core Privilege Levels

The ARM documentation uses different terms than this document to distinguish between privilege levels.

| If you see this term... | it also means this term... |
|-------------------------|----------------------------|
| Privileged | Supervisor |
| Unprivileged or user | User |

3.3.2 Nested Vectored Interrupt Controller (NVIC) Configuration

This section summarizes how the module has been configured in the chip. Full documentation for this module is provided by Arm and can be found at arm.com.

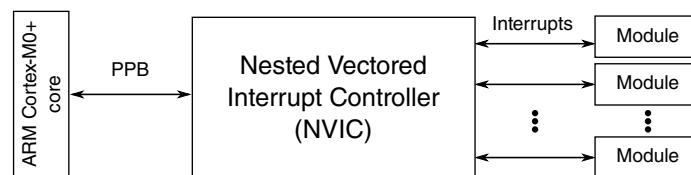

Figure 3-2. NVIC configuration

Table 3-4. Reference links to related information

| Topic | Related module | Reference |
|------------------------------|---|---|
| Full description | Nested Vectored Interrupt Controller (NVIC) | ARM Cortex-M0+ Technical Reference Manual |
| System memory map | | System memory map |
| Clocking | | Clock distribution |
| Power management | | Power management |
| Private Peripheral Bus (PPB) | ARM Cortex-M0+ core | ARM Cortex-M0+ core |

3.3.2.1 Interrupt priority levels

This device supports 4 priority levels for interrupts. Therefore, in the NVIC each source in the IPR registers contains 2 bits. For example, IPR0 is shown below:

| | | | | | | | | | | | | | | | | | | | | | | | | | | | | | | | | |
|---|------|----|----|----|----|----|----|----|------|----|----|----|----|----|----|----|------|----|----|----|----|----|---|---|------|---|---|---|---|---|---|---|
| | 31 | 30 | 29 | 28 | 27 | 26 | 25 | 24 | 23 | 22 | 21 | 20 | 19 | 18 | 17 | 16 | 15 | 14 | 13 | 12 | 11 | 10 | 9 | 8 | 7 | 6 | 5 | 4 | 3 | 2 | 1 | 0 |
| R | IRQ3 | | 0 | 0 | 0 | 0 | 0 | 0 | IRQ2 | | 0 | 0 | 0 | 0 | 0 | 0 | IRQ1 | | 0 | 0 | 0 | 0 | 0 | 0 | IRQ0 | | 0 | 0 | 0 | 0 | 0 | 0 |
| W | | | | | | | | | | | | | | | | | | | | | | | | | | | | | | | | |

3.3.2.2 Non-maskable interrupt

The non-maskable interrupt request to the NVIC is controlled by the external $\overline{\text{NMI}}$ signal. The pin the $\overline{\text{NMI}}$ signal is multiplexed on must be configured in order for the $\overline{\text{NMI}}$ function to generate the non-maskable interrupt request. $\overline{\text{NMI}}$ and DAC output share the same physical signal pin (PTB18). The $\overline{\text{NMI}}$ signal have a pull-up enabled and any external device connected to PTB18 will see a VDD voltage. Even if the FOPT is selected to disable the $\overline{\text{NMI}}$ signal, the pull-up will be enabled during Reset.

3.3.2.3 Interrupt channel assignments

The interrupt vector assignments are defined in the following table.

- Vector number — the value stored on the stack when an interrupt is serviced.
- IRQ number — non-core interrupt source count, which is the vector number minus 16.

The IRQ number is used within ARM's NVIC documentation.

Table 3-6. Interrupt vector assignments

| Address | Vector | IRQ ¹ | Source module | Source description |
|----------------------------|--------|------------------|---------------|---|
| Non-core Vectors | | | | |
| On-platform Vectors | | | | |
| 0x0000_0040 | 16 | 0 | DMA | DMA channel 0 transfer complete and error |
| 0x0000_0044 | 17 | 1 | DMA | DMA channel 1 transfer complete and error |
| 0x0000_0048 | 18 | 2 | DMA | DMA channel 2 transfer complete and error |

Table continues on the next page...

Table 3-6. Interrupt vector assignments (continued)

| Address | Vector | IRQ ¹ | Source module | Source description |
|----------------------|--------|------------------|-----------------|--|
| 0x0000_004C | 19 | 3 | DMA | DMA channel 3 transfer complete and error |
| 0x0000_0050 | 20 | 4 | — | Reserved for future MCM |
| Off-platform Vectors | | | | |
| 0x0000_0054 | 21 | 5 | FTFA | Command complete and read collision |
| 0x0000_0058 | 22 | 6 | PMC and DCDC | PMC: Low-voltage detect, low-voltage warning DCDC: PSWITCH interrupt |
| 0x0000_005C | 23 | 7 | LLWU | Low Leakage Wakeup |
| 0x0000_0060 | 24 | 8 | I2C0 | |
| 0x0000_0064 | 25 | 9 | I2C1 | |
| 0x0000_0068 | 26 | 10 | SPI0 | Single interrupt vector for all sources |
| 0x0000_006C | 27 | 11 | TSI0 | |
| 0x0000_0070 | 28 | 12 | LPUART | |
| 0x0000_0074 | 29 | 13 | TRNG0AN | |
| 0x0000_0078 | 30 | 14 | CMT | Status and error |
| 0x0000_007C | 31 | 15 | ADC0 | |
| 0x0000_0080 | 32 | 16 | CMP0 | |
| 0x0000_0084 | 33 | 17 | TPM0 | |
| 0x0000_0088 | 34 | 18 | TPM1 | |
| 0x0000_008C | 35 | 19 | TPM2 | |
| 0x0000_0090 | 36 | 20 | RTC | Alarm interrupt |
| 0x0000_0094 | 37 | 21 | RTC | Seconds interrupt |
| 0x0000_0098 | 38 | 22 | PIT | Single interrupt vector for all channels |
| 0x0000_009C | 39 | 23 | LTC(AESA) | |
| 0x0000_00A0 | 40 | 24 | 2.4G Radio INT0 | Selectable interrupt request from BLE, 802.15.4, or Generic FSK |
| 0x0000_00A4 | 41 | 25 | DAC0 | |
| 0x0000_00A8 | 42 | 26 | 2.4G Radio INT1 | Selectable interrupt request from BLE, 802.15.4, or Generic FSK |

Table continues on the next page...

Table 3-6. Interrupt vector assignments (continued)

| Address | Vector | IRQ ¹ | Source module | Source description |
|-------------|--------|------------------|---------------------|---|
| 0x0000_00AC | 43 | 27 | MCG | |
| 0x0000_00B0 | 44 | 28 | LPTMR0 | |
| 0x0000_00B4 | 45 | 29 | SPI1 | Single interrupt vector for all sources |
| 0x0000_00B8 | 46 | 30 | Port Control Module | Pin detect(Port A) |
| 0x0000_00BC | 47 | 31 | Port Control Module | Pin detect(Single interrupt vector for Port B and Port C) |

1. Indicates the NVIC's interrupt source number.

3.3.2.3.1 Determining the bitfield and register location for configuring a particular interrupt

Suppose you need to configure the SPI0 interrupt. The following table is an excerpt of the SPI0 row from [Interrupt channel assignments](#).

Table 3-7. Interrupt vector assignments

| Address | Vector | IRQ ¹ | NVIC IPR register number ² | Source module | Source description |
|-------------|--------|------------------|---------------------------------------|---------------|---|
| 0x0000_0068 | 26 | 10 | 2 | SPI0 | Single interrupt vector for all sources |

1. Indicates the NVIC's interrupt source number.

2. Indicates the NVIC's IPR register number used for this IRQ. The equation to calculate this value is: $IRQ \div 4$.

- The NVIC registers you would use to configure the interrupt are:
 - NVICIPR2
- To determine the particular IRQ's bitfield location within these particular registers:
 - NVICIPR2 bitfield starting location = $8 * (IRQ \bmod 4) + 6 = 22$

Since the NVICIPR bitfields are 2-bit wide (4 priority levels), the NVICIPR2 bitfield range is 22-23

Therefore, the following bitfield locations are used to configure the SPI0 interrupts:

- NVICIPR2[23:22]

3.3.2.4 Serialization of memory operations when clearing interrupt flags

When clearing flags associated with an interrupt source in the interrupt service routine (ISR), the flag must be read back before exiting the ISR to ensure the flag is cleared. Otherwise, the interrupt could still be pending, causing the ISR to be entered again inadvertently.

3.3.3 Asynchronous wake-up interrupt controller (AWIC) configuration

This section summarizes how the module has been configured in the chip. Full documentation for this module is provided by ARM and can be found at arm.com.

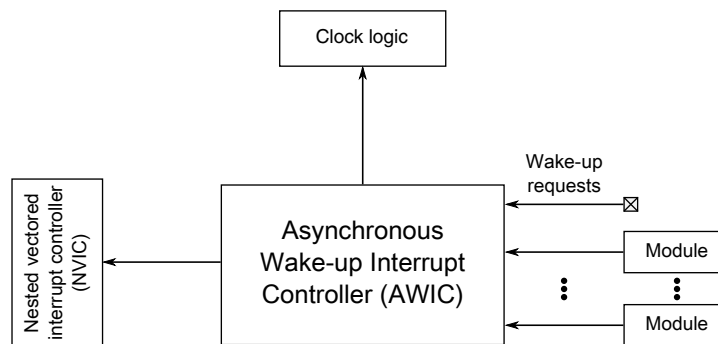

Figure 3-3. Asynchronous wake-up interrupt controller configuration

Table 3-8. Reference links to related information

| Topic | Related module | Reference |
|-------------------|---|--------------------------------------|
| System memory map | | System memory map |
| Clocking | | Clock distribution |
| Power management | | Power management |
| | Nested vectored interrupt controller (NVIC) | NVIC |
| Wake-up requests | | AWIC wake-up sources |

3.3.3.1 Wake-up sources

The device uses the following internal and external inputs to the AWIC module.

Table 3-9. AWIC stop wake-up sources

| Wake-up source | Description |
|-------------------------|---|
| Available system resets | $\overline{\text{RESET}}$ pin when LPO is its clock source |
| Low-voltage detect | Mode Controller |
| Low-voltage warning | Mode Controller |
| DCDC | PSWITCH pin edge detect |
| Pin interrupts | Port control module - Any enabled pin interrupt is capable of waking the system |
| ADC | The ADC is functional when using internal clock source |
| CMP0 | Interrupt in normal or trigger mode |
| Radio | BLE, 802.15.4, G-FSK interrupts |
| I ² Cx | Address match wakeup |
| LPUART | Any interrupt provided clock remains enabled |
| RTC | Alarm or seconds interrupt |
| TSI | Any interrupt |
| NMI | NMI pin |
| TPMx | Any interrupt provided clock remains enabled |
| LPTMR | Any interrupt provided clock remains enabled |

3.4 System modules

3.4.1 SIM configuration

This section summarizes how the module has been configured in the chip.

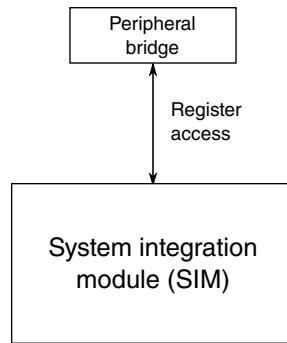

Figure 3-4. SIM configuration

Table 3-10. Reference links to related information

| Topic | Related module | Reference |
|-------------------|----------------|------------------------------------|
| Full description | SIM | SIM |
| System memory map | — | System memory map |
| Clocking | — | Clock distribution |
| Power management | — | Power management |

3.4.2 System mode controller (SMC) configuration

This section summarizes how the module has been configured in the chip.

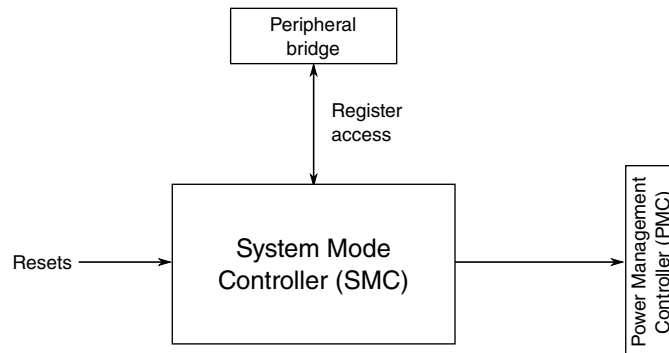

Figure 3-5. System mode controller configuration

Table 3-11. Reference links to related information

| Topic | Related module | Reference |
|-------------------|------------------------------|-----------------------------------|
| Full description | System mode controller (SMC) | SMC |
| System memory map | — | System memory map |
| Power management | — | Power management |

Table continues on the next page...

Table 3-11. Reference links to related information (continued)

| Topic | Related module | Reference |
|-------|-----------------------------------|-----------------------|
| — | Power management controller (PMC) | PMC |
| — | Low-leakage wakeup unit (LLWU) | LLWU |
| — | Reset control module (RCM) | Reset |

3.4.3 PMC configuration

This section summarizes how the module has been configured in the chip.

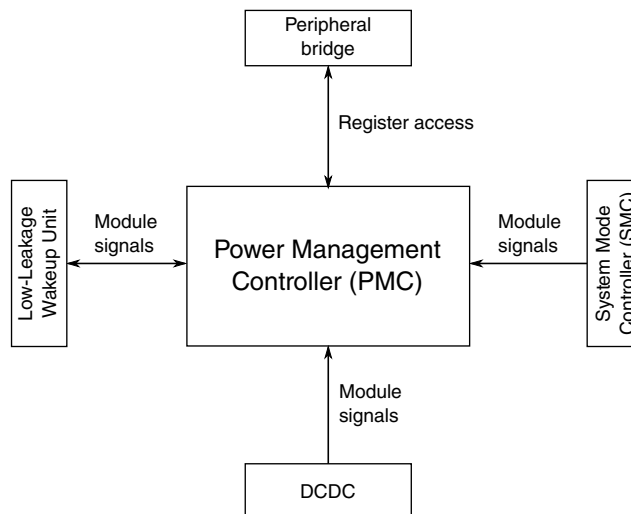
**Figure 3-6. PMC configuration****Table 3-12. Reference links to related information**

| Topic | Related module | Reference |
|-------------------|--------------------------------|--|
| Full description | PMC | PMC |
| System memory map | — | System memory map |
| Power management | — | Power management |
| Full description | System mode controller (SMC) | System Mode Controller |
| — | Low-leakage wakeup unit (LLWU) | LLWU |
| — | Reset control module (RCM) | Reset |

3.4.4 DCDC configuration

This section summarizes how the module has been configured in the chip.

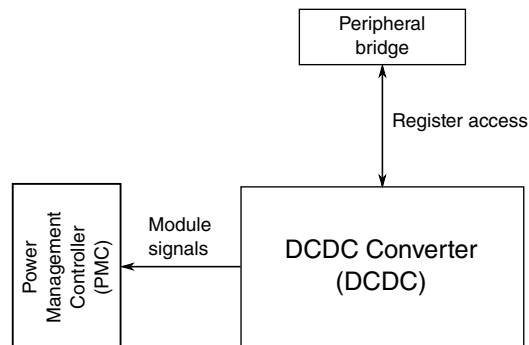

Figure 3-7. DCDC configuration

Table 3-13. Reference links to related information

| Topic | Related module | Reference |
|-------------------|----------------|-----------------------------------|
| Full description | DCDC | DCDC |
| System memory map | — | System memory map |
| Power management | — | Power management |

The power architecture for this device is based on the PMC and a DCDC converter which can operate in Buck, Boost or Bypass mode.

3.4.4.1 Buck Mode

Buck mode supports operation over a wide range of battery voltages. See the $V_{DD_DCDC_IN}$ specification in the data sheet. After DCDC startup, the DCDC can continue to operate if the battery voltage drops as low as 1.8V

The figure below illustrates the power tree when the DCDC is configured in Buck mode. The power pins shown in the figure are used as follows:

- The DCDC_CFG pin is connected to V_{DCDC_IN} to select Buck configuration.
- The PSWITCH pin is used to power-on the DCDC. A push-button switch can be used with PSWITCH to momentarily ($T_{DCDC_ON_BUCK}$) connect PSWITCH to V_{DCDC_IN} to power-on the device, though in some use cases PSWITCH could be shorted to V_{DCDC_IN} or used with a different type of switch. If PSWITCH is used with a switch as shown in the figure below, an external pull-down resistor is needed on PSWITCH to ensure that it is 0 when the switch is off.

- $V_{\text{DCDC_IN}}$ powers the DCDC regulator. It is expected that a capacitor is connected to $V_{\text{DCDC_IN}}$ to help support large transient or short duration loads, including Rx and Tx bursts.
- $V_{\text{DD_1P5}}$ is the 1.5V output of the DCDC. It needs to be filtered off-chip.
- $V_{\text{DD_PMC}}$ is a pad which is connected to $V_{\text{DD_1p5}}$ in the package substrate (does not apply to the WLCSP; system designers should take care to connected these signals via short PCB trace). This pad supplies power to the PMC's LDO regulator which generates 1.2V to the internal logic.
- $V_{\text{DD_RF1/VDD_RF2/VDD_RF3}}$ supplies power to the RF-analog domain regulators. It is powered from a filtered version of the 1.5V DCDC output
- $V_{\text{DD_1P8}}$ is the second output of the DCDC. At DCDC power-up, this defaults to 1.8V. However, it can be programmed after power-up to provide a higher voltage, up to $V_{\text{DCDC_IN}}$. $V_{\text{DD_1P8}}$ is expected to be filtered off-chip with a capacitor.
- V_{DD} (I/O and DGO) supplies power to the digital I/O pins and the DGO logic that is always powered whenever the DCDC is enabled.
- V_{DDA} powers the SAR ADC. This can be connected to $V_{\text{DD_1P8}}$.
- V_{REFH} is a reference option for the SAR ADC. This can be connected to $V_{\text{DD_1P8}}$ or an external reference can be used.

NOTE

$V_{\text{DD_1P5}}$ and $V_{\text{DD_PMC}}$ are not connected in the substrate of the WLCSP package. System designers should take care to connect these pins ($V_{\text{DD_1P5_CAP}}$ and $V_{\text{DD_1P5_PMCIN}}$ as pin name) correctly when designing hardware.

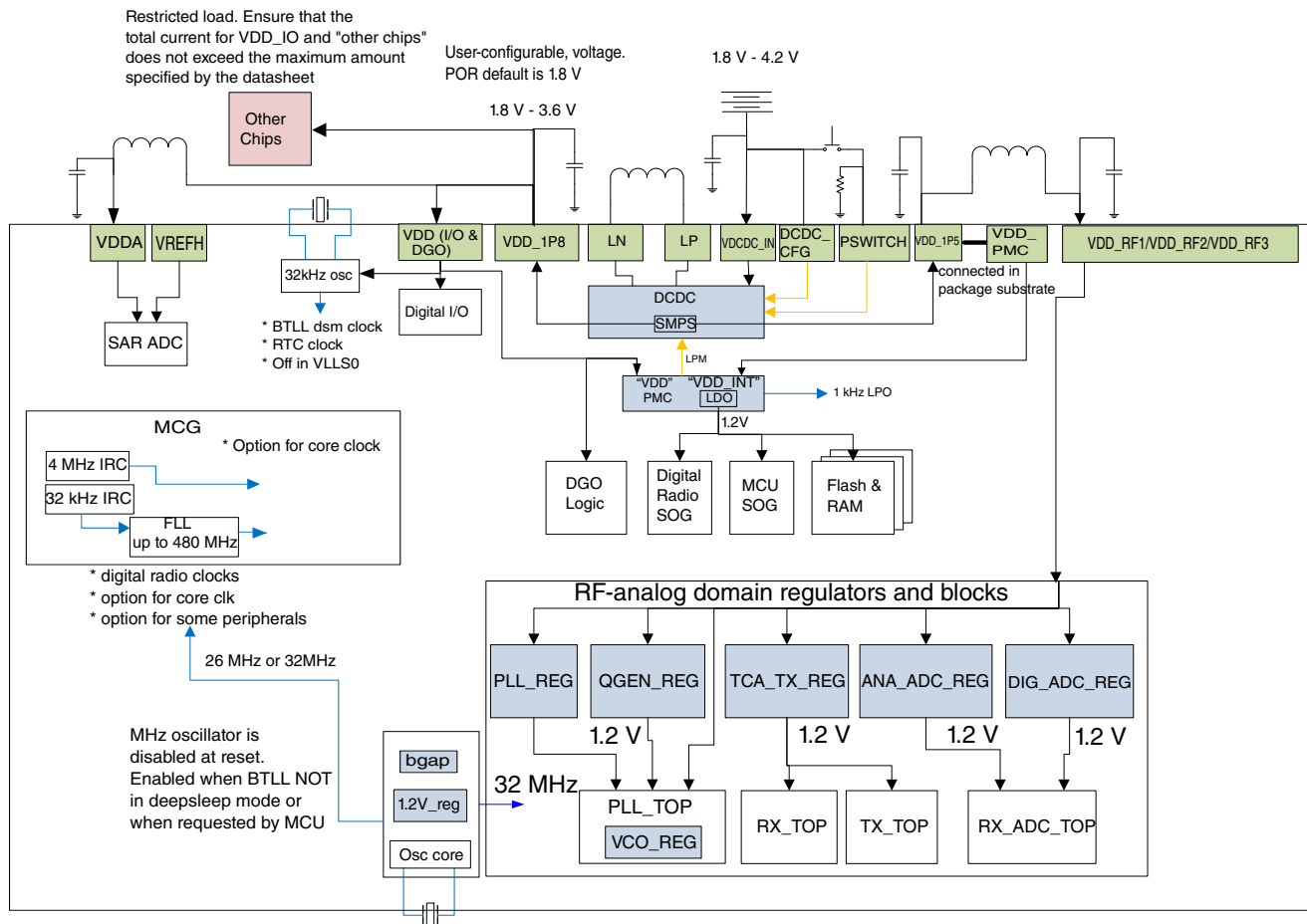

Figure 3-8. Buck Power Tree

The figure illustrates the use case where a push-button switch is used with PSWITCH pin. When the DCDC is off, depressing the button would cause the PSWITCH to be asserted momentarily to V_{DCDC_IN} , which would turn on the DCDC. After power-on, software can also check the state of the PSWITCH input; this could be used for example to signal that the device should be powered-off under software control through appropriate DCDC registers. The device does not require that a push-button be used; PSWITCH could be shorted to V_{DCDC_IN} (in which case the DCDC would always remain on while the battery is present) or used with a different type of switch.

NOTE

When using a rechargeable battery the PSWITCH pin should not be shorted to V_{DCDC_IN} , as leaving the DCDC always enabled may damage rechargeable batteries due to over-discharge.

It is expected that software will monitor the V_{DCDC_IN} periodically (using the SAR ADC), adjust the DCDC settings as needed to optimize performance, and shut off the DCDC if the battery voltage becomes too low.

Depending on the use case and low power mode, it may be more efficient to use the pulsed mode of the DCDC instead of continuous mode. The mapping of the device low power modes to the DCDC mode is shown in the table below.

Table 3-14. Low Power Configuration for Buck Mode

| Device Low Power Mode | DCDC mode |
|--------------------------|---|
| RUN, WAIT and STOP modes | continuous mode |
| VLPR and VLPW modes | user configurable: continuous, or pulsed mode |
| VLPS mode | user configurable: continuous, or pulsed mode |
| LLSx and VLLSx modes | pulsed mode |

On exit from pulsed mode to continuous mode, there is an expected delay ($T_{DCDC_SETTLE_BUCK}$) before the DCDC is fully capable of supporting the maximum loads. This is not expected to impact VDD_1P5 with an appropriately sized external capacitor, but the user may need to delay enabling large loads on VDD_1P8 (digital I/O, or external circuits). This delay should be completely hidden for exit from VLLSx modes, but not for LLSx or VLPx modes, so the users will need to be aware of this restriction.

3.4.4.2 Boost Mode

Boost mode supports operation with battery voltages from 0.9V-1.8V.

The figure below illustrates the power tree when the DCDC is configured in Boost mode. The power pins shown in the figure are used as follows:

- The DCDC cfg pin is grounded to select Boost configuration.
- The PSWITCH pin is used to power-on the DCDC. For boost, there is a restriction that the PSWITCH must be shorted to VDCDC_IN so that the DCDC will always power up when a voltage is presented to VDCDC_IN.
- VDCDC_IN powers the DCDC regulator. It is expected that a capacitor is connected to VDCDC_IN to help support large transient or short duration loads, including Rx and Tx bursts.
- VDD_1P5 is the 1.5V output of the DCDC. In boost mode, this output actually defaults to 1.8V at DCDC startup. After DCDC startup, it can be programmed for a lower voltage to save power, but it needs to be greater than VDCDC_IN + 50mV for proper DCDC operation. The VDD_1P5 pin needs to be filtered off-chip.
- VDD_PMC is a pad which is connected to VDD_1P5 in the package substrate (does not apply to the WLCSP; system designers should take care to connected these signals via short PCB trace). This pad supplies power to the PMC's LDO regulator which generates 1.2V to the internal logic.

System modules

- VDD_RF1/VDD_RF2/VDD_RF3 supplies power to the RF-analog domain regulators. It is powered from a filtered version of the 1.5V DCDC output
- VDD_1P8 is the second output of the DCDC. At DCDC power-up, this defaults to 1.8V. However, it can be programmed after power-up to provide a higher voltage. VDD_1P8 is expected to be filtered off-chip with a capacitor.
- VDD (I/O and DGO) supplies power to the digital I/O pins and the DGO logic that is always powered whenever the DCDC is enabled.
- VDDA powers the SAR ADC. This can be connected to VDD_1P8.
- VREFH is a reference option for the SAR ADC. This can be connected to VDD_1P8 or an external reference can be used.

NOTE

VDD_1P5 and VDD_PMC are not connected in the substrate of the WLCSP package. System designers should take care to connect these pins (VDD_1P5_CAP and VDD_1P5_PMCIN as pin name) correctly when designing hardware.

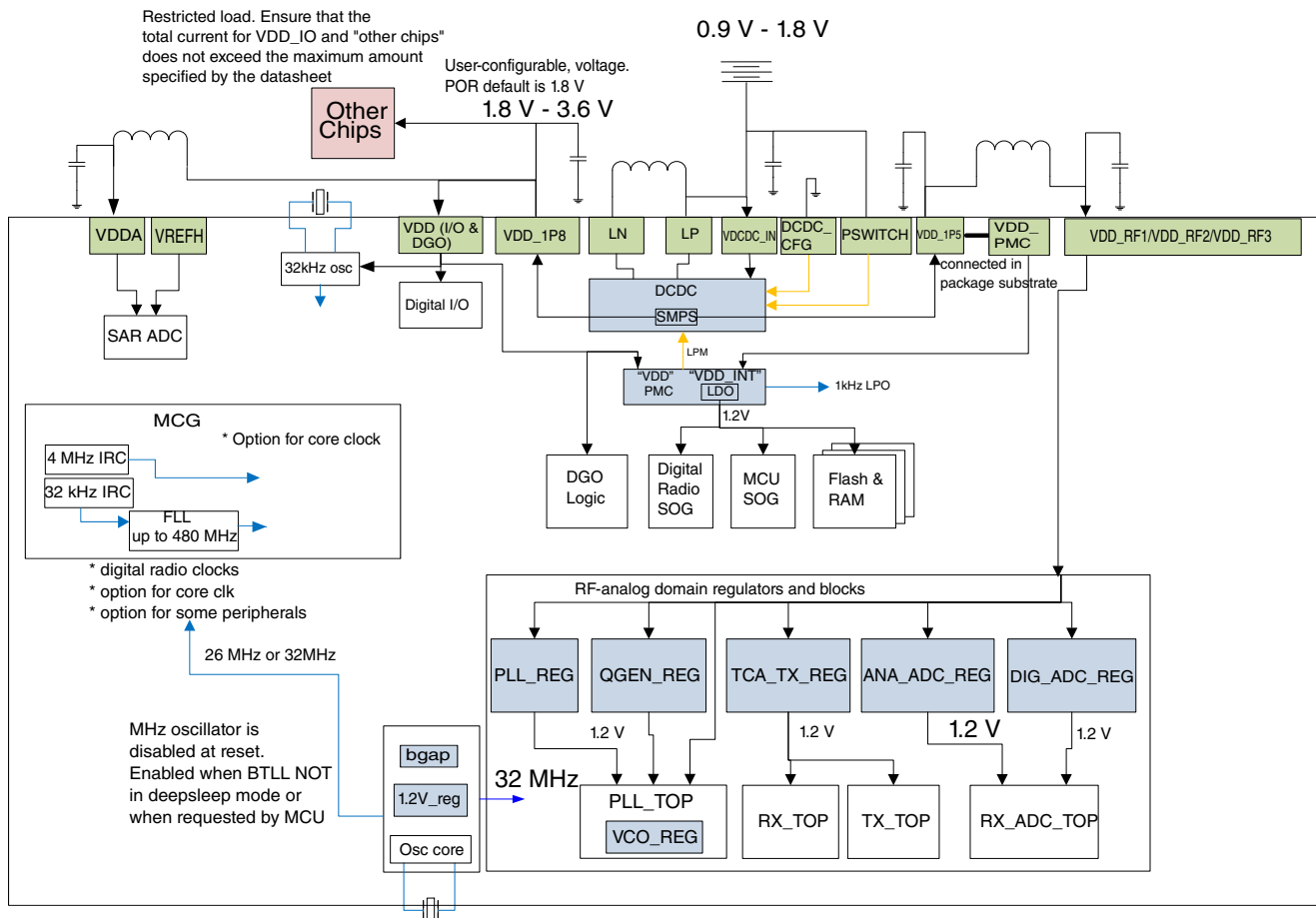

Figure 3-9. Boost Power Tree

In boost mode, there is a restriction that the DCDC should not be disabled when VDCDC_IN is present. As a result, the DCDC should also not be shut of by software in boost mode. The figure illustrates the use case where an on/off switch is used to power on and off the device. If an on/off switch is not used in an application, then the DCDC will always be enabled when the battery is present; when the device is otherwise inactive a low power mode (such as VLLS1) would be recommended to reduce current drain and extend battery life.

It is expected that software will monitor the VDCDC_IN periodically (using the SAR ADC) and adjust the DCDC settings as needed to optimize performance.

Depending on the use case and low power mode, it may be more efficient to use the pulsed mode of the DCDC instead of continuous mode. The mapping of the device low power modes to the DCDC mode is shown in the table below.

Table 3-15. Low Power Configuration for Boost Mode

| Device Low Power Mode | DCDC mode |
|--------------------------|---|
| RUN, WAIT and STOP modes | continuous mode |
| VLPR and VLPW modes | user configurable: continuous, or pulsed mode |
| VLPS mode | user configurable: continuous, or pulsed mode |
| LLSx and VLLSx modes | pulsed mode |

On exit from pulsed mode to continuous mode, there is an expected delay ($T_{DCDC_SETTLE_BOOST}$) before the DCDC is fully capable of supporting the maximum loads. This is not expected to impact VDD_1P5 with an appropriately sized external capacitor, but the user may need to delay enabling large loads on VDD_1P8 (digital I/O, or external circuits). This delay should be completely hidden for exit from VLLSx modes, but not for LLSx or VLPx modes, so the users will need to be aware of this restriction.

3.4.4.3 Bypass Mode

The figure below illustrates the power tree when the DCDC is configured in Bypass mode. The power pins shown in the figure are used as follows:

- The DCDC_CFG pin is tied to HIGH and the PSWITCH pin is tied to ground (GND) to select bypass mode operation.
- The VDCDC_IN needs to be powered to allow the DCDC to recognize the DCDC_CFG and PSWITCH signals.
- LN, LP, and VDD_1P8 pins are not used.
- VDD_PMC is a 1.5-3.6 V input which supplies power to the PMC's LDO regulator which generates 1.2 V to the internal logic.

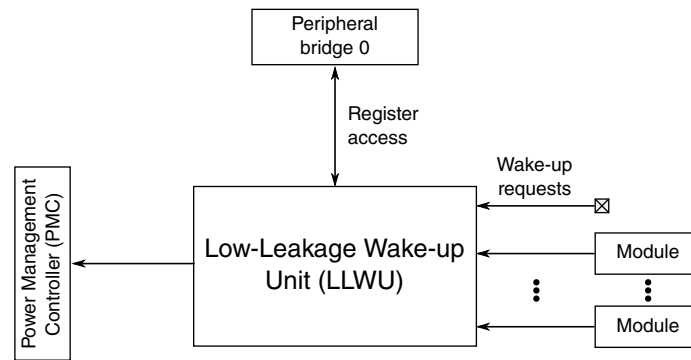

Figure 3-11. Low-Leakage Wake-up Unit configuration

Table 3-16. Reference links to related information

| Topic | Related module | Reference |
|-------------------|-----------------------------------|---|
| Full description | LLWU | LLWU |
| System memory map | | System memory map |
| Clocking | | Clock distribution |
| Power management | | Power management chapter |
| | Power Management Controller (PMC) | Power Management Controller (PMC) |
| | System Mode Controller (SMC) | System Mode Controller |
| Wake-up requests | | LLWU wake-up source |

3.4.5.1 LLWU interrupt

Do not mask the LLWU interrupt when in LLS mode. Masking the interrupt prevents the device from exiting stop mode when a wakeup is detected.

3.4.5.2 Wake-up Sources

The device uses the following internal peripheral and external pin inputs as wakeup sources to the LLWU module. LLWU_Px are external pin inputs, and LLWU_M0IF-M7IF are connections to the internal peripheral interrupt flags.

NOTE

In addition to the LLWU wakeup sources, the device also wakes from low power modes when NMI or RESET pins are enabled and the respective pin is asserted.

Table 3-17. LLWU Wakeup Sources

| LLWU Inputs | Module source or pin name |
|-------------|--|
| LLWU_P0 | PTC16 ¹ |
| LLWU_P1 | PTC17 ¹ |
| LLWU_P2 | PTC18 ¹ |
| LLWU_P3 | PTC19 ¹ |
| LLWU_P4 | PTA16 ¹ |
| LLWU_P5 | PTA17 ¹ |
| LLWU_P6 | PTA18 ¹ |
| LLWU_P7 | PTA19 ¹ |
| LLWU_P8 | PTB0 ¹ |
| LLWU_P9 | PTC0 ^{1,2} |
| LLWU_P10 | PTC2 ¹ |
| LLWU_P11 | PTC3 ¹ |
| LLWU_P12 | PTC4 ¹ |
| LLWU_P13 | PTC5 ¹ |
| LLWU_P14 | PTC6 ¹ |
| LLWU_P15 | PTC7 ¹ |
| LLWU_M0IF | LPTMR0 |
| LLWU_M1IF | CMP0 |
| LLWU_M2IF | Generic Radio Wake up Request ³ |
| LLWU_M3IF | DCDC ⁴ |
| LLWU_M4IF | TSI |
| LLWU_M5IF | RTC Alarm |
| LLWU_M6IF | Reserved |
| LLWU_M7IF | RTC Seconds |

1. When the DCDC is operating in buck or boost mode, a pin wake up event will also set the ISF (interrupt status flag) of the associated pin when exiting from LLS mode. The application should ignore this flag and simply clear it in the interrupt service routine used to service the LLS wake up event.
2. PTC0 is not available on the 48-pin Laminate QFN package.
3. This wakeup interrupt signal is generated by the RSIM. BLE link layer controller, 802.15.4 link layer controller and Generic FSK link layer controller can all generate the wake up signal.
4. This is for the PSWITCH interrupt

3.4.6 MCM configuration

This section summarizes how the module has been configured in the chip.

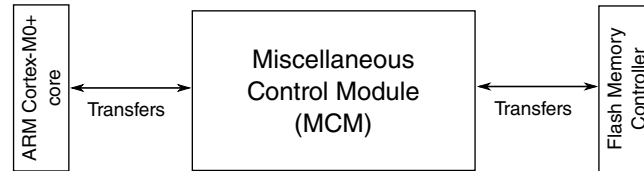

Figure 3-12. MCM configuration

Table 3-18. Reference links to related information

| Topic | Related module | Reference |
|------------------------------|------------------------------------|---|
| Full description | Miscellaneous control module (MCM) | MCM |
| System memory map | — | System memory map |
| Clocking | — | Clock distribution |
| Power management | — | Power management |
| Private peripheral bus (PPB) | ARM Cortex-M0+ core | ARM Cortex-M0+ core |
| Transfer | Flash memory controller | Flash memory controller |

3.4.7 Crossbar-light switch configuration

This section summarizes how the module has been configured in the chip.

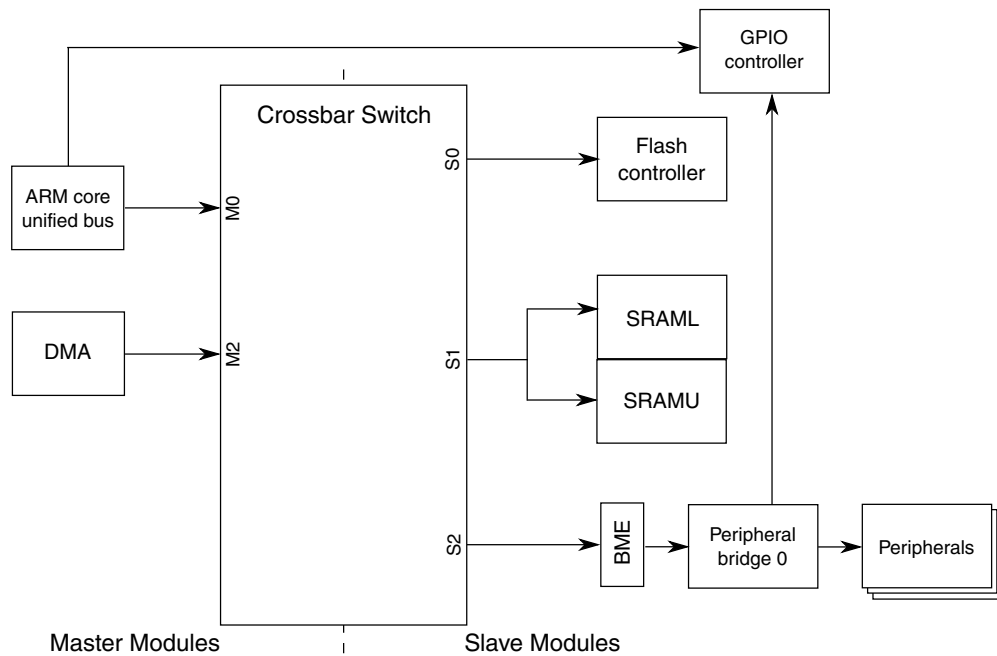

Figure 3-13. Crossbar-light switch integration

Table 3-19. Reference links to related information

| Topic | Related module | Reference |
|------------------------|-------------------------|---|
| Full description | Crossbar switch | Crossbar switch |
| System memory map | - | System memory map |
| Clocking | - | Clock distribution |
| Crossbar switch master | ARM Cortex-M0+ core | ARM Cortex-M0+ core |
| Crossbar switch master | DMA controller | DMA controller |
| Crossbar switch slave | Flash memory controller | Flash memory controller |
| Crossbar switch slave | SRAM controller | SRAM configuration |
| Crossbar switch slave | Peripheral bridge | Peripheral bridge |
| 2-ported peripheral | GPIO controller | GPIO controller |

3.4.7.1 Crossbar-Light Switch Master Assignments

The masters connected to the crossbar switch are assigned as follows:

| Master module | Master port number |
|----------------------|--------------------|
| ARM core unified bus | 0 |
| DMA | 2 |

3.4.7.2 Crossbar Switch Slave Assignments

This device contains slaves connected to the crossbar switch.

The slave assignment is as follows:

| Slave module | Slave port number |
|-------------------------|-------------------|
| Flash memory controller | 0 |
| SRAM controller | 1 |
| Peripheral bridge 0 | 2 |

3.4.8 Peripheral bridge configuration

This section summarizes how the module has been configured in the chip.

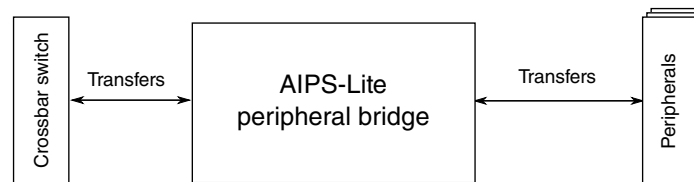

Figure 3-14. Peripheral bridge configuration

Table 3-20. Reference links to related information

| Topic | Related module | Reference |
|-------------------|-------------------------------|---|
| Full description | Peripheral bridge (AIPS-Lite) | Peripheral bridge (AIPS-Lite) |
| System memory map | — | System memory map |
| Clocking | — | Clock distribution |
| Crossbar switch | Crossbar switch | Crossbar switch |

3.4.8.1 Number of peripheral bridges

This device contains one peripheral bridge.

3.4.8.2 Memory maps

The peripheral bridges are used to access the registers of most of the modules on this device. See [Peripheral Bridge \(AIPS-Lite\) Memory Map](#) for the memory slot assignment for each module.

3.4.9 DMA request multiplexer configuration

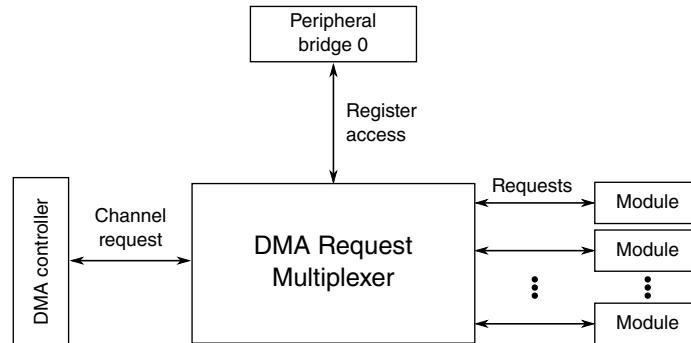

Figure 3-15. DMA request multiplexer configuration

Table 3-21. Reference links to related information

| Topic | Related module | Reference |
|-------------------|-------------------------|-------------------------------------|
| Full description | DMA request multiplexer | DMA Mux |
| System memory map | | System memory map |
| Clocking | | Clock distribution |
| Power management | | Power management |
| Channel request | DMA controller | DMA Controller |
| Requests | | DMA request sources |

3.4.9.1 DMA MUX Request Sources

This device includes a DMA request mux that allows up to 63 DMA request signals to be mapped to any of the 4 DMA channels. Because of the mux there is no hard correlation between any of the DMA request sources and a specific DMA channel. Some of the modules support Asynchronous DMA operation as indicated by the last column in the following DMA source assignment table.

Table 3-22. DMA request sources - MUX 0

| Source number | Source module | Source description | Async DMA capable |
|---------------|-------------------|-------------------------------|-------------------|
| 0 | — | Channel disabled ¹ | |
| 1 | Reserved | Not used | |
| 2 | LPUART0 | Receive | Yes |
| 3 | LPUART0 | Transmit | Yes |
| 4 | Reserved | — | |
| 5 | Reserved | — | |
| 6 | Reserved | — | |
| 7 | Reserved | — | |
| 8 | Reserved | — | |
| 9 | Reserved | — | |
| 10 | Reserved | — | |
| 11 | 2.4G Radio | XCVR DMA | |
| 12 | Reserved | — | |
| 13 | Reserved | — | |
| 14 | Reserved | — | |
| 15 | Reserved | — | |
| 16 | SPI0 | Receive | |
| 17 | SPI0 | Transmit | |
| 18 | SPI1 | Receive | |
| 19 | SPI1 | Transmit | |
| 20 | AESA | Input FIFO | |
| 21 | AESA | Output FIFO | |
| 22 | I ² C0 | — | |
| 23 | I ² C1 | — | |
| 24 | TPM0 | Channel 0 | Yes |
| 25 | TPM0 | Channel 1 | Yes |
| 26 | TPM0 | Channel 2 | Yes |
| 27 | TPM0 | Channel 3 | Yes |
| 28 | Reserved | — | |
| 29 | Reserved | — | |
| 30 | Reserved | — | |
| 31 | Reserved | — | |
| 32 | TPM1 | Channel 0 | Yes |
| 33 | TPM1 | Channel 1 | Yes |
| 34 | TPM2 | Channel 0 | Yes |
| 35 | TPM2 | Channel 1 | Yes |
| 36 | Reserved | — | |
| 37 | Reserved | — | |

Table continues on the next page...

Table 3-22. DMA request sources - MUX 0 (continued)

| Source number | Source module | Source description | Async DMA capable |
|---------------|---------------------|--------------------|-------------------|
| 38 | Reserved | — | |
| 39 | Reserved | — | |
| 40 | ADC0 | — | Yes |
| 41 | Reserved | — | |
| 42 | CMP0 | — | Yes |
| 43 | Reserved | — | |
| 44 | Reserved | — | |
| 45 | DAC0 | — | |
| 46 | Reserved | — | |
| 47 | CMT | — | |
| 48 | Reserved | — | |
| 49 | Port control module | Port A | Yes |
| 50 | Port control module | Port B | Yes |
| 51 | Port control module | Port C | Yes |
| 52 | Reserved | — | |
| 53 | Reserved | — | |
| 54 | TPM0 | Overflow | Yes |
| 55 | TPM1 | Overflow | Yes |
| 56 | TPM2 | Overflow | Yes |
| 57 | TSI0 | — | Yes |
| 58 | Reserved | — | |
| 59 | Reserved | — | |
| 60 | DMA MUX | Always enabled | |
| 61 | DMA MUX | Always enabled | |
| 62 | DMA MUX | Always enabled | |
| 63 | DMA MUX | Always enabled | |

1. Configuring a DMA channel to select source 0 or any of the reserved sources disables that DMA channel.

3.4.9.2 DMA transfers via PIT trigger

The PIT module can trigger a DMA transfer on the first two DMA channels. The assignments are detailed at [PIT/DMA Periodic Trigger Assignments](#) .

3.4.10 DMA Controller Configuration

This section summarizes how the module has been configured in the chip.

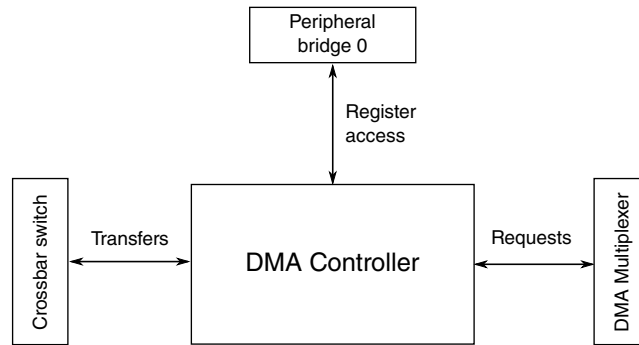

Figure 3-16. DMA Controller configuration

Table 3-23. Reference links to related information

| Topic | Related module | Reference |
|-------------------|-----------------|-------------------------------------|
| Full description | DMA controller | DMA controller |
| System memory map | | System memory map |
| Clocking | | Clock distribution |
| Power management | | Power management |
| Crossbar switch | Crossbar switch | Crossbar switch |
| Requests | | DMA request sources |

3.4.11 Computer operating properly (COP) watchdog configuration

This section summarizes how the module has been configured in the chip.

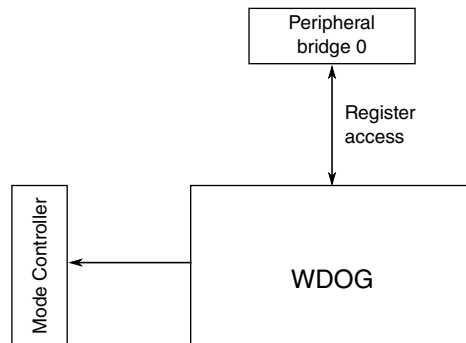

Figure 3-17. COP watchdog configuration

Table 3-24. Reference links to related information

| Topic | Related module | Reference |
|------------------|----------------|------------------------------------|
| Clocking | — | Clock distribution |
| Power management | — | Power management |

Table continues on the next page...

Table 3-24. Reference links to related information (continued)

| Topic | Related module | Reference |
|-------------------|---------------------------------|---------------------|
| Programming model | System integration module (SIM) | SIM |

3.4.11.1 COP clocks

The multiple clock inputs for the COP are:

- 1 kHz (LPO) clock
- bus clock
- MCGIRCLK
- OSCERCLK

3.4.11.2 COP watchdog operation

The COP watchdog is intended to force a system reset when the application software fails to execute as expected. To prevent a system reset from the COP timer (when it is enabled), the application software must reset the COP counter periodically. If the application program gets lost and fails to reset the COP counter before it times out, a system reset is generated to force the system back to a known starting point.

After any reset, the COP watchdog is enabled. If the COP watchdog is not used in an application, it can be disabled by clearing SIM_COPC[COPT].

The COP counter is reset by writing 0x55 and 0xAA (in that order) to the address of the SIM's Service COP (SRVCOP) register during the selected timeout period. Writes do not affect the data in the SRVCOP register. As soon as the write sequence is complete, the COP timeout period is restarted. If the program fails to perform this restart during the timeout period, the microcontroller resets. Also, if any value other than 0x55 or 0xAA is written to the SRVCOP register, the microcontroller immediately resets.

SIM_COPC[COPCLKS] and SIM_COPC[COPCLKSEL] select the timeout duration and clock source used for the COP timer. The clock source options are either the bus clock, MCGIRCLK, OSCERCLK, or the internal 1 kHz (LPO) clock source. With each clock source, the associated timeouts are controlled by SIM_COPC[COPT] and SIM_COPC[COPCLKS]. The following table summarizes the control functions of

SIM_COPC[COPCLKS] and SIM_COPC[COPCLKSEL] and SIM_COPC[COPT] fields. The COP watchdog defaults to operation from the 1 kHz clock source and the longest timeout is 2^{10} cycles.

Table 3-25. COP configuration options

| Control bits | | | Clock source | COP window opens (SIM_COPC[COPW]=1) | COP overflow count |
|---------------------|-------------------|----------------|--------------|--|----------------------------|
| SIM_COPC[COPCLKSEL] | SIM_COPC[COPCLKS] | SIM_COPC[COPT] | | | |
| N/A | N/A | 00 | N/A | N/A | COP is disabled. |
| 00 | 0 | 01 | 1 kHz | N/A | 2^5 cycles (32ms) |
| | 1 | | | 6,144 cycles | 2^{13} cycles (8192ms) |
| 00 | 0 | 10 | 1 kHz | N/A | 2^8 cycles (256ms) |
| | 1 | | | 49,152 cycles | 2^{16} cycles (65536ms) |
| 00 | 0 | 11 | 1 kHz | N/A | 2^{10} cycles (1024ms) |
| | 1 | | | 196,608 cycles | 2^{18} cycles (262144ms) |
| 01 | 0 | 01 | MCGIRCLK | N/A | 2^5 cycles |
| | 1 | | | 6,144 cycles | 2^{13} cycles |
| 01 | 0 | 10 | MCGIRCLK | N/A | 2^8 cycles |
| | 1 | | | 49,152 cycles | 2^{16} cycles |
| 01 | 0 | 11 | MCGIRCLK | N/A | 2^{10} cycles |
| | 1 | | | 196,608 cycles | 2^{18} cycles |
| 10 | 0 | 01 | OSCERCLK | N/A | 2^5 cycles |
| | 1 | | | 6,144 cycles | 2^{13} cycles |
| 10 | 0 | 10 | OSCERCLK | N/A | 2^8 cycles |
| | 1 | | | 49,152 cycles | 2^{16} cycles |
| 10 | 0 | 11 | OSCERCLK | N/A | 2^{10} cycles |
| | 1 | | | 196,608 cycles | 2^{18} cycles |
| 11 | 0 | 01 | bus | N/A | 2^5 cycles |
| | 1 | | | 6,144 cycles | 2^{13} cycles |
| 11 | 0 | 10 | bus | N/A | 2^8 cycles |
| | 1 | | | 49,152 cycles | 2^{16} cycles |
| 11 | 0 | 11 | bus | N/A | 2^{10} cycles |
| | 1 | | | 196,608 cycles | 2^{18} cycles |

After the long timeout (COPCLKS = 1) is selected, windowed COP operation is available by setting SIM_COPC[COPW]. In this mode, writes to SIM_SRVCOP to clear the COP timer must occur in the last 25% of the selected timeout period. A premature write immediately resets the chip. When the short timeout (COPCLKS = 0) is selected, windowed COP operation is not available.

The COP counter is initialized by the first writes to SIM_COPC and after any system reset. Subsequent writes to SIM_COPC have no effect on COP operation. Even if an application uses the reset default settings of SIM_COPC[COPT], SIM_COPC[COPCLKS], SIM_COPC[COPCLKSEL], and SIM_COPC[COPW] fields, the user should write to the write-once SIM_COPC register during reset initialization to lock in the settings. This approach prevents accidental changes if the application program becomes lost.

The write to SIM_SRVCOP that services (clears) the COP counter should not be placed in an interrupt service routine (ISR) because the ISR could continue to be executed periodically even if the main application program fails.

If the selected clock is not the 1 kHz clock source, the COP counter does not increment while the microcontroller is in Debug mode or while the system is in Stop (including VLPS or LLS) mode. The COP counter resumes when the microcontroller exits Debug or Stop mode.

The COP counter is re-initialized to 0 upon entry to either Debug mode or Stop (including VLPS or LLS) mode. The counter begins from 0 upon exit from Debug mode or Stop mode.

The COP counter can also be configured to continue incrementing during Debug mode or Stop (including VLPS) mode if either COPDBGEN or COPSTPEN are set respectively. When the selected clock is the bus clock and COPSTPEN bit is set, the COP counter cannot increment during Stop modes, however the COP counter is not reset to 0.

Regardless of the clock selected, the COP is disabled when the chip enters a VLLSx mode. Upon a reset that wakes the chip from the VLLSx mode, the COP is reinitialized and enabled as for any reset.

3.4.11.3 Clock Gating

This family of devices includes clock gating control for each peripheral, that is, the clock to each peripheral can explicitly be gated on or off, using clock-gate control bits in the SIM module.

3.5 Clock modules

3.5.1 MCG configuration

This section summarizes how the module has been configured in the chip.

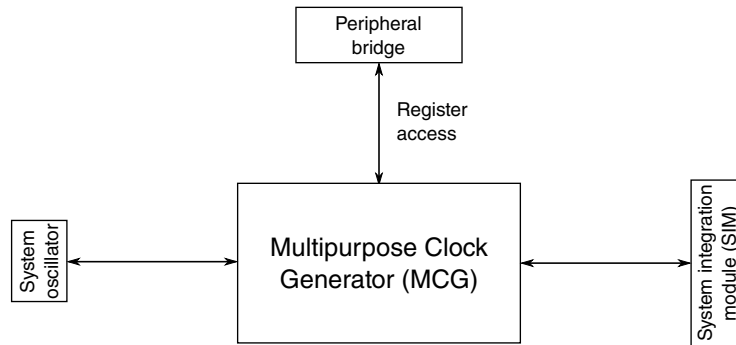

Figure 3-18. MCG configuration

Table 3-26. Reference links to related information

| Topic | Related module | Reference |
|---------------------|----------------|-------------------------------------|
| Full description | MCG | MCG |
| System memory map | — | System memory map |
| Clocking | — | Clock distribution |
| Power management | — | Power management |
| Signal multiplexing | Port control | Signal multiplexing |

3.5.1.1 MCG Instantiation Information

- OSC0 refers to the reference (26 MHz or 32 MHz) oscillator
- MCG_C2[RANGE0] should be set to 1x for clock monitor function to work correctly with the RF oscillator
- MCG_C2[HGO0] is not used
- MCG_C2[EREFS0] is not used
- MCG_S[OSCINIT0] is tied to 0 in KW41Z. Software can use the RSIM's CONTROL[RF_OSC_READY] bit to check on the status of the RF oscillator
- MCG_C7[OSCSEL]: The 32kHz oscillator should be enabled via the RTC before attempting to program the MCG to use the 32kHz oscillator

3.5.1.2 MCG FLL modes

The MCGFLLCLK frequency is limited to 48 MHz at maximum in this device. The digitally-controller oscillator (DCO) is limited to the two lowest range settings, that is, MCG_C4[DRST_DRS] must be set to either 0b00 or 0b01.

3.5.2 32kHz OSC Configuration

This section summarizes how the module has been configured in the chip.

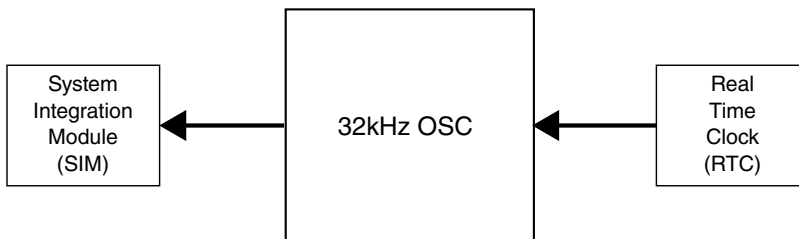

Figure 3-19. 32kHz OSC configuration

Table 3-27. Reference links to related information

| Topic | Related module | Reference |
|---------------------|------------------|-------------------------------------|
| Full description | 32kHz Oscillator | OSC |
| System memory map | — | System memory map |
| Clocking | — | Clock distribution |
| Power management | — | Power management |
| Signal multiplexing | Port control | Signal multiplexing |
| Full description | MCG | MCG |

3.5.2.1 32kHz OSC Instantiation Information

The 32kHz oscillator provides the clock source for the RTC. It supports 32kHz crystal with very low power consumption. Internal programmable capacitors are controlled by RTC module

3.5.3 Reference Oscillator Configuration

This section summarizes how the module has been configured in the chip.

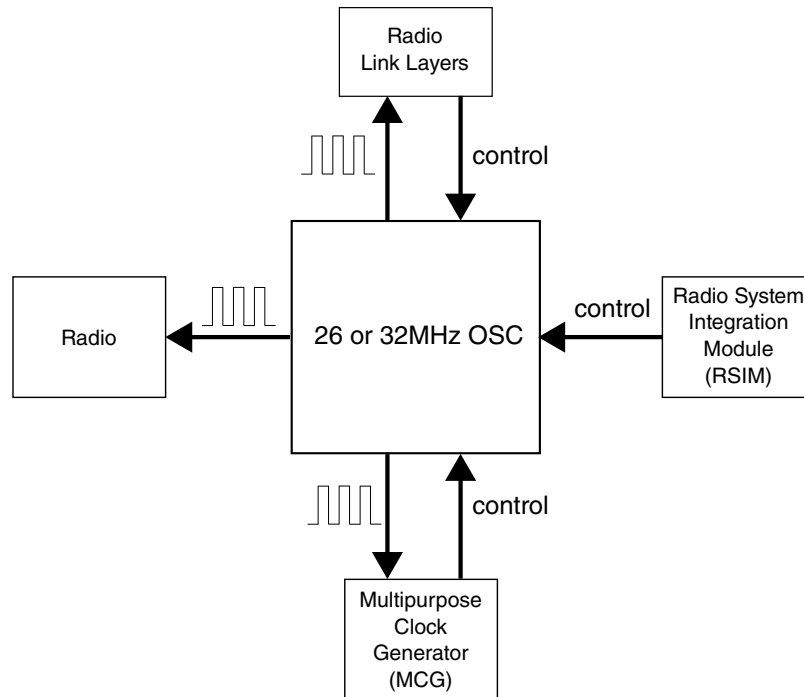

Figure 3-20. Reference OSC configuration

Table 3-28. Reference links to related information

| Topic | Related module | Reference |
|---------------------|----------------------|-------------------------------------|
| Full description | Reference Oscillator | REF_OSC |
| System memory map | — | System memory map |
| Clocking | — | Clock distribution |
| Power management | — | Power management |
| Signal multiplexing | Port control | Signal multiplexing |
| Full description | MCG | MCG |

3.5.3.1 Reference Oscillator Instantiation Information

The reference oscillator is the master clock for the radio and the MCU core. There are multiple enable/disable sources for the oscillator, they are Radio Link Layer, Radio System Integration Module ([RSIM](#)) and Multipurpose Clock Generator ([MCG](#)).

The radio link layers enable the reference oscillator when they are not in deepsleep mode (DSM).

The reference oscillator can be enabled manually for Run/Wait modes, and also optionally for Stop mode. It is done by setting the appropriate bits in the Radio System Integration Module (RSIM).

The MCG outputs a signal which enables the reference oscillator whenever OSCERCLK is selected for MCGOUTCLK or used as the reference for the FLL.

Note that use of the reference oscillator in VLPx modes is only possible when the DCDC is configured in continuous mode.

3.6 Memories and memory interfaces

3.6.1 Flash Memory Configuration

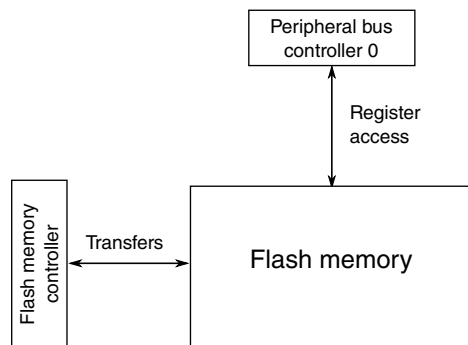

Figure 3-21. Flash memory configuration

Table 3-29. Reference links to related information

| Topic | Related module | Reference |
|-------------------|-------------------------|---|
| Full description | Flash memory | Flash memory |
| System memory map | | System memory map |
| Clocking | | Clock Distribution |
| Transfers | Flash memory controller | Flash memory controller |
| Register access | Peripheral bridge | Peripheral bridge |

3.6.1.1 Flash Memory Sizes

The device contains 512/256 KB Flash.

3.6.1.2 Flash Memory Map

The flash memory and the flash registers are located at different base addresses as shown in the following figure. The base address for each is specified in [System memory map](#).

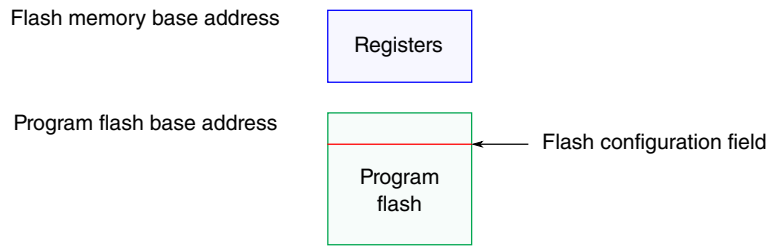

Figure 3-22. Flash memory map

The on-chip Flash is implemented in a portion of the allocated Flash range to form a contiguous block in the memory map beginning at address 0x0000_0000. See [Flash Memory Sizes](#) for details of supported ranges.

Accesses to the Flash memory ranges outside the amount of Flash on the device causes the bus cycle to be terminated with an error followed by the appropriate response in the requesting bus master.

3.6.1.3 Flash Security

How flash security is implemented on this device is described in [Chip Security](#).

3.6.1.3.1 Flash Access Control Introduction

The Flash Access Control (FAC) is a NXP or third-party configurable memory protection scheme optimized to allow end users to utilize software libraries while offering programmable restrictions to these libraries. The flash memory is divided into equal size segments that provide protection to proprietary software libraries. The protection of these segments is controlled as the FAC provides a cycle-by-cycle evaluation of the access rights for each transaction routed to the on-chip flash memory. Configurability allows an increasing number of protected segments while supporting two levels of vendors adding their proprietary software to a device.

Flash access control aligns to the three privilege levels supported by ARM Cortex-M family products where the most secure state - supervisor/privileged secure - aligns to the execute-only and supervisor-only access control. The unsecure state of user non-secure aligns to no access control states set, and the mid-level state where user secure aligns to using the access control of execute-only.

Control for this protection scheme is implemented in Program Once NVM locations and is configurable through a Program Once flash command operations. The NVM locations controlling FAC are unaffected by Erase All Blocks flash command and debug interface initiated mass erase operations.

NOTE

The FAC protection scheme has eight XACC and eight SACC registers to control up to 64 segments. For program flash sizes 128KB or less, the memory is divided into 32 segments, controlled by the four lower-order XACC and SACC registers.

To protect the NVM locations being used for execute only code from being mass erased FTFA_FSEC[MEEN] bits must be set to 'b10.

3.6.1.4 Flash Modes

The [FTFE](#) chapter defines two modes of operation - NVM normal and NVM special modes. On this device, The flash memory only operates in NVM normal mode. All references to NVM special mode should be ignored.

3.6.1.5 Erase All Flash Contents

In addition to software, the entire flash memory may be erased external to the flash memory via the SW-DP debug port by setting MDM-AP CONTROL[0]. MDM-AP STATUS[0] is set to indicate the mass erase command has been accepted. MDM-AP STATUS[0] is cleared when the mass erase completes. The flash of the MCU is protected from erasing all of the flash contents by the FTFA_FSEC[MEEN] bits. If the bits are set to 'b10 mass erase is disabled.

3.6.1.6 FTFA_FOPT Register

The flash memory's FTFA_FOPT register allows the user to customize the operation of the MCU at boot time. See [FOPT boot options](#) for details of its definition.

3.6.2 Flash Memory Controller Configuration

This section summarizes how the module has been configured in the chip.

See MCM_PLACR register description for details on the reset configuration of the FMC.

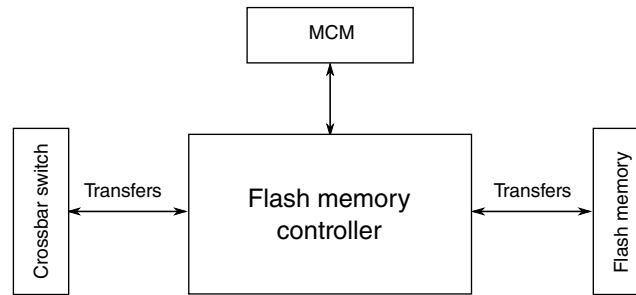

Figure 3-23. Flash memory controller configuration

Table 3-30. Reference links to related information

| Topic | Related module | Reference |
|-------------------|-------------------------|---|
| Full description | Flash memory controller | Flash memory controller |
| System memory map | | System memory map |
| Clocking | | Clock Distribution |
| Transfers | Flash memory | Flash memory |
| Transfers | Crossbar switch | Crossbar Switch |
| Register access | MCM | MCM |

3.6.3 SRAM Configuration

This section summarizes how the module has been configured in the chip.

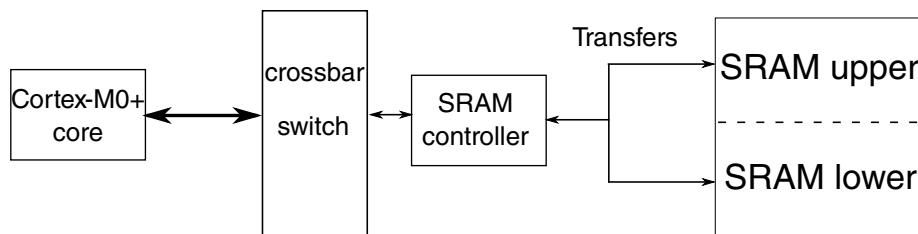

Figure 3-24. SRAM configuration

Table 3-31. Reference links to related information

| Topic | Related module | Reference |
|---------------------|----------------|-------------------------------------|
| Full description | SRAM | SRAM |
| System memory map | | System memory map |
| Clocking | | Clock Distribution |
| ARM Cortex-M0+ core | | ARM Cortex-M0+ core |

3.6.3.1 SRAM Sizes

The device contains 128/64 KB of SRAM which can be accessed by bus masters through the cross-bar switch.

3.6.3.2 SRAM Ranges

The device contains 128 KB of SRAM, split into two ranges, 1/4 (32 Kbytes) is allocated to SRAM_L and 3/4 (96 Kbytes) is allocated to SRAM_U. The first 16 Kbytes of SRAM_U remains powered in LLS2 and VLLS2 modes. The ranges are as follows:

- SRAM_L: 0x1FFF_8000-0x1FFF_FFFF (32 Kbytes). Powered off in LLS2 and VLLS2
- SRAM_U: 0x2000_0000-0x2001_7FFF (96 Kbytes)
 - 0x2000_0000 to 0x2000_3FFF (16 Kbytes). Remains powered in LLS2 and VLLS2
 - 0x2000_4000 to 0x2000_7FFF (16 Kbytes). Powered off in LLS2 and VLLS2. This can be powered on by setting SMC_STOPCTRL[RAM2PO]
 - 0x2000_8000~0x2001_7FFF(64 Kbytes): Powered off in LLS2 and VLLS2

This is illustrated in the following figure.

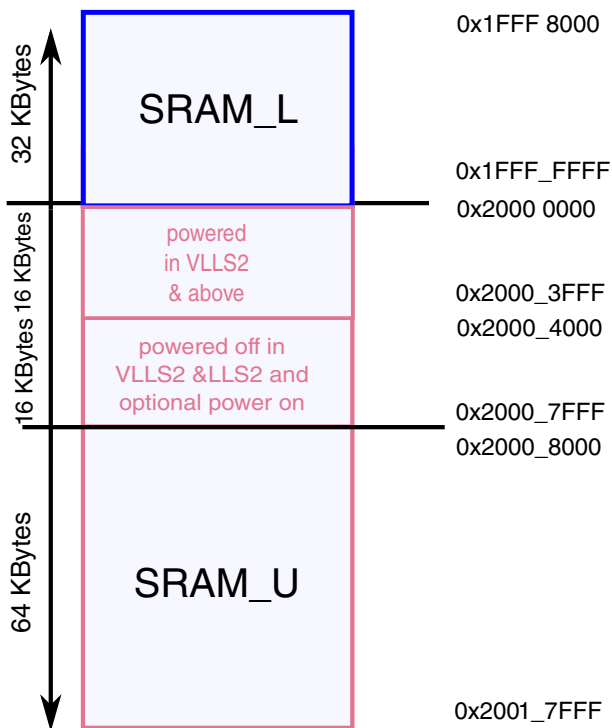

Figure 3-25. SRAM blocks memory map

3.6.3.3 SRAM retention in low power modes

In VLLS1 and VLLS0, no SRAM is retained. In LLS2 and VLLS2 modes, the 16 KB region of SRAM_U range from 0x2000_0000 to 0x2000_3FFF is powered. Optionally another 16 KB region of SRAM_U range from 0x2000_4000 to 0x2000_7FFF can be powered on, enabled by setting SMC_STOPCTRL[RAM2PO]. In other low power modes the contents of the SRAM are retained.

3.6.4 System Register File Configuration

This section summarizes how the module has been configured in the chip.

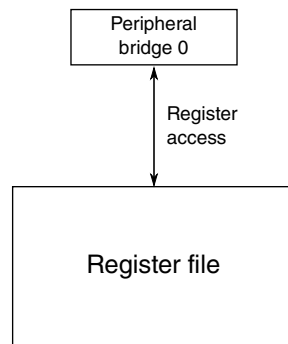

Figure 3-26. System Register file configuration

Table 3-32. Reference links to related information

| Topic | Related module | Reference |
|-------------------|----------------|------------------------------------|
| Full description | Register file | Register file |
| System memory map | | System memory map |
| Clocking | | Clock distribution |
| Power management | | Power management |

3.6.4.1 System Register file

This device includes a 32-byte register file that is powered in all power modes.

Also, it retains contents during low-voltage detect (LVD) events and is only reset during a power-on reset.

3.7 Security

3.7.1 TRNG configuration

This section summarizes how the module has been configured in the chip.

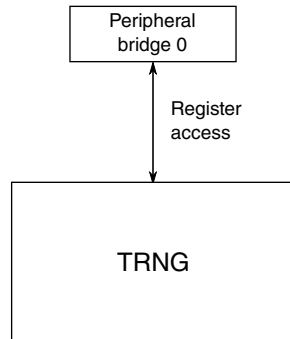

Figure 3-27. MCG configuration

Table 3-33. Reference links to related information

| Topic | Related module | Reference |
|---------------------|----------------|-------------------------------------|
| Full description | TRNG | TRNG |
| System memory map | — | System memory map |
| Clocking | — | Clock distribution |
| Power management | — | Power management |
| Signal multiplexing | Port control | Signal multiplexing |

3.7.2 LTC configuration

This section summarizes how the module has been configured in the chip.

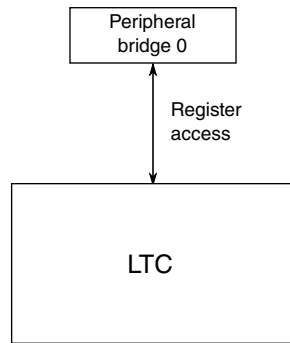

Figure 3-28. LTC configuration

Table 3-34. Reference links to related information

| Topic | Related module | Reference |
|---------------------|----------------|-------------------------------------|
| Full description | LTC | LTC |
| System memory map | — | System memory map |
| Clocking | — | Clock distribution |
| Power management | — | Power management |
| Signal multiplexing | Port control | Signal multiplexing |

3.8 Analog

3.8.1 Analog reference options

Several analog blocks have selectable reference voltages as shown in the table below. These options allow analog peripherals to share or have separate analog references. Care should be taken when selecting analog references to avoid cross talk noise.

NOTE

In the 48pin package VREFH and VDDA are separate package pins, while VREFL is connected to the VSSA package pin. VREF module output VREF_OUT share the same pin with VREFH. When VREF is enabled, the VREF output serve as the reference voltage. When VREF is disabled, external voltage reference is used and input via VREFH pin.

Table 3-35. Analog reference options

| Module | Reference option | Comment/ Reference selection |
|----------------|----------------------------------|-----------------------------------|
| 16-bit SAR ADC | 00 (V _{REF}) - VREFH/L | Selected by ADCx_SC2[REFSEL] bits |

Table continues on the next page...

Table 3-35. Analog reference options (continued)

| Module | Reference option | Comment/ Reference selection |
|--------------------|---|-----------------------------------|
| | 01 (V_{ALT}) - VDDA/VSSA | |
| 12-bit DAC | 0 (DACREF_1) - VREFH 1 (DACREF_2) - VDDA | Selected by DACx_C0[DACRFS] bit |
| CMP with 6-bit DAC | 0 (Vin1) - VREFH 1 (Vin2) - VDD | Selected by CMPx_DACCR[VRSEL] bit |

3.8.2 16-bit SAR ADC configuration

This section summarizes how the module has been configured in the chip.

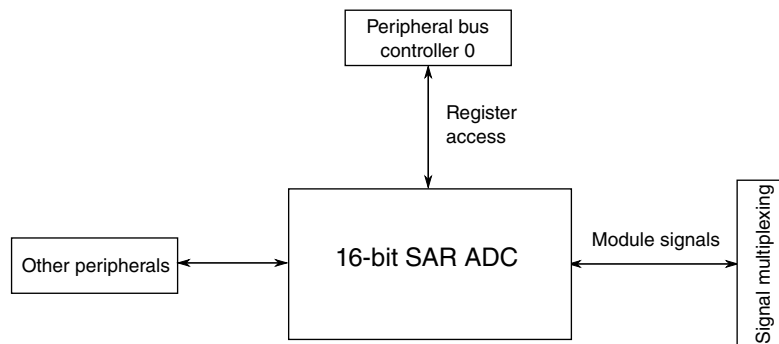
**Figure 3-29. 16-bit SAR ADC configuration****Table 3-36. Reference links to related information**

| Topic | Related module | Reference |
|---------------------|----------------|-------------------------------------|
| Full description | 16-bit SAR ADC | 16-bit SAR ADC |
| System memory map | — | System memory map |
| Clocking | — | Clock distribution |
| Power management | — | Power management |
| Signal multiplexing | Port control | Signal multiplexing |

3.8.2.1 ADC Instantiation Information

This device contains one 16-bit successive approximation ADC.

The ADC supports both software and hardware triggers. The hardware trigger sources are listed in the [Module-to-Module](#) section. The ADC will have two SC1n (Status and Control) registers, ADC0_SC1A and ADC0_SC1B, and the corresponding result registers.

The asynchronous hardware conversion trigger of ADC, ADHWT, can be initiated by various peripherals like TPM, PIT, CMP, RTC, or Radio. See SIM_SOPT7[ADC0TRGSEL] for more details.

3.8.2.2 DMA Support on ADC

Applications may require continuous sampling of the ADC that may have considerable load on the CPU. The ADC supports DMA request functionality for higher performance when the ADC is sampled at a very high rate. The ADC can trigger the DMA (via DMA req) on conversion completion.

3.8.2.3 ADC0 Connections/Channel Assignment

The ADC channel assignments are shown below. Note that not all channels are supported in all packages.

3.8.2.3.1 ADC0 Channel Assignment

| ADC Channel (SC1n[ADCH]) | Channel | Input signal (SC1n[DIFF]= 1) | Input signal (SC1n[DIFF]= 0) |
|--------------------------|---------|------------------------------|---------------------------------|
| 00000 | DAD0 | ADC0_DP0 and ADC0_DM0 | ADC0_DP0 |
| 00001 | DAD1 | Reserved | ADC0_SE1 |
| 00010 | DAD2 | Reserved | ADC0_SE2 |
| 00011 | DAD3 | Reserved | ADC0_SE3 |
| 00100 | AD4 | Reserved | ADC0_SE4 /12-bit DAC0 Output |
| 00101 | AD5 | Reserved | ADC0_SE5 |
| 00110 | AD6 | Reserved | Reserved |
| 00111 | AD7 | Reserved | Reserved |
| 01000 | AD8 | Reserved | Reserved |
| 01001 | AD9 | Reserved | Reserved |
| 01010 | AD10 | Reserved | Reserved |
| 01011 | AD11 | Reserved | Reserved |
| 01100 | AD12 | Reserved | Reserved |
| 01101 | AD13 | Reserved | Reserved |
| 01110 | AD14 | Reserved | Reserved |
| 01111 | AD15 | Reserved | Reserved |
| 10000 | AD16 | Reserved | Reserved |
| 10001 | AD17 | Reserved | Reserved |

Table continues on the next page...

| ADC Channel (SC1n[ADCH]) | Channel | Input signal (SC1n[DIFF]= 1) | Input signal (SC1n[DIFF]= 0) |
|-----------------------------|---------|---------------------------------|---------------------------------|
| 10010 | AD18 | Reserved | Reserved |
| 10011 | AD19 | Reserved | Reserved |
| 10100 | AD20 | Reserved | Reserved |
| 10101 | AD21 | Reserved | Reserved |
| 10110 | AD22 | Reserved | Reserved |
| 10111 | AD23 | Reserved | Battery voltage ¹ |
| 11000 | AD24 | Reserved | Reserved |
| 11001 | AD25 | Reserved | Reserved |
| 11010 | AD26 | Temperature Sensor (Diff) | Temperature Sensor (S.E) |
| 11011 | AD27 | Bandgap (Diff) | Bandgap (S.E) ² |
| 11100 | AD28 | Reserved | Reserved |
| 11101 | AD29 | -VREFH (Diff) | VREFH (S.E) |
| 11110 | AD30 | Reserved | VREFL |
| 11111 | AD31 | Module Disabled | Module Disabled |

1. Battery voltage option is the internal connection to the DCDC's scaled battery voltage output. It is not main battery voltage supply.
2. This is the PMC bandgap 1V reference voltage. Prior to reading from this ADC channel, ensure that you enable the bandgap buffer by setting the PMC_REGSC[BGBE] bit. Refer to the device data sheet for the bandgap voltage (V_{BG}) specification.

3.8.2.4 Alternate clock

For this device, the alternate clock is connected to the external reference clock (OSCERCLK).

3.8.3 CMP Configuration

This section summarizes how the module has been configured in the chip.

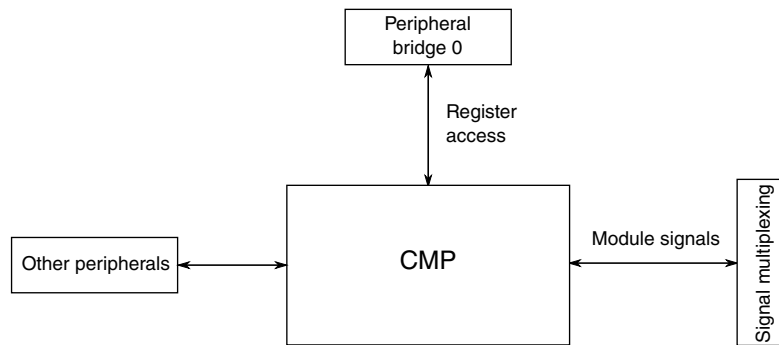

Figure 3-30. CMP configuration

Table 3-37. Reference links to related information

| Topic | Related module | Reference |
|---------------------|------------------|-------------------------------------|
| Full description | Comparator (CMP) | Comparator |
| System memory map | | System memory map |
| Clocking | | Clock distribution |
| Power management | | Power management |
| Signal multiplexing | Port control | Signal multiplexing |

3.8.3.1 CMP Instantiation Information

The device includes one high speed comparator with two 8-input multiplexors for both the inverting and non-inverting inputs of the comparator. Each CMP input channel connects to both muxes. See [CMP input connections](#) for a summary of CMP input connections for this device.

The CMP also includes one 6-bit DAC with a 64-tap resistor ladder network, which provides a selectable voltage reference for applications where voltage reference is needed for internal connection to the CMP.

The CMP can be optionally on in all modes except VLLS0.

The CMP has several module to module interconnects in order to facilitate ADC triggering, timer triggering and LPUART IR interfaces. For complete details on the CMP module interconnects, refer to the [Module to Module Interconnects](#) section.

The CMP does not support window compare function and `CMP_CR1[WE]` must always be written to 0. The sample function has limited functionality since the `SAMPLE` input to the block is not connected to a valid input. Usage of sample operation is limited to a divided version of the bus clock (`CMP_CR1[SE] = 0`).

Due to the pin number limitation, the CMP pass through mode is not supported by this device, so the `CMPx_MUXCR[PSTM]` must be left as 0.

3.8.3.2 CMP input connections

The following table shows the CMP input channel assignments.

Table 3-38. CMP input connections

| Input Channel | Assignment |
|---------------|-------------------------------------|
| IN0 | CMP0_IN0(pin) |
| IN1 | CMP0_IN1(pin) |
| IN2 | 12-bit DAC0 reference/CMP0_IN2(pin) |
| IN3 | CMP0_IN3(pin) |
| IN4 | CMP0_IN4(pin) |
| IN5 | CMP0_IN5(pin) |
| IN6 | Bandgap |
| IN7 | 6-bit DAC0 reference |

3.8.3.3 CMP external references

The 6-bit DAC sub-block supports selection of two references. For this device, the references are connected as follows:

- VREFH - V_{in1} input. When using VREFH, any ADC conversion using this same reference at the same time is negatively impacted.
- VDD - V_{in2} input

3.8.3.4 CMP trigger mode

The CMP and 6-bit DAC sub-block supports trigger mode operation when the CMP_CR1[TRIGM] is set. When trigger mode is enabled, the trigger event will initiate a compare sequence that must first enable the CMP and DAC prior to performing a CMP operation and capturing the output. In this device, the LPTMR provides control for this two-staged sequencing. The LPTMR triggering output is always enabled when the LPTMR is enabled. The first signal is supplied to enable the CMP and DAC and is asserted at the same time as the TCF flag is set. The delay to the second signal that triggers the CMP to capture the result of the compare operation is dependent on the LPTMR configuration. In Time Counter mode with prescaler enabled, the delay is 1/2 Prescaler output period. In Time Counter mode with prescaler bypassed, the delay is 1/2 Prescaler clock period.

The delay between the first signal from LPTMR and the second signal from LPTMR must be greater than the Analog comparator initialization delay as defined in the device datasheet.

3.8.4 12-bit DAC configuration

This section summarizes how the module has been configured in the chip.

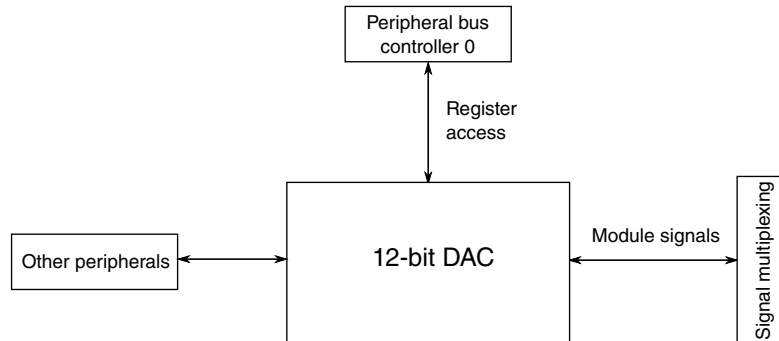

Figure 3-31. 12-bit DAC configuration

Table 3-39. Reference links to related information

| Topic | Related module | Reference |
|---------------------|----------------|-------------------------------------|
| Full description | 12-bit DAC | 12-bit DAC |
| System memory map | | System memory map |
| Clocking | | Clock distribution |
| Power management | | Power management |
| Signal multiplexing | Port control | Signal multiplexing |

3.8.4.1 12-bit DAC Instantiation Information

This device contains one 12-bit digital-to-analog converter (DAC) with programmable reference generator output. The DAC includes a two word FIFO for DMA support.

3.8.4.2 12-bit DAC Output

The output of the DAC can be placed on an external pin or selected as an input to the analog comparator or ADC.

3.8.4.3 12-bit DAC Analog Supply Connections

This device includes a dedicated VDDA and VSSA pin.

3.8.4.4 12-bit DAC Reference

For this device VREFH and VDDA are selectable as the DAC reference. VREFH is connected to the DACREF_1 input and VDDA is connected to the DACREF_2 input. Use DACx_C0[DA CRFS] control bit to select between these two options.

Be aware that if the DAC and ADC use the same reference simultaneously, some degradation of ADC accuracy is to be expected due to DAC switching.

See also [Analog References](#) .

3.8.5 Voltage Reference (VREF)

This section summarizes how the module has been configured in the chip.

Table 3-40. Reference links to related information

| Topic | Related module | Reference |
|---------------------|-------------------|--|
| Full description | Voltage Reference | Voltage Reference(VREF1) |
| System memory map | | System memory map |
| Clocking | | Clock distribution |
| Power management | | Power management |
| Signal multiplexing | Port control | Signal multiplexing |

3.8.5.1 VREF Overview

This device includes a voltage reference (VREF) to supply an accurate 1.2 V voltage output.

The voltage reference can provide a reference voltage to external peripherals or a reference to analog peripherals, such as the ADC, DAC, or CMP.

NOTE

PMC_REGSC[BGEN] bit must be set if the VREF regulator is required to remain operating in VLPx modes.

NOTE

For either an internal or external reference if the VREF_OUT functionality is being used, VREF_OUT signal must be connected to an output load capacitor. Refer the device data sheet for more details.

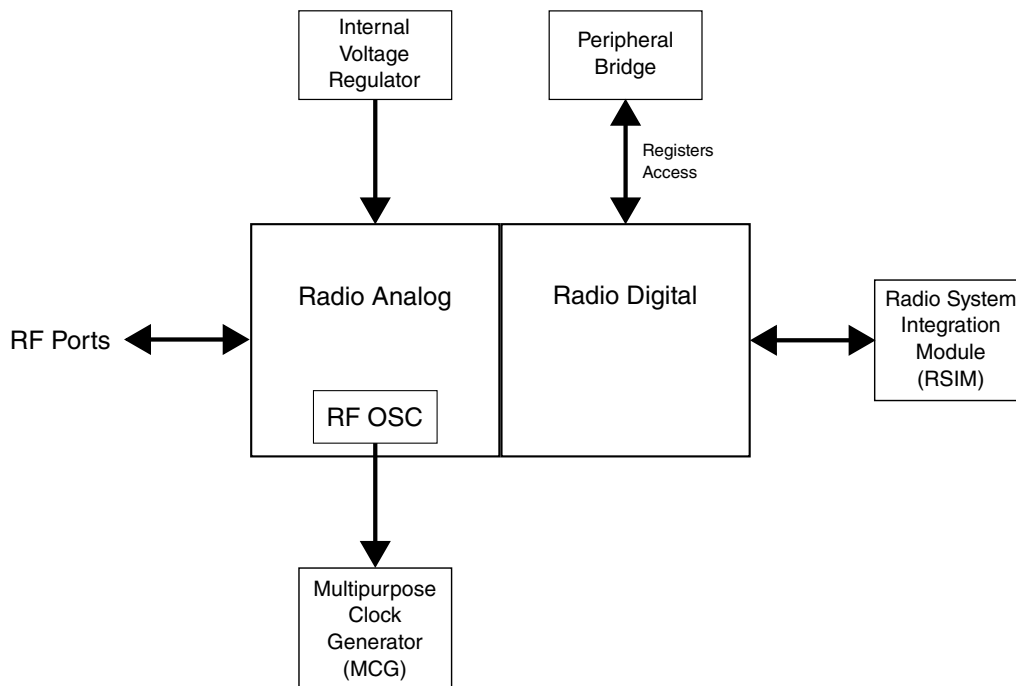
3.9 Radio**3.9.1 Radio module configuration****Figure 3-32. Radio configuration****Table 3-41. Reference links to related information**

| Topic | Related module | Reference |
|---------------------|----------------|-------------------------------------|
| Full description | Radio | 2.4 GHz Radio |
| System memory map | — | System memory map |
| Clocking | — | Clock distribution |
| Power management | — | Power management |
| Signal multiplexing | Port control | Signal multiplexing |

3.9.1.1 Radio Overview

The radio block consists of radio analog and radio digital sections. The radio analog is comprised of the RF transmitter, receiver and the supporting analog functions. The RF reference oscillator is also included in the radio analog. It is the reference oscillator for KW41Z, and can be configured using the [MCG](#) to be the master clock for both the radio and the MCU core. The Radio System Integration Module ([RSIM](#)) provides system control for the radio block. The MCU core configures the radio through radio registers within the radio digital section. Software uses the radio to communicate by interfacing with the RF protocol link layers.

3.10 Timers

3.10.1 Timer/TPM Configuration

This section describes the configuration of the TPM timers in this device.

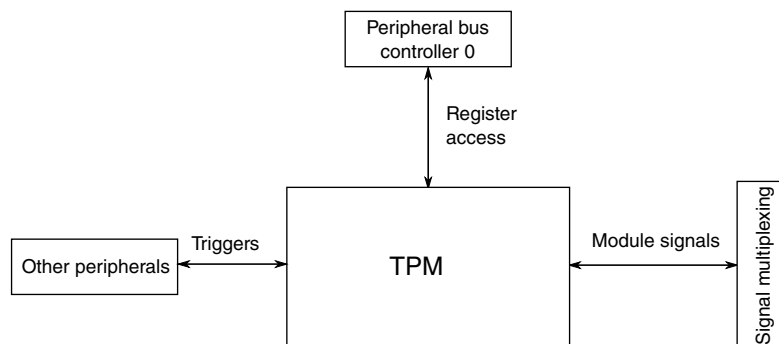

Figure 3-33. TPM configuration

Table 3-42. Reference links to related information

| Topic | Related module | Reference |
|---------------------|------------------|-------------------------------------|
| Full description | Timer/PWM Module | Timer/PWM Module |
| System memory map | | System memory map |
| Clocking | | Clock distribution |
| Power management | | Power management |
| Signal multiplexing | Port control | Signal multiplexing |

3.10.1.1 TPM Instantiation Information

This device contains three Low Power TPM modules (TPM). TPM0 is configured as shown in the table below. All TPMs can be functional in Stop/VLPS mode; the clock source is either external or internal in Stop/VLPS mode.

Table 3-43. TPM configuration

| Instance Name | Channels | Features |
|---------------|----------|---|
| TPM0 | 4 | <ul style="list-style-type: none"> • Basic TPM • No quadrature decoder(TPM0 QD registers have no efficiency) • Functional in Stop/VLPS mode |
| TPM1 | 2 | <ul style="list-style-type: none"> • Basic TPM • Quadrature Decoder and filtering to support the wireless mouse use case • Functional in Stop/VLPS |
| TPM2 | 2 | <ul style="list-style-type: none"> • Basic TPM • Quadrature Decoder and filtering to support the wireless mouse use case • Functional in Stop/VLPS |

3.10.1.2 Clock Options

The TPM block is clocked from a clock that can be selected from OSCERCLK, MCGIRCLK, or MCGFLLCLK. The selected source is controlled by SIM_SOPT2[TPMSRC]. This is discussed in [TPM Clocking](#).

Each TPM also supports an external clock mode (TPM_SC[CMOD]=1x) in which the counter increments after a synchronized (to the selected TPM clock source) rising edge detect of an external clock input. The available external clock (either TPM_CLKIN0 or TPM_CLKIN1) is selected by SIM_SOPT4[TPMxCLKSEL] control register. To guarantee valid operation the selected external clock must be less than half the frequency of the selected TPM clock source.

3.10.1.3 Trigger Options

Each TPM has a selectable trigger input source controlled by the TPMx_CONF[TRGSEL] field to use for starting the counter and/or reloading the counter. The options available are shown in the following table.

Table 3-44. TPM trigger options

| TPMx_CONF[TRGSEL] | Selected source |
|-------------------|---------------------------------------|
| 0000 | External trigger pin input (EXTRG_IN) |
| 0001 | CMP0 output |
| 0010 | Reserved |
| 0011 | Reserved |
| 0100 | PIT trigger 0 |
| 0101 | PIT trigger 1 |
| 0110 | Reserved |
| 0111 | Reserved |
| 1000 | TPM0 overflow |
| 1001 | TPM1 overflow |
| 1010 | TPM2 overflow |
| 1011 | Reserved |
| 1100 | RTC alarm |
| 1101 | RTC seconds |
| 1110 | LPTMR trigger |
| 1111 | Radio TSM |

These TPM trigger inputs are also described in [Module to Module Interconnects](#). Each TPM also outputs channel and overflow triggers. The connections of these are described in the Module to Module interconnects section as well.

3.10.1.4 Global timebase

Each TPM has a global timebase feature controlled by TPMx_CONF[GTBEEN]. TPM1 is configured as the global time when this option is enabled.

3.10.1.5 Interrupts

The TPM has multiple sources of interrupt. However, these sources are OR'd together to generate a single interrupt request per TPM module to the interrupt controller. When an interrupt occurs, read the TPM status registers (SC and STATUS) to determine the exact interrupt source.

3.10.2 PIT Configuration

This section summarizes how the module has been configured in the chip.

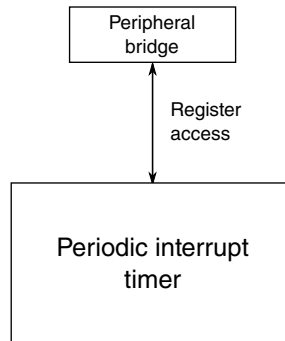

Figure 3-34. PIT configuration

Table 3-45. Reference links to related information

| Topic | Related module | Reference |
|-------------------|----------------|------------------------------------|
| Full description | PIT | PIT |
| System memory map | | System memory map |
| Clocking | | Clock Distribution |
| Power management | | Power management |

3.10.2.1 PIT/DMA Periodic Trigger Assignments

The PIT generates periodic trigger events to the DMA channel mux as shown in the table below.

Table 3-46. PIT channel assignments for periodic DMA triggering

| PIT Channel | DMA Channel Number |
|---------------|--------------------|
| PIT Channel 0 | DMA Channel 0 |
| PIT Channel 1 | DMA Channel 1 |

3.10.2.2 PIT/ADC Triggers

PIT triggers are selected as ADCx trigger sources using the SOPT7[ADCxTRGSEL] bits in the SIM module. For more details, refer to [SIM](#) chapter.

3.10.2.3 PIT/FTM Triggers

PIT triggers are selected as FTMx trigger sources using the FTMx_CONF[TRGSEL] bits in the FTM module. For more details, refer to [TPM](#) chapter.

3.10.2.4 PIT/DAC Triggers

PIT Channel 0 is configured as the DAC hardware trigger source. For more details, refer to [DAC](#) chapter.

3.10.3 Low-power timer configuration

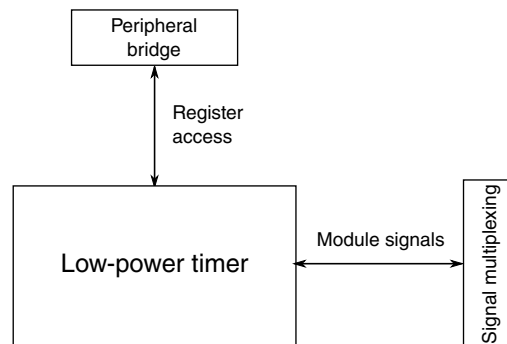

Figure 3-35. LPT configuration

Table 3-47. Reference links to related information

| Topic | Related module | Reference |
|---------------------|-----------------|-------------------------------------|
| Full description | Low-power timer | Low-power timer |
| System memory map | | System memory map |
| Clocking | | Clock Distribution |
| Power management | | Power management |
| Signal Multiplexing | Port control | Signal Multiplexing |

3.10.3.1 LPTMR Instantiation Information

The LPTMR allows operation during all power modes. The LPTMR can operate as a real-time interrupt or pulse accumulator. It includes a 2^N prescaler (real-time interrupt mode) or glitch filter (pulse accumulator mode).

The LPTMR can be clocked from the internal reference clock, the internal 1 kHz LPO, OSCERCLK, or an external 32.768 kHz crystal.

An interrupt is generated (and the counter may reset) when the counter equals the value in the 16-bit compare register.

3.10.3.2 LPTMR pulse counter input options

The LPTMR_CSR[TPS] bitfield configures the input source used in pulse counter mode. The following table shows the chip-specific input assignments for this bitfield.

| LPTMR_CSR[TPS] | Pulse counter input number | Chip input |
|----------------|----------------------------|----------------|
| 00 | 0 | CMPO output |
| 01 | 1 | LPTMR_ALT1 pin |
| 10 | 2 | LPTMR_ALT2 pin |
| 11 | 3 | Reserved |

3.10.3.3 LPTMR prescaler/glitch filter clocking options

The prescaler and glitch filter of the LPTMR module can be clocked from one of four sources determined by the LPTMR0_PSR[PCS] bitfield. The following table shows the chip-specific clock assignments for this bitfield.

NOTE

The chosen clock must remain enabled if the LPTMR is to continue operating in all required low-power modes.

| LPTMR0_PSR[PCS] | Prescaler/glitch filter clock number | Chip clock |
|-----------------|--------------------------------------|-------------------------------------|
| 00 | 0 | MCGIRCLK — internal reference clock |
| 01 | 1 | LPO — 1 kHz clock |
| 10 | 2 | ERCLK32K |
| 11 | 3 | OSCERCLK — external reference clock |

3.10.4 RTC configuration

This section summarizes how the module has been configured in the chip.

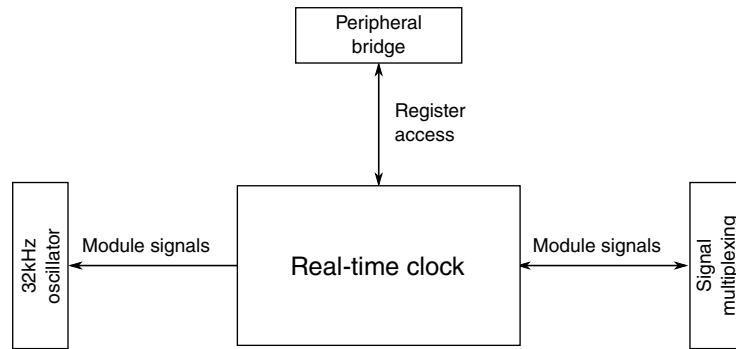

Figure 3-36. RTC configuration

Table 3-48. Reference links to related information

| Topic | Related module | Reference |
|-------------------|----------------|------------------------------------|
| Full description | RTC | RTC |
| System memory map | | System memory map |
| Clocking | | Clock Distribution |
| Power management | | Power management |

3.10.4.1 RTC Instantiation Information

RTC prescaler is clocked by ERCLK32K.

RTC is reset on POR Only.

RTC_CR[OSCE] is used to enable the 32kHz oscillator, and the RTC_CR register's SC2P, SC4P, SC8P and SC16P bit-fields are used to configure the 32kHz oscillator.

RTC_CR[WPE] and RTC_CR[WPS] are not used since the RTC wakeup pin output is not connected in this device.

Before using the 32kHz oscillator as the external reference source for the MCG, the RTC_CR[OSCE] bit should be set.

If an external square wave clock is being used to clock the RTC, the RTC_CLKIN path must be used.

3.10.4.2 RTC_CLKOUT options

RTC_CLKOUT pin is driven with the RTC 1Hz output.

3.11 Communication interfaces

3.11.1 SPI configuration

This section summarizes how the module has been configured in the chip.

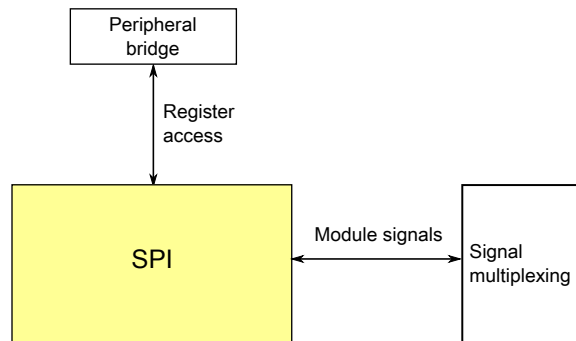

Figure 3-37. SPI configuration

Table 3-49. Reference links to related information

| Topic | Related module | Reference |
|---------------------|----------------|-------------------------------------|
| Full description | SPI | SPI |
| System memory map | | System memory map |
| Clocking | | Clock Distribution |
| Signal Multiplexing | Port control | Signal multiplexing |

3.11.1.1 SPI Instantiation Information

This device contains DSPI module which can be used as either SPI slave or SPI master, depending on the use case.

The configuration for the DSPI modules are shown in the table below.

Table 3-50. DSPI configuration

| Parameter | SPI0 | SPI1 |
|----------------|------|------|
| CTAR Registers | 2 | 2 |
| TX FIFO Depth | 4 | 4 |
| RX FIFO Depth | 4 | 4 |

The DSPI module must be in Run or Wait modes to operate as either a master or slave.

The reset value of TFFF bit in SPI_SR register will be 0 without any operation after reset. If MDIS bit in DSPI_MCR register is written with 1 after reset and the DSPI clock is enabled. TFFF bit will be 1.

3.11.2 I2C Configuration

This section summarizes how the module has been configured in the chip.

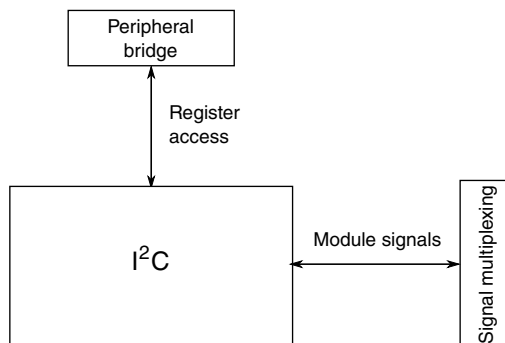

Figure 3-38. I2C configuration

Table 3-51. Reference links to related information

| Topic | Related module | Reference |
|---------------------|------------------|-------------------------------------|
| Full description | I ² C | I²C |
| System memory map | | System memory map |
| Clocking | | Clock Distribution |
| Power management | | Power management |
| Signal Multiplexing | Port control | Signal multiplexing |

3.11.2.1 I2C Instantiation Information

This device has two I2C modules. I2C0 is clocked by the bus clock and I2C1 is clocked by the system clock.

When the package pins associated with I2C have their mux select configured for I2C operation, the pins (SCL and SDA) are driven in a open drain configuration.

The digital glitch filter implemented in the I2C0 module, controlled by the I2C0_FLT[FLT] registers, is clocked from the bus clock and thus has filter granularity in bus clock cycle counts.

The digital glitch filter implemented in the I2C1 module, controlled by the I2C1_FLT[FLT] registers, is clocked from the system clock and thus has filter granularity in system clock cycle counts.

The pull up voltage on a pseudo open drain pin should not be higher than VDD.

3.11.3 LPUART Configuration

This section summarizes how the module has been configured in the chip.

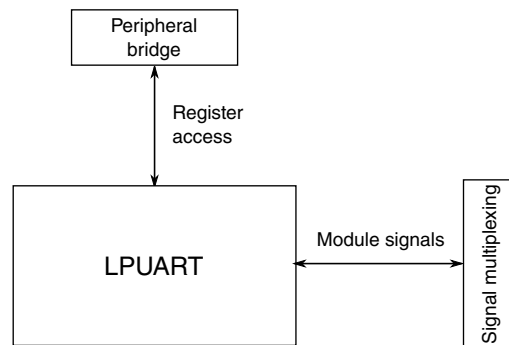

Figure 3-39. LPUART configuration

Table 3-52. Reference links to related information

| Topic | Related module | Reference |
|---------------------|----------------|-------------------------------------|
| Full description | LPUART | LPUART |
| System memory map | — | System memory map |
| Clocking | — | Clock distribution |
| Power management | — | Power management |
| Signal multiplexing | Port control | Signal multiplexing |

3.11.3.1 LPUART instantiation information

The LPUART0 module supports basic UART with DMA interface function, x4 to x32 oversampling of baud-rate, and hardware flow control.

The LPUART0 module RX and TX FIFOs are 8 entries each.

The module can remain functional in VLPS mode provided the clock it is using remains enabled.

3.12 Human-machine interfaces (HMI)

3.12.1 GPIO Configuration

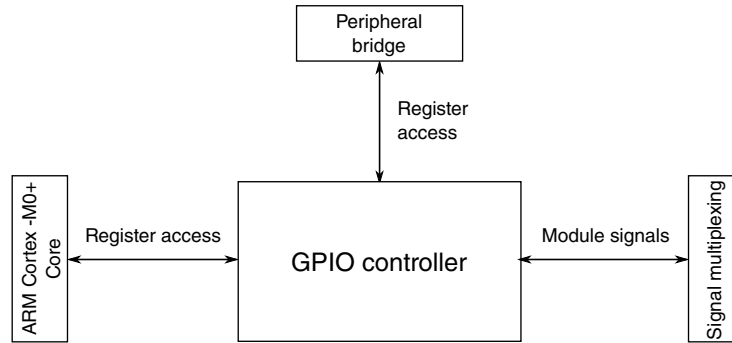

Figure 3-40. GPIO configuration

Table 3-53. Reference links to related information

| Topic | Related module | Reference |
|---------------------|-----------------|-------------------------------------|
| Full description | GPIO | GPIO |
| System memory map | | System memory map |
| Clocking | | Clock Distribution |
| Power management | | Power management |
| Crossbar switch | Crossbar switch | Crossbar switch |
| Signal Multiplexing | Port control | Signal multiplexing |

3.12.1.1 GPIO Instantiation Information

The device will include 10 pins with high current drive capability. These pins are PTC0, PTC1, PTC2, PTC3, PTC6, PTC7, PTC17, PTC18, PTB0 and PTB1. High drive can be controlled for these pin using the PORTx_PCRn[DSE] field.

3.12.1.1.1 Pull Devices and Directions

The pull devices are enabled out of POR only on RESET_B, NMI_b and respective SWD signals. Other PORT pins can be enabled by writing to PORTx_PCRn[PE] field.

All the PORT pins have controllable pull direction using the PORTx_PCRn[PS] field. All the pins default to pullup except for SWD_CLK, when enabled.

3.12.1.2 Port control and interrupt summary

The following table provides more information regarding the Port Control and Interrupt configurations .

Table 3-54. Ports summary

| Feature | Port A | Port B | Port C |
|--|---|--|---|
| Pull select control | Yes | Yes | Yes |
| Pull select at reset | PTA1=Pull down, Others=Pull up | Pull up | Pull up |
| Pull enable control | Yes | Yes | Yes |
| Pull enable at reset | PTA2 ¹ =Enabled; Others=Disabled | PTB18 (NMI_b)=Enabled; Others=Disabled | Disabled |
| Slew rate enable control | Yes | Yes | Yes |
| Slew rate enable at reset | PTA0/PTA16/PTA17/PTA18/PTA19=Disabled; Others=Enabled | PTB3/PTB0 = Disabled; Others=Enabled | PTC7/PTC16/PTC17/PTC18/PTC19=Disabled; Others=Enabled |
| Passive filter enable control | No | PTB18 (NMI_b) only | No |
| Passive filter enable at reset | Disabled | PTB18=Enabled; Others=Disabled | Disabled |
| Open drain enable control ² | No | No | No |
| Open drain enable at reset | Disabled | Disabled | Disabled |
| Drive strength enable control | No | PTB0/PTB1 only | PTC0/PTC1/PTC2/PTC3/PTC6/PTC7/PTC17/PTC18 only |
| Drive strength enable at reset | Disabled | Disabled | Disabled |
| Pin mux control | Yes | Yes | Yes |
| Pin mux at reset | PTA0/PTA1=ALT7;Others=ALT0 | PTB18=ALT7; Others=ALT0 | ALT0 |
| Lock bit | No | No | No |
| Interrupt and DMA request | Yes | Yes | Yes |
| Digital glitch filter | No | No | No |

1. PTA2 is by default the Reset_b pin. If your application needs to reassign this pin as another function, this must be done in the FOPT field when programming. It cannot be done in software if the FOPT field has not allowed for this. Please refer to the FOPT boot options for more information.
2. LPUART signals can be configured for open-drain using SIM_SOPT5 register. I2C signals are automatically enabled for open drain when selected.

3.12.1.3 GPIO accessibility in the memory map

The GPIO is multi-ported and can be accessed directly by the core with zero wait states at base address 0xF800_0000. It can also be accessed by the core and DMA masters through the cross bar/AIPS interface at 0x400F_F000 and at an aliased slot (15) at

address 0x4000_F000. All BME operations to the GPIO space can be accomplished referencing the aliased slot (15) at address 0x4000_F000. Only some of the BME operations can be accomplished referencing GPIO at address 0x400F_F000.

3.12.2 TSI Configuration

This section summarizes how the module has been configured in the chip.

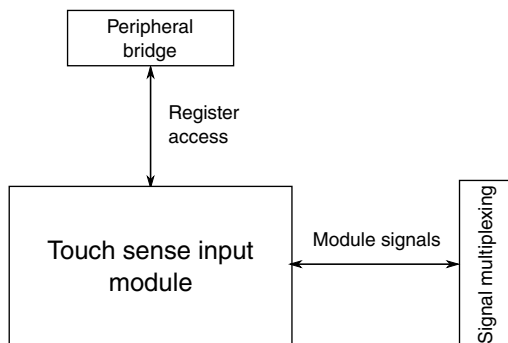

Figure 3-41. TSI configuration

Table 3-55. Reference links to related information

| Topic | Related module | Reference |
|---------------------|----------------|-------------------------------------|
| Full description | TSI | TSI |
| System memory map | | System memory map |
| Clocking | | Clock Distribution |
| Power management | | Power management |
| Signal Multiplexing | Port control | Signal multiplexing |

3.12.2.1 TSI Instantiation Information

This device includes one 16channel TSI module. All 16 channels are supported in the 48LGA package. In Stop, VLPS, LLSx and VLLSx modes any one channel can be enabled to be the wakeup source.

TSI hardware trigger is from the LPTMR. For complete details on the LPTMR module interconnects refer to the [Module-to-Module section](#).

3.12.2.2 TSI Interrupts

The TSI has multiple sources of interrupt requests. However, these sources are OR'd together to generate a single interrupt request. When a TSI interrupt occurs, read the TSI status register to determine the exact interrupt source.

Chapter 4

Memory Map

This section describes the memory and peripheral locations within the memory space of this device.

4.1 Introduction

This device contains various memories and memory-mapped peripherals which are located in a 4G bytes memory space. This chapter describes the memory and peripheral locations within that memory space.

4.2 System memory map

The following table shows the high-level device memory map.

Table 4-1. System memory map

| System 32-bit Address Range | Destination Slave | Access |
|--------------------------------------|---|-----------------------|
| 0x0000_0000–0x07FF_FFFF ¹ | Program flash and read-only data (Includes exception vectors in first 196 bytes) | All masters |
| 0x0800_0000–0x1FFF_EFFF | Reserved | — |
| 0x1FFF_8000–0x1FFF_FFFF | SRAM_L: Lower SRAM | All masters |
| 0x2000_0000–0x2001_7FFF | SRAM_U: Upper SRAM ² | All masters |
| 0x2001_8000–0x3FFF_FFFF | Reserved | – |
| 0x4000_0000–0x4007_FFFF | AIPS Peripherals | Cortex-M0+ core & DMA |
| 0x4008_0000–0x400F_EFFF | Reserved | – |
| 0x400F_F000–0x400F_FFFF | General purpose input/output (GPIO) | Cortex-M0+ core & DMA |
| 0x4010_0000–0x43FF_FFFF | Reserved | – |
| 0x4400_0000–0x5FFF_FFFF | Bit Manipulation Engine (BME) access to AIPS Peripherals for slots 0-127 ³ | Cortex-M0+ core |

Table continues on the next page...

Table 4-1. System memory map (continued)

| System 32-bit Address Range | Destination Slave | Access |
|-----------------------------|--|-----------------|
| 0x6000_0000–0xDFFF_FFFF | Reserved | – |
| 0xE000_0000–0xE00F_FFFF | Private Peripherals | Cortex-M0+ core |
| 0xE010_0000–0xEFFF_FFFF | Reserved | – |
| 0xF000_0000–0xF000_0FFF | Micro Trace Buffer (MTB) registers | Cortex-M0+ core |
| 0xF000_1000–0xF000_1FFF | MTB Data Watchpoint and Trace (MTBDWT) registers | Cortex-M0+ core |
| 0xF000_2000–0xF000_2FFF | ROM table | Cortex-M0+ core |
| 0xF000_3000–0xF000_3FFF | Miscellaneous Control Module (MCM) | Cortex-M0+ core |
| 0xF000_4000–0xF7FF_FFFF | Reserved | – |
| 0xF800_0000–0xFFFF_FFFF | IOPORT: GPIO (single cycle) | Cortex-M0+ core |

1. The program flash always begins at 0x0000_0000 but the end of implemented flash varies depending on the amount of flash implemented for a particular device.
2. See [SRAM Ranges](#) for more information on the split of the SRAM into Lower and Upper regions
3. Includes BME operations to GPIO at slot 15 (based at 0x4000_F000)

4.3 Alternate Non-Volatile IRC User Trim Description

The following non-volatile locations (4 bytes) are reserved for custom IRC user trim supported by some development tools. An alternate IRC trim to the factory loaded trim can be stored at this location. To override the factory trim, user software must load new values into the MCG trim registers.

| Non-Volatile Byte Address | Alternate IRC Trim Value |
|---------------------------|--------------------------|
| 0x0000_03FC | Reserved |
| 0x0000_03FD | Reserved |
| 0x0000_03FE (bit 0) | MCG_C4[SCFTRIM] |
| 0x0000_03FE (bit 4:1) | MCG_C4[FCTRIM] |
| 0x0000_03FE (bit 6) | MCG_C2[FCFTRIM] |
| 0x0000_03FF | MCG_C3[SCTTRIM] |

4.4 SRAM memory map

The on-chip RAM is split between SRAM_L and SRAM_U. The RAM is also implemented such that the SRAM_L and SRAM_U ranges form a contiguous block in the memory map. See [SRAM Ranges](#) for details.

Accesses to the SRAM_L and SRAM_U memory ranges outside the amount of RAM on the device causes the bus cycle to be terminated with an error followed by the appropriate response in the requesting bus master.

4.5 Bit Manipulation Engine

The Bit Manipulation Engine (BME) provides hardware support for atomic read-modify-write memory operations to the peripheral address space. By combining the basic load and store instruction support in the Cortex-M instruction set architecture with the concept of decorated storage provided by the BME, the resulting implementation provides a robust and efficient read-modify-write capability to this class of ultra low-end microcontrollers. See the [Bit Manipulation Engine \(BME\)](#) for a detailed description of BME functionality.

4.6 Peripheral bridge (AIPS-Lite) memory map

The peripheral memory map is accessible via one slave port on the crossbar in the 0x4000_0000–0x400F_FFFF region. The device implements one peripheral bridge that defines a 1024 KB address space.

The three regions associated with this space are:

- A 128 KB region, partitioned as 32 spaces, each 4 KB in size and reserved for on-platform peripheral devices. The AIPS controller generates unique module enables for all 32 spaces.
- A 384 KB region, partitioned as 96 spaces, each 4 KB in size and reserved for off-platform modules. The AIPS controller generates unique module enables for all 96 spaces.
- The last slot is a 4 KB region beginning at 0x400F_F000 for accessing the GPIO module. The GPIO slot (slot 128) is an alias of slot 15. This block is also directly interfaced to the core and provides direct access without incurring wait states associated with accesses via the AIPS controller.

Modules that are disabled via their clock gate control bits in the SIM registers disable the associated AIPS slots. Access to any address within an unimplemented or disabled peripheral bridge slot results in a transfer error termination.

For programming model accesses via the peripheral bridges, there is generally only a small range within the 4 KB slots that is implemented. Accessing an address that is not implemented in the peripheral results in a transfer error termination.

4.6.1 Read-after-write sequence and required serialization of memory operations

In some situations, a write to a peripheral must be completed fully before a subsequent action can occur. Examples of such situations include:

- Exiting an interrupt service routine (ISR)
- Changing a mode
- Configuring a function

In these situations, the application software must perform a read-after-write sequence to guarantee the required serialization of the memory operations:

1. Write the peripheral register.
2. Read the written peripheral register to verify the write.
3. Continue with subsequent operations.

4.6.2 Peripheral Bridge (AIPS-Lite) Memory Map

Table 4-2. Peripheral bridge 0 slot assignments

| System 32-bit base address | Slot number | Module |
|----------------------------|-------------|--|
| 0x4000_0000 | 0 | — |
| 0x4000_1000 | 1 | — |
| 0x4000_2000 | 2 | — |
| 0x4000_3000 | 3 | — |
| 0x4000_4000 | 4 | — |
| 0x4000_5000 | 5 | — |
| 0x4000_6000 | 6 | — |
| 0x4000_7000 | 7 | — |
| 0x4000_8000 | 8 | DMA controller |
| 0x4000_9000 | 9 | — |
| 0x4000_A000 | 10 | — |
| 0x4000_B000 | 11 | — |
| 0x4000_C000 | 12 | — |
| 0x4000_D000 | 13 | — |
| 0x4000_E000 | 14 | — |
| 0x4000_F000 | 15 | GPIO controller (aliased to 0x400F_F000) |
| 0x4001_0000 | 16 | — |
| 0x4001_1000 | 17 | — |
| 0x4001_2000 | 18 | — |

Table continues on the next page...

Table 4-2. Peripheral bridge 0 slot assignments (continued)

| System 32-bit base address | Slot number | Module |
|----------------------------|-------------|--------------------------|
| 0x4001_3000 | 19 | — |
| 0x4001_4000 | 20 | — |
| 0x4001_5000 | 21 | — |
| 0x4001_6000 | 22 | — |
| 0x4001_7000 | 23 | — |
| 0x4001_8000 | 24 | — |
| 0x4001_9000 | 25 | — |
| 0x4001_A000 | 26 | — |
| 0x4001_B000 | 27 | — |
| 0x4001_C000 | 28 | — |
| 0x4001_D000 | 29 | — |
| 0x4001_E000 | 30 | — |
| 0x4001_F000 | 31 | — |
| 0x4002_0000 | 32 | Flash memory |
| 0x4002_1000 | 33 | DMA channel mutiplexer 0 |
| 0x4002_2000 | 34 | — |
| 0x4002_3000 | 35 | — |
| 0x4002_4000 | 36 | — |
| 0x4002_5000 | 37 | — |
| 0x4002_6000 | 38 | — |
| 0x4002_7000 | 39 | — |
| 0x4002_8000 | 40 | — |
| 0x4002_9000 | 41 | TRNG |
| 0x4002_A000 | 42 | — |
| 0x4002_B000 | 43 | — |
| 0x4002_C000 | 44 | SPI0 |
| 0x4002_D000 | 45 | SPI1 |
| 0x4002_E000 | 46 | — |
| 0x4002_F000 | 47 | — |
| 0x4003_0000 | 48 | — |
| 0x4003_1000 | 49 | — |
| 0x4003_2000 | 50 | — |
| 0x4003_3000 | 51 | — |
| 0x4003_4000 | 52 | — |
| 0x4003_5000 | 53 | — |
| 0x4003_6000 | 54 | — |
| 0x4003_7000 | 55 | PIT |
| 0x4003_8000 | 56 | TPM0 (Timer/PWM) |
| 0x4003_9000 | 57 | TPM1 |

Table continues on the next page...

Table 4-2. Peripheral bridge 0 slot assignments (continued)

| System 32-bit base address | Slot number | Module |
|----------------------------|-------------|-----------------------------|
| 0x4003_A000 | 58 | TPM2 |
| 0x4003_B000 | 59 | ADC0 |
| 0x4003_C000 | 60 | — |
| 0x4003_D000 | 61 | RTC |
| 0x4003_E000 | 62 | — |
| 0x4003_F000 | 63 | DAC0 |
| 0x4004_0000 | 64 | LPTMR |
| 0x4004_1000 | 65 | System register file |
| 0x4004_2000 | 66 | — |
| 0x4004_3000 | 67 | — |
| 0x4004_4000 | 68 | — |
| 0x4004_5000 | 69 | TSI |
| 0x4004_6000 | 70 | — |
| 0x4004_7000 | 71 | SIM low-power logic |
| 0x4004_8000 | 72 | SIM |
| 0x4004_9000 | 73 | Port A multiplexing control |
| 0x4004_A000 | 74 | Port B multiplexing control |
| 0x4004_B000 | 75 | Port C multiplexing control |
| 0x4004_C000 | 76 | |
| 0x4004_D000 | 77 | |
| 0x4004_E000 | 78 | — |
| 0x4004_F000 | 79 | — |
| 0x4005_0000 | 80 | — |
| 0x4005_1000 | 81 | — |
| 0x4005_2000 | 82 | — |
| 0x4005_3000 | 83 | — |
| 0x4005_4000 | 84 | LPUART |
| 0x4005_5000 | 85 | — |
| 0x4005_6000 | 86 | — |
| 0x4005_7000 | 87 | — |
| 0x4005_8000 | 88 | LTC |
| 0x4005_9000 | 89 | RSIM |
| 0x4005_A000 | 90 | DCDC |
| 0x4005_B000 | 91 | BLE Link Layer (BTLL) |
| 0x4005_C000 | 92 | XCVR |
| 0x4005_D000 | 93 | 802.15.4 Link Layer |
| 0x4005_E000 | 94 | — |
| 0x4005_F000 | 95 | Generic FSK Link Layer |
| 0x4006_0000 | 96 | — |

Table continues on the next page...

Table 4-2. Peripheral bridge 0 slot assignments (continued)

| System 32-bit base address | Slot number | Module |
|----------------------------|-------------|-------------------------|
| 0x4006_1000 | 97 | — |
| 0x4006_2000 | 98 | CMT |
| 0x4006_3000 | 99 | — |
| 0x4006_4000 | 100 | MCG |
| 0x4006_5000 | 101 | System Oscillator (OSC) |
| 0x4006_6000 | 102 | I ² C 0 |
| 0x4006_7000 | 103 | I ² C 1 |
| 0x4006_8000 | 104 | — |
| 0x4006_9000 | 105 | — |
| 0x4006_A000 | 106 | — |
| 0x4006_B000 | 107 | — |
| 0x4006_C000 | 108 | — |
| 0x4006_D000 | 109 | — |
| 0x4006_E000 | 110 | — |
| 0x4006_F000 | 111 | — |
| 0x4007_0000 | 112 | — |
| 0x4007_1000 | 113 | — |
| 0x4007_2000 | 114 | — |
| 0x4007_3000 | 115 | CMP0 |
| 0x4007_4000 | 116 | VREF |
| 0x4007_5000 | 117 | — |
| 0x4007_6000 | 118 | — |
| 0x4007_7000 | 119 | — |
| 0x4007_8000 | 120 | — |
| 0x4007_9000 | 121 | — |
| 0x4007_A000 | 122 | — |
| 0x4007_B000 | 123 | — |
| 0x4007_C000 | 124 | LLWU |
| 0x4007_D000 | 125 | PMC |
| 0x4007_E000 | 126 | SMC |
| 0x4007_F000 | 127 | RCM |
| 0x400F_F000 | 128 | GPIO controller |

4.6.3 Modules Restricted Access in User Mode

In user mode, for RCM, SIM (slot 71 and 72), SMC, LLWU, and PMC, reads are allowed, but writes are blocked and generate bus errors.

In user mode, for MCG, writes are blocked.

By default, the SRTC blocks write access in user mode, but this restriction can be removed by programming the RTC_CR register's SUP bitfield.

4.7 Private Peripheral Bus (PPB) memory map

The PPB is part of the defined ARM bus architecture and provides access to select processor-local modules. These resources are only accessible from the core; other system masters do not have access to them.

Table 4-3. PPB memory map

| System 32-bit Address Range | Resource | Additional Range Detail | Resource |
|-----------------------------|----------------------------|-------------------------|----------------------|
| 0xE000_0000–0xE000_DFFF | Reserved | | |
| 0xE000_E000–0xE000_EFFF | System Control Space (SCS) | 0xE000_E000–0xE000_E00F | Reserved |
| | | 0xE000_E010–0xE000_E0FF | SysTick |
| | | 0xE000_E100–0xE000_ECFF | NVIC |
| | | 0xE000_ED00–0xE000_ED8F | System Control Block |
| | | 0xE000_ED90–0xE000_EDEF | Reserved |
| | | 0xE000_EDF0–0xE000_EEFF | Debug |
| | | 0xE000_EF00–0xE000_EFFF | Reserved |
| 0xE000_F000–0xE00F_EFFF | Reserved | | |
| 0xE00F_F000–0xE00F_FFFF | Core ROM Space (CRS) | | |

Chapter 5

Clock Distribution

5.1 Introduction

This chapter presents the clock architecture for the device, the overview of the clocks and includes a terminology section.

The Cortex M0+ resides within a synchronous core platform, where the processor and bus masters, Flash and peripheral clocks can be configured independently. The clock distribution figure shows how clocks from the MCG, Reference Oscillator and 32kHz Oscillator modules are distributed to the microcontroller's other function units. Some modules in the microcontroller have selectable clock input.

5.2 Programming model

The selection and multiplexing of system clock sources is controlled and programmed via the MCG module. The setting of clock dividers and module clock gating for the system are programmed via the SIM module. Reference those sections for detailed register and bit descriptions.

5.3 High-Level device clocking diagram

The device includes the following clock sources:

- RF Reference oscillator. This supports a 26 MHz or 32 MHz crystal. The clock is used by the radio analog and digital. It can be used also by the MCU core and as a clock source for some peripherals
- 32 kHz RTC oscillator. This is used as the clock for the RTC and the deepsleep clock for the Radio Link Layers.

Clock definitions

- 32 kHz IRC. This is used as the reference for the FLL at reset, and is a clock option for some peripherals
- 4 MHz IRC. This is a clock option for the MCU primarily intended to support VLPx mode, and is also a clock option for some peripherals.

See [Reference Oscillator Instantiation Information](#) for more information on control of the reference oscillator.

The 32 kHz oscillator will be controlled through the RTC

The following [MCG](#), and [SIM](#) module registers control the multiplexers, dividers, and clock gates shown in the below figure:

| | MCG | SIM |
|--------------|--------|----------------------|
| Multiplexers | MCG_Cx | SIM_SOPT1, SIM_SOPT2 |
| Dividers | MCG_Cx | SIM_CLKDIVx |
| Clock gates | MCG_C1 | SIM_SCGCx |

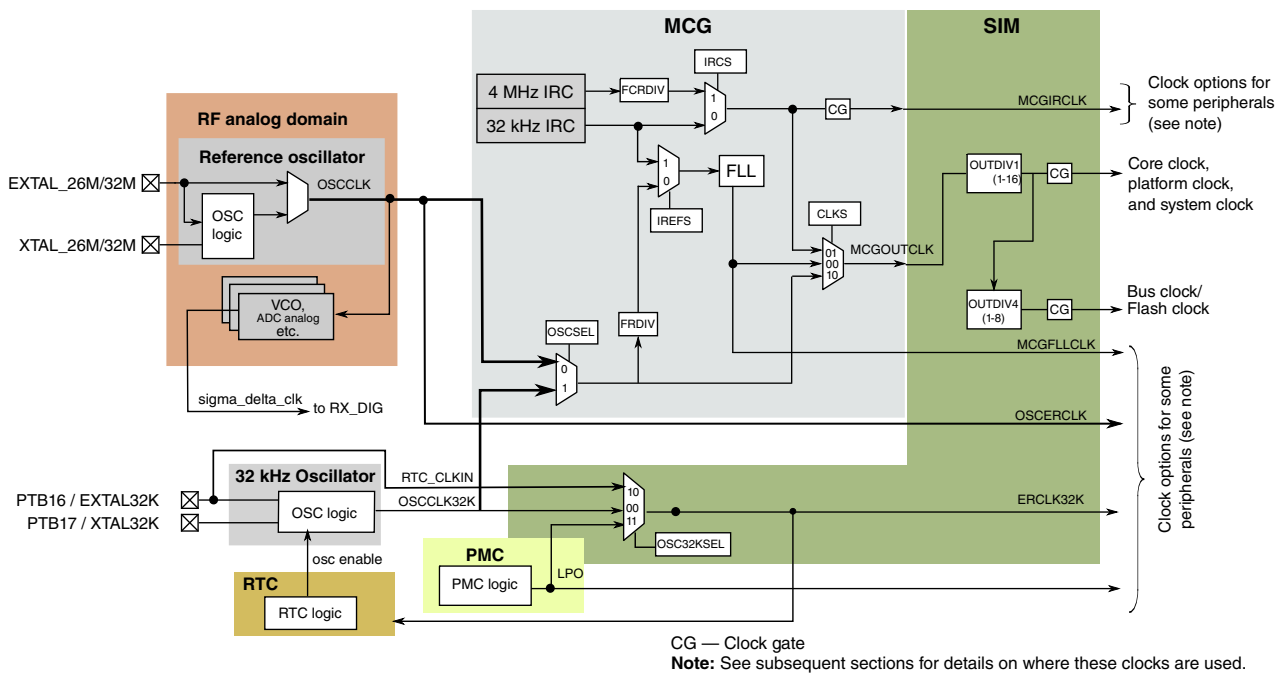

Figure 5-1. Clocking diagram

NOTE

The OSCSEL bit is configured only before enabling the OSCCLK and the OSCCLK32K.

5.4 Clock definitions

The following table describes the clocks in the previous block diagram.

| Clock name | Description |
|----------------|--|
| Core clock | MCGOUTCLK divided by OUTDIV1, clocks the ARM Cortex-M0+ core |
| Platform clock | MCGOUTCLK divided by OUTDIV1, clocks the crossbar switch and NVIC |
| System clock | MCGOUTCLK divided by OUTDIV1, clocks the bus masters directly |
| Bus clock | System clock divided by OUTDIV4, clocks the bus slaves and peripherals. |
| Flash clock | Flash memory clock. On this device it is the same as Bus clock. |
| MCGIRCLK | MCG output of the internal reference clock |
| MCGOUTCLK | MCG output of either IRC, MCGFLLCLK or MCG's external reference clock that sources the core, system, bus, and flash clock. |
| MCGFLLCLK | MCG output of the FLL. MCGFLLCLK may clock some modules. |
| OSCCLK | Output of the internal Reference oscillator or sourced directly from EXTAL. Used as MCG external reference clock. |
| OSCERCLK | Reference oscillator output sourced from OSCCLK that clocks some on-chip modules |
| OSC32KCLK | Output of the internal 32 kHz oscillator. A 32.768 kHz crystal or clock is used to support RTC features. If RTC is not needed, a 32.768 kHz crystal or clock is needed to support radio deepsleep mode (DSM) |
| ERCLK32K | Clock source for some modules. Can be selected as either OSC32KCLK (default), RTC_CLKIN or LPO. This clock is used to provide the 32kHz clock to the Radio; when using Radio, LPO should not be selected. |
| LPO | PMC 1kHz output |

5.4.1 Device clock summary

The following table provides more information regarding the on-chip clocks.

Table 5-1. Clock Summary

| Clock name | Run mode clock frequency | VLPR mode clock frequency | Clock source | Clock is disabled when... |
|------------|--------------------------|---------------------------|--------------|---|
| MCGOUTCLK | Up to 48 MHz | Up to 4 MHz | MCG | In all stop modes except for partial stop modes |

Table continues on the next page...

Table 5-1. Clock Summary (continued)

| Clock name | Run mode clock frequency | VLPR mode clock frequency | Clock source | Clock is disabled when... |
|-------------------------------------|--------------------------|--|------------------------------------|--|
| MCGFLLCLK | Up to 48 MHz | N/A | MCG | MCG clock controls are not enabled (in all stop modes) |
| Core clock | Up to 48 MHz | Up to 4 MHz | MCGOUTCLK clock divider | In all wait and stop modes |
| Platform clock | Up to 48 MHz | Up to 4 MHz | MCGOUTCLK clock divider | In all stop modes |
| System clock | Up to 48 MHz | Up to 4 MHz | MCGOUTCLK clock divider | In all stop modes Compute Operation |
| Bus clock | Up to 24 MHz | Up to 1 MHz in BLPE ¹ Up to 800 kHz in BLPI ² | MCGOUTCLK clock divider | In all stop modes except for partial STOP2 mode, and Compute Operation |
| SWD Clock | Up to 24 MHz | Up to 1 MHz | SWD_CLK pin | In all stop modes |
| Flash clock | Up to 24 MHz | Up to 1 MHz in BLPE Up to 800 kHz in BLPI | MCGOUTCLK clock divider | In all stop modes except for partial STOP2 mode |
| Internal reference (MCGIRCLK) | 30-40 kHz | 4 MHz Fast IRC only | MCG | MCG_C1[IRCLKEN] cleared, Stop/VLPS mode and MCG_C1[IREFSTEN] cleared, or LLS/VLLS mode |
| Reference oscillator (OSCERCLK) | 26 MHz or 32 MHz | DCDC configured for continuous mode: 32 MHz Otherwise: N/A | Reference Oscillator | See Reference Oscillator Enable Sources |
| 32K External reference (OSC32KCLK) | 32 KHz | 32 kHz | 32KHz Oscillator | RTC_CR[OSCE] cleared |
| External reference 32kHz (ERCLK32K) | 30-40 kHz | 30-40 kHz | 32kHz Oscillator, RTC_CLKIN or LPO | Selected clock source disabled |
| LPO | 1 kHz | 1 kHz | PMC | Available in all power modes except VLLS0 |
| LPUART clock | Up to 48 MHz | Up to 4 MHz | MCGIRCLK, MCGFLLCLK, or OSCERCLK | SIM_SOPT2[LPUART0SRC]=00 or selected clock source disabled. |

1. BLPE: MCG mode where MCGOUT is derived from an external oscillator. For KW41Z, use of BLPE in VLPR mode is only feasible when the DCDC is configured for continuous mode
2. BLPI: MCG mode where MCGOUT is derived from the internal reference.

5.5 Internal clocking requirements

The clock dividers are programmed via the SIM module's CLKDIV registers. The following requirements must be met when configuring the clocks for this device:

1. The core, platform, and system clock are programmable from a divide-by-1 through divide-by-16 setting. The core, platform, and system clock frequencies must be 48 MHz or slower.
2. The bus clock and flash clock frequency is divided from the system clock and is programmable from a divide-by-1 through divide-by-8 setting. The bus clock and flash clock must be programmed to 24 MHz or slower.

5.5.1 Clock divider values after reset

Out of reset, the MCG selects the FLL, using the 32KHz internal reference, as the MCGOUTCLK output. This clock is approximately 20MHz.

Two bits in the flash memory's FTFA_FOPT register control the reset value of the core clock, system clock, bus clock, and flash clock dividers (in the SIM's CLKDIV1 register) as shown below:

| FTFA_FOPT [4,0] | Core/system clock | Bus/Flash clock | Description |
|-----------------|----------------------------|-----------------------------|-----------------|
| 00 | 0x7 (divide by 8), ~2.5MHz | 0x1 (divide by 2), ~1.25MHz | Slow clock boot |
| 01 | 0x3 (divide by 4), ~5MHz | 0x1 (divide by 2), ~2.5MHz | Slow clock boot |
| 10 | 0x1 (divide by 2), ~10MHz | 0x1 (divide by 2), ~5MHz | Slow clock boot |
| 11 | 0x0 (divide by 1), ~20MHz | 0x1 (divide by 2), ~10MHz | Fast clock boot |

This gives the user flexibility in selecting between a lower frequency, low-power boot option vs. higher frequency, higher power during and after reset.

The flash erased state defaults to fast clocking mode, since these bits reside in flash, which is logic 1 in the flash erased state. To enable a lower power boot option, program the appropriate bits in FTFA_FOPT. During the reset sequence, if either of the control bits is cleared, the system is in a slower clock configuration. Upon any system reset, the clock dividers return to this configurable reset state.

5.5.2 VLPR mode clocking

For KW4x device, the VLPx modes are provided primarily as an option for the MCU subsystem to consume less power when the radio is not being used. It is possible to use VLPx modes when the radio is active, but only if the DCDC is configured for continuous mode, in which case biasing will not be enabled. The radio requires use of the 32MHz oscillator and its clock cannot be used in VLPx modes unless the DCDC is configured for continuous mode. The MCG BLPI mode therefore needs to be used in most VLPx use cases.

Some additional restrictions on VLPR mode are provided below.

The clock dividers cannot be changed while in VLPR mode. They must be programmed prior to entering VLPR mode to guarantee operation. Max frequency limitations for VLPR mode are as follows :

- the core/system clocks are less than or equal to 4 MHz, and
- the bus and flash clocks are
 - less than or equal to 800 kHz if using BLPI
 - less than or equal to 1 MHz if using BLPE. As this requires the use of the 32MHz oscillator, this is only possible when the DCDC is configured for continuous mode

5.6 Reference Oscillator Enable Sources

The Reference oscillator is always used by the radio, but can also be used by the MCU. As such, the Reference Oscillator will need to be enabled whenever either subsystem needs the clock. The enable sources for the system oscillator are described as follows.

The radio link layers enable the reference oscillator when they are not in deepsleep mode (DSM).

The oscillator can be enabled manually for Run/Wait modes, and also optionally for Stop mode, by setting the appropriate bits in the [Radio System Integration Module\(RSIM\)](#)

The MCG also outputs a signal which enables the reference oscillator whenever the OSCERCLK is selected for MCGOUTCLK or used as reference for the FLL

Note that use of the reference oscillator in VLPx modes is only possible when the DCDC is configured in continuous mode.

The oscillator can also be enabled by the XTAL_OUT_EN pins.

5.7 Clock Gating

The clock to each module can be individually gated on and off using the SIM module's SCGCx registers. Most of these bits are cleared after any reset, which disables the clock to the corresponding module to conserve power. Prior to initializing a module, set the corresponding bit in SCGCx register to enable the clock. Before turning off the clock, make sure to disable the module.

Any bus access to a peripheral that has its clock disabled generates an error termination.

Refer to [SIM](#) chapter for more information.

5.8 Module clocks

The following table summarizes the clocks associated with each module.

Table 5-2. Module clocks

| Module | Bus interface clock | Internal clocks | I/O interface clocks |
|-------------------------------------|---------------------|--|----------------------|
| Core modules | | | |
| ARM Cortex-M0+ core | Platform clock | Core clock | — |
| NVIC | Platform clock | — | — |
| DAP | Platform clock | — | SWD_CLK |
| System modules | | | |
| DMA | System clock | — | — |
| DMA Mux | Bus clock | — | — |
| Port control | Bus clock | — | — |
| Crossbar Switch | Platform clock | — | — |
| Peripheral bridges | System clock | Bus clock | — |
| LLWU, PMC, SIM, RCM | Bus clock | LPO | — |
| Mode controller | Bus clock | — | — |
| MCM | Platform clock | — | — |
| COP | Bus clock | COP clock | — |
| Clocks | | | |
| MCG | Bus clock | MCGOUTCLK, MCGFLLCLK, MCGIRCLK, OSCERCLK | — |
| Reference Oscillator | — | OSCERCLK | — |
| 32KHz Oscillator | — ¹ | OSC32KCLK | — |
| Memory and memory interfaces | | | |
| Flash Controller | Platform clock | | — |

Table continues on the next page...

Table 5-2. Module clocks (continued)

| Module | Bus interface clock | Internal clocks | I/O interface clocks |
|---------------------------------|---------------------|---------------------------|----------------------|
| Flash memory | Flash clock | — | — |
| Analog | | | |
| ADC | Bus clock | OSCERCLK | — |
| CMP | Bus clock | — | — |
| DAC | Bus clock | — | — |
| Timers | | | |
| TPM0/1/2 | Bus clock | TPM clock | TPM_CLKINx |
| PIT | Bus clock | — | — |
| CMT | Bus clock | — | — |
| LPTMR | Bus clock | LPTMR clock | — |
| RTC | Bus clock | ERCLK32K | — |
| Communication interfaces | | | |
| SPI0/1 | Bus clock | — | SPI0_SCK, SPI1_SCK |
| I ² C0 | Bus clock | — | I2C0_SCL |
| I ² C1 | System clock | — | I2C1_SCL |
| LPUART | Bus clock | LPUART clock | — |
| Human-machine interfaces | | | |
| GPIO | Platform clock | — | — |
| TSI | Bus clock | — | — |
| Security | | | |
| AESA | System clock | — | — |
| TRNG | Bus clock | — | — |
| Radio | | | |
| RF/Analog | — | OSC CLK | — |
| BTLL | OSCERCLK/2 | OSCERCLK, ERCLK32K | — |
| RSIM | Bus clock | ERCLK32K | — |
| XCVR_PHY | OSCERCLK | OSCERCLK, sigma_delta_clk | — |
| 802.15.4 | OSCERCLK | OSCERCLK | — |
| Generic FSK | OSCERCLK | OSCERCLK | — |

1. In KW4x, the 32 kHz osc will be controlled via the RTC.

5.8.1 PMC 1 kHz LPO clock

The Power Management Controller (PMC) generates a 1 kHz clock that is enabled in all modes of operation, including all low power modes except VLLS0. This 1 kHz source is commonly referred to as LPO clock or 1 kHz LPO clock.

5.8.2 COP clocking

The COP may be clocked from four clock sources as shown in the following figure.

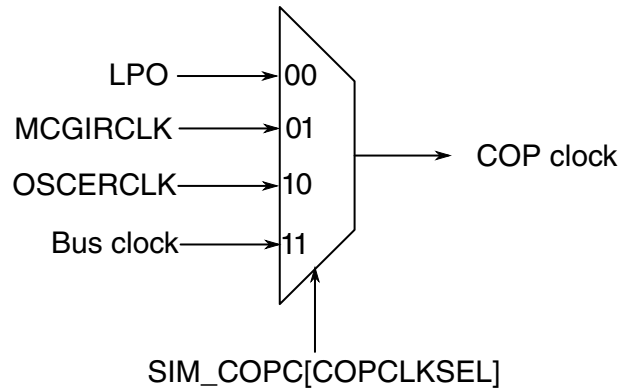

Figure 5-2. COP clock generation

5.8.3 RTC clocking

The RTC module can be clocked as shown in the following figure.

NOTE

The chosen clock must remain enabled if the RTC is to continue operating in all required low-power modes.

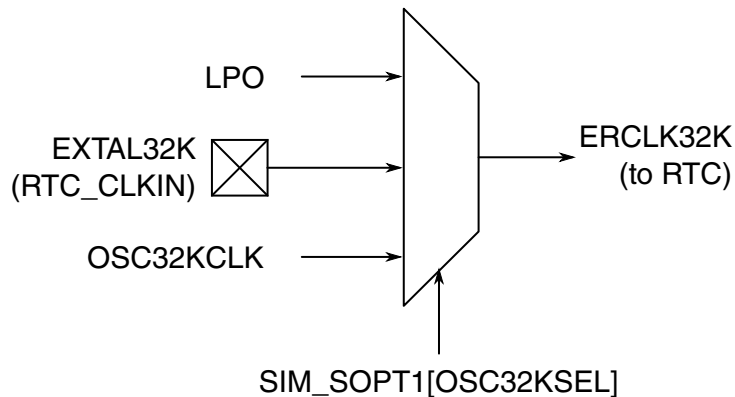

Figure 5-3. RTC clock generation

5.8.4 LPTMR clocking

The prescaler and glitch filters in each of the LPTMR_x modules can be clocked as shown in the following figure.

NOTE

The chosen clock must remain enabled if the LPTMR_x is to continue operating in all required low-power modes.

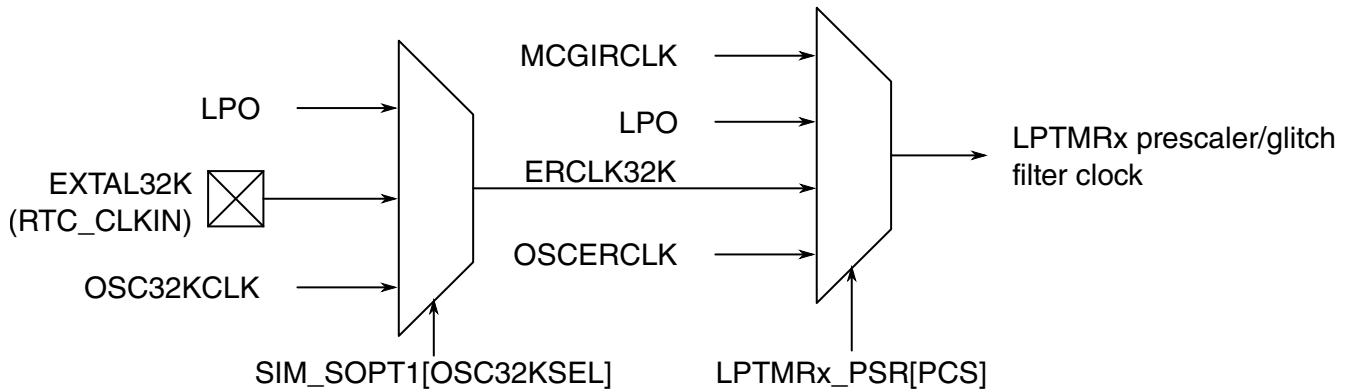

Figure 5-4. LPTMRx prescaler/glitch filter clock generation

5.8.5 TPM clocking

The clock used by the TPM modules can be selected as shown in the following figure.

NOTE

The chosen clock must remain enabled if the TPM is to continue operating in all required low-power modes.

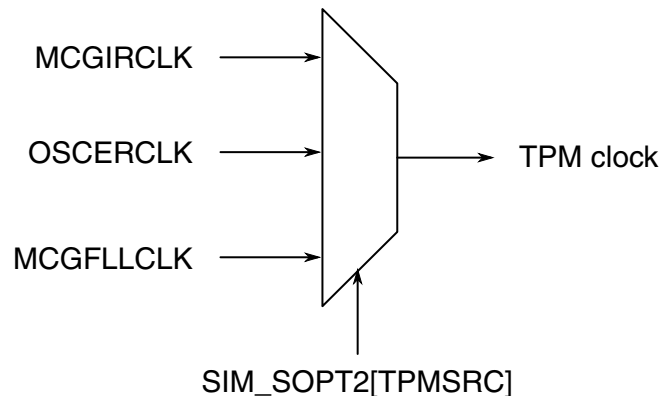

Figure 5-5. TPM clock generation

5.8.6 LPUART clocking

The LPUART module has a selectable clock as shown in the following figure.

NOTE

The chosen clock must remain enabled if the LPUART is to continue operating in all required low-power modes.

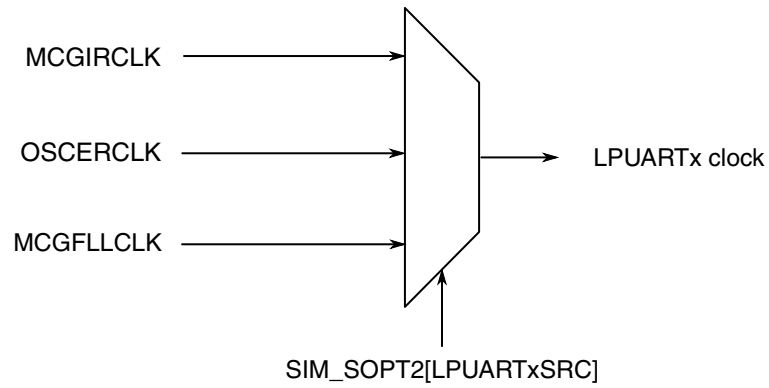

Figure 5-6. LPUART clock generation

Chapter 6

Reset and Boot

This section describes the basic reset and boot mechanisms and sources for this device.

6.1 Introduction

The reset sources supported in this MCU are listed in the table found here.

Table 6-1. Reset sources

| Reset sources | Description |
|---------------|--|
| POR reset | <ul style="list-style-type: none">• Power-on reset (POR) |
| System resets | <ul style="list-style-type: none">• External pin reset (PIN)• Low-voltage detect (LVD)• Computer operating properly (COP) watchdog reset• Low leakage wakeup (LLWU) reset• Multipurpose clock generator loss of clock (LOC) reset• Stop mode acknowledge error (SACKERR)• Software reset (SW)• Lockup reset (LOCKUP)• MDM DAP system reset |
| Debug reset | <ul style="list-style-type: none">• Debug reset |

Each of the system reset sources has an associated bit in the System Reset Status (SRS) registers. See the [Reset Control Module](#) for register details.

The MCU can exit and reset in functional mode where the CPU is executing code (default) or the CPU is in a debug halted state. There are several boot options that can be configured. See [Boot information](#) for more details.

6.2 Reset

The information found here discusses basic reset mechanisms and sources.

Some modules that cause resets can be configured to cause interrupts instead. Consult the individual peripheral chapters for more information.

6.2.1 Power-on reset (POR)

When power is initially applied to the PMC or when the supply voltage drops below the power-on reset re-arm voltage level (V_{POR}), the PMC's POR circuit causes a POR reset condition.

As the supply voltage rises, the LVD circuit holds the MCU in reset until the supply has risen above the LVD low threshold (V_{LVDL}). The POR and LVD fields in the System Reset Status register, RCM_SRS0, are set following a POR.

6.2.2 System reset sources

Resetting the MCU provides a way to start processing from a known set of initial conditions. System reset begins with the on-chip in full regulation and system clocking generation from an internal reference. When the processor exits reset, it performs the following:

- Reads the start SP (SP_main) from vector-table offset 0
- Reads the start PC from vector-table offset 4
- LR is set to 0xFFFF_FFFF

The on-chip peripheral modules are disabled and the non-analog I/O pins are initially configured as disabled. The pins with analog functions assigned to them default to their analog function after reset.

During and following a reset, the SWD pins have their associated input pins configured as:

- SWD_CLK in pull-down (PD)
- SWD_DIO in pull-up (PU)

6.2.2.1 External pin reset (RESET_b)

This pin is open drain and has an internal pullup device. Asserting RESET_b wakes the device from any mode.

The RESET_b pin can be disabled by programming RESET_PIN_CFG option bit to 0. When this option is selected, there could be a short period of contention during a POR ramp where the device drives the pin-out low prior to establishing the setting of this option and releasing the reset function on the pin. When the RESET pin is disabled and configured as a GPIO output, it operates as a pseudo open drain output.

6.2.2.1.1 $\overline{\text{RESET}}$ pin filter

The $\overline{\text{RESET}}$ pin filter supports filtering from both the 1 kHz LPO clock and the bus clock. RCM_RPFC[RSTFLTSS], RCM_RPFC[RSTFLTSRW], and RCM_RPFW[RSTFLTSEL] control this functionality; see the [RCM](#) chapter. The filters are asynchronously reset by Chip POR. The reset value for each filter assumes the $\overline{\text{RESET}}$ pin is negated.

For all stop modes where LPO clock is still active (Stop, VLPS, LLS, VLLS3, and VLLS1), the only filtering option is the LPO-based digital filter. The filtering logic either switches to bypass operation or has continued filtering operation depending on the filtering mode selected. When entering VLLS0, the $\overline{\text{RESET}}$ pin filter is disabled and bypassed.

The LPO filter has a fixed filter value of 3. Due to a synchronizer on the input data, there is also some associated latency (2 cycles). As a result, 5 cycles are required to complete a transition from low to high or high to low.

6.2.2.2 Low-voltage detect (LVD)

The chip includes a system for managing low-voltage conditions to protect memory contents and control MCU system states during supply voltage variations. The system consists of a power-on reset (POR) circuit and an LVD circuit with a user-selectable trip voltage. The LVD system is always enabled in Normal Run, Wait, or Stop mode. The LVD system is disabled when entering VLPx, LLS, or VLLSx modes.

The LVD can be configured to generate a reset upon detection of a low-voltage condition by setting PMC_LVDSC1[LVDRE] to 1. The low-voltage detection threshold is determined by PMC_LVDSC1[LVDV]. After an LVD reset has occurred, the LVD system holds the MCU in reset until the supply voltage has risen above the low voltage detection threshold. RCM_SRS0[LVD] is set following either an LVD reset or POR.

When using the DCDC, the default configuration of the LVD and LVW levels will ensure proper device operation. If the DCDC is programmed to output a voltage higher than 1.8V on VDD_1p8OUT pin, the low-voltage warning (LVW) level can be changed

if desired, but the LVD level should be left at its default value. It is also recommended that the PMC_LVDSC1[LVDRE] bit should remain set to allow LVD to generate a reset on a low-voltage condition.

6.2.2.3 Computer operating properly (COP) watchdog timer

The computer operating properly (COP) watchdog timer (WDOG) monitors the operation of the system by expecting periodic communication from the software. This communication is generally known as servicing (or refreshing) the COP watchdog. If this periodic refreshing does not occur, the watchdog issues a system reset. The COP reset causes RCM_SRS0[WDOG] to set.

6.2.2.4 Low leakage wakeup (LLWU)

The LLWU module provides the means for a number of external pins and a number of internal peripherals to wake the MCU from low leakage power modes. The LLWU module is functional only in low leakage power modes. In VLLSx modes, all enabled inputs to the LLWU can generate a system reset.

After a system reset, the LLWU retains the flags indicating the input source of the last wakeup until the user clears them.

NOTE

Some flags are cleared in the LLWU and some flags are required to be cleared in the peripheral module. Refer to the individual peripheral chapters for more information.

6.2.2.5 Multipurpose clock generator loss-of-clock (LOC)

The MCG module supports external reference clocks.

If MCG_C6[CME] is set, the clock monitor associated with the RF reference oscillator is enabled. If the external reference falls below f_{loc_low} or f_{loc_high} , as controlled by MCG_C2[RANGE], the MCU resets. MCG_SC[LOCS0] and [RCM_SRS0[LOC] are set to indicate this reset source.

If MCG_C8[CME1] is set, the clock monitor associated with the RTC oscillator is enabled. If the external reference falls below f_{loc_low} , the MCU resets. MCG_C8[LOCS1] and RCM_SRS0[LOC] are set to indicate this reset source.

NOTE

To prevent unexpected loss of clock reset events, all clock monitors must be disabled before entering any low-power modes, including VLPR and VLPW.

6.2.2.6 Stop mode acknowledge error (SACKERR)

This reset is generated if the core attempts to enter Stop mode or Compute Operation, but not all modules acknowledge Stop mode within 1025 cycles of the 1 kHz LPO clock.

A module might not acknowledge the entry to Stop mode if an error condition occurs. The error can be caused by a failure of an external clock input to a module.

6.2.2.7 Software reset (SW)

The SYSRESETREQ field in the NVIC Application Interrupt and Reset Control register can be set to force a software reset on the device. (See ARM's NVIC documentation for the full description of the register fields, especially the VECTKEY field requirements.) Setting SYSRESETREQ generates a software reset request. This reset forces a system reset of all major components except for the debug module. A software reset causes RCM_SRS1[SW] to set.

6.2.2.8 Lockup reset (LOCKUP)

The LOCKUP gives immediate indication of seriously errant kernel software. This is the result of the core being locked because of an unrecoverable exception following the activation of the processor's built in system state protection hardware.

The LOCKUP condition causes a system reset and also causes RCM_SRS1[LOCKUP] to set.

6.2.2.9 MDM-AP system reset request

Set the System Reset Request field in the MDM-AP control register to initiate a system reset. This is the primary method for resets via the SWD interface. The system reset is held until this field is cleared.

Set the Core Hold Reset field in the MDM-AP control register to hold the core in reset as the rest of the chip comes out of system reset.

6.2.3 MCU resets

A variety of resets are generated by the MCU to reset different modules.

6.2.3.1 POR Only

The POR Only reset asserts on the POR reset source only. It resets the PMC and RTC.

The POR Only reset also causes all other reset types to occur.

6.2.3.2 Chip POR not VLLS

The Chip POR not VLLS reset asserts on POR and LVD reset sources. It resets parts of the SMC and SIM. It also resets the LPTMR.

The Chip POR not VLLS reset also causes these resets to occur: Chip POR, Chip Reset not VLLS, and Chip Reset (including Early Chip Reset).

6.2.3.3 Chip POR

The Chip POR asserts on POR, LVD, and VLLS Wakeup reset sources. It resets the Reset Pin Filter registers and parts of the SIM and MCG.

The Chip POR also causes the Chip Reset (including Early Chip Reset) to occur.

6.2.3.4 Chip Reset not VLLS

The Chip Reset not VLLS reset asserts on all reset sources except a VLLS Wakeup that does not occur via the $\overline{\text{RESET}}$ pin. It resets parts of the SMC, LLWU, and other modules that remain powered during VLLS mode.

The Chip Reset not VLLS reset also causes the Chip Reset (including Early Chip Reset) to occur.

6.2.3.5 Chip Reset not VLLS3/2

The Chip Reset not VLLS3/2 reset asserts on all reset sources except a VLLS3 or VLLS2 Wakeup that does not occur via the $\overline{\text{RESET}}$ pin. It resets the radio digital logic which remains in state-retention during VLLS3 and VLLS2 modes.

6.2.3.6 Early Chip Reset

The Early Chip Reset asserts on all reset sources. It resets only the flash memory module. It negates before flash memory initialization begins ("earlier" than when the Chip Reset negates).

6.2.3.7 Chip Reset

Chip Reset asserts on all reset sources and only negates after flash initialization has completed and the $\overline{\text{RESET}}$ pin has also negated. It resets the remaining modules (the modules not reset by other reset types).

6.2.4 RESET_b pin

For all reset sources except a VLLS Wakeup that does not occur via the RESET_b pin, the RESET_b pin is driven low by the MCU for at least 128 bus clock cycles and until flash initialization has completed.

After flash initialization has completed, the RESET_b pin is released, and the internal Chip Reset negates after the RESET_b pin is pulled high. Keeping the RESET_b pin asserted externally delays the negation of the internal Chip Reset.

The RESET_b pin can be disabled by programming FTFA_FOPT[RESET_PIN_CFG] option bit to 0 (See [Table 6-2](#)). When this option is selected, there could be a short period of contention during a POR ramp where the device drives the pin low prior to establishing the setting of this option and releasing the reset function on the pin. When the RESET pin is disabled and configured as a GPIO output, it operates as a pseudo open drain output.

6.3 Boot

The information found here describes the boot sequence, including sources and options.

Some configuration information such as clock trim values stored in factory programmed flash locations is autoloaded.

6.3.1 Boot sources

The Cortex-M0+ core adds support for a programmable Vector Table Offset Register (VTOR) to relocate the exception vector table. This device supports booting from internal flash and RAM.

This device supports booting from internal flash with the reset vectors located at addresses 0x0 (initial SP_main), 0x4 (initial PC), and RAM with relocating the exception vector table to RAM.

6.3.2 FOPT boot options

The Flash Option (FOPT) register in the Flash Memory module (FTFA_FOPT) allows the user to customize the operation of the MCU at boot time. The register contains read-only bits that are loaded from the NVM's option byte in the flash configuration field. The default setting for all values in the FTFA_FOPT register is logic 1 since it is copied from the option byte residing in flash, which has all bits as logic 1 in the flash erased state. To configure for alternate settings, program the appropriate bits in the NVM option byte. The new settings will take effect on subsequent POR, VLLSx recoveries, and any system reset. For more details on programming the option byte, see the flash memory chapter.

The MCU uses the bits of FTFA_FOPT to configure the device at reset as shown in the following table.

NOTE

Reserved bits in the option byte should be left in their default erased state of logic 1 to avoid FOPT[7:0] = 0x00 which is not valid, and is treated as FOPT[7:0] = 0xFF.

Table 6-2. Flash Option Register (FTFA_FOPT) bit definitions

| Bit Num | Field | Value | Definition |
|---------|-----------|-------|---|
| 7-6 | Reserved | | Reserved for future expansion. |
| 5 | FAST_INIT | | Selects initialization speed on POR, VLLSx, and any system reset . |
| | | 0 | Slower initialization: The flash initialization will be slower with the benefit of reduced average current during this time. The duration of the recovery will be controlled by the clock divider selection determined by the LPBOOT setting. |
| | | 1 | Fast Initialization: The flash has faster recoveries at the expense of higher current during these times. |

Table continues on the next page...

**Table 6-2. Flash Option Register (FTFA_FOPT) bit definitions
(continued)**

| Bit Num | Field | Value | Definition |
|---------|---------------|-------|---|
| 3 | RESET_PIN_CFG | | Enables/disables control for the RESET pin. |
| | | 0 | <p>$\overline{\text{RESET}}$ pin is disabled following a POR and cannot be enabled as reset function. When this option is selected, there could be a short period of contention during a POR ramp where the device drives the pinout low prior to establishing the setting of this option and releasing the reset function on the pin.</p> <p>This bit is preserved through system resets and low-power modes. When $\overline{\text{RESET}}$ pin function is disabled, it cannot be used as a source for low-power mode wake-up.</p> <p>NOTE: When the reset pin has been disabled and security has been enabled by means of the FSEC register, a mass erase can be performed only by setting both the Mass Erase and System Reset Request fields in the MDM-AP register.</p> |
| | | 1 | $\overline{\text{RESET}}$ pin is dedicated. The port is configured with pullup enabled, open drain, passive filter enabled. |
| 2 | NMI_DIS | | Enables/disables control for the NMI function. |
| | | 0 | NMI interrupts are always blocked. The associated pin continues to default to $\overline{\text{NMI}}$ pin controls with internal pullup enabled. When $\overline{\text{NMI}}$ pin function is disabled, it cannot be used as a source for low-power mode wake-up. |
| | | 1 | $\overline{\text{NMI}}$ pin/interrupts reset default to enabled. |
| 1 | Reserved | | Reserved for future expansion. |
| 4,0 | LPBOOT | | Controls the reset value of OUTDIV1 value in SIM_CLKDIV1 register. Larger divide value selections produce lower average power consumption during POR, VLLSx recoveries and reset sequencing and after reset exit. The recovery times are also extended if the FAST_INIT option is not selected. |
| | | 00 | Core and system clock divider (OUTDIV1) is 0x7 (divide by 8). |
| | | 01 | Core and system clock divider (OUTDIV1) is 0x3 (divide by 4). |
| | | 10 | Core and system clock divider (OUTDIV1) is 0x1 (divide by 2). |
| | | 11 | Core and system clock divider (OUTDIV1) is 0x0 (divide by 1). |

6.3.3 Boot sequence

At power up, the on-chip regulator holds the system in a POR state until the input supply exceeds the POR threshold. The system continues to be held in this static state until the internally regulated supplies have reached a safe operating voltage as determined by the LVD. The Reset Controller logic then controls a sequence to exit reset.

1. A system reset is held on internal logic, the $\overline{\text{RESET}}$ pin is driven out low, and the MCG is enabled in its default clocking mode.
2. Required clocks are enabled (system clock, flash clock, and any bus clocks that do not have clock gate control reset to disabled).

3. The system reset on internal logic continues to be held, but the Flash module is released from reset and begins initialization operation while the Reset Control logic continues to drive the $\overline{\text{RESET}}$ pin out low.
4. Early in reset sequencing, the NVM option byte is read and stored to the FOPT register of the Flash Memory module (FTFA_FOPT). If the bits associated with FTFA_FOPT[LPBOOT] are programmed for an alternate clock divider reset value, the system/core clock is switched to a slower clock speed. If FTFA_FOPT[FAST_INIT] is programmed clear, the flash initialization switches to slower clock resulting longer recovery times.
5. When flash Initialization completes, the $\overline{\text{RESET}}$ pin is released. If $\overline{\text{RESET}}$ continues to be asserted (an indication of a slow rise time on the $\overline{\text{RESET}}$ pin or external drive in low), the system continues to be held in reset. Once the $\overline{\text{RESET}}$ pin is detected high, the core clock is enabled and the system is released from reset.
6. When the system exits reset, the processor sets up the stack, program counter (PC), and link register (LR). The processor reads the start SP (SP_main) from vector-table offset 0. The core reads the start PC from vector-table offset 4. LR is set to 0xFFFF_FFFF. The next sequence of events depends on the $\overline{\text{NMI}}$ input and FTFA_FOPT[NMI_DIS] (See [Table 6-2](#)) :
 - If the $\overline{\text{NMI}}$ input is high or the NMI function is disabled in FTFA_FOPT, the CPU begins execution at the PC location.
 - If the $\overline{\text{NMI}}$ input is low and the NMI function is enabled in FTFA_FOPT, this results in an NMI interrupt. The processor executes an Exception Entry and reads the NMI interrupt handler address from vector-table offset 8. The CPU begins execution at the NMI interrupt handler.

Subsequent system resets follow this same reset flow.

Chapter 7

Kinetis Flashloader

7.1 Chip-Specific Information

This device has various peripherals (LPUART, I2C, SPI) supported by the Kinetis Flashloader. The following table shows the pads used by the Kinetis Flashloader.

Table 7-1. Kinetis Flashloader Peripheral Pinmux

| Peripheral | Instance | Port |
|------------|----------|--|
| LPUART | 0 | PTC6, LPUART0_RX PTC7, LPUART0_TX |
| I2C | 0 | PTB0, I2C0_SCL PTB1, I2C0_SDA |
| SPI | 0 | PTC16, SPI0_SCK PTC17, SPI0_SOUT PTC18, SPI0_SIN PTC19, SPI0_PCS0 |

7.2 Introduction

The Kinetis devices *that do not have an on-chip ROM* are shipped with the pre-programmed Kinetis Flashloader in the on-chip flash memory, for one-time, in-system factory programming. The Kinetis Flashloader's main task is to load a customer firmware image into the flash memory. The image on the flash has 2 programs: flashloader_loader and flashloader. After a device reset, the flashloader_loader program starts its execution first. The flashloader_loader program copies the contents of flashloader image from the flash to the on-chip RAM; the device then switches execution to the flashloader program to execute from RAM.

For this device, the Kinetis Flashloader can interface with LPUART, I2C, and SPI peripherals in slave mode and respond to the commands sent by a master (or host) communicating on one of those ports. The host/master can be a firmware-download application running on a PC or an embedded host communicating with the Kinetis Flashloader. Regardless of the host/master (PC or embedded host), the Kinetis Flashloader always uses a command protocol to communicate with that host/master. Commands are provided to write to memory (flash or RAM), erase flash, and get/set flashloader options and property values. The host application can query the set of available commands.

This chapter describes Kinetis Flashloader features, functionality, command structure and which peripherals are supported.

Features supported by the Kinetis Flashloader :

- Supports LPUART, I2C, and SPI peripheral interfaces
- Automatic detection of the active peripheral
- LPUART peripheral with autobaud
- Common packet-based protocol for all peripherals
- Packet error detection and retransmission
- Protection of RAM used by the flashloader while it is running
- Provides command to read properties of the device, such as flash and RAM size

Table 7-2. Commands supported by the Kinetis Flashloader

| Command | Description | When flash security is enabled, then this command is |
|-------------------|---|--|
| Call | Runs user application code and returns control to bootloader | Not supported |
| Execute | Run user application code that never returns control to the flashloader | Not supported |
| FillMemory | Fill a range of bytes in flash with a word pattern | Not supported |
| FlashEraseAll | Erase the entire flash array | Not supported |
| FlashEraseRegion | Erase a range of sectors in flash | Not supported |
| FlashProgramOnce | Writes data provided in a command packet to a specified range of bytes in the program once field | Not supported |
| FlashReadOnce | Returns the contents of the program once field by given index and byte count | Not supported |
| FlashReadResource | Returns the contents of the IFR field or Flash Version ID, by given offset, byte count and option | Not supported |
| WriteMemory | Write data to memory | Not supported |
| ReadMemory | Read data from memory | Not supported |
| GetProperty | Get the current value of a property | Supported |
| ReceiveSbFile | Receive an SB file (which is generated by the elftosb tool) | Supported if the SB file is encrypted. See the SB File |

Table continues on the next page...

Table 7-2. Commands supported by the Kinetis Flashloader (continued)

| Command | Description | When flash security is enabled, then this command is |
|-----------------------|---|--|
| | | Decryption Support section for more details. |
| Reset | Reset the chip | Supported |
| SetProperty | Attempt to modify a writable property | Supported |
| FlashEraseAllUnsecure | Erase the entire flash array, including protected sectors | Supported |

7.3 Functional Description

The following sub-sections describe the Kinetis Flashloader functionality.

7.3.1 Memory Maps

While executing, the Kinetis Flashloader uses RAM memory.

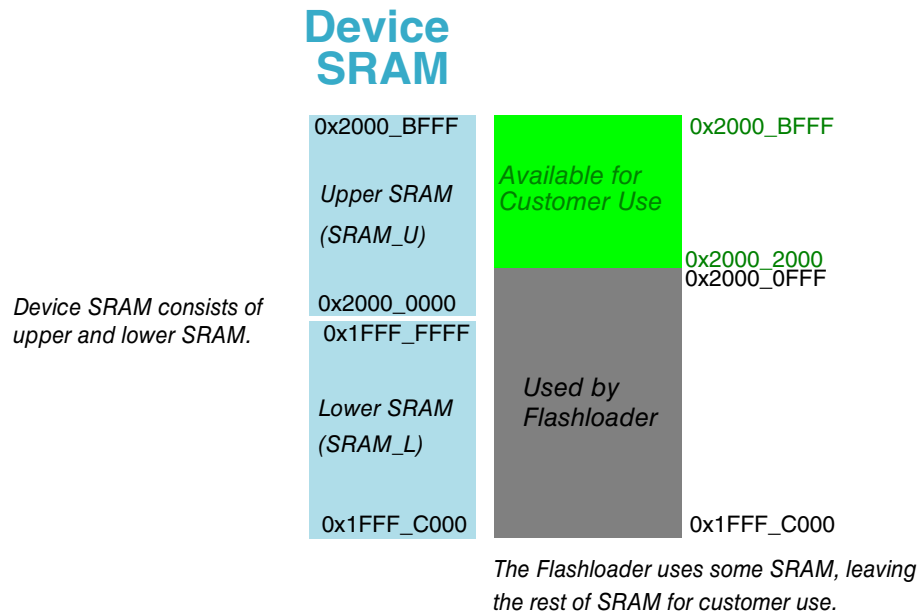

Figure 7-1. Kinetis Flashloader RAM Memory Map

NOTE

The Kinetis Flashloader requires a minimum memory space of 32 KB of RAM. For Kinetis devices with less than this amount of on-chip RAM, the Kinetis Flashloader is not available.

7.3.2 Start-up Process

As the Kinetis Flashloader begins executing, flashloader operations begin:

1. The flashloader’s temporary working area in RAM is initialized.
2. All supported peripherals are initialized.
3. The flashloader waits for communication to begin on a peripheral.
 - There is no timeout for the active peripheral detection process.
 - If communication is detected, then all inactive peripherals are shut down, and the command phase is entered.

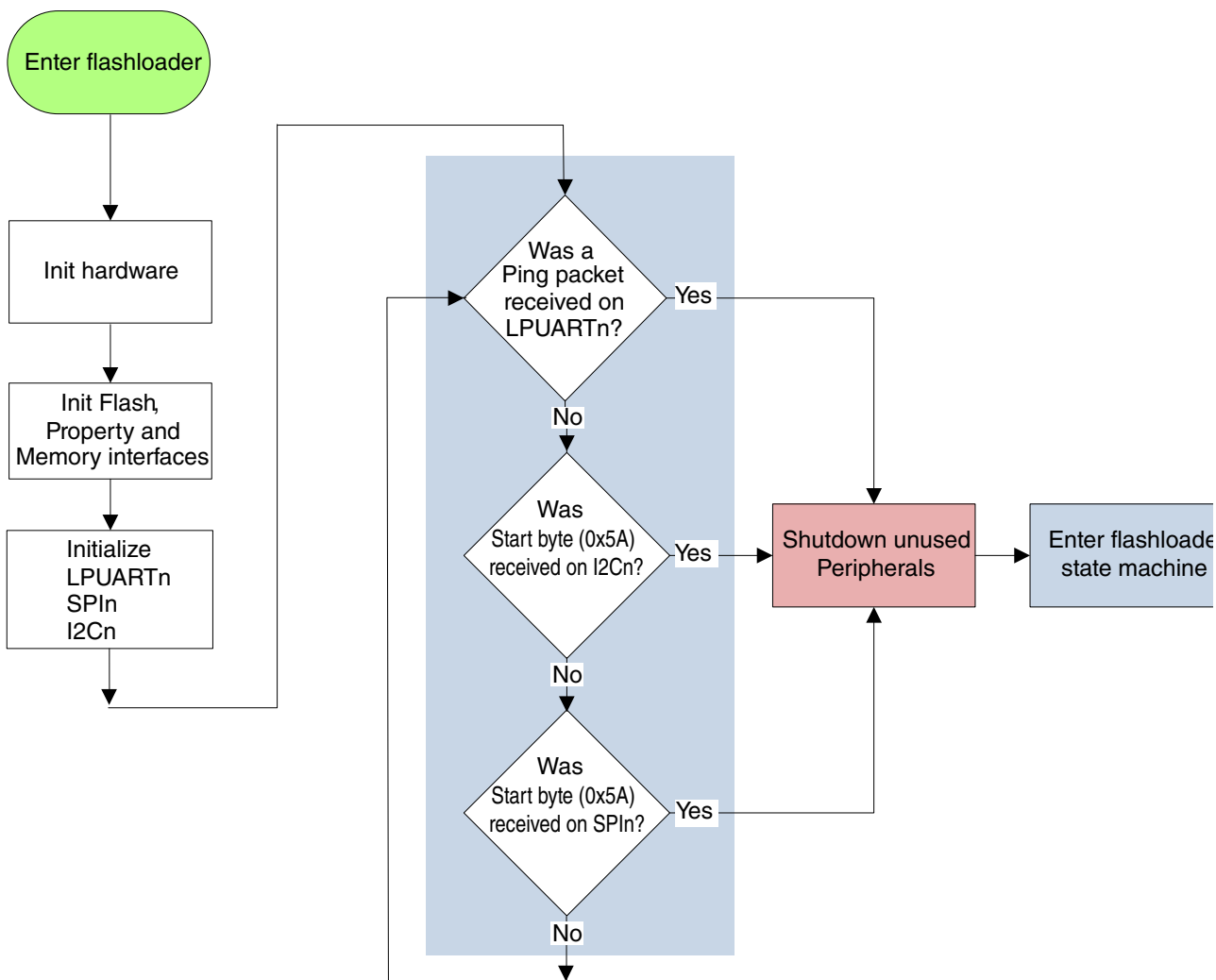

Figure 7-2. Kinetis Flashloader Start-up Flowchart

7.3.3 Clock Configuration

The core runs on the default reset clock (20.9 MHz). The Kinetis Flashloader does not modify any clocks.

7.3.4 Flashloader Protocol

This section explains the general protocol for the packet transfers between the host and the Kinetis Flashloader. The description includes the transfer of packets for different transactions, such as commands with no data phase and commands with incoming or outgoing data phase. The next section describes various packet types used in a transaction.

Each command sent from the host is replied to with a response command.

Commands may include an optional data phase:

- If the data phase is **incoming** (from host to flashloader), then the data phase is part of the **original command**.
- If the data phase is **outgoing** (from flashloader to host), then the data phase is part of the **response command**.

NOTE

In all protocols (described in the next subsections), the Ack sent in response to a Command or Data packet can arrive at any time *before, during, or after* the Command/Data packet has processed.

7.3.4.1 Command with no data phase

The protocol for a command with no data phase contains:

- Command packet (from host)
- Generic response command packet (to host)

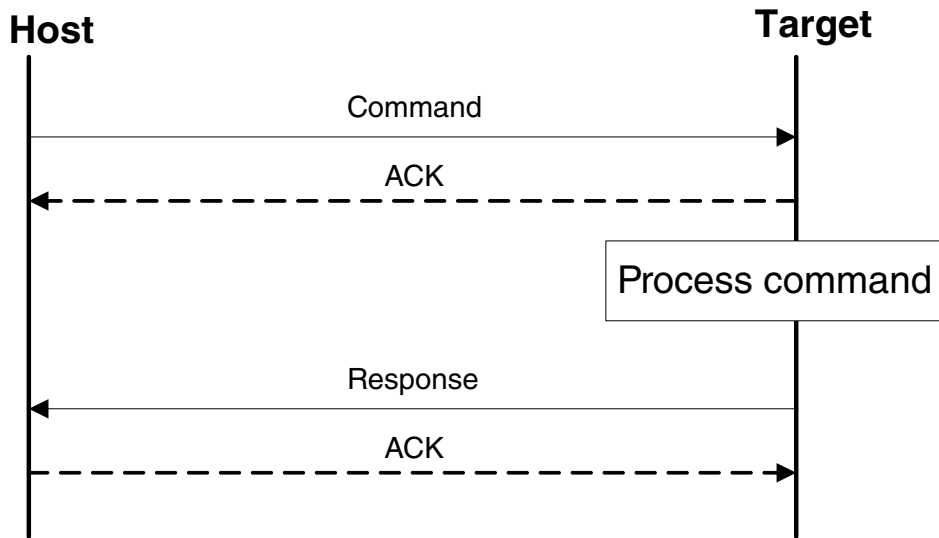

Figure 7-3. Command with No Data Phase

7.3.4.2 Command with incoming data phase

The protocol for a command with an incoming data phase contains:

- Command packet (from host)
- Generic response command packet (to host)
- Incoming data packets (from host)
- Generic response command packet (to host)

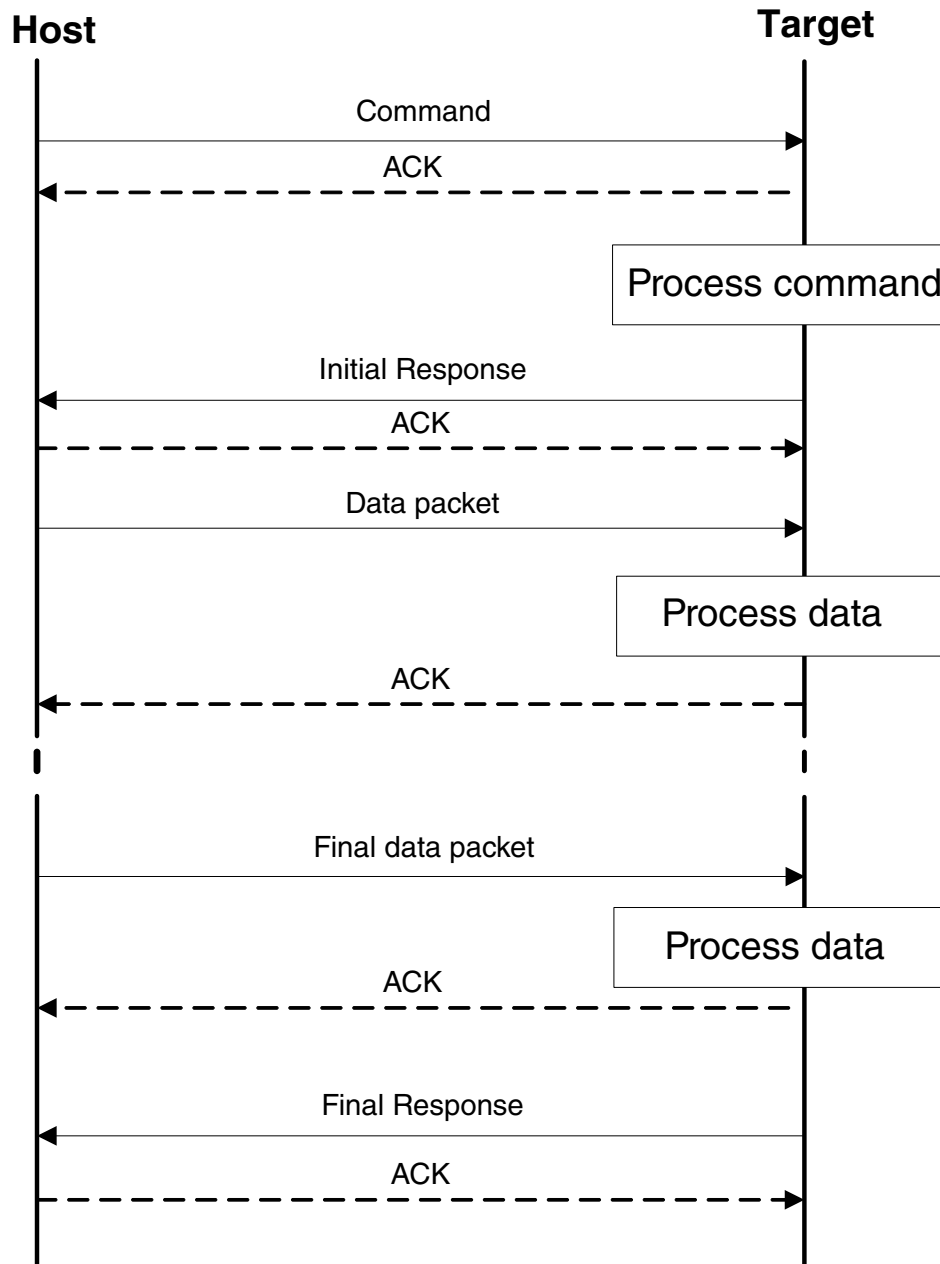

Figure 7-4. Command with incoming data phase

NOTE

- The host may not send any further packets while it (the host) is waiting for the response to a command.
- If the Generic Response packet prior to the start of the data phase does not have a status of `kStatus_Success`, then the data phase is aborted.
- Data phases may be aborted by the receiving side by sending the final Generic Response early with a status of

kStatus_AbortDataPhase. The host may abort the data phase early by sending a zero-length data packet.

- The final Generic Response packet *sent after the data phase* includes the status for the entire operation.

7.3.4.3 Command with outgoing data phase

The protocol for a command with an outgoing data phase contains:

- Command packet (from host)
- ReadMemory Response command packet (to host) (kCommandFlag_HasDataPhase set)
- Outgoing data packets (to host)
- Generic response command packet (to host)

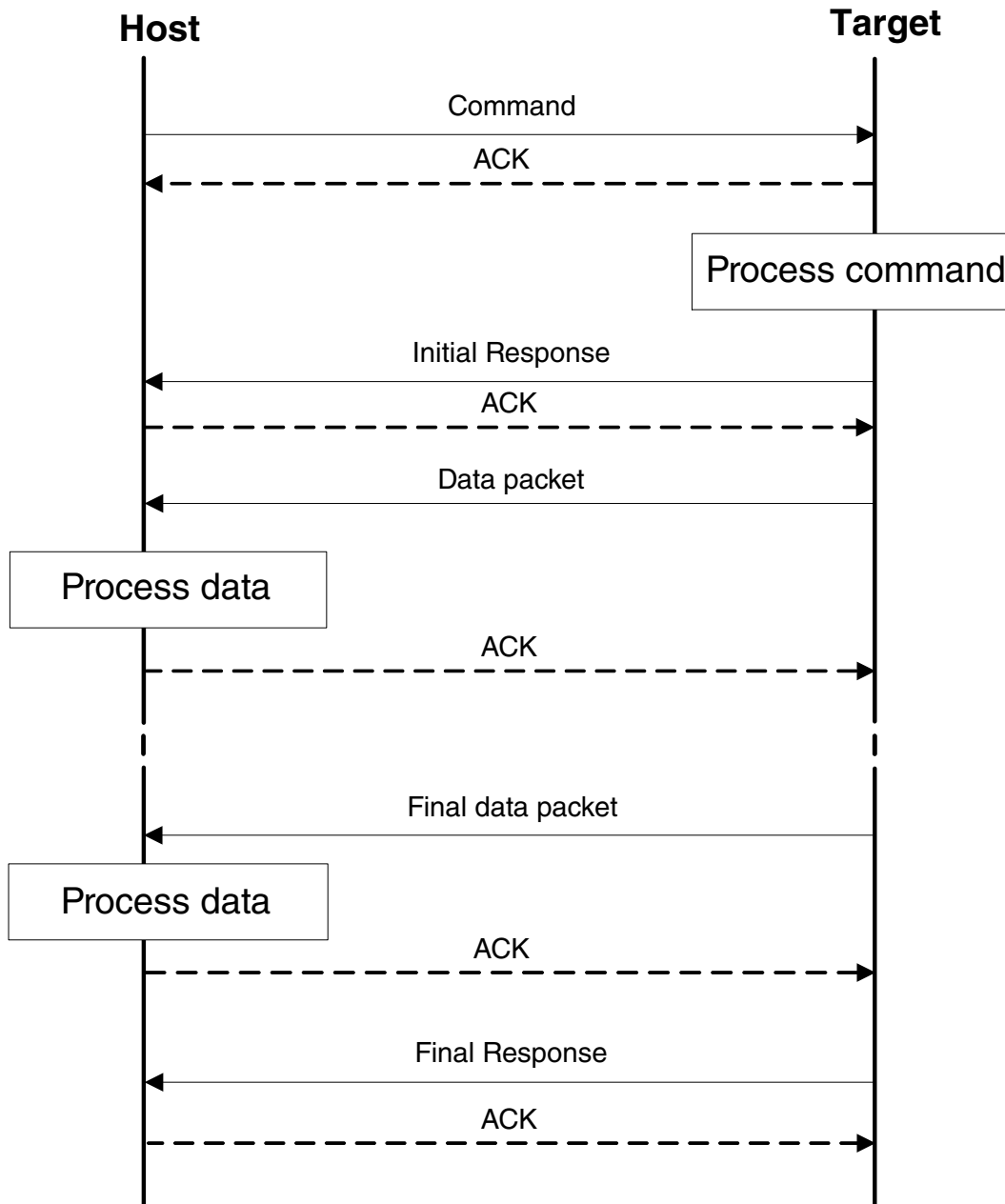

Figure 7-5. Command with outgoing data phase

NOTE

- For the outgoing data phase sequence above, the data phase is really considered part of the response command.
- The host may not send any further packets while it (the host) is waiting for the response to a command.
- If the ReadMemory Response command packet prior to the start of the data phase does not contain the `kCommandFlag_HasDataPhase` flag, then the data phase is aborted.

- Data phases may be aborted by the host sending the final Generic Response early with a status of `kStatus_AbortDataPhase`. The sending side may abort the data phase early by sending a zero-length data packet.
- The final Generic Response packet *sent after the data phase* includes the status for the entire operation.

7.3.5 Flashloader Packet Types

The Kinetis Flashloader device works in slave mode. All data communication is initiated by a host, which is either a PC or an embedded host (note that QuadSPI is treated like a storage device, like flash). The Kinetis Flashloader device is the target, which receives a command or data packet. All data communication between host and target is packetized.

NOTE

The term "target" refers to the "Kinetis Flashloader device."

There are 6 types of packets used in the device:

- Ping packet
- Ping Response packet
- Framing packet
- Command packet
- Data packet
- Response packet

All fields in the packets are in little-endian byte order.

7.3.5.1 Ping packet

The Ping packet is the first packet sent from a host to the target (Kinetis Flashloader), to establish a connection on a selected peripheral. For a LPUART peripheral, the Ping packet is used to determine the baudrate. A Ping packet must be sent before any other communications. In response to a Ping packet, the target sends a Ping Response packet.

Table 7-3. Ping Packet Format

| Byte # | Value | Name |
|--------|-------|------------|
| 0 | 0x5A | start byte |
| 1 | 0xA6 | ping |

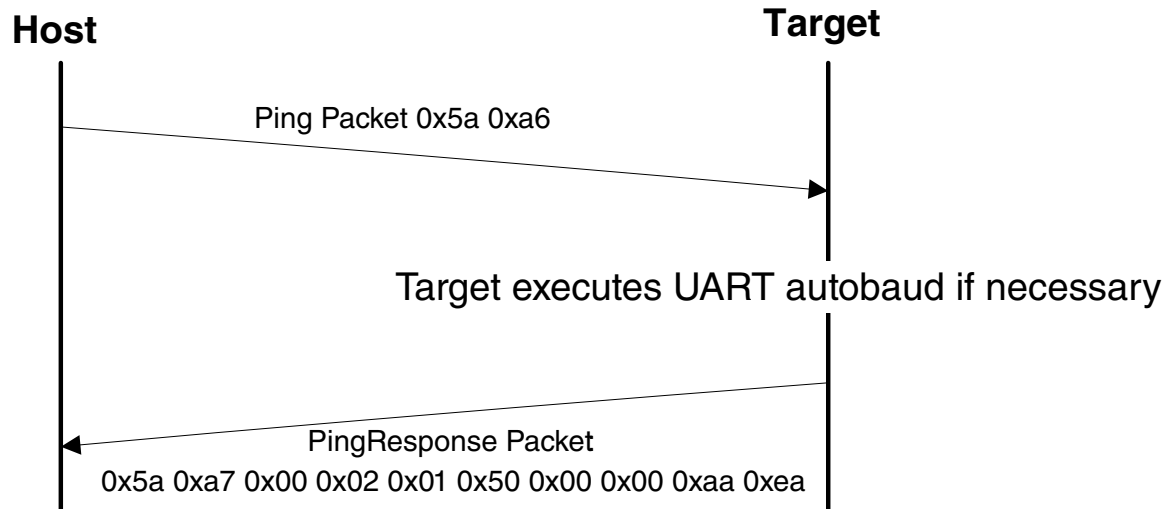

Figure 7-6. Ping Packet Protocol Sequence

7.3.5.2 Ping Response Packet

The target (Kinetis Flashloader) sends a Ping Response packet back to the host after receiving a Ping packet. If communication is over a LPUART peripheral, the target uses the incoming Ping packet to determine the baud rate before replying with the Ping Response packet. Once the Ping Response packet is received by the host, the connection is established, and the host starts sending commands to the target (Kinetis Flashloader).

Table 7-4. Ping Response Packet Format

| Byte # | Value | Parameter |
|--------|-------|----------------------------|
| 0 | 0x5A | start byte |
| 1 | 0xA7 | Ping response code |
| 2 | | Protocol bugfix |
| 3 | | Protocol minor |
| 4 | | Protocol major |
| 5 | | Protocol name = 'P' (0x50) |
| 6 | | Options low |
| 7 | | Options high |
| 8 | | CRC16 low |
| 9 | | CRC16 high |

7.3.5.3 Framing Packet

The framing packet is used for flow control and error detection, and it (the framing packet) wraps command and data packets as well.

The framing packet described in this section is used for serial peripherals including LPUART, I2C, SPI.

Table 7-5. Framing Packet Format

| Byte # | Value | Parameter | |
|-----------|-------|--------------------------------|---|
| 0 | 0x5A | start byte | |
| 1 | | packetType | |
| 2 | | length_low | Length is a 16-bit field that specifies the entire command or data packet size in bytes. |
| 3 | | length_high | |
| 4 | | crc16_low | This is a 16-bit field. The CRC16 value covers entire framing packet, including the start byte and command or data packets, but does not include the CRC bytes. See the CRC16 algorithm after this table. |
| 5 | | crc16_high | |
| 6 . . . n | | Command or Data packet payload | |

A special framing packet that contains only a start byte and a packet type is used for synchronization between the host and target.

Table 7-6. Special Framing Packet Format

| Byte # | Value | Parameter |
|--------|---------|------------|
| 0 | 0x5A | start byte |
| 1 | 0xA n | packetType |

The Packet Type field specifies the type of the packet from one of the defined types (below):

Table 7-7. packetType Field

| packetType | Name | Description |
|------------|-----------------------------|--|
| 0xA1 | kFramingPacketType_Ack | The previous packet was received successfully; the sending of more packets is allowed. |
| 0xA2 | kFramingPacketType_Nak | The previous packet was corrupted and must be re-sent. |
| 0xA3 | kFramingPacketType_AckAbort | Data phase is being aborted. |
| 0xA4 | kFramingPacketType_Command | The framing packet contains a command packet payload. |
| 0xA5 | kFramingPacketType_Data | The framing packet contains a data packet payload. |
| 0xA6 | kFramingPacketType_Ping | Sent to verify the other side is alive. Also used for UART autobaud. |

Table continues on the next page...

Table 7-7. packetType Field (continued)

| packetType | Name | Description |
|------------|---------------------------------|---|
| 0xA7 | kFramingPacketType_PingResponse | A response to Ping; contains the framing protocol version number and options. |

This device uses the Cyclic Redundancy Check module (CRC) to perform the CRC algorithm. See the CRC chapter for more details.

7.3.5.4 Command packet

The command packet carries a 32-bit command header and a list of 32-bit parameters.

Table 7-8. Command Packet Format

| Command Packet Format (32 bytes) | | | | | | | | | | |
|----------------------------------|--------|--------|-------------|--|-----------------|-----------------|-----------------|-----------------|-----------------|-----------------|
| Command Header (4 bytes) | | | | 28 bytes for Parameters (Max 7 parameters) | | | | | | |
| Tag | Flags | Rsvd | Param Count | Param1 (32-bit) | Param2 (32-bit) | Param3 (32-bit) | Param4 (32-bit) | Param5 (32-bit) | Param6 (32-bit) | Param7 (32-bit) |
| byte 0 | byte 1 | byte 2 | byte 3 | | | | | | | |

Table 7-9. Command Header Format

| Byte # | Command Header Field | |
|--------|---------------------------|--|
| 0 | Command or Response tag | The command header is 4 bytes long, with these fields. |
| 1 | Flags | |
| 2 | Reserved. Should be 0x00. | |
| 3 | ParameterCount | |

The header is followed by 32-bit parameters up to the value of the ParameterCount field specified in the header. Because a command packet is 32 bytes long, only 7 parameters can fit into the command packet.

Command packets are also used by the target to send responses back to the host. As mentioned earlier, command packets and data packets are embedded into framing packets for all of the transfers.

Table 7-10. Commands that are supported

| Command | Name |
|---------|------------------|
| 0x01 | FlashEraseAll |
| 0x02 | FlashEraseRegion |
| 0x03 | ReadMemory |

Table continues on the next page...

Table 7-10. Commands that are supported (continued)

| Command | Name |
|---------|-----------------------|
| 0x04 | WriteMemory |
| 0x05 | FillMemory |
| 0x06 | Reserved |
| 0x07 | GetProperty |
| 0x08 | ReceiveSBFile |
| 0x09 | Execute |
| 0x0A | Call |
| 0x0B | Reset |
| 0x0C | SetProperty |
| 0x0D | FlashEraseAllUnsecure |
| 0x0E | FlashProgramOnce |
| 0x0F | FlashReadOnce |
| 0x10 | FlashReadResource |
| 0x11 | Reserved |
| 0x12 | Reserved |

Table 7-11. Responses that are supported

| Response | Name |
|----------|--|
| 0xA0 | GenericResponse |
| 0xA3 | ReadMemoryResponse (used for sending responses to ReadMemory command only) |
| 0xA7 | GetPropertyResponse (used for sending responses to GetProperty command only) |
| 0xAF | FlashReadOnceResponse (used for sending responses to FlashReadOnce command only) |
| 0xB0 | FlashReadResourceResponse (used for sending responses to FlashReadResource command only) |

Flags: Each command packet contains a Flag byte. Only bit 0 of the flag byte is used. If bit 0 of the flag byte is set to 1, then data packets will follow in the command sequence. The number of bytes that will be transferred in the data phase is determined by a command-specific parameter in the parameters array.

ParameterCount: The number of parameters included in the command packet.

Parameters: The parameters are word-length (32 bits). With the default maximum packet size of 32 bytes, a command packet can contain up to 7 parameters.

7.3.5.5 Data packet

The data packet carries just the data, either host sending data to target, or target sending data to host. The data transfer direction is determined by the last command sent from the host. The data packet is also wrapped within a framing packet, to ensure the correct packet data is received.

The contents of a data packet are simply the data itself. There are no other fields, so that the most data per packet can be transferred. Framing packets are responsible for ensuring that the correct packet data is received.

7.3.5.6 Response packet

The responses are carried using the same command packet format wrapped with framing packet data. Types of responses include:

- GenericResponse
- GetPropertyResponse
- ReadMemoryResponse
- FlashReadOnceResponse
- FlashReadResourceResponse

GenericResponse: After the Kinetis Flashloader has processed a command, the flashloader will send a generic response with status and command tag information to the host. The generic response is the last packet in the command protocol sequence. The generic response packet contains the framing packet data and the command packet data (with generic response tag = 0xA0) and a list of parameters (defined in the next section). The parameter count field in the header is always set to 2, for status code and command tag parameters.

Table 7-12. GenericResponse Parameters

| Byte # | Parameter | Description |
|--------|-------------|---|
| 0 - 3 | Status code | The Status codes are errors encountered during the execution of a command by the target (Kinetis Flashloader). If a command succeeds, then a kStatus_Success code is returned. Table 7-50 , Kinetis Flashloader Status Error Codes, lists the status codes returned to the host by the Kinetis Flashloader. |
| 4 - 7 | Command tag | The Command tag parameter identifies the response to the command sent by the host. |

GetPropertyResponse: The GetPropertyResponse packet is sent by the target in response to the host query that uses the GetProperty command. The GetPropertyResponse packet contains the framing packet data and the command packet data, with the command/response tag set to a GetPropertyResponse tag value (0xA7).

The parameter count field in the header is set to greater than 1, to always include the status code and one or many property values.

Table 7-13. GetPropertyResponse Parameters

| Byte # | Value | Parameter |
|--------|-------|---|
| 0 - 3 | | Status code |
| 4 - 7 | | Property value |
| ... | | ... |
| | | Can be up to maximum 6 property values, limited to the size of the 32-bit command packet and property type. |

ReadMemoryResponse: The ReadMemoryResponse packet is sent by the target in response to the host sending a ReadMemory command. The ReadMemoryResponse packet contains the framing packet data and the command packet data, with the command/response tag set to a ReadMemoryResponse tag value (0xA3), the flags field set to kCommandFlag_HasDataPhase (1).

The parameter count set to 2 for the status code and the data byte count parameters shown below.

Table 7-14. ReadMemoryResponse Parameters

| Byte # | Parameter | Description |
|--------|-----------------|---|
| 0 - 3 | Status code | The status of the associated Read Memory command. |
| 4 - 7 | Data byte count | The number of bytes sent in the data phase. |

FlashReadOnceResponse: The FlashReadOnceResponse packet is sent by the target in response to the host sending a FlashReadOnce command. The FlashReadOnceResponse packet contains the framing packet data and the command packet data, with the command/response tag set to a FlashReadOnceResponse tag value (0xAF), and the flags field set to 0. The parameter count is set to 2 plus *the number of words* requested to be read in the FlashReadOnceCommand.

Table 7-15. FlashReadOnceResponse Parameters

| Byte # | Value | Parameter |
|--------|-------|-------------|
| 0 - 3 | | Status Code |

Table continues on the next page...

Table 7-15. FlashReadOnceResponse Parameters (continued)

| | | |
|-------|--|---|
| 4 – 7 | | Byte count to read |
| ... | | ... |
| | | Can be up to 20 bytes of requested read data. |

The FlashReadResourceResponse packet is sent by the target in response to the host sending a FlashReadResource command. The FlashReadResourceResponse packet contains the framing packet data and command packet data, with the command/response tag set to a FlashReadResourceResponse tag value (0xB0), and the flags field set to kCommandFlag_HasDataPhase (1).

Table 7-16. FlashReadResourceResponse Parameters

| Byte # | Value | Parameter |
|--------|-------|-----------------|
| 0 – 3 | | Status Code |
| 4 – 7 | | Data byte count |

7.3.6 Flashloader Command API

All Kinetis Flashloader command APIs follow the command packet format that is wrapped by the framing packet, as explained in previous sections.

- For a list of commands supported by the Flashloader, see [Table 7-2, Commands supported](#).
- For a list of status codes returned by the Kinetis Flashloader, see [Table 7-50, Kinetis Flashloader Status Error Codes](#).

NOTE

All the examples in this section depict byte traffic on serial peripherals that use framing packets.

7.3.6.1 Call command

The Call command will execute a function that is written in memory at the address sent in the command. The address needs to be a valid memory location residing in accessible flash (internal or external) or in RAM. The command supports the passing of one 32-bit argument. Although the command supports a stack address, at this time the call will still take place using the current stack pointer. After execution of the function, a 32-bit return value will be returned in the generic response message.

Table 7-17. Parameters for Call Command

| Byte # | Command |
|--------|---------------|
| 0 - 3 | Call address |
| 4 - 7 | Argument word |
| 8 - 11 | Stack pointer |

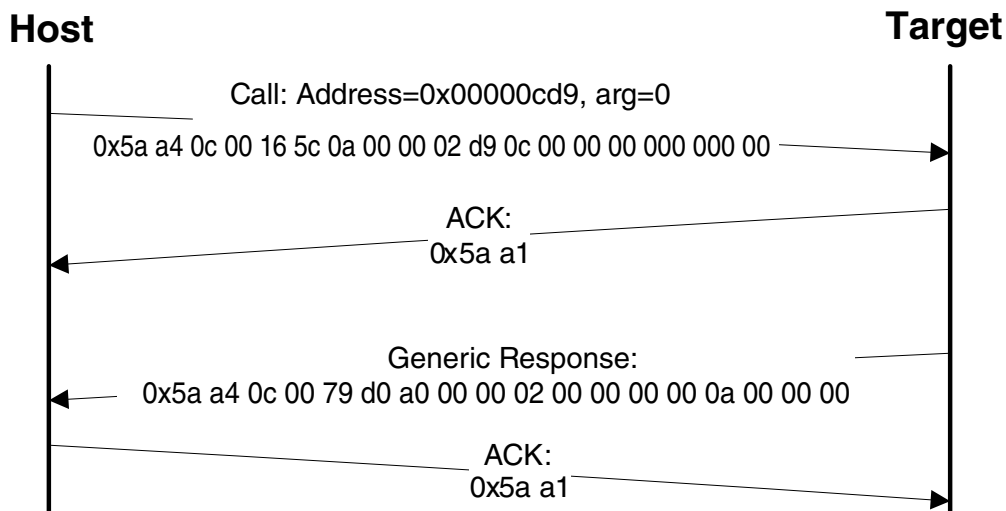

Figure 7-7. Protocol Sequence for Call Command

Response: The target (Kinetis Flashloader) will return a GenericResponse packet with a status code either set to the return value of the function called or set to kStatus_InvalidArgument (105).

7.3.6.2 GetProperty command

The GetProperty command is used to query the flashloader about various properties and settings. Each supported property has a unique 32-bit tag associated with it. The tag occupies the first parameter of the command packet. The target returns a GetPropertyResponse packet with the property values for the property identified with the tag in the GetProperty command.

Properties are the defined units of data that can be accessed with the GetProperty or SetProperty commands. Properties may be read-only or read-write. All read-write properties are 32-bit integers, so they can easily be carried in a command parameter.

For a list of properties and their associated 32-bit property tags supported by the Kinetis Flashloader, see [Table 7-45](#).

The 32-bit property tag is the only parameter required for GetProperty command.

Table 7-18. Parameters for GetProperty Command

| Byte # | Command |
|--------|--------------|
| 0 - 3 | Property tag |

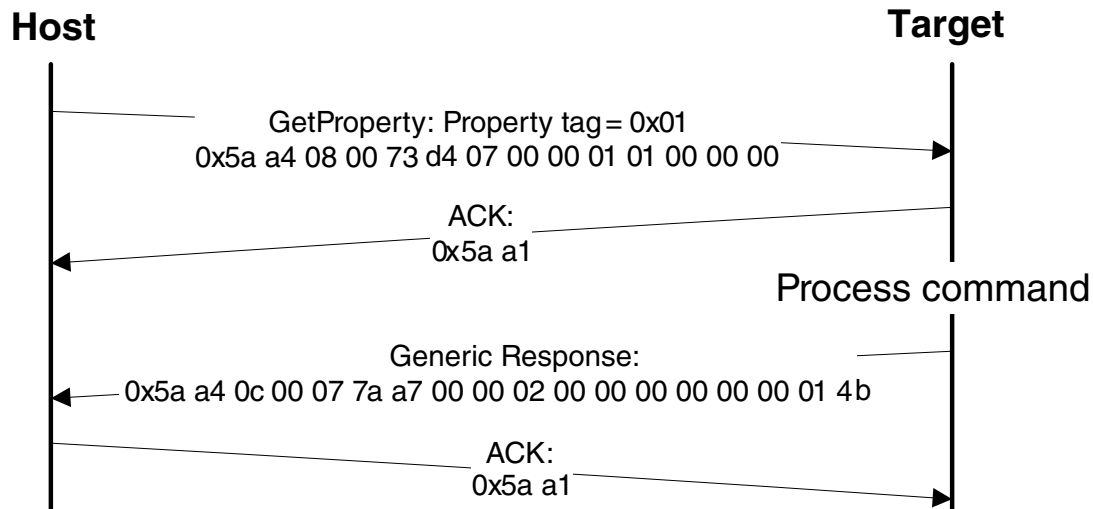
**Figure 7-8. Protocol Sequence for GetProperty Command****Table 7-19. GetProperty Command Packet Format (Example)**

| GetProperty | Parameter | Value |
|----------------|----------------|----------------------------------|
| Framing packet | start byte | 0x5A |
| | packetType | 0xA4, kFramingPacketType_Command |
| | length | 0x08 0x00 |
| | crc16 | 0x73 0xD4 |
| Command packet | commandTag | 0x07 – GetProperty |
| | flags | 0x00 |
| | reserved | 0x00 |
| | parameterCount | 0x01 |
| | propertyTag | 0x00000001 - CurrentVersion |

The GetProperty command has no data phase.

Response: In response to a GetProperty command, the target will send a GetPropertyResponse packet with the response tag set to 0xA7. The parameter count indicates the number of parameters sent for the property values, with the first parameter showing status code 0, followed by the property value(s). The next table shows an example of a GetPropertyResponse packet.

Table 7-20. GetProperty Response Packet Format (Example)

| GetPropertyResponse | Parameter | Value |
|---------------------|----------------|----------------------------------|
| Framing packet | start byte | 0x5A |
| | packetType | 0xA4, kFramingPacketType_Command |
| | length | 0x0c 0x00 (12 bytes) |
| | crc16 | 0x07 0x7a |
| Command packet | responseTag | 0xA7 |
| | flags | 0x00 |
| | reserved | 0x00 |
| | parameterCount | 0x02 |
| | status | 0x00000000 |
| | propertyValue | 0x0000014b - CurrentVersion |

7.3.6.3 SetProperty command

The SetProperty command is used to change or alter the values of the properties or options in the Kinetis Flashloader. However, the SetProperty command can only change the value of properties that are writable—see [Table 7-45](#), Properties used by Get/SetProperty Commands. If you try to set a value for a read-only property, then the Kinetis Flashloader will return an error.

The property tag and the new value to set are the 2 parameters required for the SetProperty command.

Table 7-21. Parameters for SetProperty Command

| Byte # | Command |
|--------|----------------|
| 0 - 3 | Property tag |
| 4 - 7 | Property value |

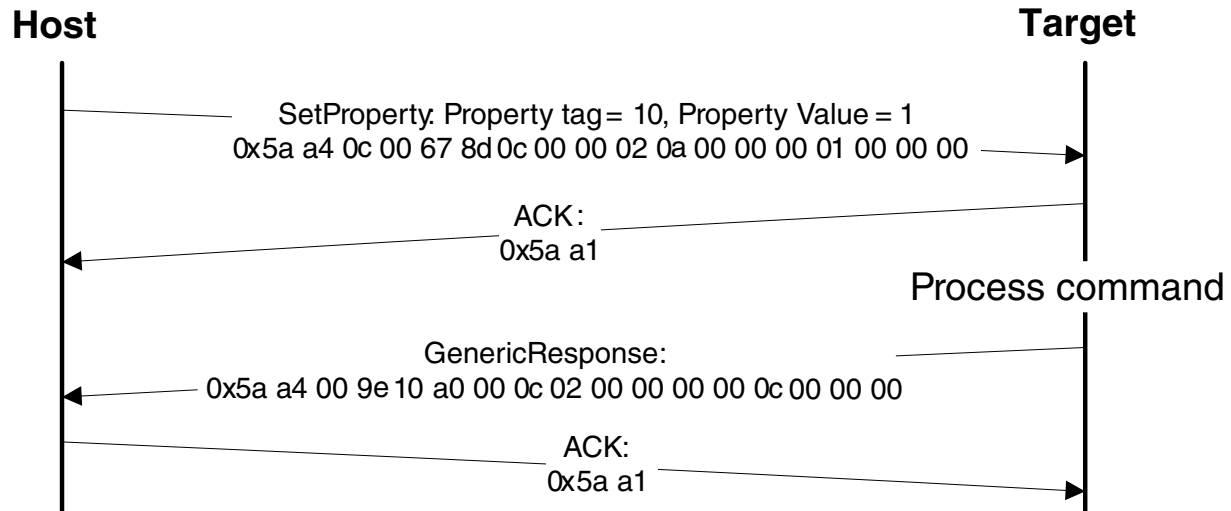

Figure 7-9. Protocol Sequence for SetProperty Command

Table 7-22. SetProperty Command Packet Format (Example)

| SetProperty | Parameter | Value |
|----------------|----------------|---|
| Framing packet | start byte | 0x5A |
| | packetType | 0xA4, kFramingPacketType_Command |
| | length | 0x0C 0x00 |
| | crc16 | 0x67 0x8D |
| Command packet | commandTag | 0x0C – SetProperty with property tag 10 |
| | flags | 0x00 |
| | reserved | 0x00 |
| | parameterCount | 0x02 |
| | propertyTag | 0x0000000A - VerifyWrites |
| | propertyValue | 0x00000001 |

The SetProperty command has no data phase.

Response: The target (Kinetis Flashloader) will return a GenericResponse packet with one of following status codes:

Table 7-23. SetProperty Response Status Codes

| Status Code |
|-------------------------|
| kStatus_Success |
| kStatus_ReadOnly |
| kStatus_UnknownProperty |
| kStatus_InvalidArgument |

7.3.6.4 FlashEraseAll command

The FlashEraseAll command performs an erase of the entire flash memory. If any flash regions are protected, then the FlashEraseAll command will fail and return an error status code. Executing the FlashEraseAll command will release flash security if it (flash security) was enabled, by setting the FTFA_FSEC register. However, the FSEC field of the flash configuration field is erased, so unless it is reprogrammed, the flash security will be re-enabled after the next system reset. The Command tag for FlashEraseAll command is 0x01 set in the commandTag field of the command packet.

The FlashEraseAll command requires 1 parameter: memoryId.

Table 7-24. Parameters for FlashEraseAll command

| Bytes | Parameter |
|-------|--|
| 0 - 3 | MemoryId <ul style="list-style-type: none"> • 0x00 - Internal PFlash • 0x01 - QuadSPI memory |

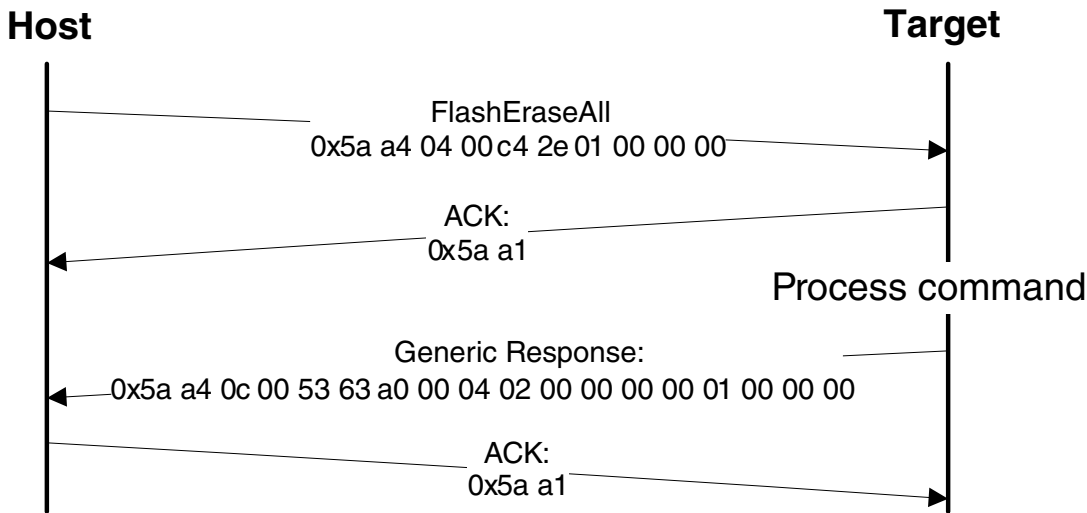

Figure 7-10. Protocol Sequence for FlashEraseAll Command

Table 7-25. FlashEraseAll Command Packet Format (Example)

| FlashEraseAll | Parameter | Value |
|----------------|------------|----------------------------------|
| Framing packet | start byte | 0x5A |
| | packetType | 0xA4, kFramingPacketType_Command |
| | length | 0x04 0x00 |
| | crc16 | 0xC4 0x2E |

Table continues on the next page...

Table 7-25. FlashEraseAll Command Packet Format (Example) (continued)

| FlashEraseAll | Parameter | Value |
|----------------|----------------|--|
| Command packet | commandTag | 0x01 - FlashEraseAll |
| | flags | 0x00 |
| | reserved | 0x00 |
| | parameterCount | 0x00 |
| | MemoryID | <ul style="list-style-type: none"> • If MemoryID = 0x00h, then internal flash. • If MemoryID = 0x01h, then QSPI0 memory. |

The FlashEraseAll command has no data phase.

Response: The target (Kinetis Flashloader) will return a GenericResponse packet with status code either set to kStatus_Success for successful execution of the command, or set to an appropriate error status code.

7.3.6.5 FlashEraseRegion command

The FlashEraseRegion command performs an erase of one or more sectors of the flash memory or a specified range of flash within the connected SPI flash devices.

The start address and number of bytes are the 2 parameters required for the FlashEraseRegion command. The start and byte count parameters must be , or the FlashEraseRegion command will fail and return kStatus_FlashAlignmentError (0x101). If the region specified does not fit in the flash memory space, the FlashEraseRegion command will fail and return kStatus_FlashAddressError (0x102). If any part of the region specified is protected, the FlashEraseRegion command will fail and return kStatus_MemoryRangeInvalid (0x10200).

Table 7-26. Parameters for FlashEraseRegion Command

| Byte # | Parameter |
|--------|---------------|
| 0 - 3 | Start address |
| 4 - 7 | Byte count |

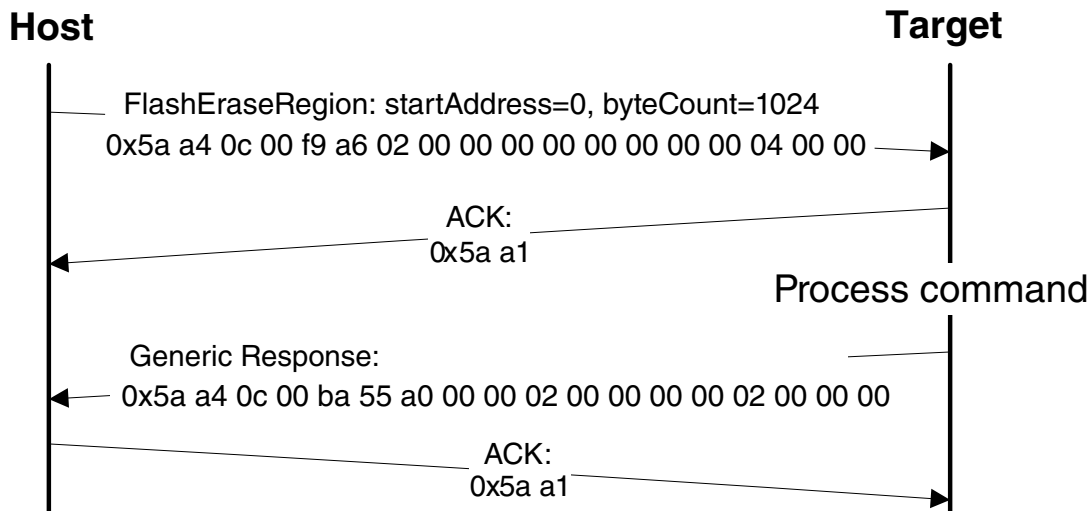

Figure 7-11. Protocol Sequence for FlashEraseRegion Command

Table 7-27. FlashEraseRegion Command Packet Format (Example)

| FlashEraseRegion | Parameter | Value |
|------------------|----------------|------------------------------------|
| Framing packet | start byte | 0x5A |
| | packetType | 0xA4, kFramingPacketType_Command |
| | length | 0x0C 0x00 |
| | crc16 | 0xF9 0x A6 |
| Command packet | commandTag | 0x02, kCommandTag_FlashEraseRegion |
| | flags | 0x00 |
| | reserved | 0x00 |
| | parameterCount | 0x02 |
| | startAddress | 0x00 0x00 0x00 0x00 (0x0000_0000) |
| | byte count | 0x00 0x04 0x00 0x00 (0x400) |

The FlashEraseRegion command has no data phase.

Response: The target (Kinetis Flashloader) will return a GenericResponse packet with one of following error status codes.

Table 7-28. FlashEraseRegion Response Status Codes

| Status Code |
|--|
| kStatus_Success (0x0) |
| kStatus_MemoryRangeInvalid (0x10200) |
| kStatus_FlashAlignmentError (0x101) |
| kStatus_FlashAddressError (0x102) |
| kStatus_FlashAccessError (0x103) |
| kStatus_FlashProtectionViolation (0x104) |
| kStatus_FlashCommandFailure (0x105) |

7.3.6.6 FlashEraseAllUnsecure command

The FlashEraseAllUnsecure command performs a mass erase of the flash memory, including protected sectors. Flash security is immediately disabled if it (flash security) was enabled, and the FSEC byte in the flash configuration field at address 0x40C is programmed to 0xFE. However, if the mass erase enable option in the FSEC field is disabled, then the FlashEraseAllUnsecure command will fail.

The FlashEraseAllUnsecure command requires no parameters.

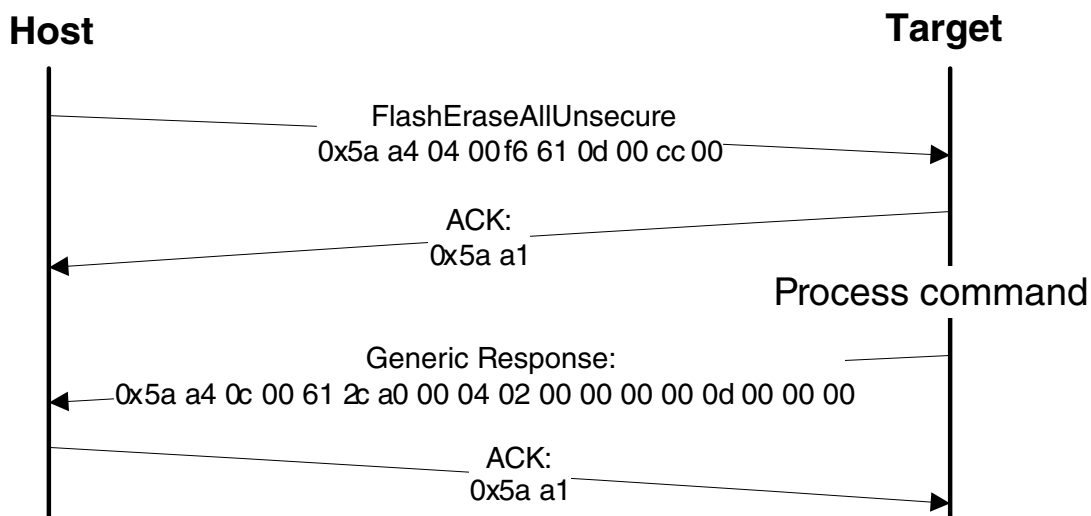

Figure 7-12. Protocol Sequence for FlashEraseAll Command

Table 7-29. FlashEraseAllUnsecure Command Packet Format (Example)

| FlashEraseAllUnsecure | Parameter | Value |
|-----------------------|----------------|----------------------------------|
| Framing packet | start byte | 0x5A |
| | packetType | 0xA4, kFramingPacketType_Command |
| | length | 0x04 0x00 |
| | crc16 | 0xF6 0x61 |
| Command packet | commandTag | 0x0D - FlashEraseAllUnsecure |
| | flags | 0x00 |
| | reserved | 0x00 |
| | parameterCount | 0x00 |

The FlashEraseAllUnsecure command has no data phase.

Response: The target (Kinetis Flashloader) will return a GenericResponse packet with status code either set to kStatus_Success for successful execution of the command, or set to an appropriate error status code.

7.3.6.7 FillMemory command

The FillMemory command fills a range of bytes in memory with a data pattern. It follows the same rules as the WriteMemory command. The difference between FillMemory and WriteMemory is that a data pattern is included in FillMemory command parameter, and there is no data phase for the FillMemory command, while WriteMemory does have a data phase.

Table 7-30. Parameters for FillMemory Command

| Byte # | Command |
|--------|---|
| 0 - 3 | Start address of memory to fill |
| 4 - 7 | Number of bytes to write with the pattern <ul style="list-style-type: none"> The start address should be 32-bit aligned. The number of bytes must be evenly divisible by 4. |
| 8 - 11 | 32-bit pattern |

- To fill with a byte pattern (8-bit), the byte must be replicated 4 times in the 32-bit pattern.
- To fill with a short pattern (16-bit), the short value must be replicated 2 times in the 32-bit pattern.

For example, to fill a byte value with 0xFE, the word pattern would be 0xFEFEFEFE; to fill a short value 0x5AFE, the word pattern would be 0x5AFE5AFE.

Special care must be taken when writing to flash.

- First, any flash sector written to must have been previously erased with a FlashEraseAll or FlashEraseRegion command.
- Writing to flash requires the start address to be 8-byte aligned ([2:0] = 000) .
- If the VerifyWrites property is set to true, then writes to flash will also perform a flash verify program operation.

When writing to RAM, the start address need not be aligned, and the data will not be padded.

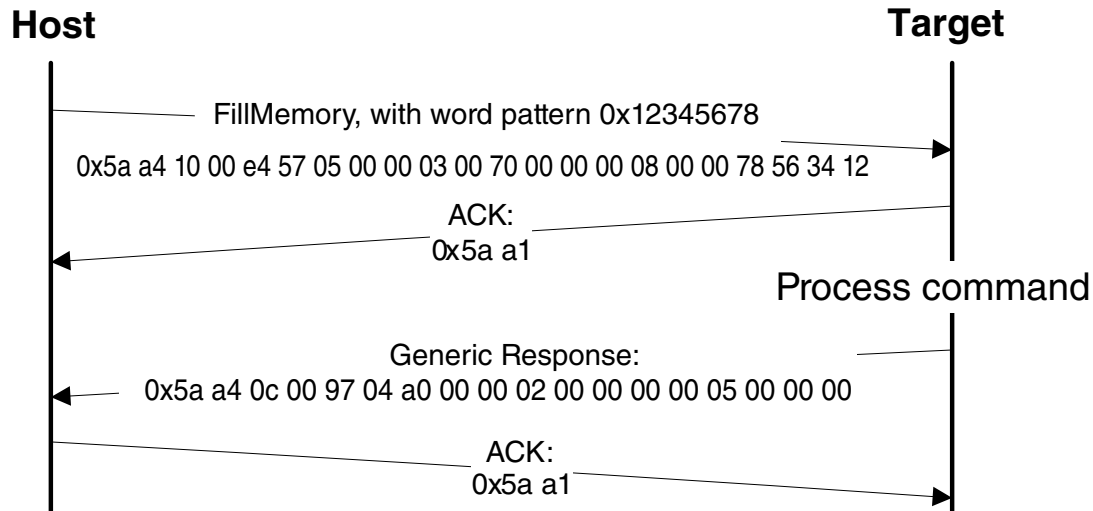

Figure 7-13. Protocol Sequence for FillMemory Command

Table 7-31. FillMemory Command Packet Format (Example)

| FillMemory | Parameter | Value |
|----------------|----------------|----------------------------------|
| Framing packet | start byte | 0x5A |
| | packetType | 0xA4, kFramingPacketType_Command |
| | length | 0x10 0x00 |
| | crc16 | 0xE4 0x57 |
| Command packet | commandTag | 0x05 – FillMemory |
| | flags | 0x00 |
| | Reserved | 0x00 |
| | parameterCount | 0x03 |
| | startAddress | 0x00007000 |
| | byteCount | 0x00000800 |
| | patternWord | 0x12345678 |

The FillMemory command has no data phase.

Response: upon successful execution of the command, the target (Kinetis Flashloader) will return a GenericResponse packet with a status code set to kStatus_Success, or to an appropriate error status code.

7.3.6.8 FlashProgramOnce command

The FlashProgramOnce command writes data (that is provided in a command packet) to a specified range of bytes in the program once field. Special care must be taken when writing to the program once field.

Functional Description

- The program once field only supports programming once, so any attempted to reprogram a program once field will get an error response.
- Writing to the program once field requires the byte count to be 4-byte aligned or 8-byte aligned.

The FlashProgramOnce command uses 3 parameters: index, byteCount, data.

Table 7-32. Parameters for FlashProgramOnce Command

| Byte # | Command |
|---------|--|
| 0 - 3 | Index of program once field |
| 4 - 7 | Byte count (must be evenly divisible by 4) |
| 8 - 11 | Data |
| 12 - 16 | Data |

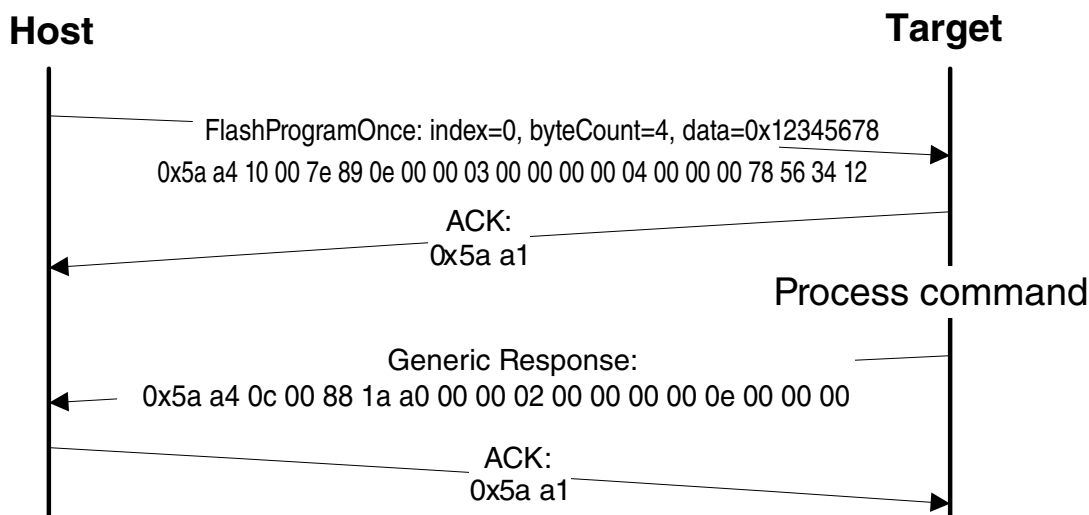

Figure 7-14. Protocol Sequence for FlashProgramOnce Command

Table 7-33. FlashProgramOnce Command Packet Format (Example)

| FlashProgramOnce | Parameter | Value |
|------------------|----------------|----------------------------------|
| Framing packet | start byte | 0x5A |
| | packetType | 0xA4, kFramingPacketType_Command |
| | length | 0x10 0x00 |
| | crc16 | 0x7E4 0x89 |
| Command packet | commandTag | 0x0E – FlashProgramOnce |
| | flags | 0 |
| | reserved | 0 |
| | parameterCount | 3 |
| | index | 0x0000_0000 |

Table continues on the next page...

Table 7-33. FlashProgramOnce Command Packet Format (Example) (continued)

| FlashProgramOnce | Parameter | Value |
|------------------|-----------|-------------|
| | byteCount | 0x0000_0004 |
| | data | 0x1234_5678 |

Response: upon successful execution of the command, the target (Kinetis Flashloader) will return a GenericResponse packet with a status code set to kStatus_Success, or to an appropriate error status code.

7.3.6.9 FlashReadOnce command

The FlashReadOnce command returns the contents of the program once field by given index and byte count. The FlashReadOnce command uses 2 parameters: index and byteCount.

Table 7-34. Parameters for FlashReadOnce Command

| Byte # | Parameter | Description |
|--------|-----------|--|
| 0 - 3 | index | Index of the program once field (to read from) |
| 4 - 7 | byteCount | Number of bytes to read and return to the caller |

**Figure 7-15. Protocol Sequence for FlashReadOnce Command**

Table 7-35. FlashReadOnce Command Packet Format (Example)

| FlashReadOnce | Parameter | Value |
|----------------|----------------|----------------------|
| Framing packet | start byte | 0x5A |
| | packetType | 0xA4 |
| | length | 0x0C 0x00 |
| | crc | 0xC1 0xA5 |
| Command packet | commandTag | 0x0F – FlashReadOnce |
| | flags | 0x00 |
| | reserved | 0x00 |
| | parameterCount | 0x02 |
| | index | 0x0000_0000 |
| | byteCount | 0x0000_0004 |

Table 7-36. FlashReadOnce Response Format (Example)

| FlashReadOnce Response | Parameter | Value |
|------------------------|----------------|-------------|
| Framing packet | start byte | 0x5A |
| | packetType | 0xA4 |
| | length | 0x10 0x00 |
| | crc | 0x3F 0x6F |
| Command packet | commandTag | 0xAF |
| | flags | 0x00 |
| | reserved | 0x00 |
| | parameterCount | 0x03 |
| | status | 0x0000_0000 |
| | byteCount | 0x0000_0004 |
| | data | 0x1234_5678 |

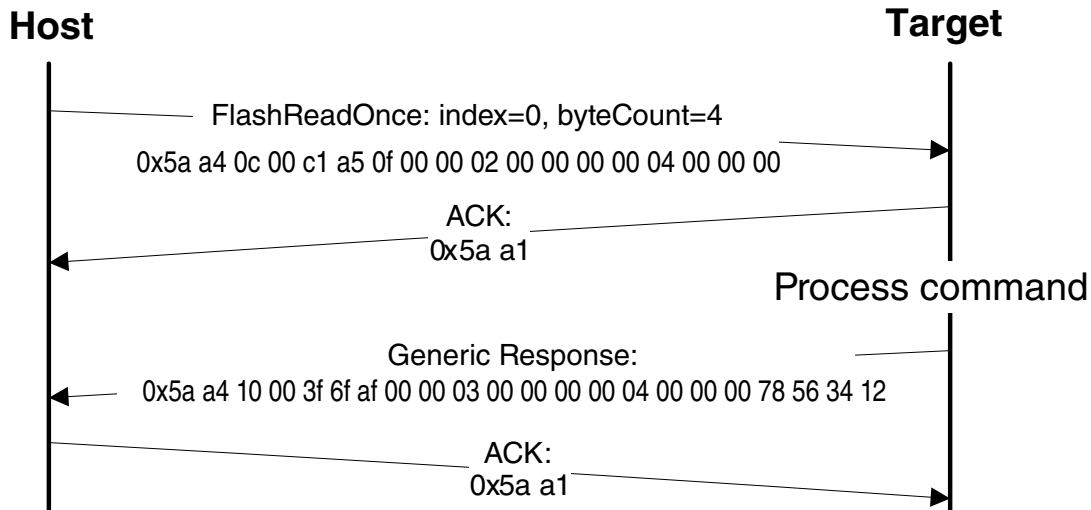
Response: upon successful execution of the command, the target (Kinetis Flashloader) will return a FlashReadOnceResponse packet with a status code set to kStatus_Success, a byte count and corresponding data read from Program Once Field upon successful execution of the command, or will return with a status code set to an appropriate error status code and a byte count set to 0.

7.3.6.10 FlashReadResource command

The FlashReadResource command returns the contents of the IFR field or Flash Version ID, by given offset, byte count, and option. The FlashReadResource command uses 3 parameters: start address, byteCount, option.

Table 7-37. Parameters for FlashReadResource Command

| Byte # | Parameter | Command |
|--------|---------------|--|
| 0 - 3 | start address | Start address of specific non-volatile memory to be read |
| 4 - 7 | byteCount | Byte count to be read |
| 8 - 11 | option | 0: IFR 1: Flash Version ID |

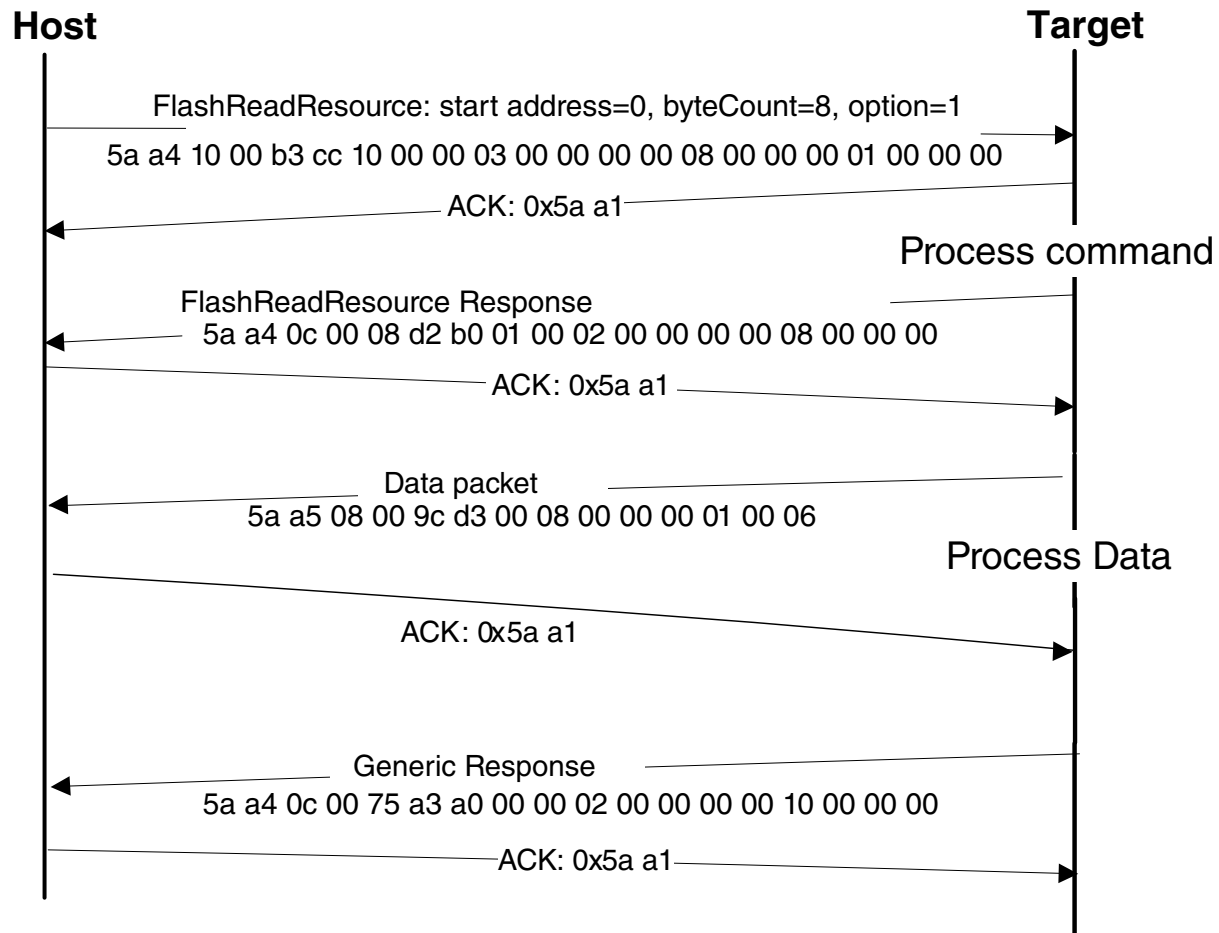
**Figure 7-16. Protocol Sequence for FlashReadResource Command****Table 7-38. FlashReadResource Command Packet Format (Example)**

| FlashReadResource | Parameter | Value |
|-------------------|------------|--------------------------|
| Framing packet | start byte | 0x5A |
| | packetType | 0xA4 |
| | length | 0x10 0x00 |
| | crc | 0xB3 0xCC |
| Command packet | commandTag | 0x10 – FlashReadResource |
| | flags | 0x00 |

Table continues on the next page...

Table 7-38. FlashReadResource Command Packet Format (Example) (continued)

| FlashReadResource | Parameter | Value |
|-------------------|----------------|-------------|
| | reserved | 0x00 |
| | parameterCount | 0x03 |
| | startAddress | 0x0000_0000 |
| | byteCount | 0x0000_0008 |
| | option | 0x0000_0001 |

Table 7-39. FlashReadResource Response Format (Example)

| FlashReadResource Response | Parameter | Value |
|----------------------------|----------------|-------------|
| Framing packet | start byte | 0x5A |
| | packetType | 0xA4 |
| | length | 0x0C 0x00 |
| | crc | 0xD2 0xB0 |
| Command packet | commandTag | 0xB0 |
| | flags | 0x01 |
| | reserved | 0x00 |
| | parameterCount | 0x02 |
| | status | 0x0000_0000 |
| | byteCount | 0x0000_0008 |

Data phase: The FlashReadResource command has a data phase. Because the target (Kinetis Flashloader) works in slave mode, the host must pull data packets until the number of bytes of data *specified in the byteCount parameter of FlashReadResource command* are received by the host.

7.3.6.11 WriteMemory command

The WriteMemory command writes data provided in the data phase to a specified range of bytes in memory (flash or RAM). However, if flash protection is enabled, then writes to protected sectors will fail.

Special care must be taken when writing to flash.

- First, any flash sector written to must have been previously erased with a FlashEraseAll or FlashEraseRegion command.
- Writing to flash requires the start address to be 8-byte aligned ([2:0] = 000).
- If the VerifyWrites property is set to true, then writes to flash will also perform a flash verify program operation.

When writing to RAM, the start address need not be aligned, and the data will not be padded.

The start address and number of bytes are the 2 parameters required for WriteMemory command.

Table 7-40. Parameters for WriteMemory Command

| Byte # | Command |
|--------|---------------|
| 0 - 3 | Start address |
| 4 - 7 | Byte count |

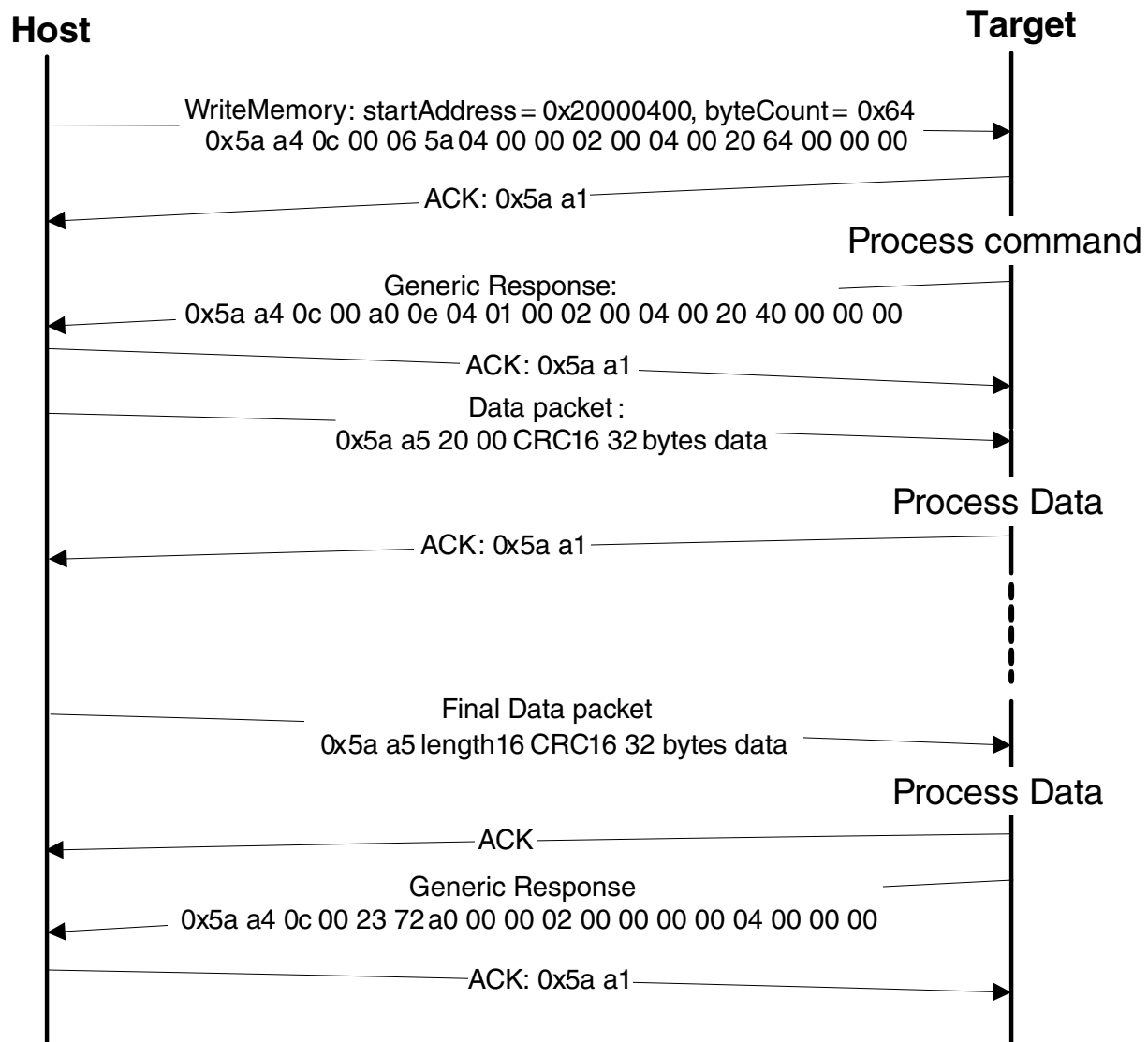

Figure 7-17. Protocol Sequence for WriteMemory Command

Table 7-41. WriteMemory Command Packet Format (Example)

| WriteMemory | Parameter | Value |
|----------------|----------------|----------------------------------|
| Framing packet | start byte | 0x5A |
| | packetType | 0xA4, kFramingPacketType_Command |
| | length | 0x0C 0x00 |
| | crc16 | 0x06 0x5A |
| Command packet | commandTag | 0x04 - writeMemory |
| | flags | 0x00 |
| | reserved | 0x00 |
| | parameterCount | 0x02 |
| | startAddress | 0x20000400 |
| | byteCount | 0x00000064 |

Data Phase: The WriteMemory command has a data phase; the host will send data packets until the number of bytes of data specified in the byteCount parameter of the WriteMemory command are received by the target.

Response: The target (Kinetis Flashloader) will return a GenericResponse packet with a status code set to kStatus_Success upon successful execution of the command, or to an appropriate error status code.

7.3.6.12 Read memory command

The ReadMemory command returns the contents of memory at the given address, for a specified number of bytes. This command can read any region of memory accessible by the CPU and not protected by security.

The start address and number of bytes are the 2 parameters required for ReadMemory command.

Table 7-42. Parameters for read memory command

| Byte | Parameter | Description |
|------|---------------|--|
| 0-3 | Start address | Start address of memory to read from |
| 4-7 | Byte count | Number of bytes to read and return to caller |

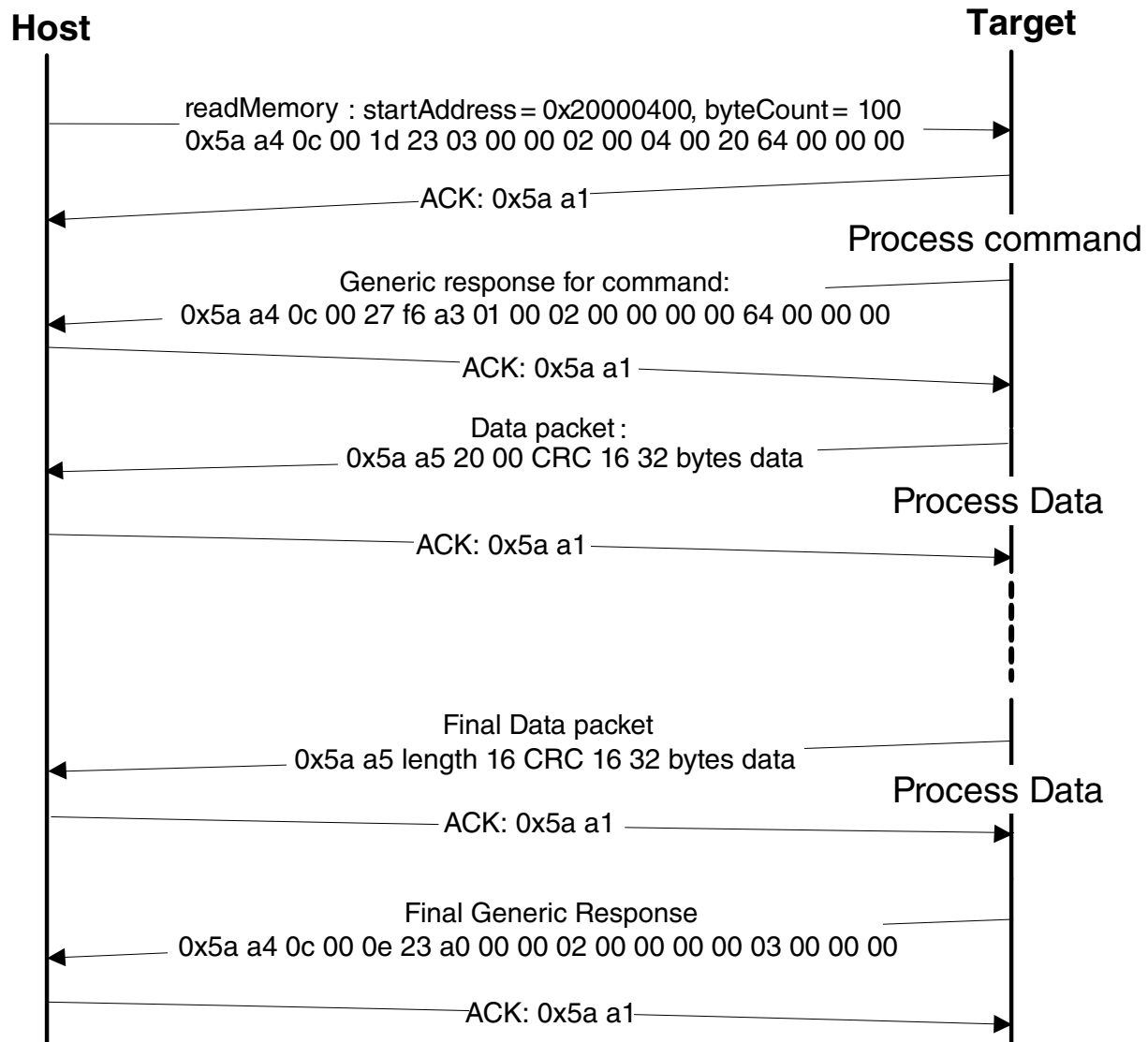

Figure 7-18. Command sequence for read memory

| ReadMemory | Parameter | Value |
|----------------|----------------|----------------------------|
| Framing packet | Start byte | 0x5A0xA4, |
| | packetType | kFramingPacketType_Command |
| | length | 0x0C 0x00 |
| | crc16 | 0x1D 0x23 |
| Command packet | commandTag | 0x03 - readMemory |
| | flags | 0x00 |
| | reserved | 0x00 |
| | parameterCount | 0x02 |
| | startAddress | 0x20000400 |
| | byteCount | 0x00000064 |

Data Phase: The ReadMemory command has a data phase. Since the target (Kinetis Flashloader) works in slave mode, the host need pull data packets until the number of bytes of data specified in the byteCount parameter of ReadMemory command are received by host.

Response: The target (Kinetis Flashloader) will return a GenericResponse packet with a status code either set to kStatus_Success upon successful execution of the command, or set to an appropriate error status code.

7.3.6.13 Execute command

The execute command results in the flashloader setting the program counter to the code at the provided jump address, R0 to the provided argument, and a Stack pointer to the provided stack pointer address. Prior to the jump, the system is returned to the reset state.

The Jump address, function argument pointer, and stack pointer are the parameters required for the Execute command.

Table 7-43. Parameters for Execute Command

| Byte # | Command |
|--------|-----------------------|
| 0 - 3 | Jump address |
| 4 - 7 | Argument word |
| 8 - 11 | Stack pointer address |

The Execute command has no data phase.

Response: Before executing the Execute command, the target (Kinetis Flashloader) will validate the parameters and return a GenericResponse packet with a status code either set to kStatus_Success or an appropriate error status code.

7.3.6.14 Reset command

The Reset command will result in flashloader resetting the chip.

The Reset command requires no parameters.

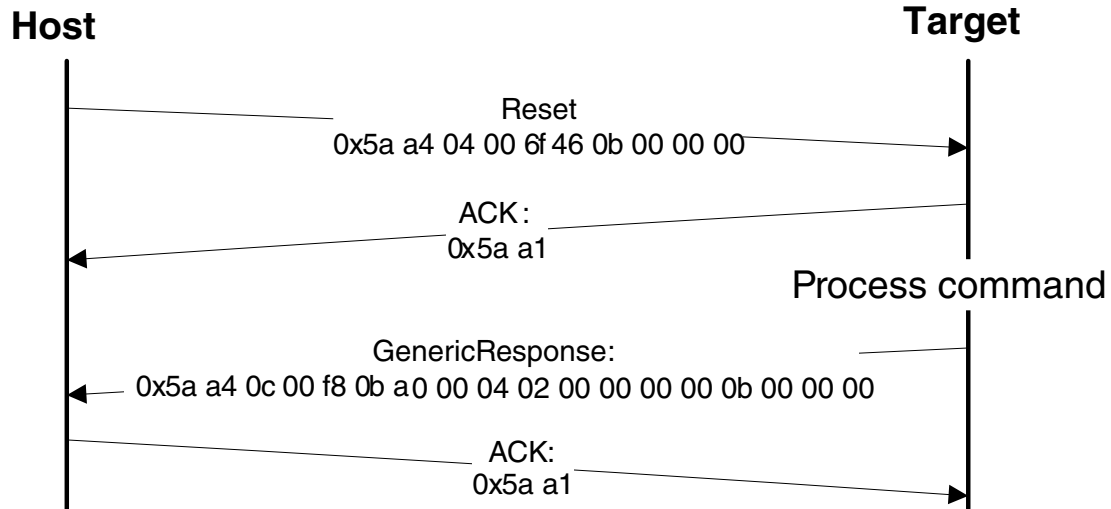

Figure 7-19. Protocol Sequence for Reset Command

Table 7-44. Reset Command Packet Format (Example)

| Reset | Parameter | Value |
|----------------|----------------|----------------------------------|
| Framing packet | start byte | 0x5A |
| | packetType | 0xA4, kFramingPacketType_Command |
| | length | 0x04 0x00 |
| | crc16 | 0x6F 0x46 |
| Command packet | commandTag | 0x0B - reset |
| | flags | 0x00 |
| | reserved | 0x00 |
| | parameterCount | 0x00 |

The Reset command has no data phase.

Response: The target (Kinetis Flashloader) will return a GenericResponse packet with status code set to kStatus_Success, before resetting the chip.

7.4 Peripherals Supported

This section describes the peripherals supported by the Kinetis Flashloader.

7.4.1 I2C Peripheral

The Kinetis Flashloader supports loading data into flash via the I2C peripheral, where the I2C peripheral serves as the I2C slave. A 7-bit slave address is used during the transfer.

The Kinetis Flashloader uses 0x10 as the I2C slave address, and supports 400 kbps as the I2C baud rate.

Because the I2C peripheral serves as an I2C slave device, each transfer should be started by the host, and each outgoing packet should be fetched by the host.

- An incoming packet is sent by the host with a selected I2C slave address and the direction bit is set as write.
- An outgoing packet is read by the host with a selected I2C slave address and the direction bit is set as read.
- 0x00 will be sent as the response to host if the target is busy with processing or preparing data.

The following flow charts demonstrate the communication flow of how the host reads ping packet, ACK and response from the target.

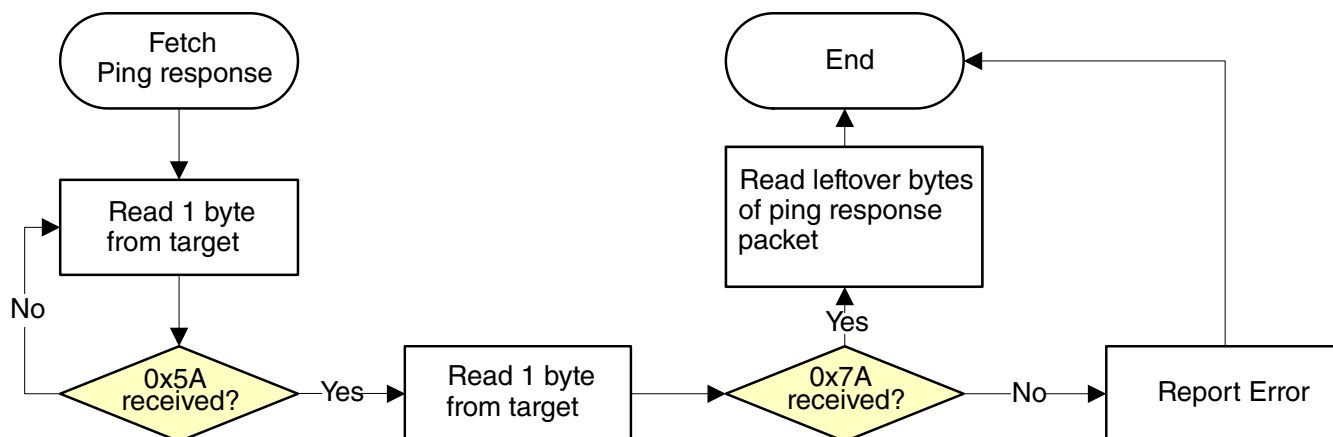

Figure 7-20. Host reads ping response from target via I2C

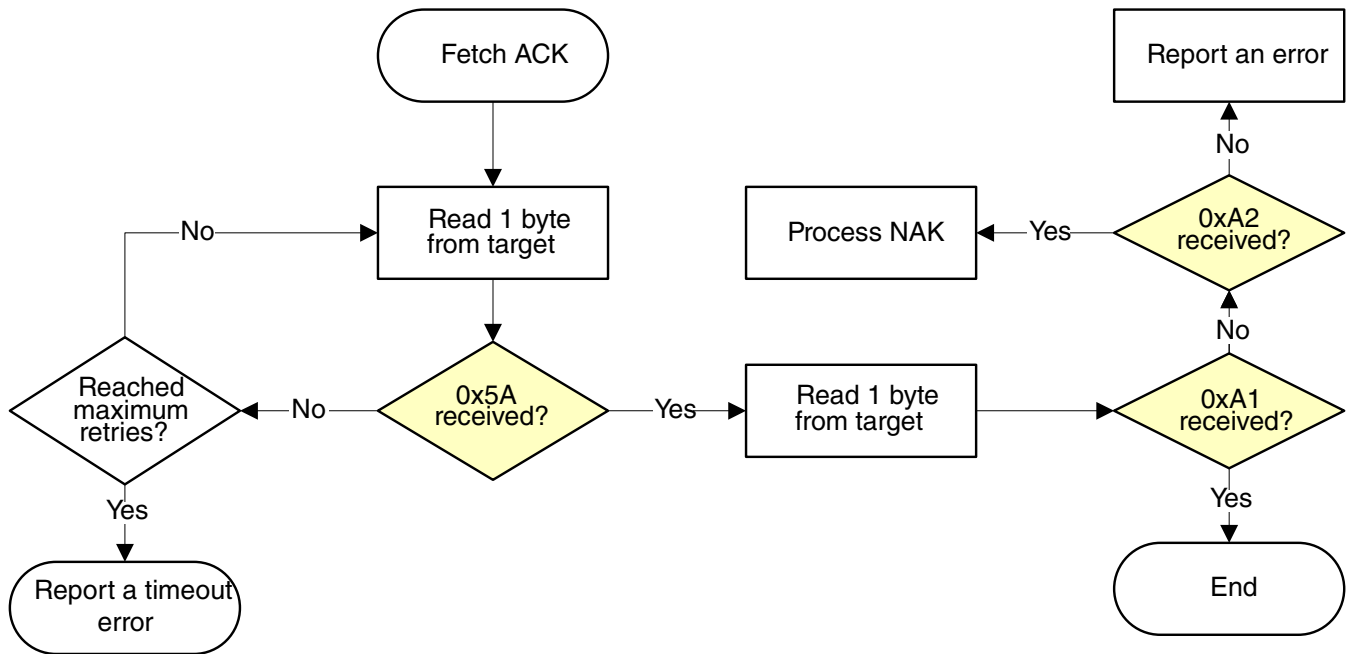

Figure 7-21. Host reads ACK packet from target via I2C

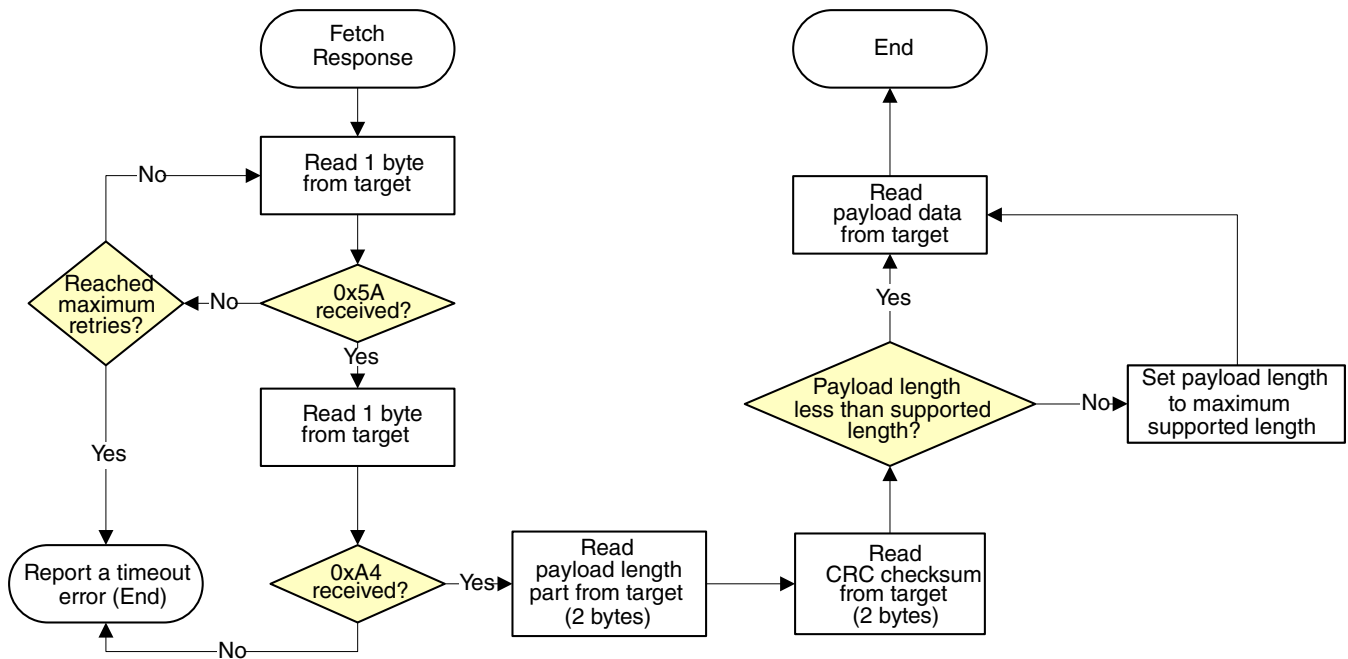

Figure 7-22. Host reads response from target via I2C

7.4.2 SPI Peripheral

The Kinetis Flashloader supports loading data into flash via the SPI peripheral, where the SPI peripheral serves as a SPI slave.

The Kinetis Flashloader supports 400 kbps as the SPI baud rate.

The SPI peripheral uses the following bus attributes:

- Clock Phase = 1 (Second Edge)
- Clock Polarity = 1 (Active Low)

Because the SPI peripheral serves as a SPI slave device, each transfer should be started by the host, and each outgoing packet should be fetched by the host.

The transfer on SPI is slightly different from I2C:

- Host will receive 1 byte after it sends out any byte.
- Received bytes should be ignored when host is sending out bytes to target
- Host starts reading bytes by sending 0x00s to target
- The byte 0x00 will be sent as response to host if target is under the following conditions:
 - Processing incoming packet
 - Preparing outgoing data
 - Received invalid data

The SPI bus configuration is:

- Phase = 1; data is sampled on rising edges
- Polarity = 1; idle is high
- MSB is transmitted first

For any transfer where the target does not have actual data to send, the target (slave) is responsible for ensuring that 0x00 bytes will be returned to the host (master). The host uses framing packets to identify real data and not "dummy" 0x00 bytes (which do not have framing packets).

The following flowcharts demonstrate how the host reads a ping response, an ACK and a command response from target via SPI.

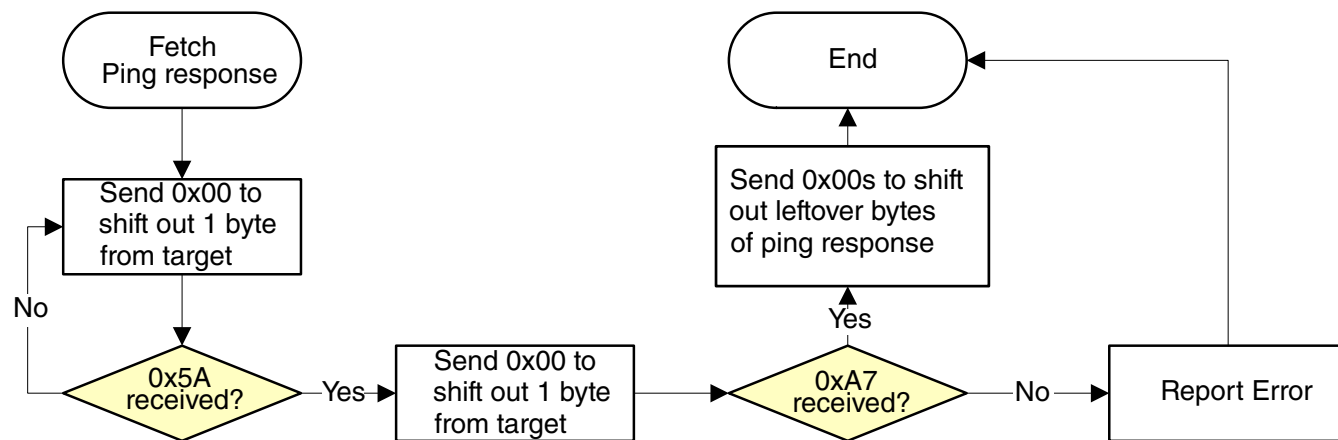

Figure 7-23. Host reads ping packet from target via SPI

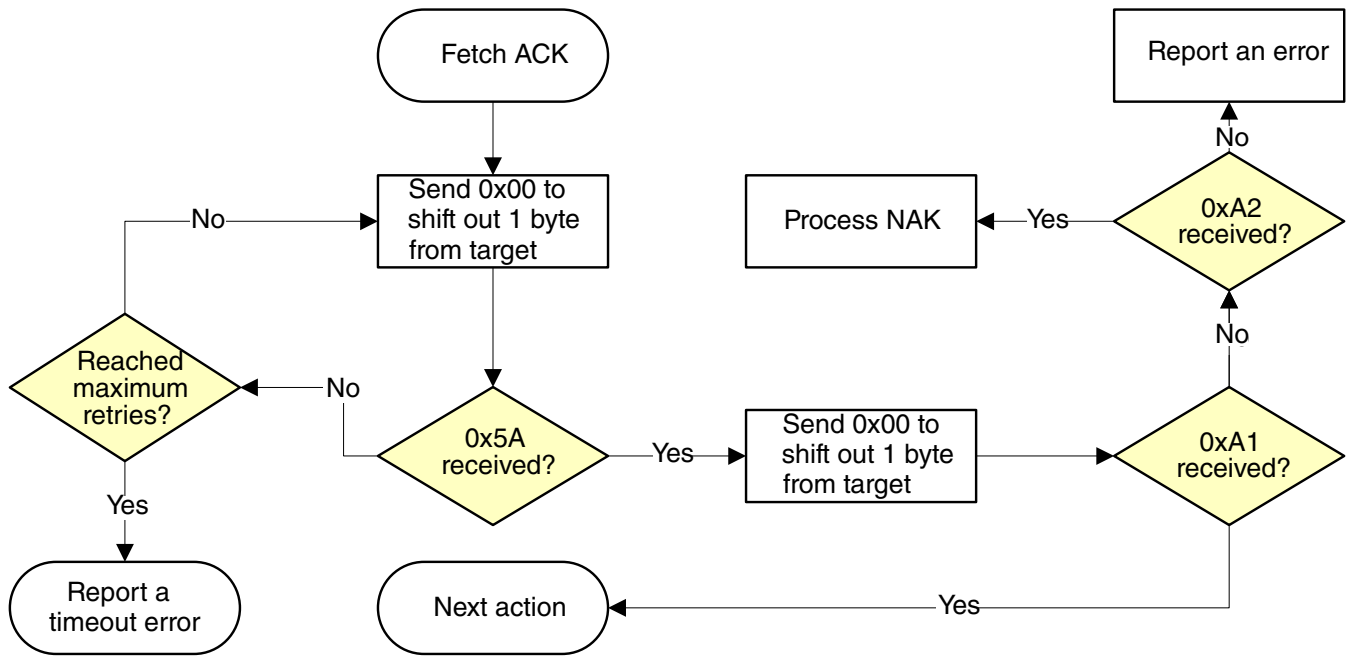

Figure 7-24. Host reads ACK from target via SPI

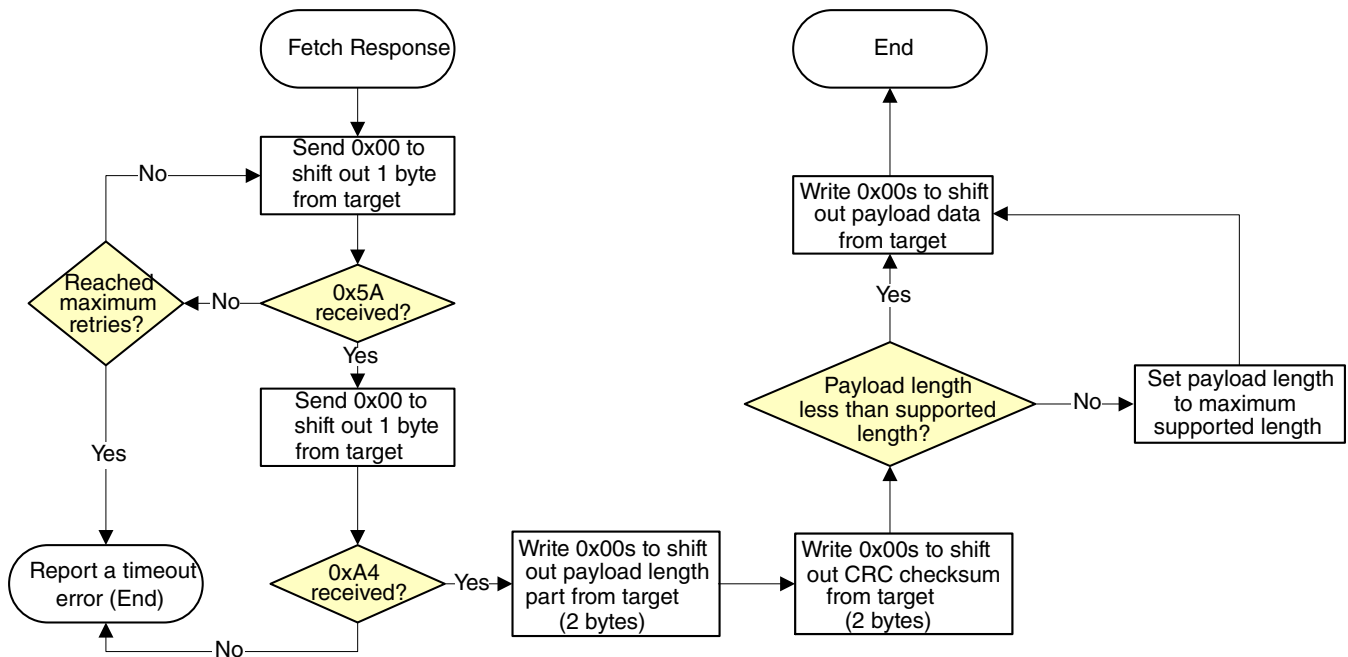

Figure 7-25. Host reads response from target via SPI

7.4.3 LPUART Peripheral

The Kinetis Flashloader integrates an autobaud detection algorithm for the LPUART peripheral, thereby providing flexible baud rate choices.

Autobaud feature: If LPUART n is used to connect to the flashloader, then the LPUART n _RX pin must be kept high and not left floating during the detection phase in order to comply with the autobaud detection algorithm. After the flashloader detects the ping packet (0x5A 0xA6) on LPUART n _RX, the flashloader firmware executes the autobaud sequence. If the baudrate is successfully detected, then the flashloader will send a ping packet response [(0x5A 0xA7), protocol version (4 bytes), protocol version options (2 bytes) and crc16 (2 bytes)] at the detected baudrate. The Kinetis Flashloader then enters a loop, waiting for flashloader commands via the LPUART peripheral.

NOTE

- The autobaud feature requires a ping packet with a higher accuracy (+/-3%), or the ping packet will be ignored as noise.
- The data bytes of the ping packet must be sent continuously (with no more than 80 ms between bytes) in a fixed LPUART transmission mode (8-bit data, no parity bit and 1 stop bit). If the bytes of the ping packet are sent one-by-one with more than 80 ms delay between them, then the autobaud detection algorithm may calculate an incorrect baud rate. In this case, the autobaud detection state machine should be reset.

Supported baud rates: The baud rate is closely related to the MCU core and system clock frequencies. Typical baud rates supported are 9600, 19200, 38400, 57600, and 115200.

Packet transfer: After autobaud detection succeeds, flashloader communications can take place over the LPUART peripheral. The following flow charts show:

- How the host detects an ACK from the target
- How the host detects a ping response from the target
- How the host detects a command response from the target

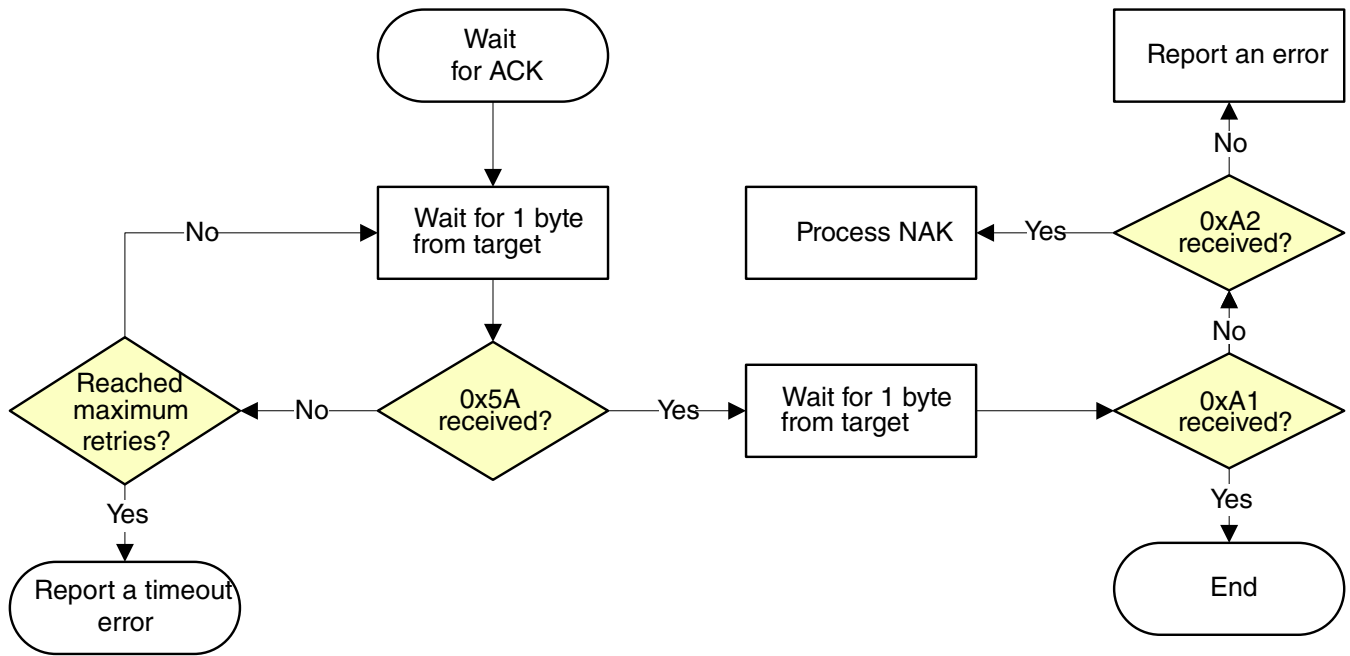

Figure 7-26. Host reads an ACK from target via LPUART

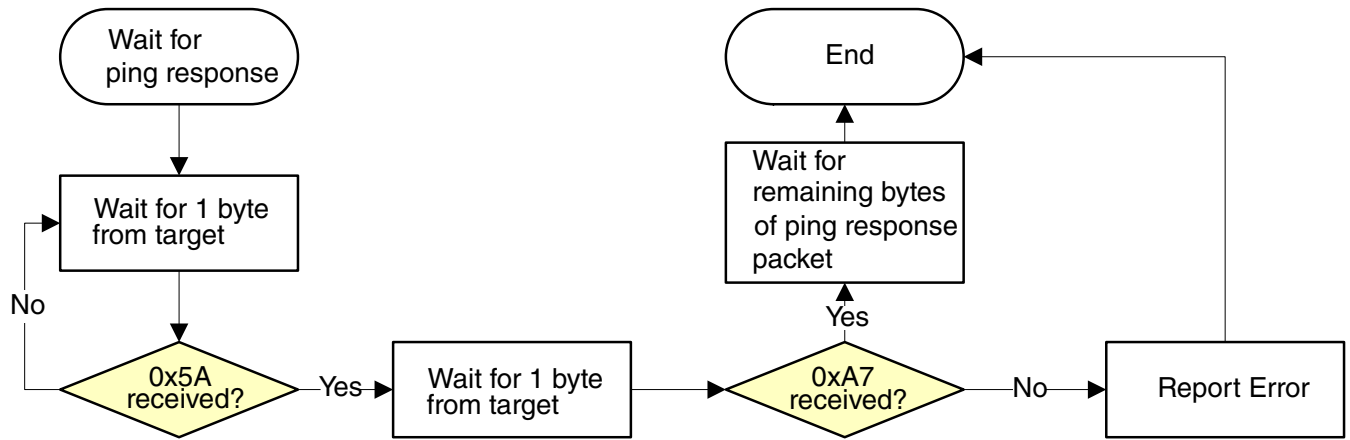

Figure 7-27. Host reads a ping response from target via LPUART

Get/SetProperty Command Properties

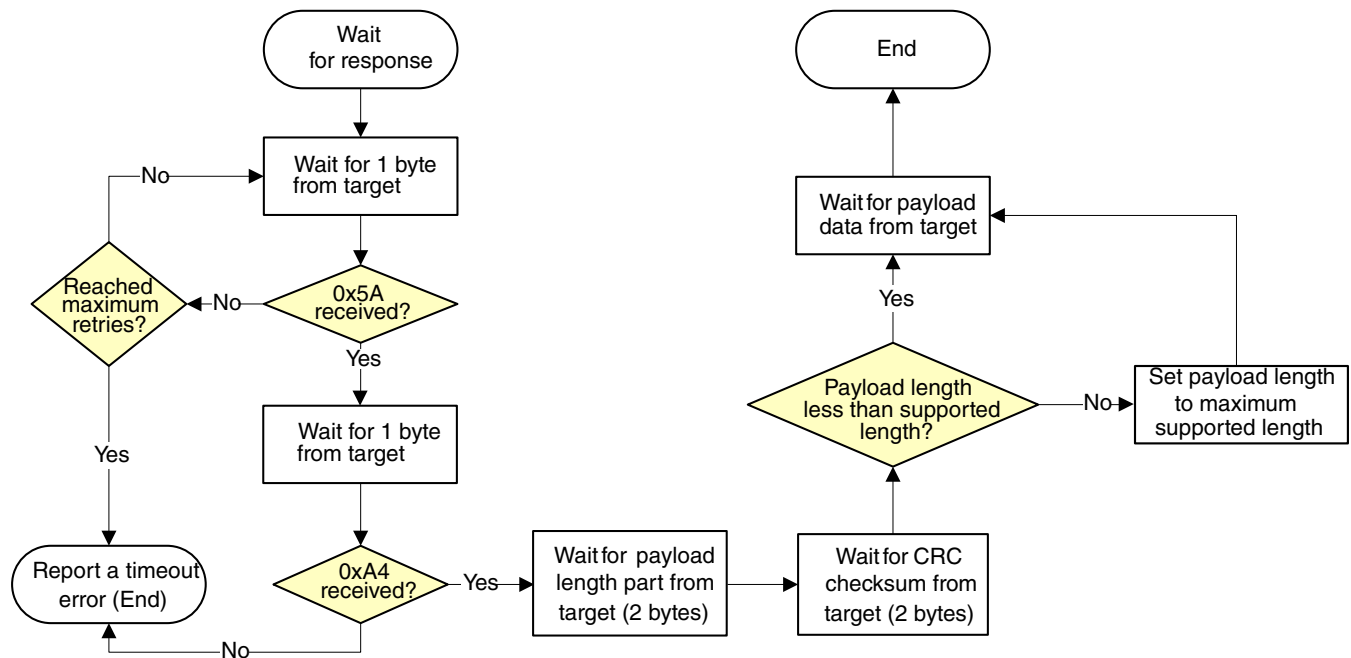

Figure 7-28. Host reads a command response from target via LPUART

7.5 Get/SetProperty Command Properties

This section lists the properties of the GetProperty and SetProperty commands.

Table 7-45. Properties used by Get/SetProperty Commands, sorted by Value

| Property | Writable | Tag Value | Size | Description |
|--------------------------------------|----------|-----------|------|---|
| CurrentVersion | No | 01h | 4 | Current flashloader version. |
| AvailablePeripherals | No | 02h | 4 | The set of peripherals supported on this chip. |
| FlashStartAddress | No | 03h | 4 | Start address of program flash. |
| FlashSizeInBytes | No | 04h | 4 | Size in bytes of program flash. |
| FlashSectorSize | No | 05h | 4 | The size in bytes of one sector of program flash. This is the minimum erase size. |
| FlashBlockCount | No | 06h | 4 | Number of blocks in the flash array. |
| AvailableCommands | No | 07h | 4 | The set of commands supported by the flashloader. |
| VerifyWrites | Yes | 0Ah | 4 | Controls whether the flashloader will verify writes to flash. VerifyWrites feature is enabled by default. 0 - No verification is done. 1 - Enable verification. |
| MaxPacketSize | No | 0Bh | 4 | Maximum supported packet size for the currently active peripheral interface. |

Table continues on the next page...

Table 7-45. Properties used by Get/SetProperty Commands, sorted by Value (continued)

| Property | Writable | Tag Value | Size | Description |
|-------------------------|----------|-----------|------|--|
| ReservedRegions | No | 0Ch | 16 | List of memory regions reserved by the flashloader. Returned as value pairs (<start-address-of-region>, <end-address-of-region>). <ul style="list-style-type: none"> If HasDataPhase flag is not set, then the Response packet parameter count indicates the number of pairs. If HasDataPhase flag is set, then the second parameter is the number of bytes in the data phase. |
| RAMStartAddress | No | 0Eh | 4 | Start address of RAM segment. The first parameter to GetProperty command identifies the segment. See the device specific memory map for number of RAM segments the device contains. |
| RAMSizeInBytes | No | 0Fh | 4 | Size in bytes of RAM segment. The first parameter to GetProperty command identifies the segment. See the device specific memory map for number of RAM segments the device contains. |
| SystemDeviceId | No | 10h | 4 | Value of the Kinetis System Device Identification register. |
| FlashSecurityState | No | 11h | 4 | Indicates whether Flash security is enabled 0 - Flash security is disabled 1 - Flash security is enabled |
| UniqueDeviceId | No | 12h | 16 | Unique device identification, value of Kinetis Unique Identification registers (16 for K series devices, 12 for KL series devices) |
| FacSupport | No | 13h | 4 | FAC (Flash Access Control) support flag 0 - FAC not supported 1 - FAC supported |
| FlashAccessSegmentSize | No | 14h | 4 | The size in bytes of 1 segment of flash |
| FlashAccessSegmentCount | No | 15h | 4 | FAC segment count (The count of flash access segments within the flash model.) |
| FlashReadMargin | Yes | 16h | 4 | The margin level setting for flash erase and program verify commands. 0 = Normal 1 = User (default) 2 = Factory |
| TargetVersion | No | 18h | 4 | SoC target build version number |

7.5.1 Property Definitions

Get/Set property definitions are provided in this section.

7.5.1.1 CurrentVersion Property

The value of this property is a 4-byte structure containing the current version of the flashloader.

Table 7-46. Fields of CurrentVersion property:

| Bits | [31:24] | [23:16] | [15:8] | [7:0] |
|-------|-------------------|---------------|---------------|----------------|
| Field | Name = 'K' (0x4B) | Major version | Minor version | Bugfix version |

7.5.1.2 AvailablePeripherals Property

The value of this property is a bitfield that lists the peripherals supported by the flashloader and the hardware on which it is running.

Table 7-47. Peripheral bits:

| Bit | [31:7] | [6] | [5] | [4] | [3] | [2] | [1] | [0] |
|------------|----------|----------|----------|----------|----------|-----------|-----------|--------|
| Peripheral | Reserved | Reserved | Reserved | Reserved | Reserved | SPI Slave | I2C Slave | LPUART |

If the peripheral is available, then the corresponding bit will be set in the property value. All reserved bits must be set to 0.

7.5.1.3 AvailableCommands Property

This property value is a bitfield with set bits indicating the commands enabled in the flashloader. Only commands that can be sent from the host to the target are listed in the bitfield. Response commands such as GenericResponse are excluded.

The bit number that identifies whether a command is present is the command's tag value minus 1. 1 is subtracted from the command tag because the lowest command tag value is 0x01. To get the bit mask for a given command, use this expression:

$$\text{mask} = 1 \ll (\text{tag} - 1)$$

Table 7-48. Command bits:

| Bit | [31:18] | [17] | [16] | [15] | [14] | [13] | [12] | [11] | [10] | [9] | [8] | [7] | [6] | [5] | [4] | [3] | [2] | [1] | [0] |
|---------|----------|----------|----------|-------------------|---------------|------------------|-----------------------|-------------|-------|------|---------|----------|-------------|----------|------------|-------------|------------|------------------|---------------|
| Command | Reserved | Reserved | Reserved | FlashReadResource | FlashReadOnce | FlashProgramOnce | FlashEraseAllUnsecure | SetProperty | Reset | Call | Execute | Reserved | GetProperty | Reserved | FillMemory | WriteMemory | ReadMemory | FlashEraseRegion | FlashEraseAll |

7.5.1.4 TargetVersion Property

The value of this property is a 4-byte structure containing the target version of the flashloader.

Table 7-49. Fields of TargetVersion property:

| Bits | [31:24] | [23:16] | [15:8] | [7:0] |
|-------|-------------------|---------------|---------------|----------------|
| Field | Name = 'T' (0x4B) | Major version | Minor version | Bugfix version |

7.6 Kinetis Flashloader Status Error Codes

This section describes the status error codes that the Kinetis Flashloader returns to the host.

Table 7-50. Kinetis Flashloader Status Error Codes, sorted by Value

| Error Code | Value | Description |
|-----------------------------|-------|--|
| kStatus_Success | 0 | Operation succeeded without error. |
| kStatus_Fail | 1 | Operation failed with a generic error. |
| kStatus_ReadOnly | 2 | Requested value cannot be changed because it is read-only. |
| kStatus_OutOfRange | 3 | Requested value is out of range. |
| kStatus_InvalidArgument | 4 | The requested command's argument is undefined. |
| kStatus_Timeout | 5 | A timeout occurred. |
| kStatus_FlashSizeError | 100 | Not used. |
| kStatus_FlashAlignmentError | 101 | Address or length does not meet required alignment. |

Table continues on the next page...

Table 7-50. Kinetis Flashloader Status Error Codes, sorted by Value (continued)

| Error Code | Value | Description |
|----------------------------------|-------|--|
| kStatus_FlashAddressError | 102 | Address or length is outside addressable memory. |
| kStatus_FlashAccessError | 103 | The FTFA_FSTAT[ACCERR] bit is set. |
| kStatus_FlashProtectionViolation | 104 | The FTFA_FSTAT[FPVIOL] bit is set. |
| kStatus_FlashCommandFailure | 105 | The FTFA_FSTAT[MGSTAT0] bit is set. |
| kStatus_FlashUnknownProperty | 106 | Unknown Flash property. |
| kStatus_FlashEraseKeyError | 107 | The key provided does not match the programmed flash key. |
| kStatus_FlashRegionExecuteOnly | 108 | The area of flash is protected as execute only. |
| kStatus_I2C_SlaveTxUnderrun | 200 | I2C Slave TX Underrun error. |
| kStatus_I2C_SlaveRxOverrun | 201 | I2C Slave RX Overrun error. |
| kStatus_I2C_ArbitrationLost | 202 | I2C Arbitration Lost error. |
| kStatus_SPI_SlaveTxUnderrun | 300 | SPI Slave TX Underrun error. |
| kStatus_SPI_SlaveRxOverrun | 301 | SPI Slave RX Overrun error. |
| kStatus_SPI_Timeout | 302 | SPI transfer timed out. |
| kStatus_SPI_Busy | 303 | SPI instance is already busy performing a transfer. |
| kStatus_SPI_NoTransferInProgress | 304 | Attempt to abort a transfer when no transfer was in progress. |
| kStatus_UnknownCommand | 10000 | The requested command value is undefined. |
| kStatus_SecurityViolation | 10001 | Command is disallowed because flash security is enabled. |
| kStatus_AbortDataPhase | 10002 | Abort the data phase early. |
| kStatusMemoryRangeInvalid | 10200 | Memory range conflicts with a protected region. |
| kStatus_UnknownProperty | 10300 | The requested property value is undefined. |
| kStatus_ReadOnlyProperty | 10301 | The requested property value cannot be written. |
| kStatus_InvalidPropertyValue | 10302 | The specified property value is invalid. |
| kStatus_AppCrcCheckPassed | 10400 | CRC check is valid and passed. |
| kStatus_AppCrcCheckFailed | 10401 | CRC check is valid but failed. |
| kStatus_AppCrcCheckInactive | 10402 | CRC check is inactive. |
| kStatus_AppCrcCheckInvalid | 10403 | CRC check is invalid, because the BCA is invalid or the CRC parameters are unset (all 0xFF bytes). |
| kStatus_AppCrcCheckOutOfRange | 10404 | CRC check is valid but addresses are out of range. |

Chapter 8

Power Management

This section describes the various chip power modes and the functionality of the individual modules in these modes.

8.1 Introduction

This chapter describes the chip power distribution as well as the various chip power modes and functionality of the individual modules in these modes.

The power architecture for this device is based on the PMC and a DCDC converter which can operate in a buck, boost or bypass configuration.

For more details see [DCDC](#) chapter.

8.2 Clocking Modes

This sections describes the various clocking modes supported on this device.

8.2.1 Partial Stop

Partial Stop is a clocking option that can be taken instead of entering STOP mode and is configured in the SMC Stop Control Register (SMC_STOPCTRL). The Stop mode is only partially entered, which leaves some additional functionality alive at the expense of higher power consumption. Partial Stop can be entered from either Run mode or VLP Run mode.

When configured for PSTOP2, only the core and system clocks are gated and the bus clock remains active. The bus masters and bus slaves clocked by the system clock enter Stop mode, but the bus slaves clocked by bus clock remain in Run (or VLP Run) mode. The clock generators in the MCG and the on-chip regulator in the PMC also remain in

Run (or VLP Run) mode. Exit from PSTOP2 can be initiated by a reset, an asynchronous interrupt from a bus master or bus slave clocked by the system clock, or a synchronous interrupt from a bus slave clocked by the bus clock. If configured, a DMA request (using the asynchronous DMA wakeup) can also be used to exit Partial Stop for the duration of a DMA transfer before the device is transitioned back into PSTOP2.

When configured for PSTOP1, both the system clock and bus clock are gated. All bus masters and bus slaves enter Stop mode, but the clock generators in the MCG and the on-chip regulator in the PMC remain in Run (or VLP Run) mode. Exit from PSTOP1 can be initiated by a reset or an asynchronous interrupt from a bus master or bus slave. If configured, an asynchronous DMA request can also be used to exit Partial Stop for the duration of a DMA transfer before the device is transitioned back into PSTOP1.

PSTOP1 is functionally similar to STOP mode, but offers faster wakeup at the expense of higher power consumption. Another benefit is that it keeps all of the MCG clocks enabled, which can be useful for some of the asynchronous peripherals that can remain functional in Stop modes.

8.2.2 DMA Wakeup

The DMA can be configured to wakeup the device on a DMA request whenever it is placed in stop mode. The wakeup is configured per DMA channel and is supported in Compute Operation, PSTOP, STOP and VLPS low power modes.

When a DMA wakeup is detected in PSTOP, STOP or VLPS then the device will initiate a normal exit from the low power mode. This can include restoring the on-chip regulator and internal power switches, enabling the clock generators in the MCG, enabling the system and bus clocks (but not the core clock) and negating the stop mode signal to the bus masters and bus slaves. The only difference is that the CPU will remain in the low power mode with the CPU clock disabled.

During Compute Operation, a DMA wakeup will initiate a normal exit from Compute Operation. This includes enabling the clocks and negating the stop mode signal to the bus masters and bus slaves. The core clock always remains enabled during Compute Operation.

Since the DMA wakeup will enable the clocks and negate the stop mode signals to all bus masters and slaves, software needs to ensure that bus masters and slaves that are not involved with the DMA wakeup and transfer remain in a known state. That can be accomplished by disabling the modules before entry into the low power mode or by setting the Doze enable bit in selected modules.

Once the DMA request that initiated the wakeup negates and the DMA completes the current transfer, the device will transition back into the original low power mode. This includes requesting all non-CPU bus masters to enter Stop mode and then requesting bus slaves to enter Stop mode. In STOP and VLPS modes the MCG and PMC would then also enter their appropriate modes.

NOTE

If the requested DMA transfer cannot cause the DMA request to negate then the device will remain in a higher power state until the low power mode is fully exited.

An enabled DMA wakeup can cause an aborted entry into the low power mode, if the DMA request asserts during the stop mode entry sequence (or reentry if the request asserts during a DMA wakeup) and can cause the SMC to assert its Stop Abort flag. Once the DMA wakeup completes, entry into the low power mode will restart.

An interrupt that occurs during a DMA wakeup will cause an immediate exit from the low power mode (this is optional for Compute Operation) without impacting the DMA transfer.

A DMA wakeup can be generated by either a synchronous DMA request (supported in PSTOP2 or during the stop mode entry sequence) or an asynchronous DMA request (supported in all other low power modes). Not all peripherals can generate an asynchronous DMA request in stop modes, although in general if a peripheral can generate synchronous DMA requests and also supports asynchronous interrupts in stop modes, then it can generate an asynchronous DMA request.

8.2.3 Compute Operation

Compute Operation is an execution or compute-only mode of operation that keeps the CPU enabled with full access to the SRAM and Flash read port, but places all other bus masters and bus slaves into their stop mode. Compute Operation can be enabled in either Run mode or VLP Run mode.

NOTE

Do not enter any stop mode without first exiting Compute Operation.

Because Compute Operation reuses the stop mode logic (including the staged entry with bus masters disabled before bus slaves), any bus master or bus slave that can remain functional in stop mode also remains functional in Compute Operation, including generation of asynchronous interrupts and DMA requests. When enabling Compute Operation in Run mode, module functionality for bus masters and slaves is the equivalent

of STOP mode. When enabling Compute Operation in VLP Run mode, module functionality for bus masters and slaves is the equivalent of VLPS mode. The MCG, PMC, SRAM and Flash read port are not affected by Compute Operation, although the Flash register interface is disabled.

During Compute Operation, the AIPS peripheral space is disabled and attempted accesses generate bus errors. The private peripheral space remains accessible during Compute Operation, including the MCM, NVIC, IOPORT and SysTick. Although access to the GPIO registers via the IOPORT is supported, the GPIO port data input registers do not return valid data since clocks are disabled to the Port Control and Interrupt modules. By writing to the GPIO port data output registers, it is possible to control those GPIO ports that are configured as output pins.

Compute Operation is controlled by the CPO register in the MCM, which is only accessible to the CPU. Setting or clearing the CPOREQ bit in the MCM initiates entry or exit into Compute Operation. Compute Operation can also be configured to exit automatically on detection of an interrupt, which is required in order to service most interrupts. Only the core system interrupts (exceptions, including NMI and SysTick) and any edge sensitive interrupts can be serviced without exiting Compute Operation.

When entering Compute Operation, the CPOACK status bit indicates when entry has completed. When exiting Compute Operation in Run mode, the CPOACK status bit negates immediately. When exiting Compute Operation in VLP Run mode, the exit is delayed to allow the PMC to handle the change in power consumption. This delay means the CPOACK bit is polled to determine when the AIPS peripheral space can be accessed without generating a bus error.

The DMA wakeup is also supported during Compute Operation and causes the CPOACK status bit to clear and the AIPS peripheral space to be accessible for the duration of the DMA wakeup. At the completion of the DMA wakeup, the device transitions back into Compute Operation.

8.2.4 Peripheral Doze

Several peripherals support a Peripheral Doze mode, where a register bit can be used to disable the peripheral for the duration of a low power mode. The Flash can also be placed in a low power state during Peripheral Doze via a register bit in the SIM.

Peripheral Doze is defined to include all of the modes of operation listed below.

- The CPU is in Wait mode.

- The CPU is in Stop mode, including the entry sequence and for the duration of a DMA wakeup.
- The CPU is in Compute Operation, including the entry sequence and for the duration of a DMA wakeup.

Peripheral Doze can therefore be used to disable selected bus masters or slaves for the duration of WAIT or VLPW mode. It can also be used to disable selected bus slaves immediately on entry into any stop mode (or Compute Operation), instead of waiting for the bus masters to acknowledge the entry as part of the stop entry sequence. Finally, it can be used to disable selected bus masters or slaves that should remain inactive during a DMA wakeup.

If the Flash is not being accessed during WAIT and PSTOP modes, then the Flash Doze mode can be used to reduce power consumption, at the expense of a slightly longer wakeup when executing code and vectors from Flash. It can also be used to reduce power consumption during Compute Operation when executing code and vectors from SRAM.

8.2.5 Clock Gating

To conserve power, the clocks to most modules can be turned off using the SCGCx registers in the SIM module. These bits are cleared after any reset, which disables the clock to the corresponding module. Prior to initializing a module, set the corresponding bit in the SCGCx register to enable the clock. Before turning off the clock, make sure to disable the module. For more details, refer to the clock distribution and SIM chapters.

8.3 Power modes

The power management controller (PMC) provides multiple power options to allow the user to optimize power consumption for the level of functionality needed.

Depending on the stop requirements of the user application, a variety of stop modes are available that provide state retention, partial power down or full power down of certain logic and/or memory. I/O states are held in all modes of operation. The following table compares the various power modes available.

For each run mode there is a corresponding wait and stop mode. Wait modes are similar to ARM sleep modes. Stop modes (VLPS, STOP) are similar to ARM sleep deep mode. The very low power run (VLPR) operating mode can drastically reduce runtime power when the maximum bus frequency is not required to handle the application needs.

Power modes

The three primary modes of operation are run, wait and stop. The WFI instruction invokes either wait or stop depending on the SLEEPDEEP bit in Cortex-M0+ System Control Register. The primary modes are augmented in a number of ways to provide lower power based on application needs.

Table 8-1. Power modes (At 25 deg C)

| Power mode | Description | CPU recovery method | Radio |
|--|---|---------------------|--|
| Normal Run (all peripherals clock off) | Allows maximum performance of chip. | — | Radio can be active |
| Normal Wait - via WFI | Allows peripherals to function, while allowing CPU to go to sleep reducing power. | Interrupt | |
| Normal Stop - via WFI | Places chip in static state. Lowest power mode that retains all registers while maintaining LVD protection. | Interrupt | |
| PStop2 (Partial Stop 2) | Core and system clocks are gated. Bus clock remains active. Masters and slaves clocked by bus clock remain in Run or VLPRun mode. The clock generators in MCG and the on-chip regulator in the PMC also remain in Run or VLPRun mode. | Interrupt | |
| PStop1 (Partial Stop 1) | Core, system clocks and bus clock are gated. All bus masters and slaves enter Stop mode. The clock generators in MCG and the on-chip regulator in the PMC also remain in Run or VLPRun mode. | Interrupt | |
| VLPR (Very Low Power Run) (all peripherals off) | Reduced frequency (1MHz) Flash access mode, regulator in low power mode, LVD off. Internal oscillator can provide low power 4 MHz source for core. (Values @2MHz core/ 1MHz bus and flash, module off, execution from flash). Biasing is disabled when DC-DC is configured for continuous mode in VLPR/W | — | Radio operation is possible only when DC-DC is configured for continuous mode. ¹ However, there may be insufficient MIPS with a 4MHz MCU to support much in the way of radio operation. |
| VLPW (Very Low Power Wait) - via WFI (all peripherals off) | Similar to VLPR, with CPU in sleep to further reduce power. (Values @4MHz core/ 1MHz bus, module off) Biasing is disabled when DC-DC is configured for continuous mode in VLPR/W | Interrupt | |
| VLPS (Very Low Power Stop) via WFI | Places MCU in static state with LVD operation off. Lowest power mode with ADC and all pin interrupts functional. LPTMR, RTC, CMP, TSI can be operational. Biasing is disabled when DC-DC is configured for continuous mode in VLPS | Interrupt | |
| LLS3 (Low Leakage Stop) | State retention power mode. LLWU, LPTMR, RTC, CMP, TSI can be operational. All of the radio Sea of Gates (SOG) logic is in state retention | Wakeup Interrupt | Radio SOG is in state retention in LLSx. The BLE/802.15.4/Generic FSK DSM ² logic can be active using the 32 kHz clock |
| LLS2 (Low Leakage Stop) | State retention power mode. LLWU, LPTMR, RTC, CMP, TSI can be operational. 16 KB or 32 KB of programmable RAM can be powered on. All of the radio SOG logic is in state retention | Wakeup Interrupt | |

Table continues on the next page...

Table 8-1. Power modes (At 25 deg C) (continued)

| Power mode | Description | CPU recovery method | Radio |
|--|--|---------------------|---|
| VLLS3 (Very Low Leakage Stop3) | Full SRAM retention. LLWU, LPTMR, RTC, CMP, TSI can be operational. All of the radio SOG logic is in state retention | Wakeup Reset | Radio SOG is in state retention in VLLS3/2. The BLE/802.15.4/Generic FSK DSM logic can be active using the 32 kHz clock |
| VLLS2 (Very Low Leakage Stop2) | Partial SRAM retention. 16 KB or 32 KB of programmable RAM can be powered on.. LLWU, LPTMR, RTC, CMP, TSI can be operational. All of the radio SOG logic is in state retention - | Wakeup Reset | |
| VLLS1 (Very Low Leakage Stop1) with RTC + 32 kHz OSC | All SRAM powered off. The 32-byte system register file remains powered for customer-critical data. LLWU, LPTMR, RTC, CMP can be operational. Radio logic is power gated. | Wakeup Reset | Radio operation not supported. The Radio SOG is power-gated in VLLS1/0. Radio state is lost at VLLS1 and lower power states |
| VLLS1 (Very Low Leakage Stop1) with LPTMR + LPO | All SRAM powered off. The 32-byte system register file remains powered for customer-critical data. LLWU, LPTMR, RTC, CMP, TSI can be operational. | Wakeup Reset | |
| VLLS0 (Very Low Leakage Stop0) with Brown-out Detection | VLLS0 is not supported with DC-DC The 32-byte system register file remains powered for customer-critical data. Disable all analog modules in PMC and retains I/O state and DGO state. LPO disabled, POR brown-out detection enabled, Pin interrupt only. Radio logic is power gated. | Wakeup Reset | Radio operation not supported. The Radio digital is power-gated in VLLS1/0 |
| VLLS0 (Very Low Leakage Stop0) without Brown-out Detection | VLLS0 is not supported with DC-DC buck/boost configuration but is supported with bypass configuration The 32-byte system register file remains powered for customer-critical data. Disable all analog modules in PMC and retains I/O state and DGO state. LPO disabled, POR brown-out detection disabled, Pin interrupt only. Radio logic is power gated. | Wakeup Reset | |

1. Biasing is disabled, but the Flash is in a low power mode for VLPx, so this configuration can realize some power savings over use of Run/Wait/Stop
2. DSM refers to Radio's deepsleep mode. DSM does not refer to the ARM sleep deep mode.

8.4 Entering and exiting power modes

The WFI instruction invokes wait and stop modes for the chip. The processor exits the low-power mode via an interrupt. For LLS and VLLS modes, the wakeup sources are limited to LLWU generated wakeups, NMI pin, or $\overline{\text{RESET}}$ pin assertions. When the NMI pin or $\overline{\text{RESET}}$ pin have been disabled through associated FOPT settings, then these pins are ignored as wakeup sources. The wake-up flow from VLLSx is always through reset.

NOTE

The WFE instruction can have the side effect of entering a low-power mode, but that is not its intended usage. See ARM documentation for more on the WFE instruction.

NOTE

When the OSCCLK, the 32 MHz or 26 MHz crystal or external clock from EXTAL/XTAL, which serves as the Radio clock, is used as KW41 system clock, the RSIM_CONTROL[STOP_ACK_OVRD] bit should be set to avoid STOP/VLPS/LLSx/VLLSx mode entrance failure. Alternatively, KW41Z system clock can be switched to run from an internal mode, such as FEI, before entering low power mode.

On VLLSx recoveries, the I/O pins continue to be held in a static state after code execution begins, allowing software to reconfigure the system before unlocking the I/O. RAM is retained in VLLS3 and VLLS2 and part of RAM can be retained in VLLS2 if RAM2PO is enabled.

8.5 Module Operation in Low Power Modes

The following table illustrates the functionality of each module while the chip is in each of the low power modes. The standard behavior is shown with some exceptions for Compute Operation (CPO) and Partial Stop2 (PSTOP2).

(Debug modules are discussed separately; see [Debug in low-power modes](#).) Number ratings (such as 4 MHz and 1 Mbps) represent the maximum frequencies or maximum data rates per mode. Also, these terms are used:

- FF = Full functionality. In VLPR and VLPW the system frequency is limited, but if a module does not have a limitation in its functionality, it is still listed as FF.
- Async operation = Fully functional with alternate clock source, provided the selected clock source remains enabled
- static = Module register states and associated memories are retained.
- powered = Memory is powered to retain contents.
- low power = Memory is powered to retain contents in a lower power state
- OFF = Modules are powered off; module is in reset state upon wakeup. For clocks, OFF means disabled.
- wakeup = Modules can serve as a wakeup source for the chip.

Table 8-2. Module operation in low power modes

| Modules | VLPR | VLPW | Stop | VLPS | LLSx | VLLSx |
|---|--|--|---|--|--------------------------|--|
| Core modules | | | | | | |
| NVIC | FF | FF | static | static | static | OFF |
| System modules | | | | | | |
| Mode Controller | FF | FF | FF | FF | FF | FF |
| LLWU ¹ | static | static | static | static | FF | FF ² |
| PMC Regulator | DCDC configured for continuous mode : ON Otherwise: low power | DCDC configured for continuous mode : ON Otherwise: low power | ON | DCDC configured for continuous mode : ON Otherwise: low power | low power | low power in VLLS3, VLLS2, OFF in VLLS0/1 |
| LVD | disabled | disabled | ON | disabled | disabled | disabled |
| Brown-out Detection | ON | ON | ON | ON | ON | ON in VLLS1/2/3, optionally disabled in VLLS0 ³ |
| DMA | FF Async operation in CPO | FF | Async operation | Async operation | static | OFF |
| Watchdog | FF static in CPO | FF | Optional with clock source enabled in stop mode FF in PSTOP2 | Optional with clock source enabled in stop mode | static | OFF |
| Clocks | | | | | | |
| 1 kHz LPO | ON | ON | ON | ON | ON | ON in VLLS1/2/3, OFF in VLLS0 |
| Reference oscillator (OSC) ⁴ | Should be OFF, except when DCDC configured for continuous mode | Should be OFF, except when DCDC configured for continuous mode | ON as needed | Should be OFF, except when DCDC configured for continuous mode | OFF | OFF |
| 32 kHz oscillator (OSC32K) | optional | optional | optional | optional | optional | OFF in VLLS0 ⁵ |
| MCG | 4 MHz IRC | 4 MHz IRC | static - MCGIRCLK optional | static - MCGIRCLK optional | static - no clock output | OFF |
| Core clock | 4 MHz max | OFF | OFF | OFF | OFF | OFF |
| Platform clock | 4 MHz max | 4 MHz max | OFF | OFF | OFF | OFF |
| System clock | 4 MHz max OFF in CPO | 4 MHz max | OFF | OFF | OFF | OFF |
| Bus clock | 1 MHz max | 1 MHz max | OFF | OFF | OFF | OFF |

Table continues on the next page...

Table 8-2. Module operation in low power modes (continued)

| Modules | VLPR | VLPW | Stop | VLPS | LLSx | VLLSx |
|-------------------------------------|--|-----------|--|------------------------------|--|--|
| | OFF in CPO | | 24 MHz max in PSTOP2 from RUN 1 MHz max in PSTOP2 from VLPR | | | |
| Memory and memory interfaces | | | | | | |
| Flash | 1 MHz max access - no program No register access in CPO | low power | low power | low power | OFF | OFF |
| SRAM_U and SRAM_L | low power | low power | low power | low power | low power in LLS3, partially OFF in LLS2 | low power in VLLS3, partially OFF in VLLS2, all OFF in VLLS0/1 |
| System Register File | powered | powered | powered | powered | powered | powered |
| Communication interfaces | | | | | | |
| LPUART | 1 Mbps Async operation in CPO | 1 Mbps | Async operation FF in PSTOP2 | Async operation | static | OFF |
| DSPI1/0 | 500 kbps | 500 kbps | FF in PSTOP2 | static | static | OFF |
| I ² C0 | 50 kbps static, address match wakeup in CPO | 50 kbps | static, address match wakeup FF in PSTOP2 | static, address match wakeup | static | OFF |
| I ² C1 | 100 kbps static, address match wakeup in CPO | 100 kbps | static, address match wakeup | static, address match wakeup | static | OFF |
| CMT | FF static in CPO | FF | static | static | static | OFF |
| Timers | | | | | | |
| TPMx | FF Async operation in CPO | FF | Async operation FF in PSTOP2 | Async operation | static | OFF |
| PIT | FF static in CPO | FF | static | static | static | OFF |
| LPTMR | FF | FF | Async operation FF in PSTOP2 | Async operation | Async operation | Async operation ⁶ |
| RTC | FF | FF | Async operation FF in PSTOP2 | Async operation | Async operation | Async operation ⁷ |

Table continues on the next page...

Table 8-2. Module operation in low power modes (continued)

| Modules | VLPR | VLPW | Stop | VLPS | LLSx | VLLSx |
|---------------------------------|---|--|---|--|--|---|
| | Async operation in CPO | | | | | |
| General Purpose Analog | | | | | | |
| 16-bit ADC | FF ADC internal clock only in CPO | FF | ADC internal clock only FF in PSTOP2 | ADC internal clock only | static | OFF |
| CMP ⁸ | FF HS or LS compare in CPO | FF | HS or LS compare FF in PSTOP2 | HS or LS compare | LS compare | LS compare in VLLS1/2/3, OFF in VLLS0 |
| 6-bit DAC (in CMP) | FF static in CPO | FF | static FF in PSTOP2 | static | static | static, OFF in VLLS0 |
| 12-bit DAC | FF static in CPO | FF | static FF in PSTOP2 | static | static | static |
| Human-machine interfaces | | | | | | |
| GPIO | FF IOPORT write only in CPO | FF | static output, wakeup input FF in PSTOP2 | static output, wakeup input | static, pins latched | OFF, pins latched |
| TSI ⁹ | FF Async operation in CPO | Async operation | Async operation | Async operation | Async operation | Async operation |
| Security | | | | | | |
| AESA | FF static in CPO | FF | static | static | static | OFF |
| TRNG | FF static in CPO | FF | static | static | static | OFF |
| Radio | | | | | | |
| Bluetooth LE Link Layer (BTLL) | DCDC configured for continuous mode : FF Otherwise: static (must be in DSM) | DCDC configured for continuous mode : FF Otherwise: static (must be in DSM) | FF | DCDC configured for continuous mode : FF Otherwise: static (must be in DSM) | static (state retention) DSM timer can be active | VLLS3/2: static (state retention) DSM timer can be active VLLS1/0: OFF |
| 802.15.4 link layer | DCDC configured for continuous mode : FF Otherwise: static | DCDC configured for continuous mode : FF Otherwise: static | FF | DCDC configured for continuous mode : FF Otherwise: static | static (state retention) | VLLS3/2: static (state retention) VLLS1/0: OFF |
| PHY_DIG | PHY_DIG operation follows the same behavior as described in the rows above for BTLL and 802.15.4. | | | | | |
| Reference OSC | Refer to the "Reference OSC" entry in the "Clocks" section of this table | | | | | |

Table continues on the next page...

Table 8-2. Module operation in low power modes (continued)

| Modules | VLPR | VLPW | Stop | VLPS | LLSx | VLLSx |
|--------------------|---|---|-----------------------------|---|------|-------|
| Other Radio Analog | DCDC configured for continuous mode : Can be enabled by Radio TSM Otherwise: should be OFF | DCDC configured for continuous mode : Can be enabled by Radio TSM Otherwise: should be OFF | Can be enabled by Radio TSM | DCDC configured for continuous mode : Can be enabled by Radio TSM Otherwise: should be OFF | OFF | OFF |

- Using the LLWU module, the external pins available for this chip do not require the associated peripheral function to be enabled. It only requires the function controlling the pin (GPIO or peripheral) to be configured as an input to allow a transition to occur to the LLWU.
- Since LPO clock source is disabled, filters will be bypassed during VLLS0.
- The STOPCTRL[PORPO] bit in the SMC module controls this option.
- The reference oscillator is not usable in VLPx modes except when when the DCDC is configured to use its normal (continuous) power mode in VLPx, in which case biasing is disabled
- The 32 KHz oscillator can be bypassed, in which case the 32 kHz EXTAL32K clock can be used in VLLS0
- LPO clock source is not available in VLLS0. In VLLS0 it must be configured for bypass (external clock) operation. Pulse counting is available in all modes.
- In VLLS0 the only clock option for the RTC is the 32 kHz bypass clock (EXTAL32K)
- CMP in stop or VLPS supports high speed or low speed external pin to pin or external pin to DAC compares. CMP in LLS or VLLSx only supports low speed external pin to pin or external pin to DAC compares. Windowed, sampled & filtered modes of operation are not available while in stop, VLPS, LLS, or VLLSx modes.
- TSI wakeup from all low power modes is limited to a single selectable pin.

Chapter 9

Security

This section provides an overview of flash security and details the effects of security on non-flash modules.

9.1 Introduction

This device implements security based on the mode selected from the flash module.

The following sections provide an overview of flash security and details the effects of security on non-flash modules.

9.2 Flash security

The flash module provides security information to the MCU based on the state held by FTFA_FSEC[SEC]. The MCU, in turn, confirms the security request and limits access to flash resources. During reset, the flash module initializes FTFA_FSEC using data read from the security byte of the flash configuration field.

NOTE

The security features apply only to external accesses: debug. CPU accesses to the flash are not affected by the status of FTFA_FSEC.

In the unsecured state, all flash commands are available on the programming interfaces either from the debug port (SWD) or user code execution. When the flash is secured (FTFA_FSEC[SEC] = 00, 01, or 11), the programmer interfaces are only allowed to launch mass erase operations. Additionally, in this mode, the debug port has no access to memory locations.

9.3 Security interactions with other modules

The flash security settings are used by the system to determine what resources are available. The following sections describe the interactions between modules and the flash security settings or the impact that the flash security has on non-flash modules.

9.3.1 Security interactions with Debug

When flash security is active, the SWD port cannot access the memory resources of the MCU.

Although most debug functions are disabled, the debugger can write to the Flash Mass Erase in Progress field of the MDM-AP Control register to trigger a mass erase (Erase All Blocks) command. A mass erase via the debugger is allowed even when some memory locations are protected.

When mass erase is disabled, mass erase via the debugger is blocked.

9.3.2 Firmware Distribution Protection

KW4x will implement a Flash protection scheme designed to enable the distribution of Firmware to third parties from the factory. The protection mechanism allows firmware in the flash to be marked as execute-only on a per-segment basis.

Refer to chapter [FTFA](#) for Flash protection information

Chapter 10

Debug

This section describes the debug architecture and components of this device.

10.1 Introduction

Debug of this device is based on the ARM CoreSight™ architecture and is configured to provide the maximum flexibility as allowed by the restrictions of the pinout and other available resources.

It provides register and memory accessibility from the external debugger interface, basic run/halt control plus 2 breakpoints and 2 watchpoints.

Only one debug interface is supported:

- Serial Wire Debug (SWD)

10.2 Debug port pin descriptions

The debug port pins default after POR to their SWD functionality.

Table 10-1. Serial wire debug pin description

| Pin name | Type | Description |
|----------|----------------|--|
| SWD_CLK | Input | Serial Wire Clock This pin is the clock for debug logic when in the Serial Wire Debug mode. This pin is pulled down internally. |
| SWD_DIO | Input / Output | Serial Wire Debug Data Input/Output The SWD_DIO pin is used by an external debug tool for communication and device control. This pin is pulled up internally. |

10.3 SWD status and control registers

Through the ARM Debug Access Port (DAP), the debugger has access to the status and control elements, implemented as registers on the DAP bus as shown in the figure found here.

These registers provide additional control and status for low power mode recovery and typical run-control scenarios. The status register bits also provide a means for the debugger to get updated status of the core without having to initiate a bus transaction across the crossbar switch, thus remaining less intrusive during a debug session.

It is important to note that these DAP control and status registers are not memory mapped within the system memory map and are only accessible via the Debug Access Port using SWD. The MDM-AP is accessible as Debug Access Port 1 with the available registers shown in this table.

Table 10-2. MDM-AP register summary

| Address | Register | Description |
|-------------|----------|--|
| 0x0100_0000 | Status | See MDM-AP Status Register |
| 0x0100_0004 | Control | See MDM-AP Control Register |
| 0x0100_00FC | IDR | Read-only identification register that always reads as 0x001C_0020 |

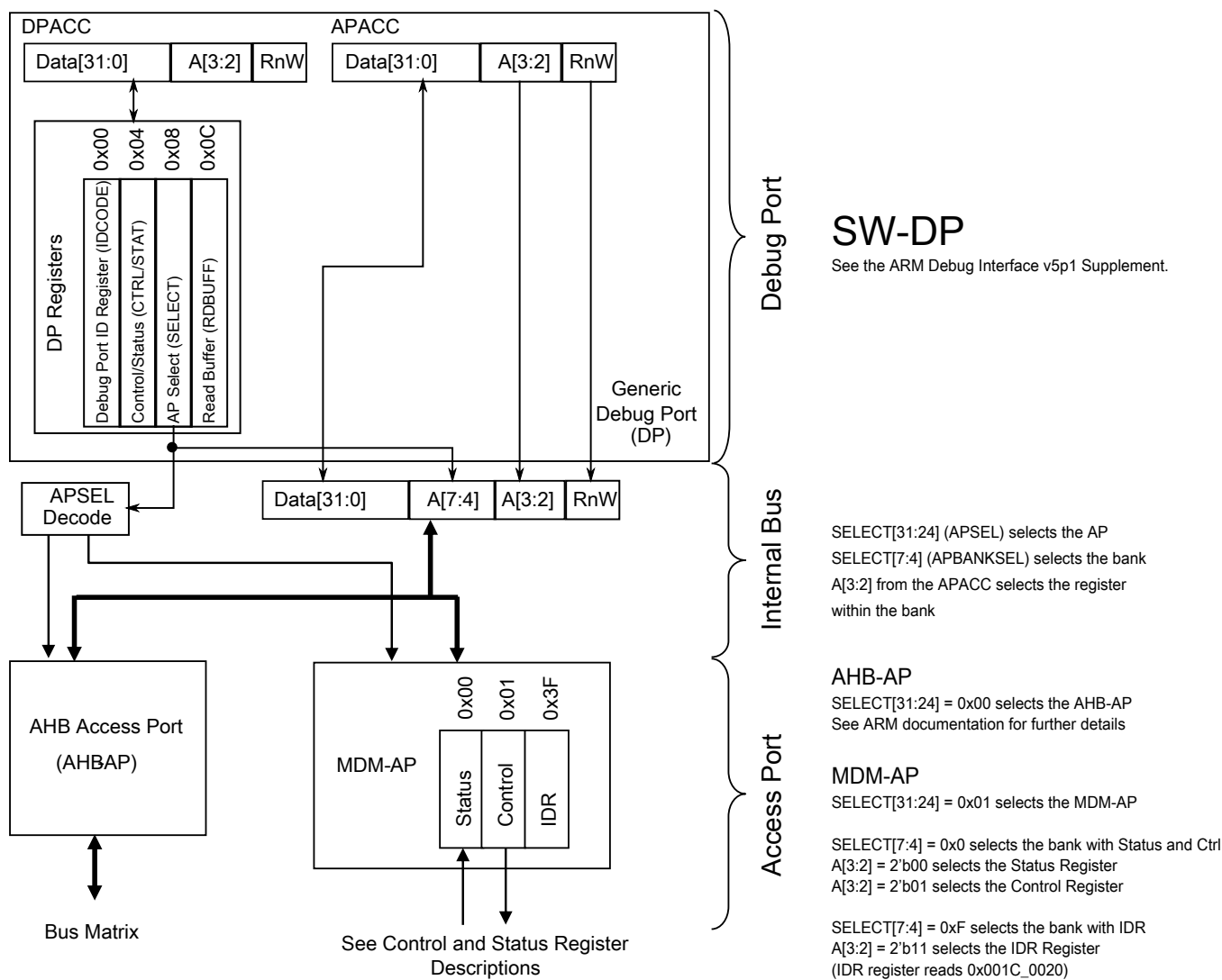

Figure 10-1. MDM AP addressing

10.3.1 MDM-AP Control Register

Table 10-3. MDM-AP Control register assignments

| Bit | Name | Secure ¹ | Description |
|-----|------------------------------|---------------------|--|
| 0 | Flash Mass Erase in Progress | Y | Set to cause mass erase. Cleared by power on reset after mass erase operation completes. Together with Flash Mass Erase Acknowledge bit (AP STATUS[0]), it represents the following states: <ul style="list-style-type: none"> AP CTRL[0], AP STATUS [0] = 00, Idle, waiting for mass erase by writing AP CTRL[0] = 1 AP CTRL[0], AP STATUS [0] = 01, Waiting for acknowledgement from flash |

Table continues on the next page...

Table 10-3. MDM-AP Control register assignments (continued)

| Bit | Name | Secure ¹ | Description |
|-----|-------------------------------------|---------------------|---|
| | | | <ul style="list-style-type: none"> AP CTRL[0], AP STATUS [0] = 10, Receive ack from flash, waiting for done from flash AP CTRL[0], AP STATUS [0] = 11, Done from flash, waiting for next AP CTRL[0] = 1 <p>When mass erase is disabled (via MEEN settings), the erase request does not occur and the Flash Mass Erase in Progress bit continues to assert until the next system reset.</p> <p>NOTE: When the reset pin has been disabled and security has been enabled by means of the FSEC register, a mass erase can be performed if mass erase is enabled in the MEEN bits and only by setting both the mass erase and system reset request bits in the MDM-AP register.</p> |
| 1 | Debug Disable | N | Set to disable debug. Clear to allow debug operation. When set, it overrides the C_DEBUGEN bit within the DHCSR and force disables Debug logic. |
| 2 | Debug Request | N | Set to force the core to halt. If the core is in a Stop or Wait mode, this bit can be used to wake the core and transition to a halted state. |
| 3 | System Reset Request | Y | Set to force a system reset. The system remains held in reset until this bit is cleared. |
| 4 | Core Hold Reset | N | Configuration bit to control core operation at the end of system reset sequencing. 0 Normal operation: Release the core from reset along with the rest of the system at the end of system reset sequencing. 1 Suspend operation: Hold the core in reset at the end of reset sequencing. Once the system enters this suspended state, clearing this control bit immediately releases the core from reset and CPU operation begins. |
| 5 | VLLSx Debug Request (VLLDBGREQ) | N | Set to configure the system to be held in reset after the next recovery from a VLLSx mode. This bit is ignored on a VLLSx wakeup via the Reset pin. During a VLLSx wakeup via the Reset pin, the system can be held in reset by holding the reset pin asserted allowing the debugger to reinitialize the debug modules. This bit holds the system in reset when VLLSx modes are exited to allow the debugger time to re-initialize debug IP before the debug session continues. The Mode Controller captures this bit logic on entry to VLLSx modes. Upon exit from VLLSx modes, the Mode Controller will hold the system in reset until VLLDBGACK is asserted. VLLDBGREQ clears automatically due to the POR reset generated as part of the VLLSx recovery. |
| 6 | VLLSx Debug Acknowledge (VLLDBGACK) | N | Set to release a system being held in reset following a VLLSx recovery This bit is used by the debugger to release the system reset when it is being held on VLLSx mode exit. The debugger re-initializes all debug IP and then assert this control bit to allow the Mode Controller to release the system from reset and allow CPU operation to begin. |

Table continues on the next page...

Table 10-3. MDM-AP Control register assignments (continued)

| Bit | Name | Secure ¹ | Description |
|--------|-------------------------------|---------------------|---|
| | | | VLLDBGACK is cleared by the debugger or can be left set because it clears automatically due to the POR reset generated as part of the next VLLSx recovery. |
| 7 | LLS, VLLSx Status Acknowledge | N | Set this bit to acknowledge the DAP LLS and VLLS Status bits have been read. This acknowledge automatically clears the status bits. This bit is used by the debugger to clear the sticky LLS and VLLSx mode entry status bits. This bit is asserted and cleared by the debugger. |
| 8 – 31 | Reserved for future use | N | |

1. Command available in secure mode

10.3.2 MDM-AP Status Register

Table 10-4. MDM-AP Status register assignments

| Bit | Name | Description |
|-----|------------------------------|--|
| 0 | Flash Mass Erase Acknowledge | The Flash Mass Erase Acknowledge bit is cleared by power on reset. The bit is also cleared at launch of a mass erase command due to write of Flash Mass Erase in Progress bit in MDM AP Control Register. The Flash Mass Erase Acknowledge is set after Flash control logic has started the mass erase operation. When mass erase is disabled (via MEEN settings), an erase request due to setting of Flash Mass Erase in Progress bit is not acknowledged. |
| 1 | Flash Ready | Indicates Flash has been initialized and debugger can be configured even if system is continuing to be held in reset via the debugger. |
| 2 | System Security | Indicates the security state. When secure, the debugger does not have access to the system bus or any memory mapped peripherals. This bit indicates when the part is locked and no system bus access is possible. |
| 3 | System Reset | Indicates the system reset state. 0 System is in reset. 1 System is not in reset. |
| 4 | Reserved | |
| 5 | Mass Erase Enable | Indicates if the MCU can be mass erased or not 0 Mass erase is disabled. 1 Mass erase is enabled . |
| 6 | Backdoor Access Key Enable | Indicates if the MCU has the backdoor access key enabled. 0 Disabled 1 Enabled |
| 7 | LP Enabled | Decode of SMC_PMCTRL[STOPM] field to indicate that VLPS, LLS, or VLLSx are the selected power mode the next time the ARM Core enters Deep Sleep. 0 Low Power Stop Mode is not enabled. |

Table continues on the next page...

Table 10-4. MDM-AP Status register assignments (continued)

| Bit | Name | Description |
|---------|-------------------------|---|
| | | 1 Low Power Stop Mode is enabled. Usage intended for debug operation in which Run to VLPS is attempted. Per debug definition, the system actually enters the Stop state. A debugger should interpret deep sleep indication (with SLEEPDEEP and SLEEPING asserted), in conjunction with this bit asserted as the debugger-VLPS status indication. |
| 8 | Very Low Power Mode | Indicates current power mode is VLPx. This bit is not 'sticky' and should always represent whether VLPx is enabled or not. This bit is used to throttle SWD_CLK frequency up/down. |
| 9 | LLS Mode Exit | This bit indicates an exit from LLS mode has occurred. The debugger will lose communication while the system is in LLS (including access to this register). Once communication is reestablished, this bit indicates that the system had been in LLS. Since the debug modules held their state during LLS, they do not need to be reconfigured. This bit is set during the LLS recovery sequence. The LLS Mode Exit bit is held until the debugger has had a chance to recognize that LLS was exited and is cleared by a write of 1 to the LLS, VLLSx Status Acknowledge bit in MDM AP Control register. |
| 10 | VLLSx Modes Exit | This bit indicates an exit from VLLSx mode has occurred. The debugger will lose communication while the system is in VLLSx (including access to this register). Once communication is reestablished, this bit indicates that the system had been in VLLSx. Since the debug modules lose their state during VLLSx modes, they need to be reconfigured. This bit is set during the VLLSx recovery sequence. The VLLSx Mode Exit bit is held until the debugger has had a chance to recognize that a VLLS mode was exited and is cleared by a write of 1 to the LLS, VLLSx Status Acknowledge bit in MDM AP Control register. |
| 11 – 15 | Reserved for future use | Always read 0. |
| 16 | Core Halted | Indicates the core has entered Debug Halt mode |
| 17 | Core SLEEPDEEP | Indicates the core has entered a low-power mode |
| 18 | Core SLEEPING | SLEEPING==1 and SLEEPDEEP==0 indicates wait or VLPW mode. SLEEPING==1 and SLEEPDEEP==1 indicates stop or VLPS mode. |
| 19 – 31 | Reserved for future use | Always read 0. |

10.4 Debug Resets

The debug system receives the following source of reset:

- System POR reset

Conversely the debug system is capable of generating system reset using the following mechanism:

- A system reset in the DAP control register which allows the debugger to hold the system in reset.
- SYSRESETREQ bit in the NVIC application interrupt and reset control register
- A system reset in the DAP control register which allows the debugger to hold the Core in reset.

10.5 Micro Trace Buffer (MTB)

The Micro Trace Buffer (MTB) provides a simple execution trace capability for the Cortex-M0+ processor.

When enabled, the MTB records changes in program flow reported by the Cortex-M0+ processor, via the execution trace interface, into a configurable region of the SRAM. Subsequently, an off-chip debugger may extract the trace information, which would allow reconstruction of an instruction flow trace. The MTB does not include any form of load/store data trace capability or tracing of any other information.

In addition to providing the trace capability, the MTB also operates as a simple AHB-Lite SRAM controller. The system bus masters, including the processor, have read/write access to all of the SRAM via the AHB-Lite interface, allowing the memory to be also used to store program and data information. The MTB simultaneously stores the trace information into an attached SRAM and allows bus masters to access the memory. The MTB ensures that trace information write accesses to the SRAM take priority over accesses from the AHB-Lite interface.

The MTB includes trace control registers for configuring and triggering the MTB functions. The MTB also supports triggering via TSTART and TSTOP control functions in the MTB DWT module.

10.6 Debug in low-power modes

In low-power modes, in which the debug modules are kept static or powered off, the debugger cannot gather any debug data for the duration of the low-power mode.

- In the case that the debugger is held static, the debug port returns to full functionality as soon as the low-power mode exits and the system returns to a state with active debug.
- In the case that the debugger logic is powered off, the debugger is reset on recovery and must be reconfigured once the low-power mode is exited.

Power mode entry logic monitors Debug Power Up and System Power Up signals from the debug port as indications that a debugger is active. These signals can be changed in RUN, VLPR, WAIT and VLPW. If the debug signal is active and the system attempts to enter Stop or VLPS, FCLK continues to run to support core register access. In these modes in which FCLK is left active the debug modules have access to core registers but not to system memory resources accessed via the crossbar.

With debug enabled, transitions from Run directly to VLPS result in the system entering Stop mode instead. Status bits within the MDM-AP Status register can be evaluated to determine this pseudo-VLPS state.

NOTE

With the debug enabled, transitions from Run --> VLPR --> VLPS are still possible.

In VLLS mode, all debug modules are powered off and reset at wakeup. In LLS mode, the debug modules retain their state but no debug activity is possible.

Going into a VLLSx mode causes all the debug controls and settings to be reset. To give time to the debugger to sync up with the HW, the MDM-AP Control register can be configured to hold the system in reset on recovery so that the debugger can regain control and reconfigure debug logic prior to the system exiting reset and resuming operation.

10.7 Debug and security

When flash security is enabled, the debug port capabilities are limited in order to prevent exploitation of secure data.

In the secure state, the debugger still has access to the status register and can determine the current security state of the device. In the case of a secure device, the debugger has the capability of only performing a mass erase operation.

Chapter 11

Port control and interrupt (PORT)

The port control and interrupt (PORT) module provides support for port control, and external interrupt functions.

11.1 Introduction

11.2 Overview

The Port Control and Interrupt (PORT) module provides support for port control, and external interrupt functions.

Most functions can be configured independently for each pin in the 32-bit port and affect the pin regardless of its pin muxing state.

There is one instance of the PORT module for each port. Not all pins within each port are implemented on a specific device.

11.2.1 Features

The PORT module has the following features:

- Pin interrupt on selected pins
 - Interrupt flag and enable registers for each pin
 - Support for edge sensitive (rising, falling, both) or level sensitive (low, high) configured per pin
 - Support for interrupt or DMA request configured per pin
 - Asynchronous wake-up in low-power modes
 - Pin interrupt is functional in all digital pin muxing modes
- Port control
 - Individual pull control fields with pullup, pulldown, and pull-disable support on selected pins

- Individual drive strength field supporting high and low drive strength on selected pins
- Individual slew rate field supporting fast and slow slew rates on selected pins
- Individual input passive filter field supporting enable and disable of the individual input passive filter on selected pins
- Individual mux control field supporting analog or pin disabled, GPIO, and up to six chip-specific digital functions
- Pad configuration fields are functional in all digital pin muxing modes.

11.2.2 Modes of operation

11.2.2.1 Run mode

In Run mode, the PORT operates normally.

11.2.2.2 Wait mode

In Wait mode, PORT continues to operate normally and may be configured to exit the Low-Power mode if an enabled interrupt is detected. DMA requests are still generated during the Wait mode, but do not cause an exit from the Low-Power mode.

11.2.2.3 Stop mode

In Stop mode, the PORT can be configured to exit the Low-Power mode via an asynchronous wake-up signal if an enabled interrupt is detected.

11.2.2.4 Debug mode

In Debug mode, PORT operates normally.

11.3 External signal description

The table found here describes the PORT external signal.

Table 11-1. Signal properties

| Name | Function | I/O | Reset | Pull |
|-------------|--------------------|-----|-------|------|
| PORTx[31:0] | External interrupt | I/O | 0 | - |

NOTE

Not all pins within each port are implemented on each device.

11.4 Detailed signal description

The table found here contains the detailed signal description for the PORT interface.

Table 11-2. PORT interface—detailed signal description

| Signal | I/O | Description | |
|-------------|-----|---------------------|---|
| PORTx[31:0] | I/O | External interrupt. | |
| | | State meaning | Asserted—pin is logic 1. Negated—pin is logic 0. |
| | | Timing | Assertion—may occur at any time and can assert asynchronously to the system clock. Negation—may occur at any time and can assert asynchronously to the system clock. |

11.5 Memory map and register definition

Any read or write access to the PORT memory space that is outside the valid memory map results in a bus error. All register accesses complete with zero wait states.

PORT memory map

| Absolute address (hex) | Register name | Width (in bits) | Access | Reset value | Section/page |
|------------------------|-------------------------------------|-----------------|--------|-----------------------------|----------------------------|
| 4004_9000 | Pin Control Register n (PORTA_PCR0) | 32 | R/W | See section | 11.5.1/253 |
| 4004_9004 | Pin Control Register n (PORTA_PCR1) | 32 | R/W | See section | 11.5.1/253 |
| 4004_9008 | Pin Control Register n (PORTA_PCR2) | 32 | R/W | See section | 11.5.1/253 |
| 4004_900C | Pin Control Register n (PORTA_PCR3) | 32 | R/W | See section | 11.5.1/253 |
| 4004_9010 | Pin Control Register n (PORTA_PCR4) | 32 | R/W | See section | 11.5.1/253 |

Table continues on the next page...

PORT memory map (continued)

| Absolute address (hex) | Register name | Width (in bits) | Access | Reset value | Section/page |
|------------------------|--|-----------------|-----------------------|-------------|--------------|
| 4004_9014 | Pin Control Register n (PORTA_PCR5) | 32 | R/W | See section | 11.5.1/253 |
| 4004_9018 | Pin Control Register n (PORTA_PCR6) | 32 | R/W | See section | 11.5.1/253 |
| 4004_901C | Pin Control Register n (PORTA_PCR7) | 32 | R/W | See section | 11.5.1/253 |
| 4004_9020 | Pin Control Register n (PORTA_PCR8) | 32 | R/W | See section | 11.5.1/253 |
| 4004_9024 | Pin Control Register n (PORTA_PCR9) | 32 | R/W | See section | 11.5.1/253 |
| 4004_9028 | Pin Control Register n (PORTA_PCR10) | 32 | R/W | See section | 11.5.1/253 |
| 4004_902C | Pin Control Register n (PORTA_PCR11) | 32 | R/W | See section | 11.5.1/253 |
| 4004_9030 | Pin Control Register n (PORTA_PCR12) | 32 | R/W | See section | 11.5.1/253 |
| 4004_9034 | Pin Control Register n (PORTA_PCR13) | 32 | R/W | See section | 11.5.1/253 |
| 4004_9038 | Pin Control Register n (PORTA_PCR14) | 32 | R/W | See section | 11.5.1/253 |
| 4004_903C | Pin Control Register n (PORTA_PCR15) | 32 | R/W | See section | 11.5.1/253 |
| 4004_9040 | Pin Control Register n (PORTA_PCR16) | 32 | R/W | See section | 11.5.1/253 |
| 4004_9044 | Pin Control Register n (PORTA_PCR17) | 32 | R/W | See section | 11.5.1/253 |
| 4004_9048 | Pin Control Register n (PORTA_PCR18) | 32 | R/W | See section | 11.5.1/253 |
| 4004_904C | Pin Control Register n (PORTA_PCR19) | 32 | R/W | See section | 11.5.1/253 |
| 4004_9050 | Pin Control Register n (PORTA_PCR20) | 32 | R/W | See section | 11.5.1/253 |
| 4004_9054 | Pin Control Register n (PORTA_PCR21) | 32 | R/W | See section | 11.5.1/253 |
| 4004_9058 | Pin Control Register n (PORTA_PCR22) | 32 | R/W | See section | 11.5.1/253 |
| 4004_905C | Pin Control Register n (PORTA_PCR23) | 32 | R/W | See section | 11.5.1/253 |
| 4004_9060 | Pin Control Register n (PORTA_PCR24) | 32 | R/W | See section | 11.5.1/253 |
| 4004_9064 | Pin Control Register n (PORTA_PCR25) | 32 | R/W | See section | 11.5.1/253 |
| 4004_9068 | Pin Control Register n (PORTA_PCR26) | 32 | R/W | See section | 11.5.1/253 |
| 4004_906C | Pin Control Register n (PORTA_PCR27) | 32 | R/W | See section | 11.5.1/253 |
| 4004_9070 | Pin Control Register n (PORTA_PCR28) | 32 | R/W | See section | 11.5.1/253 |
| 4004_9074 | Pin Control Register n (PORTA_PCR29) | 32 | R/W | See section | 11.5.1/253 |
| 4004_9078 | Pin Control Register n (PORTA_PCR30) | 32 | R/W | See section | 11.5.1/253 |
| 4004_907C | Pin Control Register n (PORTA_PCR31) | 32 | R/W | See section | 11.5.1/253 |
| 4004_9080 | Global Pin Control Low Register (PORTA_GPCLR) | 32 | W (always reads 0) | 0000_0000h | 11.5.2/256 |
| 4004_9084 | Global Pin Control High Register (PORTA_GPCHR) | 32 | W (always reads 0) | 0000_0000h | 11.5.3/256 |
| 4004_90A0 | Interrupt Status Flag Register (PORTA_ISFR) | 32 | w1c | 0000_0000h | 11.5.4/257 |
| 4004_A000 | Pin Control Register n (PORTB_PCR0) | 32 | R/W | See section | 11.5.1/253 |
| 4004_A004 | Pin Control Register n (PORTB_PCR1) | 32 | R/W | See section | 11.5.1/253 |
| 4004_A008 | Pin Control Register n (PORTB_PCR2) | 32 | R/W | See section | 11.5.1/253 |
| 4004_A00C | Pin Control Register n (PORTB_PCR3) | 32 | R/W | See section | 11.5.1/253 |
| 4004_A010 | Pin Control Register n (PORTB_PCR4) | 32 | R/W | See section | 11.5.1/253 |

Table continues on the next page...

PORT memory map (continued)

| Absolute address (hex) | Register name | Width (in bits) | Access | Reset value | Section/page |
|------------------------|--|-----------------|-----------------------|-------------|--------------|
| 4004_A014 | Pin Control Register n (PORTB_PCR5) | 32 | R/W | See section | 11.5.1/253 |
| 4004_A018 | Pin Control Register n (PORTB_PCR6) | 32 | R/W | See section | 11.5.1/253 |
| 4004_A01C | Pin Control Register n (PORTB_PCR7) | 32 | R/W | See section | 11.5.1/253 |
| 4004_A020 | Pin Control Register n (PORTB_PCR8) | 32 | R/W | See section | 11.5.1/253 |
| 4004_A024 | Pin Control Register n (PORTB_PCR9) | 32 | R/W | See section | 11.5.1/253 |
| 4004_A028 | Pin Control Register n (PORTB_PCR10) | 32 | R/W | See section | 11.5.1/253 |
| 4004_A02C | Pin Control Register n (PORTB_PCR11) | 32 | R/W | See section | 11.5.1/253 |
| 4004_A030 | Pin Control Register n (PORTB_PCR12) | 32 | R/W | See section | 11.5.1/253 |
| 4004_A034 | Pin Control Register n (PORTB_PCR13) | 32 | R/W | See section | 11.5.1/253 |
| 4004_A038 | Pin Control Register n (PORTB_PCR14) | 32 | R/W | See section | 11.5.1/253 |
| 4004_A03C | Pin Control Register n (PORTB_PCR15) | 32 | R/W | See section | 11.5.1/253 |
| 4004_A040 | Pin Control Register n (PORTB_PCR16) | 32 | R/W | See section | 11.5.1/253 |
| 4004_A044 | Pin Control Register n (PORTB_PCR17) | 32 | R/W | See section | 11.5.1/253 |
| 4004_A048 | Pin Control Register n (PORTB_PCR18) | 32 | R/W | See section | 11.5.1/253 |
| 4004_A04C | Pin Control Register n (PORTB_PCR19) | 32 | R/W | See section | 11.5.1/253 |
| 4004_A050 | Pin Control Register n (PORTB_PCR20) | 32 | R/W | See section | 11.5.1/253 |
| 4004_A054 | Pin Control Register n (PORTB_PCR21) | 32 | R/W | See section | 11.5.1/253 |
| 4004_A058 | Pin Control Register n (PORTB_PCR22) | 32 | R/W | See section | 11.5.1/253 |
| 4004_A05C | Pin Control Register n (PORTB_PCR23) | 32 | R/W | See section | 11.5.1/253 |
| 4004_A060 | Pin Control Register n (PORTB_PCR24) | 32 | R/W | See section | 11.5.1/253 |
| 4004_A064 | Pin Control Register n (PORTB_PCR25) | 32 | R/W | See section | 11.5.1/253 |
| 4004_A068 | Pin Control Register n (PORTB_PCR26) | 32 | R/W | See section | 11.5.1/253 |
| 4004_A06C | Pin Control Register n (PORTB_PCR27) | 32 | R/W | See section | 11.5.1/253 |
| 4004_A070 | Pin Control Register n (PORTB_PCR28) | 32 | R/W | See section | 11.5.1/253 |
| 4004_A074 | Pin Control Register n (PORTB_PCR29) | 32 | R/W | See section | 11.5.1/253 |
| 4004_A078 | Pin Control Register n (PORTB_PCR30) | 32 | R/W | See section | 11.5.1/253 |
| 4004_A07C | Pin Control Register n (PORTB_PCR31) | 32 | R/W | See section | 11.5.1/253 |
| 4004_A080 | Global Pin Control Low Register (PORTB_GPCLR) | 32 | W (always reads 0) | 0000_0000h | 11.5.2/256 |
| 4004_A084 | Global Pin Control High Register (PORTB_GPCHR) | 32 | W (always reads 0) | 0000_0000h | 11.5.3/256 |
| 4004_A0A0 | Interrupt Status Flag Register (PORTB_ISFR) | 32 | w1c | 0000_0000h | 11.5.4/257 |
| 4004_B000 | Pin Control Register n (PORTC_PCR0) | 32 | R/W | See section | 11.5.1/253 |
| 4004_B004 | Pin Control Register n (PORTC_PCR1) | 32 | R/W | See section | 11.5.1/253 |
| 4004_B008 | Pin Control Register n (PORTC_PCR2) | 32 | R/W | See section | 11.5.1/253 |
| 4004_B00C | Pin Control Register n (PORTC_PCR3) | 32 | R/W | See section | 11.5.1/253 |
| 4004_B010 | Pin Control Register n (PORTC_PCR4) | 32 | R/W | See section | 11.5.1/253 |

Table continues on the next page...

PORT memory map (continued)

| Absolute address (hex) | Register name | Width (in bits) | Access | Reset value | Section/page |
|------------------------|--|-----------------|-----------------------|-------------|--------------|
| 4004_B014 | Pin Control Register n (PORTC_PCR5) | 32 | R/W | See section | 11.5.1/253 |
| 4004_B018 | Pin Control Register n (PORTC_PCR6) | 32 | R/W | See section | 11.5.1/253 |
| 4004_B01C | Pin Control Register n (PORTC_PCR7) | 32 | R/W | See section | 11.5.1/253 |
| 4004_B020 | Pin Control Register n (PORTC_PCR8) | 32 | R/W | See section | 11.5.1/253 |
| 4004_B024 | Pin Control Register n (PORTC_PCR9) | 32 | R/W | See section | 11.5.1/253 |
| 4004_B028 | Pin Control Register n (PORTC_PCR10) | 32 | R/W | See section | 11.5.1/253 |
| 4004_B02C | Pin Control Register n (PORTC_PCR11) | 32 | R/W | See section | 11.5.1/253 |
| 4004_B030 | Pin Control Register n (PORTC_PCR12) | 32 | R/W | See section | 11.5.1/253 |
| 4004_B034 | Pin Control Register n (PORTC_PCR13) | 32 | R/W | See section | 11.5.1/253 |
| 4004_B038 | Pin Control Register n (PORTC_PCR14) | 32 | R/W | See section | 11.5.1/253 |
| 4004_B03C | Pin Control Register n (PORTC_PCR15) | 32 | R/W | See section | 11.5.1/253 |
| 4004_B040 | Pin Control Register n (PORTC_PCR16) | 32 | R/W | See section | 11.5.1/253 |
| 4004_B044 | Pin Control Register n (PORTC_PCR17) | 32 | R/W | See section | 11.5.1/253 |
| 4004_B048 | Pin Control Register n (PORTC_PCR18) | 32 | R/W | See section | 11.5.1/253 |
| 4004_B04C | Pin Control Register n (PORTC_PCR19) | 32 | R/W | See section | 11.5.1/253 |
| 4004_B050 | Pin Control Register n (PORTC_PCR20) | 32 | R/W | See section | 11.5.1/253 |
| 4004_B054 | Pin Control Register n (PORTC_PCR21) | 32 | R/W | See section | 11.5.1/253 |
| 4004_B058 | Pin Control Register n (PORTC_PCR22) | 32 | R/W | See section | 11.5.1/253 |
| 4004_B05C | Pin Control Register n (PORTC_PCR23) | 32 | R/W | See section | 11.5.1/253 |
| 4004_B060 | Pin Control Register n (PORTC_PCR24) | 32 | R/W | See section | 11.5.1/253 |
| 4004_B064 | Pin Control Register n (PORTC_PCR25) | 32 | R/W | See section | 11.5.1/253 |
| 4004_B068 | Pin Control Register n (PORTC_PCR26) | 32 | R/W | See section | 11.5.1/253 |
| 4004_B06C | Pin Control Register n (PORTC_PCR27) | 32 | R/W | See section | 11.5.1/253 |
| 4004_B070 | Pin Control Register n (PORTC_PCR28) | 32 | R/W | See section | 11.5.1/253 |
| 4004_B074 | Pin Control Register n (PORTC_PCR29) | 32 | R/W | See section | 11.5.1/253 |
| 4004_B078 | Pin Control Register n (PORTC_PCR30) | 32 | R/W | See section | 11.5.1/253 |
| 4004_B07C | Pin Control Register n (PORTC_PCR31) | 32 | R/W | See section | 11.5.1/253 |
| 4004_B080 | Global Pin Control Low Register (PORTC_GPCLR) | 32 | W (always reads 0) | 0000_0000h | 11.5.2/256 |
| 4004_B084 | Global Pin Control High Register (PORTC_GPCHR) | 32 | W (always reads 0) | 0000_0000h | 11.5.3/256 |
| 4004_B0A0 | Interrupt Status Flag Register (PORTC_ISFR) | 32 | w1c | 0000_0000h | 11.5.4/257 |

11.5.1 Pin Control Register n (PORTx_PCRn)

NOTE

See the Signal Multiplexing and Pin Assignment chapter for the reset value of this device.

See the GPIO Configuration section for details on the available functions for each pin.

Do not modify pin configuration registers associated with pins that are not available in a reduced-pin package offering. Unbonded pins not available in a package are disabled by default to prevent them from consuming power.

Address: Base address + 0h offset + (4d × i), where i=0d to 31d

| Bit | 31 | 30 | 29 | 28 | 27 | 26 | 25 | 24 | 23 | 22 | 21 | 20 | 19 | 18 | 17 | 16 | |
|-------|-----|----|----|----|----|-----|----|-----|-----|-----|----------|-----|------|-----|----|----|--|
| R | 0 | | | | | | | ISF | 0 | | | | IRQC | | | | |
| W | w1c | | | | | | | | | | | | | | | | |
| Reset | 0 | 0 | 0 | 0 | 0 | 0 | 0 | 0 | 0 | 0 | 0 | 0 | 0 | 0 | 0 | 0 | |
| Bit | 15 | 14 | 13 | 12 | 11 | 10 | 9 | 8 | 7 | 6 | 5 | 4 | 3 | 2 | 1 | 0 | |
| R | 0 | | | | | MUX | | | 0 | DSE | Reserved | PFE | 0 | SRE | PE | PS | |
| W | w1c | | | | | | | | w1c | | | | w1c | | | | |
| Reset | 0 | 0 | 0 | 0 | 0 | * | * | * | 0 | * | 0 | * | 0 | * | * | * | |

* Notes:

- MUX field: Varies by port. See Signal Multiplexing and Signal Descriptions chapter for reset values per port.
- DSE field: Varies by port. See the Signal Multiplexing and Signal Descriptions chapter for reset values per port.
- PFE field: Varies by port. See Signal Multiplexing and Signal Descriptions chapter for reset values per port.
- SRE field: Varies by port. See Signal Multiplexing and Signal Descriptions chapter for reset values per port.
- PE field: Varies by port. See Signal Multiplexing and Signal Descriptions chapter for reset values per port.
- PS field: Varies by port. See Signal Multiplexing and Signal Descriptions chapter for reset values per port.

PORTx_PCRn field descriptions

| Field | Description |
|-------------------|---|
| 31–25 Reserved | This field is reserved. This read-only field is reserved and always has the value 0. |
| 24 ISF | Interrupt Status Flag This field is read-only for pins that do not support interrupt generation. The pin interrupt configuration is valid in all digital pin muxing modes. 0 Configured interrupt is not detected. 1 Configured interrupt is detected. If the pin is configured to generate a DMA request, then the corresponding flag will be cleared automatically at the completion of the requested DMA transfer. Otherwise, the flag remains set until a logic 1 is written to the flag. If the pin is configured for a level sensitive interrupt and the pin remains asserted, then the flag is set again immediately after it is cleared. |
| 23–20 Reserved | This field is reserved. This read-only field is reserved and always has the value 0. |
| 19–16 IRQC | Interrupt Configuration This field is read-only for pins that do not support interrupt generation. The pin interrupt configuration is valid in all digital pin muxing modes. The corresponding pin is configured to generate interrupt/DMA request as follows: 0000 Interrupt Status Flag (ISF) is disabled. 0001 ISF flag and DMA request on rising edge. 0010 ISF flag and DMA request on falling edge. 0011 ISF flag and DMA request on either edge. 0100 Reserved. 0101 Reserved. 0110 Reserved. 0111 Reserved. 1000 ISF flag and Interrupt when logic 0. 1001 ISF flag and Interrupt on rising-edge. 1010 ISF flag and Interrupt on falling-edge. 1011 ISF flag and Interrupt on either edge. 1100 ISF flag and Interrupt when logic 1. 1101 Reserved. 1110 Reserved. 1111 Reserved. |
| 15–11 Reserved | This field is reserved. This read-only field is reserved and always has the value 0. |
| 10–8 MUX | Pin Mux Control Not all pins support all pin muxing slots. Unimplemented pin muxing slots are reserved and may result in configuring the pin for a different pin muxing slot. The corresponding pin is configured in the following pin muxing slot as follows: 000 Pin disabled (Alternative 0) (analog). 001 Alternative 1 (GPIO). 010 Alternative 2 (chip-specific). 011 Alternative 3 (chip-specific). |

Table continues on the next page...

PORTx_PCRn field descriptions (continued)

| Field | Description |
|---------------|--|
| | 100 Alternative 4 (chip-specific). 101 Alternative 5 (chip-specific). 110 Alternative 6 (chip-specific). 111 Alternative 7 (chip-specific). |
| 7 Reserved | This field is reserved. This read-only field is reserved and always has the value 0. |
| 6 DSE | Drive Strength Enable This field is read-only for pins that do not support a configurable drive strength. Drive strength configuration is valid in all digital pin muxing modes. 0 Low drive strength is configured on the corresponding pin, if pin is configured as a digital output. 1 High drive strength is configured on the corresponding pin, if pin is configured as a digital output. |
| 5 Reserved | This field is reserved. |
| 4 PFE | Passive Filter Enable This field is read-only for pins that do not support a configurable passive input filter. Passive filter configuration is valid in all digital pin muxing modes. 0 Passive input filter is disabled on the corresponding pin. 1 Passive input filter is enabled on the corresponding pin, if the pin is configured as a digital input. Refer to the device data sheet for filter characteristics. |
| 3 Reserved | This field is reserved. This read-only field is reserved and always has the value 0. |
| 2 SRE | Slew Rate Enable This field is read-only for pins that do not support a configurable slew rate. Slew rate configuration is valid in all digital pin muxing modes. 0 Fast slew rate is configured on the corresponding pin, if the pin is configured as a digital output. 1 Slow slew rate is configured on the corresponding pin, if the pin is configured as a digital output. |
| 1 PE | Pull Enable This field is read-only for pins that do not support a configurable pull resistor. Refer to the Chapter of Signal Multiplexing and Signal Descriptions for the pins that support a configurable pull resistor. Pull configuration is valid in all digital pin muxing modes. 0 Internal pullup or pulldown resistor is not enabled on the corresponding pin. 1 Internal pullup or pulldown resistor is enabled on the corresponding pin, if the pin is configured as a digital input. |
| 0 PS | Pull Select This bit is read only for pins that do not support a configurable pull resistor direction. Pull configuration is valid in all digital pin muxing modes. 0 Internal pulldown resistor is enabled on the corresponding pin, if the corresponding PE field is set. 1 Internal pullup resistor is enabled on the corresponding pin, if the corresponding PE field is set. |

11.5.2 Global Pin Control Low Register (PORTx_GPCLR)

Only 32-bit writes are supported to this register.

Address: Base address + 80h offset

| | | | | | | | | | | | | | | | | | | | | | | | | | | | | | | | | |
|-------|------|----|----|----|----|----|----|----|----|----|----|----|----|----|----|----|------|----|----|----|----|----|---|---|---|---|---|---|---|---|---|---|
| Bit | 31 | 30 | 29 | 28 | 27 | 26 | 25 | 24 | 23 | 22 | 21 | 20 | 19 | 18 | 17 | 16 | 15 | 14 | 13 | 12 | 11 | 10 | 9 | 8 | 7 | 6 | 5 | 4 | 3 | 2 | 1 | 0 |
| R | 0 | | | | | | | | | | | | | | | | 0 | | | | | | | | | | | | | | | |
| W | GPWE | | | | | | | | | | | | | | | | GPWD | | | | | | | | | | | | | | | |
| Reset | 0 | 0 | 0 | 0 | 0 | 0 | 0 | 0 | 0 | 0 | 0 | 0 | 0 | 0 | 0 | 0 | 0 | 0 | 0 | 0 | 0 | 0 | 0 | 0 | 0 | 0 | 0 | 0 | 0 | 0 | 0 | 0 |

PORTx_GPCLR field descriptions

| Field | Description |
|---------------|--|
| 31–16 GPWE | Global Pin Write Enable Selects which Pin Control Registers (15 through 0) bits [15:0] update with the value in GPWD. 0 Corresponding Pin Control Register is not updated with the value in GPWD. 1 Corresponding Pin Control Register is updated with the value in GPWD. |
| GPWD | Global Pin Write Data Write value that is written to all Pin Control Registers bits [15:0] that are selected by GPWE. |

11.5.3 Global Pin Control High Register (PORTx_GPCHR)

Only 32-bit writes are supported to this register.

Address: Base address + 84h offset

| | | | | | | | | | | | | | | | | | | | | | | | | | | | | | | | | |
|-------|------|----|----|----|----|----|----|----|----|----|----|----|----|----|----|----|------|----|----|----|----|----|---|---|---|---|---|---|---|---|---|---|
| Bit | 31 | 30 | 29 | 28 | 27 | 26 | 25 | 24 | 23 | 22 | 21 | 20 | 19 | 18 | 17 | 16 | 15 | 14 | 13 | 12 | 11 | 10 | 9 | 8 | 7 | 6 | 5 | 4 | 3 | 2 | 1 | 0 |
| R | 0 | | | | | | | | | | | | | | | | 0 | | | | | | | | | | | | | | | |
| W | GPWE | | | | | | | | | | | | | | | | GPWD | | | | | | | | | | | | | | | |
| Reset | 0 | 0 | 0 | 0 | 0 | 0 | 0 | 0 | 0 | 0 | 0 | 0 | 0 | 0 | 0 | 0 | 0 | 0 | 0 | 0 | 0 | 0 | 0 | 0 | 0 | 0 | 0 | 0 | 0 | 0 | 0 | 0 |

PORTx_GPCHR field descriptions

| Field | Description |
|---------------|---|
| 31–16 GPWE | Global Pin Write Enable Selects which Pin Control Registers (31 through 16) bits [15:0] update with the value in GPWD. 0 Corresponding Pin Control Register is not updated with the value in GPWD. 1 Corresponding Pin Control Register is updated with the value in GPWD. |
| GPWD | Global Pin Write Data Write value that is written to all Pin Control Registers bits [15:0] that are selected by GPWE. |

11.5.4 Interrupt Status Flag Register (PORTx_ISFR)

The corresponding bit is read only for pins that do not support interrupt generation.

The pin interrupt configuration is valid in all digital pin muxing modes. The Interrupt Status Flag for each pin is also visible in the corresponding Pin Control Register, and each flag can be cleared in either location.

Address: Base address + A0h offset

| | | | | | | | | | | | | | | | | | | | | | | | | | | | | | | | | |
|-------|-----|----|----|----|----|----|----|----|----|----|----|----|----|----|----|----|----|----|----|----|----|----|---|---|---|---|---|---|---|---|---|---|
| Bit | 31 | 30 | 29 | 28 | 27 | 26 | 25 | 24 | 23 | 22 | 21 | 20 | 19 | 18 | 17 | 16 | 15 | 14 | 13 | 12 | 11 | 10 | 9 | 8 | 7 | 6 | 5 | 4 | 3 | 2 | 1 | 0 |
| R | ISF | | | | | | | | | | | | | | | | | | | | | | | | | | | | | | | |
| W | w1c | | | | | | | | | | | | | | | | | | | | | | | | | | | | | | | |
| Reset | 0 | 0 | 0 | 0 | 0 | 0 | 0 | 0 | 0 | 0 | 0 | 0 | 0 | 0 | 0 | 0 | 0 | 0 | 0 | 0 | 0 | 0 | 0 | 0 | 0 | 0 | 0 | 0 | 0 | 0 | 0 | 0 |

PORTx_ISFR field descriptions

| Field | Description |
|-------|--|
| ISF | <p>Interrupt Status Flag</p> <p>Each bit in the field indicates the detection of the configured interrupt of the same number as the field.</p> <p>0 Configured interrupt is not detected.</p> <p>1 Configured interrupt is detected. If the pin is configured to generate a DMA request, then the corresponding flag will be cleared automatically at the completion of the requested DMA transfer. Otherwise, the flag remains set until a logic 1 is written to the flag. If the pin is configured for a level sensitive interrupt and the pin remains asserted, then the flag is set again immediately after it is cleared.</p> |

11.6 Functional description

11.6.1 Pin control

Each port pin has a corresponding Pin Control register, PORT_PCRn, associated with it.

The upper half of the Pin Control register configures the pin's capability to either interrupt the CPU or request a DMA transfer, on a rising/falling edge or both edges as well as a logic level occurring on the port pin. It also includes a flag to indicate that an interrupt has occurred.

The lower half of the Pin Control register configures the following functions for each pin within the 32-bit port.

- Pullup or pulldown enable on selected pins
- Drive strength and slew rate configuration on selected pins

Functional description

- Passive input filter enable on selected pins
- Pin Muxing mode

The functions apply across all digital pin muxing modes and individual peripherals do not override the configuration in the Pin Control register. For example, if an I²C function is enabled on a pin, that does not override the pullup configuration for that pin.

When the Pin Muxing mode is configured for analog or is disabled, all the digital functions on that pin are disabled. This includes the pullup and pulldown enables, output buffer enable, input buffer enable, and passive filter enable.

The configuration of each Pin Control register is retained when the PORT module is disabled.

Whenever a pin is configured in any digital pin muxing mode, the input buffer for that pin is enabled allowing the pin state to be read via the corresponding GPIO Port Data Input Register (GPIO_PDIR) or allowing a pin interrupt or DMA request to be generated. If a pin is ever floating when its input buffer is enabled, then this can cause an increase in power consumption and must be avoided. A pin can be floating due to an input pin that is not connected or an output pin that has tri-stated (output buffer is disabled).

Enabling the internal pull resistor (or implementing an external pull resistor) will ensure a pin does not float when its input buffer is enabled; note that the internal pull resistor is automatically disabled whenever the output buffer is enabled allowing the Pull Enable bit to remain set. Configuring the Pin Muxing mode to disabled or analog will disable the pin's input buffer and results in the lowest power consumption.

11.6.2 Global pin control

The two global pin control registers allow a single register write to update the lower half of the pin control register on up to 16 pins, all with the same value.

The global pin control registers are designed to enable software to quickly configure multiple pins within the one port for the same peripheral function. However, the interrupt functions cannot be configured using the global pin control registers.

The global pin control registers are write-only registers, that always read as 0.

11.6.3 External interrupts

The external interrupt capability of the PORT module is available in all digital pin muxing modes provided the PORT module is enabled.

Each pin can be individually configured for any of the following external interrupt modes:

- Interrupt disabled, default out of reset
- Active high level sensitive interrupt
- Active low level sensitive interrupt
- Rising edge sensitive interrupt
- Falling edge sensitive interrupt
- Rising and falling edge sensitive interrupt
- Rising edge sensitive DMA request
- Falling edge sensitive DMA request
- Rising and falling edge sensitive DMA request

The interrupt status flag is set when the configured edge or level is detected on the pin . When not in Stop mode, the input is first synchronized to the bus clock to detect the configured level or edge transition.

The PORT module generates a single interrupt that asserts when the interrupt status flag is set for any enabled interrupt for that port. The interrupt negates after the interrupt status flags for all enabled interrupts have been cleared by writing a logic 1 to the ISF flag in either the PORT_ISFR or PORT_PCRn registers.

The PORT module generates a single DMA request that asserts when the interrupt status flag is set for any enabled DMA request in that port. The DMA request negates after the DMA transfer is completed, because that clears the interrupt status flags for all enabled DMA requests.

During Stop mode, the interrupt status flag for any enabled interrupt is asynchronously set if the required level or edge is detected. This also generates an asynchronous wake-up signal to exit the Low-Power mode.

Chapter 12

System Integration Module (SIM)

The System Integration Module (SIM) provides system control and chip configuration registers. This module contains several fields for selecting the clock source and dividers for various module clocks.

12.1 Introduction

The system integration module (SIM) provides system control and chip configuration registers.

12.1.1 Features

- System clocking configuration
 - System clock divide values
 - Architectural clock gating control
 - ERCLK32K clock selection
 - LPUART0 and TPM clock selection
- Flash and System RAM size configuration
- TPM external clock and input capture selection
- LPUART receive/transmit source selection/configuration

12.2 Memory map and register definition

The SIM module contains many bit fields for selecting the clock source and dividers for various module clocks.

NOTE

The SIM registers can be written only in supervisor mode. In user mode, write accesses are blocked and will result in a bus error.

NOTE

The SIM_SOPT1 register is located at a different base address than the other SIM registers.

SIM memory map

| Absolute address (hex) | Register name | Width (in bits) | Access | Reset value | Section/page |
|------------------------|---|-----------------|--------|-----------------------------|-----------------------------|
| 4004_7000 | System Options Register 1 (SIM_SOPT1) | 32 | R/W | 0000_9000h | 12.2.1/263 |
| 4004_8004 | System Options Register 2 (SIM_SOPT2) | 32 | R/W | 0000_0000h | 12.2.2/264 |
| 4004_800C | System Options Register 4 (SIM_SOPT4) | 32 | R/W | 0000_0000h | 12.2.3/265 |
| 4004_8010 | System Options Register 5 (SIM_SOPT5) | 32 | R/W | 0000_0000h | 12.2.4/267 |
| 4004_8018 | System Options Register 7 (SIM_SOPT7) | 32 | R/W | 0000_0000h | 12.2.5/268 |
| 4004_8024 | System Device Identification Register (SIM_SDID) | 32 | R | See section | 12.2.6/270 |
| 4004_8034 | System Clock Gating Control Register 4 (SIM_SCGC4) | 32 | R/W | F000_0030h | 12.2.7/271 |
| 4004_8038 | System Clock Gating Control Register 5 (SIM_SCGC5) | 32 | R/W | 0200_0182h | 12.2.8/273 |
| 4004_803C | System Clock Gating Control Register 6 (SIM_SCGC6) | 32 | R/W | 0000_0001h | 12.2.9/276 |
| 4004_8040 | System Clock Gating Control Register 7 (SIM_SCGC7) | 32 | R/W | 0000_0100h | 12.2.10/278 |
| 4004_8044 | System Clock Divider Register 1 (SIM_CLKDIV1) | 32 | R/W | See section | 12.2.11/279 |
| 4004_804C | Flash Configuration Register 1 (SIM_FCFG1) | 32 | R/W | See section | 12.2.12/280 |
| 4004_8050 | Flash Configuration Register 2 (SIM_FCFG2) | 32 | R | See section | 12.2.13/282 |
| 4004_8058 | Unique Identification Register Mid-High (SIM_UIDMH) | 32 | R | See section | 12.2.14/283 |
| 4004_805C | Unique Identification Register Mid Low (SIM_UIDML) | 32 | R | See section | 12.2.15/283 |
| 4004_8060 | Unique Identification Register Low (SIM_UIDL) | 32 | R | See section | 12.2.16/284 |
| 4004_8100 | COP Control Register (SIM_COPC) | 32 | R/W | 0000_000Ch | 12.2.17/284 |
| 4004_8104 | Service COP (SIM_SRV COP) | 32 | W | 0000_0000h | 12.2.18/286 |

12.2.1 System Options Register 1 (SIM_SOPT1)

NOTE

The SOPT1 register is only reset on POR or LVD.

Address: 4004_7000h base + 0h offset = 4004_7000h

| | | | | | | | | | | | | | | | | |
|-------|----|----|----|----|----|----|----|----|----|----|----|----|-----------|----|-----------|----|
| Bit | 31 | 30 | 29 | 28 | 27 | 26 | 25 | 24 | 23 | 22 | 21 | 20 | 19 | 18 | 17 | 16 |
| R | 0 | | | | | | | | | | | | OSC32KSEL | | OSC32KOUT | |
| W | | | | | | | | | | | | | | | | |
| Reset | 0 | 0 | 0 | 0 | 0 | 0 | 0 | 0 | 0 | 0 | 0 | 0 | 0 | 0 | 0 | 0 |
| Bit | 15 | 14 | 13 | 12 | 11 | 10 | 9 | 8 | 7 | 6 | 5 | 4 | 3 | 2 | 1 | 0 |
| R | 0 | | | | | | | | | | | | | | | |
| W | | | | | | | | | | | | | | | | |
| Reset | 1 | 0 | 0 | 1 | 0 | 0 | 0 | 0 | 0 | 0 | 0 | 0 | 0 | 0 | 0 | 0 |

SIM_SOPT1 field descriptions

| Field | Description |
|--------------------|---|
| 31–20 Reserved | This field is reserved. This read-only field is reserved and always has the value 0. |
| 19–18 OSC32KSEL | 32K Oscillator Clock Select Selects the 32 kHz clock source (ERCLK32K) for RTC and LPTMR. This field is reset only on POR/LVD. 00 32kHz oscillator (OSC32KCLK) 01 Reserved 10 RTC_CLKIN 11 LPO 1kHz |
| 17–16 OSC32KOUT | 32K oscillator clock output Outputs the ERCLK32K on the selected pin in all modes of operation (including LLS/VLLS and System Reset), overriding the existing pin mux configuration for that pin. This field is reset only on POR/LVD. 00 ERCLK32K is not output. 01 ERCLK32K is output on PTB3. 10 Reserved. 11 Reserved. |
| Reserved | This field is reserved. This read-only field is reserved and always has the value 0. |

12.2.2 System Options Register 2 (SIM_SOPT2)

SOPT2 contains the controls for selecting many of the module clock source options on this device. See the Clock Distribution chapter for more information including clocking diagrams and definitions of device clocks.

Address: 4004_7000h base + 1004h offset = 4004_8004h

| | | | | | | | | | | | | | | | | |
|-------|----|----|----|----|------------|----|--------|----|-----------|----|----|----|----|----|----|----|
| Bit | 31 | 30 | 29 | 28 | 27 | 26 | 25 | 24 | 23 | 22 | 21 | 20 | 19 | 18 | 17 | 16 |
| R | 0 | | 0 | | LPUART0SRC | | TPMSRC | | 0 | | 0 | | | 0 | | |
| W | | | | | C | | | | | | | | | | | |
| Reset | 0 | 0 | 0 | 0 | 0 | 0 | 0 | 0 | 0 | 0 | 0 | 0 | 0 | 0 | 0 | 0 |
| Bit | 15 | 14 | 13 | 12 | 11 | 10 | 9 | 8 | 7 | 6 | 5 | 4 | 3 | 2 | 1 | 0 |
| R | 0 | | | | | | | | CLKOUTSEL | | | | 0 | | | |
| W | | | | | | | | | | | | | | | | |
| Reset | 0 | 0 | 0 | 0 | 0 | 0 | 0 | 0 | 0 | 0 | 0 | 0 | 0 | 0 | 0 | 0 |

SIM_SOPT2 field descriptions

| Field | Description |
|---------------------|--|
| 31–30 Reserved | This field is reserved. This read-only field is reserved and always has the value 0. |
| 29–28 Reserved | This field is reserved. This read-only field is reserved and always has the value 0. |
| 27–26 LPUART0SRC | LPUART0 Clock Source Select Selects the clock source for the LPUART0 transmit and receive clock. 00 Clock disabled 01 MCGFLLCLK clock 10 OSCERCLK clock 11 MCGIRCLK clock |
| 25–24 TPMSRC | TPM Clock Source Select Selects the clock source for the TPM counter clock 00 Clock disabled 01 MCGFLLCLK clock 10 OSCERCLK clock 11 MCGIRCLK clock |
| 23–22 Reserved | This field is reserved. This read-only field is reserved and always has the value 0. |
| 21–18 Reserved | This field is reserved. This read-only field is reserved and always has the value 0. |
| 17–16 Reserved | This field is reserved. This read-only field is reserved and always has the value 0. |

Table continues on the next page...

SIM_SOPT2 field descriptions (continued)

| Field | Description |
|------------------|--|
| 15–8 Reserved | This field is reserved. This read-only field is reserved and always has the value 0. |
| 7–5 CLKOUTSEL | CLKOUT select Selects the clock to output on the CLKOUT pin. 000 OSCERCLK DIV2 001 OSCERCLK DIV4 010 Bus clock 011 LPO clock 1 kHz 100 MCGIRCLK 101 OSCERCLK DIV8 110 OSCERCLK 111 Reserved |
| Reserved | This field is reserved. This read-only field is reserved and always has the value 0. |

12.2.3 System Options Register 4 (SIM_SOPT4)

Address: 4004_7000h base + 100Ch offset = 4004_800Ch

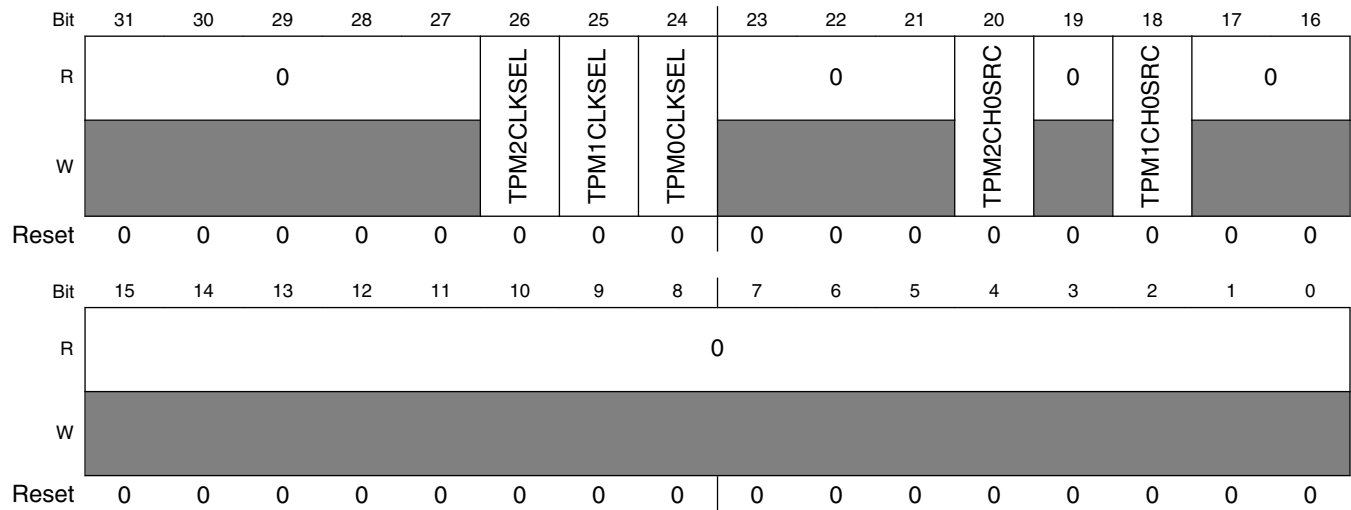

SIM_SOPT4 field descriptions

| Field | Description |
|-------------------|--|
| 31–27 Reserved | This field is reserved. This read-only field is reserved and always has the value 0. |
| 26 TPM2CLKSEL | TPM2 External Clock Pin Select Selects the external pin used to drive the clock to the TPM2 module. |

Table continues on the next page...

SIM_SOPT4 field descriptions (continued)

| Field | Description |
|-------------------|--|
| | <p>NOTE: The selected pin must also be configured for the TPM external clock function through the appropriate Pin Control Register in the Port Control module.</p> <p>0 TPM2 external clock driven by TPM_CLKIN0 pin. 1 TPM2 external clock driven by TPM_CLKIN1 pin.</p> |
| 25 TPM1CLKSEL | <p>TPM1 External Clock Pin Select</p> <p>Selects the external pin used to drive the clock to the TPM1 module.</p> <p>NOTE: The selected pin must also be configured for the TPM external clock function through the appropriate pin control register in the port control module.</p> <p>0 TPM1 external clock driven by TPM_CLKIN0 pin. 1 TPM1 external clock driven by TPM_CLKIN1 pin.</p> |
| 24 TPM0CLKSEL | <p>TPM0 External Clock Pin Select</p> <p>Selects the external pin used to drive the clock to the TPM0 module.</p> <p>NOTE: The selected pin must also be configured for the TPM external clock function through the appropriate pin control register in the port control module.</p> <p>0 TPM0 external clock driven by TPM_CLKIN0 pin. 1 TPM0 external clock driven by TPM_CLKIN1 pin.</p> |
| 23–21 Reserved | <p>This field is reserved. This read-only field is reserved and always has the value 0.</p> |
| 20 TPM2CH0SRC | <p>TPM2 Channel 0 Input Capture Source Select</p> <p>Selects the source for TPM2 channel 0 input capture.</p> <p>NOTE: When TPM2 is not in input capture mode, clear this field.</p> <p>0 TPM2_CH0 signal 1 CMP0 output</p> |
| 19 Reserved | <p>This field is reserved. This read-only field is reserved and always has the value 0.</p> |
| 18 TPM1CH0SRC | <p>TPM1 Channel 0 Input Capture Source Select</p> <p>Selects the source for TPM1 channel 0 input capture.</p> <p>NOTE: When TPM1 is not in input capture mode, clear this field.</p> <p>0 TPM1_CH0 signal 1 CMP0 output</p> |
| Reserved | <p>This field is reserved. This read-only field is reserved and always has the value 0.</p> |

12.2.4 System Options Register 5 (SIM_SOPT5)

Address: 4004_7000h base + 1010h offset = 4004_8010h

| | | | | | | | | | | | | | | | | |
|-------|------------|----|----|----|----|----|----|----|----|----|----|------------|---------------|----|---------------|----|
| Bit | 31 | 30 | 29 | 28 | 27 | 26 | 25 | 24 | 23 | 22 | 21 | 20 | 19 | 18 | 17 | 16 |
| R | 0 | | | | | | | | 0 | 0 | 0 | LPUART0ODE | | | | |
| W | [Reserved] | | | | | | | | | | | | | | | |
| Reset | 0 | 0 | 0 | 0 | 0 | 0 | 0 | 0 | 0 | 0 | 0 | 0 | 0 | 0 | 0 | 0 |
| Bit | 15 | 14 | 13 | 12 | 11 | 10 | 9 | 8 | 7 | 6 | 5 | 4 | 3 | 2 | 1 | 0 |
| R | 0 | | | | | | | | 0 | | | | LPUART0RXS RC | | LPUART0TXS RC | |
| W | [Reserved] | | | | | | | | | | | | | | | |
| Reset | 0 | 0 | 0 | 0 | 0 | 0 | 0 | 0 | 0 | 0 | 0 | 0 | 0 | 0 | 0 | 0 |

SIM_SOPT5 field descriptions

| Field | Description |
|-------------------|--|
| 31–20 Reserved | This field is reserved. This read-only field is reserved and always has the value 0. |
| 19 Reserved | This field is reserved. This read-only field is reserved and always has the value 0. |
| 18 Reserved | This field is reserved. This read-only field is reserved and always has the value 0. |
| 17 Reserved | This field is reserved. This read-only field is reserved and always has the value 0. |
| 16 LPUART0ODE | LPUART0 Open Drain Enable 0 Open drain is disabled on LPUART0. 1 Open drain is enabled on LPUART0. |
| 15–7 Reserved | This field is reserved. This read-only field is reserved and always has the value 0. |
| 6–4 Reserved | This field is reserved. This read-only field is reserved and always has the value 0. |
| 3 Reserved | This field is reserved. This read-only field is reserved and always has the value 0. |
| 2 LPUART0RXSRC | LPUART0 Receive Data Source Select Selects the source for the LPUART0 receive data. 0 LPUART_RX pin 1 CMP0 output |
| LPUART0TXSRC | LPUART0 Transmit Data Source Select |

Table continues on the next page...

SIM_SOPT5 field descriptions (continued)

| Field | Description |
|-------|---|
| | Selects the source for the LPUART0 transmit data. |
| 00 | LPUART0_TX pin |
| 01 | LPUART0_TX pin modulated with TPM1 channel 0 output |
| 10 | LPUART0_TX pin modulated with TPM2 channel 0 output |
| 11 | Reserved |

12.2.5 System Options Register 7 (SIM_SOPT7)

Address: 4004_7000h base + 1018h offset = 4004_8018h

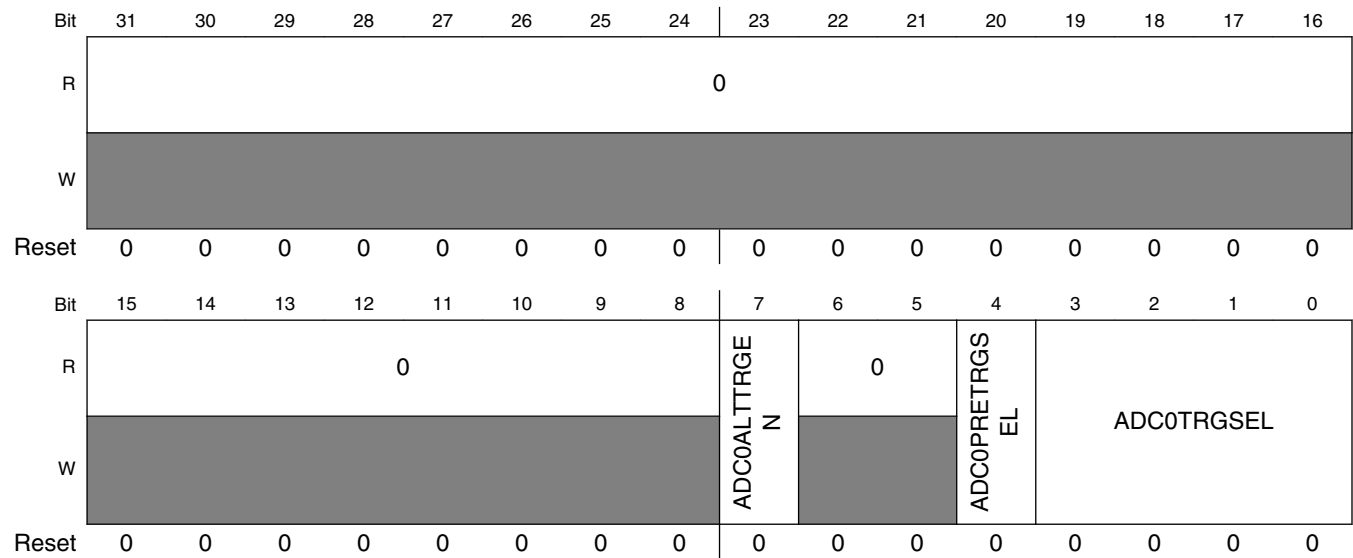

SIM_SOPT7 field descriptions

| Field | Description |
|--------------------|--|
| 31–8 Reserved | This field is reserved. This read-only field is reserved and always has the value 0. |
| 7 ADC0ALTTTRGEN | ADC0 Alternate Trigger Enable Enables alternative conversion triggers for ADC0. 0 ADC ADHWT trigger comes from TPM1 channel 0 and channel1. Prior to the assertion of TPM1 channel 0, a pre-trigger pulse will be sent to ADHWTSB to initiate an ADC acquisition using ADCx_SC1A configuration and store ADC conversion in ADCx_RA Register. Prior to the assertion of TPM1 channel 1 a pre-trigger pulse will be sent to ADHWTSB to initiate an ADC acquisition using ADCx_SC1B configuration and store ADC conversion in ADCx_RB Register. 1 ADC ADHWT trigger comes from a peripheral event selected by ADC0TRGSEL bits. ADC0PRETRGSEL bit will select the optional ADHWTSB or ADHWTSB select lines for choosing the ADCx_SC1x config and ADCx_Rx result register to store the ADC conversion. |

Table continues on the next page...

SIM_SOPT7 field descriptions (continued)

| Field | Description |
|--------------------|---|
| 6–5 Reserved | This field is reserved. This read-only field is reserved and always has the value 0. |
| 4 ADC0PRETRGSEL | ADC0 Pretrigger Select Selects the ADC0 pre-trigger source when alternative triggers are enabled through ADC0ALTTRGEN. NOTE: The ADC0PRETRGSEL function is ignored if ADC0ALTTRGEN = 0. 0 Pre-trigger ADHDWTSB is selected, thus ADC0 will use ADC0_SC1A configuration for the next ADC conversion and store the result in ADC0_RA register. 1 Pre-trigger ADHDWTTSA is selected, thus ADC0 will use ADC0_SC1B configuration for the next ADC conversion and store the result in ADC0_RB register. |
| ADC0TRGSEL | ADC0 Trigger Select Selects 1 of 16 peripherals to initiate an ADC conversion via the ADHWDT input, when ADC0ALTTRGEN = 1, else is ignored by ADC0. 0000 External trigger pin input (EXTRG_IN) 0001 CMP0 output 0010 Reserved 0011 Reserved 0100 PIT trigger 0 0101 PIT trigger 1 0110 Reserved 0111 Reserved 1000 TPM0 overflow 1001 TPM1 overflow 1010 TPM2 overflow 1011 Reserved 1100 RTC alarm 1101 RTC seconds 1110 LPTMR0 trigger 1111 Radio TSM |

12.2.6 System Device Identification Register (SIM_SDID)

Address: 4004_7000h base + 1024h offset = 4004_8024h

| | | | | | | | | | | | | | | | | |
|-------|-------|----|----|----|-------|----------|----|----|----------|----|----|----|----------|----|----|----|
| Bit | 31 | 30 | 29 | 28 | 27 | 26 | 25 | 24 | 23 | 22 | 21 | 20 | 19 | 18 | 17 | 16 |
| R | FAMID | | | | 0 | SUBFAMID | | | SERIESID | | | | SRAMSIZE | | | |
| W | | | | | | | | | | | | | | | | |
| Reset | * | * | * | * | 0 | 0 | * | * | 0 | 1 | 0 | 1 | * | * | * | * |
| Bit | 15 | 14 | 13 | 12 | 11 | 10 | 9 | 8 | 7 | 6 | 5 | 4 | 3 | 2 | 1 | 0 |
| R | REVID | | | | DIEID | | | | 0 | | | | PINID | | | |
| W | | | | | | | | | | | | | | | | |
| Reset | * | * | * | * | 0 | 0 | 0 | 0 | 0 | 0 | 0 | 0 | * | * | * | * |

* Notes:

- FAMID field: Device specific value.
- SUBFAMID field: Device specific value.
- SRAMSIZE field: Device specific value.
- REVID field: Device specific value.
- PINID field: Device specific value.

SIM_SDID field descriptions

| Field | Description |
|-------------------|---|
| 31–28 FAMID | Kinetis family ID Specifies the Kinetis family of the device. 0010 KW2x Family (802.15.4) 0011 KW3x Family (BTLE) 0100 KW4x Family (802.15.4, BTLE, GFSK) |
| 27–26 Reserved | This field is reserved. This read-only field is reserved and always has the value 0. |
| 25–24 SUBFAMID | Kinetis Sub-Family ID. Specifies the Kinetis sub-family of the device. 00 KWx0 Subfamily 01 KWx1 Subfamily 10 KWx2 Subfamily 11 KWx3 Subfamily |
| 23–20 SERIESID | Kinetis Series ID Specifies the Kinetis family of the device. 0101 KW family |
| 19–16 SRAMSIZE | System SRAM Size Specifies the size of the System SRAM |

Table continues on the next page...

SIM_SDID field descriptions (continued)

| Field | Description |
|-----------------|--|
| | 1001 128 KB 0111 64 KB |
| 15–12 REVID | Device Revision Number Specifies the silicon implementation number for the device. |
| 11–7 DIEID | Device Die Number Specifies the silicon implementation number for the device. |
| 6–4 Reserved | This field is reserved. This read-only field is reserved and always has the value 0. |
| PINID | Pin count Identification Specifies the pin count of the device. 0000 Reserved 0001 Reserved 0010 Reserved 0011 Reserved 0100 48-pin 0101 Reserved 0110 Reserved 0111 Reserved 1000 Reserved 1001 Reserved 1010 Reserved 1011 Reserved 1100 Reserved 1101 Reserved 1110 Reserved 1111 Reserved |

12.2.7 System Clock Gating Control Register 4 (SIM_SCGC4)

Address: 4004_7000h base + 1034h offset = 4004_8034h

| | | | | | | | | | | | | | | | | |
|-------|----|----|----|----|----|----|----|----|------|------|------|-----|----|-----|----|----|
| Bit | 31 | 30 | 29 | 28 | 27 | 26 | 25 | 24 | 23 | 22 | 21 | 20 | 19 | 18 | 17 | 16 |
| R | 1 | | | | 0 | | | | 0 | 0 | VREF | CMP | 0 | 0 | | |
| W | 0 | | | | | | | | | | | | | | | |
| Reset | 1 | 1 | 1 | 1 | 0 | 0 | 0 | 0 | 0 | 0 | 0 | 0 | 0 | 0 | 0 | 0 |
| Bit | 15 | 14 | 13 | 12 | 11 | 10 | 9 | 8 | 7 | 6 | 5 | 4 | 3 | 2 | 1 | 0 |
| R | 0 | 0 | 0 | 0 | 0 | 0 | 0 | 0 | I2C1 | I2C0 | 1 | | 0 | CMT | 0 | |
| W | 0 | | | | | | | | | | | | | | | |
| Reset | 0 | 0 | 0 | 0 | 0 | 0 | 0 | 0 | 0 | 0 | 1 | 1 | 0 | 0 | 0 | 0 |

SIM_SCGC4 field descriptions

| Field | Description |
|-------------------|--|
| 31–28 Reserved | This field is reserved. This read-only field is reserved and always has the value 1. |
| 27–24 Reserved | This field is reserved. This read-only field is reserved and always has the value 0. |
| 23–22 Reserved | This field is reserved. This read-only field is reserved and always has the value 0. |
| 21 Reserved | This field is reserved. This read-only field is reserved and always has the value 0. |
| 20 VREF | VREF Clock Gate Control Controls the clock gate to the VREF module. 0 Clock disabled 1 Clock enabled |
| 19 CMP | Comparator Clock Gate Control Controls the clock gate to the comparator module. 0 Clock disabled 1 Clock enabled |
| 18 Reserved | This field is reserved. This read-only field is reserved and always has the value 0. |
| 17–14 Reserved | This field is reserved. This read-only field is reserved and always has the value 0. |
| 13 Reserved | This field is reserved. This read-only field is reserved and always has the value 0. |
| 12 Reserved | This field is reserved. This read-only field is reserved and always has the value 0. |
| 11 Reserved | This field is reserved. This read-only field is reserved and always has the value 0. |
| 10 Reserved | This field is reserved. This read-only field is reserved and always has the value 0. |
| 9 Reserved | This field is reserved. This read-only field is reserved and always has the value 0. |
| 8 Reserved | This field is reserved. This read-only field is reserved and always has the value 0. |
| 7 I2C1 | I2C1 Clock Gate Control Controls the clock gate to the I ² C1 module. 0 Clock disabled 1 Clock enabled |
| 6 I2C0 | I2C0 Clock Gate Control Controls the clock gate to the I ² C0 module. 0 Clock disabled 1 Clock enabled |

Table continues on the next page...

SIM_SCGC4 field descriptions (continued)

| Field | Description |
|-----------------|---|
| 5-4 Reserved | This field is reserved. This read-only field is reserved and always has the value 1. |
| 3 Reserved | This field is reserved. This read-only field is reserved and always has the value 0. |
| 2 CMT | CMT Clock Gate Control Controls the clock gate to the CMT module. 0 Clock disabled 1 Clock enabled |
| Reserved | This field is reserved. This read-only field is reserved and always has the value 0. |

12.2.8 System Clock Gating Control Register 5 (SIM_SCGC5)

Address: 4004_7000h base + 1038h offset = 4004_8038h

| Bit | 31 | 30 | 29 | 28 | 27 | 26 | 25 | 24 | 23 | 22 | 21 | 20 | 19 | 18 | 17 | 16 |
|-------|----|----|----|----|-------|-------|-------|-----|----|----|-----|---------|----|----|----|-------|
| R | | 0 | | | | | RSIM | LTC | 0 | 0 | | LPUART0 | 0 | | 0 | |
| W | | | | | | | | | | | | | | | | |
| Reset | 0 | 0 | 0 | 0 | 0 | 0 | 1 | 0 | 0 | 0 | 0 | 0 | 0 | 0 | 0 | 0 |
| Bit | 15 | 14 | 13 | 12 | 11 | 10 | 9 | 8 | 7 | 6 | 5 | 4 | 3 | 2 | 1 | 0 |
| R | 0 | | 0 | | | | | | 1 | 0 | | | 0 | | 1 | |
| W | | | | | PORTC | PORTB | PORTA | | | | TSI | | | | | LPTMR |
| Reset | 0 | 0 | 0 | 0 | 0 | 0 | 0 | 1 | 1 | 0 | 0 | 0 | 0 | 0 | 1 | 0 |

SIM_SCGC5 field descriptions

| Field | Description |
|-------------------|---|
| 31 GEN_FSK | Generic FSK enabled 0 GFSK CGC bit disabled. 1 GFSK CGC bit enabled. |
| 30 Reserved | This field is reserved. This read-only field is reserved and always has the value 0. |
| 29 ZigBee | 802.15.4 Clock Gate Control This bit controls the clock gate to the 802.15.4 module. 0 Clock disabled 1 Clock enabled |
| 28 PHYDIG | PHY Digital Clock Gate Control This bit controls the clock gate to the Physical Layer (PHY) Digital module. 0 Clock disabled 1 Clock enabled |
| 27 BTLL | BTLL System Clock Gate Control This bit controls the clock gate to the BlueTooth Link Layer (BTLL) module. 0 Clock disabled 1 Clock enabled |
| 26 DCDC | DCDC Clock Gate Control This bit controls the clock gate to the DCDC module. 0 Clock disabled 1 Clock enabled |
| 25 RSIM | RSIM Clock Gate Control This bit controls the clock gate to the Radio SIM (RSIM) module. Always enabled. |
| 24 LTC | LTC Clock Gate Control This bit controls the clock gate to the LTC Security module. 0 Clock disabled 1 Clock enabled |
| 23–22 Reserved | This field is reserved. This read-only field is reserved and always has the value 0. |
| 21 Reserved | This field is reserved. This read-only field is reserved and always has the value 0. |
| 20 LPUART0 | LPUART0 Clock Gate Control This bit controls the clock gate to the LPUART0 module. 0 Clock disabled 1 Clock enabled |
| 19 Reserved | This field is reserved. This read-only field is reserved and always has the value 0. |

Table continues on the next page...

SIM_SCGC5 field descriptions (continued)

| Field | Description |
|-------------------|--|
| 18–14 Reserved | This field is reserved. This read-only field is reserved and always has the value 0. |
| 13–12 Reserved | This field is reserved. This read-only field is reserved and always has the value 0. |
| 11 PORTC | Port C Clock Gate Control Controls the clock gate to the Port C module. 0 Clock disabled 1 Clock enabled |
| 10 PORTB | Port B Clock Gate Control Controls the clock gate to the Port B module. 0 Clock disabled 1 Clock enabled |
| 9 PORTA | Port A Clock Gate Control Controls the clock gate to the Port A module. 0 Clock disabled 1 Clock enabled |
| 8–7 Reserved | This field is reserved. This read-only field is reserved and always has the value 1. |
| 6 Reserved | This field is reserved. This read-only field is reserved and always has the value 0. |
| 5 TSI | TSI Access Control Controls software access to the TSI module. 0 Access disabled 1 Access enabled |
| 4–2 Reserved | This field is reserved. This read-only field is reserved and always has the value 0. |
| 1 Reserved | This field is reserved. This read-only field is reserved and always has the value 1. |
| 0 LPTMR | Low Power Timer Access Control Controls software access to the Low Power Timer module. 0 Access disabled 1 Access enabled |

12.2.9 System Clock Gating Control Register 6 (SIM_SCGC6)

Address: 4004_7000h base + 103Ch offset = 4004_803Ch

| | | | | | | | | | | | | | | | | |
|-------|------|----|------|------|------|------|------|------|-----|----|----|----|----|--------|-----|----|
| Bit | 31 | 30 | 29 | 28 | 27 | 26 | 25 | 24 | 23 | 22 | 21 | 20 | 19 | 18 | 17 | 16 |
| R | | 0 | | 0 | | | | | | 0 | | | | 0 | | 0 |
| W | DAC0 | | RTC | | ADC0 | TPM2 | TPM1 | TPM0 | PIT | | | | | | | |
| Reset | 0 | 0 | 0 | 0 | 0 | 0 | 0 | 0 | 0 | 0 | 0 | 0 | 0 | 0 | 0 | 0 |
| Bit | 15 | 14 | 13 | 12 | 11 | 10 | 9 | 8 | 7 | 6 | 5 | 4 | 3 | 2 | 1 | 0 |
| R | 0 | 0 | | | 0 | | | | 0 | | | | | | | |
| W | | | SPI1 | SPI0 | | | TRNG | | | | | | | DMAMUX | FTF | |
| Reset | 0 | 0 | 0 | 0 | 0 | 0 | 0 | 0 | 0 | 0 | 0 | 0 | 0 | 0 | 0 | 1 |

SIM_SCGC6 field descriptions

| Field | Description |
|----------------|---|
| 31 DAC0 | DAC0 Clock Gate Control This bit controls the clock gate to the DAC0 module. 0 Clock disabled 1 Clock enabled |
| 30 Reserved | This field is reserved. This read-only field is reserved and always has the value 0. |
| 29 RTC | RTC Access Control Controls software access and interrupts to the RTC module. 0 Access and interrupts disabled 1 Access and interrupts enabled |
| 28 Reserved | This field is reserved. This read-only field is reserved and always has the value 0. |
| 27 ADC0 | ADC0 Clock Gate Control Controls the clock gate to the ADC0 module. 0 Clock disabled 1 Clock enabled |
| 26 TPM2 | TPM2 Clock Gate Control Controls the clock gate to the TPM2 module. 0 Clock disabled 1 Clock enabled |

Table continues on the next page...

SIM_SCGC6 field descriptions (continued)

| Field | Description |
|-------------------|---|
| 25 TPM1 | TPM1 Clock Gate Control Controls the clock gate to the TPM1 module. 0 Clock disabled 1 Clock enabled |
| 24 TPM0 | TPM0 Clock Gate Control Controls the clock gate to the TPM0 module. 0 Clock disabled 1 Clock enabled |
| 23 PIT | PIT Clock Gate Control This bit controls the clock gate to the PIT module. 0 Clock disabled 1 Clock enabled |
| 22–19 Reserved | This field is reserved. This read-only field is reserved and always has the value 0. |
| 18 Reserved | This field is reserved. This read-only field is reserved and always has the value 0. |
| 17–16 Reserved | This field is reserved. This read-only field is reserved and always has the value 0. |
| 15 Reserved | This field is reserved. This read-only field is reserved and always has the value 0. |
| 14 Reserved | This field is reserved. This read-only field is reserved and always has the value 0. |
| 13 SPI1 | SPI1 Clock Gate Control Controls the clock gate to the Serial Peripheral Interface (SPI1) module. 0 Clock disabled 1 Clock enabled |
| 12 SPI0 | SPI0 Clock Gate Control Controls the clock gate to the Serial Peripheral Interface (SPI0) module. 0 Clock disabled 1 Clock enabled |
| 11–10 Reserved | This field is reserved. This read-only field is reserved and always has the value 0. |
| 9 TRNG | TRNG Clock Gate Control Controls the clock gate to the Random Number Generator (TRNG) module. 0 Clock disabled 1 Clock enabled |
| 8–2 Reserved | This field is reserved. This read-only field is reserved and always has the value 0. |

Table continues on the next page...

SIM_SCGC6 field descriptions (continued)

| Field | Description |
|-------------|--|
| 1 DMAMUX | DMA Mux Clock Gate Control Controls the clock gate to the DMA Mux module. 0 Clock disabled 1 Clock enabled |
| 0 FTF | Flash Memory Clock Gate Control Controls the clock gate to the flash memory. Flash reads are still supported while the flash memory is clock gated, but entry into low power modes is blocked. 0 Clock disabled 1 Clock enabled |

12.2.10 System Clock Gating Control Register 7 (SIM_SCGC7)

Address: 4004_7000h base + 1040h offset = 4004_8040h

| | | | | | | | | | | | | | | | | | |
|-------|----|----|----|----|----|----|----|-----|---|----|----|----|----|----|----|----|----|
| Bit | 31 | 30 | 29 | 28 | 27 | 26 | 25 | 24 | | 23 | 22 | 21 | 20 | 19 | 18 | 17 | 16 |
| R | 0 | | | | | | | | | | | | | | | | |
| W | | | | | | | | | | | | | | | | | |
| Reset | 0 | 0 | 0 | 0 | 0 | 0 | 0 | 0 | | 0 | 0 | 0 | 0 | 0 | 0 | 0 | 0 |
| Bit | 15 | 14 | 13 | 12 | 11 | 10 | 9 | 8 | | 7 | 6 | 5 | 4 | 3 | 2 | 1 | 0 |
| R | 0 | | | | | | | DMA | 0 | | | | | | | | |
| W | | | | | | | | | | | | | | | | | |
| Reset | 0 | 0 | 0 | 0 | 0 | 0 | 0 | 1 | | 0 | 0 | 0 | 0 | 0 | 0 | 0 | 0 |

SIM_SCGC7 field descriptions

| Field | Description |
|------------------|---|
| 31–9 Reserved | This field is reserved. This read-only field is reserved and always has the value 0. |
| 8 DMA | DMA Clock Gate Control Controls the clock gate to the DMA module. 0 Clock disabled 1 Clock enabled |
| Reserved | This field is reserved. This read-only field is reserved and always has the value 0. |

12.2.11 System Clock Divider Register 1 (SIM_CLKDIV1)

NOTE

The CLKDIV1 register cannot be written to when the device is in VLPR mode.

NOTE

Reset value loaded during System Reset from FTFA_FOPT[LPBOOT]"/>).

Address: 4004_7000h base + 1044h offset = 4004_8044h

| | | | | | | | | | | | | | | | | | | | | | | | | | | | | | | | | | |
|-------|---------|----|----|----|----|----|----|----|----|----|----|----|---------|----|----|----|----|----|----|----|----|----|---|---|---|---|---|---|---|---|---|---|---|
| Bit | 31 | 30 | 29 | 28 | 27 | 26 | 25 | 24 | 23 | 22 | 21 | 20 | 19 | 18 | 17 | 16 | 15 | 14 | 13 | 12 | 11 | 10 | 9 | 8 | 7 | 6 | 5 | 4 | 3 | 2 | 1 | 0 | |
| R | OUTDIV1 | | | | 0 | | | | | | | | OUTDIV4 | | | | 0 | | | | | | | | | | | | | | | | |
| W | | | | | | | | | | | | | | | | | | | | | | | | | | | | | | | | | |
| Reset | * | * | * | * | 0 | 0 | 0 | 0 | 0 | 0 | 0 | 0 | 0 | 0 | 0 | 0 | 1 | 0 | 0 | 0 | 0 | 0 | 0 | 0 | 0 | 0 | 0 | 0 | 0 | 0 | 0 | 0 | 0 |

* Notes:

- OUTDIV1 field: The reset value depends on the FTFA_FOPT[LPBOOT]. It is loaded with 0000 (divide by 1), 0001 (divide by 2), 0011 (divide by 4, or 0111 (divide by 8).

SIM_CLKDIV1 field descriptions

| Field | Description |
|-------------------|--|
| 31–28 OUTDIV1 | <p>Clock 1 Output Divider value</p> <p>Sets the divide value for the core/system clock, as well as the bus/flash clocks. At the end of reset, it is loaded with 0000 (divide by one), 0001 (divide by two), 0011 (divide by four), or 0111 (divide by eight) depending on the setting of the FTFA_FOPT[LPBOOT].</p> <p>0000 Divide-by-1. 0001 Divide-by-2. 0010 Divide-by-3. 0011 Divide-by-4. 0100 Divide-by-5. 0101 Divide-by-6. 0110 Divide-by-7. 0111 Divide-by-8. 1000 Divide-by-9. 1001 Divide-by-10. 1010 Divide-by-11. 1011 Divide-by-12. 1100 Divide-by-13. 1101 Divide-by-14. 1110 Divide-by-15. 1111 Divide-by-16.</p> |
| 27–19 Reserved | <p>This field is reserved. This read-only field is reserved and always has the value 0.</p> |

Table continues on the next page...

SIM_CLKDIV1 field descriptions (continued)

| Field | Description |
|------------------|--|
| 18–16 OUTDIV4 | <p>Clock 4 Output Divider value</p> <p>Sets the divide value for the bus and flash clock and is in addition to the System clock divide ratio. At the end of reset, it is loaded with 0001 (divide by 2).</p> <p>000 Divide-by-1. 001 Divide-by-2. 010 Divide-by-3. 011 Divide-by-4. 100 Divide-by-5. 101 Divide-by-6. 110 Divide-by-7. 111 Divide-by-8.</p> |
| Reserved | <p>This field is reserved. This read-only field is reserved and always has the value 0.</p> |

12.2.12 Flash Configuration Register 1 (SIM_FCFG1)

Address: 4004_7000h base + 104Ch offset = 4004_804Ch

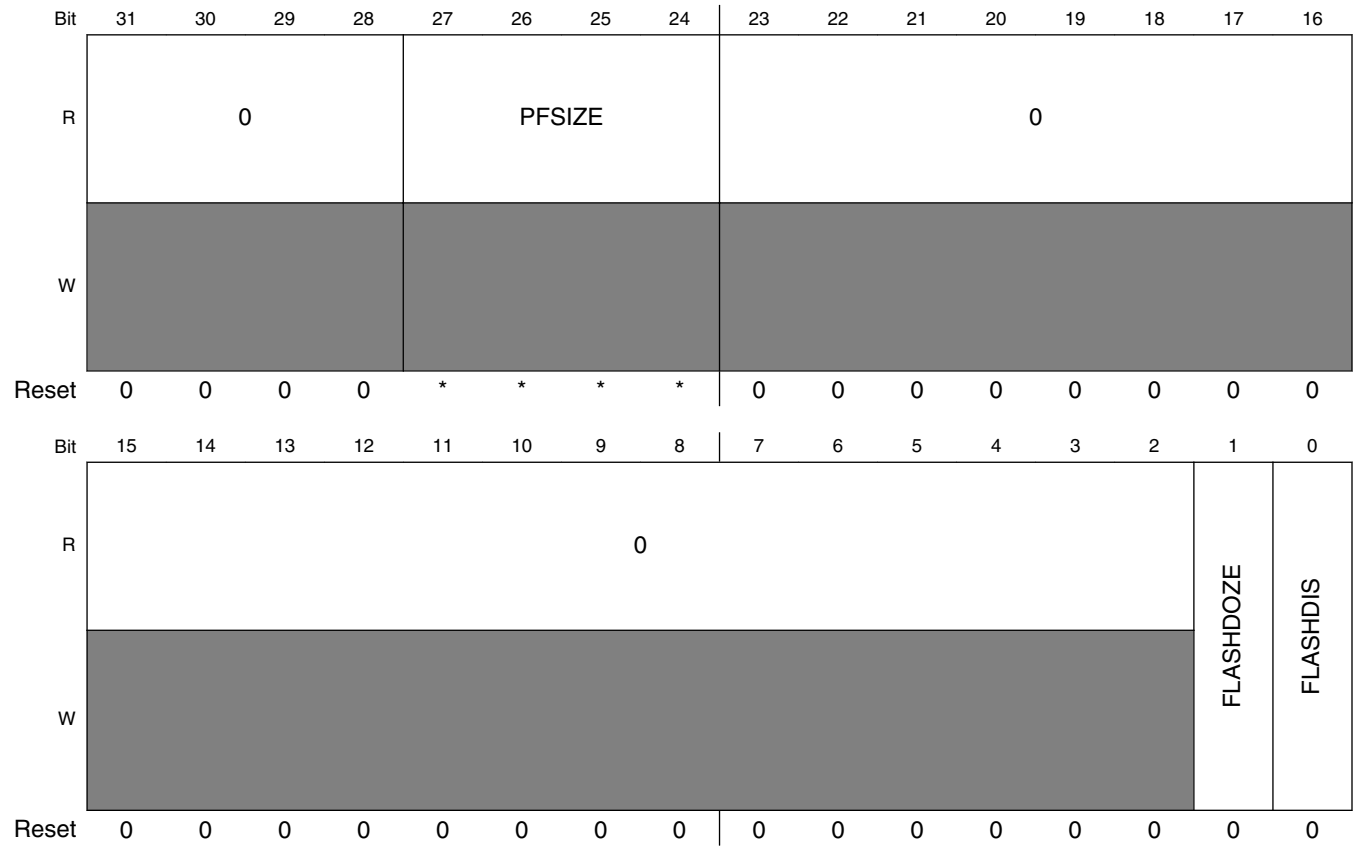

- * Notes:
- PFSIZE field: Device specific value.

SIM_FCFG1 field descriptions

| Field | Description |
|-------------------|---|
| 31–28 Reserved | This field is reserved. This read-only field is reserved and always has the value 0. |
| 27–24 PFSIZE | Program Flash Size Specifies the amount of program flash memory available on the device . Undefined values are reserved. 1001 256 KB of program flash memory 1011 512 KB of program flash memory 1111 512 KB of program flash memory |
| 23–2 Reserved | This field is reserved. This read-only field is reserved and always has the value 0. |
| 1 FLASHDOZE | Flash Doze When set, flash memory is disabled for the duration of Doze mode. This field must be clear during VLP modes. The flash will be automatically enabled again at the end of Doze mode so interrupt vectors do not need to be relocated out of flash memory. The wake-up time from Doze mode is extended when this field is set. An attempt by the DMA or other bus master to access the flash memory when the flash is disabled will result in a bus error. 0 Flash remains enabled during Doze mode. 1 Flash is disabled for the duration of Doze mode. |
| 0 FLASHDIS | Flash Disable Flash accesses are disabled (and generate a bus error) and the flash memory is placed in a low-power state. This field should not be changed during VLP modes. Relocate the interrupt vectors out of Flash memory before disabling the Flash. 0 Flash is enabled. 1 Flash is disabled. |

12.2.13 Flash Configuration Register 2 (SIM_FCFG2)

This is read only register, any write to this register will cause transfer error.

Address: 4004_7000h base + 1050h offset = 4004_8050h

| | | | | | | | | | | | | | | | | |
|-------|----|----------|----|----|----|----|----|----|----|----------|----|----|----|----|----|----|
| Bit | 31 | 30 | 29 | 28 | 27 | 26 | 25 | 24 | 23 | 22 | 21 | 20 | 19 | 18 | 17 | 16 |
| R | 0 | MAXADDR0 | | | | | | | 1 | MAXADDR1 | | | | | | |
| W | | | | | | | | | | | | | | | | |
| Reset | 0 | * | * | * | * | * | * | * | 1 | * | * | * | * | * | * | * |
| Bit | 15 | 14 | 13 | 12 | 11 | 10 | 9 | 8 | 7 | 6 | 5 | 4 | 3 | 2 | 1 | 0 |
| R | 0 | | | | | | | | | | | | | | | |
| W | | | | | | | | | | | | | | | | |
| Reset | 0 | 0 | 0 | 0 | 0 | 0 | 0 | 0 | 0 | 0 | 0 | 0 | 0 | 0 | 0 | 0 |

* Notes:

- MAXADDR0 field: Device specific value indicating amount of implemented flash.
- MAXADDR1 field: Device specific value indicating amount of implemented flash.

SIM_FCFG2 field descriptions

| Field | Description |
|-------------------|---|
| 31 Reserved | This field is reserved. This read-only field is reserved and always has the value 0. |
| 30–24 MAXADDR0 | Max Address lock This field concatenated with 13 trailing zeros indicates the first invalid address of program flash (block 0). For example, if MAXADDR0 = 0x20, the first invalid address of program flash (block 0) is 0x0004_0000. This would be the MAXADDR0 value for a device with 256 KB program flash in flash block 0. |
| 23 Reserved | This field is reserved. This read-only field is reserved and always has the value 1. |
| 22–16 MAXADDR1 | This field concatenated with leading zeros plus the value of the MAXADDR1 field indicates the first invalid address of the second program flash block (flash block 1). For example, if MAXADDR0 = MAXADDR1 = 0x20 the first invalid address of flash block 1 is 0x4_0000 + 0x4_0000. This would be the MAXADDR1 value for a device with 512 KB program flash memory across two flash blocks. so |
| Reserved | This field is reserved. This read-only field is reserved and always has the value 0. |

12.2.14 Unique Identification Register Mid-High (SIM_UIDMH)

Address: 4004_7000h base + 1058h offset = 4004_8058h

| | | | | | | | | | | | | | | | | | | | | | | | | | | | | | | | | | |
|-------|----|----|----|----|----|----|----|----|----|----|----|----|----|----|----|----|-----|----|----|----|----|----|---|---|---|---|---|---|---|---|---|---|---|
| Bit | 31 | 30 | 29 | 28 | 27 | 26 | 25 | 24 | 23 | 22 | 21 | 20 | 19 | 18 | 17 | 16 | 15 | 14 | 13 | 12 | 11 | 10 | 9 | 8 | 7 | 6 | 5 | 4 | 3 | 2 | 1 | 0 | |
| R | 0 | | | | | | | | | | | | | | | | UID | | | | | | | | | | | | | | | | |
| W | | | | | | | | | | | | | | | | | | | | | | | | | | | | | | | | | |
| Reset | 0 | 0 | 0 | 0 | 0 | 0 | 0 | 0 | 0 | 0 | 0 | 0 | 0 | 0 | 0 | 0 | * | * | * | * | * | * | * | * | * | * | * | * | * | * | * | * | * |

* Notes:

- UID field: Device specific value.

SIM_UIDMH field descriptions

| Field | Description |
|-------------------|---|
| 31–16 Reserved | This field is reserved. This read-only field is reserved and always has the value 0. |
| UID | Unique Identification Unique identification for the device. |

12.2.15 Unique Identification Register Mid Low (SIM_UIDML)

Address: 4004_7000h base + 105Ch offset = 4004_805Ch

| | | | | | | | | | | | | | | | | | | | | | | | | | | | | | | | | | |
|-------|-----|----|----|----|----|----|----|----|----|----|----|----|----|----|----|----|----|----|----|----|----|----|---|---|---|---|---|---|---|---|---|---|---|
| Bit | 31 | 30 | 29 | 28 | 27 | 26 | 25 | 24 | 23 | 22 | 21 | 20 | 19 | 18 | 17 | 16 | 15 | 14 | 13 | 12 | 11 | 10 | 9 | 8 | 7 | 6 | 5 | 4 | 3 | 2 | 1 | 0 | |
| R | UID | | | | | | | | | | | | | | | | | | | | | | | | | | | | | | | | |
| W | | | | | | | | | | | | | | | | | | | | | | | | | | | | | | | | | |
| Reset | * | * | * | * | * | * | * | * | * | * | * | * | * | * | * | * | * | * | * | * | * | * | * | * | * | * | * | * | * | * | * | * | * |

* Notes:

- UID field: Device specific value.

SIM_UIDML field descriptions

| Field | Description |
|-------|--|
| UID | Unique Identification Unique identification for the device. |

12.2.16 Unique Identification Register Low (SIM_UIDL)

Address: 4004_7000h base + 1060h offset = 4004_8060h

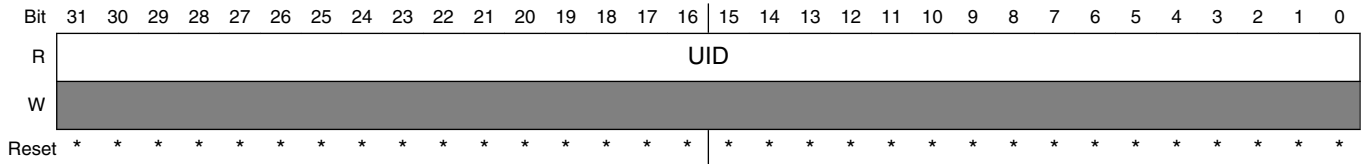

* Notes:

- UID field: Device specific value.

SIM_UIDL field descriptions

| Field | Description |
|-------|--|
| UID | Unique Identification Unique identification for the device. |

12.2.17 COP Control Register (SIM_COPC)

All of the bits in this register can be written only once after a reset, writing this register will also reset the COP counter.

Address: 4004_7000h base + 1100h offset = 4004_8100h

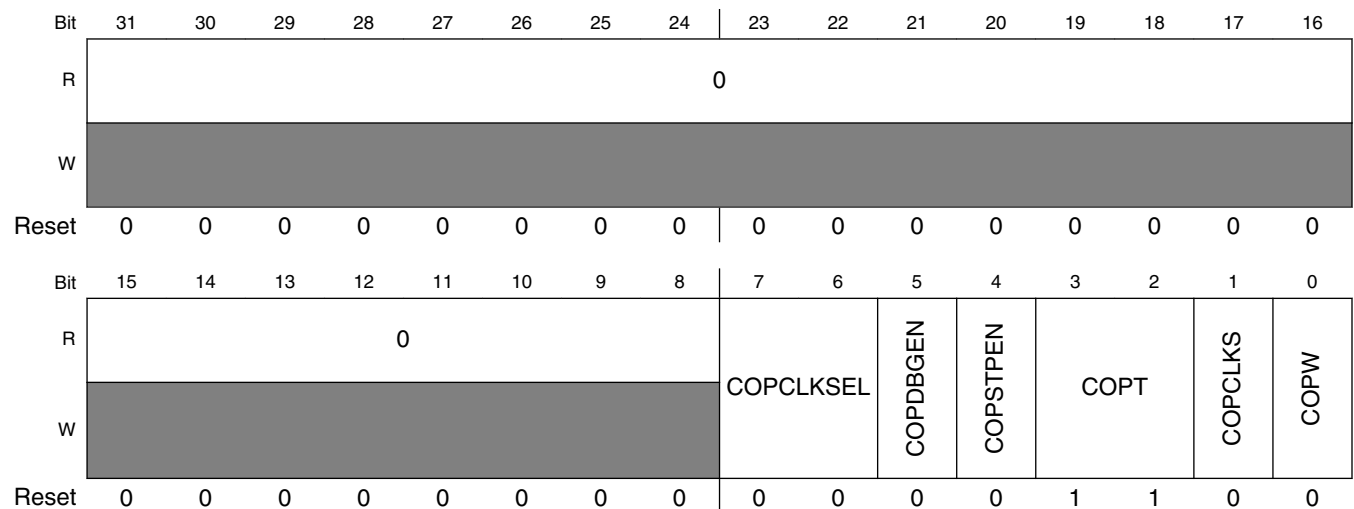

SIM_COPC field descriptions

| Field | Description |
|------------------|--|
| 31–8 Reserved | This field is reserved. This read-only field is reserved and always has the value 0. |
| 7–6 COPCLKSEL | COP Clock Select This write-once field selects the clock source of the COP watchdog. 00 LPO clock (1 kHz) 01 MCGIRCLK 10 OSCERCLK 11 Bus clock |
| 5 COPDBGEN | COP Debug Enable 0 COP is disabled and the counter is reset in Debug mode 1 COP is enabled in Debug mode |
| 4 COPSTPEN | COP Stop Enable 0 COP is disabled and the counter is reset in Stop modes 1 COP is enabled in Stop modes |
| 3–2 COPT | COP Watchdog Timeout This write-once field selects the timeout period of the COP. COPT along with the COPCLKS field define the COP timeout period. 00 COP disabled 01 COP timeout after 2^5 cycles for short timeout or 2^{13} cycles for long timeout 10 COP timeout after 2^8 cycles for short timeout or 2^{16} cycles for long timeout 11 COP timeout after 2^{10} cycles for short timeout or 2^{18} cycles for long timeout |
| 1 COPCLKS | COP Clock Select This write-once field selects between a short timeout or a long timeout, the COP clock source is configured by COPCLKSEL. 0 COP configured for short timeout 1 COP configured for long timeout |
| 0 COPW | COP Windowed Mode Windowed mode is supported for all COP clock sources, but only when the COP is configured for a long timeout. The COP window is opened three quarters through the timeout period and will generate a system reset if the COP is serviced outside of that time. 0 Normal mode 1 Windowed mode |

12.2.18 Service COP (SIM_SRVCOP)

This is write only register, any read to this register will cause transfer error.

Address: 4004_7000h base + 1104h offset = 4004_8104h

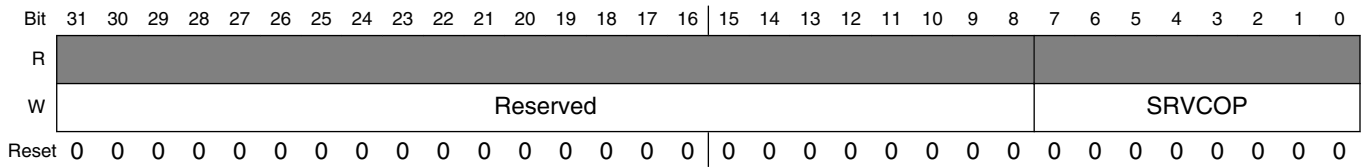

SIM_SRVCOP field descriptions

| Field | Description |
|------------------|--|
| 31–8 Reserved | This field is reserved. |
| SRVCOP | Service COP Register Write 0x55 and then 0xAA (in that order) to reset the COP timeout counter, writing any other value will generate a system reset. |

Chapter 13

System Mode Controller (SMC)

13.1 Introduction

The System Mode Controller (SMC) is responsible for sequencing the system into and out of all low-power Stop and Run modes.

Specifically, it monitors events to trigger transitions between power modes while controlling the power, clocks, and memories of the system to achieve the power consumption and functionality of that mode.

This chapter describes all the available low-power modes, the sequence followed to enter/exit each mode, and the functionality available while in each of the modes.

The SMC is able to function during even the deepest low power modes.

See [AN4503: Power Management for Kinetis MCUs](#) for further details on using the SMC.

13.2 Modes of operation

The ARM CPU has three primary modes of operation:

- Run
- Sleep
- Deep Sleep

The WFI or WFE instruction is used to invoke Sleep and Deep Sleep modes. Run, Wait, and Stop are the common terms used for the primary operating modes of Kinetis microcontrollers.

The following table shows the translation between the ARM CPU modes and the Kinetis MCU power modes.

Modes of operation

| ARM CPU mode | MCU mode |
|--------------|----------|
| Sleep | Wait |
| Deep Sleep | Stop |

Accordingly, the ARM CPU documentation refers to sleep and deep sleep, while the Kinetis MCU documentation normally uses wait and stop.

In addition, Kinetis MCUs also augment Stop, Wait, and Run modes in a number of ways. The power management controller (PMC) contains a run and a stop mode regulator. Run regulation is used in normal run, wait and stop modes. Stop mode regulation is used during all very low power and low leakage modes. During stop mode regulation, the bus frequencies are limited in the very low power modes.

The SMC provides the user with multiple power options. The Very Low Power Run (VLPR) mode can drastically reduce run time power when maximum bus frequency is not required to handle the application needs. From Normal Run mode, the Run Mode (RUNM) field can be modified to change the MCU into VLPR mode when limited frequency is sufficient for the application. From VLPR mode, a corresponding wait (VLPW) and stop (VLPS) mode can be entered.

Depending on the needs of the user application, a variety of stop modes are available that allow the state retention, partial power down or full power down of certain logic and/or memory. I/O states are held in all modes of operation. Several registers are used to configure the various modes of operation for the device.

The following table describes the power modes available for the device.

Table 13-1. Power modes

| Mode | Description |
|------|--|
| RUN | The MCU can be run at full speed and the internal supply is fully regulated, that is, in run regulation. This mode is also referred to as Normal Run mode. |
| WAIT | The core clock is gated off. The system clock continues to operate. Bus clocks, if enabled, continue to operate. Run regulation is maintained. |
| STOP | The core clock is gated off. System clocks to other masters and bus clocks are gated off after all stop acknowledge signals from supporting peripherals are valid. |
| VLPR | The core, system, bus, and flash clock maximum frequencies are restricted in this mode. See the Power Management chapter for details about the maximum allowable frequencies. |
| VLPW | The core clock is gated off. The system, bus, and flash clocks continue to operate, although their maximum frequency is restricted. See the Power Management chapter for details on the maximum allowable frequencies. |
| VLPS | The core clock is gated off. System clocks to other masters and bus clocks are gated off after all stop acknowledge signals from supporting peripherals are valid. |
| LLS3 | The core clock is gated off. System clocks to other masters and bus clocks are gated off after all stop acknowledge signals from supporting peripherals are valid. The MCU is placed in a low |

Table continues on the next page...

Table 13-1. Power modes (continued)

| Mode | Description |
|-------|---|
| | leakage mode by reducing the voltage to internal logic. All system RAM contents, internal logic and I/O states are retained. |
| LLS2 | The core clock is gated off. System clocks to other masters and bus clocks are gated off after all stop acknowledge signals from supporting peripherals are valid. The MCU is placed in a low leakage mode by reducing the voltage to internal logic and powering down the system RAM3 partition. The system RAM2 partition can be optionally retained using STOPCTRL[RAM2PO]. The system RAM1 partition, internal logic and I/O states are retained. ¹ |
| VLLS3 | The core clock is gated off. System clocks to other masters and bus clocks are gated off after all stop acknowledge signals from supporting peripherals are valid. The MCU is placed in a low leakage mode by powering down the internal logic. All system RAM contents are retained and I/O states are held. Internal logic states are not retained. |
| VLLS2 | The core clock is gated off. System clocks to other masters and bus clocks are gated off after all stop acknowledge signals from supporting peripherals are valid. The MCU is placed in a low leakage mode by powering down the internal logic and the system RAM3 partition. The system RAM2 partition can be optionally retained using STOPCTRL[RAM2PO]. The system RAM1 partition contents are retained in this mode. Internal logic states are not retained. ¹ |
| VLLS1 | The core clock is gated off. System clocks to other masters and bus clocks are gated off after all stop acknowledge signals from supporting peripherals are valid. The MCU is placed in a low leakage mode by powering down the internal logic and all system RAM. I/O states are held. Internal logic states are not retained. |
| VLLS0 | The core clock is gated off. System clocks to other masters and bus clocks are gated off after all stop acknowledge signals from supporting peripherals are valid. The MCU is placed in a low leakage mode by powering down the internal logic and all system RAM. I/O states are held. Internal logic states are not retained. The 1kHz LPO clock is disabled and the power on reset (POR) circuit can be optionally enabled using STOPCTRL[PORPO]. |

1. See the devices' chip configuration details for the size and location of the system RAM partitions.

13.3 Memory map and register descriptions

Information about the registers related to the system mode controller can be found here.

Different SMC registers reset on different reset types. Each register's description provides details. For more information about the types of reset on this chip, refer to the Reset section details.

NOTE

The SMC registers can be written only in supervisor mode. Write accesses in user mode are blocked and will result in a bus error.

NOTE

Before executing the WFI instruction, the last register written to must be read back. This ensures that all register writes associated with setting up the low power mode being entered have completed before the MCU enters the low power mode.

Failure to do this may result in the low power mode not being entered correctly.

SMC memory map

| Absolute address (hex) | Register name | Width (in bits) | Access | Reset value | Section/ page |
|------------------------|---|-----------------|--------|-------------|----------------------------|
| 4007_E000 | Power Mode Protection register (SMC_PMPROT) | 8 | R/W | 00h | 13.3.1/290 |
| 4007_E001 | Power Mode Control register (SMC_PMCTRL) | 8 | R/W | 00h | 13.3.2/291 |
| 4007_E002 | Stop Control Register (SMC_STOPCTRL) | 8 | R/W | 03h | 13.3.3/292 |
| 4007_E003 | Power Mode Status register (SMC_PMSTAT) | 8 | R | 01h | 13.3.4/294 |

13.3.1 Power Mode Protection register (SMC_PMPROT)

This register provides protection for entry into any low-power run or stop mode. The enabling of the low-power run or stop mode occurs by configuring the Power Mode Control register (PMCTRL).

The PMPROT register can be written only once after any system reset.

If the MCU is configured for a disallowed or reserved power mode, the MCU remains in its current power mode. For example, if the MCU is in normal RUN mode and AVLP is 0, an attempt to enter VLPR mode using PMCTRL[RUNM] is blocked and PMCTRL[RUNM] remains 00b, indicating the MCU is still in Normal Run mode.

NOTE

This register is reset on Chip Reset not VLLS and by reset types that trigger Chip Reset not VLLS. It is unaffected by reset types that do not trigger Chip Reset not VLLS. See the Reset section details for more information.

Address: 4007_E000h base + 0h offset = 4007_E000h

| | | | | | | | | |
|-------|---|---|------|---|------|---|-------|---|
| Bit | 7 | 6 | 5 | 4 | 3 | 2 | 1 | 0 |
| Read | 0 | 0 | AVLP | 0 | ALLS | 0 | AVLLS | 0 |
| Write | | | | | | | | |
| Reset | 0 | 0 | 0 | 0 | 0 | 0 | 0 | 0 |

SMC_PMPROT field descriptions

| Field | Description |
|---------------|---|
| 7 Reserved | This field is reserved. This read-only field is reserved and always has the value 0. |
| 6 Reserved | This field is reserved. This read-only field is reserved and always has the value 0. |

Table continues on the next page...

SMC_PMPROT field descriptions (continued)

| Field | Description |
|---------------|---|
| 5 AVLP | <p>Allow Very-Low-Power Modes</p> <p>Provided the appropriate control bits are set up in PMCTRL, this write-once field allows the MCU to enter any very-low-power mode (VLPR, VLPW, and VLPS).</p> <p>0 VLPR, VLPW, and VLPS are not allowed. 1 VLPR, VLPW, and VLPS are allowed.</p> |
| 4 Reserved | <p>This field is reserved. This read-only field is reserved and always has the value 0.</p> |
| 3 ALLS | <p>Allow Low-Leakage Stop Mode</p> <p>Provided the appropriate control bits are set up in PMCTRL, this write-once field allows the MCU to enter any low-leakage stop mode (LLS).</p> <p>0 Any LLSx mode is not allowed 1 Any LLSx mode is allowed</p> |
| 2 Reserved | <p>This field is reserved. This read-only field is reserved and always has the value 0.</p> |
| 1 AVLLS | <p>Allow Very-Low-Leakage Stop Mode</p> <p>Provided the appropriate control bits are set up in PMCTRL, this write once bit allows the MCU to enter any very-low-leakage stop mode (VLLSx).</p> <p>0 Any VLLSx mode is not allowed 1 Any VLLSx mode is allowed</p> |
| 0 Reserved | <p>This field is reserved. This read-only field is reserved and always has the value 0.</p> |

13.3.2 Power Mode Control register (SMC_PMCTRL)

The PMCTRL register controls entry into low-power Run and Stop modes, provided that the selected power mode is allowed via an appropriate setting of the protection (PMPROT) register.

NOTE

This register is reset on Chip POR not VLLS and by reset types that trigger Chip POR not VLLS. It is unaffected by reset types that do not trigger Chip POR not VLLS. See the Reset section details for more information.

Address: 4007_E000h base + 1h offset = 4007_E001h

| Bit | 7 | 6 | 5 | 4 | 3 | 2 | 1 | 0 |
|-------|----------|------|---|---|---|-------|-------|---|
| Read | Reserved | RUNM | | | 0 | STOPA | STOPM | |
| Write | Reserved | RUNM | | | 0 | STOPA | STOPM | |
| Reset | 0 | 0 | 0 | 0 | 0 | 0 | 0 | 0 |

SMC_PMCTRL field descriptions

| Field | Description |
|---------------|--|
| 7 Reserved | This field is reserved. This bit is reserved for future expansion. Software should write 0 to this bit to maintain compatibility. |
| 6–5 RUNM | Run Mode Control When written, causes entry into the selected run mode. Writes to this field are blocked if the protection level has not been enabled using the PMPROT register. NOTE: RUNM may be set to VLPR only when PMSTAT=RUN. After being written to VLPR, RUNM should not be written back to RUN until PMSTAT=VLPR. 00 Normal Run mode (RUN) 01 Reserved 10 Very-Low-Power Run mode (VLPR) 11 Reserved |
| 4 Reserved | This field is reserved. This read-only field is reserved and always has the value 0. |
| 3 STOPA | Stop Aborted When set, this read-only status bit indicates an interrupt or reset occurred during the previous stop mode entry sequence, preventing the system from entering that mode. This field is cleared by hardware at the beginning of any stop mode entry sequence and is set if the sequence was aborted. 0 The previous stop mode entry was successful. 1 The previous stop mode entry was aborted. |
| STOPM | Stop Mode Control When written, controls entry into the selected stop mode when Sleep-Now or Sleep-On-Exit mode is entered with SLEEPDEEP=1 . Writes to this field are blocked if the protection level has not been enabled using the PMPROT register. After any system reset, this field is cleared by hardware on any successful write to the PMPROT register. NOTE: When set to VLLSxor LLSx, the LLSM in the STOPCTRL register is used to further select the particular VLLSor LLS submode which will be entered. NOTE: When set to STOP, the PSTOPO bits in the STOPCTRL register can be used to select a Partial Stop mode if desired. 000 Normal Stop (STOP) 001 Reserved 010 Very-Low-Power Stop (VLPS) 011 Low-Leakage Stop (LLSx) 100 Very-Low-Leakage Stop (VLLSx) 101 Reserved 110 Reseved 111 Reserved |

13.3.3 Stop Control Register (SMC_STOPCTRL)

The STOPCTRL register provides various control bits allowing the user to fine tune power consumption during the stop mode selected by the STOPM field.

NOTE

This register is reset on Chip POR not VLLS and by reset types that trigger Chip POR not VLLS. It is unaffected by reset types that do not trigger Chip POR not VLLS. See the Reset section details for more information.

Address: 4007_E000h base + 2h offset = 4007_E002h

| | | | | | | | | |
|-------|--------|---|-------|--------|----------|------|---|---|
| Bit | 7 | 6 | 5 | 4 | 3 | 2 | 1 | 0 |
| Read | PSTOPO | | PORPO | RAM2PO | Reserved | LLSM | | |
| Write | PSTOPO | | PORPO | RAM2PO | Reserved | LLSM | | |
| Reset | 0 | 0 | 0 | 0 | 0 | 0 | 1 | 1 |

SMC_STOPCTRL field descriptions

| Field | Description |
|---------------|---|
| 7–6 PSTOPO | <p>Partial Stop Option</p> <p>These bits control whether a Partial Stop mode is entered when STOPM=STOP. When entering a Partial Stop mode from RUN (or VLPR) mode, the PMC, MCG and flash remain fully powered, allowing the device to wakeup almost instantaneously at the expense of higher power consumption. In PSTOP2, only system clocks are gated allowing peripherals running on bus clock to remain fully functional. In PSTOP1, both system and bus clocks are gated.</p> <p>00 STOP - Normal Stop mode 01 PSTOP1 - Partial Stop with both system and bus clocks disabled 10 PSTOP2 - Partial Stop with system clock disabled and bus clock enabled 11 Reserved</p> |
| 5 PORPO | <p>POR Power Option</p> <p>This bit controls whether the POR detect circuit is enabled in VLLS0 mode.</p> <p>0 POR detect circuit is enabled in VLLS0 1 POR detect circuit is disabled in VLLS0</p> |
| 4 RAM2PO | <p>RAM2 Power Option</p> <p>This bit controls powering of RAM partition 2 in LLS2 or VLLS2 mode.</p> <p>NOTE: See the device's Chip Configuration details for the size and location of RAM partition 2</p> <p>0 RAM2 not powered in LLS2/VLLS2 1 RAM2 powered in LLS2/VLLS2</p> |
| 3 Reserved | <p>This field is reserved.</p> <p>This bit is reserved for future expansion. Software should write 0 to this bit to maintain compatibility.</p> |
| LLSM | <p>LLS or VLLS Mode Control</p> <p>This field controls which LLS or VLLS sub-mode to enter if STOPM = LLSx or VLLSx.</p> <p>000 VLLS0 if PMCTRL[STOPM]=VLLSx, reserved if PMCTRL[STOPM]=LLSx 001 VLLS1 if PMCTRL[STOPM]=VLLSx, reserved if PMCTRL[STOPM]=LLSx 010 VLLS2 if PMCTRL[STOPM]=VLLSx, LLS2 if PMCTRL[STOPM]=LLSx 011 VLLS3 if PMCTRL[STOPM]=VLLSx, LLS3 if PMCTRL[STOPM]=LLSx 100 Reserved</p> |

Table continues on the next page...

SMC_STOPCTRL field descriptions (continued)

| Field | Description |
|-------|-------------|
| 101 | Reserved |
| 110 | Reserved |
| 111 | Reserved |

13.3.4 Power Mode Status register (SMC_PMSTAT)

PMSTAT is a read-only, one-hot register which indicates the current power mode of the system.

NOTE

This register is reset on Chip POR not VLLS and by reset types that trigger Chip POR not VLLS. It is unaffected by reset types that do not trigger Chip POR not VLLS. See the Reset section details for more information.

Address: 4007_E000h base + 3h offset = 4007_E003h

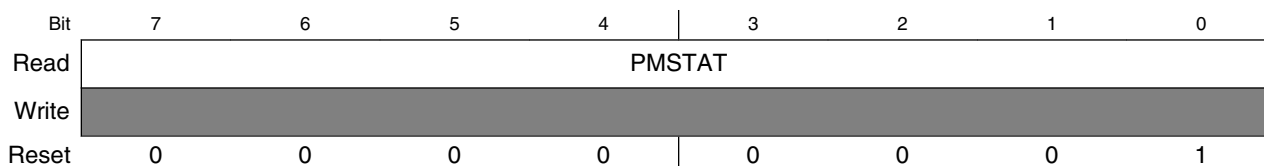

SMC_PMSTAT field descriptions

| Field | Description |
|--------|--|
| PMSTAT | <p>Power Mode Status</p> <p>NOTE: When debug is enabled, the PMSTAT will not update to STOP or VLPS</p> <p>NOTE: When a PSTOP mode is enabled, the PMSTAT will not update to STOP or VLPS</p> <p>0000_0001 Current power mode is RUN.</p> <p>0000_0010 Current power mode is STOP.</p> <p>0000_0100 Current power mode is VLPR.</p> <p>0000_1000 Current power mode is VLPW.</p> <p>0001_0000 Current power mode is VLPS.</p> <p>0010_0000 Current power mode is LLS.</p> <p>0100_0000 Current power mode is VLLS.</p> <p>1000_0000 Reserved</p> |

13.4 Functional description

13.4.1 Power mode transitions

The following figure shows the power mode state transitions available on the chip. Any reset always brings the MCU back to the normal RUN state.

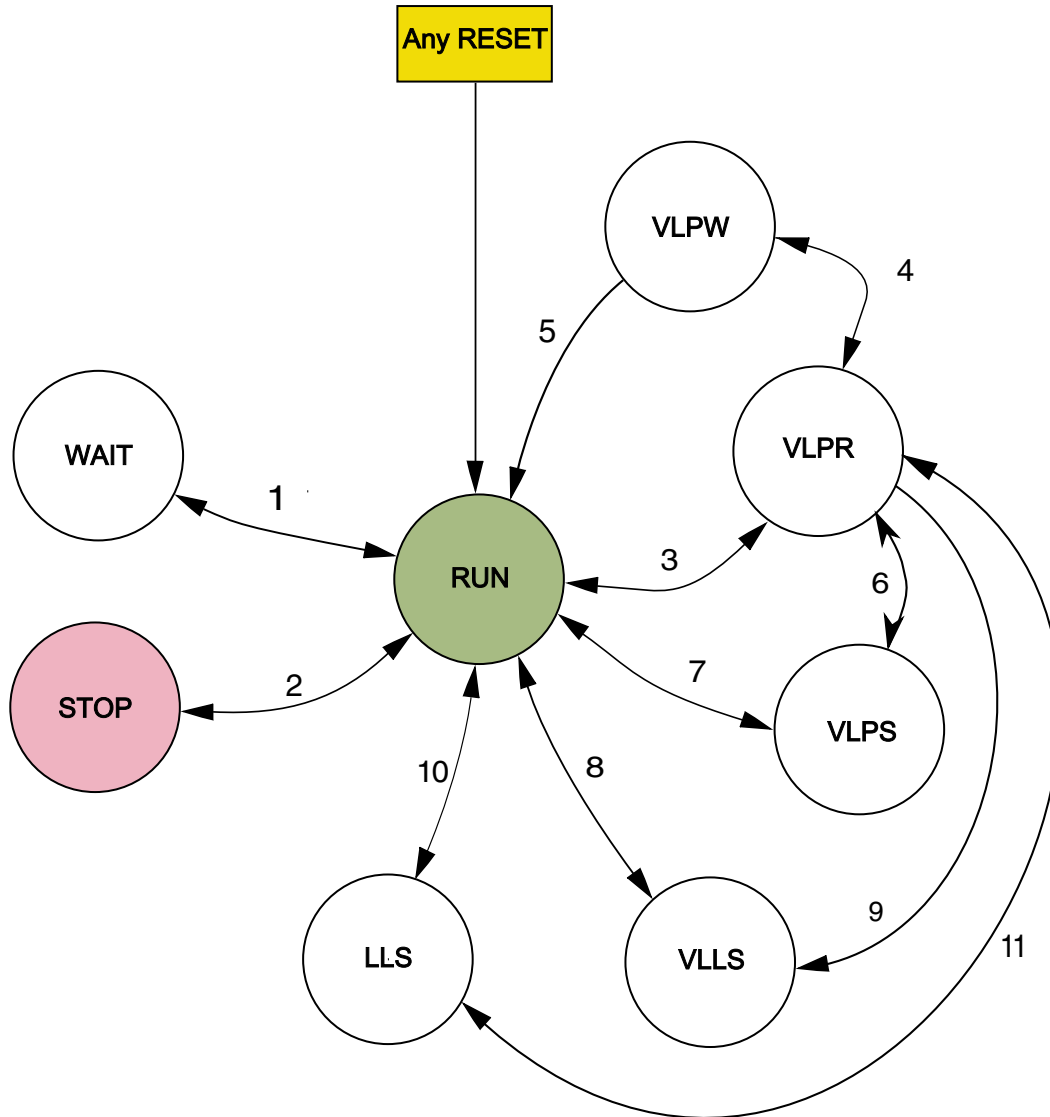

Figure 13-1. Power mode state diagram

The following table defines triggers for the various state transitions shown in the previous figure.

Table 13-2. Power mode transition triggers

| Transition # | From | To | Trigger conditions |
|--------------|-------|-------|--|
| 1 | RUN | WAIT | Sleep-now or sleep-on-exit modes entered with SLEEPDEEP clear, controlled in System Control Register in ARM core. See note. |
| | WAIT | RUN | Interrupt or Reset |
| 2 | RUN | STOP | PMCTRL[RUNM]=00, PMCTRL[STOPM]=000 ² Sleep-now or sleep-on-exit modes entered with SLEEPDEEP set, which is controlled in System Control Register in ARM core. See note. ¹ |
| | STOP | RUN | Interrupt or Reset |
| 3 | RUN | VLPR | The core, system, bus and flash clock frequencies and MCG clocking mode are restricted in this mode. See the Power Management chapter for the maximum allowable frequencies and MCG modes supported. Set PMPROT[AVLP]=1, PMCTRL[RUNM]=10. |
| | VLPR | RUN | Set PMCTRL[RUNM]=00 or Reset. |
| 4 | VLPR | VLPW | Sleep-now or sleep-on-exit modes entered with SLEEPDEEP clear, which is controlled in System Control Register in ARM core. See note. ¹ |
| | VLPW | VLPR | Interrupt |
| 5 | VLPW | RUN | Reset |
| 6 | VLPR | VLPS | PMCTRL[STOPM]=000 ³ or 010, Sleep-now or sleep-on-exit modes entered with SLEEPDEEP set, which is controlled in System Control Register in ARM core. See note. ¹ |
| | VLPS | VLPR | Interrupt NOTE: If VLPS was entered directly from RUN (transition #4), hardware forces exit back to RUN and does not allow a transition to VLPR. |
| 7 | RUN | VLPS | PMPROT[AVLP]=1, PMCTRL[STOPM]=010, Sleep-now or sleep-on-exit modes entered with SLEEPDEEP set, which is controlled in System Control Register in ARM core. See note. ¹ |
| | VLPS | RUN | Interrupt and VLPS mode was entered directly from RUN or Reset |
| 8 | RUN | VLLSx | PMPROT[AVLLS]=1, PMCTRL[STOPM]=100, STOPCTRL[LLSM]=x (VLLSx), Sleep-now or sleep-on-exit modes entered with SLEEPDEEP set, which is controlled in System Control Register in ARM core. |
| | VLLSx | RUN | Wakeup from enabled LLWU input source or RESET pin |

Table continues on the next page...

Table 13-2. Power mode transition triggers (continued)

| Transition # | From | To | Trigger conditions |
|--------------|------|-------|---|
| 9 | VLPR | VLLSx | PMPROT[AVLLS]=1, PMCTRL[STOPM]=100, STOPCTRL[LLSM]=x (VLLSx), Sleep-now or sleep-on-exit modes entered with SLEEPDEEP set, which is controlled in System Control Register in ARM core. |
| 10 | RUN | LLSx | PMPROT[ALLS]=1, PMCTRL[STOPM]=011, STOPCTRL[LLSM]=x (LLSx), Sleep-now or sleep-on-exit modes entered with SLEEPDEEP set, which is controlled in System Control Register in ARM core. |
| | LLSx | RUN | Wakeup from enabled LLWU input source and LLSx mode was entered directly from RUN or RESET pin. |
| 11 | VLPR | LLSx | PMPROT[ALLS]=1, PMCTRL[STOPM]=011, Sleep-now or sleep-on-exit modes entered with SLEEPDEEP set, which is controlled in System Control Register in ARM core. |
| | LLSx | VLPR | Wakeup from enabled LLWU input source and LLSx mode was entered directly from VLPR NOTE: If LLSx was entered directly from RUN, hardware will not allow this transition and will force exit back to RUN |

1. If debug is enabled, the core clock remains to support debug.
2. If PMCTRL[STOPM]=000 and STOPCTRL[PSTOPO]=01 or 10, then only a Partial Stop mode is entered instead of STOP
3. If PMCTRL[STOPM]=000 and STOPCTRL[PSTOPO]=00, then VLPS mode is entered instead of STOP. If PMCTRL[STOPM]=000 and STOPCTRL[PSTOPO]=01 or 10, then only a Partial Stop mode is entered instead of VLPS

13.4.2 Power mode entry/exit sequencing

When entering or exiting low-power modes, the system must conform to an orderly sequence to manage transitions safely.

The SMC manages the system's entry into and exit from all power modes. This diagram illustrates the connections of the SMC with other system components in the chip that are necessary to sequence the system through all power modes.

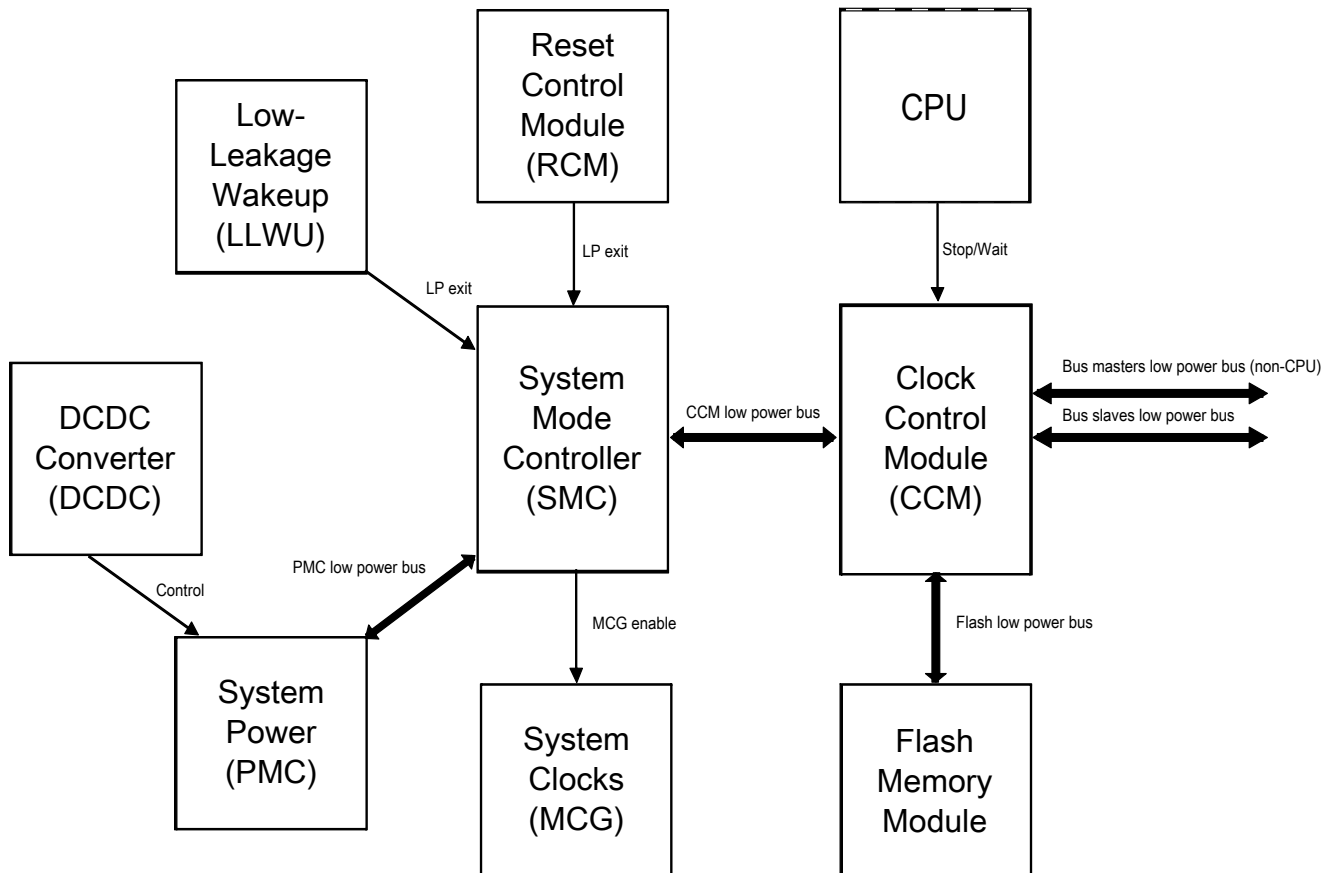

Figure 13-2. Low-power system components and connections

13.4.2.1 Stop mode entry sequence

Entry into a low-power stop mode (Stop, VLPS, LLS, VLLSx) is initiated by a CPU executing the WFI instruction. After the instruction is executed, the following sequence occurs:

1. The CPU clock is gated off immediately.
2. Requests are made to all non-CPU bus masters to enter Stop mode.
3. After all masters have acknowledged they are ready to enter Stop mode, requests are made to all bus slaves to enter Stop mode.
4. After all slaves have acknowledged they are ready to enter Stop mode, all system and bus clocks are gated off.
5. Clock generators are disabled in the MCG.
6. The on-chip regulator in the PMC and internal power switches are configured to meet the power consumption goals for the targeted low-power mode.

13.4.2.2 Stop mode exit sequence

Exit from a low-power stop mode is initiated either by a reset or an interrupt event. The following sequence then executes to restore the system to a run mode (RUN or VLPR):

1. The on-chip regulator in the PMC and internal power switches are restored.
2. Clock generators are enabled in the MCG.
3. System and bus clocks are enabled to all masters and slaves.
4. The CPU clock is enabled and the CPU begins servicing the reset or interrupt that initiated the exit from the low-power stop mode.

13.4.2.3 Aborted stop mode entry

If an interrupt or a reset occurs during a stop entry sequence, the SMC can abort the transition early and return to RUN mode without completely entering the stop mode. An aborted entry is possible only if the reset or interrupt occurs before the PMC begins the transition to stop mode regulation. After this point, the interrupt or reset is ignored until the PMC has completed its transition to stop mode regulation. When an aborted stop mode entry sequence occurs, SMC_PMCTRL[STOPA] is set to 1.

13.4.2.4 Transition to wait modes

For wait modes (WAIT and VLPW), the CPU clock is gated off while all other clocking continues, as in RUN and VLPR mode operation. Some modules that support stop-in-wait functionality have their clocks disabled in these configurations.

13.4.2.5 Transition from stop modes to Debug mode

The debugger module supports a transition from STOP, WAIT, VLPS, and VLPW back to a Halted state when the debugger has been enabled. As part of this transition, system clocking is re-established and is equivalent to the normal RUN and VLPR mode clocking configuration.

13.4.3 Run modes

The run modes supported by this device can be found here.

- Run (RUN)
- Very Low-Power Run (VLPR)

13.4.3.1 RUN mode

This is the normal operating mode for the device.

This mode is selected after any reset. When the ARM processor exits reset, it sets up the stack, program counter (PC), and link register (LR):

- The processor reads the start SP (SP_main) from vector-table offset 0x000
- The processor reads the start PC from vector-table offset 0x004
- LR is set to 0xFFFF_FFFF.

To reduce power in this mode, disable the clocks to unused modules.

13.4.3.2 Very-Low Power Run (VLPR) mode

In VLPR mode, the on-chip voltage regulator is put into a stop mode regulation state. In this state, the regulator is designed to supply enough current to the MCU over a reduced frequency. To further reduce power in this mode, disable the clocks to unused modules using their corresponding clock gating control bits in the SIM's registers.

Before entering this mode, the following conditions must be met:

- The MCG must be configured in a mode which is supported during VLPR. See the Power Management details for information about these MCG modes.
- All clock monitors in the MCG must be disabled.
- The maximum frequencies of the system, bus, flash, and core are restricted. See the Power Management details about which frequencies are supported.
- Mode protection must be set to allow VLP modes, that is, PMPROT[AVLP] is 1.
- PMCTRL[RUNM] must be set to 10b to enter VLPR.
- Flash programming/erasing is not allowed.

NOTE

Do not increase the clock frequency while in VLPR mode, because the regulator is slow in responding and cannot manage fast load transitions. In addition, do not modify the clock source in the MCG module or any clock divider registers. Module clock enables in the SIM can be set, but not cleared.

To reenter Normal Run mode, clear PMCTRL[RUNM]. PMSTAT is a read-only status register that can be used to determine when the system has completed an exit to RUN mode. When PMSTAT=RUN, the system is in run regulation and the MCU can run at full speed in any clock mode. If a higher execution frequency is desired, poll PMSTAT until it is set to RUN when returning from VLPR mode.

Any reset always causes an exit from VLPR and returns the device to RUN mode after the MCU exits its reset flow.

13.4.4 Wait modes

This device contains two different wait modes which are listed here.

- Wait
- Very-Low Power Wait (VLPW)

13.4.4.1 WAIT mode

WAIT mode is entered when the ARM core enters the Sleep-Now or Sleep-On-Exit modes while SLEEPDEEP is cleared. The ARM CPU enters a low-power state in which it is not clocked, but peripherals continue to be clocked provided they are enabled.

When an interrupt request occurs, the CPU exits WAIT mode and resumes processing in RUN mode, beginning with the stacking operations leading to the interrupt service routine.

A system reset causes an exit from WAIT mode, returning the device to normal RUN mode.

13.4.4.2 Very-Low-Power Wait (VLPW) mode

VLPW mode is entered by entering the Sleep-Now or Sleep-On-Exit mode while SLEEPDEEP is cleared and the device is in VLPR mode.

In VLPW, the on-chip voltage regulator remains in its stop regulation state. In this state, the regulator is designed to supply enough current to the device at a reduced frequency. To further reduce power in this mode, disable the clocks to unused modules.

VLPR mode restrictions also apply to VLPW.

When an interrupt from VLPW occurs, the device returns to VLPR mode to execute the interrupt service routine.

A system reset causes an exit from VLPW mode, returning the device to normal RUN mode.

13.4.5 Stop modes

This device contains a variety of stop modes to meet your application needs.

The stop modes range from:

- a stopped CPU, with all I/O, logic, and memory states retained, and certain asynchronous mode peripherals operating

to:

- a powered down CPU, with only I/O and a small register file retained, very few asynchronous mode peripherals operating, while the remainder of the MCU is powered down.

The choice of stop mode depends upon the user's application, and how power usage and state retention versus functional needs and recovery time may be traded off.

The various stop modes are selected by setting the appropriate fields in PMPROT and PMCTRL. The selected stop mode is entered during the sleep-now or sleep-on-exit entry with the SLEEPDEEP bit set in the System Control Register in the ARM core.

The available stop modes are:

- Normal Stop (STOP)
- Very-Low Power Stop (VLPS)
- Low-Leakage Stop (LLS)
- Very-Low-Leakage Stop (VLLSx)

13.4.5.1 STOP mode

STOP mode is entered via the sleep-now or sleep-on-exit with the SLEEPDEEP bit set in the System Control Register in the ARM core.

The MCG module can be configured to leave the reference clocks running.

A module capable of providing an asynchronous interrupt to the device takes the device out of STOP mode and returns the device to normal RUN mode. Refer to the device's Power Management chapter for peripheral, I/O, and memory operation in STOP mode. When an interrupt request occurs, the CPU exits STOP mode and resumes processing, beginning with the stacking operations leading to the interrupt service routine.

A system reset will cause an exit from STOP mode, returning the device to normal RUN mode via an MCU reset.

13.4.5.2 Very-Low-Power Stop (VLPS) mode

The two ways in which VLPS mode can be entered are listed here.

- Entry into stop via the sleep-now or sleep-on-exit with the SLEEPDEEP bit set in the System Control Register in the ARM core while the MCU is in VLPR mode and PMCTRL[STOPM] = 010 or 000.
- Entry into stop via the sleep-now or sleep-on-exit with the SLEEPDEEP bit set in the System Control Register in the ARM core while the MCU is in normal RUN mode and PMCTRL[STOPM] = 010. When VLPS is entered directly from RUN mode, exit to VLPR is disabled by hardware and the system will always exit back to RUN.

In VLPS, the on-chip voltage regulator remains in its stop regulation state as in VLPR.

A module capable of providing an asynchronous interrupt to the device takes the device out of VLPS and returns the device to VLPR mode.

A system reset will also cause a VLPS exit, returning the device to normal RUN mode.

13.4.5.3 Low-Leakage Stop (LLSx) modes

This device contains two Low-Leakage Stop modes: LLS3 and LLS2. LLS or LLSx is often used in this document to refer to both modes. All LLS modes can be entered from normal RUN or VLPR modes.

The MCU enters LLS mode if:

- In Sleep-Now or Sleep-On-Exit mode, SLEEPDEEP is set in the System Control Register in the ARM core, and
- The device is configured as shown in [Table 13-2](#).

In LLS, the on-chip voltage regulator is in stop regulation. Most of the peripherals are put in a state-retention mode that does not allow them to operate while in LLS.

Before entering LLS mode, the user should configure the Low-Leakage Wake-up (LLWU) module to enable the desired wake-up sources. The available wake-up sources in LLS are detailed in the chip configuration details for this device.

After wakeup from LLS, the device returns to the run mode from which LLS was entered (either normal RUN or VLPR) with a pending LLWU module interrupt. In the LLWU interrupt service routine (ISR), the user can poll the LLWU module wake-up flags to determine the source of the wakeup.

NOTE

The LLWU interrupt must not be masked by the interrupt controller to avoid a scenario where the system does not fully exit Stop mode on an LLS recovery.

An asserted $\overline{\text{RESET}}$ pin will cause an exit from LLS mode, returning the device to normal RUN mode. When LLS is exiting via the $\overline{\text{RESET}}$ pin, RCM_SRS[PIN] and RCM_SRS[WAKEUP] are set.

13.4.5.4 Very-Low-Leakage Stop (VLLSx) modes

This device contains these very low leakage modes:

- VLLS3
- VLLS2
- VLLS1
- VLLS0

VLLSx is often used in this document to refer to all of these modes.

All VLLSx modes can be entered from normal RUN or VLPR modes.

The MCU enters the configured VLLS mode if:

- In Sleep-Now or Sleep-On-Exit mode, the SLEEPDEEP bit is set in the System Control Register in the ARM core, and
- The device is configured as shown in [Table 13-2](#).

In VLLS, the on-chip voltage regulator is in its stop-regulation state while most digital logic is powered off.

Before entering VLLS mode, the user should configure the Low-Leakage Wake-up (LLWU) module to enable the desired wakeup sources. The available wake-up sources in VLLS are detailed in the chip configuration details for this device.

After wakeup from VLLS, the device returns to normal RUN mode with a pending LLWU interrupt. In the LLWU interrupt service routine (ISR), the user can poll the LLWU module wake-up flags to determine the source of the wake-up.

When entering VLLS, each I/O pin is latched as configured before executing VLLS. Because all digital logic in the MCU is powered off, all port and peripheral data is lost during VLLS. This information must be restored before PMC_REGSC[ACKISO] is set.

An asserted $\overline{\text{RESET}}$ pin will cause an exit from any VLLS mode, returning the device to normal RUN mode. When exiting VLLS via the $\overline{\text{RESET}}$ pin, RCM_SRS[PIN] and RCM_SRS[WAKEUP] are set.

13.4.6 Debug in low power modes

When the MCU is secure, the device disables/limits debugger operation. When the MCU is unsecure, the ARM debugger can assert two power-up request signals:

- System power up, via SYSPWR in the Debug Port Control/Stat register
- Debug power up, via CDBGPWRUPREQ in the Debug Port Control/Stat register

When asserted while in RUN, WAIT, VLPR, or VLPW the mode controller drives a corresponding acknowledge for each signal, that is, both CDBGPWRUPACK and CSYSPWRUPACK. When both requests are asserted, the mode controller handles attempts to enter STOP and VLPS by entering an emulated stop state. In this emulated stop state:

- the regulator is in run regulation,
- the MCG-generated clock source is enabled,
- all system clocks, except the core clock, are disabled,
- the debug module has access to core registers, and
- access to the on-chip peripherals is blocked.

No debug is available while the MCU is in LLS or VLLS modes. LLS is a state-retention mode and all debug operation can continue after waking from LLS, even in cases where system wakeup is due to a system reset event.

Entering into a VLLS mode causes all of the debug controls and settings to be powered off. To give time to the debugger to sync with the MCU, the MDM AP Control Register includes a Very-Low-Leakage Debug Request (VLLDBGREQ) bit that is set to configure the Reset Controller logic to hold the system in reset after the next recovery from a VLLS mode. This bit allows the debugger time to reinitialize the debug module before the debug session continues.

The MDM AP Control Register also includes a Very Low Leakage Debug Acknowledge (VLLDBGACK) bit that is set to release the ARM core being held in reset following a VLLS recovery. The debugger reinitializes all debug IP, and then asserts the VLLDBGACK control bit to allow the RCM to release the ARM core from reset and allow CPU operation to begin.

Functional description

The VLLDBGACK bit is cleared by the debugger (or can be left set as is) or clears automatically due to the reset generated as part of the next VLLS recovery.

Chapter 14

Power Management Controller (PMC)

14.1 Introduction

The power management controller (PMC) contains the internal voltage regulator, power on reset (POR), and low voltage detect system (LVD) for the VDD domain.

See [AN4503: Power Management for Kinetis MCUs](#) for further details on using the PMC.

14.2 Features

A list of included PMC features can be found here.

- Internal voltage regulator
- Active POR providing brown-out detect
- Low-voltage detect (LVD) on VDD supporting two low-voltage trip points with four warning levels per trip point

14.3 Low-voltage detect (LVD) system

This device includes a system to guard against low-voltage conditions on the VDD supply. When the VDD supply falls below a specific trip point, the LVD circuit puts the device into a reset state, preventing the device from attempting to operate below its operating voltage range.

The system is comprised of a power-on reset (POR) circuit and a LVD circuit with a user-selectable trip voltage: high (V_{LVDH}) or low (V_{LVDL}). The trip voltage is selected by `LVDS1[LV DV]`. The LVD is disabled upon entering VLPx, LLS, and VLLSx modes.

Two flags are available to indicate the status of the low-voltage detect system:

- The Low Voltage Detect Flag in the Low Voltage Status and Control 1 Register (LVDSC1[LVDF]) operates in a level sensitive manner. LVDSC1[LVDF] is set when the supply voltage falls below the selected trip point (VLVD). LVDSC1[LVDF] is cleared by writing 1 to LVDSC1[LVDACK], but only if the internal supply has returned above the trip point; otherwise, LVDSC1[LVDF] remains set.
- The Low Voltage Warning Flag (LVWF) in the Low Voltage Status and Control 2 Register (LVDSC2[LVWF]) operates in a level sensitive manner. LVDSC2[LVWF] is set when the supply voltage falls below the selected monitor trip point (VLVW). LVDSC2[LVWF] is cleared by writing one to LVDSC2[LWACK], but only if the internal supply has returned above the trip point; otherwise, LVDSC2[LVWF] remains set.

14.3.1 LVD reset operation

By setting LVDSC1[LVDRE], the LVD generates a reset upon detection of a low-voltage condition. The low-voltage detection threshold is determined by LVDSC1[LVDV]. After an LVD reset occurs, the LVD system holds the MCU in reset until the supply voltage rises above this threshold. The LVD field in the SRS register of the RCM module (RCM_SRS[LVD]) is set following an LVD or power-on reset.

14.3.2 LVD interrupt operation

By configuring the LVD circuit for interrupt operation (LVDSC1[LVDIE] set and LVDSC1[LVDRE] clear), LVDSC1[LVDF] is set and an LVD interrupt request occurs upon detection of a low voltage condition. LVDSC1[LVDF] is cleared by writing 1 to LVDSC1[LVDACK].

14.3.3 Low-voltage warning (LVW) interrupt operation

The LVD system that monitors the VDD supply contains a Low-Voltage Warning Flag (LVWF) in the Low Voltage Detect Status and Control 2 Register to indicate that the supply voltage is approaching, but is above, the LVD voltage. The LVW also has an interrupt, which is enabled by setting LVDSC2[LVWIE]. If enabled, an LVW interrupt request occurs when LVDSC2[LVWF] is set. LVDSC2[LVWF] is cleared by writing 1 to LVDSC2[LWACK].

LVDS2[LVWV] selects one of the four trip voltages:

- Highest: V_{LVW4}
- Two mid-levels: V_{LVW3} and V_{LVW2}
- Lowest: V_{LVW1}

14.4 I/O retention

When in LLS mode, the I/O pins are held in their input or output state.

Upon wakeup, the PMC is re-enabled, goes through a power up sequence to full regulation, and releases the logic from state retention mode. The I/O are released immediately after a wake-up or reset event. In the case of LLS exit via a RESET pin, the I/O default to their reset state.

When in VLLS modes, the I/O states are held on a wake-up event (with the exception of wake-up by reset event) until the wake-up has been acknowledged via a write to REGSC[ACKISO]. In the case of VLLS exit via a RESET pin, the I/O are released and default to their reset state. In this case, no write to REGSC[ACKISO] is needed.

14.5 Memory map and register descriptions

Details about the PMC registers can be found here.

NOTE

Different portions of PMC registers are reset only by particular reset types. Each register's description provides details. For more information about the types of reset on this chip, refer to the Reset section details.

The PMC registers can be written only in supervisor mode. Write accesses in user mode are blocked and will result in a bus error.

PMC memory map

| Absolute address (hex) | Register name | Width (in bits) | Access | Reset value | Section/page |
|------------------------|---|-----------------|--------|-------------|----------------------------|
| 4007_D000 | Low Voltage Detect Status And Control 1 register (PMC_LVDSC1) | 8 | R/W | 10h | 14.5.1/310 |
| 4007_D001 | Low Voltage Detect Status And Control 2 register (PMC_LVDSC2) | 8 | R/W | 00h | 14.5.2/311 |
| 4007_D002 | Regulator Status And Control register (PMC_REGSC) | 8 | R/W | 04h | 14.5.3/312 |

14.5.1 Low Voltage Detect Status And Control 1 register (PMC_LVDSC1)

This register contains status and control bits to support the low voltage detect function. This register should be written during the reset initialization program to set the desired controls even if the desired settings are the same as the reset settings.

While the device is in the very low power or low leakage modes, the LVD system is disabled regardless of LVDSC1 settings. To protect systems that must have LVD always on, configure the Power Mode Protection (PMPROT) register of the SMC module (SMC_PMPROT) to disallow any very low power or low leakage modes from being enabled.

See the device's data sheet for the exact LVD trip voltages.

NOTE

The LVDV bits are reset solely on a POR Only event. The register's other bits are reset on Chip Reset Not VLLS. For more information about these reset types, refer to the Reset section details.

Address: 4007_D000h base + 0h offset = 4007_D000h

| | | | | | | | | |
|-------|------|--------|-------|-------|---|---|------|---|
| Bit | 7 | 6 | 5 | 4 | 3 | 2 | 1 | 0 |
| Read | LVDF | 0 | LVDIE | LVDRE | 0 | | LVDV | |
| Write | | LVDACK | | | | | | |
| Reset | 0 | 0 | 0 | 1 | 0 | 0 | 0 | 0 |

PMC_LVDSC1 field descriptions

| Field | Description |
|-----------|--|
| 7 LVDF | Low-Voltage Detect Flag This read-only status field indicates a low-voltage detect event. |

Table continues on the next page...

PMC_LVDSC1 field descriptions (continued)

| Field | Description |
|-----------------|--|
| | 0 Low-voltage event not detected 1 Low-voltage event detected |
| 6 LVDACK | Low-Voltage Detect Acknowledge This write-only field is used to acknowledge low voltage detection errors. Write 1 to clear LVDF. Reads always return 0. |
| 5 LVDIE | Low-Voltage Detect Interrupt Enable Enables hardware interrupt requests for LVDF. 0 Hardware interrupt disabled (use polling) 1 Request a hardware interrupt when LVDF = 1 |
| 4 LVDRE | Low-Voltage Detect Reset Enable This write-once bit enables LVDF events to generate a hardware reset. Additional writes are ignored. 0 LVDF does not generate hardware resets 1 Force an MCU reset when LVDF = 1 |
| 3–2 Reserved | This field is reserved. This read-only field is reserved and always has the value 0. |
| LVDV | Low-Voltage Detect Voltage Select Selects the LVD trip point voltage (V_{LVD}). 00 Low trip point selected ($V_{LVD} = V_{LVDL}$) 01 High trip point selected ($V_{LVD} = V_{LV DH}$) 10 Reserved 11 Reserved |

14.5.2 Low Voltage Detect Status And Control 2 register (PMC_LVDSC2)

This register contains status and control bits to support the low voltage warning function.

While the device is in the very low power or low leakage modes, the LVD system is disabled regardless of LVDSC2 settings.

See the device's data sheet for the exact LVD trip voltages.

NOTE

The LVW trip voltages depend on LVWV and LVDV.

NOTE

LVWV is reset solely on a POR Only event. The other fields of the register are reset on Chip Reset Not VLLS. For more

information about these reset types, refer to the Reset section details.

Address: 4007_D000h base + 1h offset = 4007_D001h

| | | | | | | | | |
|-------|------|--------|-------|---|---|---|------|---|
| Bit | 7 | 6 | 5 | 4 | 3 | 2 | 1 | 0 |
| Read | LVWF | 0 | LVWIE | 0 | | | LVWV | |
| Write | | LVWACK | | | | | | |
| Reset | 0 | 0 | 0 | 0 | 0 | 0 | 0 | 0 |

PMC_LVDSC2 field descriptions

| Field | Description |
|-----------------|--|
| 7 LVWF | <p>Low-Voltage Warning Flag</p> <p>This read-only status field indicates a low-voltage warning event. LVWF is set when V_{Supply} transitions below the trip point, or after reset and V_{Supply} is already below V_{LVW}. LVWF may be 1 after power-on reset, therefore, to use LVW interrupt function, before enabling LVWIE, LVWF must be cleared by writing LVWACK first.</p> <p>0 Low-voltage warning event not detected 1 Low-voltage warning event detected</p> |
| 6 LVWACK | <p>Low-Voltage Warning Acknowledge</p> <p>This write-only field is used to acknowledge low voltage warning errors. Write 1 to clear LVWF. Reads always return 0.</p> |
| 5 LVWIE | <p>Low-Voltage Warning Interrupt Enable</p> <p>Enables hardware interrupt requests for LVWF.</p> <p>0 Hardware interrupt disabled (use polling) 1 Request a hardware interrupt when LVWF = 1</p> |
| 4–2 Reserved | <p>This field is reserved. This read-only field is reserved and always has the value 0.</p> |
| LVWV | <p>Low-Voltage Warning Voltage Select</p> <p>Selects the LVW trip point voltage (V_{LVW}). The actual voltage for the warning depends on LVDS1[LV DV].</p> <p>00 Low trip point selected ($V_{LVW} = V_{LVW1}$) 01 Mid 1 trip point selected ($V_{LVW} = V_{LVW2}$) 10 Mid 2 trip point selected ($V_{LVW} = V_{LVW3}$) 11 High trip point selected ($V_{LVW} = V_{LVW4}$)</p> |

14.5.3 Regulator Status And Control register (PMC_REGSC)

The PMC contains an internal voltage regulator. The voltage regulator design uses a bandgap reference that is also available through a buffer as input to certain internal peripherals, such as the CMP and ADC. The internal regulator provides a status bit (REGONS) indicating the regulator is in run regulation.

NOTE

This register is reset on Chip Reset Not VLLS and by reset types that trigger Chip Reset not VLLS. See the Reset section details for more information.

Address: 4007_D000h base + 2h offset = 4007_D002h

| Bit | 7 | 6 | 5 | 4 | 3 | 2 | 1 | 0 |
|-------|---|------|----------|------|--------|--------|----------|------|
| Read | 0 | VLPO | Reserved | BGEN | ACKISO | REGONS | Reserved | BGBE |
| Write | | | | | w1c | | | |
| Reset | 0 | 0 | 0 | 0 | 0 | 1 | 0 | 0 |

PMC_REGSC field descriptions

| Field | Description |
|---------------|---|
| 7 Reserved | This field is reserved. This read-only field is reserved and always has the value 0. |
| 6 VLPO | VLPx Option When used in conjunction with BGEN, this bit allows additional clock sources and higher frequency operation (at the cost of higher power) to be selected during VLPx modes. 0 Operating frequencies and MCG clocking modes are restricted during VLPx modes as listed in the Power Management chapter. 1 If BGEN is also set, operating frequencies and MCG clocking modes are unrestricted during VLPx modes. Note that flash access frequency is still restricted however. |
| 5 Reserved | This field is reserved. |
| 4 BGEN | Bandgap Enable In VLPx Operation BGEN controls whether the bandgap is enabled in lower power modes of operation (VLPx, LLS, and VLLSx). When on-chip peripherals require the bandgap voltage reference in low power modes of operation, set BGEN to continue to enable the bandgap operation. NOTE: When the bandgap voltage reference is not needed in low power modes, clear BGEN to avoid excess power consumption. 0 Bandgap voltage reference is disabled in VLPx , LLS , and VLLSx modes. 1 Bandgap voltage reference is enabled in VLPx , LLS , and VLLSx modes. |
| 3 ACKISO | Acknowledge Isolation Reading this field indicates whether certain peripherals and the I/O pads are in a latched state as a result of having been in a VLLS mode. Writing 1 to this field when it is set releases the I/O pads and certain peripherals to their normal run mode state. NOTE: After recovering from a VLLS mode, user should restore chip configuration before clearing ACKISO. In particular, pin configuration for enabled LLWU wakeup pins should be restored to avoid any LLWU flag from being falsely set when ACKISO is cleared. 0 Peripherals and I/O pads are in normal run state. 1 Certain peripherals and I/O pads are in an isolated and latched state. |
| 2 REGONS | Regulator In Run Regulation Status This read-only field provides the current status of the internal voltage regulator. |

Table continues on the next page...

PMC_REGSC field descriptions (continued)

| Field | Description |
|---------------|--|
| | 0 Regulator is in stop regulation or in transition to/from it 1 Regulator is in run regulation |
| 1 Reserved | This field is reserved. NOTE: This reserved bit must remain cleared (set to 0). |
| 0 BGBE | Bandgap Buffer Enable Enables the bandgap buffer. 0 Bandgap buffer not enabled 1 Bandgap buffer enabled |

Chapter 15

DCDC Converter (DCDC)

15.1 Introduction

15.2 Features

The DCDC module includes the following features:

- Single inductor, multiple outputs.
- Buck or Boost modes (pin selectable: CFG = VBAT → buck; CFG = 0 → boost). This is only configurable through hardware.
- Continuous or pulsed operation (software configurable).
- Power switch input pin to allow external control of power up in buck manual start mode.
- Scaled battery output voltage suitable for analog-to-digital converter (ADC) utilization.
- Internal oscillator for support where the crystal oscillator is not present.

15.3 Block diagram

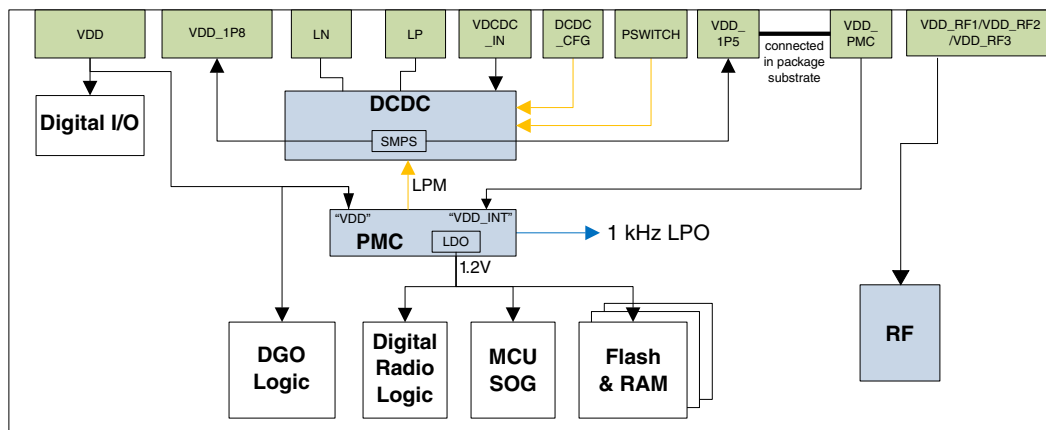

Figure 15-1. DCDC block Diagram

15.4 Functional Description

The DCDC converter module is a switching mode DCDC converter supporting Buck, Boost and Bypass mode. It only requires single inductor to produce multiple switching outputs. The converter can be operated in continuous or pulsed mode. It is configurable through internal registers. An internal oscillator is included for use case where external oscillator is not available.

The DCDC converter produces two switching outputs in Buck and Boost modes . They are VDD_1P5 and VDD_1P8.

Selection of operating mode is done by setting the pin DCDC_CFG. VDD_1P5 regulated output supplies the radio block and the SOG (Sea of Gates). VDD_1P8 regulated output supplies the rest of the device. VDD_1P8 output can feed external circuitry. Refer to the part specific datasheet for current limits on VDD_1P8.

In Boost mode, the VDD_1P5 will be 1.8 V by default. Software needs to measure the battery voltage with minimal load, before changing the output voltage. The output target voltage must be 50 mV higher than battery voltage. For example, when the battery voltage is less than 1.4 V, the target output voltage must be set to 1.45 V. If the target voltage is set to lower than the battery voltage, it may trigger PMC low voltage reset.

PSWITCH pin can be used to wakeup the DCDC converter in buck mode. When the PSWITCH voltage (with respect to GND) reaches the threshold voltage (V_{IH} with respect to VDCDC_IN), the DCDC will begin regulation. After the DCDC turn-on time has expired ($T_{DCDC_ON_BUCK}$), the PSWITCH voltage may be removed if manual mode operation is desired. Note that the application design must ensure that VDCDC_IN comes up before the PSWITCH voltage and the PSWITCH voltage must not exceed VDCDC_IN.

15.5 Application Requirements

Continuous mode

In continuous mode, the control loop of the DCDC converter is always outputting a PWM signal which charges the tank capacitor to the target voltage. Continuous mode is the default setting for the DCDC and the DCDC is always in continuous mode when the device is in normal RUN, or HSRUN (if HSRUN is available). Continuous mode is optionally available in VLPR, VLPW, or VLPS and never available for LLS mode, or VLLSx modes.

The following register settings are required to ensure optimum DCDC operation in continuous mode:

- DCDC_REG1[DCDC_LOOPCTRL_EN_DF_HYST] = 1
- DCDC_REG1[DCDC_LOOPCTRL_EN_CM_HYST] = 1
- DCDC_REG2[DCDC_LOOPCTRL_HYST_SIGN] = 1

In boost mode, POSLIMIT_BOOST_IN is set to small value by default to limit startup voltage. It should be set to 0x12 after startup, to provide high current to output, especially when battery voltage is low.

Target voltage adjustment

To adjust target voltage of VDD_1P8 and VDD_1P5 the following steps must be followed:

1. Clear DCDC_VDD1P8CTRL_DISABLE_STEP and DCDC_VDD1P5CTRL_DISABLE_STEP
2. Set the target register bits, DCDC_VDD1P5CTRL_TRG_BOOST, DCDC_VDD1P5CTRL_TRG_BUCK and DCDC_VDD1P8CTRL_TRG as per the bitfield values.

DCDC_STS_DC_OK bit will be de-asserted after target register changes. After the output voltage settles to the new target value, DCDC_STS_DC_OK will be asserted.

NOTE

DCDC output voltage can be modified only in continuous mode.

Pulsed mode

In pulsed mode, the control loop of the DCDC converter only turns on the PWM signal which charges the tank capacitor when the output voltage drops below a specified level (defined by the hysteresis level specified in `DCDC_REG0[DCDC_LP_STATE_HYS_L]`). The PWM charging signal will then turn off once the output voltage has reached the target voltage (defined by the hysteresis level specified in `DCDC_REG0[DCDC_LP_STATE_HYS_H]`). Pulse mode is only available in low power modes (VLPR, VLPW, VLPS, LLS, or VLLSx modes) and will only be effective for light loads on the DCDC (≤ 0.5 mA).

Before entering pulsed mode, must set `DCDC_VDD1P8CTRL_DISABLE_STEP` and `DCDC_VDD1P5CTRL_DISABLE_STEP` bit to 1.

The following register settings are required to ensure optimum DCDC operation:

- `DCDC_REG1[DCDC_LOOPCTRL_EN_DF_HYST] = 1`
- `DCDC_REG1[DCDC_LOOPCTRL_EN_CM_HYST] = 1`
- `DCDC_REG2[DCDC_LOOPCTRL_HYST_SIGN] = 1`
- `DCDC_REG0[DCDC_LP_DF_CMP_ENABLE] = 1`

Half/Double FET

When current loading is less than the half FET threshold current, it is recommended to use the half FET mode which can improve efficiency. When current loading is greater than the double FET threshold current, it is recommended to use the double FET mode which can improve the current drive capability and efficiency.

15.6 Assumptions

- PSWITCH cannot be shorted to VBAT in Lithium-ion battery configurations.
- PSWITCH can be shorted to battery (except Lithium-ion battery) for automatic and continuous turn on.
- DCDC remains ON when PSWITCH is connected to VDD. After the DCDC ON time (T_{DCDC_ON}), the PSWITCH state may switch to the low state and the DCDC will remain ON. Software will then be able to shut the DCDC OFF, when PWSITCH is in low state.
- PSWITCH must be asserted until DCDC control stabilizes. If not, DCDC shuts down.
- DCDC receives signal from PMC LVD indicating 1.8 V is good.

- DCDC, when starting, initializes both 1P5 and 1P8 and then the main loop starts. After the DCDC_OK_STATUS bit is asserted, software can change the configuration of the DCDC to the required configuration, which is based on the battery voltage and desired IO configuration.
- DCDC outputs signal that DCDC voltages are above target values.

15.7 Memory map and register definition

15.7.1 DCDC Register Descriptions

All the registers will only be reset to default value after POR reset.

DCDC memory map

| Absolute address (hex) | Register name | Width (in bits) | Access | Reset value | Section/page |
|------------------------|-----------------------------|-----------------|--------|-------------|----------------------------|
| 4005_A000 | DCDC REGISTER 0 (DCDC_REG0) | 32 | R/W | 0418_0000h | 15.7.2/320 |
| 4005_A004 | DCDC REGISTER 1 (DCDC_REG1) | 32 | R/W | 0017_C21Ch | 15.7.3/324 |
| 4005_A008 | DCDC REGISTER 2 (DCDC_REG2) | 32 | R/W | 0000_4009h | 15.7.4/325 |
| 4005_A00C | DCDC REGISTER 3 (DCDC_REG3) | 32 | R/W | 0000_AA46h | 15.7.5/327 |
| 4005_A010 | DCDC REGISTER 4 (DCDC_REG4) | 32 | R/W | 0000_0000h | 15.7.6/331 |
| 4005_A018 | DCDC REGISTER 6 (DCDC_REG6) | 32 | R/W | 0000_0000h | 15.7.7/332 |
| 4005_A01C | DCDC REGISTER 7 (DCDC_REG7) | 32 | R/W | 0000_0000h | 15.7.8/333 |

15.7.2 DCDC REGISTER 0 (DCDC_REG0)

Address: 4005_A000h base + 0h offset = 4005_A000h

| Bit | 31 | 30 | 29 | 28 | 27 | 26 | 25 | 24 | 23 | 22 | 21 | 20 | 19 | 18 | 17 | 16 | | | | | | | | | | | | |
|-------|----------------|----|---------------------|----|---------------------|----|----------------|----|---------------------|----|----------------|----|-------------|----|------------------------|----|--------------------|---|---------------------|---|------------------|---|---------------------|---|---------------------|---|----------|--|
| | DCDC_STS_DC_OK | | VLPW_CONFIG_DCDC_HP | | VLPW_CONFIG_DCDC_HP | | PSWITCH_STATUS | | DCDC_XTALOK_DISABLE | | PWD_CMP_OFFSET | | DCDC_LESS_I | | OFFSET_RSNS_LP_DISABLE | | OFFSET_RSNS_LP_ADJ | | HYST_LP_CMP_DISABLE | | HYST_LP_COMP_ADJ | | DCDC_LP_STATE_HYS_H | | DCDC_LP_STATE_HYS_L | | Reserved | |
| R | | | | | | | | | | | | | | | | | | | | | | | | | | | | |
| W | | | | | | | | | | | | | | | | | | | | | | | | | | | | |
| Reset | 0 | 0 | 0 | 0 | 0 | 1 | 0 | 0 | 0 | 0 | 0 | 0 | 0 | 0 | 0 | 0 | 0 | 1 | 1 | 0 | 0 | 0 | 0 | 0 | 0 | 0 | 0 | |

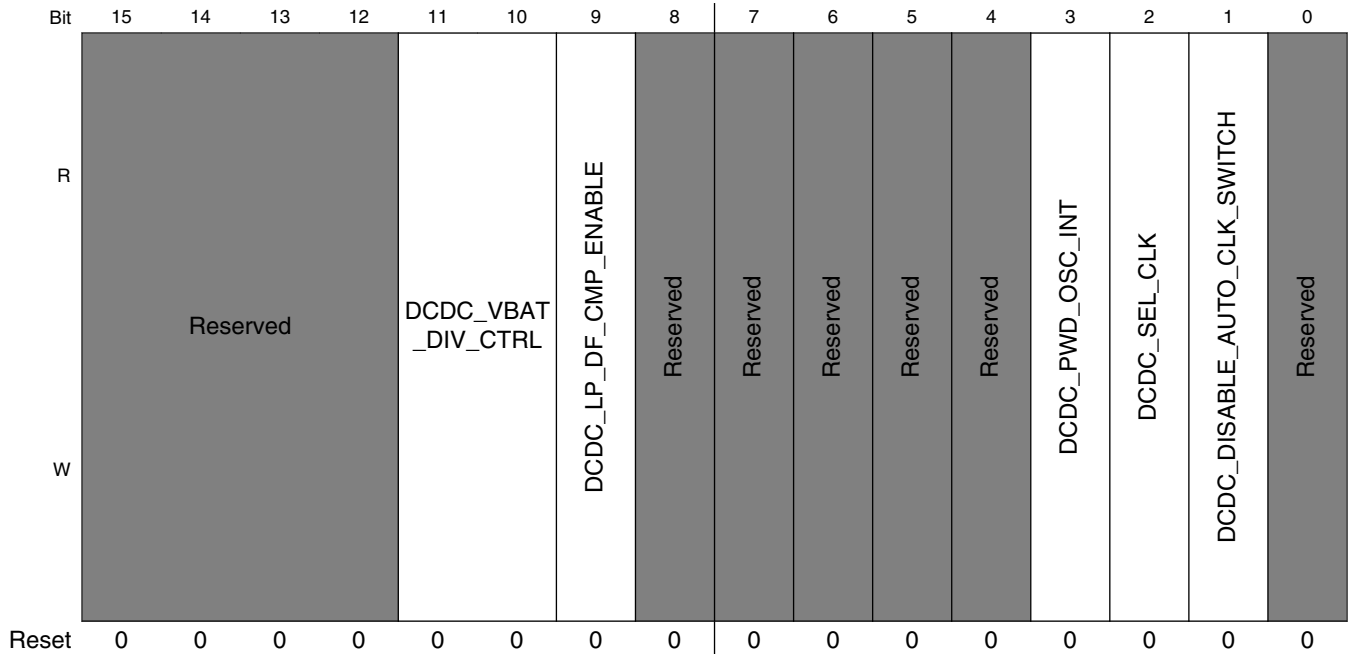

DCDC_REG0 field descriptions

| Field | Description |
|--------------------------------|--|
| 31 DCDC_STS_DC_OK | Status bit to indicate that the DCDC output voltage is stable. The lock time depends on the loading and the DCDC mode. When changing output voltage target, it will take approximately (0.5 ms* target change steps). In pulsed mode, it will take approximately 5 ms. In startup, it will take approximately 50 ms. 0 Unstable DCDC output voltage 1 Stable DCDC output voltage |
| 30 VLPR_VLPW_CONFIG_DCDC_HP | Selects behavior of DCDC in device VLPR and VLPW low power modes. Pulsed mode is a lower power mode. It can be used if the loads are small (<=0.5mA) in VLPx modes. NOTE: This bit should only be changed in RUN mode. 0 DCDC works in pulsed mode when SoC is in VLPR / VLPW modes. 1 DCDC works in continuous mode when SoC is in VLPR / VLPW modes. |
| 29 VLPS_CONFIG_DCDC_HP | Selects behavior of DCDC in device VLPS low power mode. Pulsed mode is a lower power mode. It can be used if the loads are small (<=0.5mA) in VLPx modes. 0 DCDC works in pulsed mode when SOC is in VLPS modes. 1 DCDC works in continuous mode when SOC is in VLPS modes. |
| 28 PSWITCH_STATUS | Status bit to indicate PSWITCH status 0 PSWITCH is low 1 PSWITCH is high |
| 27 DCDC_XTALOK_DISABLE | Disable xtalok detection circuit. This is a debug bit which should not be changed in real case. This bit disables the clock 24 MHz reference clock detector. |
| 26 PWD_CMP_OFFSET | Output range comparator monitors the output voltage of DCDC. When the DCDC output voltage is out of range, this comparator will speed up DCDC control loop in an attempt to bring the DCDC output voltage back in range. |

Table continues on the next page...

DCDC_REG0 field descriptions (continued)

| Field | Description |
|------------------------------|---|
| | 0 Output range comparator powered up. 1 Output range comparator powered down. |
| 25 DCDC_LESS_I | Reduces DCDC current by reducing the analog reference current inside the DCDC Converter. As a result, you may see higher ripple amplitude. NOTE: This bit only affects RUN mode. 0 Use normal current for analog references 1 Use reduced current for analog references |
| 24 OFFSET_RSNS_LP_DISABLE | Disable hysteresis in low power voltage sense. NOTE: It is recommended to always ensure that this bit is written with its reset value. 0 Hysteresis feature is enabled 1 Hysteresis feature is disabled |
| 23 OFFSET_RSNS_LP_ADJ | Adjust hysteretic value in low power voltage sense. NOTE: It is recommended to always ensure that this bit is written with its reset value. 0 Adjustment feature is disabled 1 Adjustment feature is enabled |
| 22 HYST_LP_CMP_DISABLE | Disable hysteresis in low power comparator. NOTE: It is recommended to always ensure that this bit is written with its reset value. 0 Hysteresis feature is enabled 1 Hysteresis feature is disabled |
| 21 HYST_LP_COMP_ADJ | Adjust hysteretic value in low power comparator. NOTE: It is recommended to always ensure that this bit is written with its reset value. 0 Adjustment feature is disabled 1 Adjustment feature is enabled |
| 20–19 DCDC_LP_STATE_HYS_H | Configure the hysteretic upper threshold value in low power mode. It determines the hysteretic value of the output voltage in pulsed mode. 00 Target voltage value + 0 mV 01 Target voltage value + 25 mV 10 Target voltage value + 50 mV 11 Target voltage value + 75 mV |
| 18–17 DCDC_LP_STATE_HYS_L | Configure the hysteretic lower threshold value in low power mode. It determines the hysteretic value of the output voltage in pulsed mode. 00 Target voltage value - 0 mV 01 Target voltage value - 25 mV 10 Target voltage value - 50 mV 11 Target voltage value - 75 mV |
| 16 Reserved | This field is reserved. Reserved |
| 15–12 Reserved | This field is reserved. Reserved |

Table continues on the next page...

DCDC_REG0 field descriptions (continued)

| Field | Description |
|-----------------------------------|---|
| 11–10 DCDC_VBAT_DIV_CTRL | Controls VBAT voltage divider. The divided VBAT output is input to an ADC channel which allows the battery voltage to be measured. 00 OFF 01 VBAT 10 VBAT / 2 11 VBAT / 4 |
| 9 DCDC_LP_DF_CMP_ENABLE | Enable low power differential comparators, to sense lower supply in pulsed mode. This can reduce the ripple in pulsed mode. 1 DCDC compare the lower supply(relative to target value) with DCDC_LP_STATE_HYS_L. When it is lower than DCDC_LP_STATE_HYS_L, re-charge output. This is the recommended configuration to guarantee optimal operation 0 DCDC compare the common mode sense of supply(relative to target value) with DCDC_LP_STATE_HYS_L. When it is lower than DCDC_LP_STATE_HYS_L, re-charge output. |
| 8 Reserved | This field is reserved. Reserved |
| 7 Reserved | This field is reserved. Reserved |
| 6 Reserved | This field is reserved. Reserved |
| 5 Reserved | This field is reserved. Reserved |
| 4 Reserved | This field is reserved. Reserved |
| 3 DCDC_PWD_OSC_INT | Power down internal oscillator. Only set this bit when 32M crystal oscillator is available. 0 Internal oscillator is powered up 1 Internal oscillator is powered down |
| 2 DCDC_SEL_CLK | Select external clock for DCDC when DCDC_DISABLE_AUTO_CLK_SWITCH is set. 0 Internal oscillator is used as DCDC clock 1 External oscillator is used as DCDC clock |
| 1 DCDC_DISABLE_AUTO_CLK_SWITCH | Disable automatic clock switch from internal oscillator to external clock. 0 Automatic clock switch feature is enabled 1 Automatic clock switch feature is disabled |
| 0 Reserved | This field is reserved. Reserved |

15.7.3 DCDC REGISTER 1 (DCDC_REG1)

Address: 4005_A000h base + 4h offset = 4005_A004h

| | | | | | | | | | | | | | | | | |
|-------|----------|----|-------------------|----|----|----|----|--------------------------|--------------------------|-----------------------------|-----------------------------|----------|----|----|----|----|
| Bit | 31 | 30 | 29 | 28 | 27 | 26 | 25 | 24 | 23 | 22 | 21 | 20 | 19 | 18 | 17 | 16 |
| R | Reserved | | | | | | | DCDC_LOOPCTRL_EN_DF_HYST | DCDC_LOOPCTRL_EN_CM_HYST | DCDC_LOOPCTRL_DF_HST_THRESH | DCDC_LOOPCTRL_CM_HST_THRESH | Reserved | | | | |
| W | Reserved | | | | | | | | | | | Reserved | | | | |
| Reset | 0 | 0 | 0 | 0 | 0 | 0 | 0 | 0 | 0 | 0 | 0 | 1 | 0 | 1 | 1 | 1 |
| Bit | 15 | 14 | 13 | 12 | 11 | 10 | 9 | 8 | 7 | 6 | 5 | 4 | 3 | 2 | 1 | 0 |
| R | Reserved | | POSLIMIT_BOOST_IN | | | | | | POSLIMIT_BUCK_IN | | | | | | | |
| W | Reserved | | | | | | | | | | | | | | | |
| Reset | 1 | 1 | 0 | 0 | 0 | 0 | 1 | 0 | 0 | 0 | 0 | 1 | 1 | 1 | 0 | 0 |

DCDC_REG1 field descriptions

| Field | Description |
|-----------------------------------|---|
| 31–25 Reserved | This field is reserved. Reserved |
| 24 DCDC_LOOPCTRL_EN_DF_HYST | Enable hysteresis in switching converter differential mode analog comparators. This feature improves transient supply ripple and efficiency. NOTE: Value of this bit needs to be set as explained in Application Requirements . |
| 23 DCDC_LOOPCTRL_EN_CM_HYST | Enable hysteresis in switching converter common mode analog comparators. This feature improves transient supply ripple and efficiency. NOTE: Value of this bit needs to be set as explained in Application Requirements . |
| 22 DCDC_LOOPCTRL_DF_HST_THRESH | Enable hysteresis in switching converter differential mode analog comparators. This feature improves transient supply ripple and efficiency. NOTE: Value of this bit needs to be set as explained in Application Requirements . |
| 21 DCDC_LOOPCTRL_CM_HST_THRESH | Enable hysteresis in switching converter common mode analog comparators. This feature improves transient supply ripple and efficiency. NOTE: Value of this bit needs to be set as explained in Application Requirements . |
| 20–14 Reserved | This field is reserved. Reserved. |

Table continues on the next page...

DCDC_REG1 field descriptions (continued)

| Field | Description |
|-------------------------------|--|
| 13–7 POSLIMIT_ BOOST_IN | Upper limit duty cycle limit in DCDC converter. This field limits the maximum VDDIO achievable for a given battery voltage, and its value may be increased if very low battery operation is met. |
| POSLIMIT_ BUCK_IN | Upper limit duty cycle limit in DCDC converter. This field limits the maximum VDDIO achievable for a given battery voltage, and its value may be increased if very low battery operation is met. |

15.7.4 DCDC REGISTER 2 (DCDC_REG2)

Address: 4005_A000h base + 8h offset = 4005_A008h

| | | | | | | | | | | | | | | | | |
|-------|--------------------------------|----------|-----------------------------|----------|----------|------------------------------|---------------------------|----|----------|----|----|----------|----|----|----|----|
| Bit | 31 | 30 | 29 | 28 | 27 | 26 | 25 | 24 | 23 | 22 | 21 | 20 | 19 | 18 | 17 | 16 |
| R | Reserved | | | | | | DCDC_BATTMONITOR_BATT_VAL | | | | | | | | | |
| W | Reserved | | | | | | DCDC_BATTMONITOR_BATT_VAL | | | | | | | | | |
| Reset | 0 | 0 | 0 | 0 | 0 | 0 | 0 | 0 | 0 | 0 | 0 | 0 | 0 | 0 | 0 | 0 |
| Bit | 15 | 14 | 13 | 12 | 11 | 10 | 9 | 8 | 7 | 6 | 5 | 4 | 3 | 2 | 1 | 0 |
| R | DCDC_BATTMONITOR_ EN_BATADJ | Reserved | DCDC_LOOPCTRL_ HYST_SIGN | Reserved | Reserved | DCDC_LOOPCTRL_EN_ RCSCALE | Reserved | | Reserved | | | Reserved | | | | |
| W | DCDC_BATTMONITOR_ EN_BATADJ | Reserved | DCDC_LOOPCTRL_ HYST_SIGN | Reserved | Reserved | DCDC_LOOPCTRL_EN_ RCSCALE | Reserved | | Reserved | | | Reserved | | | | |
| Reset | 0 | 1 | 0 | 0 | 0 | 0 | 0 | 0 | 0 | 0 | 0 | 0 | 1 | 0 | 0 | 1 |

DCDC_REG2 field descriptions

| Field | Description |
|--|---|
| 31–26 Reserved | This field is reserved. Reserved |
| 25–16 DCDC_ BATTMONITOR_ BATT_VAL | Software should write the VDCDC_IN in this register measured with an 8 mV LSB resolution through the ADC. This value is used by the DCDC converter and must be properly configured before setting EN_BATADJ. The ADC should use the internal battery voltage channel to measure VDCDC_IN. Refer to the chip configuration chapter for battery voltage ADC channel assignment. |
| 15 DCDC_ BATTMONITOR_ EN_BATADJ | This bit enables the DCDC to improve efficiency and minimize ripple using the information from the BATT_VAL field. The BATT_VAL contains accurate information before setting EN_BATADJ. The ADC should use the internal battery voltage channel to measure VDCDC_IN. Refer to the chip configuration chapter for battery voltage ADC channel assignment. |

Table continues on the next page...

DCDC_REG2 field descriptions (continued)

| Field | Description |
|--|--|
| | 0 Disable the usage of the DCDC_BATTMONITOR_BATT_VAL value to calculate DCDC loop control 1 Enable the usage of DCDC_BATTMONITOR_BATT_VAL value to calculate DCDC loop control |
| 14 Reserved | This field is reserved. Reserved |
| 13 DCDC_ LOOPCTRL_ HYST_SIGN | This bit ensures proper switching of DCDC in Pulsed mode and is set in Pulsed mode. 0 Hysteresis sign not inverted 1 Hysteresis sign inverted (proper switching guaranteed) |
| 12 Reserved | This field is reserved. Reserved |
| 11 Reserved | This field is reserved. Reserved |
| 10–9 DCDC_ LOOPCTRL_EN_ RCSCALE | The DCDC_LOOPCTRL_EN_RCSCALE reduces the response time of the DCDC to transient loads. 00 Default response time 01 2 times faster than default 10 4 times faster than default 11 8 times faster than default |
| 8–6 Reserved | This field is reserved. Reserved |
| 5–2 Reserved | This field is reserved. Reserved |
| Reserved | This field is reserved. Reserved |

15.7.5 DCDC REGISTER 3 (DCDC_REG3)

Address: 4005_A000h base + Ch offset = 4005_A00Ch

| Bit | 31 | 30 | 29 | 28 | 27 | 26 | 25 | 24 | 23 | 22 | 21 | 20 | 19 | 18 | 17 | 16 |
|-------|----------|------------------------------|------------------------------|----------|----------|-----------------------|-------------------------|------------------------|------------------------------|--------------------------------|-------------------------------|-----------------------|----|----|----------|----|
| R | Reserved | DCDC_VDD1P8CTRL_DISABLE_STEP | DCDC_VDD1P5CTRL_DISABLE_STEP | Reserved | Reserved | DCDC_MINPWR_HALF_FETS | DCDC_MINPWR_DOUBLE_FETS | DCDC_MINPWR_DC_HALFCLK | DCDC_MINPWR_HALF_FETS_PULSED | DCDC_MINPWR_DOUBLE_FETS_PULSED | DCDC_MINPWR_DC_HALFCLK_PULSED | DCDC_VDD1P5CTRL_ADJTN | | | Reserved | |
| W | | | | | | | | | | | | | | | | |
| Reset | 0 | 0 | 0 | 0 | 0 | 0 | 0 | 0 | 0 | 0 | 0 | 0 | 0 | 0 | 0 | 0 |

Memory map and register definition

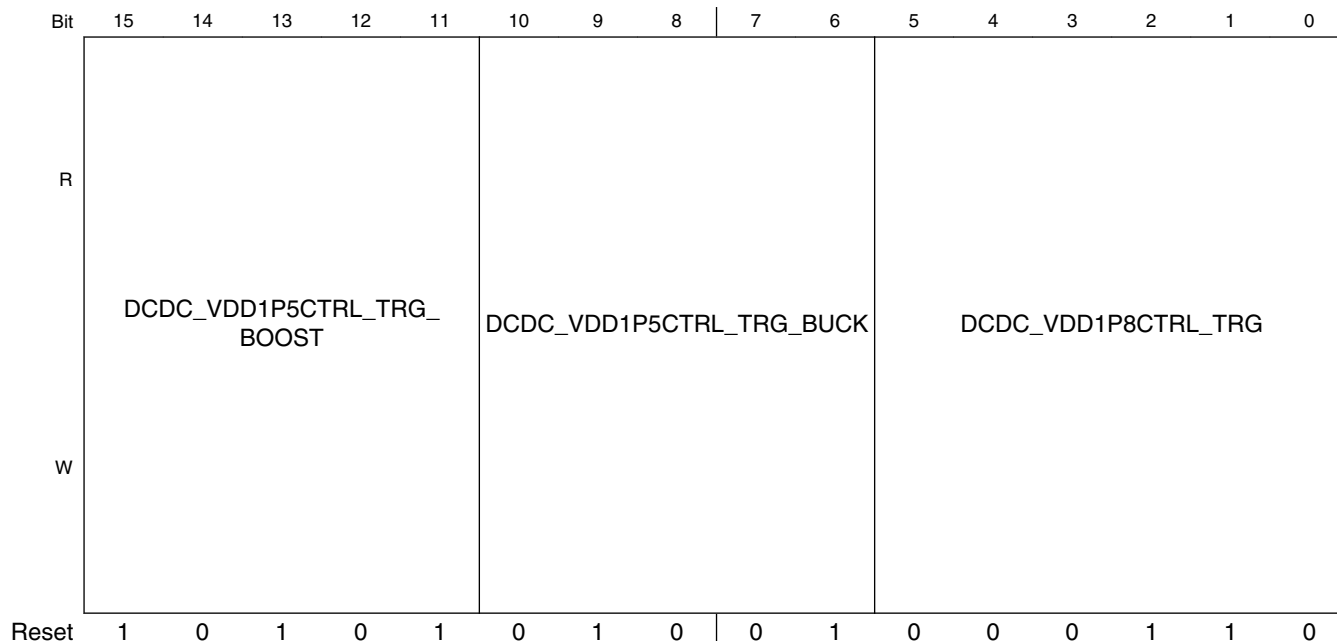

DCDC_REG3 field descriptions

| Field | Description |
|------------------------------------|---|
| 31 Reserved | This field is reserved. Reserved |
| 30 DCDC_VDD1P8CTRL_DISABLE_STEP | Disable stepping for VDD_1P8. Must set this bit before enter low power modes. 0 VDD_1P8 stepping enabled 1 VDD_1P8 stepping disabled |
| 29 DCDC_VDD1P5CTRL_DISABLE_STEP | Disable stepping for VDD_1P5. Must set this bit before enter low power modes. 0 VDD_1P5 stepping enabled 1 VDD_1P5 stepping disabled |
| 28 Reserved | This read-only field is reserved and always has the value 0. This field is reserved. |
| 27 Reserved | This field is reserved. This read-only field is reserved and always has the value 0. |
| 26 DCDC_MINPWR_HALF_FETS | Use half switch FET for the continuous mode. NOTE: Both DCDC_MINPWR_DOUBLE_FETS and DCDC_MINPWR_HALF_FETS fields cannot be set to 1 at the same time. 0 Normal operation 1 Use Half FET |
| 25 DCDC_MINPWR_DOUBLE_FETS | Use double switch FET for the continuous mode. NOTE: Both DCDC_MINPWR_DOUBLE_FETS and DCDC_MINPWR_HALF_FETS fields cannot be set to 1 at the same time. 0 Normal operation 1 Use Double FET |

Table continues on the next page...

DCDC_REG3 field descriptions (continued)

| Field | Description | | | | | | | | | | | | | | | | |
|--|--|------|---------------------------|------|---------|------|---------|------|---------|-----|-----|------|-------|-----|-----|------|-----|
| 24 DCDC_ MINPWR_DC_ HALFCLK | Set DCDC clock to half frequency for the continuous mode. 0 Normal operation for DCDC clock 1 DCDC clock operates at half frequency | | | | | | | | | | | | | | | | |
| 23 DCDC_ MINPWR_HALF_ FETS_PULSED | Use half switch FET for the Pulsed mode. NOTE: Both DCDC_MINPWR_DOUBLE_FETS_PULSED and DCDC_MINPWR_HALF_FETS_PULSED fields cannot be set to 1 at the same time. 0 Pulsed mode uses normal output configuration 1 Pulsed mode uses half FET output configuration | | | | | | | | | | | | | | | | |
| 22 DCDC_ MINPWR_ DOUBLE_FETS_ PULSED | Use double switch FET for the Pulsed mode. NOTE: Both DCDC_MINPWR_DOUBLE_FETS_PULSED and DCDC_MINPWR_HALF_FETS_PULSED fields cannot be set to 1 at the same time. 0 Pulsed mode uses normal output configuration 1 Pulsed mode uses double FET output configuration | | | | | | | | | | | | | | | | |
| 21 DCDC_ MINPWR_DC_ HALFCLK_ PULSED | Set DCDC clock to half frequency for the Pulsed mode. 0 Pulsed mode uses normal operation for DCDC clock 1 Pulsed mode uses half frequency DCDC clock operation | | | | | | | | | | | | | | | | |
| 20–17 DCDC_ VDD1P5CTRL_ ADJTN | Adjust value of duty cycle when switching between VDD_1P5 and VDD_1P8. The unit is 1/32 or 3.125%. NOTE: When using the battery monitor feature it is not necessary to set this bit. We recommend using the battery monitor feature. | | | | | | | | | | | | | | | | |
| 16 Reserved | This field is reserved. Reserved | | | | | | | | | | | | | | | | |
| 15–11 DCDC_ VDD1P5CTRL_ TRG_BOOST | Target value of VDD_1P5 in boost mode, 25 mV each step from 0x00 to 0x15. In boost mode, DCDC boosts VDD_1P5 to 1.8 V by default, software needs to measure battery voltage in light load, then adjust the target value accordingly. If the total load current < 10mA, it is considered to be light load. It depends on the internal resistance of the battery type. <table border="1"> <thead> <tr> <th>Code</th> <th>VDD_1P8 Output Target (V)</th> </tr> </thead> <tbody> <tr> <td>0x00</td> <td>1.275 V</td> </tr> <tr> <td>0x01</td> <td>1.300 V</td> </tr> <tr> <td>0x02</td> <td>1.325 V</td> </tr> <tr> <td>...</td> <td>...</td> </tr> <tr> <td>0x15</td> <td>1.8 V</td> </tr> <tr> <td>...</td> <td>...</td> </tr> <tr> <td>0x1D</td> <td>2 V</td> </tr> </tbody> </table> NOTE: Before writing this register, these conditions must be met: 1. DCDC must be in Continuous Mode 2. DCDC_STS_DC_OK bit must be set | Code | VDD_1P8 Output Target (V) | 0x00 | 1.275 V | 0x01 | 1.300 V | 0x02 | 1.325 V | ... | ... | 0x15 | 1.8 V | ... | ... | 0x1D | 2 V |
| Code | VDD_1P8 Output Target (V) | | | | | | | | | | | | | | | | |
| 0x00 | 1.275 V | | | | | | | | | | | | | | | | |
| 0x01 | 1.300 V | | | | | | | | | | | | | | | | |
| 0x02 | 1.325 V | | | | | | | | | | | | | | | | |
| ... | ... | | | | | | | | | | | | | | | | |
| 0x15 | 1.8 V | | | | | | | | | | | | | | | | |
| ... | ... | | | | | | | | | | | | | | | | |
| 0x1D | 2 V | | | | | | | | | | | | | | | | |

Table continues on the next page...

DCDC_REG3 field descriptions (continued)

| Field | Description | | | | | | | | | | | | | | | | | | | | | | | | | | | | | | | | | | |
|--|--|---------------------------|---------------------------|------|---------|------|---------|------|---------|-----|-----|------|---------|------|---------|------|---------|------|---------|------|---------|-----|-----|------|---------|------|---------|------|---------|------|---------|-----|-----|------|---------|
| 10–6 DCDC_ VDD1P5CTRL_ TRG_BUCK | Target value of VDD_1P5 in buck mode, 25 mV each step from 0x00 to 0x0F | | | | | | | | | | | | | | | | | | | | | | | | | | | | | | | | | | |
| | <table border="1"> <thead> <tr> <th>Code</th> <th>VDD_1P8 Output Target (V)</th> </tr> </thead> <tbody> <tr> <td>0x00</td> <td>1.275 V</td> </tr> <tr> <td>0x01</td> <td>1.300 V</td> </tr> <tr> <td>0x02</td> <td>1.325 V</td> </tr> <tr> <td>...</td> <td>...</td> </tr> <tr> <td>0x0F</td> <td>1.65 V</td> </tr> </tbody> </table> | Code | VDD_1P8 Output Target (V) | 0x00 | 1.275 V | 0x01 | 1.300 V | 0x02 | 1.325 V | ... | ... | 0x0F | 1.65 V | | | | | | | | | | | | | | | | | | | | | | |
| | Code | VDD_1P8 Output Target (V) | | | | | | | | | | | | | | | | | | | | | | | | | | | | | | | | | |
| | 0x00 | 1.275 V | | | | | | | | | | | | | | | | | | | | | | | | | | | | | | | | | |
| | 0x01 | 1.300 V | | | | | | | | | | | | | | | | | | | | | | | | | | | | | | | | | |
| | 0x02 | 1.325 V | | | | | | | | | | | | | | | | | | | | | | | | | | | | | | | | | |
| | ... | ... | | | | | | | | | | | | | | | | | | | | | | | | | | | | | | | | | |
| 0x0F | 1.65 V | | | | | | | | | | | | | | | | | | | | | | | | | | | | | | | | | | |
| NOTE: Before writing this register, these conditions must be met: | | | | | | | | | | | | | | | | | | | | | | | | | | | | | | | | | | | |
| 1. DCDC must be in Continuous Mode | | | | | | | | | | | | | | | | | | | | | | | | | | | | | | | | | | | |
| 2. DCDC_STS_DC_OK bit must be set | | | | | | | | | | | | | | | | | | | | | | | | | | | | | | | | | | | |
| DCDC_ VDD1P8CTRL_ TRG | Target value of VDD_1P8 : | | | | | | | | | | | | | | | | | | | | | | | | | | | | | | | | | | |
| | 25 mV each step in two ranges, from 0x00 to 0x11 and 0x20 to 0x3F and 50 mV each step in range from 0x12 to 0x1F. | | | | | | | | | | | | | | | | | | | | | | | | | | | | | | | | | | |
| | <table border="1"> <thead> <tr> <th>Code</th> <th>VDD_1P8 Output Target (V)</th> </tr> </thead> <tbody> <tr> <td>0x00</td> <td>1.650 V</td> </tr> <tr> <td>0x01</td> <td>1.675 V</td> </tr> <tr> <td>0x02</td> <td>1.700 V</td> </tr> <tr> <td>...</td> <td>...</td> </tr> <tr> <td>0x11</td> <td>2.075 V</td> </tr> <tr> <td>0x12</td> <td>2.100 V</td> </tr> <tr> <td>0x13</td> <td>2.150 V</td> </tr> <tr> <td>0x14</td> <td>2.200 V</td> </tr> <tr> <td>0x15</td> <td>2.250 V</td> </tr> <tr> <td>...</td> <td>...</td> </tr> <tr> <td>0x1F</td> <td>2.750 V</td> </tr> <tr> <td>0x20</td> <td>2.800 V</td> </tr> <tr> <td>0x21</td> <td>2.825 V</td> </tr> <tr> <td>0x22</td> <td>2.850 V</td> </tr> <tr> <td>...</td> <td>...</td> </tr> <tr> <td>0x3C</td> <td>3.500 V</td> </tr> </tbody> </table> | Code | VDD_1P8 Output Target (V) | 0x00 | 1.650 V | 0x01 | 1.675 V | 0x02 | 1.700 V | ... | ... | 0x11 | 2.075 V | 0x12 | 2.100 V | 0x13 | 2.150 V | 0x14 | 2.200 V | 0x15 | 2.250 V | ... | ... | 0x1F | 2.750 V | 0x20 | 2.800 V | 0x21 | 2.825 V | 0x22 | 2.850 V | ... | ... | 0x3C | 3.500 V |
| | Code | VDD_1P8 Output Target (V) | | | | | | | | | | | | | | | | | | | | | | | | | | | | | | | | | |
| | 0x00 | 1.650 V | | | | | | | | | | | | | | | | | | | | | | | | | | | | | | | | | |
| | 0x01 | 1.675 V | | | | | | | | | | | | | | | | | | | | | | | | | | | | | | | | | |
| | 0x02 | 1.700 V | | | | | | | | | | | | | | | | | | | | | | | | | | | | | | | | | |
| | ... | ... | | | | | | | | | | | | | | | | | | | | | | | | | | | | | | | | | |
| | 0x11 | 2.075 V | | | | | | | | | | | | | | | | | | | | | | | | | | | | | | | | | |
| | 0x12 | 2.100 V | | | | | | | | | | | | | | | | | | | | | | | | | | | | | | | | | |
| | 0x13 | 2.150 V | | | | | | | | | | | | | | | | | | | | | | | | | | | | | | | | | |
| | 0x14 | 2.200 V | | | | | | | | | | | | | | | | | | | | | | | | | | | | | | | | | |
| | 0x15 | 2.250 V | | | | | | | | | | | | | | | | | | | | | | | | | | | | | | | | | |
| | ... | ... | | | | | | | | | | | | | | | | | | | | | | | | | | | | | | | | | |
| | 0x1F | 2.750 V | | | | | | | | | | | | | | | | | | | | | | | | | | | | | | | | | |
| | 0x20 | 2.800 V | | | | | | | | | | | | | | | | | | | | | | | | | | | | | | | | | |
| | 0x21 | 2.825 V | | | | | | | | | | | | | | | | | | | | | | | | | | | | | | | | | |
| | 0x22 | 2.850 V | | | | | | | | | | | | | | | | | | | | | | | | | | | | | | | | | |
| | ... | ... | | | | | | | | | | | | | | | | | | | | | | | | | | | | | | | | | |
| | 0x3C | 3.500 V | | | | | | | | | | | | | | | | | | | | | | | | | | | | | | | | | |
| NOTE: Before writing this register, these conditions must be met: | | | | | | | | | | | | | | | | | | | | | | | | | | | | | | | | | | | |
| 1. DCDC must be in Continuous Mode | | | | | | | | | | | | | | | | | | | | | | | | | | | | | | | | | | | |
| 2. DCDC_STS_DC_OK bit must be set | | | | | | | | | | | | | | | | | | | | | | | | | | | | | | | | | | | |

15.7.6 DCDC REGISTER 4 (DCDC_REG4)

Address: 4005_A000h base + 10h offset = 4005_A010h



DCDC_REG4 field descriptions

| Field | Description |
|-----------------------|---|
| 31–16 UNLOCK | <p>0x3E77 KEY—Key needed to unlock DCDC_REG4 register. Write 0x3E77 to unlock this register and allow other bits to be changed.</p> <p>NOTE: This register must be unlocked on a write-by-write basis, so the UNLOCK field must contain the correct key value during all writes to this register in order to update any other bit values in the register.</p> |
| 15–1 Reserved | <p>This field is reserved. Reserved</p> |
| 0 DCDC_SW_SHUTDOWN | <p>Shut down DCDC in buck mode. DCDC can be turned on by pulling PSWITCH to high momentarily (DCDC Turn on time (T_{DCDC_ON}; refer to the data sheet for specific time).</p> <p>NOTE DCDC_SW_SHUTDOWN should not be used in boost mode because when user write this bit, MCU won't be POR and enters an abnormal state. This bit should not be used in buck mode when PSWITCH is tied to DCDC_IN.</p> |

15.7.7 DCDC REGISTER 6 (DCDC_REG6)

Address: 4005_A000h base + 18h offset = 4005_A018h

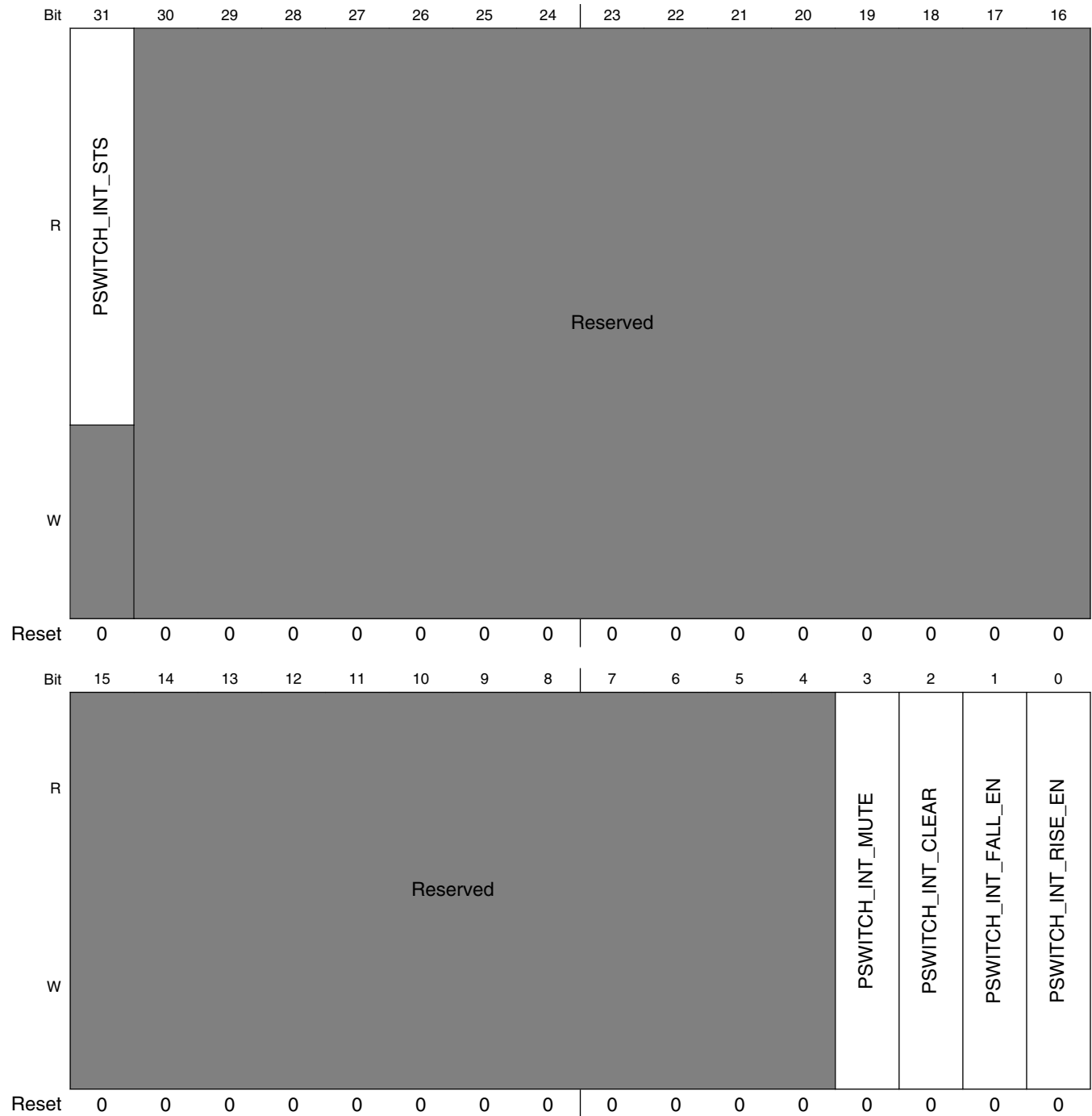

DCDC_REG6 field descriptions

| Field | Description |
|--------------------------|--|
| 31 PSWITCH_INT_STS | PSWITCH edge detection interrupt status. This bit indicates whether or not an interrupt has occurred. This bit is cleared by writing to the PSWITCH_INT_CLEAR bit (DCDC_REG6[PSWITCH_INT_CLEAR]) 0 PSWITCH interrupt has not occurred 1 PSWITCH interrupt has occurred |
| 30–4 Reserved | This field is reserved. Reserved |
| 3 PSWITCH_INT_MUTE | Mask interrupt to SoC, edge detection result can be read from PSWITCH_INT_STS. |
| 2 PSWITCH_INT_CLEAR | This bit clears the PSWITCH interrupt. 0 No effect 1 Clear PSWITCH interrupt |
| 1 PSWITCH_INT_FALL_EN | Enable falling edge detect for interrupt. 0 PSWITCH falling edge interrupt disabled 1 PSWITCH falling edge interrupt enabled |
| 0 PSWITCH_INT_RISE_EN | Enable rising edge detect for interrupt. 0 PSWITCH rising edge interrupt disabled 1 PSWITCH rising edge interrupt enabled |

15.7.8 DCDC REGISTER 7 (DCDC_REG7)

Address: 4005_A000h base + 1Ch offset = 4005_A01Ch

| | | | | | | | | | | | | | | | | |
|-------|------------------|----|----|----|----|----|----|----|----|----|----|-------------------|----------------------|------------------|----|----|
| Bit | 31 | 30 | 29 | 28 | 27 | 26 | 25 | 24 | 23 | 22 | 21 | 20 | 19 | 18 | 17 | 16 |
| R | Reserved | | | | | | | | | | | PULSE_RUN_SPEEDUP | INTEGRATOR_VALUE_SEL | INTEGRATOR_VALUE | | |
| W | | | | | | | | | | | | | | | | |
| Reset | 0 | 0 | 0 | 0 | 0 | 0 | 0 | 0 | 0 | 0 | 0 | 0 | 0 | 0 | 0 | 0 |
| Bit | 15 | 14 | 13 | 12 | 11 | 10 | 9 | 8 | 7 | 6 | 5 | 4 | 3 | 2 | 1 | 0 |
| R | INTEGRATOR_VALUE | | | | | | | | | | | | | | | |
| W | | | | | | | | | | | | | | | | |
| Reset | 0 | 0 | 0 | 0 | 0 | 0 | 0 | 0 | 0 | 0 | 0 | 0 | 0 | 0 | 0 | 0 |

DCDC_REG7 field descriptions

| Field | Description |
|--------------------------------|--|
| 31–21 Reserved | This field is reserved. Reserved |
| 20 PULSE_RUN_ SPEEDUP | Enable pulse run speedup. Before setting this bit, INTEGRATOR_VALUE_SEL must be set to 1 and integrator value must be programmed. 0 Pulse run speedup feature disabled 1 Pulse run speedup feature enabled |
| 19 INTEGRATOR_ VALUE_SEL | Select the integrator value from above register or saved value in hardware. 0 Select the saved value in hardware. 1 Select the integrator value in this register. |
| INTEGRATOR_ VALUE | Integrator value which can be loaded in pulsed mode. Software can program this value according to battery voltage and VDD_1P5 output target value before goes to the pulsed mode. It is signed number. The register value = (Dutycycle * 32 - 16) * 2 ^ 13 For buck mode, dutycycle = VDD_1P5 / VBAT. For boost mode, dutycycle = (VDD_1P5 - VBAT) / VDD_1P5. |

Chapter 16

Low-Leakage Wakeup Unit (LLWU)

16.1 Introduction

The LLWU module allows the user to select up to 16 external pins and up to internal modules as interrupt wake-up sources from low-leakage power modes.

The input sources are described in the device's chip configuration details. Each of the available wake-up sources can be individually enabled.

The $\overline{\text{RESET}}$ pin is an additional source for triggering an exit from low-leakage power modes, and causes the MCU to exit both LLS and VLLS through a reset flow.

The LLWU module also includes two optional digital pin filters for the external wakeup pins.

See [AN4503: Power Management for Kinetis MCUs](#) for further details on using the LLWU.

16.1.1 Features

The LLWU module features include:

- Support for up to 16 external input pins and up to internal modules with individual enable bits for MCU interrupt from low leakage modes
- Input sources may be external pins or from internal peripherals capable of running in LLS or VLLS. See the chip configuration information for wakeup input sources for this device.
- External pin wake-up inputs, each of which is programmable as falling-edge, rising-edge, or any change

- Wake-up inputs that are activated after MCU enters a low-leakage power mode
- Optional digital filters provided to qualify an external pin detect. Note that when the LPO clock is disabled, the filters are disabled and bypassed.

16.1.2 Modes of operation

The LLWU module becomes functional on entry into a low-leakage power mode. After recovery from LLS, the LLWU is immediately disabled. After recovery from VLLS, the LLWU continues to detect wake-up events until the user has acknowledged the wake-up via a write to PMC_REGSC[ACKISO].

16.1.2.1 LLS mode

Wake-up events due to external pin inputs (LLWU_Px) and internal module interrupt inputs (LLWU_MxIF) result in an interrupt flow when exiting LLS.

NOTE

The LLWU interrupt must not be masked by the interrupt controller to avoid a scenario where the system does not fully exit Stop mode on an LLS recovery.

16.1.2.2 VLLS modes

All wakeup and reset events result in VLLS exit via a reset flow.

16.1.2.3 Non-low leakage modes

The LLWU is not active in all non-low leakage modes where detection and control logic are in a static state. The LLWU registers are accessible in non-low leakage modes and are available for configuring and reading status when bus transactions are possible.

When the wake-up pin filters are enabled, filter operation begins immediately. If a low leakage mode is entered within five LPO clock cycles of an active edge, the edge event will be detected by the LLWU.

16.1.2.4 Debug mode

When the chip is in Debug mode and then enters LLS or a VLLSx mode, no debug logic works in the fully-functional low-leakage mode. Upon an exit from the LLS or VLLSx mode, the LLWU becomes inactive.

16.1.3 Block diagram

The following figure is the block diagram for the LLWU module.

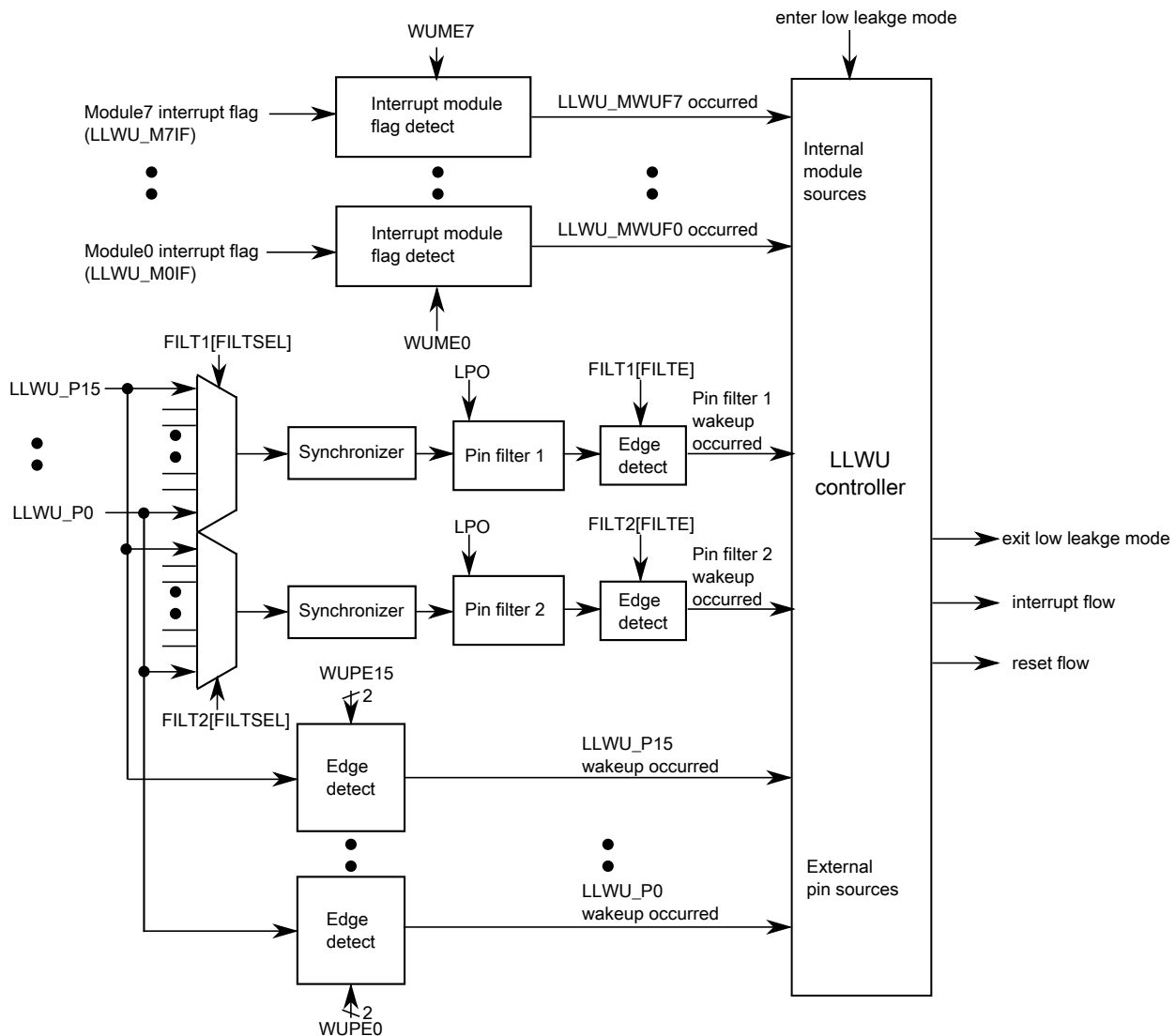

Figure 16-1. LLWU block diagram

16.2 LLWU signal descriptions

The signal properties of LLWU are shown in the table found here.

The external wakeup input pins can be enabled to detect either rising-edge, falling-edge, or on any change.

Table 16-1. LLWU signal descriptions

| Signal | Description | I/O |
|---------|---------------------------|-----|
| LLWU_Pn | Wakeup inputs (n = 0-15) | I |

16.3 Memory map/register definition

The LLWU includes the following registers:

- Wake-up source enable registers
 - Enable external pin input sources
 - Enable internal peripheral interrupt sources
- Wake-up flag registers
 - Indication of wakeup source that caused exit from a low-leakage power mode includes external pin or internal module interrupt
- Wake-up pin filter enable registers

NOTE

The LLWU registers can be written only in supervisor mode. Write accesses in user mode are blocked and will result in a bus error.

All LLWU registers are reset by Chip Reset not VLLS and by reset types that trigger Chip Reset not VLLS. Each register's displayed reset value represents this subset of reset types. LLWU registers are unaffected by reset types that do not trigger Chip Reset not VLLS. For more information about the types of reset on this chip, refer to the [Introduction](#) details.

LLWU memory map

| Absolute address (hex) | Register name | Width (in bits) | Access | Reset value | Section/page |
|------------------------|---|-----------------|--------|-------------|-----------------------------|
| 4007_C000 | LLWU Pin Enable 1 register (LLWU_PE1) | 8 | R/W | 00h | 16.3.1/339 |
| 4007_C001 | LLWU Pin Enable 2 register (LLWU_PE2) | 8 | R/W | 00h | 16.3.2/340 |
| 4007_C002 | LLWU Pin Enable 3 register (LLWU_PE3) | 8 | R/W | 00h | 16.3.3/341 |
| 4007_C003 | LLWU Pin Enable 4 register (LLWU_PE4) | 8 | R/W | 00h | 16.3.4/342 |
| 4007_C004 | LLWU Module Enable register (LLWU_ME) | 8 | R/W | 00h | 16.3.5/343 |
| 4007_C005 | LLWU Flag 1 register (LLWU_F1) | 8 | R/W | 00h | 16.3.6/345 |
| 4007_C006 | LLWU Flag 2 register (LLWU_F2) | 8 | R/W | 00h | 16.3.7/347 |
| 4007_C007 | LLWU Flag 3 register (LLWU_F3) | 8 | R | 00h | 16.3.8/348 |
| 4007_C008 | LLWU Pin Filter 1 register (LLWU_FILT1) | 8 | R/W | 00h | 16.3.9/350 |
| 4007_C009 | LLWU Pin Filter 2 register (LLWU_FILT2) | 8 | R/W | 00h | 16.3.10/351 |

16.3.1 LLWU Pin Enable 1 register (LLWU_PE1)

LLWU_PE1 contains the field to enable and select the edge detect type for the external wakeup input pins LLWU_P3–LLWU_P0.

NOTE

This register is reset on Chip Reset not VLLS and by reset types that trigger Chip Reset not VLLS. It is unaffected by reset types that do not trigger Chip Reset not VLLS. See the [Introduction](#) details for more information.

Address: 4007_C000h base + 0h offset = 4007_C000h

| Bit | 7 | 6 | 5 | 4 | 3 | 2 | 1 | 0 |
|-------|-------|---|-------|---|-------|---|-------|---|
| Read | WUPE3 | | WUPE2 | | WUPE1 | | WUPE0 | |
| Write | | | | | | | | |
| Reset | 0 | 0 | 0 | 0 | 0 | 0 | 0 | 0 |

LLWU_PE1 field descriptions

| Field | Description |
|--------------|---|
| 7–6 WUPE3 | <p>Wakeup Pin Enable For LLWU_P3</p> <p>Enables and configures the edge detection for the wakeup pin.</p> <p>00 External input pin disabled as wakeup input 01 External input pin enabled with rising edge detection 10 External input pin enabled with falling edge detection 11 External input pin enabled with any change detection</p> |
| 5–4 WUPE2 | <p>Wakeup Pin Enable For LLWU_P2</p> <p>Enables and configures the edge detection for the wakeup pin.</p> |

Table continues on the next page...

LLWU_PE1 field descriptions (continued)

| Field | Description |
|--------------|--|
| | 00 External input pin disabled as wakeup input 01 External input pin enabled with rising edge detection 10 External input pin enabled with falling edge detection 11 External input pin enabled with any change detection |
| 3-2 WUPE1 | Wakeup Pin Enable For LLWU_P1 Enables and configures the edge detection for the wakeup pin. 00 External input pin disabled as wakeup input 01 External input pin enabled with rising edge detection 10 External input pin enabled with falling edge detection 11 External input pin enabled with any change detection |
| WUPE0 | Wakeup Pin Enable For LLWU_P0 Enables and configures the edge detection for the wakeup pin. 00 External input pin disabled as wakeup input 01 External input pin enabled with rising edge detection 10 External input pin enabled with falling edge detection 11 External input pin enabled with any change detection |

16.3.2 LLWU Pin Enable 2 register (LLWU_PE2)

LLWU_PE2 contains the field to enable and select the edge detect type for the external wakeup input pins LLWU_P7-LLWU_P4.

NOTE

This register is reset on Chip Reset not VLLS and by reset types that trigger Chip Reset not VLLS. It is unaffected by reset types that do not trigger Chip Reset not VLLS. See the [Introduction](#) details for more information.

Address: 4007_C000h base + 1h offset = 4007_C001h

| | | | | | | | | |
|-------|-------|---|-------|---|-------|---|-------|---|
| Bit | 7 | 6 | 5 | 4 | 3 | 2 | 1 | 0 |
| Read | WUPE7 | | WUPE6 | | WUPE5 | | WUPE4 | |
| Write | | | | | | | | |
| Reset | 0 | 0 | 0 | 0 | 0 | 0 | 0 | 0 |

LLWU_PE2 field descriptions

| Field | Description |
|--------------|--|
| 7-6 WUPE7 | Wakeup Pin Enable For LLWU_P7 Enables and configures the edge detection for the wakeup pin. 00 External input pin disabled as wakeup input |

Table continues on the next page...

LLWU_PE2 field descriptions (continued)

| Field | Description |
|--------------|--|
| | 01 External input pin enabled with rising edge detection 10 External input pin enabled with falling edge detection 11 External input pin enabled with any change detection |
| 5–4 WUPE6 | Wakeup Pin Enable For LLWU_P6 Enables and configures the edge detection for the wakeup pin. 00 External input pin disabled as wakeup input 01 External input pin enabled with rising edge detection 10 External input pin enabled with falling edge detection 11 External input pin enabled with any change detection |
| 3–2 WUPE5 | Wakeup Pin Enable For LLWU_P5 Enables and configures the edge detection for the wakeup pin. 00 External input pin disabled as wakeup input 01 External input pin enabled with rising edge detection 10 External input pin enabled with falling edge detection 11 External input pin enabled with any change detection |
| WUPE4 | Wakeup Pin Enable For LLWU_P4 Enables and configures the edge detection for the wakeup pin. 00 External input pin disabled as wakeup input 01 External input pin enabled with rising edge detection 10 External input pin enabled with falling edge detection 11 External input pin enabled with any change detection |

16.3.3 LLWU Pin Enable 3 register (LLWU_PE3)

LLWU_PE3 contains the field to enable and select the edge detect type for the external wakeup input pins LLWU_P11–LLWU_P8.

NOTE

This register is reset on Chip Reset not VLLS and by reset types that trigger Chip Reset not VLLS. It is unaffected by reset types that do not trigger Chip Reset not VLLS. See the [Introduction](#) details for more information.

Address: 4007_C000h base + 2h offset = 4007_C002h

| Bit | 7 | 6 | 5 | 4 | 3 | 2 | 1 | 0 |
|-------|--------|---|--------|---|-------|---|-------|---|
| Read | WUPE11 | | WUPE10 | | WUPE9 | | WUPE8 | |
| Write | | | | | | | | |
| Reset | 0 | 0 | 0 | 0 | 0 | 0 | 0 | 0 |

LLWU_PE3 field descriptions

| Field | Description |
|---------------|--|
| 7-6 WUPE11 | <p>Wakeup Pin Enable For LLWU_P11</p> <p>Enables and configures the edge detection for the wakeup pin.</p> <p>00 External input pin disabled as wakeup input 01 External input pin enabled with rising edge detection 10 External input pin enabled with falling edge detection 11 External input pin enabled with any change detection</p> |
| 5-4 WUPE10 | <p>Wakeup Pin Enable For LLWU_P10</p> <p>Enables and configures the edge detection for the wakeup pin.</p> <p>00 External input pin disabled as wakeup input 01 External input pin enabled with rising edge detection 10 External input pin enabled with falling edge detection 11 External input pin enabled with any change detection</p> |
| 3-2 WUPE9 | <p>Wakeup Pin Enable For LLWU_P9</p> <p>Enables and configures the edge detection for the wakeup pin.</p> <p>00 External input pin disabled as wakeup input 01 External input pin enabled with rising edge detection 10 External input pin enabled with falling edge detection 11 External input pin enabled with any change detection</p> |
| WUPE8 | <p>Wakeup Pin Enable For LLWU_P8</p> <p>Enables and configures the edge detection for the wakeup pin.</p> <p>00 External input pin disabled as wakeup input 01 External input pin enabled with rising edge detection 10 External input pin enabled with falling edge detection 11 External input pin enabled with any change detection</p> |

16.3.4 LLWU Pin Enable 4 register (LLWU_PE4)

LLWU_PE4 contains the field to enable and select the edge detect type for the external wakeup input pins LLWU_P15–LLWU_P12.

NOTE

This register is reset on Chip Reset not VLLS and by reset types that trigger Chip Reset not VLLS. It is unaffected by reset types that do not trigger Chip Reset not VLLS. See the [Introduction](#) details for more information.

Address: 4007_C000h base + 3h offset = 4007_C003h

| | | | | | | | | |
|-------|--------|---|--------|---|--------|---|--------|---|
| Bit | 7 | 6 | 5 | 4 | 3 | 2 | 1 | 0 |
| Read | WUPE15 | | WUPE14 | | WUPE13 | | WUPE12 | |
| Write | | | | | | | | |
| Reset | 0 | 0 | 0 | 0 | 0 | 0 | 0 | 0 |

LLWU_PE4 field descriptions

| Field | Description |
|---------------|--|
| 7-6 WUPE15 | <p>Wakeup Pin Enable For LLWU_P15</p> <p>Enables and configures the edge detection for the wakeup pin.</p> <p>00 External input pin disabled as wakeup input 01 External input pin enabled with rising edge detection 10 External input pin enabled with falling edge detection 11 External input pin enabled with any change detection</p> |
| 5-4 WUPE14 | <p>Wakeup Pin Enable For LLWU_P14</p> <p>Enables and configures the edge detection for the wakeup pin.</p> <p>00 External input pin disabled as wakeup input 01 External input pin enabled with rising edge detection 10 External input pin enabled with falling edge detection 11 External input pin enabled with any change detection</p> |
| 3-2 WUPE13 | <p>Wakeup Pin Enable For LLWU_P13</p> <p>Enables and configures the edge detection for the wakeup pin.</p> <p>00 External input pin disabled as wakeup input 01 External input pin enabled with rising edge detection 10 External input pin enabled with falling edge detection 11 External input pin enabled with any change detection</p> |
| WUPE12 | <p>Wakeup Pin Enable For LLWU_P12</p> <p>Enables and configures the edge detection for the wakeup pin.</p> <p>00 External input pin disabled as wakeup input 01 External input pin enabled with rising edge detection 10 External input pin enabled with falling edge detection 11 External input pin enabled with any change detection</p> |

16.3.5 LLWU Module Enable register (LLWU_ME)

LLWU_ME contains the bits to enable the internal module flag as a wakeup input source for inputs MWUF7–MWUF0.

NOTE

This register is reset on Chip Reset not VLLS and by reset types that trigger Chip Reset not VLLS. It is unaffected by reset

Memory map/register definition

types that do not trigger Chip Reset not VLLS. See the [Introduction](#) details for more information.

Address: 4007_C000h base + 4h offset = 4007_C004h

| | | | | | | | | |
|-------|-------|-------|-------|-------|-------|-------|-------|-------|
| Bit | 7 | 6 | 5 | 4 | 3 | 2 | 1 | 0 |
| Read | WUME7 | WUME6 | WUME5 | WUME4 | WUME3 | WUME2 | WUME1 | WUME0 |
| Write | | | | | | | | |
| Reset | 0 | 0 | 0 | 0 | 0 | 0 | 0 | 0 |

LLWU_ME field descriptions

| Field | Description |
|------------|---|
| 7 WUME7 | <p>Wakeup Module Enable For Module 7</p> <p>Enables an internal module as a wakeup source input.</p> <p>0 Internal module flag not used as wakeup source 1 Internal module flag used as wakeup source</p> |
| 6 WUME6 | <p>Wakeup Module Enable For Module 6</p> <p>Enables an internal module as a wakeup source input.</p> <p>0 Internal module flag not used as wakeup source 1 Internal module flag used as wakeup source</p> |
| 5 WUME5 | <p>Wakeup Module Enable For Module 5</p> <p>Enables an internal module as a wakeup source input.</p> <p>0 Internal module flag not used as wakeup source 1 Internal module flag used as wakeup source</p> |
| 4 WUME4 | <p>Wakeup Module Enable For Module 4</p> <p>Enables an internal module as a wakeup source input.</p> <p>0 Internal module flag not used as wakeup source 1 Internal module flag used as wakeup source</p> |
| 3 WUME3 | <p>Wakeup Module Enable For Module 3</p> <p>Enables an internal module as a wakeup source input.</p> <p>0 Internal module flag not used as wakeup source 1 Internal module flag used as wakeup source</p> |
| 2 WUME2 | <p>Wakeup Module Enable For Module 2</p> <p>Enables an internal module as a wakeup source input.</p> <p>0 Internal module flag not used as wakeup source 1 Internal module flag used as wakeup source</p> |
| 1 WUME1 | <p>Wakeup Module Enable for Module 1</p> <p>Enables an internal module as a wakeup source input.</p> <p>0 Internal module flag not used as wakeup source 1 Internal module flag used as wakeup source</p> |

Table continues on the next page...

LLWU_ME field descriptions (continued)

| Field | Description |
|------------|---|
| 0 WUME0 | <p>Wakeup Module Enable For Module 0</p> <p>Enables an internal module as a wakeup source input.</p> <p>0 Internal module flag not used as wakeup source 1 Internal module flag used as wakeup source</p> |

16.3.6 LLWU Flag 1 register (LLWU_F1)

LLWU_F1 contains the wakeup flags indicating which wakeup source caused the MCU to exit LLS or VLLS mode. For LLS, this is the source causing the CPU interrupt flow. For VLLS, this is the source causing the MCU reset flow.

The external wakeup flags are read-only and clearing a flag is accomplished by a write of a 1 to the corresponding WUFx bit. The wakeup flag (WUFx), if set, will remain set if the associated WUPEx bit is cleared.

NOTE

This register is reset on Chip Reset not VLLS and by reset types that trigger Chip Reset not VLLS. It is unaffected by reset types that do not trigger Chip Reset not VLLS. See the [Introduction](#) details for more information.

Address: 4007_C000h base + 5h offset = 4007_C005h

| Bit | 7 | 6 | 5 | 4 | 3 | 2 | 1 | 0 |
|-------|------|------|------|------|------|------|------|------|
| Read | WUF7 | WUF6 | WUF5 | WUF4 | WUF3 | WUF2 | WUF1 | WUF0 |
| Write | w1c | w1c | w1c | w1c | w1c | w1c | w1c | w1c |
| Reset | 0 | 0 | 0 | 0 | 0 | 0 | 0 | 0 |

LLWU_F1 field descriptions

| Field | Description |
|-----------|--|
| 7 WUF7 | <p>Wakeup Flag For LLWU_P7</p> <p>Indicates that an enabled external wakeup pin was a source of exiting a low-leakage power mode. To clear the flag, write a 1 to WUF7.</p> <p>0 LLWU_P7 input was not a wakeup source 1 LLWU_P7 input was a wakeup source</p> |
| 6 WUF6 | <p>Wakeup Flag For LLWU_P6</p> <p>Indicates that an enabled external wakeup pin was a source of exiting a low-leakage power mode. To clear the flag, write a 1 to WUF6.</p> |

Table continues on the next page...

LLWU_F1 field descriptions (continued)

| Field | Description |
|-----------|--|
| | 0 LLWU_P6 input was not a wakeup source 1 LLWU_P6 input was a wakeup source |
| 5 WUF5 | Wakeup Flag For LLWU_P5 Indicates that an enabled external wakeup pin was a source of exiting a low-leakage power mode. To clear the flag, write a 1 to WUF5. 0 LLWU_P5 input was not a wakeup source 1 LLWU_P5 input was a wakeup source |
| 4 WUF4 | Wakeup Flag For LLWU_P4 Indicates that an enabled external wake-up pin was a source of exiting a low-leakage power mode. To clear the flag, write a 1 to WUF4. 0 LLWU_P4 input was not a wakeup source 1 LLWU_P4 input was a wakeup source |
| 3 WUF3 | Wakeup Flag For LLWU_P3 Indicates that an enabled external wakeup pin was a source of exiting a low-leakage power mode. To clear the flag, write a 1 to WUF3. 0 LLWU_P3 input was not a wake-up source 1 LLWU_P3 input was a wake-up source |
| 2 WUF2 | Wakeup Flag For LLWU_P2 Indicates that an enabled external wakeup pin was a source of exiting a low-leakage power mode. To clear the flag, write a 1 to WUF2. 0 LLWU_P2 input was not a wakeup source 1 LLWU_P2 input was a wakeup source |
| 1 WUF1 | Wakeup Flag For LLWU_P1 Indicates that an enabled external wakeup pin was a source of exiting a low-leakage power mode. To clear the flag, write a 1 to WUF1. 0 LLWU_P1 input was not a wakeup source 1 LLWU_P1 input was a wakeup source |
| 0 WUF0 | Wakeup Flag For LLWU_P0 Indicates that an enabled external wake-up pin was a source of exiting a low-leakage power mode. To clear the flag, write a 1 to WUF0. 0 LLWU_P0 input was not a wakeup source 1 LLWU_P0 input was a wakeup source |

16.3.7 LLWU Flag 2 register (LLWU_F2)

LLWU_F2 contains the wakeup flags indicating which wakeup source caused the MCU to exit LLS or VLLS mode. For LLS, this is the source causing the CPU interrupt flow. For VLLS, this is the source causing the MCU reset flow.

The external wakeup flags are read-only and clearing a flag is accomplished by a write of a 1 to the corresponding WUFx bit. The wakeup flag (WUFx), if set, will remain set if the associated WUPEx bit is cleared.

NOTE

This register is reset on Chip Reset not VLLS and by reset types that trigger Chip Reset not VLLS. It is unaffected by reset types that do not trigger Chip Reset not VLLS. See the [Introduction](#) details for more information.

Address: 4007_C000h base + 6h offset = 4007_C006h

| Bit | 7 | 6 | 5 | 4 | 3 | 2 | 1 | 0 |
|-------|-------|-------|-------|-------|-------|-------|------|------|
| Read | WUF15 | WUF14 | WUF13 | WUF12 | WUF11 | WUF10 | WUF9 | WUF8 |
| Write | w1c | w1c | w1c | w1c | w1c | w1c | w1c | w1c |
| Reset | 0 | 0 | 0 | 0 | 0 | 0 | 0 | 0 |

LLWU_F2 field descriptions

| Field | Description |
|------------|--|
| 7 WUF15 | <p>Wakeup Flag For LLWU_P15</p> <p>Indicates that an enabled external wakeup pin was a source of exiting a low-leakage power mode. To clear the flag, write a 1 to WUF15.</p> <p>0 LLWU_P15 input was not a wakeup source 1 LLWU_P15 input was a wakeup source</p> |
| 6 WUF14 | <p>Wakeup Flag For LLWU_P14</p> <p>Indicates that an enabled external wakeup pin was a source of exiting a low-leakage power mode. To clear the flag, write a 1 to WUF14.</p> <p>0 LLWU_P14 input was not a wakeup source 1 LLWU_P14 input was a wakeup source</p> |
| 5 WUF13 | <p>Wakeup Flag For LLWU_P13</p> <p>Indicates that an enabled external wakeup pin was a source of exiting a low-leakage power mode. To clear the flag, write a 1 to WUF13.</p> <p>0 LLWU_P13 input was not a wakeup source 1 LLWU_P13 input was a wakeup source</p> |

Table continues on the next page...

LLWU_F2 field descriptions (continued)

| Field | Description |
|--------------|--|
| 4 WUF12 | <p>Wakeup Flag For LLWU_P12</p> <p>Indicates that an enabled external wakeup pin was a source of exiting a low-leakage power mode. To clear the flag, write a 1 to WUF12.</p> <p>0 LLWU_P12 input was not a wakeup source 1 LLWU_P12 input was a wakeup source</p> |
| 3 WUF11 | <p>Wakeup Flag For LLWU_P11</p> <p>Indicates that an enabled external wakeup pin was a source of exiting a low-leakage power mode. To clear the flag, write a 1 to WUF11.</p> <p>0 LLWU_P11 input was not a wakeup source 1 LLWU_P11 input was a wakeup source</p> |
| 2 WUF10 | <p>Wakeup Flag For LLWU_P10</p> <p>Indicates that an enabled external wakeup pin was a source of exiting a low-leakage power mode. To clear the flag, write a 1 to WUF10.</p> <p>0 LLWU_P10 input was not a wakeup source 1 LLWU_P10 input was a wakeup source</p> |
| 1 WUF9 | <p>Wakeup Flag For LLWU_P9</p> <p>Indicates that an enabled external wakeup pin was a source of exiting a low-leakage power mode. To clear the flag, write a 1 to WUF9.</p> <p>0 LLWU_P9 input was not a wakeup source 1 LLWU_P9 input was a wakeup source</p> |
| 0 WUF8 | <p>Wakeup Flag For LLWU_P8</p> <p>Indicates that an enabled external wakeup pin was a source of exiting a low-leakage power mode. To clear the flag, write a 1 to WUF8.</p> <p>0 LLWU_P8 input was not a wakeup source 1 LLWU_P8 input was a wakeup source</p> |

16.3.8 LLWU Flag 3 register (LLWU_F3)

LLWU_F3 contains the wakeup flags indicating which internal wakeup source caused the MCU to exit LLS or VLLS mode. For LLS, this is the source causing the CPU interrupt flow. For VLLS, this is the source causing the MCU reset flow.

For internal peripherals that are capable of running in a low-leakage power mode, such as a real time clock module or CMP module, the flag from the associated peripheral is accessible as the MWUFx bit. The flag will need to be cleared in the peripheral instead of writing a 1 to the MWUFx bit.

NOTE

This register is reset on Chip Reset not VLLS and by reset types that trigger Chip Reset not VLLS. It is unaffected by reset types that do not trigger Chip Reset not VLLS. See the [Introduction](#) details for more information.

Address: 4007_C000h base + 7h offset = 4007_C007h

| Bit | 7 | 6 | 5 | 4 | 3 | 2 | 1 | 0 |
|-------|-------|-------|-------|-------|-------|-------|-------|-------|
| Read | MWUF7 | MWUF6 | MWUF5 | MWUF4 | MWUF3 | MWUF2 | MWUF1 | MWUF0 |
| Write | | | | | | | | |
| Reset | 0 | 0 | 0 | 0 | 0 | 0 | 0 | 0 |

LLWU_F3 field descriptions

| Field | Description |
|------------|--|
| 7 MWUF7 | <p>Wakeup flag For module 7</p> <p>Indicates that an enabled internal peripheral was a source of exiting a low-leakage power mode. To clear the flag, follow the internal peripheral flag clearing mechanism.</p> <p>0 Module 7 input was not a wakeup source 1 Module 7 input was a wakeup source</p> |
| 6 MWUF6 | <p>Wakeup flag For module 6</p> <p>Indicates that an enabled internal peripheral was a source of exiting a low-leakage power mode. To clear the flag, follow the internal peripheral flag clearing mechanism.</p> <p>0 Module 6 input was not a wakeup source 1 Module 6 input was a wakeup source</p> |
| 5 MWUF5 | <p>Wakeup flag For module 5</p> <p>Indicates that an enabled internal peripheral was a source of exiting a low-leakage power mode. To clear the flag, follow the internal peripheral flag clearing mechanism.</p> <p>0 Module 5 input was not a wakeup source 1 Module 5 input was a wakeup source</p> |
| 4 MWUF4 | <p>Wakeup flag For module 4</p> <p>Indicates that an enabled internal peripheral was a source of exiting a low-leakage power mode. To clear the flag, follow the internal peripheral flag clearing mechanism.</p> <p>0 Module 4 input was not a wakeup source 1 Module 4 input was a wakeup source</p> |
| 3 MWUF3 | <p>Wakeup flag For module 3</p> <p>Indicates that an enabled internal peripheral was a source of exiting a low-leakage power mode. To clear the flag, follow the internal peripheral flag clearing mechanism.</p> <p>0 Module 3 input was not a wakeup source 1 Module 3 input was a wakeup source</p> |
| 2 MWUF2 | <p>Wakeup flag For module 2</p> |

Table continues on the next page...

LLWU_F3 field descriptions (continued)

| Field | Description |
|------------|--|
| | Indicates that an enabled internal peripheral was a source of exiting a low-leakage power mode. To clear the flag, follow the internal peripheral flag clearing mechanism. 0 Module 2 input was not a wakeup source 1 Module 2 input was a wakeup source |
| 1 MWUF1 | Wakeup flag For module 1 Indicates that an enabled internal peripheral was a source of exiting a low-leakage power mode. To clear the flag, follow the internal peripheral flag clearing mechanism. 0 Module 1 input was not a wakeup source 1 Module 1 input was a wakeup source |
| 0 MWUF0 | Wakeup flag For module 0 Indicates that an enabled internal peripheral was a source of exiting a low-leakage power mode. To clear the flag, follow the internal peripheral flag clearing mechanism. 0 Module 0 input was not a wakeup source 1 Module 0 input was a wakeup source |

16.3.9 LLWU Pin Filter 1 register (LLWU_FILT1)

LLWU_FILT1 is a control and status register that is used to enable/disable the digital filter 1 features for an external pin.

NOTE

This register is reset on Chip Reset not VLLS and by reset types that trigger Chip Reset not VLLS. It is unaffected by reset types that do not trigger Chip Reset not VLLS. See the [Introduction](#) details for more information.

Address: 4007_C000h base + 8h offset = 4007_C008h

| | | | | | | | | |
|-------|-------|-------|---|---|---|---------|---|---|
| Bit | 7 | 6 | 5 | 4 | 3 | 2 | 1 | 0 |
| Read | FILTF | FILTE | | | 0 | FILTSEL | | |
| Write | w1c | | | | | | | |
| Reset | 0 | 0 | 0 | 0 | 0 | 0 | 0 | 0 |

LLWU_FILT1 field descriptions

| Field | Description |
|------------|---|
| 7 FILTF | Filter Detect Flag Indicates that the filtered external wakeup pin, selected by FILTSEL, was a source of exiting a low-leakage power mode. To clear the flag write a one to FILTF. |

Table continues on the next page...

LLWU_FILT1 field descriptions (continued)

| Field | Description |
|---------------|---|
| | 0 Pin Filter 1 was not a wakeup source 1 Pin Filter 1 was a wakeup source |
| 6–5 FILTE | Digital Filter On External Pin Controls the digital filter options for the external pin detect. 00 Filter disabled 01 Filter posedge detect enabled 10 Filter negedge detect enabled 11 Filter any edge detect enabled |
| 4 Reserved | This field is reserved. This read-only field is reserved and always has the value 0. |
| FILTSEL | Filter Pin Select Selects 1 out of the 16 wakeup pins to be muxed into the filter. 0000 Select LLWU_P0 for filter 1111 Select LLWU_P15 for filter |

16.3.10 LLWU Pin Filter 2 register (LLWU_FILT2)

LLWU_FILT2 is a control and status register that is used to enable/disable the digital filter 2 features for an external pin.

NOTE

This register is reset on Chip Reset not VLLS and by reset types that trigger Chip Reset not VLLS. It is unaffected by reset types that do not trigger Chip Reset not VLLS. See the [Introduction](#) details for more information.

Address: 4007_C000h base + 9h offset = 4007_C009h

| | | | | | | | | |
|-------|-------|-------|---|---|---|---------|---|---|
| Bit | 7 | 6 | 5 | 4 | 3 | 2 | 1 | 0 |
| Read | FILTF | FILTE | | | 0 | FILTSEL | | |
| Write | w1c | | | | | | | |
| Reset | 0 | 0 | 0 | 0 | 0 | 0 | 0 | 0 |

LLWU_FILT2 field descriptions

| Field | Description |
|------------|---|
| 7 FILTF | Filter Detect Flag Indicates that the filtered external wakeup pin, selected by FILTSEL, was a source of exiting a low-leakage power mode. To clear the flag write a one to FILTF. |

Table continues on the next page...

LLWU_FILT2 field descriptions (continued)

| Field | Description |
|---------------|---|
| | 0 Pin Filter 2 was not a wakeup source 1 Pin Filter 2 was a wakeup source |
| 6–5 FILTE | Digital Filter On External Pin Controls the digital filter options for the external pin detect. 00 Filter disabled 01 Filter posedge detect enabled 10 Filter negedge detect enabled 11 Filter any edge detect enabled |
| 4 Reserved | This field is reserved. This read-only field is reserved and always has the value 0. |
| FILTSEL | Filter Pin Select Selects 1 out of the 16 wakeup pins to be muxed into the filter. 0000 Select LLWU_P0 for filter 1111 Select LLWU_P15 for filter |

16.4 Functional description

This low-leakage wakeup unit (LLWU) module allows internal peripherals and external input pins as a source of wakeup from low-leakage modes.

It is operational only in LLS and VLLSx modes.

The LLWU module contains pin enables for each external pin and internal module. For each external pin, the user can disable or select the edge type for the wakeup with the following options:

- Falling-edge
- Rising-edge
- Either-edge

When an external pin is enabled as a wakeup source, the pin must be configured as an input pin.

The LLWU implements optional 3-cycle glitch filters, based on the LPO clock. A detected external pin is required to remain asserted until the enabled glitch filter times out. Additional latency of up to 2 cycles is due to synchronization, which results in a total of up to 5 cycles of delay before the detect circuit alerts the system to the wakeup or reset event when the filter function is enabled. Two wakeup detect filters are available for selected external pins. Glitch filtering is not provided on the internal modules.

For internal module interrupts, the WUMEx bit enables the associated module interrupt as a wakeup source.

16.4.1 LLS mode

Wakeup events triggered from either an external pin input or an internal module interrupt, result in a CPU interrupt flow to begin user code execution.

16.4.2 VLLS modes

For any wakeup from VLLS, recovery is always via a reset flow and RCM_SRS[WAKEUP] is set indicating the low-leakage mode was active. State retention data is lost and I/O will be restored after PMC_REGSC[ACKISO] has been written.

A VLLS exit event due to $\overline{\text{RESET}}$ pin assertion causes an exit via a system reset. State retention data is lost and the I/O states immediately return to their reset state. The RCM_SRS[WAKEUP] and RCM_SRS[PIN] bits are set and the system executes a reset flow before CPU operation begins with a reset vector fetch.

16.4.3 Initialization

For an enabled peripheral wakeup input, the peripheral flag must be cleared by software before entering LLS or VLLSx mode to avoid an immediate exit from the mode.

Flags associated with external input pins, filtered and unfiltered, must also be cleared by software prior to entry to LLS or VLLSx mode.

After enabling an external pin filter or changing the source pin, wait at least five LPO clock cycles before entering LLS or VLLSx mode to allow the filter to initialize.

NOTE

After recovering from a VLLS mode, user must restore chip configuration before clearing PMC_REGSC[ACKISO]. In particular, pin configuration for enabled LLWU wake-up pins must be restored to avoid any LLWU flag from being falsely set when PMC_REGSC[ACKISO] is cleared.

The signal selected as a wake-up source pin must be a digital pin, as selected in the pin mux control.

Chapter 17

Reset Control Module (RCM)

17.1 Introduction

Information found here describes the registers of the Reset Control Module (RCM). The RCM implements many of the reset functions for the chip. See the chip's reset chapter for more information.

See [AN4503: Power Management for Kinetis MCUs](#) for further details on using the RCM.

17.2 Reset memory map and register descriptions

The RCM Memory Map/Register Definition can be found here.

The Reset Control Module (RCM) registers provide reset status information and reset filter control.

NOTE

The RCM registers can be written only in supervisor mode. Write accesses in user mode are blocked and will result in a bus error.

RCM memory map

| Absolute address (hex) | Register name | Width (in bits) | Access | Reset value | Section/page |
|------------------------|--|-----------------|--------|-------------|----------------------------|
| 4007_F000 | System Reset Status Register 0 (RCM_SRS0) | 8 | R | 82h | 17.2.1/356 |
| 4007_F001 | System Reset Status Register 1 (RCM_SRS1) | 8 | R | 00h | 17.2.2/357 |
| 4007_F004 | Reset Pin Filter Control register (RCM_RPFC) | 8 | R/W | 00h | 17.2.3/358 |
| 4007_F005 | Reset Pin Filter Width register (RCM_RPFW) | 8 | R/W | 00h | 17.2.4/359 |

17.2.1 System Reset Status Register 0 (RCM_SRS0)

This register includes read-only status flags to indicate the source of the most recent reset. The reset state of these bits depends on what caused the MCU to reset.

NOTE

The reset value of this register depends on the reset source:

- POR (including LVD) — 0x82
- LVD (without POR) — 0x02
- VLLS mode wakeup due to $\overline{\text{RESET}}$ pin assertion — 0x41
- VLLS mode wakeup due to other wakeup sources — 0x01
- Other reset — a bit is set if its corresponding reset source caused the reset

Address: 4007_F000h base + 0h offset = 4007_F000h

| | | | | | | | | |
|-------|-----|-----|------|---|---|-----|-----|--------|
| Bit | 7 | 6 | 5 | 4 | 3 | 2 | 1 | 0 |
| Read | POR | PIN | WDOG | 0 | | LOC | LVD | WAKEUP |
| Write | | | | | | | | |
| Reset | 1 | 0 | 0 | 0 | 0 | 0 | 1 | 0 |

RCM_SRS0 field descriptions

| Field | Description |
|-----------------|--|
| 7 POR | <p>Power-On Reset</p> <p>Indicates a reset has been caused by the power-on detection logic. Because the internal supply voltage was ramping up at the time, the low-voltage reset (LVD) status bit is also set to indicate that the reset occurred while the internal supply was below the LVD threshold.</p> <p>0 Reset not caused by POR 1 Reset caused by POR</p> |
| 6 PIN | <p>External Reset Pin</p> <p>Indicates a reset has been caused by an active-low level on the external $\overline{\text{RESET}}$ pin.</p> <p>0 Reset not caused by external reset pin 1 Reset caused by external reset pin</p> |
| 5 WDOG | <p>Watchdog</p> <p>Indicates a reset has been caused by the watchdog timer timing out. This reset source can be blocked by disabling the watchdog.</p> <p>0 Reset not caused by watchdog timeout 1 Reset caused by watchdog timeout</p> |
| 4–3 Reserved | <p>This field is reserved. This read-only field is reserved and always has the value 0.</p> |

Table continues on the next page...

RCM_SRS0 field descriptions (continued)

| Field | Description |
|-------------|---|
| 2 LOC | <p>Loss-of-Clock Reset</p> <p>Indicates a reset has been caused by a loss of external clock. The MCG clock monitor must be enabled for a loss of clock to be detected. Refer to the detailed MCG description for information on enabling the clock monitor.</p> <p>0 Reset not caused by a loss of external clock. 1 Reset caused by a loss of external clock.</p> |
| 1 LVD | <p>Low-Voltage Detect Reset</p> <p>If PMC_LVDSC1[LVDRE] is set and the supply drops below the LVD trip voltage, an LVD reset occurs. This field is also set by POR.</p> <p>0 Reset not caused by LVD trip or POR 1 Reset caused by LVD trip or POR</p> |
| 0 WAKEUP | <p>Low Leakage Wakeup Reset</p> <p>Indicates a reset has been caused by an enabled LLWU module wakeup source while the chip was in a low leakage mode. In LLS mode, the RESET pin is the only wakeup source that can cause this reset. Any enabled wakeup source in a VLLSx mode causes a reset. This bit is cleared by any reset except WAKEUP.</p> <p>0 Reset not caused by LLWU module wakeup source 1 Reset caused by LLWU module wakeup source</p> |

17.2.2 System Reset Status Register 1 (RCM_SRS1)

This register includes read-only status flags to indicate the source of the most recent reset. The reset state of these bits depends on what caused the MCU to reset.

NOTE

The reset value of this register depends on the reset source:

- POR (including LVD) — 0x00
- LVD (without POR) — 0x00
- VLLS mode wakeup — 0x00
- Other reset — a bit is set if its corresponding reset source caused the reset

Address: 4007_F000h base + 1h offset = 4007_F001h

| Bit | 7 | 6 | 5 | 4 | 3 | 2 | 1 | 0 |
|-------|---|---|---------|---|--------|----|--------|---|
| Read | 0 | 0 | SACKERR | 0 | MDM_AP | SW | LOCKUP | 0 |
| Write | | | | | | | | |
| Reset | 0 | 0 | 0 | 0 | 0 | 0 | 0 | 0 |

RCM_SRS1 field descriptions

| Field | Description |
|---------------|---|
| 7 Reserved | This field is reserved. This read-only field is reserved and always has the value 0. |
| 6 Reserved | This field is reserved. This read-only field is reserved and always has the value 0. |
| 5 SACKERR | Stop Mode Acknowledge Error Reset Indicates that after an attempt to enter Stop mode, a reset has been caused by a failure of one or more peripherals to acknowledge within approximately one second to enter stop mode. 0 Reset not caused by peripheral failure to acknowledge attempt to enter stop mode 1 Reset caused by peripheral failure to acknowledge attempt to enter stop mode |
| 4 Reserved | This field is reserved. This read-only field is reserved and always has the value 0. |
| 3 MDM_AP | MDM-AP System Reset Request Indicates a reset has been caused by the host debugger system setting of the System Reset Request bit in the MDM-AP Control Register. 0 Reset not caused by host debugger system setting of the System Reset Request bit 1 Reset caused by host debugger system setting of the System Reset Request bit |
| 2 SW | Software Indicates a reset has been caused by software setting of SYSRESETREQ bit in Application Interrupt and Reset Control Register in the ARM core. 0 Reset not caused by software setting of SYSRESETREQ bit 1 Reset caused by software setting of SYSRESETREQ bit |
| 1 LOCKUP | Core Lockup Indicates a reset has been caused by the ARM core indication of a LOCKUP event. 0 Reset not caused by core LOCKUP event 1 Reset caused by core LOCKUP event |
| 0 Reserved | This field is reserved. This read-only field is reserved and always has the value 0. |

17.2.3 Reset Pin Filter Control register (RCM_RPFC)

NOTE

The reset values of bits 2-0 are for Chip POR only. They are unaffected by other reset types.

NOTE

The bus clock filter is reset when disabled or when entering stop mode. The LPO filter is reset when disabled .

Address: 4007_F000h base + 4h offset = 4007_F004h

| | | | | | | | | | |
|-------|---|---|---|---|---|----------|---|-----------|--|
| Bit | 7 | 6 | 5 | 4 | 3 | 2 | 1 | 0 | |
| Read | 0 | | | | | RSTFLTSS | | RSTFLTSRW | |
| Write | | | | | | | | | |
| Reset | 0 | 0 | 0 | 0 | 0 | 0 | 0 | 0 | |

RCM_RPFC field descriptions

| Field | Description |
|-----------------|---|
| 7-3 Reserved | This field is reserved. This read-only field is reserved and always has the value 0. |
| 2 RSTFLTSS | Reset Pin Filter Select in Stop Mode Selects how the reset pin filter is enabled in Stop and VLPS modes , and also during LLS and VLLS modes. On exit from VLLS mode, this bit should be reconfigured before clearing PMC_REGSC[ACKISO]. 0 All filtering disabled 1 LPO clock filter enabled |
| RSTFLTSRW | Reset Pin Filter Select in Run and Wait Modes Selects how the reset pin filter is enabled in run and wait modes. 00 All filtering disabled 01 Bus clock filter enabled for normal operation 10 LPO clock filter enabled for normal operation 11 Reserved |

17.2.4 Reset Pin Filter Width register (RCM_RPFW)

NOTE

The reset values of the bits in the RSTFLTSEL field are for Chip POR only. They are unaffected by other reset types.

Address: 4007_F000h base + 5h offset = 4007_F005h

| | | | | | | | | |
|-------|---|---|---|---|-----------|---|---|---|
| Bit | 7 | 6 | 5 | 4 | 3 | 2 | 1 | 0 |
| Read | 0 | | | | RSTFLTSEL | | | |
| Write | | | | | | | | |
| Reset | 0 | 0 | 0 | 0 | 0 | 0 | 0 | 0 |

RCM_RPFW field descriptions

| Field | Description |
|-----------------|---|
| 7-5 Reserved | This field is reserved. This read-only field is reserved and always has the value 0. |
| RSTFLTSEL | Reset Pin Filter Bus Clock Select Selects the reset pin bus clock filter width. |

Table continues on the next page...

RCM_RPFW field descriptions (continued)

| Field | Description |
|-------|------------------------------|
| 00000 | Bus clock filter count is 1 |
| 00001 | Bus clock filter count is 2 |
| 00010 | Bus clock filter count is 3 |
| 00011 | Bus clock filter count is 4 |
| 00100 | Bus clock filter count is 5 |
| 00101 | Bus clock filter count is 6 |
| 00110 | Bus clock filter count is 7 |
| 00111 | Bus clock filter count is 8 |
| 01000 | Bus clock filter count is 9 |
| 01001 | Bus clock filter count is 10 |
| 01010 | Bus clock filter count is 11 |
| 01011 | Bus clock filter count is 12 |
| 01100 | Bus clock filter count is 13 |
| 01101 | Bus clock filter count is 14 |
| 01110 | Bus clock filter count is 15 |
| 01111 | Bus clock filter count is 16 |
| 10000 | Bus clock filter count is 17 |
| 10001 | Bus clock filter count is 18 |
| 10010 | Bus clock filter count is 19 |
| 10011 | Bus clock filter count is 20 |
| 10100 | Bus clock filter count is 21 |
| 10101 | Bus clock filter count is 22 |
| 10110 | Bus clock filter count is 23 |
| 10111 | Bus clock filter count is 24 |
| 11000 | Bus clock filter count is 25 |
| 11001 | Bus clock filter count is 26 |
| 11010 | Bus clock filter count is 27 |
| 11011 | Bus clock filter count is 28 |
| 11100 | Bus clock filter count is 29 |
| 11101 | Bus clock filter count is 30 |
| 11110 | Bus clock filter count is 31 |
| 11111 | Bus clock filter count is 32 |

Chapter 18

Bit Manipulation Engine (BME)

The Bit Manipulation Engine (BME) provides hardware support for atomic read-modify-write memory operations to the peripheral address space in ARM®Cortex™-M0+ based microcontrollers. This architectural capability is also known as "decorated storage." By combining the basic load and store instructions of the Cortex-M instruction set architecture (v6M, v7M) with the concept of decorated storage provided by the BME, the resulting implementation provides a robust and efficient read-modify-write capability to this class of ultra low-end microcontrollers.

18.1 Introduction

The Bit Manipulation Engine (BME) provides hardware support for atomic read-modify-write memory operations to the peripheral address space in Cortex-M0+ based microcontrollers.

This architectural capability is also known as "decorated storage" as it defines a mechanism for providing additional semantics for load and store operations to memory-mapped peripherals beyond just the reading and writing of data values to the addressed memory locations. In the BME definition, the "decoration", that is, the additional semantic information, is encoded into the peripheral address used to reference the memory.

By combining the basic load and store instructions of the ARM Cortex-M instruction set architecture (v6M, v7M) with the concept of decorated storage provided by the BME, the resulting implementation provides a robust and efficient read-modify-write capability to this class of ultra low-end microcontrollers. The resulting architectural capability defined by this core platform function is targeted at the manipulation of n-bit fields in peripheral registers and is consistent with I/O hardware addressing in the Embedded C standard. For most BME commands, a single core read or write bus cycle is converted into an atomic read-modify-write, that is, an indivisible "read followed by a write" bus sequence.

BME decorated references are only available on system bus transactions generated by the processor core and targeted at the standard 512 KB peripheral address space based at 0x4000_0000¹. The decoration semantic is embedded into address bits[28:19], creating a 448 MB space at addresses 0x4400_0000–0x5FFF_FFFF for AIPS; these bits are stripped out of the actual address sent to the peripheral bus controller and used by the BME to define and control its operation.

18.1.1 Overview

The following figure is a generic block diagram of the processor core and platform for this class of ultra low-end microcontrollers.

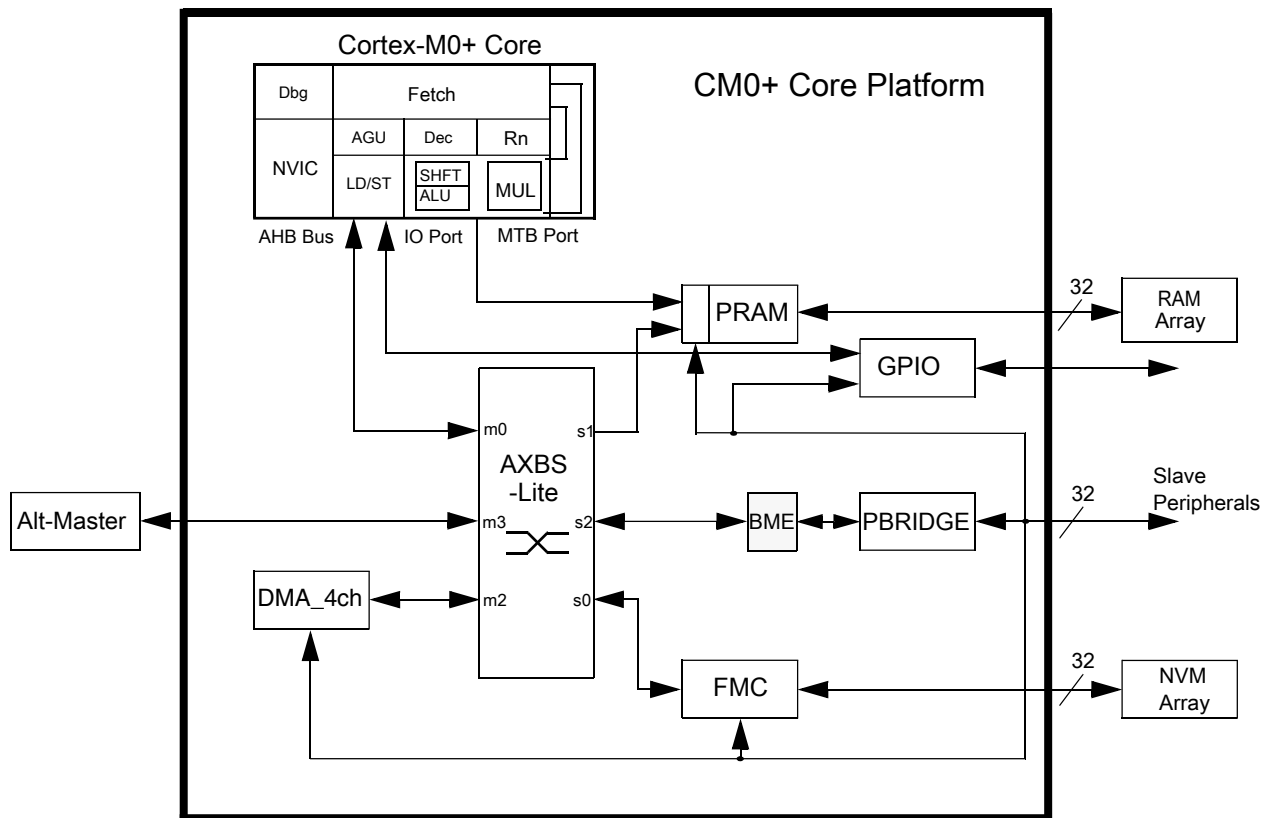

Note: BME can be accessed only by the core.

Figure 18-1. Cortex-M0+ core platform block diagram

1. To be perfectly accurate, the peripheral address space occupies a 516 KB region: 512 KB based at 0x4000_0000 plus a 4 KB space based at 0x400F_F000 for GPIO accesses. This organization provides compatibility with the Kinetis K Family. Attempted accesses to the memory space located between 0x4008_0000 - 0x400F_EFFF are error terminated due to an illegal address.

As shown in the block diagram, the BME module interfaces to a crossbar switch AHB slave port as its primary input and sources an AHB bus output to the Peripheral Bridge (PBRIDGE) controller. The BME hardware microarchitecture is a 2-stage pipeline design matching the protocol of the AMBA-AHB system bus interfaces. The PBRIDGE module converts the AHB system bus protocol into the IPS/APB protocol used by the attached slave peripherals.

18.1.2 Features

The key features of the BME include:

- Lightweight implementation of decorated storage for selected address spaces
- Additional access semantics encoded into the reference address
- Resides between a crossbar switch slave port and a peripheral bridge bus controller
- Two-stage pipeline design matching the AHB system bus protocol
- Combinationally passes non-decorated accesses to peripheral bridge bus controller
- Conversion of decorated loads and stores from processor core into atomic read-modify-writes
- Decorated loads support unsigned bit field extracts, load-and-`{set,clear}` 1-bit operations
- Decorated stores support bit field inserts, logical AND, OR, and XOR operations
- Support for byte, halfword and word-sized decorated operations
- Supports minimum signal toggling on AHB output bus to reduce power dissipation

18.1.3 Modes of operation

The BME module does not support any special modes of operation. As a memory-mapped device located on a crossbar slave AHB system bus port, BME responds strictly on the basis of memory addresses for accesses to the peripheral bridge bus controller.

All functionality associated with the BME module resides in the core platform's clock domain; this includes its connections with the crossbar slave port and the PBRIDGE bus controller.

18.2 Memory map and register definition

The BME module provides a memory-mapped capability and does not include any programming model registers.

The exact set of functions supported by the BME are detailed in the [Functional description](#).

The peripheral address space occupies a 516 KB region: 512 KB based at 0x4000_0000 plus a 4 KB space based at 0x400F_F000 for GPIO accesses; the decorated address space is mapped to the 448 MB region located at 0x4400_0000–0x5FFF_FFFF.

18.3 Functional description

Information found here details the specific functions supported by the BME.

Recall the combination of the basic load and store instructions of the Cortex-M instruction set architecture (v6M, v7M) plus the concept of decorated storage provided by the BME, the resulting implementation provides a robust and efficient read-modify-write capability to this class of ultra low-end microcontrollers. The resulting architectural capability defined by this core platform function is targeted at the manipulation of n-bit fields in peripheral registers and is consistent with I/O hardware addressing in the Embedded C standard. For most BME commands, a single core read or write bus cycle is converted into an atomic read-modify-write, that is, an indivisible "read followed by a write" bus sequence.

Consider decorated store operations first, then decorated loads.

18.3.1 BME decorated stores

The functions supported by the BME's decorated stores include three logical operators (AND, OR, XOR) plus a bit field insert.

For all these operations, BME converts a single decorated AHB store transaction into a 2-cycle atomic read-modify-write sequence, where the combined read-modify operation is performed in the first AHB data phase, and then the write is performed in the second AHB data phase.

A generic timing diagram of a decorated store showing a peripheral bit field insert operation is shown as follows:

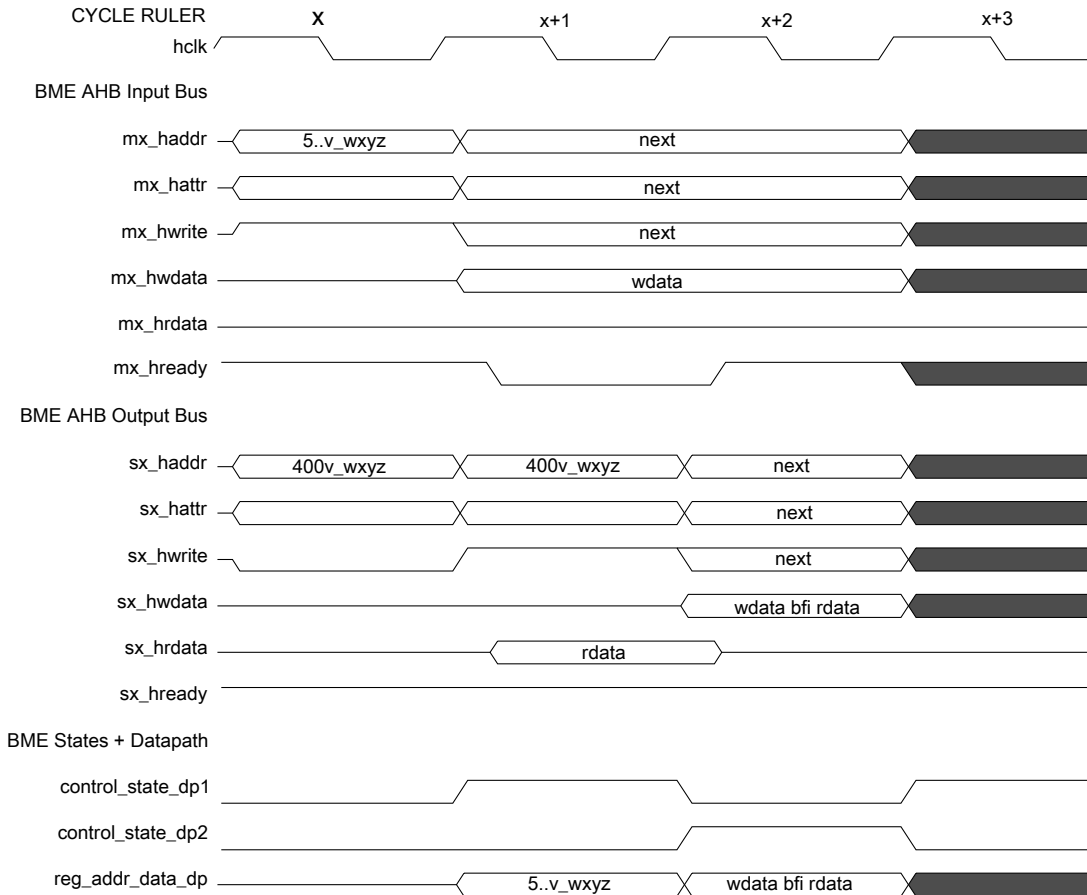

Figure 18-2. Decorated store: bit field insert timing diagram

All the decorated store operations follow the same execution template shown in [Figure 18-2](#), a two-cycle read-modify-write operation:

1. Cycle x, 1st AHB address phase: Write from input bus is translated into a read operation on the output bus using the actual memory address (with the decoration removed) and then captured in a register.
2. Cycle x+1, 2nd AHB address phase: Write access with the registered (but actual) memory address is output
3. Cycle x+1, 1st AHB data phase: Memory read data is modified using the input bus write data and the function defined by the decoration and captured in a data register; the input bus cycle is stalled.
4. Cycle x+2, 2nd AHB data phase: Registered write data is sourced onto the output write data bus.

NOTE

Any wait states inserted by the slave device are simply passed through the BME back to the master input bus, stalling the AHB transaction cycle for cycle.

18.3.1.1 Decorated store logical AND (AND)

This command performs an atomic read-modify-write of the referenced memory location.

1. First, the location is read;
2. It is then modified by performing a logical AND operation using the write data operand sourced for the system bus cycle
3. Finally, the result of the AND operation is written back into the referenced memory location.

The data size is specified by the write operation and can be byte (8-bit), halfword (16-bit) or word (32-bit). The core performs the required write data lane replication on byte and halfword transfers.

| | | | | | | | | | | | | | | | | | | | | | | | | | | | | | | | | |
|--------|----|----|----|----|----|----|----|----|----|----|----|----|----------|----|----|----|----|----|----|----|----|----|---|---|---|---|---|---|---|---|---|---|
| | 31 | 30 | 29 | 28 | 27 | 26 | 25 | 24 | 23 | 22 | 21 | 20 | 19 | 18 | 17 | 16 | 15 | 14 | 13 | 12 | 11 | 10 | 9 | 8 | 7 | 6 | 5 | 4 | 3 | 2 | 1 | 0 |
| ioandb | 0 | * | * | 0 | 0 | 1 | - | - | - | - | - | - | mem_addr | | | | | | | | | | | | | | | | | | | |
| ioandh | 0 | * | * | 0 | 0 | 1 | - | - | - | - | - | - | mem_addr | | | | | | | | | | | | | | | 0 | | | | |
| ioandw | 0 | * | * | 0 | 0 | 1 | - | - | - | - | - | - | mem_addr | | | | | | | | | | | | | | | 0 | 0 | | | |

Figure 18-3. Decorated store address: logical AND

See Figure 18-3, where $addr[30:29] = 10$ for peripheral, $addr[28:26] = 001$ specifies the AND operation, and $mem_addr[19:0]$ specifies the address offset into the space based at $0x4000_0000$ for peripherals. The "-" indicates an address bit "don't care".

The decorated AND write operation is defined in the following pseudo-code as:

```

ioand<sz>(accessAddress, wdata)           // decorated store AND
tmp  = mem[accessAddress & 0xE0FFFFFF, size] // memory read
tmp  = tmp & wdata                          // modify
mem[accessAddress & 0xE0FFFFFF, size] = tmp // memory write
    
```

where the operand size <sz> is defined as b(yte, 8-bit), h(alfword, 16-bit) and w(ord, 32-bit). This notation is used throughout the document.

In the cycle definition tables, the notations AHB_ap and AHB_dp refer to the address and data phases of the BME AHB transaction. The cycle-by-cycle BME operations are detailed in the following table.

Table 18-1. Cycle definitions of decorated store: logical AND

| Pipeline stage | Cycle | | |
|----------------|---|---|--------|
| | x | x+1 | x+2 |
| BME AHB_ap | Forward addr to memory; Decode decoration; Convert | Recirculate captured addr + attr to memory as slave_wt | <next> |

Table continues on the next page...

Table 18-1. Cycle definitions of decorated store: logical AND (continued)

| Pipeline stage | Cycle | | |
|----------------|---|--|---|
| | x | x+1 | x+2 |
| | master_wt to slave_rd; Capture address, attributes | | |
| BME AHB_dp | <previous> | Perform memory read; Form (rdata & wdata) and capture destination data in register | Perform write sending registered data to memory |

18.3.1.2 Decorated store logical OR (OR)

This command performs an atomic read-modify-write of the referenced memory location.

1. First, the location is read.
2. It is then modified by performing a logical OR operation using the write data operand sourced for the system bus cycle.
3. Finally, the result of the OR operation is written back into the referenced memory location.

The data size is specified by the write operation and can be byte (8-bit), halfword (16-bit) or word (32-bit). The core performs the required write data lane replication on byte and halfword transfers.

| | 31 | 30 | 29 | 28 | 27 | 26 | 25 | 24 | 23 | 22 | 21 | 20 | 19 | 18 | 17 | 16 | 15 | 14 | 13 | 12 | 11 | 10 | 9 | 8 | 7 | 6 | 5 | 4 | 3 | 2 | 1 | 0 | | | | | | | | | | | | |
|-------|----|----|----|----|----|----|----|----|----|----|----|----|----------|----|----|----|----|----|----|----|----|----|---|---|---|---|---|---|---|---|---|---|--|--|--|--|--|--|--|--|--|--|---|---|
| ioorb | 0 | * | * | 0 | 1 | 0 | - | - | - | - | - | - | mem_addr | | | | | | | | | | | | | | | | | | | | | | | | | | | | | | | |
| ioorh | 0 | * | * | 0 | 1 | 0 | - | - | - | - | - | - | mem_addr | | | | | | | | | | | | | | | | | | | | | | | | | | | | | | | 0 |
| ioorw | 0 | * | * | 0 | 1 | 0 | - | - | - | - | - | - | mem_addr | | | | | | | | | | | | | | | | | | | | | | | | | | | | | | 0 | 0 |

Figure 18-4. Decorated address store: logical OR

See [Figure 18-4](#), where $\text{addr}[30:29] = 10$ for peripheral, $\text{addr}[28:26] = 010$ specifies the OR operation, and $\text{mem_addr}[19:0]$ specifies the address offset into the space based at $0x4000_0000$ for peripherals. The "-" indicates an address bit "don't care".

The decorated OR write operation is defined in the following pseudo-code as:

```
ioor<sz>(accessAddress, wdata)           // decorated store OR

tmp   = mem[accessAddress & 0xE0FFFFFF, size] // memory read
tmp   = tmp | wdata                          // modify
mem[accessAddress & 0xE0FFFFFF, size] = tmp  // memory write
```

The cycle-by-cycle BME operations are detailed in the following table.

Table 18-2. Cycle definitions of decorated store: logical OR

| Pipeline stage | Cycle | | |
|----------------|---|--|---|
| | x | x+1 | x+2 |
| BME AHB_ap | Forward addr to memory; Decode decoration; Convert master_wt to slave_rd; Capture address, attributes | Recirculate captured addr + attr to memory as slave_wt | <next> |
| BME AHB_dp | <previous> | Perform memory read; Form (rdata wdata) and capture destination data in register | Perform write sending registered data to memory |

18.3.1.3 Decorated store logical XOR (XOR)

This command performs an atomic read-modify-write of the referenced memory location.

1. First, the location is read.
2. It is then modified by performing a logical XOR (exclusive-OR) operation using the write data operand sourced for the system bus cycle.
3. Finally, the result of the XOR operation is written back into the referenced memory location.

The data size is specified by the write operation and can be byte (8-bit), halfword (16-bit) or word (32-bit). The core performs the required write data lane replication on byte and halfword transfers.

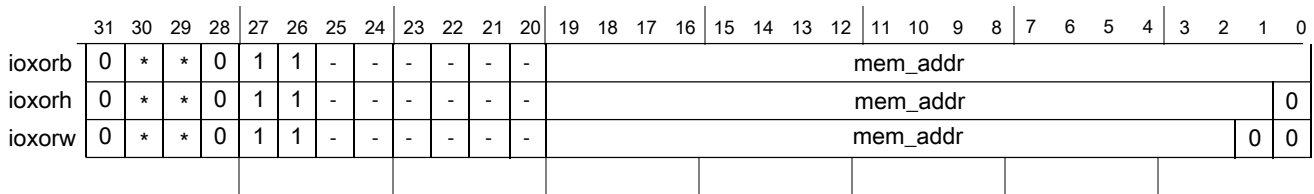

Figure 18-5. Decorated address store: logical XOR

See [Figure 18-5](#), where `addr[30:29] = 10` for peripheral, `addr[28:26] = 011` specifies the XOR operation, and `mem_addr[19:0]` specifies the address offset into the peripheral space based at `0x4000_0000` for peripherals. The "-" indicates an address bit "don't care".

The decorated XOR write operation is defined in the following pseudo-code as:

```
ioxor<sz>(accessAddress, wdata) // decorated store XOR

tmp = mem[accessAddress & 0xE00FFFFF, size] // memory read
tmp = tmp ^ wdata // modify
mem[accessAddress & 0xE00FFFFF, size] = tmp // memory write
```

The cycle-by-cycle BME operations are detailed in the following table.

Table 18-3. Cycle definitions of decorated store: logical XOR

| Pipeline Stage | Cycle | | |
|----------------|---|--|--|
| | x | x+1 | x+2 |
| BME AHB_ap | Forward addr to memory; Decode decoration; Convert master_wt to slave_rd; Capture address, attributes | Recirculate captured addr + attr to memory as slave_wt | <next> |
| BME AHB_dp | <previous> | Perform memory read; Form (rdata ^ wdata) and capture destination data in register | Perform write sending registered data to memory |

18.3.1.4 Decorated store bit field insert (BFI)

This command inserts a bit field contained in the write data operand, defined by LSB position (b) and the bit field width (w+1), into the memory "container" defined by the access size associated with the store instruction using an atomic read-modify-write sequence.

The data size is specified by the write operation and can be byte (8-bit), halfword (16-bit) or word (32-bit).

NOTE

For the word sized operation, the maximum bit field width is 16 bits. The core performs the required write data lane replication on byte and halfword transfers.

The BFI operation can be used to insert a single bit into a peripheral. For this case, the w field is simply set to 0, indicating a bit field width of 1.

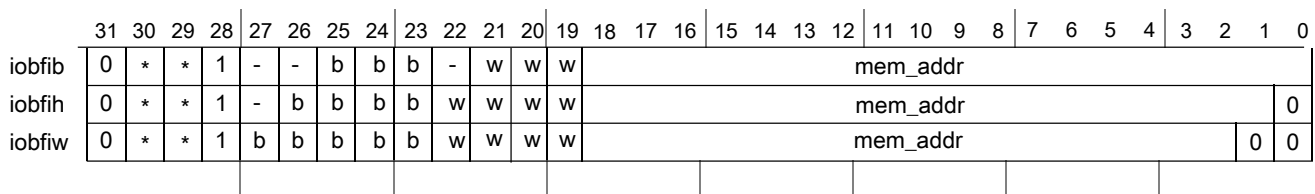
**Figure 18-6. Decorated address store: bit field insert**

where $\text{addr}[30:29] = 10$ for peripheral, $\text{addr}[28] = 1$ signals a BFI operation, $\text{addr}[27:23]$ is "b", the LSB identifier, $\text{addr}[22:19]$ is "w", the bit field width minus 1 identifier, and $\text{addr}[18:0]$ specifies the address offset into the peripheral space based at $0x4000_0000$ for peripherals. The "-" indicates an address bit "don't care". Note, unlike the other decorated store operations, BFI uses $\text{addr}[19]$ as the least significant bit in the "w" specifier and not as an address bit.

Functional description

The decorated BFI write operation is defined in the following pseudo-code as:

```
iobfi<sz>(accessAddress, wdata)           // decorated bit field insert

tmp   = mem[accessAddress & 0xE007FFFF, size] // memory read
mask  = ((1 << (w+1)) - 1) << b             // generate bit mask
tmp   = tmp & ~mask                          // modify
      | wdata & mask
mem[accessAddress & 0xE007FFFF, size] = tmp // memory write
```

The write data operand (wdata) associated with the store instruction contains the bit field to be inserted. It must be properly aligned within a right-aligned container, that is, within the lower 8 bits for a byte operation, the lower 16 bits for a halfword, or the entire 32 bits for a word operation.

To illustrate, consider the following example of the insertion of the 3-bit field "xyz" into an 8-bit memory container, initially set to "abcd_efgh". For all cases, w is 2, signaling a bit field width of 3.

```
if b = 0 and the decorated store (strb) Rt register[7:0] = ----_-xyz,
    then destination is "abcd_xyz"
if b = 1 and the decorated store (strb) Rt register[7:0] = ----_xyz-,
    then destination is "abcd_xyzh"
if b = 2 and the decorated store (strb) Rt register[7:0] = ---x_yz--,
    then destination is "abcx_yzgh"
if b = 3 and the decorated store (strb) Rt register[7:0] = --xy_z---,
    then destination is "abxy_zfgh"
if b = 4 and the decorated store (strb) Rt register[7:0] = -xyz_----,
    then destination is "axyz_efgh"
if b = 5 and the decorated store (strb) Rt register[7:0] = xyz-____,
    then destination is "xyzd_efgh"
if b = 6 and the decorated store (strb) Rt register[7:0] = yz--____,
    then destination is "yzcd_efgh"
if b = 7 and the decorated store (strb) Rt register[7:0] = z---____,
    then destination is "zbcd_efgh"
```

Note from the example, when the starting bit position plus the field width exceeds the container size, only part of the source bit field is inserted into the destination memory location. Stated differently, if $(b + w + 1) > \text{container_width}$, only the low-order "container_width - b" bits are actually inserted.

The cycle-by-cycle BME operations are detailed in the following table.

Table 18-4. Cycle definitions of decorated store: bit field insert

| Pipeline stage | Cycle | | |
|----------------|---|--|--|
| | x | x+1 | x+2 |
| BME AHB_ap | Forward addr to memory; Decode decoration; Convert master_wt to slave_rd; Capture address, attributes | Recirculate captured addr + attr to memory as slave_wt | <next> |
| BME AHB_dp | <previous> | Perform memory read; Form bit mask; Form bitwise ((mask) ? wdata : rdata) and capture destination data in register | Perform write sending registered data to memory |

18.3.2 BME decorated loads

The functions supported by the BME's decorated loads include two single-bit load-and-`{set, clear}` operators plus unsigned bit field extracts.

For the two load-and-`{set, clear}` operations, BME converts a single decorated AHB load transaction into a two-cycle atomic read-modify-write sequence, where the combined read-modify operations are performed in the first AHB data phase, and then the write is performed in the second AHB data phase as the original read data is returned to the processor core. For an unsigned bit field extract, the decorated load transaction is stalled for one cycle in the BME as the data field is extracted, then aligned and returned to the processor in the second AHB data phase. This is the only decorated transaction that is not an atomic read-modify-write, as it is a simple data read.

A generic timing diagram of a decorated load showing a peripheral load-and-set 1-bit operation is shown as follows.

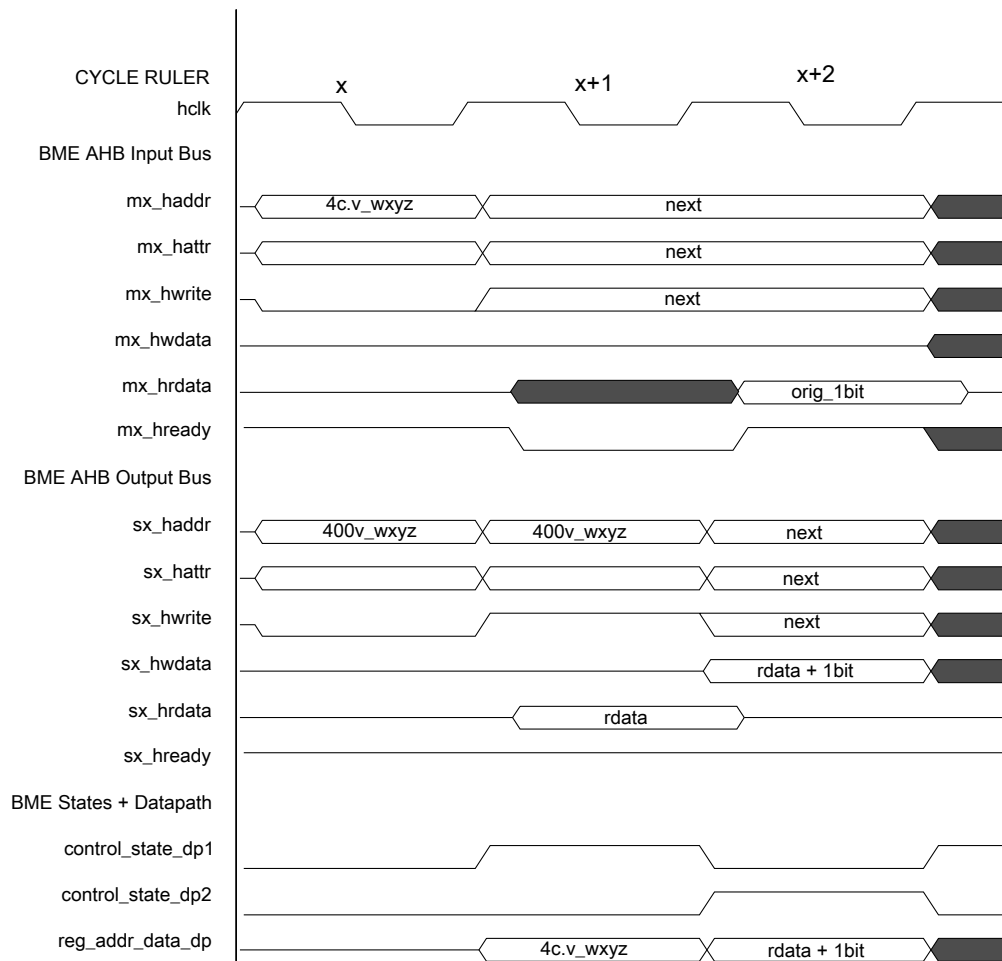

Figure 18-7. Decorated load: load-and-set 1-bit field insert timing diagram

Decorated load-and-`{set, clear}` 1-bit operations follow the execution template shown in the above figure: a 2-cycle read-modify-write operation:

1. Cycle x, first AHB address phase: Read from input bus is translated into a read operation on the output bus with the actual memory address (with the decoration removed) and then captured in a register
2. Cycle x+1, second AHB address phase: Write access with the registered (but actual) memory address is output
3. Cycle x+1, first AHB data phase: The "original" 1-bit memory read data is captured in a register, while the 1-bit field is set or clear based on the function defined by the decoration with the modified data captured in a register; the input bus cycle is stalled
4. Cycle x+2, second AHB data phase: The selected original 1-bit is right-justified, zero-filled and then driven onto the input read data bus, while the registered write data is sourced onto the output write data bus

NOTE

Any wait states inserted by the slave device are simply passed through the BME back to the master input bus, stalling the AHB transaction cycle for cycle.

A generic timing diagram of a decorated load showing an unsigned peripheral bit field operation is shown in the following figure.

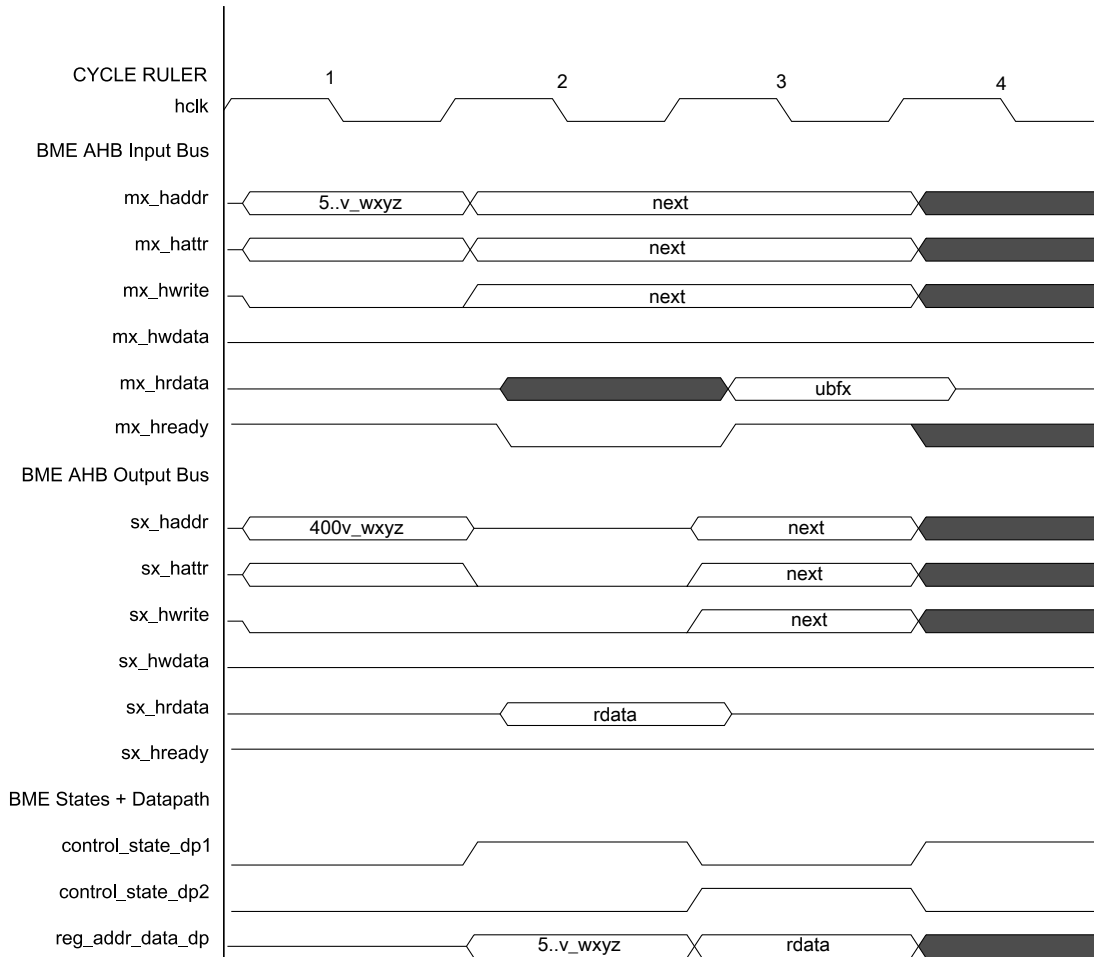

Figure 18-8. Decorated load: unsigned bit field insert timing diagram

The decorated unsigned bit field extract follows the same execution template shown in the above figure, a 2-cycle read operation:

- Cycle x, 1st AHB address phase: Read from input bus is translated into a read operation on the output bus with the actual memory address (with the decoration removed) and then captured in a register
- Cycle x+1, 2nd AHB address phase: Idle cycle

Functional description

- Cycle x+1, 1st AHB data phase: A bit mask is generated based on the starting bit position and the field width; the mask is AND'ed with the memory read data to isolate the bit field; the resulting data is captured in a data register; the input bus cycle is stalled
- Cycle x+2, 2nd AHB data phase: Registered data is logically right-aligned for proper alignment and driven onto the input read data bus

NOTE

Any wait states inserted by the slave device are simply passed through the BME back to the master input bus, stalling the AHB transaction cycle for cycle.

18.3.2.1 Decorated load: load-and-clear 1 bit (LAC1)

This command loads a 1-bit field defined by the LSB position (b) into the core's general purpose destination register (Rt) and zeroes the bit in the memory space after performing an atomic read-modify-write sequence.

The extracted 1-bit data field from the memory address is right-justified and zero-filled in the operand returned to the core.

The data size is specified by the read operation and can be byte (8-bit), halfword (16-bit) or word (32-bit).

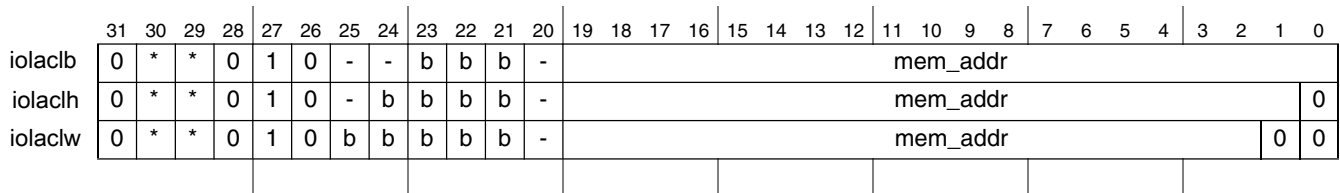

Figure 18-9. Decorated load address: load-and-clear 1 bit

See [Figure 18-9](#), where $\text{addr}[30:29] = 10$ for peripheral, $\text{addr}[28:26] = 010$ specifies the load-and-clear 1 bit operation, $\text{addr}[25:21]$ is "b", the bit identifier, and $\text{mem_addr}[19:0]$ specifies the address offset into the space based at $0x4000_0000$ for peripheral. The "-" indicates an address bit "don't care".

The decorated load-and-clear 1-bit read operation is defined in the following pseudo-code as:

```

rdata = ioclcl<sz>(accessAddress)           // decorated load-and-clear 1
tmp    = mem[accessAddress & 0xE00FFFFF, size] // memory read
mask   = 1 << b                               // generate bit mask
rdata  = (tmp & mask) >> b                     // read data returned to core
tmp    = tmp & ~mask                           // modify
mem[accessAddress & 0xE00FFFFF, size] = tmp   // memory write

```

The cycle-by-cycle BME operations are detailed in the following table.

Table 18-5. Cycle definitions of decorated load: load-and-clear 1 bit

| Pipeline Stage | Cycle | | |
|----------------|--|---|---|
| | x | x+1 | x+2 |
| BME AHB_ap | Forward addr to memory; Decode decoration; Capture address, attributes | Recirculate captured addr + attr to memory as slave_wt | <next> |
| BME AHB_dp | <previous> | Perform memory read; Form bit mask; Extract bit from rdata; Form (rdata & ~mask) and capture destination data in register | Return extracted bit to master; Perform write sending registered data to memory |

18.3.2.2 Decorated Load: Load-and-Set 1 Bit (LAS1)

This command loads a 1-bit field defined by the LSB position (b) into the core's general purpose destination register (Rt) and sets the bit in the memory space after performing an atomic read-modify-write sequence.

The extracted one bit data field from the memory address is right justified and zero filled in the operand returned to the core.

The data size is specified by the read operation and can be byte (8-bit), halfword (16-bit) or word (32-bit).

| | 31 | 30 | 29 | 28 | 27 | 26 | 25 | 24 | 23 | 22 | 21 | 20 | 19 | 18 | 17 | 16 | 15 | 14 | 13 | 12 | 11 | 10 | 9 | 8 | 7 | 6 | 5 | 4 | 3 | 2 | 1 | 0 |
|--------|----|----|----|----|----|----|----|----|----|----|----|----|----------|----|----|----|----|----|----|----|----|----|---|---|---|---|---|---|---|---|---|---|
| iolasb | 0 | * | * | 0 | 1 | 1 | - | - | b | b | b | - | mem_addr | | | | | | | | | | | | | | | | | | | |
| iolash | 0 | * | * | 0 | 1 | 1 | - | b | b | b | b | - | mem_addr | | | | | | | | | | | | | | | | 0 | | | |
| iolasw | 0 | * | * | 0 | 1 | 1 | b | b | b | b | b | - | mem_addr | | | | | | | | | | | | | | | | 0 | 0 | | |

Figure 18-10. Decorated load address: load-and-set 1 bit

where $\text{addr}[30:29] = 10$ for peripheral, $\text{addr}[28:26] = 011$ specifies the load-and-set 1 bit operation, $\text{addr}[25:21]$ is "b", the bit identifier, and $\text{mem_addr}[19:0]$ specifies the address offset into the space based at $0x4000_0000$ for peripheral. The "-" indicates an address bit "don't care".

The decorated Load-and-Set 1 Bit read operation is defined in the following pseudo-code as:

```

rdata = iolas1<sz>(accessAddress)           // decorated load-and-set 1

tmp    = mem[accessAddress & 0xE00FFFFF, size] // memory read
mask   = 1 << b                               // generate bit mask
rdata  = (tmp & mask) >> b                     // read data returned to core

```

Functional description

```
tmp = tmp | mask // modify
mem[accessAddress & 0xE0FFFFFF, size] = tmp // memory write
```

The cycle-by-cycle BME operations are detailed in the following table.

Table 18-6. Cycle definitions of decorated load: load-and-set 1-bit

| Pipeline Stage | Cycle | | |
|----------------|---|--|---|
| | x | x+1 | x+2 |
| BME AHB_ap | Forward addr to memory; Decode decoration; Capture address, attributes | Recirculate captured addr + attr to memory as slave_wt | <next> |
| BME AHB_dp | <previous> | Perform memory read; Form bit mask; Extract bit from rdata; Form (rdata mask) and capture destination data in register | Return extracted bit to master; Perform write sending registered data to memory |

18.3.2.3 Decorated load unsigned bit field extract (UBFX)

This command extracts a bit field defined by LSB position (b) and the bit field width (w +1) from the memory "container" defined by the access size associated with the load instruction using a two-cycle read sequence.

The extracted bit field from the memory address is right-justified and zero-filled in the operand returned to the core. Recall this is the only decorated operation that does not perform a memory write, that is, UBFX only performs a read.

The data size is specified by the write operation and can be byte (8-bit), halfword (16-bit) or word (32-bit). Note for the word sized operation, the maximum bit field width is 16 bits.

The use of a UBFX operation is recommended to extract a single bit. For this case, the w field is simply set to 0, indicating a bit field width of 1.

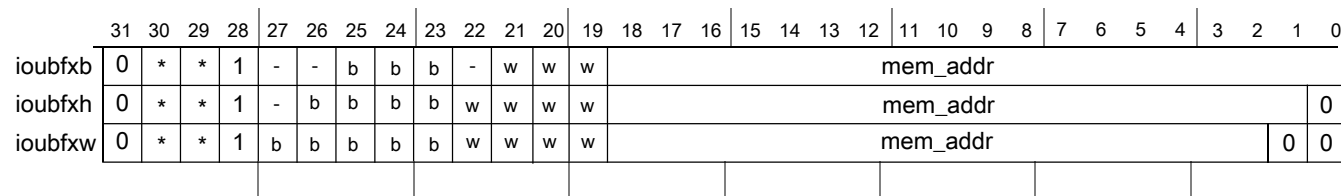

Figure 18-11. Decorated load address: unsigned bit field extract

See [Figure 18-11](#), where $\text{addr}[30:29] = 10$ for peripheral, $\text{addr}[28] = 1$ specifies the unsigned bit field extract operation, $\text{addr}[27:23]$ is "b", the LSB identifier, $\text{addr}[22:19]$ is "w", the bit field width minus 1 identifier, and $\text{mem_addr}[18:0]$ specifies the address

offset into the space based at 0x4000_0000 for peripheral. The "-" indicates an address bit "don't care". Note, unlike the other decorated load operations, UBFX uses addr[19] as the least significant bit in the "w" specifier and not as an address bit.

The decorated unsigned bit field extract read operation is defined in the following pseudo-code as:

```
rdata = ioubfx<sz>(accessAddress)           // unsigned bit field extract

tmp    = mem[accessAddress & 0xE007FFFF, size] // memory read
mask   = ((1 << (w+1)) - 1) << b             // generate bit mask
rdata  = (tmp & mask) >> b                   // read data returned to core
```

Like the BFI operation, when the starting bit position plus the field width exceeds the container size, only part of the source bit field is extracted from the destination memory location. Stated differently, if $(b + w + 1) > \text{container_width}$, only the low-order " $\text{container_width} - b$ " bits are actually extracted. The cycle-by-cycle BME operations are detailed in the following table.

Table 18-7. Cycle definitions of decorated load: unsigned bit field extract

| Pipeline Stage | Cycle | | |
|----------------|--|---|---|
| | x | x+1 | x+2 |
| BME AHB_ap | Forward addr to memory; Decode decoration; Capture address, attributes | Idle AHB address phase | <next> |
| BME AHB_dp | <previous> | Perform memory read; Form bit mask; Form (rdata & mask) and capture destination data in register | Logically right shift registered data; Return justified rdata to master |

18.3.3 Additional details on decorated addresses and GPIO accesses

As previously noted, the peripheral address space occupies a 516 KB region: 512 KB based at 0x4000_0000 plus a 4 KB space based at 0x400F_F000 for GPIO accesses. This memory layout provides compatibility with the Kinetis K Family and provides 129 address "slots", each 4 KB in size.

The GPIO address space is multiply-mapped by the hardware: it appears at the "standard" system address 0x400F_F000 and is physically located in the address slot corresponding to address 0x4000_F000. Decorated loads and stores create a slight complication involving accesses to the GPIO. Recall the use of address[19] varies by decorated operation; for AND, OR, XOR, LAC1 and LAS1, this bit functions as a true address bit, while for BFI and UBFX, this bit defines the least significant bit of the "w" bit field specifier.

As a result, undecorated GPIO references and decorated AND, OR, XOR, LAC1 and LAS1 operations can use the standard 0x400F_F000 base address, while decorated BFI and UBFX operations must use the alternate 0x4000_F000 base address. Another implementation can simply use 0x400F_F000 as the base address for all undecorated GPIO accesses and 0x4000_F000 as the base address for all decorated accesses. Both implementations are supported by the hardware.

Table 18-8. Decorated peripheral and GPIO address details

| Peripheral address space | Description |
|--------------------------|--|
| 0x4000_0000–0x4007_FFFF | Undecorated (normal) peripheral accesses |
| 0x4008_0000–0x400F_EFFF | Illegal addresses; attempted references are aborted and error terminated |
| 0x400F_F000–0x400F_FFFF | Undecorated (normal) GPIO accesses using standard address |
| 0x4010_0000–0x43FF_FFFF | Illegal addresses; attempted references are aborted and error terminated |
| 0x4400_0000–0x4FFF_FFFF | Decorated AND, OR, XOR, LAC1, LAS1 references to peripherals and GPIO based at either 0x4000_F000 or 0x400F_F000 |
| 0x5000_0000–0x5FFF_FFFF | Decorated BFI, UBFX references to peripherals and GPIO only based at 0x4000_F000 |

18.4 Application information

In this section, GNU assembler macros with C expression operands are presented as examples of the required instructions to perform decorated operations.

This section specifically presents a partial bme.h file defining the assembly language expressions for decorated logical stores: AND, OR, and XOR. Comparable functions for BFI and the decorated loads are more complex and available in the complete BME header file.

These macros use the same function names presented in [Functional description](#).

```
#define IOANDW(ADDR,WDATA)          \
    __asm("ldr    r3, =(1<<26);"   \
          "orr    r3, %[addr];"     \
          "mov    r2, %[wdata];"    \
          "str    r2, [r3];"        \
          ":: [addr] \"r\" (ADDR), [wdata] \"r\" (WDATA) : \"r2\", \"r3\");

#define IOANDH(ADDR,WDATA)          \
    __asm("ldr    r3, =(1<<26);"   \
          "orr    r3, %[addr];"     \
          "mov    r2, %[wdata];"    \
          "strh   r2, [r3];"        \
          ":: [addr] \"r\" (ADDR), [wdata] \"r\" (WDATA) : \"r2\", \"r3\");

#define IOANDB(ADDR,WDATA)          \
    __asm("ldr    r3, =(1<<26);"   \
          "orr    r3, %[addr];"     \
          "mov    r2, %[wdata];"    \
          "strb   r2, [r3];"        \
          ":: [addr] \"r\" (ADDR), [wdata] \"r\" (WDATA) : \"r2\", \"r3\");
```

```

#define IOORW(ADDR,WDATA)          \
    __asm("ldr    r3, =(1<<27);"  \
          "orr    r3, %[addr];"    \
          "mov    r2, %[wdata];"   \
          "str    r2, [r3];"       \
          ":: [addr] "r" (ADDR), [wdata] "r" (WDATA) : "r2", "r3");

#define IOORH(ADDR,WDATA)          \
    __asm("ldr    r3, =(1<<27);"  \
          "orr    r3, %[addr];"    \
          "mov    r2, %[wdata];"   \
          "strh   r2, [r3];"       \
          ":: [addr] "r" (ADDR), [wdata] "r" (WDATA) : "r2", "r3");

#define IOORB(ADDR,WDATA)          \
    __asm("ldr    r3, =(1<<27);"  \
          "orr    r3, %[addr];"    \
          "mov    r2, %[wdata];"   \
          "strb   r2, [r3];"       \
          ":: [addr] "r" (ADDR), [wdata] "r" (WDATA) : "r2", "r3");

#define IOXORW(ADDR,WDATA)         \
    __asm("ldr    r3, =(3<<26);"  \
          "orr    r3, %[addr];"    \
          "mov    r2, %[wdata];"   \
          "str    r2, [r3];"       \
          ":: [addr] "r" (ADDR), [wdata] "r" (WDATA) : "r2", "r3");

#define IOXORH(ADDR,WDATA)         \
    __asm("ldr    r3, =(3<<26);"  \
          "orr    r3, %[addr];"    \
          "mov    r2, %[wdata];"   \
          "strh   r2, [r3];"       \
          ":: [addr] "r" (ADDR), [wdata] "r" (WDATA) : "r2", "r3");

#define IOXORB(ADDR,WDATA)         \
    __asm("ldr    r3, =(3<<26);"  \
          "orr    r3, %[addr];"    \
          "mov    r2, %[wdata];"   \
          "strb   r2, [r3];"       \
          ":: [addr] "r" (ADDR), [wdata] "r" (WDATA) : "r2", "r3");

```

Chapter 19

Miscellaneous Control Module (MCM)

The Miscellaneous Control Module (MCM) provides a myriad of miscellaneous control functions for the platform (RPP).

19.1 Introduction

The Miscellaneous Control Module (MCM) provides a myriad of miscellaneous control functions.

19.1.1 Features

The MCM includes the following features:

- Program-visible information on the platform configuration
- Crossbar master arbitration policy selection
- Flash controller speculation buffer and cache configurations

19.2 Memory map/register descriptions

The memory map and register descriptions found here describe the registers using byte addresses. The registers can be written only when in supervisor mode.

MCM memory map

| Absolute address (hex) | Register name | Width (in bits) | Access | Reset value | Section/page |
|------------------------|--|-----------------|--------|-------------|----------------------------|
| F000_3008 | Crossbar Switch (AXBS) Slave Configuration (MCM_PLASC) | 16 | R | 0007h | 19.2.1/382 |

Table continues on the next page...

MCM memory map (continued)

| Absolute address (hex) | Register name | Width (in bits) | Access | Reset value | Section/page |
|------------------------|---|-----------------|--------|-------------|----------------------------|
| F000_300A | Crossbar Switch (AXBS) Master Configuration (MCM_PLAMC) | 16 | R | 0005h | 19.2.2/383 |
| F000_300C | Platform Control Register (MCM_PLACR) | 32 | R/W | 0000_0050h | 19.2.3/383 |
| F000_3040 | Compute Operation Control Register (MCM_CPO) | 32 | R/W | 0000_0000h | 19.2.4/386 |

19.2.1 Crossbar Switch (AXBS) Slave Configuration (MCM_PLASC)

PLASC is a 16-bit read-only register identifying the presence/absence of bus slave connections to the device’s crossbar switch.

Address: F000_3000h base + 8h offset = F000_3008h

| | | | | | | | | | | | | | | | | |
|-------|----|----|----|----|----|----|---|---|-----|---|---|---|---|---|---|---|
| Bit | 15 | 14 | 13 | 12 | 11 | 10 | 9 | 8 | 7 | 6 | 5 | 4 | 3 | 2 | 1 | 0 |
| Read | 0 | | | | | | | | ASC | | | | | | | |
| Write | | | | | | | | | | | | | | | | |
| Reset | 0 | 0 | 0 | 0 | 0 | 0 | 0 | 0 | 0 | 0 | 0 | 0 | 0 | 1 | 1 | 1 |

MCM_PLASC field descriptions

| Field | Description |
|---------------|---|
| 15–8 Reserved | This field is reserved. This read-only field is reserved and always has the value 0. |
| ASC | Each bit in the ASC field indicates whether there is a corresponding connection to the crossbar switch's slave input port. 0 A bus slave connection to AXBS input port <i>n</i> is absent. 1 A bus slave connection to AXBS input port <i>n</i> is present. |

19.2.2 Crossbar Switch (AXBS) Master Configuration (MCM_PLAMC)

PLAMC is a 16-bit read-only register identifying the presence/absence of bus master connections to the device's crossbar switch.

Address: F000_3000h base + Ah offset = F000_300Ah

| | | | | | | | | | | | | | | | | | |
|-------|----------|----|----|----|----|----|---|---|-----|---|---|---|---|---|---|---|---|
| Bit | 15 | 14 | 13 | 12 | 11 | 10 | 9 | 8 | 7 | 6 | 5 | 4 | 3 | 2 | 1 | 0 | |
| Read | 0 | | | | | | | | AMC | | | | | | | | |
| Write | [Shaded] | | | | | | | | | | | | | | | | |
| Reset | 0 | 0 | 0 | 0 | 0 | 0 | 0 | 0 | 0 | 0 | 0 | 0 | 0 | 0 | 1 | 0 | 1 |

MCM_PLAMC field descriptions

| Field | Description |
|------------------|---|
| 15–8 Reserved | This field is reserved. This read-only field is reserved and always has the value 0. |
| AMC | Each bit in the AMC field indicates whether there is a corresponding connection to the AXBS master input port. 0 A bus master connection to AXBS input port <i>n</i> is absent 1 A bus master connection to AXBS input port <i>n</i> is present |

19.2.3 Platform Control Register (MCM_PLACR)

The PLACR register selects the arbitration policy for the crossbar masters and configures the flash memory controller.

The speculation buffer and cache in the flash memory controller is configurable via PLACR[15:10].

The speculation buffer is enabled only for instructions after reset. It is possible to have these states for the speculation buffer:

| DFCS | EFDS | Description |
|------|------|--|
| 0 | 0 | Speculation buffer is on for instruction and off for data. |
| 0 | 1 | Speculation buffer is on for instruction and on for data. |
| 1 | X | Speculation buffer is off. |

Memory map/register descriptions

The cache in flash controller is enabled and caching both instruction and data type fetches after reset. It is possible to have these states for the cache:

| DFCC | DFCIC | DFCDA | Description |
|------|-------|-------|---|
| 0 | 0 | 0 | Cache is on for both instruction and data. |
| 0 | 0 | 1 | Cache is on for instruction and off for data. |
| 0 | 1 | 0 | Cache is off for instruction and on for data. |
| 0 | 1 | 1 | Cache is off for both instruction and data. |
| 1 | X | X | Cache is off. |

Address: F000_3000h base + Ch offset = F000_300Ch

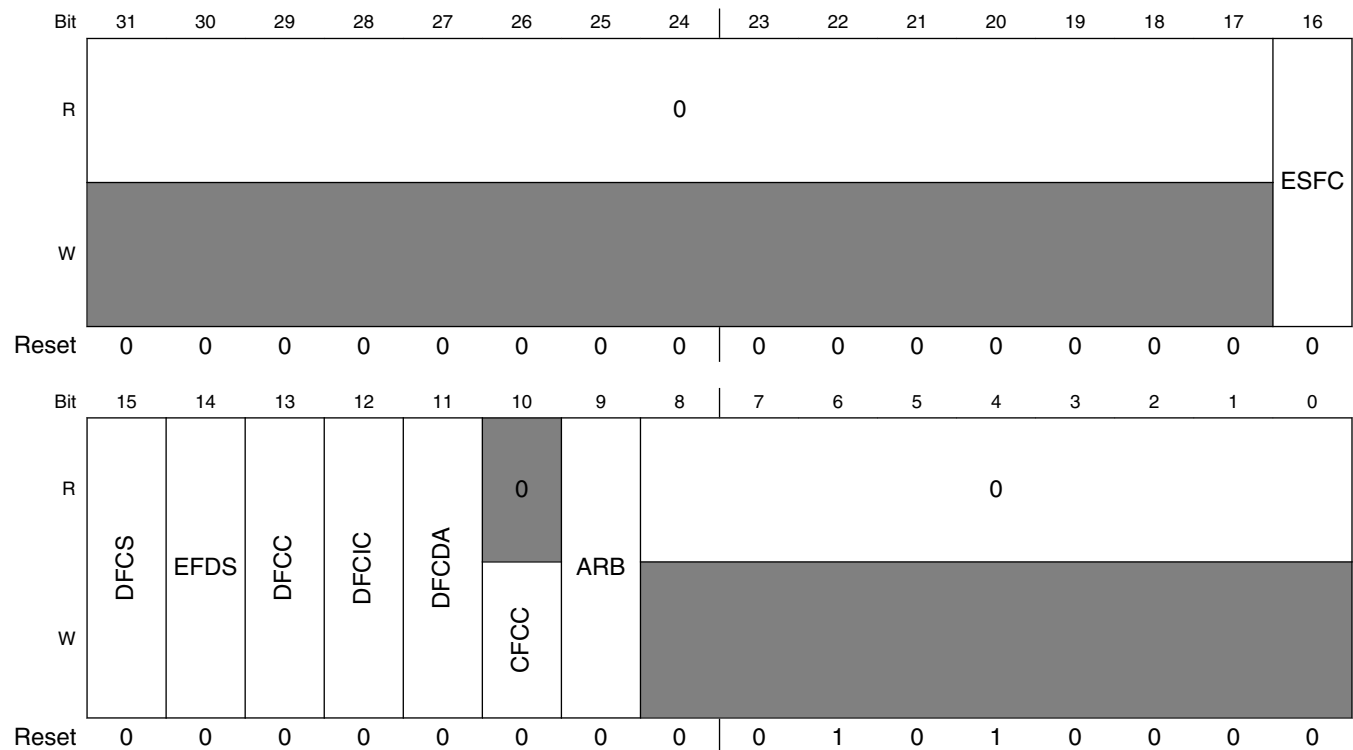

MCM_PLACR field descriptions

| Field | Description |
|-------------------|---|
| 31–17 Reserved | This field is reserved. This read-only field is reserved and always has the value 0. |
| 16 ESFC | Enable Stalling Flash Controller Enables stalling flash controller when flash is busy. |

Table continues on the next page...

MCM_PLACR field descriptions (continued)

| Field | Description |
|-------------|---|
| | <p>When software needs to access the flash memory while a flash memory resource is being manipulated by a flash command, software can enable a stall mechanism to avoid a read collision. The stall mechanism allows software to execute code from the same block on which flash operations are being performed. However, software must ensure the sector the flash operations are being performed on is not the same sector from which the code is executing.</p> <p>ESFC enables the stall mechanism. This bit must be set only just before the flash operation is executed and must be cleared when the operation completes.</p> <p>0 Disable stalling flash controller when flash is busy. 1 Enable stalling flash controller when flash is busy.</p> |
| 15 DFCS | <p>Disable Flash Controller Speculation</p> <p>Disables flash controller speculation.</p> <p>0 Enable flash controller speculation. 1 Disable flash controller speculation.</p> |
| 14 EFDS | <p>Enable Flash Data Speculation</p> <p>Enables flash data speculation.</p> <p>0 Disable flash data speculation. 1 Enable flash data speculation.</p> |
| 13 DFCC | <p>Disable Flash Controller Cache</p> <p>Disables flash controller cache.</p> <p>0 Enable flash controller cache. 1 Disable flash controller cache.</p> |
| 12 DFCIC | <p>Disable Flash Controller Instruction Caching</p> <p>Disables flash controller instruction caching.</p> <p>0 Enable flash controller instruction caching. 1 Disable flash controller instruction caching.</p> |
| 11 DFCDA | <p>Disable Flash Controller Data Caching</p> <p>Disables flash controller data caching.</p> <p>0 Enable flash controller data caching 1 Disable flash controller data caching.</p> |
| 10 CFCC | <p>Clear Flash Controller Cache</p> <p>Writing a 1 to this field clears the cache. Writing a 0 to this field is ignored. This field always reads as 0.</p> |
| 9 ARB | <p>Arbitration select</p> <p>0 Fixed-priority arbitration for the crossbar masters 1 Round-robin arbitration for the crossbar masters</p> |
| Reserved | <p>This field is reserved. This read-only field is reserved and always has the value 0.</p> |

19.2.4 Compute Operation Control Register (MCM_CPO)

This register controls the Compute Operation.

Address: F000_3000h base + 40h offset = F000_3040h

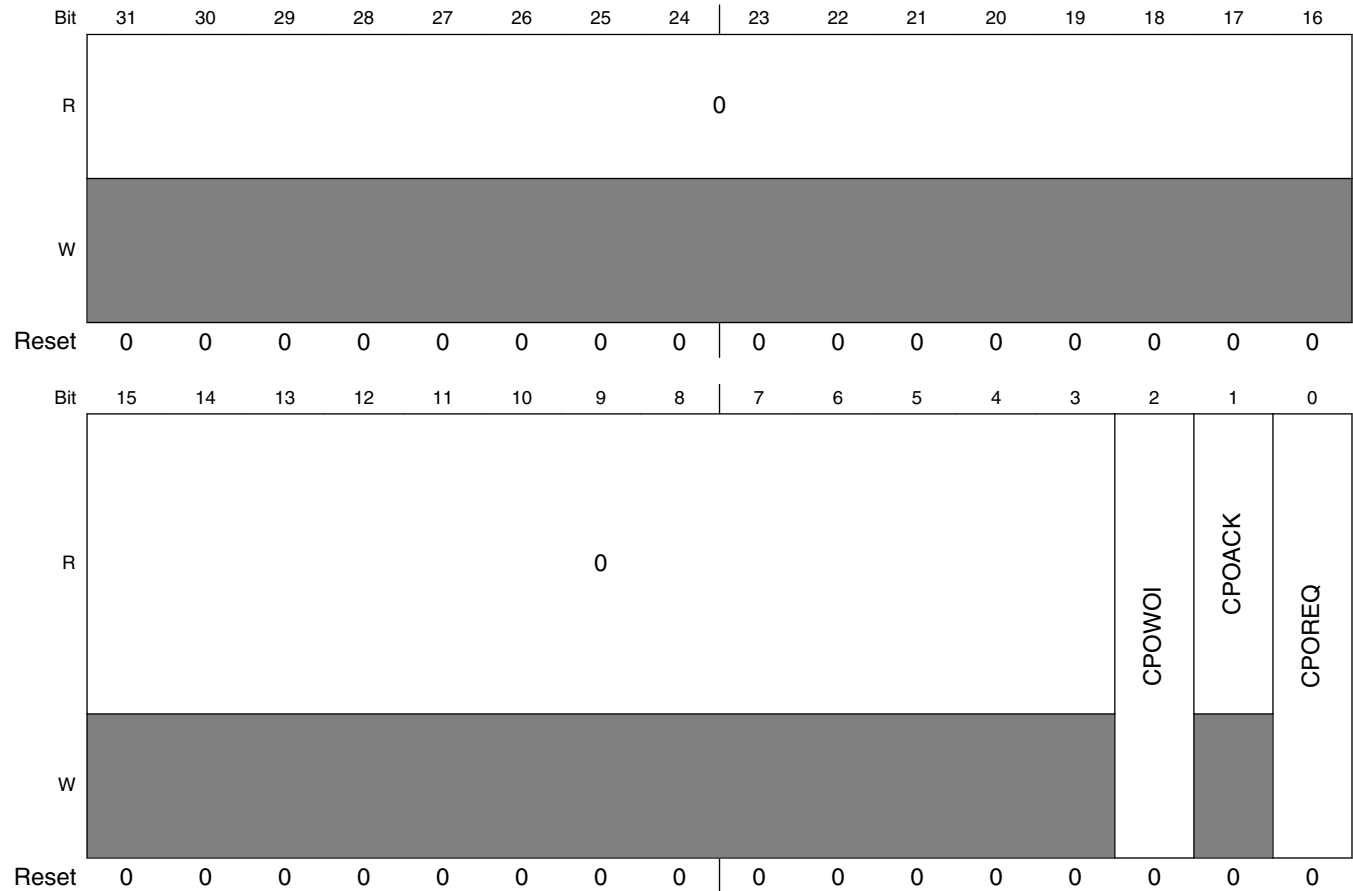

MCM_CPO field descriptions

| Field | Description |
|------------------|---|
| 31–3 Reserved | This field is reserved. This read-only field is reserved and always has the value 0. |
| 2 CPOWUI | Compute Operation Wake-up on Interrupt 0 No effect. 1 When set, the CPOREQ is cleared on any interrupt or exception vector fetch. |
| 1 CPOACK | Compute Operation Acknowledge 0 Compute operation entry has not completed or compute operation exit has completed. 1 Compute operation entry has completed or compute operation exit has not completed. |
| 0 CPOREQ | Compute Operation Request This bit is auto-cleared by vector fetching if CPOWUI = 1. |

Table continues on the next page...

MCM_CPO field descriptions (continued)

| Field | Description |
|--------------|----------------------------|
| 0 | Request is cleared. |
| 1 | Request Compute Operation. |

Chapter 20

Micro Trace Buffer (MTB)

This module explains how microcontrollers using the Cortex-M0+ processor core support CoreSight Micro Trace Buffer to provide program trace capabilities. It also explains about change-of-flow data packets in a user-defined region of the system RAM and DWT (Data Watchpoint and Trace) module that allows a user to define watchpoint addresses, or an address and data value, that when triggered can be used to start or stop the program trace recording.

20.1 Introduction

Microcontrollers using the Cortex-M0+ processor core include support for a CoreSight Micro Trace Buffer to provide program trace capabilities.

The proper name for this function is the CoreSight Micro Trace Buffer for the Cortex-M0+ Processor; in this document, it is simply abbreviated as the MTB.

The simple program trace function creates instruction address change-of-flow data packets in a user-defined region of the system RAM. Accordingly, the system RAM controller manages requests from two sources:

- AMBA-AHB reads and writes from the system bus
- program trace packet writes from the processor

As part of the MTB functionality, there is a DWT (Data Watchpoint and Trace) module that allows the user to define watchpoint addresses, or optionally, an address and data value, that when triggered, can be used to start or stop the program trace recording.

This document details the functionality of both the MTB_RAM and MTB_DWT capabilities.

20.1.1 Overview

A generic block diagram of the processor core and platform for this class of ultra low-end microcontrollers is shown as follows:

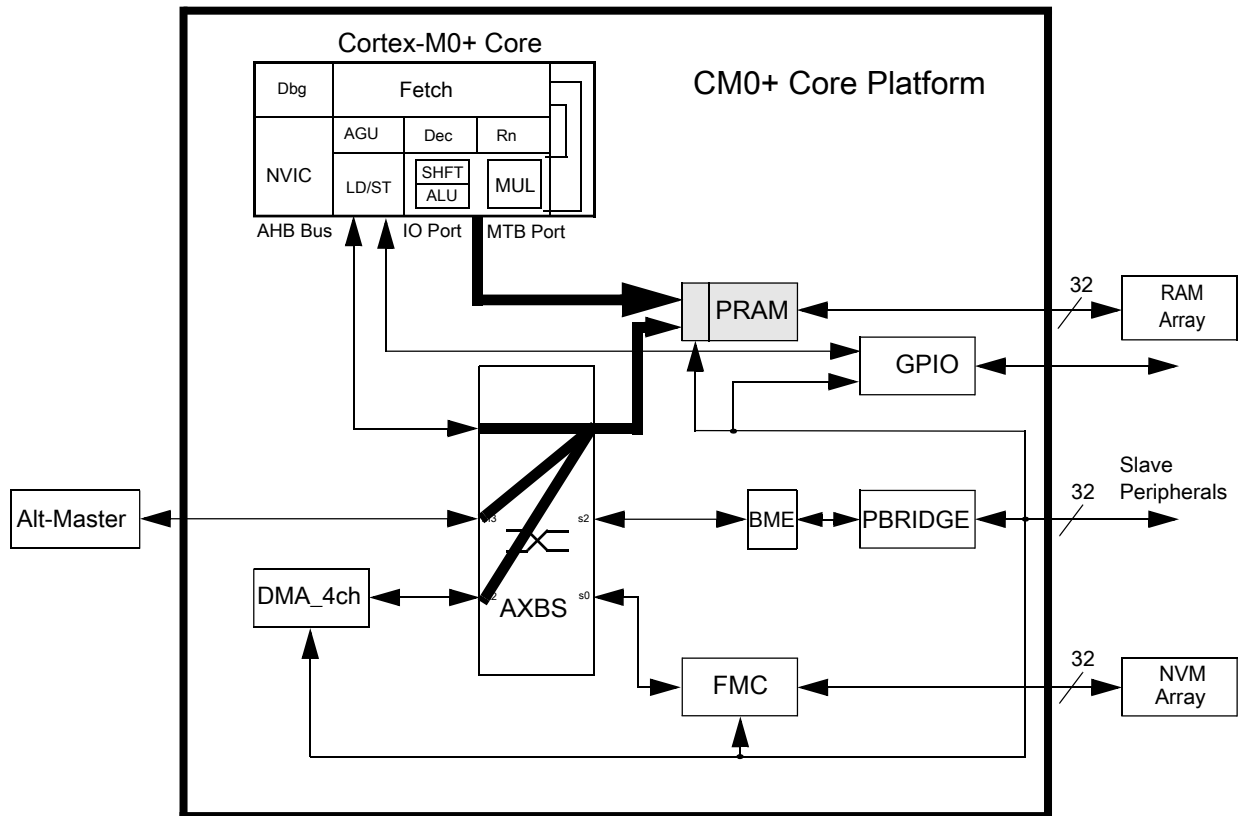

Figure 20-1. Generic Cortex-M0+ core platform block diagram

As shown in the block diagram, the platform RAM (PRAM) controller connects to two input buses:

- the crossbar slave port for system bus accesses
- a "private execution MTB port" from the core

The logical paths from the crossbar master input ports to the PRAM controller are highlighted along with the private execution trace port from the processor core. The private MTB port signals the instruction address information needed for the 64-bit program trace packets written into the system RAM. The PRAM controller output interfaces to the attached RAM array. In this document, the PRAM controller is the MTB_RAM controller.

The following information is taken from the ARM CoreSight Micro Trace Buffer documentation.

"The execution trace packet consists of a pair of 32-bit words that the MTB generates when it detects the processor PC value changes non-sequentially. A non-sequential PC change can occur during branch instructions or during exception entry.

The processor can cause a trace packet to be generated for any instruction.

The following figure shows how the execution trace information is stored in memory as a sequence of packets.

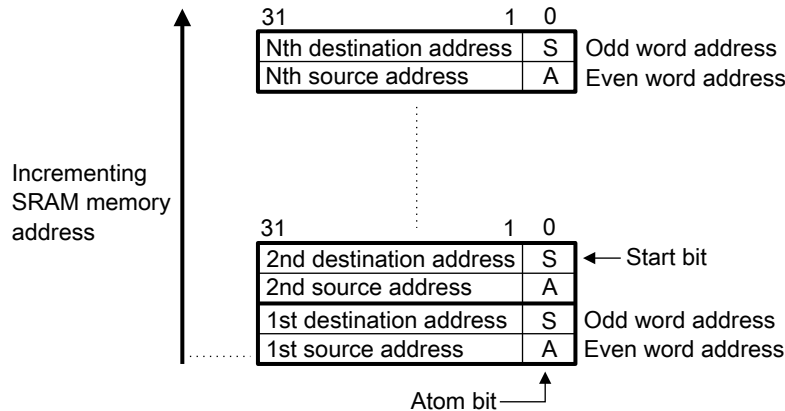

Figure 20-2. MTB execution trace storage format

The first, lower addressed, word contains the source of the branch, the address it branched from. The value stored only records bits[31:1] of the source address, because Thumb instructions are at least halfword aligned. The least significant bit of the value is the A-bit. The A-bit indicates the atomic state of the processor at the time of the branch, and can differentiate whether the branch originated from an instruction in a program, an exception, or a PC update in Debug state. When it is zero the branch originated from an instruction, when it is one the branch originated from an exception or PC update in Debug state. This word is always stored at an even word location.

The second, higher addressed word contains the destination of the branch, the address it branched to. The value stored only records bits[31:1] of the branch address. The least significant bit of the value is the S-bit. The S-bit indicates where the trace started. An S-bit value of 1 indicates where the first packet after the trace started and a value of 0 is used for other packets. Because it is possible to start and stop tracing multiple times in a trace session, the memory might contain several packets with the S-bit set to 1. This word is always stored in the next higher word in memory, an odd word address.

When the A-bit is set to 1, the source address field contains the architecturally-preferred return address for the exception. For example, if an exception was caused by an SVC instruction, then the source address field contains the address of the following instruction. This is different from the case where the A-bit is set to 0. In this case, the source address contains the address of the branch instruction.

For an exception return operation, two packets are generated:

- The first packet has the:
 - Source address field set to the address of the instruction that causes the exception return, BX or POP.
 - Destination address field set to bits[31:1] of the EXC_RETURN value. See the ARM v6-M Architecture Reference Manual.
 - The A-bit set to 0.
- The second packet has the:
 - Source address field set to bits[31:1] of the EXC_RETURN value.
 - Destination address field set to the address of the instruction where execution commences.
 - A-bit set to 1."

Given the recorded change-of-flow trace packets in system RAM and the memory image of the application, a debugger can read out the data and create an instruction-by-instruction program trace. In keeping with the low area and power implementation cost design targets, the MTB trace format is less efficient than other CoreSight trace modules, for example, the ETM (Embedded Trace Macrocell). Since each branch packet is 8 bytes in size, a 1 KB block of system RAM can contain 128 branches. Using the Dhrystone 2.1 benchmark's dynamic runtime as an example, this corresponds to about 875 instructions per KB of trace RAM, or with a zero wait state memory, this corresponds to approximately 1600 processor cycles per KB. This metric is obviously very sensitive to the runtime characteristics of the user code.

The MTB_DWT function (not shown in the core platform block diagram) monitors the processor address and data buses so that configurable watchpoints can be detected to trigger the appropriate response in the MTB recording.

20.1.2 Features

The key features of the MTB_RAM and MTB_DWT include:

- Memory controller for system RAM and Micro Trace Buffer for program trace packets
- Read/write capabilities for system RAM accesses, write-only for program trace packets
- Supports zero wait state response to system bus accesses when no trace data is being written
- Can buffer two AHB address phases and one data write for system RAM accesses
- Supports 64-bit program trace packets including source and destination instruction addresses

- Program trace information in RAM available to MCU's application code or external debugger
- Program trace watchpoint configuration accessible by MCU's application code or debugger
- Location and size of RAM trace buffer is configured by software
- Two DWT comparators (addresses or address + data) provide programmable start/stop recording
- CoreSight compliant debug functionality

20.1.3 Modes of operation

The MTB_RAM and MTB_DWT functions do not support any special modes of operation. The MTB_RAM controller, as a memory-mapped device located on the platform's slave AHB system bus, responds strictly on the basis of memory addresses for accesses to its attached RAM array. The MTB private execution bus provides program trace packet write information to the RAM controller. Both the MTB_RAM and MTB_DWT modules are memory-mapped, so their programming models can be accessed.

All functionality associated with the MTB_RAM and MTB_DWT modules resides in the core platform's clock domain; this includes its connections with the RAM array.

20.2 External signal description

The MTB_RAM and MTB_DWT modules do not directly support any external interfaces.

The internal interface includes a standard AHB bus with a 32-bit datapath width from the appropriate crossbar slave port plus the private execution trace bus from the processor core. The signals in the private execution trace bus are detailed in the following table taken from the ARM CoreSight Micro Trace Buffer documentation. The signal direction is defined as viewed by the MTB_RAM controller.

Table 20-1. Private execution trace port from the core to MTB_RAM

| Signal | Direction | Description |
|--------|-----------|--|
| LOCKUP | Input | Indicates the processor is in the Lockup state. This signal is driven LOW for cycles when the processor is executing normally and driven HIGH for every cycle the processor is waiting in the Lockup state. This signal is valid on every cycle. |
| IAESEQ | Input | Indicates the next instruction address in execute, IAEX, is sequential, that is non-branching. |

Table continues on the next page...

Table 20-1. Private execution trace port from the core to MTB_RAM (continued)

| Signal | Direction | Description |
|------------|-----------|---|
| IAEXEN | Input | IAEX register enable. |
| IAEX[30:0] | Input | Registered address of the instruction in the execution stage, shifted right by one bit, that is, PC >> 1. |
| ATOMIC | Input | Indicates the processor is performing non-instruction related activities. |
| EDBGRQ | Output | Request for the processor to enter the Debug state, if enabled, and halt. |

In addition, there are two signals formed by the MTB_DWT module and driven to the MTB_RAM controller: TSTART (trace start) and TSTOP (trace stop). These signals can be configured using the trace watchpoints to define programmable addresses and data values to affect the program trace recording state.

20.3 Memory map and register definition

The MTB_RAM and MTB_DWT modules each support a sparsely-populated 4 KB address space for their programming models. For each address space, there are a variety of control and configurable registers near the base address, followed by a large unused address space and finally a set of CoreSight registers to support dynamic determination of the debug configuration for the device.

Accesses to the programming model follow standard ARM conventions. Taken from the ARM CoreSight Micro Trace Buffer documentation, these are:

- Do not attempt to access reserved or unused address locations. Attempting to access these locations can result in UNPREDICTABLE behavior.
- The behavior of the MTB is UNPREDICTABLE if the registers with UNKNOWN reset values are not programmed prior to enabling trace.
- Unless otherwise stated in the accompanying text:
 - Do not modify reserved register bits
 - Ignore reserved register bits on reads
 - All register bits are reset to a logic 0 by a system or power-on reset
 - Use only word size, 32-bit, transactions to access all registers

20.3.1 MTB_RAM Memory Map

MTB memory map

| Absolute address (hex) | Register name | Width (in bits) | Access | Reset value | Section/page |
|------------------------|---|-----------------|--------|-------------|-------------------|
| F000_0000 | MTB Position Register (MTB_POSITION) | 32 | R/W | Undefined | 20.3.1.1/ 396 |
| F000_0004 | MTB Master Register (MTB_MASTER) | 32 | R/W | See section | 20.3.1.2/ 398 |
| F000_0008 | MTB Flow Register (MTB_FLOW) | 32 | R/W | Undefined | 20.3.1.3/ 399 |
| F000_000C | MTB Base Register (MTB_BASE) | 32 | R | Undefined | 20.3.1.4/ 401 |
| F000_0F00 | Integration Mode Control Register (MTB_MODECTRL) | 32 | R | 0000_0000h | 20.3.1.5/ 402 |
| F000_0FA0 | Claim TAG Set Register (MTB_TAGSET) | 32 | R | 0000_0000h | 20.3.1.6/ 402 |
| F000_0FA4 | Claim TAG Clear Register (MTB_TAGCLEAR) | 32 | R | 0000_0000h | 20.3.1.7/ 403 |
| F000_0FB0 | Lock Access Register (MTB_LOCKACCESS) | 32 | R | 0000_0000h | 20.3.1.8/ 403 |
| F000_0FB4 | Lock Status Register (MTB_LOCKSTAT) | 32 | R | 0000_0000h | 20.3.1.9/ 404 |
| F000_0FB8 | Authentication Status Register (MTB_AUTHSTAT) | 32 | R | 0000_0000h | 20.3.1.10/ 404 |
| F000_0FBC | Device Architecture Register (MTB_DEVICEARCH) | 32 | R | 4770_0A31h | 20.3.1.11/ 405 |
| F000_0FC8 | Device Configuration Register (MTB_DEVICECFG) | 32 | R | 0000_0000h | 20.3.1.12/ 405 |
| F000_0FCC | Device Type Identifier Register (MTB_DEVICETYPID) | 32 | R | 0000_0031h | 20.3.1.13/ 406 |
| F000_0FD0 | Peripheral ID Register (MTB_PERIPHID4) | 32 | R | See section | 20.3.1.14/ 406 |
| F000_0FD4 | Peripheral ID Register (MTB_PERIPHID5) | 32 | R | See section | 20.3.1.14/ 406 |
| F000_0FD8 | Peripheral ID Register (MTB_PERIPHID6) | 32 | R | See section | 20.3.1.14/ 406 |
| F000_0FDC | Peripheral ID Register (MTB_PERIPHID7) | 32 | R | See section | 20.3.1.14/ 406 |
| F000_0FE0 | Peripheral ID Register (MTB_PERIPHID0) | 32 | R | See section | 20.3.1.14/ 406 |
| F000_0FE4 | Peripheral ID Register (MTB_PERIPHID1) | 32 | R | See section | 20.3.1.14/ 406 |
| F000_0FE8 | Peripheral ID Register (MTB_PERIPHID2) | 32 | R | See section | 20.3.1.14/ 406 |
| F000_0FEC | Peripheral ID Register (MTB_PERIPHID3) | 32 | R | See section | 20.3.1.14/ 406 |

Table continues on the next page...

MTB memory map (continued)

| Absolute address (hex) | Register name | Width (in bits) | Access | Reset value | Section/page |
|------------------------|-------------------------------------|-----------------|--------|-------------|-------------------|
| F000_0FF0 | Component ID Register (MTB_COMPID0) | 32 | R | See section | 20.3.1.15/ 407 |
| F000_0FF4 | Component ID Register (MTB_COMPID1) | 32 | R | See section | 20.3.1.15/ 407 |
| F000_0FF8 | Component ID Register (MTB_COMPID2) | 32 | R | See section | 20.3.1.15/ 407 |
| F000_0FFC | Component ID Register (MTB_COMPID3) | 32 | R | See section | 20.3.1.15/ 407 |

20.3.1.1 MTB Position Register (MTB_POSITION)

The MTB_POSITION register contains the Trace Write Address Pointer and Wrap fields. This register can be modified by the explicit programming model writes. It is also automatically updated by the MTB hardware when trace packets are being recorded.

The base address of the system RAM in the memory map dictates special consideration for the placement of the MTB. Consider the following guidelines:

For the standard configuration where the size of the MTB is $\leq 25\%$ of the total RAM capacity, it is recommended the MTB be based at the address defined by the MTB_BASE register. The read-only MTB_BASE register is defined by the expression $(0x2000_0000 - (\text{RAM_Size}/4))$. For this configuration, the MTB_POSITION register is initialized to $\text{MTB_BASE} \& 0x0000_7FF8$.

If the size of the MTB is more than 25% but less than or equal to 50% of the total RAM capacity, it is recommended the MTB be based at address 0x2000_0000. In this configuration, the MTB_POSITION register is initialized to $(0x2000_0000 \& 0x0000_7FF8) = 0x0000_0000$.

Following these two suggested placements provides a full-featured circular memory buffer containing program trace packets.

In the unlikely event an even larger trace buffer is required, a write-once capacity of 75% of the total RAM capacity can be based at address 0x2000_0000. The MTB_POSITION register is initialized to $(0x2000_0000 \& 0x0000_7FF8) = 0x0000_0000$. However, this configuration cannot support operation as a circular queue and instead requires the use of the MTB_FLOW[WATERMARK] capability to automatically disable tracing or halting the processor as the number of packet writes approach the buffer capacity. See the MTB_FLOW register description for more details.

Address: F000_0000h base + 0h offset = F000_0000h

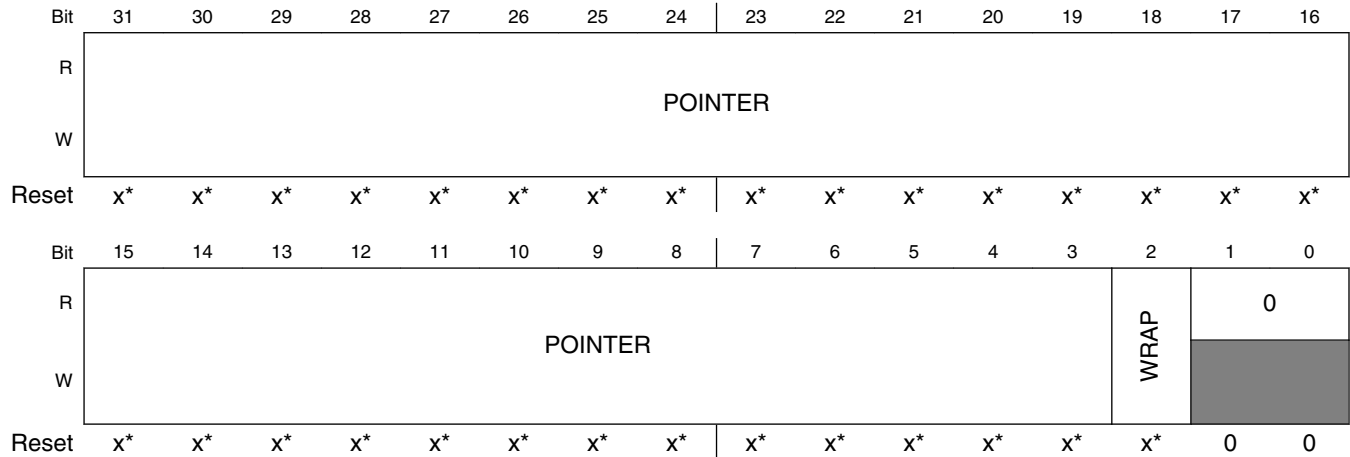

- * Notes:
- x = Undefined at reset.

MTB_POSITION field descriptions

| Field | Description |
|-----------------|---|
| 31–3 POINTER | <p>Trace Packet Address Pointer[28:0]</p> <p>Because a packet consists of two words, the POINTER field is the address of the first word of a packet. This field contains bits[31:3] of the RAM address where the next trace packet is written. Therefore, it points to an unused location and is automatically incremented.</p> <p>A debug agent can calculate the system memory map address for the current location in the MTB using the following "generic" equation:</p> <p>Given $mtb_size = 1 \ll (MTB_MASTER[MASK] + 4)$,</p> <p>$systemAddress = MTB_BASE + (((MTB_POSITION \& 0xFFFF_FFF8) + (mtb_size - (MTB_BASE \& (mtb_size-1)))) \& 0x0000_7FF8)$;</p> <p>For this device, a simpler expression also applies. See the following pseudo-code:</p> <p>if $((MTB_POSITION \gg 13) == 0x3)$ $systemAddress = (0x1FFF \ll 16) + (0x1 \ll 15) + (MTB_POSITION \& 0x7FF8)$; else $systemAddress = (0x2000 \ll 16) + (0x0 \ll 15) + (MTB_POSITION \& 0x7FF8)$;</p> <p>NOTE: The size of the RAM is parameterized and the most significant bits of the POINTER field are RAZ/WI.</p> <p>For these devices, $POSITION[31:15] == POSITION[POINTER[28:12]]$ are RAZ/WI. Therefore, the active bits in this field are $POSITION[14:3] == POSITION[POINTER[11:0]]$.</p> |
| 2 WRAP | <p>WRAP</p> <p>This field is set to 1 automatically when the POINTER value wraps as determined by the MTB_MASTER[MASK] field in the MASTER Trace Control Register. A debug agent might use the WRAP field to determine whether the trace information above and below the pointer address is valid.</p> |
| Reserved | <p>This field is reserved.</p> <p>This read-only field is reserved and always has the value 0.</p> |

20.3.1.2 MTB Master Register (MTB_MASTER)

The MTB_MASTER register contains the main program trace enable plus other trace controls. This register can be modified by the explicit programming model writes. MTB_MASTER[EN] and MTB_MASTER[HALTREQ] fields are also automatically updated by the MTB hardware.

Before MTB_MASTER[EN] or MTB_MASTER[TSTARTEN] are set to 1, the software must initialize the MTB_POSITION and MTB_FLOW registers.

If MTB_FLOW[WATERMARK] is used to stop tracing or to halt the processor, MTB_MASTER[MASK] must still be set to a value that prevents MTB_POSITION[POINTER] from wrapping before it reaches the MTB_FLOW[WATERMARK] value.

NOTE

The format of this mask field is different than MTBDWT_MASKn[MASK].

Address: F000_0000h base + 4h offset = F000_0004h

| | | | | | | | | | | | | | | | | |
|-------|----|----|----|----|----|----|----|---------|---------|----------|---------|----------|------|----|----|----|
| Bit | 31 | 30 | 29 | 28 | 27 | 26 | 25 | 24 | 23 | 22 | 21 | 20 | 19 | 18 | 17 | 16 |
| R | 0 | | | | | | | | | | | | | | | |
| W | EN | | | | | | | | | | | | | | | |
| Reset | 0 | 0 | 0 | 0 | 0 | 0 | 0 | 0 | 0 | 0 | 0 | 0 | 0 | 0 | 0 | 0 |
| Bit | 15 | 14 | 13 | 12 | 11 | 10 | 9 | 8 | 7 | 6 | 5 | 4 | 3 | 2 | 1 | 0 |
| R | 0 | | | | | | | HALTREQ | RAMPRIV | SFRWPRIV | TSTOPEN | TSTARTEN | MASK | | | |
| W | 0 | | | | | | | HALTREQ | RAMPRIV | SFRWPRIV | TSTOPEN | TSTARTEN | MASK | | | |
| Reset | 0 | 0 | 0 | 0 | 0 | 0 | 0 | 0 | 1 | 0 | 0 | x* | x* | x* | x* | x* |

- * Notes:
- x = Undefined at reset.

MTB_MASTER field descriptions

| Field | Description |
|----------|--|
| 31 EN | <p>Main Trace Enable</p> <p>When this field is 1, trace data is written into the RAM memory location addressed by MTB_POSITION[POINTER]. The MTB_POSITION[POINTER] value auto increments after the trace data packet is written.</p> <p>EN can be automatically set to 0 using the MTB_FLOW[WATERMARK] field and the MTB_FLOW[AUTOSTOP] bit.</p> |

Table continues on the next page...

MTB_MASTER field descriptions (continued)

| Field | Description |
|-------------------|---|
| | <p>EN is automatically set to 1 if TSTARTEN is 1 and the TSTART signal is HIGH.</p> <p>EN is automatically set to 0 if TSTOPEN is 1 and the TSTOP signal is HIGH.</p> <p>NOTE: If EN is set to 0 because MTB_FLOW[WATERMARK] is set, then it is not automatically set to 1 if TSTARTEN is 1 and the TSTART input is HIGH. In this case, tracing can only be restarted if MTB_FLOW[WATERMARK] or MTB_POSITION[POINTER] value is changed by software.</p> |
| 30–10 Reserved | <p>This field is reserved.</p> <p>This read-only field is reserved and always has the value 0.</p> |
| 9 HALTREQ | <p>Halt Request</p> <p>This field is connected to the halt request signal of the trace logic, EDBGREQ. When HALTREQ is set to 1, the EDBFGRQ is asserted if DBGEN (invasive debug enable, one of the debug authentication interface signals) is also HIGH. HALTREQ can be automatically set to 1 using MTB_FLOW[WATERMARK].</p> |
| 8 RAMPRIV | <p>RAM Privilege</p> <p>If this field is 0, then user or privileged AHB read and write accesses to the RAM are permitted. If this field is 1, then only privileged AHB read and write accesses to the RAM are permitted and user accesses are RAZ/WI. The HPROT[1] signal determines if an access is a user or privileged mode reference.</p> |
| 7 SFRWPRIV | <p>Special Function Register Write Privilege</p> <p>If this field is 0, then user or privileged AHB read and write accesses to the MTB_RAM Special Function Registers (programming model) are permitted. If this field is 1, then only privileged write accesses are permitted; user write accesses are ignored. The HPROT[1] signal determines if an access is user or privileged. Note MTB_RAM SFR read access are not controlled by this bit and are always permitted.</p> |
| 6 TSTOPEN | <p>Trace Stop Input Enable</p> <p>If this field is 1 and the TSTOP signal is HIGH, then EN is set to 0. If a trace packet is being written to memory, the write is completed before tracing is stopped.</p> |
| 5 TSTARTEN | <p>Trace Start Input Enable</p> <p>If this field is 1 and the TSTART signal is HIGH, then EN is set to 1. Tracing continues until a stop condition occurs.</p> |
| MASK | <p>Mask</p> <p>This value determines the maximum size of the trace buffer in RAM. It specifies the most-significant bit of the MTB_POSITION[POINTER] field that can be updated by automatic increment. If the trace tries to advance past this power of 2, the MTB_POSITION[WRAP] bit is set to 1, the MTB_POSITION[MASK+3:3] == MTB_POSITION[POINTER[MASK:0]] bits are set to 0, and the MTB_POSITION[14:MASK+3] == MTB_POSITION[POINTER[11:MASK+1]] bits remain unchanged.</p> <p>This field causes the trace packet information to be stored in a circular buffer of size $2^{[MASK+4]}$ bytes, that can be positioned in memory at multiples of this size. As detailed in the MTB_POSITION description, typical "upper limits" for the MTB size are RAM_Size/4 or RAM_Size/2. Values greater than the maximum have the same effect as the maximum.</p> |

20.3.1.3 MTB Flow Register (MTB_FLOW)

The MTB_FLOW register contains the watermark address and the autostop/autohalt control bits.

Memory map and register definition

If tracing is stopped using the watermark autostop feature, it cannot be restarted until software clears the watermark autostop. This can be achieved in one of the following ways:

- Changing the MTB_POSITION[POINTER] field value to point to the beginning of the trace buffer, or
- Setting MTB_FLOW[AUTOSTOP] = 0.

A debug agent can use MTB_FLOW[AUTOSTOP] to fill the trace buffer once only without halting the processor.

A debug agent can use MTB_FLOW[AUTOHALT] to fill the trace buffer once before causing the Cortex-M0+ processor to enter the Debug state. To enter Debug state, the Cortex-M0+ processor might have to perform additional branch type operations. Therefore, the MTB_FLOW[WATERMARK] field must be set below the final entry in the trace buffer region.

Address: F000_0000h base + 8h offset = F000_0008h

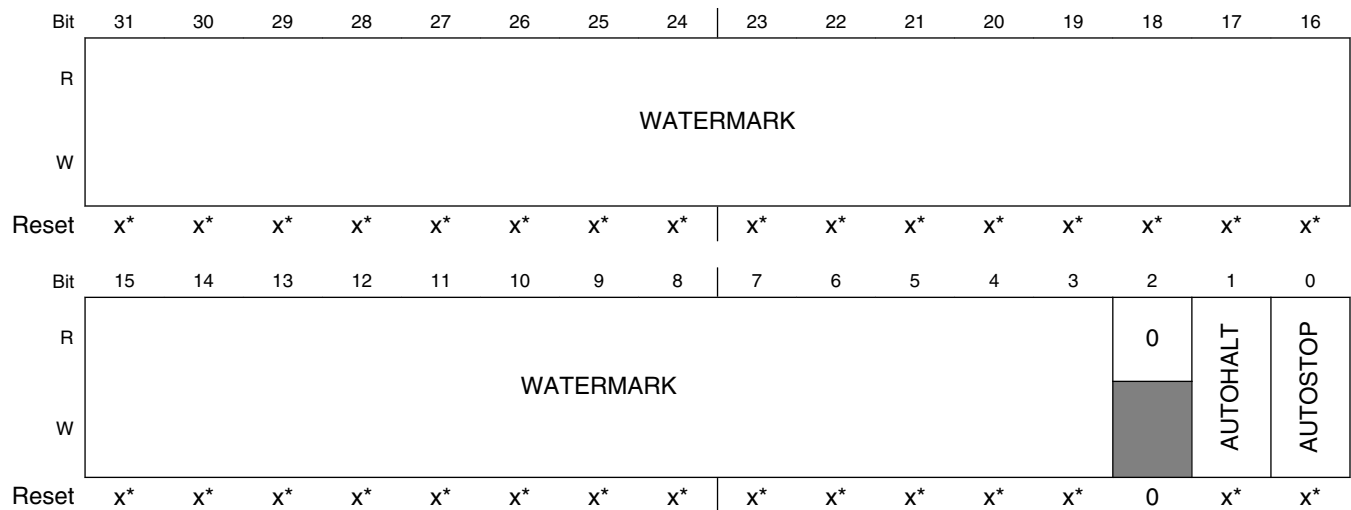

* Notes:

- x = Undefined at reset.

MTB_FLOW field descriptions

| Field | Description |
|-------------------|---|
| 31–3 WATERMARK | WATERMARK[28:0] This field contains an address in the same format as the MTB_POSITION[POINTER] field. When MTB_POSITION[POINTER] matches the WATERMARK field value, actions defined by the AUTOHALT and AUTOSTOP bits are performed. |
| 2 Reserved | This field is reserved. This read-only field is reserved and always has the value 0. |

Table continues on the next page...

MTB_FLOW field descriptions (continued)

| Field | Description |
|---------------|---|
| 1 AUTOHALT | AUTOHALT If this field is 1 and WATERMARK is equal to MTB_POSITION[POINTER], then MTB_MASTER[HALTREQ] is automatically set to 1. If the DBGEN signal is HIGH, the MTB asserts this halt request to the Cortex-M0+ processor by asserting the EDBGREQ signal. |
| 0 AUTOSTOP | AUTOSTOP If this field is 1 and WATERMARK is equal to MTB_POSITION[POINTER], then MTB_MASTER[EN] is automatically set to 0. This stops tracing. |

20.3.1.4 MTB Base Register (MTB_BASE)

The read-only MTB_BASE Register indicates where the RAM is located in the system memory map. This register is provided to enable auto discovery of the MTB RAM location, by a debug agent and is defined by a hardware design parameter. For this device, the base address is defined by the expression: $MTB_BASE[BASEADDR] = 0x2000_0000 - (RAM_Size/4)$

Address: F000_0000h base + Ch offset = F000_000Ch

| Bit | 31 | 30 | 29 | 28 | 27 | 26 | 25 | 24 | 23 | 22 | 21 | 20 | 19 | 18 | 17 | 16 | 15 | 14 | 13 | 12 | 11 | 10 | 9 | 8 | 7 | 6 | 5 | 4 | 3 | 2 | 1 | 0 |
|-------|----------|----|----|----|----|----|----|----|----|----|----|----|----|----|----|----|----|----|----|----|----|----|----|----|----|----|----|----|----|----|----|----|
| R | BASEADDR | | | | | | | | | | | | | | | | | | | | | | | | | | | | | | | |
| W | | | | | | | | | | | | | | | | | | | | | | | | | | | | | | | | |
| Reset | x* | x* | x* | x* | x* | x* | x* | x* | x* | x* | x* | x* | x* | x* | x* | x* | x* | x* | x* | x* | x* | x* | x* | x* | x* | x* | x* | x* | x* | x* | x* | x* |

* Notes:

- x = Undefined at reset.

MTB_BASE field descriptions

| Field | Description |
|----------|--|
| BASEADDR | BASEADDR This value is defined with a hardwired signal and the expression: $0x2000_0000 - (RAM_Size/4)$. For example, if the total RAM capacity is 16 KB, this field is 0x1FFF_F000. |

20.3.1.5 Integration Mode Control Register (MTB_MODECTRL)

This register enables the device to switch from a functional mode, or default behavior, into integration mode. It is hardwired to specific values used during the auto-discovery process by an external debug agent.

Address: F000_0000h base + F00h offset = F000_0F00h

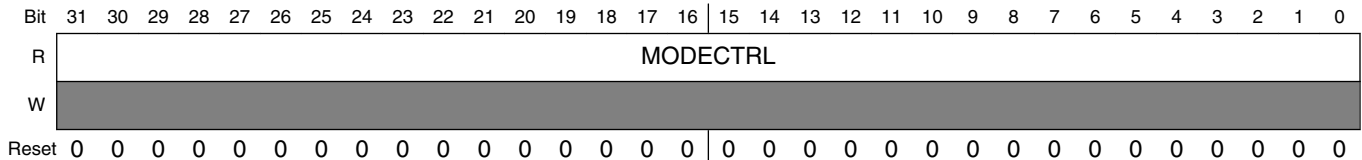

MTB_MODECTRL field descriptions

| Field | Description |
|----------|--------------------------------------|
| MODECTRL | MODECTRL Hardwired to 0x0000_0000 |

20.3.1.6 Claim TAG Set Register (MTB_TAGSET)

The Claim Tag Set Register returns the number of bits that can be set on a read, and enables individual bits to be set on a write. It is hardwired to specific values used during the auto-discovery process by an external debug agent.

Address: F000_0000h base + FA0h offset = F000_0FA0h

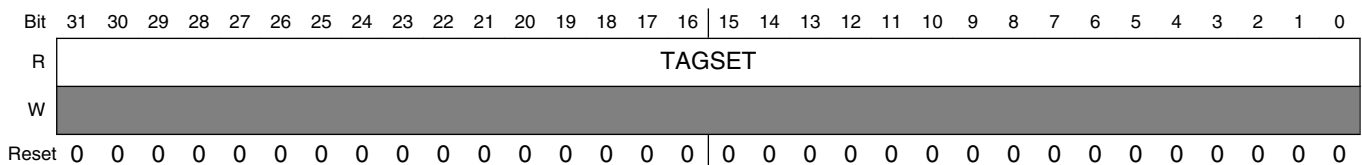

MTB_TAGSET field descriptions

| Field | Description |
|--------|------------------------------------|
| TAGSET | TAGSET Hardwired to 0x0000_0000 |

20.3.1.7 Claim TAG Clear Register (MTB_TAGCLEAR)

The read/write Claim Tag Clear Register is used to read the claim status on debug resources. A read indicates the claim tag status. Writing 1 to a specific bit clears the corresponding claim tag to 0. It is hardwired to specific values used during the auto-discovery process by an external debug agent.

Address: F000_0000h base + FA4h offset = F000_0FA4h

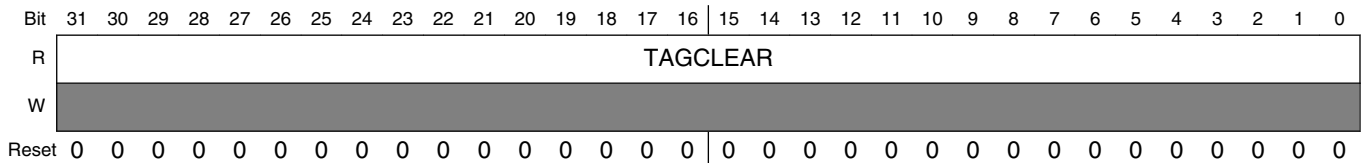

MTB_TAGCLEAR field descriptions

| Field | Description |
|----------|--------------------------------------|
| TAGCLEAR | TAGCLEAR Hardwired to 0x0000_0000 |

20.3.1.8 Lock Access Register (MTB_LOCKACCESS)

The Lock Access Register enables a write access to component registers. It is hardwired to specific values used during the auto-discovery process by an external debug agent.

Address: F000_0000h base + FB0h offset = F000_0FB0h

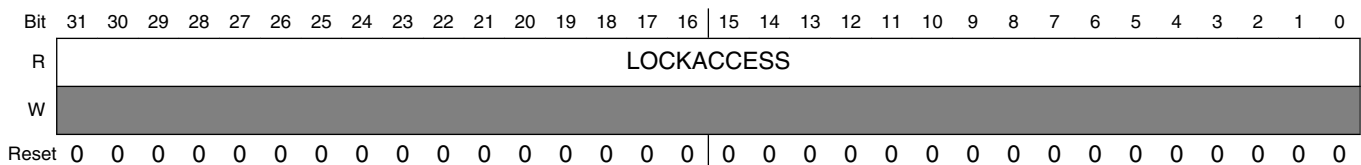

MTB_LOCKACCESS field descriptions

| Field | Description |
|------------|--------------------------|
| LOCKACCESS | Hardwired to 0x0000_0000 |

20.3.1.9 Lock Status Register (MTB_LOCKSTAT)

The Lock Status Register indicates the status of the lock control mechanism. This register is used in conjunction with the Lock Access Register. It is hardwired to specific values used during the auto-discovery process by an external debug agent.

Address: F000_0000h base + FB4h offset = F000_0FB4h

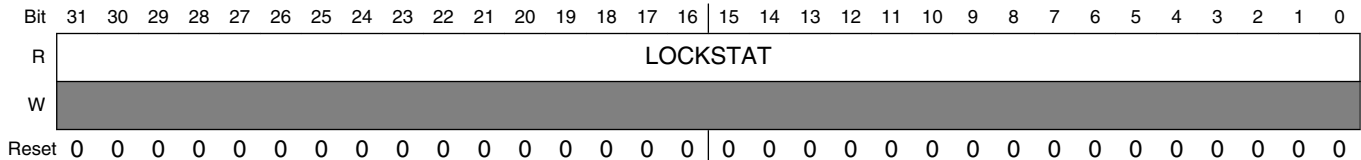

MTB_LOCKSTAT field descriptions

| Field | Description |
|----------|--------------------------------------|
| LOCKSTAT | LOCKSTAT Hardwired to 0x0000_0000 |

20.3.1.10 Authentication Status Register (MTB_AUTHSTAT)

The Authentication Status Register reports the required security level and current status of the security enable bit pairs. Where functionality changes on a given security level, this change must be reported in this register. It is connected to specific signals used during the auto-discovery process by an external debug agent.

MTB_AUTHSTAT[3:2] indicates if nonsecure, noninvasive debug is enabled or disabled, while MTB_AUTHSTAT[1:0] indicates the enabled/disabled state of nonsecure, invasive debug. For both 2-bit fields, 0b10 indicates the functionality is disabled and 0b11 indicates it is enabled.

Address: F000_0000h base + FB8h offset = F000_0FB8h

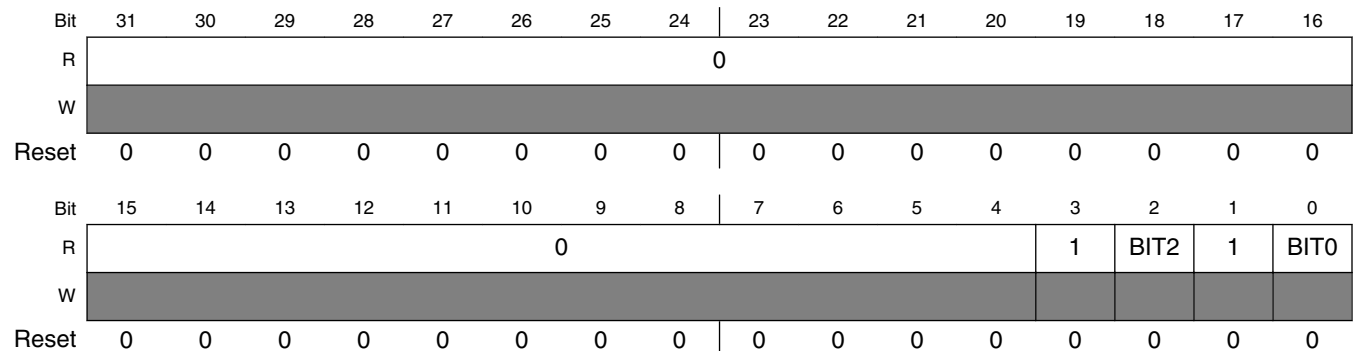

MTB_AUTHSTAT field descriptions

| Field | Description |
|------------------|---|
| 31–4 Reserved | This field is reserved. This read-only field is reserved and always has the value 0. |
| 3 Reserved | BIT3 This read-only field is reserved and always has the value 1. |
| 2 BIT2 | BIT2 Connected to NIDEN or DBGGEN signal. |
| 1 Reserved | BIT1 This read-only field is reserved and always has the value 1. |
| 0 BIT0 | Connected to DBGGEN. |

20.3.1.11 Device Architecture Register (MTB_DEVICEARCH)

This register indicates the device architecture. It is hardwired to specific values used during the auto-discovery process by an external debug agent.

Address: F000_0000h base + FBCh offset = F000_0FBCh

| | | | | | | | | | | | | | | | | | | | | | | | | | | | | | | | | |
|-------|------------|----|----|----|----|----|----|----|----|----|----|----|----|----|----|----|----|----|----|----|----|----|---|---|---|---|---|---|---|---|---|---|
| Bit | 31 | 30 | 29 | 28 | 27 | 26 | 25 | 24 | 23 | 22 | 21 | 20 | 19 | 18 | 17 | 16 | 15 | 14 | 13 | 12 | 11 | 10 | 9 | 8 | 7 | 6 | 5 | 4 | 3 | 2 | 1 | 0 |
| R | DEVICEARCH | | | | | | | | | | | | | | | | | | | | | | | | | | | | | | | |
| W | | | | | | | | | | | | | | | | | | | | | | | | | | | | | | | | |
| Reset | 0 | 1 | 0 | 0 | 0 | 1 | 1 | 1 | 0 | 1 | 1 | 1 | 0 | 0 | 0 | 0 | 0 | 0 | 0 | 0 | 1 | 0 | 1 | 0 | 0 | 0 | 1 | 1 | 0 | 0 | 0 | 1 |

MTB_DEVICEARCH field descriptions

| Field | Description |
|------------|---|
| DEVICEARCH | DEVICEARCH Hardwired to 0x4770_0A31. |

20.3.1.12 Device Configuration Register (MTB_DEVICECFG)

This register indicates the device configuration. It is hardwired to specific values used during the auto-discovery process by an external debug agent.

Address: F000_0000h base + FC8h offset = F000_0FC8h

| | | | | | | | | | | | | | | | | | | | | | | | | | | | | | | | | |
|-------|-----------|----|----|----|----|----|----|----|----|----|----|----|----|----|----|----|----|----|----|----|----|----|---|---|---|---|---|---|---|---|---|---|
| Bit | 31 | 30 | 29 | 28 | 27 | 26 | 25 | 24 | 23 | 22 | 21 | 20 | 19 | 18 | 17 | 16 | 15 | 14 | 13 | 12 | 11 | 10 | 9 | 8 | 7 | 6 | 5 | 4 | 3 | 2 | 1 | 0 |
| R | DEVICECFG | | | | | | | | | | | | | | | | | | | | | | | | | | | | | | | |
| W | | | | | | | | | | | | | | | | | | | | | | | | | | | | | | | | |
| Reset | 0 | 0 | 0 | 0 | 0 | 0 | 0 | 0 | 0 | 0 | 0 | 0 | 0 | 0 | 0 | 0 | 0 | 0 | 0 | 0 | 0 | 0 | 0 | 0 | 0 | 0 | 0 | 0 | 0 | 0 | 0 | 0 |

MTB_DEVICECFG field descriptions

| Field | Description |
|-----------|--|
| DEVICECFG | DEVICECFG Hardwired to 0x0000_0000. |

20.3.1.13 Device Type Identifier Register (MTB_DEVICETYPID)

This register indicates the device type ID. It is hardwired to specific values used during the auto-discovery process by an external debug agent.

Address: F000_0000h base + FCCh offset = F000_0FCCh

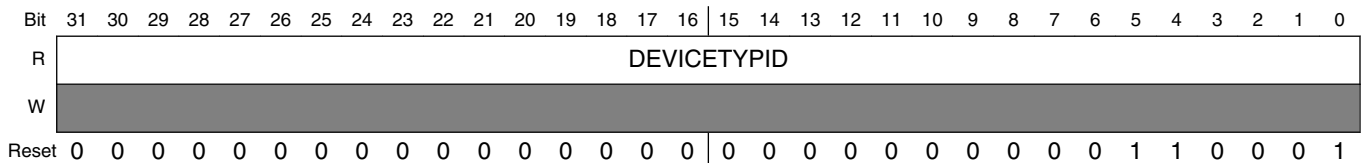

MTB_DEVICETYPID field descriptions

| Field | Description |
|-------------|--|
| DEVICETYPID | DEVICETYPID Hardwired to 0x0000_0031. |

20.3.1.14 Peripheral ID Register (MTB_PERIPHIDn)

These registers indicate the peripheral IDs. They are hardwired to specific values used during the auto-discovery process by an external debug agent.

Address: F000_0000h base + FD0h offset + (4d × i), where i=0d to 7d

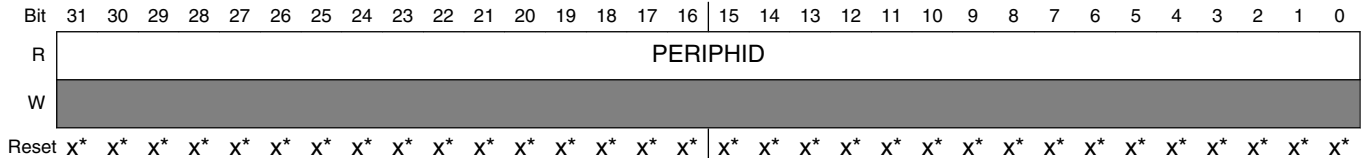

MTB_PERIPHIDn field descriptions

| Field | Description |
|----------|--|
| PERIPHID | PERIPHID Peripheral ID4 is hardwired to 0x0000_0004; ID0 to 0x0000_0032; ID1 to 0x0000_00B9; ID2 to 0x0000_000B; and all the others to 0x0000_0000. |

20.3.1.15 Component ID Register (MTB_COMPIDn)

These registers indicate the component IDs. They are hardwired to specific values used during the auto-discovery process by an external debug agent.

Address: F000_0000h base + FF0h offset + (4d × i), where i=0d to 3d

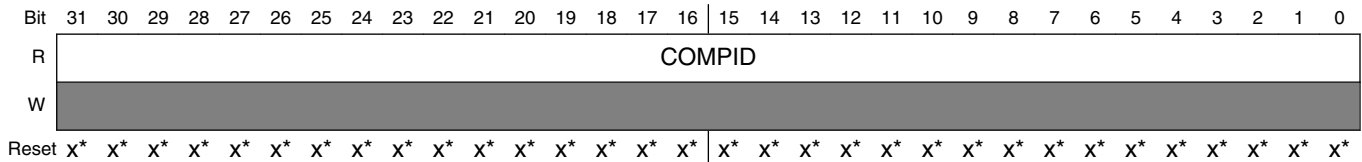

MTB_COMPIDn field descriptions

| Field | Description |
|--------|--|
| COMPID | Component ID Component ID0 is hardwired to 0x0000_000D; ID1 to 0x0000_0090; ID2 to 0x0000_0005; ID3 to 0x0000_00B1. |

20.3.2 MTB_DWT Memory Map

The MTB_DWT programming model supports a very simplified subset of the v7M debug architecture and follows the standard ARM DWT definition.

MTBDWT memory map

| Absolute address (hex) | Register name | Width (in bits) | Access | Reset value | Section/page |
|------------------------|---|-----------------|--------|-------------|------------------------------|
| F000_1000 | MTB DWT Control Register (MTBDWT_CTRL) | 32 | R | 2F00_0000h | 20.3.2.1/408 |
| F000_1020 | MTB_DWT Comparator Register (MTBDWT_COMP0) | 32 | R/W | 0000_0000h | 20.3.2.2/409 |
| F000_1024 | MTB_DWT Comparator Mask Register (MTBDWT_MASK0) | 32 | R/W | 0000_0000h | 20.3.2.3/410 |
| F000_1028 | MTB_DWT Comparator Function Register 0 (MTBDWT_FCT0) | 32 | R/W | 0000_0000h | 20.3.2.4/411 |
| F000_1030 | MTB_DWT Comparator Register (MTBDWT_COMP1) | 32 | R/W | 0000_0000h | 20.3.2.2/409 |
| F000_1034 | MTB_DWT Comparator Mask Register (MTBDWT_MASK1) | 32 | R/W | 0000_0000h | 20.3.2.3/410 |
| F000_1038 | MTB_DWT Comparator Function Register 1 (MTBDWT_FCT1) | 32 | R/W | 0000_0000h | 20.3.2.5/413 |
| F000_1200 | MTB_DWT Trace Buffer Control Register (MTBDWT_TBCTRL) | 32 | R/W | 2000_0000h | 20.3.2.6/414 |

Table continues on the next page...

MTBDWT memory map (continued)

| Absolute address (hex) | Register name | Width (in bits) | Access | Reset value | Section/page |
|------------------------|--|-----------------|--------|-------------|-------------------|
| F000_1FC8 | Device Configuration Register (MTBDWT_DEVICECFG) | 32 | R | 0000_0000h | 20.3.2.7/ 416 |
| F000_1FCC | Device Type Identifier Register (MTBDWT_DEVICETYPID) | 32 | R | 0000_0004h | 20.3.2.8/ 416 |
| F000_1FD0 | Peripheral ID Register (MTBDWT_PERIPHID4) | 32 | R | See section | 20.3.2.9/ 417 |
| F000_1FD4 | Peripheral ID Register (MTBDWT_PERIPHID5) | 32 | R | See section | 20.3.2.9/ 417 |
| F000_1FD8 | Peripheral ID Register (MTBDWT_PERIPHID6) | 32 | R | See section | 20.3.2.9/ 417 |
| F000_1FDC | Peripheral ID Register (MTBDWT_PERIPHID7) | 32 | R | See section | 20.3.2.9/ 417 |
| F000_1FE0 | Peripheral ID Register (MTBDWT_PERIPHID0) | 32 | R | See section | 20.3.2.9/ 417 |
| F000_1FE4 | Peripheral ID Register (MTBDWT_PERIPHID1) | 32 | R | See section | 20.3.2.9/ 417 |
| F000_1FE8 | Peripheral ID Register (MTBDWT_PERIPHID2) | 32 | R | See section | 20.3.2.9/ 417 |
| F000_1FEC | Peripheral ID Register (MTBDWT_PERIPHID3) | 32 | R | See section | 20.3.2.9/ 417 |
| F000_1FF0 | Component ID Register (MTBDWT_COMPID0) | 32 | R | See section | 20.3.2.10/ 417 |
| F000_1FF4 | Component ID Register (MTBDWT_COMPID1) | 32 | R | See section | 20.3.2.10/ 417 |
| F000_1FF8 | Component ID Register (MTBDWT_COMPID2) | 32 | R | See section | 20.3.2.10/ 417 |
| F000_1FFC | Component ID Register (MTBDWT_COMPID3) | 32 | R | See section | 20.3.2.10/ 417 |

20.3.2.1 MTB DWT Control Register (MTBDWT_CTRL)

The MTBDWT_CTRL register provides read-only information on the watchpoint configuration for the MTB_DWT.

Address: F000_1000h base + 0h offset = F000_1000h

| | | | | | | | | | | | | | | | | | | | | | | | | | | | | | | | | |
|-------|--------|----|----|----|---------|----|----|----|----|----|----|----|----|----|----|----|----|----|----|----|----|----|---|---|---|---|---|---|---|---|---|---|
| Bit | 31 | 30 | 29 | 28 | 27 | 26 | 25 | 24 | 23 | 22 | 21 | 20 | 19 | 18 | 17 | 16 | 15 | 14 | 13 | 12 | 11 | 10 | 9 | 8 | 7 | 6 | 5 | 4 | 3 | 2 | 1 | 0 |
| R | NUMCMP | | | | DWTCTRL | | | | | | | | | | | | | | | | | | | | | | | | | | | |
| W | 0 | | | | | | | | | | | | | | | | | | | | | | | | | | | | | | | |
| Reset | 0 | 0 | 1 | 0 | 1 | 1 | 1 | 1 | 0 | 0 | 0 | 0 | 0 | 0 | 0 | 0 | 0 | 0 | 0 | 0 | 0 | 0 | 0 | 0 | 0 | 0 | 0 | 0 | 0 | 0 | 0 | 0 |

MTBDWT_CTRL field descriptions

| Field | Description |
|-----------------|---|
| 31–28 NUMCMP | Number of comparators The MTB_DWT implements two comparators. |
| DWTCFGCTRL | DWT configuration controls This field is hardwired to 0xF00_0000, disabling all the remaining DWT functionality. The specific fields and their state are: MTBDWT_CTRL[27] = NOTRCPKT = 1, trace sample and exception trace is not supported MTBDWT_CTRL[26] = NOEXTTRIG = 1, external match signals are not supported MTBDWT_CTRL[25] = NOCYCCNT = 1, cycle counter is not supported MTBDWT_CTRL[24] = NOPRFCNT = 1, profiling counters are not supported MTBDWT_CTRL[22] = CYCEBTENA = 0, no POSTCNT underflow packets generated MTBDWT_CTRL[21] = FOLDEVTENA = 0, no folded instruction counter overflow events MTBDWT_CTRL[20] = LSUEVTENA = 0, no LSU counter overflow events MTBDWT_CTRL[19] = SLEEPEVTENA = 0, no sleep counter overflow events MTBDWT_CTRL[18] = EXCEVTENA = 0, no exception overhead counter events MTBDWT_CTRL[17] = CPIEVTENA = 0, no CPI counter overflow events MTBDWT_CTRL[16] = EXCTRCENA = 0, generation of exception trace disabled MTBDWT_CTRL[12] = PCSAMPLENA = 0, no periodic PC sample packets generated MTBDWT_CTRL[11:10] = SYNCTAP = 0, no synchronization packets MTBDWT_CTRL[9] = CYCTAP = 0, cycle counter is not supported MTBDWT_CTRL[8:5] = POSTINIT = 0, cycle counter is not supported MTBDWT_CTRL[4:1] = POSTPRESET = 0, cycle counter is not supported MTBDWT_CTRL[0] = CYCCNTENA = 0, cycle counter is not supported |

20.3.2.2 MTB_DWT Comparator Register (MTBDWT_COMPn)

The MTBDWT_COMPn registers provide the reference value for comparator n.

Address: F000_1000h base + 20h offset + (16d × i), where i=0d to 1d

| | | | | | | | | | | | | | | | | | | | | | | | | | | | | | | | | | | |
|-------|----|----|----|----|----|----|----|----|----|----|----|----|----|----|----|----|----|----|----|----|----|----|---|---|---|---|---|---|---|---|---|---|---|---|
| Bit | 31 | 30 | 29 | 28 | 27 | 26 | 25 | 24 | 23 | 22 | 21 | 20 | 19 | 18 | 17 | 16 | 15 | 14 | 13 | 12 | 11 | 10 | 9 | 8 | 7 | 6 | 5 | 4 | 3 | 2 | 1 | 0 | | |
| R | | | | | | | | | | | | | | | | | | | | | | | | | | | | | | | | | | |
| W | | | | | | | | | | | | | | | | | | | | | | | | | | | | | | | | | | |
| Reset | 0 | 0 | 0 | 0 | 0 | 0 | 0 | 0 | 0 | 0 | 0 | 0 | 0 | 0 | 0 | 0 | 0 | 0 | 0 | 0 | 0 | 0 | 0 | 0 | 0 | 0 | 0 | 0 | 0 | 0 | 0 | 0 | 0 | 0 |

MTBDWT_COMPn field descriptions

| Field | Description |
|-------|--|
| COMP | Reference value for comparison If MTBDWT_COMP0 is used for a data value comparator and the access size is byte or halfword, the data value must be replicated across all appropriate byte lanes of this register. For example, if the data is a |

MTBDWT_COMPn field descriptions (continued)

| Field | Description |
|-------|---|
| | byte-sized "x" value, then COMP[31:24] = COMP[23:16] = COMP[15:8] = COMP[7:0] = "x". Likewise, if the data is a halfword-size "y" value, then COMP[31:16] = COMP[15:0] = "y". |

20.3.2.3 MTB_DWT Comparator Mask Register (MTBDWT_MASKn)

The MTBDWT_MASKn registers define the size of the ignore mask applied to the reference address for address range matching by comparator n. Note the format of this mask field is different than the MTB_MASTER[MASK].

Address: F000_1000h base + 24h offset + (16d × i), where i=0d to 1d

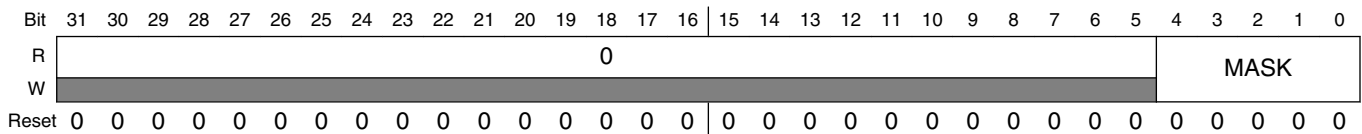

MTBDWT_MASKn field descriptions

| Field | Description |
|------------------|---|
| 31–5 Reserved | This field is reserved. This read-only field is reserved and always has the value 0. |
| MASK | <p>MASK</p> <p>The value of the ignore mask, 0-31 bits, is applied to address range matching. MASK = 0 is used to include all bits of the address in the comparison, except if MASK = 0 and the comparator is configured to watch instruction fetch addresses, address bit [0] is ignored by the hardware since all fetches must be at least halfword aligned. For MASK != 0 and regardless of watch type, address bits [x-1:0] are ignored in the address comparison.</p> <p>Using a mask means the comparator matches on a range of addresses, defined by the unmasked most significant bits of the address, bits [31:x]. The maximum MASK value is 24, producing a 16 Mbyte mask. An attempted write of a MASK value > 24 is limited by the MTBDWT hardware to 24.</p> <p>If MTBDWT_COMP0 is used as a data value comparator, then MTBDWT_MASK0 should be programmed to zero.</p> |

20.3.2.4 MTB_DWT Comparator Function Register 0 (MTBDWT_FCT0)

The MTBDWT_FCTn registers control the operation of comparator n.

Address: F000_1000h base + 28h offset = F000_1028h

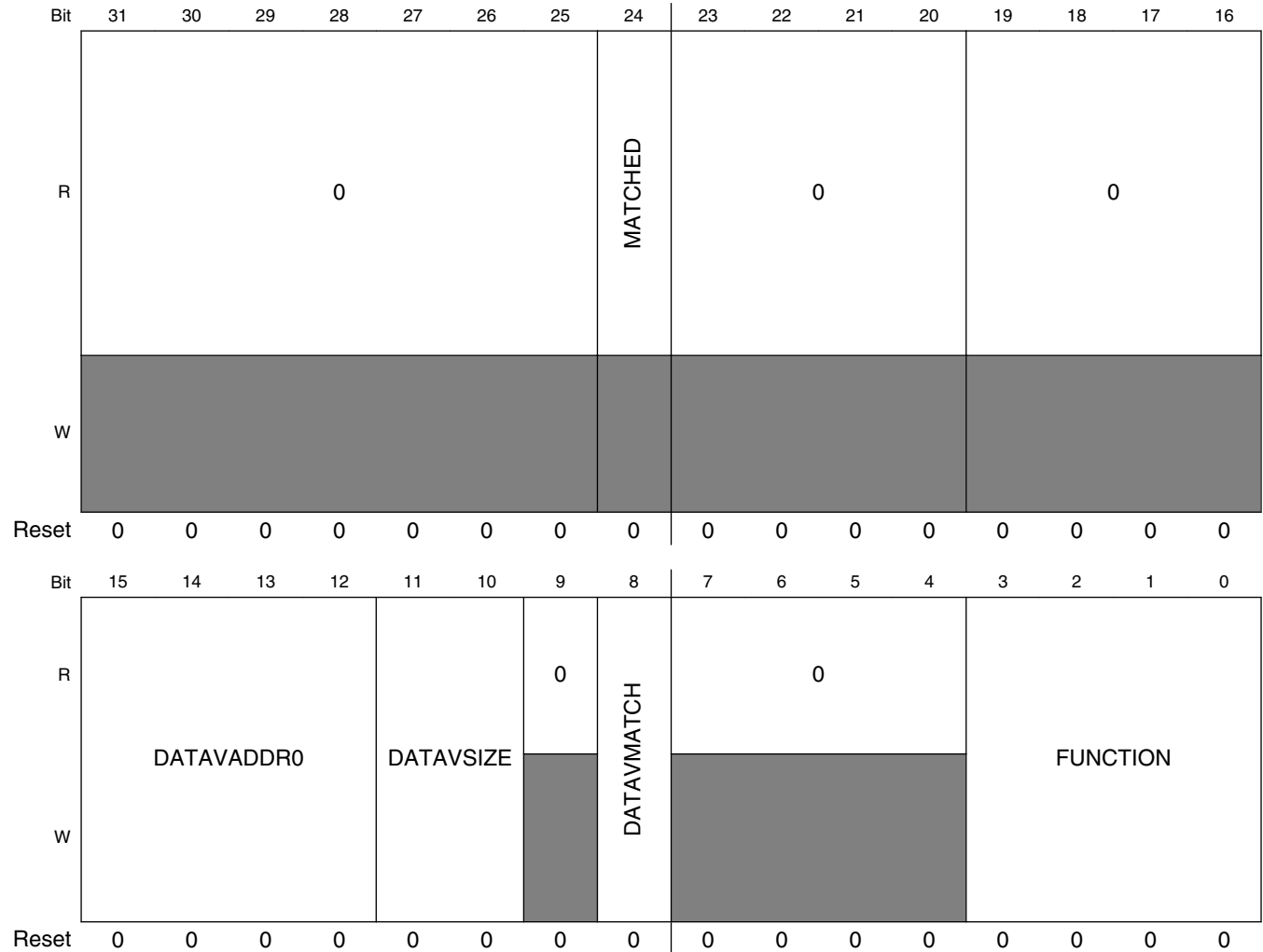

MTBDWT_FCT0 field descriptions

| Field | Description |
|-------------------|--|
| 31–25 Reserved | This field is reserved. This read-only field is reserved and always has the value 0. |
| 24 MATCHED | Comparator match If this read-only flag is asserted, it indicates the operation defined by the FUNCTION field occurred since the last read of the register. Reading the register clears this bit. 0 No match. 1 Match occurred. |

Table continues on the next page...

MTBDWT_FCT0 field descriptions (continued)

| Field | Description |
|---------------------|--|
| 23–20 Reserved | This field is reserved. This read-only field is reserved and always has the value 0. |
| 19–16 Reserved | This field is reserved. This read-only field is reserved and always has the value 0. |
| 15–12 DATAVADDR0 | Data Value Address 0 Since the MTB_DWT implements two comparators, the DATAVADDR0 field is restricted to values {0,1}. When the DATAVMATCH bit is asserted, this field defines the comparator number to use for linked address comparison. If MTBDWT_COMP0 is used as a data watchpoint and MTBDWT_COMP1 as an address watchpoint, DATAVADDR0 must be set. |
| 11–10 DATAVSIZE | Data Value Size For data value matching, this field defines the size of the required data comparison. 00 Byte. 01 Halfword. 10 Word. 11 Reserved. Any attempts to use this value results in UNPREDICTABLE behavior. |
| 9 Reserved | This field is reserved. This read-only field is reserved and always has the value 0. |
| 8 DATAVMATCH | Data Value Match When this field is 1, it enables data value comparison. For this implementation, MTBDWT_COMP0 supports address or data value comparisons; MTBDWT_COMP1 only supports address comparisons. 0 Perform address comparison. 1 Perform data value comparison. |
| 7–4 Reserved | This field is reserved. This read-only field is reserved and always has the value 0. |
| FUNCTION | Function Selects the action taken on a comparator match. If MTBDWT_COMP0 is used for a data value and MTBDWT_COMP1 for an address value, then MTBDWT_FCT1[FUNCTION] must be set to zero. For this configuration, MTBDWT_MASK1 can be set to a non-zero value, so the combined comparators match on a range of addresses. 0000 Disabled. 0100 Instruction fetch. 0101 Data operand read. 0110 Data operand write. 0111 Data operand (read + write). others Reserved. Any attempts to use this value results in UNPREDICTABLE behavior. |

20.3.2.5 MTB_DWT Comparator Function Register 1 (MTBDWT_FCT1)

The MTBDWT_FCTn registers control the operation of comparator n. Since the MTB_DWT only supports data value comparisons on comparator 0, there are several fields in the MTBDWT_FCT1 register that are RAZ/WI (bits 12, 11:10, 8).

Address: F000_1000h base + 38h offset = F000_1038h

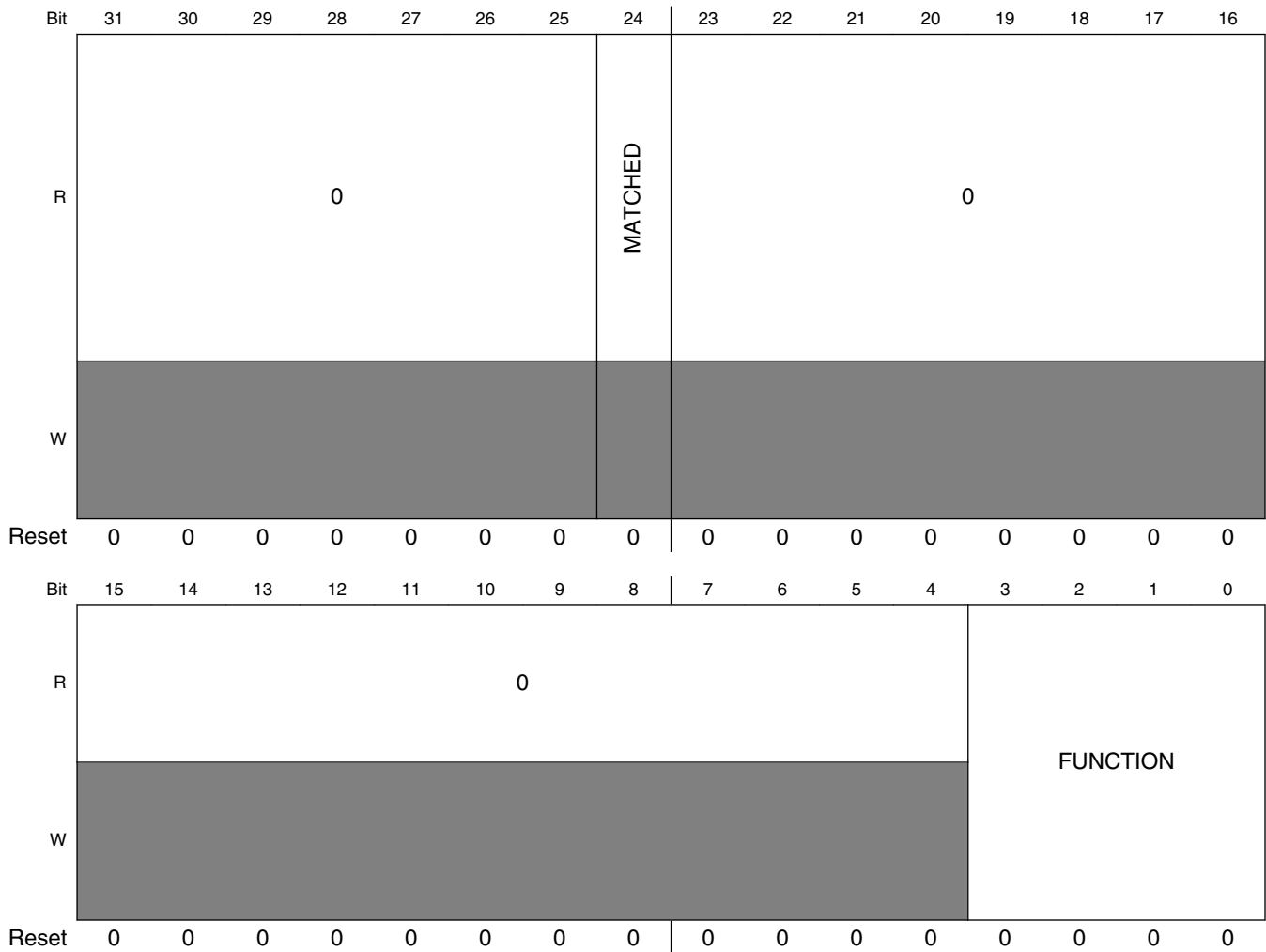

MTBDWT_FCT1 field descriptions

| Field | Description |
|-------------------|--|
| 31–25 Reserved | This field is reserved. This read-only field is reserved and always has the value 0. |
| 24 MATCHED | Comparator match If this read-only flag is asserted, it indicates the operation defined by the FUNCTION field occurred since the last read of the register. Reading the register clears this bit. |

Table continues on the next page...

MTBDWT_FCT1 field descriptions (continued)

| Field | Description |
|------------------|--|
| | 0 No match. 1 Match occurred. |
| 23–4 Reserved | This field is reserved. This read-only field is reserved and always has the value 0. |
| FUNCTION | <p>Function</p> <p>Selects the action taken on a comparator match. If MTBDWT_COMP0 is used for a data value and MTBDWT_COMP1 for an address value, then MTBDWT_FCT1[FUNCTION] must be set to zero. For this configuration, MTBDWT_MASK1 can be set to a non-zero value, so the combined comparators match on a range of addresses.</p> <p>0000 Disabled. 0100 Instruction fetch. 0101 Data operand read. 0110 Data operand write. 0111 Data operand (read + write). others Reserved. Any attempts to use this value results in UNPREDICTABLE behavior.</p> |

20.3.2.6 MTB_DWT Trace Buffer Control Register (MTBDWT_TBCTRL)

The MTBDWT_TBCTRL register defines how the watchpoint comparisons control the actual trace buffer operation.

Recall the MTB supports starting and stopping the program trace based on the watchpoint comparisons signaled via TSTART and TSTOP. The watchpoint comparison signals are enabled in the MTB's control logic by setting the appropriate enable bits, MTB_MASTER[TSTARTEN, TSTOPEN]. In the event of simultaneous assertion of both TSTART and TSTOP, TSTART takes priority.

Address: F000_1000h base + 200h offset = F000_1200h

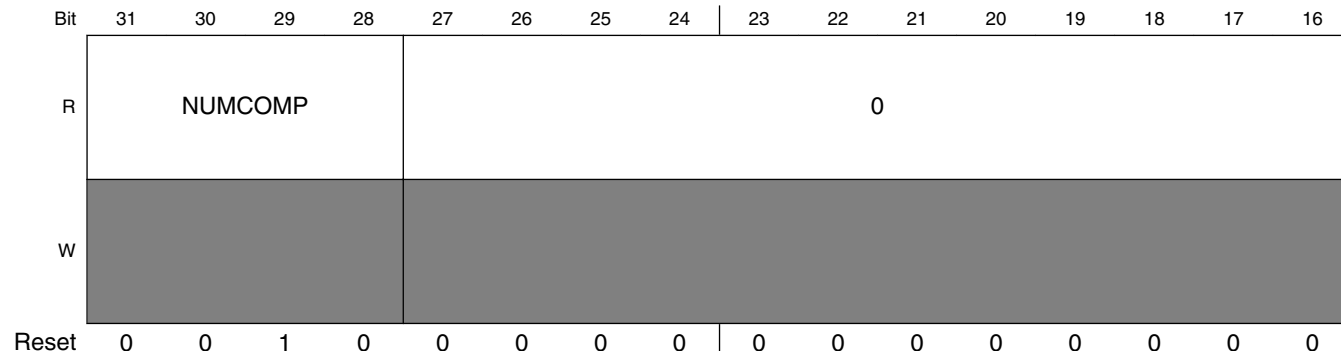

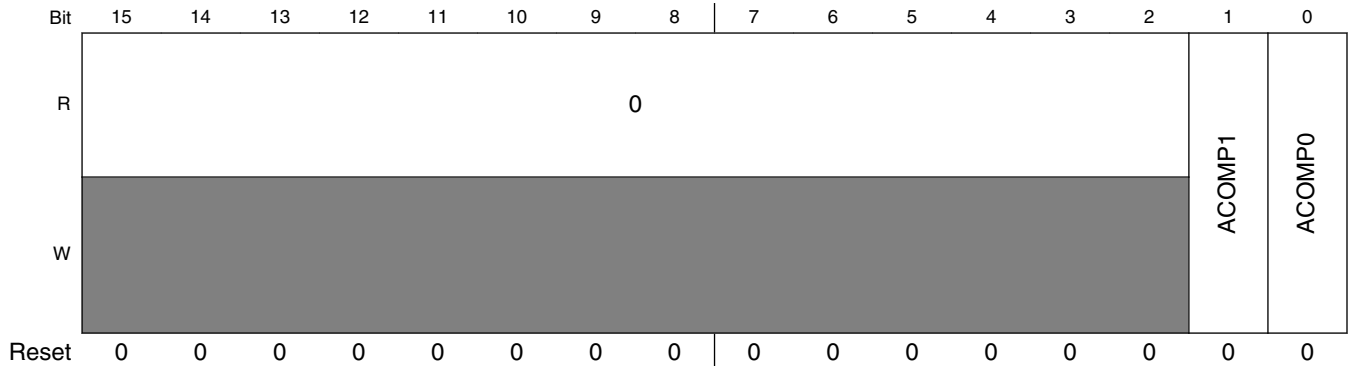

MTBDWT_TBCTRL field descriptions

| Field | Description |
|------------------|---|
| 31–28 NUMCOMP | <p>Number of Comparators</p> <p>This read-only field specifies the number of comparators in the MTB_DWT. This implementation includes two registers.</p> |
| 27–2 Reserved | <p>This field is reserved.</p> <p>This read-only field is reserved and always has the value 0.</p> |
| 1 ACOMP1 | <p>Action based on Comparator 1 match</p> <p>When the MTBDWT_FCT1[MATCHED] is set, it indicates MTBDWT_COMP1 address compare has triggered and the trace buffer's recording state is changed.</p> <p>0 Trigger TSTOP based on the assertion of MTBDWT_FCT1[MATCHED]. 1 Trigger TSTART based on the assertion of MTBDWT_FCT1[MATCHED].</p> |
| 0 ACOMP0 | <p>Action based on Comparator 0 match</p> <p>When the MTBDWT_FCT0[MATCHED] is set, it indicates MTBDWT_COMP0 address compare has triggered and the trace buffer's recording state is changed. The assertion of MTBDWT_FCT0[MATCHED] is caused by the following conditions:</p> <ul style="list-style-type: none"> Address match in MTBDWT_COMP0 when MTBDWT_FCT0[DATAVMATCH] = 0 Data match in MTBDWT_COMP0 when MTBDWT_FCT0[DATAVMATCH, DATAVADDR0] = {1,0} Data match in MTBDWT_COMP0 and address match in MTBDWT_COMP1 when MTBDWT_FCT0[DATAVMATCH, DATAVADDR0] = {1,1} <p>0 Trigger TSTOP based on the assertion of MTBDWT_FCT0[MATCHED]. 1 Trigger TSTART based on the assertion of MTBDWT_FCT0[MATCHED].</p> |

20.3.2.7 Device Configuration Register (MTBDWT_DEVICECFG)

This register indicates the device configuration. It is hardwired to specific values used during the auto-discovery process by an external debug agent.

Address: F000_1000h base + FC8h offset = F000_1FC8h

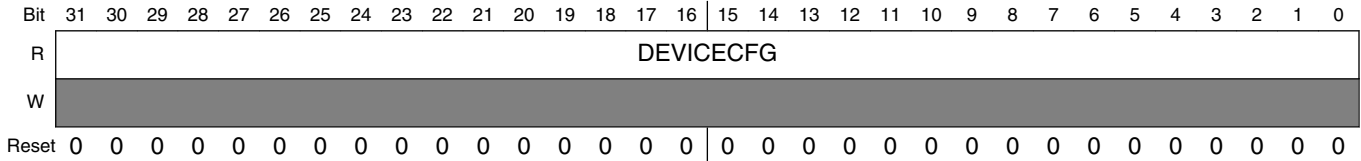

MTBDWT_DEVICECFG field descriptions

| Field | Description |
|-----------|--|
| DEVICECFG | DEVICECFG Hardwired to 0x0000_0000. |

20.3.2.8 Device Type Identifier Register (MTBDWT_DEVICETYPID)

This register indicates the device type ID. It is hardwired to specific values used during the auto-discovery process by an external debug agent.

Address: F000_1000h base + FCCh offset = F000_1FCCh

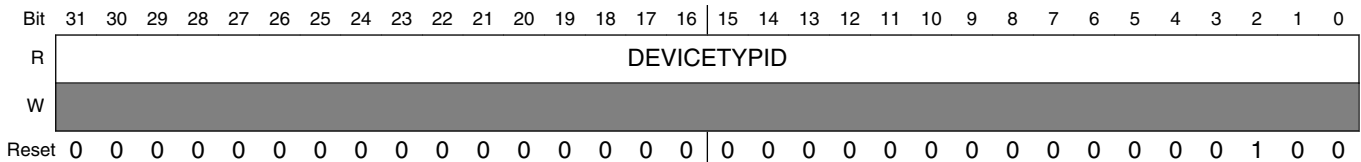

MTBDWT_DEVICETYPID field descriptions

| Field | Description |
|-------------|--|
| DEVICETYPID | DEVICETYPID Hardwired to 0x0000_0004. |

20.3.2.9 Peripheral ID Register (MTBDWT_PERIPHID_n)

These registers indicate the peripheral IDs. They are hardwired to specific values used during the auto-discovery process by an external debug agent.

Address: F000_1000h base + FD0h offset + (4d × i), where i=0d to 7d

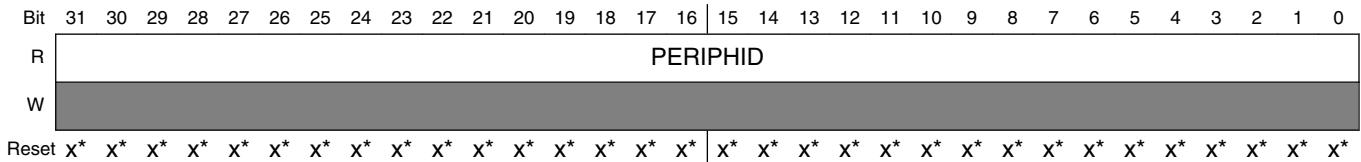

MTBDWT_PERIPHID_n field descriptions

| Field | Description |
|----------|--|
| PERIPHID | PERIPHID Peripheral ID1 is hardwired to 0x0000_00E0; ID2 to 0x0000_0008; and all the others to 0x0000_0000. |

20.3.2.10 Component ID Register (MTBDWT_COMPID_n)

These registers indicate the component IDs. They are hardwired to specific values used during the auto-discovery process by an external debug agent.

Address: F000_1000h base + FF0h offset + (4d × i), where i=0d to 3d

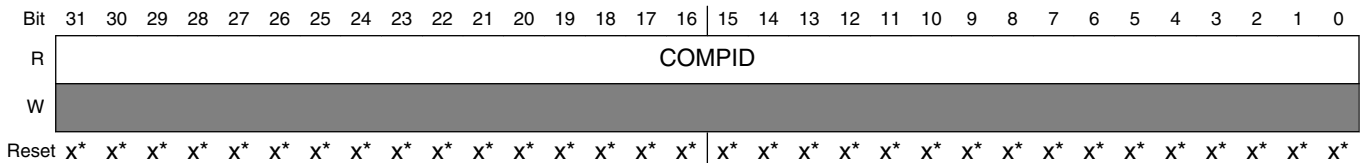

MTBDWT_COMPID_n field descriptions

| Field | Description |
|--------|--|
| COMPID | Component ID Component ID0 is hardwired to 0x0000_000D; ID1 to 0x0000_0090; ID2 to 0x0000_0005; ID3 to 0x0000_00B1. |

20.3.3 System ROM Memory Map

The System ROM Table registers are also mapped into a sparsely-populated 4 KB address space.

For core configurations like that supported by Cortex-M0+, ARM recommends that a debugger identifies and connects to the debug components using the CoreSight debug infrastructure.

ARM recommends that a debugger follows the flow as shown in the following figure to discover the components in the CoreSight debug infrastructure. In this case, a debugger reads the peripheral and component ID registers for each CoreSight component in the CoreSight system.

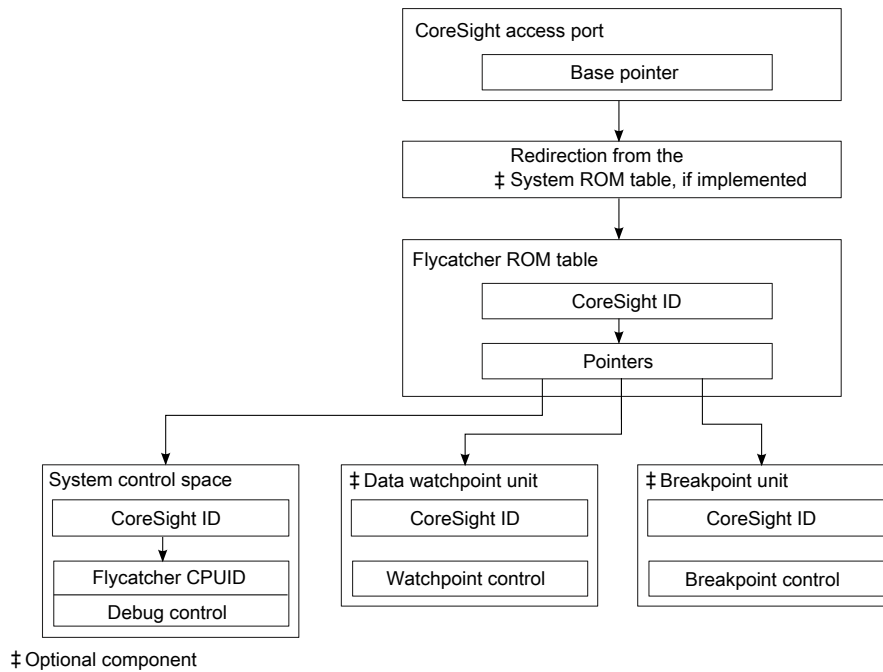

Figure 20-3. CoreSight discovery process

ROM memory map

| Absolute address (hex) | Register name | Width (in bits) | Access | Reset value | Section/page |
|------------------------|--|-----------------|--------|-------------|------------------|
| F000_2000 | Entry (ROM_ENTRY0) | 32 | R | See section | 20.3.3.1/ 419 |
| F000_2004 | Entry (ROM_ENTRY1) | 32 | R | See section | 20.3.3.1/ 419 |
| F000_2008 | Entry (ROM_ENTRY2) | 32 | R | See section | 20.3.3.1/ 419 |
| F000_200C | End of Table Marker Register (ROM_TABLEMARK) | 32 | R | 0000_0000h | 20.3.3.2/ 420 |
| F000_2FCC | System Access Register (ROM_SYSACCESS) | 32 | R | 0000_0001h | 20.3.3.3/ 420 |
| F000_2FD0 | Peripheral ID Register (ROM_PERIPHID4) | 32 | R | See section | 20.3.3.4/ 421 |

Table continues on the next page...

ROM memory map (continued)

| Absolute address (hex) | Register name | Width (in bits) | Access | Reset value | Section/page |
|------------------------|--|-----------------|--------|-------------|------------------|
| F000_2FD4 | Peripheral ID Register (ROM_PERIPHID5) | 32 | R | See section | 20.3.3.4/ 421 |
| F000_2FD8 | Peripheral ID Register (ROM_PERIPHID6) | 32 | R | See section | 20.3.3.4/ 421 |
| F000_2FDC | Peripheral ID Register (ROM_PERIPHID7) | 32 | R | See section | 20.3.3.4/ 421 |
| F000_2FE0 | Peripheral ID Register (ROM_PERIPHID0) | 32 | R | See section | 20.3.3.4/ 421 |
| F000_2FE4 | Peripheral ID Register (ROM_PERIPHID1) | 32 | R | See section | 20.3.3.4/ 421 |
| F000_2FE8 | Peripheral ID Register (ROM_PERIPHID2) | 32 | R | See section | 20.3.3.4/ 421 |
| F000_2FEC | Peripheral ID Register (ROM_PERIPHID3) | 32 | R | See section | 20.3.3.4/ 421 |
| F000_2FF0 | Component ID Register (ROM_COMPID0) | 32 | R | See section | 20.3.3.5/ 421 |
| F000_2FF4 | Component ID Register (ROM_COMPID1) | 32 | R | See section | 20.3.3.5/ 421 |
| F000_2FF8 | Component ID Register (ROM_COMPID2) | 32 | R | See section | 20.3.3.5/ 421 |
| F000_2FFC | Component ID Register (ROM_COMPID3) | 32 | R | See section | 20.3.3.5/ 421 |

20.3.3.1 Entry (ROM_ENTRY n)

The System ROM Table begins with "n" relative 32-bit addresses, one for each debug component present in the device and terminating with an all-zero value signaling the end of the table at the "n+1"-th value.

It is hardwired to specific values used during the auto-discovery process by an external debug agent.

Address: F000_2000h base + 0h offset + (4d × i), where i=0d to 2d

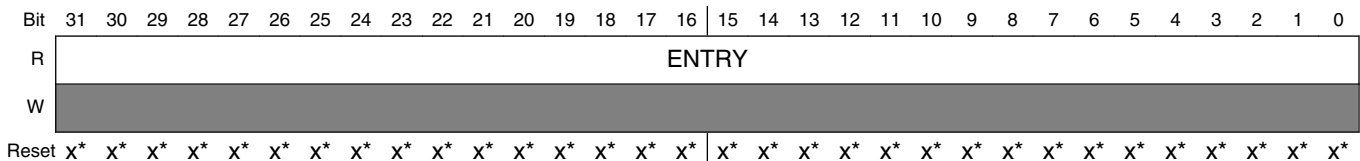

ROM_ENTRY n field descriptions

| Field | Description |
|-------|-------------|
| ENTRY | ENTRY |

ROM_ENTRYn field descriptions (continued)

| Field | Description |
|-------|--|
| | Entry 0 (MTB) is hardwired to 0xFFFF_E003; Entry 1 (MTBDWT) to 0xFFFF_F003; Entry 2 (CM0+ ROM Table) to 0xF00F_D003. |

20.3.3.2 End of Table Marker Register (ROM_TABLEMARK)

This register indicates end of table marker. It is hardwired to specific values used during the auto-discovery process by an external debug agent.

Address: F000_2000h base + Ch offset = F000_200Ch

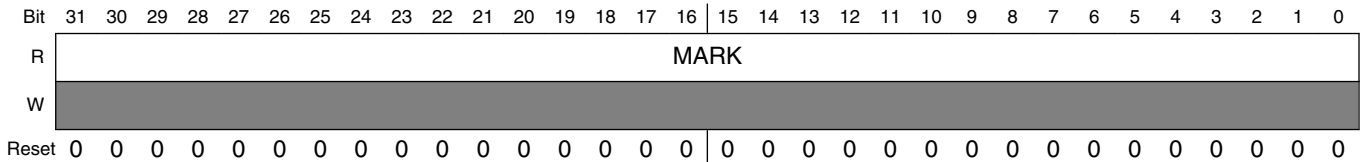

ROM_TABLEMARK field descriptions

| Field | Description |
|-------|----------------------------------|
| MARK | MARK Hardwired to 0x0000_0000 |

20.3.3.3 System Access Register (ROM_SYSACCESS)

This register indicates system access. It is hardwired to specific values used during the auto-discovery process by an external debug agent.

Address: F000_2000h base + FCCh offset = F000_2FCCh

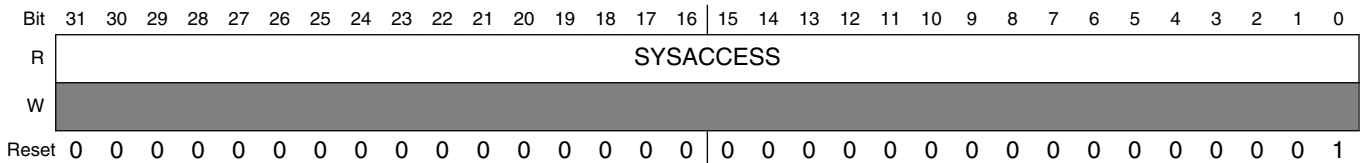

ROM_SYSACCESS field descriptions

| Field | Description |
|-----------|---------------------------------------|
| SYSACCESS | SYSACCESS Hardwired to 0x0000_0001 |

20.3.3.4 Peripheral ID Register (ROM_PERIPHID_n)

These registers indicate the peripheral IDs. They are hardwired to specific values used during the auto-discovery process by an external debug agent.

Address: F000_2000h base + FD0h offset + (4d × i), where i=0d to 7d

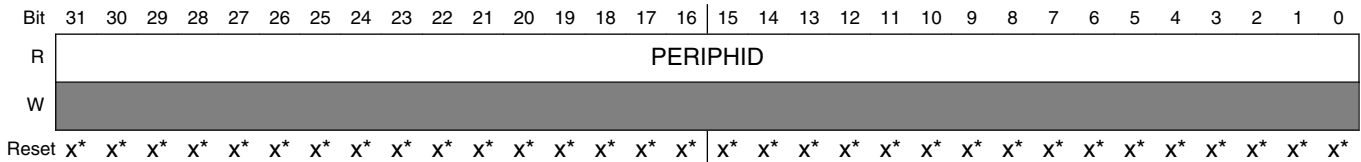

ROM_PERIPHID_n field descriptions

| Field | Description |
|----------|--|
| PERIPHID | PERIPHID Peripheral ID1 is hardwired to 0x0000_00E0; ID2 to 0x0000_0008; and all the others to 0x0000_0000. |

20.3.3.5 Component ID Register (ROM_COMPID_n)

These registers indicate the component IDs. They are hardwired to specific values used during the auto-discovery process by an external debug agent.

Address: F000_2000h base + FF0h offset + (4d × i), where i=0d to 3d

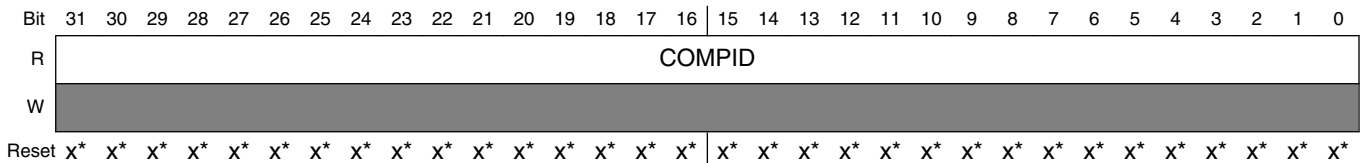

ROM_COMPID_n field descriptions

| Field | Description |
|--------|--|
| COMPID | Component ID Component ID0 is hardwired to 0x0000_000D; ID1 to 0x0000_0010; ID2 to 0x0000_0005; ID3 to 0x0000_00B1. |

Chapter 21

Crossbar Switch Lite (AXBS-Lite)

This chapter provides information on the layout, configuration, and programming of the crossbar switch. The crossbar switch connects bus masters and bus slaves using a crossbar switch structure.

21.1 Introduction

The information found here provides information on the layout, configuration, and programming of the crossbar switch.

The crossbar switch connects bus masters and bus slaves using a crossbar switch structure. This structure allows up to four bus masters to access different bus slaves simultaneously, while providing arbitration among the bus masters when they access the same slave.

21.1.1 Features

The crossbar switch includes these features:

- Symmetric crossbar bus switch implementation
 - Allows concurrent accesses from different masters to different slaves
- Up to single-clock 32-bit transfer
- Programmable configuration for fixed-priority or round-robin slave port arbitration (see the chip-specific information).

21.2 Memory Map / Register Definition

This crossbar switch is designed for minimal gate count. It, therefore, has no memory-mapped configuration registers.

Please see the chip-specific information for information on whether the arbitration method in the crossbar switch is programmable, and by which module.

21.3 Functional Description

21.3.1 General operation

When a master accesses the crossbar switch, the access is immediately taken. If the targeted slave port of the access is available, then the access is immediately presented on the slave port. Single-clock or zero-wait-state accesses are possible through the crossbar. If the targeted slave port of the access is busy or parked on a different master port, the requesting master simply sees wait states inserted until the targeted slave port can service the master's request. The latency in servicing the request depends on each master's priority level and the responding slave's access time.

Because the crossbar switch appears to be just another slave to the master device, the master device has no knowledge of whether it actually owns the slave port it is targeting. While the master does not have control of the slave port it is targeting, it simply waits.

After the master has control of the slave port it is targeting, the master remains in control of the slave port until it relinquishes the slave port by running an IDLE cycle or by targeting a different slave port for its next access.

The master can also lose control of the slave port if another higher-priority master makes a request to the slave port.

The crossbar terminates all master IDLE transfers, as opposed to allowing the termination to come from one of the slave buses. Additionally, when no master is requesting access to a slave port, the crossbar drives IDLE transfers onto the slave bus, even though a default master may be granted access to the slave port.

When a slave bus is being idled by the crossbar, it remains parked with the last master to use the slave port. This is done to save the initial clock of arbitration delay that otherwise would be seen if the same master had to arbitrate to gain control of the slave port.

21.3.2 Arbitration

The crossbar switch supports two arbitration algorithms:

- Fixed priority
- Round-robin

The selection of the global slave port arbitration algorithm is described in the crossbar switch chip-specific information.

21.3.2.1 Arbitration during undefined length bursts

All lengths of burst accesses lock out arbitration until the last beat of the burst.

21.3.2.2 Fixed-priority operation

When operating in fixed-priority mode, each master is assigned a unique priority level with the highest numbered master having the highest priority (for example, in a system with 5 masters, master 1 has lower priority than master 3). If two masters request access to the same slave port, the master with the highest priority gains control over the slave port.

NOTE

In this arbitration mode, a higher-priority master can monopolize a slave port, preventing accesses from any lower-priority master to the port.

When a master makes a request to a slave port, the slave port checks whether the new requesting master's priority level is higher than that of the master that currently has control over the slave port, unless the slave port is in a parked state. The slave port performs an arbitration check at every clock edge to ensure that the proper master, if any, has control of the slave port.

The following table describes possible scenarios based on the requesting master port:

Table 21-1. How the Crossbar Switch grants control of a slave port to a master

| When | Then the Crossbar Switch grants control to the requesting master |
|--|--|
| Both of the following are true: <ul style="list-style-type: none"> • The current master is not running a transfer. • The new requesting master's priority level is higher than that of the current master. | At the next clock edge |

Table continues on the next page...

Table 21-1. How the Crossbar Switch grants control of a slave port to a master (continued)

| When | Then the Crossbar Switch grants control to the requesting master |
|--|---|
| The requesting master's priority level is lower than the current master. | At the conclusion of one of the following cycles: <ul style="list-style-type: none"> • An IDLE cycle • A non-IDLE cycle to a location other than the current slave port |

21.3.2.3 Round-robin priority operation

When operating in round-robin mode, each master is assigned a relative priority based on the master port number. This relative priority is compared to the master port number (ID) of the last master to perform a transfer on the slave bus. The highest priority requesting master becomes owner of the slave bus at the next transfer boundary. Priority is based on how far ahead the ID of the requesting master is to the ID of the last master.

After granted access to a slave port, a master may perform as many transfers as desired to that port until another master makes a request to the same slave port. The next master in line is granted access to the slave port at the next transfer boundary, or possibly on the next clock cycle if the current master has no pending access request.

As an example of arbitration in round-robin mode, assume the crossbar is implemented with master ports 0, 1, 4, and 5. If the last master of the slave port was master 1, and master 0, 4, and 5 make simultaneous requests, they are serviced in the order: 4 then 5 then 0.

The round-robin arbitration mode generally provides a more fair allocation of the available slave-port bandwidth (compared to fixed priority) as the fixed master priority does not affect the master selection.

21.4 Initialization/application information

No initialization is required for the crossbar switch. See the chip-specific crossbar switch information for the reset state of the arbitration scheme.

Chapter 22

Peripheral Bridge (AIPS-Lite)

The Peripheral Bridge (AIPS-Lite) converts the crossbar switch interface to an interface to access a majority of peripherals on the device. The peripheral bridge supports up to 128 peripherals, including separate clock enable inputs for each of the slots to accommodate slower peripherals.

22.1 Introduction

The peripheral bridge converts the crossbar switch interface to an interface that can access most of the slave peripherals on this chip.

The peripheral bridge occupies 64 MB of the address space, which is divided into peripheral slots of 4 KB. (It might be possible that all the peripheral slots are not used. See the memory map chapter for details on slot assignments.) The bridge includes separate clock enable inputs for each of the slots to accommodate slower peripherals.

22.1.1 Features

Key features of the peripheral bridge are:

- Supports peripheral slots with 8-, 16-, and 32-bit datapath width

22.1.2 General operation

The slave devices connected to the peripheral bridge are modules which contain a programming model of control and status registers. The system masters read and write these registers through the peripheral bridge.

The register maps of the peripherals are located on 4-KB boundaries. Each peripheral is allocated one or more 4-KB block(s) of the memory map.

22.2 Memory map/register definition

The AIPS module(s) on this device do(es) not contain any user-programmable registers.

AIPS memory map

| Absolute address (hex) | Register name | Width (in bits) | Access | Reset value | Section/page |
|------------------------|---|-----------------|--------|-------------|--------------|
| 0 | Master Privilege Register A (AIPS_MPRA) | 32 | R/W | See section | 22.2.1/428 |
| 20 | Peripheral Access Control Register (AIPS_PACRA) | 32 | R/W | See section | 22.2.2/431 |
| 24 | Peripheral Access Control Register (AIPS_PACRB) | 32 | R/W | See section | 22.2.2/431 |
| 28 | Peripheral Access Control Register (AIPS_PACRC) | 32 | R/W | See section | 22.2.2/431 |
| 2C | Peripheral Access Control Register (AIPS_PACRD) | 32 | R/W | See section | 22.2.2/431 |
| 40 | Peripheral Access Control Register (AIPS_PACRE) | 32 | R/W | See section | 22.2.3/436 |
| 44 | Peripheral Access Control Register (AIPS_PACRF) | 32 | R/W | See section | 22.2.3/436 |
| 48 | Peripheral Access Control Register (AIPS_PACRG) | 32 | R/W | See section | 22.2.3/436 |
| 4C | Peripheral Access Control Register (AIPS_PACRH) | 32 | R/W | See section | 22.2.3/436 |
| 50 | Peripheral Access Control Register (AIPS_PACRI) | 32 | R/W | See section | 22.2.3/436 |
| 54 | Peripheral Access Control Register (AIPS_PACRJ) | 32 | R/W | See section | 22.2.3/436 |
| 58 | Peripheral Access Control Register (AIPS_PACRK) | 32 | R/W | See section | 22.2.3/436 |
| 5C | Peripheral Access Control Register (AIPS_PACRL) | 32 | R/W | See section | 22.2.3/436 |
| 60 | Peripheral Access Control Register (AIPS_PACRM) | 32 | R/W | See section | 22.2.3/436 |
| 64 | Peripheral Access Control Register (AIPS_PACRN) | 32 | R/W | See section | 22.2.3/436 |
| 68 | Peripheral Access Control Register (AIPS_PACRO) | 32 | R/W | See section | 22.2.3/436 |
| 6C | Peripheral Access Control Register (AIPS_PACRP) | 32 | R/W | See section | 22.2.3/436 |

22.2.1 Master Privilege Register A (AIPS_MPRA)

The MPRA specifies identical 4-bit fields defining the access-privilege level associated with a bus master to various peripherals on the chip. The register provides one field per bus master.

NOTE

At reset, the default value loaded into the MPRA fields is chip-specific. See the chip configuration details for the value of a particular device.

A register field that maps to an unimplemented master or peripheral behaves as read-only-zero.

Each master is assigned a logical ID from 0 to 15. See the master logical ID assignment table in the chip-specific AIPS information.

Address: 0h base + 0h offset = 0h

| | | | | | | | | | | | | | | | | |
|-------|----|------|------|------|----|----|------|------|------|----|------|------|------|----|----|----|
| Bit | 31 | 30 | 29 | 28 | 27 | 26 | 25 | 24 | 23 | 22 | 21 | 20 | 19 | 18 | 17 | 16 |
| R | 0 | | | | 0 | 0 | | | | 0 | | | | | | |
| W | | MTR0 | MTW0 | MPL0 | | | MTR2 | MTW2 | MPL2 | | MTR3 | MTW3 | MPL3 | | | |
| Reset | 0* | 0* | 0* | 0* | 0* | 0* | 0* | 0* | 0* | 0* | 0* | 0* | 0* | 0* | 0* | 0* |
| Bit | 15 | 14 | 13 | 12 | 11 | 10 | 9 | 8 | 7 | 6 | 5 | 4 | 3 | 2 | 1 | 0 |
| R | 0 | 0 | 0 | 0 | | | | | | | | | | | | |
| W | | | | | | | | | | | | | | | | |
| Reset | 0* | 0* | 0* | 0* | 0* | 0* | 0* | 0* | 0* | 0* | 0* | 0* | 0* | 0* | 0* | 0* |

* Notes:

- The reset value is chip-dependent and can be found in the chip-specific AIPS information.

AIPS_MPRA field descriptions

| Field | Description |
|----------------|--|
| 31 Reserved | This field is reserved. This read-only field is reserved and always has the value 0. |
| 30 MTR0 | Master 0 Trusted For Read Determines whether the master is trusted for read accesses. 0 This master is not trusted for read accesses. 1 This master is trusted for read accesses. |
| 29 MTW0 | Master 0 Trusted For Writes Determines whether the master is trusted for write accesses. 0 This master is not trusted for write accesses. 1 This master is trusted for write accesses. |
| 28 MPL0 | Master 0 Privilege Level Specifies how the privilege level of the master is determined. 0 Accesses from this master are forced to user-mode. 1 Accesses from this master are not forced to user-mode. |
| 27 Reserved | This field is reserved. This read-only field is reserved and always has the value 0. |
| 23 Reserved | This field is reserved. This read-only field is reserved and always has the value 0. |
| 22 MTR2 | Master 2 Trusted For Read Determines whether the master is trusted for read accesses. |

Table continues on the next page...

AIPS_MPRA field descriptions (continued)

| Field | Description |
|----------------|--|
| | 0 This master is not trusted for read accesses. 1 This master is trusted for read accesses. |
| 21 MTW2 | Master 2 Trusted For Writes Determines whether the master is trusted for write accesses. 0 This master is not trusted for write accesses. 1 This master is trusted for write accesses. |
| 20 MPL2 | Master 2 Privilege Level Specifies how the privilege level of the master is determined. 0 Accesses from this master are forced to user-mode. 1 Accesses from this master are not forced to user-mode. |
| 19 Reserved | This field is reserved. This read-only field is reserved and always has the value 0. |
| 18 MTR3 | Master 3 Trusted For Read Determines whether the master is trusted for read accesses. 0 This master is not trusted for read accesses. 1 This master is trusted for read accesses. |
| 17 MTW3 | Master 3 Trusted For Writes Determines whether the master is trusted for write accesses. 0 This master is not trusted for write accesses. 1 This master is trusted for write accesses. |
| 16 MPL3 | Master 3 Privilege Level Specifies how the privilege level of the master is determined. 0 Accesses from this master are forced to user-mode. 1 Accesses from this master are not forced to user-mode. |
| 15 Reserved | This field is reserved. This read-only field is reserved and always has the value 0. |
| 11 Reserved | This field is reserved. This read-only field is reserved and always has the value 0. |
| 7 Reserved | This field is reserved. This read-only field is reserved and always has the value 0. |
| 3 Reserved | This field is reserved. This read-only field is reserved and always has the value 0. |

22.2.2 Peripheral Access Control Register (AIPS_PACR n)

Each PACR register consists of eight 4-bit PACR fields. Each PACR field defines the access levels for a particular peripheral. The mapping between a peripheral and its PACR field is shown in the table below. The peripheral assignment to each PACR is defined by the memory map slot that the peripheral is assigned to. See this chip's memory map for the assignment of a particular peripheral.

The following table shows the location of each peripheral slot's PACR field in the PACR registers.

| Offset | Register | [31:28] | [27:24] | [23:20] | [19:16] | [15:12] | [11:8] | [7:4] | [3:0] |
|--------|----------|---------|---------|---------|---------|---------|---------|---------|---------|
| 0x20 | PACRA | PACR0 | PACR1 | PACR2 | PACR3 | PACR4 | PACR5 | PACR6 | PACR7 |
| 0x24 | PACRB | PACR8 | PACR9 | PACR10 | PACR11 | PACR12 | PACR13 | PACR14 | PACR15 |
| 0x28 | PACRC | PACR16 | PACR17 | PACR18 | PACR19 | PACR20 | PACR21 | PACR22 | PACR23 |
| 0x2C | PACRD | PACR24 | PACR25 | PACR26 | PACR27 | PACR28 | PACR29 | PACR30 | PACR31 |
| 0x30 | Reserved | | | | | | | | |
| 0x34 | Reserved | | | | | | | | |
| 0x38 | Reserved | | | | | | | | |
| 0x3C | Reserved | | | | | | | | |
| 0x40 | PACRE | PACR32 | PACR33 | PACR34 | PACR35 | PACR36 | PACR37 | PACR38 | PACR39 |
| 0x44 | PACRF | PACR40 | PACR41 | PACR42 | PACR43 | PACR44 | PACR45 | PACR46 | PACR47 |
| 0x48 | PACRG | PACR48 | PACR49 | PACR50 | PACR51 | PACR52 | PACR53 | PACR54 | PACR55 |
| 0x4C | PACRH | PACR56 | PACR57 | PACR58 | PACR59 | PACR60 | PACR61 | PACR62 | PACR63 |
| 0x50 | PACRI | PACR64 | PACR65 | PACR66 | PACR67 | PACR68 | PACR69 | PACR70 | PACR71 |
| 0x54 | PACRJ | PACR72 | PACR73 | PACR74 | PACR75 | PACR76 | PACR77 | PACR78 | PACR79 |
| 0x58 | PACRK | PACR80 | PACR81 | PACR82 | PACR83 | PACR84 | PACR85 | PACR86 | PACR87 |
| 0x5C | PACRL | PACR88 | PACR89 | PACR90 | PACR91 | PACR92 | PACR93 | PACR94 | PACR95 |
| 0x60 | PACRM | PACR96 | PACR97 | PACR98 | PACR99 | PACR100 | PACR101 | PACR102 | PACR103 |
| 0x64 | PACRN | PACR104 | PACR105 | PACR106 | PACR107 | PACR108 | PACR109 | PACR110 | PACR111 |
| 0x68 | PACRO | PACR112 | PACR113 | PACR114 | PACR115 | PACR116 | PACR117 | PACR118 | PACR119 |
| 0x6C | PACRP | PACR120 | PACR121 | PACR122 | PACR123 | PACR124 | PACR125 | PACR126 | PACR127 |

NOTE

The register field descriptions for PACR A-D, which control peripheral slots 0-31, are shown below. The following section, [Peripheral Access Control Register \(AIPS_PACR \$n\$ \)](#), shows the register field descriptions for PACR E-P. All PACR registers are identical. They are divided into two sections because they occupy two non-contiguous address spaces.

Memory map/register definition

Address: 0h base + 20h offset + (4d × i), where i=0d to 3d

| | | | | | | | | | | | | | | | | |
|-------|----|-----|-----|-----|----|-----|-----|-----|----|-----|-----|-----|----|-----|-----|-----|
| Bit | 31 | 30 | 29 | 28 | 27 | 26 | 25 | 24 | 23 | 22 | 21 | 20 | 19 | 18 | 17 | 16 |
| R | 0 | SP0 | WP0 | TP0 | 0 | SP1 | WP1 | TP1 | 0 | SP2 | WP2 | TP2 | 0 | SP3 | WP3 | TP3 |
| W | | | | | | | | | | | | | | | | |
| Reset | 0* | 0* | 0* | 0* | 0* | 0* | 0* | 0* | 0* | 0* | 0* | 0* | 0* | 0* | 0* | 0* |

| | | | | | | | | | | | | | | | | |
|-------|----|-----|-----|-----|----|-----|-----|-----|----|-----|-----|-----|----|-----|-----|-----|
| Bit | 15 | 14 | 13 | 12 | 11 | 10 | 9 | 8 | 7 | 6 | 5 | 4 | 3 | 2 | 1 | 0 |
| R | 0 | SP4 | WP4 | TP4 | 0 | SP5 | WP5 | TP5 | 0 | SP6 | WP6 | TP6 | 0 | SP7 | WP7 | TP7 |
| W | | | | | | | | | | | | | | | | |
| Reset | 0* | 0* | 0* | 0* | 0* | 0* | 0* | 0* | 0* | 0* | 0* | 0* | 0* | 0* | 0* | 0* |

* Notes:

- The reset value is chip-dependent and can be found in the AIPS chip-specific information.

AIPS_PACR_n field descriptions

| Field | Description |
|----------------|--|
| 31 Reserved | This field is reserved. This read-only field is reserved and always has the value 0. |
| 30 SP0 | Supervisor Protect Determines whether the peripheral requires supervisor privilege level for accesses. When this field is set, the master privilege level must indicate the supervisor access attribute, and the MPRx[MPL _n] control field for the master must be set. If not, access terminates with an error response and no peripheral access initiates. 0 This peripheral does not require supervisor privilege level for accesses. 1 This peripheral requires supervisor privilege level for accesses. |
| 29 WP0 | Write Protect Determines whether the peripheral allows write access. When this bit is set and a write access is attempted, access terminates with an error response and no peripheral access initiates. 0 This peripheral allows write accesses. 1 This peripheral is write protected. |
| 28 TP0 | Trusted Protect Determines whether the peripheral allows accesses from an untrusted master. When this field is set and an access is attempted by an untrusted master, the access terminates with an error response and no peripheral access initiates. 0 Accesses from an untrusted master are allowed. 1 Accesses from an untrusted master are not allowed. |
| 27 Reserved | This field is reserved. This read-only field is reserved and always has the value 0. |
| 26 SP1 | Supervisor Protect Determines whether the peripheral requires supervisor privilege level for accesses. When this field is set, the master privilege level must indicate the supervisor access attribute, and the MPRx[MPL _n] control field for the master must be set. If not, access terminates with an error response and no peripheral access initiates. 0 This peripheral does not require supervisor privilege level for accesses. 1 This peripheral requires supervisor privilege level for accesses. |

Table continues on the next page...

AIPS_PACR_n field descriptions (continued)

| Field | Description |
|----------------|---|
| 25 WP1 | <p>Write Protect</p> <p>Determines whether the peripheral allows write accesses. When this field is set and a write access is attempted, access terminates with an error response and no peripheral access initiates.</p> <p>0 This peripheral allows write accesses. 1 This peripheral is write protected.</p> |
| 24 TP1 | <p>Trusted Protect</p> <p>Determines whether the peripheral allows accesses from an untrusted master. When this bit is set and an access is attempted by an untrusted master, the access terminates with an error response and no peripheral access initiates.</p> <p>0 Accesses from an untrusted master are allowed. 1 Accesses from an untrusted master are not allowed.</p> |
| 23 Reserved | <p>This field is reserved. This read-only field is reserved and always has the value 0.</p> |
| 22 SP2 | <p>Supervisor Protect</p> <p>Determines whether the peripheral requires supervisor privilege level for accesses. When this field is set, the master privilege level must indicate the supervisor access attribute, and the MPR_x[MPL_n] control field for the master must be set. If not, access terminates with an error response and no peripheral access initiates.</p> <p>0 This peripheral does not require supervisor privilege level for accesses. 1 This peripheral requires supervisor privilege level for accesses.</p> |
| 21 WP2 | <p>Write Protect</p> <p>Determines whether the peripheral allows write access. When this bit is set and a write access is attempted, access terminates with an error response and no peripheral access initiates.</p> <p>0 This peripheral allows write accesses. 1 This peripheral is write protected.</p> |
| 20 TP2 | <p>Trusted Protect</p> <p>Determines whether the peripheral allows accesses from an untrusted master. When this field is set and an access is attempted by an untrusted master, the access terminates with an error response and no peripheral access initiates.</p> <p>0 Accesses from an untrusted master are allowed. 1 Accesses from an untrusted master are not allowed.</p> |
| 19 Reserved | <p>This field is reserved. This read-only field is reserved and always has the value 0.</p> |
| 18 SP3 | <p>Supervisor Protect</p> <p>Determines whether the peripheral requires supervisor privilege level for access. When this bit is set, the master privilege level must indicate the supervisor access attribute, and the MPR_x[MPL_n] control bit for the master must be set. If not, access terminates with an error response and no peripheral access initiates.</p> <p>0 This peripheral does not require supervisor privilege level for accesses. 1 This peripheral requires supervisor privilege level for accesses.</p> |

Table continues on the next page...

AIPS_PACR_n field descriptions (continued)

| Field | Description |
|----------------|--|
| 17 WP3 | <p>Write Protect</p> <p>Determines whether the peripheral allows write accesses. When this field is set and a write access is attempted, access terminates with an error response and no peripheral access initiates.</p> <p>0 This peripheral allows write accesses. 1 This peripheral is write protected.</p> |
| 16 TP3 | <p>Trusted Protect</p> <p>Determines whether the peripheral allows accesses from an untrusted master. When this bit is set and an access is attempted by an untrusted master, the access terminates with an error response and no peripheral access initiates.</p> <p>0 Accesses from an untrusted master are allowed. 1 Accesses from an untrusted master are not allowed.</p> |
| 15 Reserved | <p>This field is reserved. This read-only field is reserved and always has the value 0.</p> |
| 14 SP4 | <p>Supervisor Protect</p> <p>Determines whether the peripheral requires supervisor privilege level for accesses. When this field is set, the master privilege level must indicate the supervisor access attribute, and the MPRx[MPL_n] control field for the master must be set. If not, access terminates with an error response and no peripheral access initiates.</p> <p>0 This peripheral does not require supervisor privilege level for accesses. 1 This peripheral requires supervisor privilege level for accesses.</p> |
| 13 WP4 | <p>Write Protect</p> <p>Determines whether the peripheral allows write access. When this bit is set and a write access is attempted, access terminates with an error response and no peripheral access initiates.</p> <p>0 This peripheral allows write accesses. 1 This peripheral is write protected.</p> |
| 12 TP4 | <p>Trusted Protect</p> <p>Determines whether the peripheral allows accesses from an untrusted master. When this field is set and an access is attempted by an untrusted master, the access terminates with an error response and no peripheral access initiates.</p> <p>0 Accesses from an untrusted master are allowed. 1 Accesses from an untrusted master are not allowed.</p> |
| 11 Reserved | <p>This field is reserved. This read-only field is reserved and always has the value 0.</p> |
| 10 SP5 | <p>Supervisor Protect</p> <p>Determines whether the peripheral requires supervisor privilege level for accesses. When this field is set, the master privilege level must indicate the supervisor access attribute, and the MPRx[MPL_n] control field for the master must be set. If not, access terminates with an error response and no peripheral access initiates.</p> <p>0 This peripheral does not require supervisor privilege level for accesses. 1 This peripheral requires supervisor privilege level for accesses.</p> |

Table continues on the next page...

AIPS_PACR_n field descriptions (continued)

| Field | Description |
|---------------|---|
| 9 WP5 | <p>Write Protect</p> <p>Determines whether the peripheral allows write accesses. When this field is set and a write access is attempted, access terminates with an error response and no peripheral access initiates.</p> <p>0 This peripheral allows write accesses. 1 This peripheral is write protected.</p> |
| 8 TP5 | <p>Trusted Protect</p> <p>Determines whether the peripheral allows accesses from an untrusted master. When this field is set and an access is attempted by an untrusted master, the access terminates with an error response and no peripheral access initiates.</p> <p>0 Accesses from an untrusted master are allowed. 1 Accesses from an untrusted master are not allowed.</p> |
| 7 Reserved | <p>This field is reserved. This read-only field is reserved and always has the value 0.</p> |
| 6 SP6 | <p>Supervisor Protect</p> <p>Determines whether the peripheral requires supervisor privilege level for accesses. When this field is set, the master privilege level must indicate the supervisor access attribute, and the MPR_x[MPL_n] control field for the master must be set. If not, access terminates with an error response and no peripheral access initiates.</p> <p>0 This peripheral does not require supervisor privilege level for accesses. 1 This peripheral requires supervisor privilege level for accesses.</p> |
| 5 WP6 | <p>Write Protect</p> <p>Determines whether the peripheral allows write accesses. When this field is set and a write access is attempted, access terminates with an error response and no peripheral access initiates.</p> <p>0 This peripheral allows write accesses. 1 This peripheral is write protected.</p> |
| 4 TP6 | <p>Trusted Protect</p> <p>Determines whether the peripheral allows accesses from an untrusted master. When this field is set and an access is attempted by an untrusted master, the access terminates with an error response and no peripheral access initiates.</p> <p>0 Accesses from an untrusted master are allowed. 1 Accesses from an untrusted master are not allowed.</p> |
| 3 Reserved | <p>This field is reserved. This read-only field is reserved and always has the value 0.</p> |
| 2 SP7 | <p>Supervisor Protect</p> <p>Determines whether the peripheral requires supervisor privilege level for accesses. When this field is set, the master privilege level must indicate the supervisor access attribute, and the MPR_x[MPL_n] control field for the master must be set. If not, access terminates with an error response and no peripheral access initiates.</p> <p>0 This peripheral does not require supervisor privilege level for accesses. 1 This peripheral requires supervisor privilege level for accesses.</p> |

Table continues on the next page...

AIPS_PACR_n field descriptions (continued)

| Field | Description |
|----------|---|
| 1 WP7 | <p>Write Protect</p> <p>Determines whether the peripheral allows write accesses. When this field is set and a write access is attempted, access terminates with an error response and no peripheral access initiates.</p> <p>0 This peripheral allows write accesses. 1 This peripheral is write protected.</p> |
| 0 TP7 | <p>Trusted Protect</p> <p>Determines whether the peripheral allows accesses from an untrusted master. When this field is set and an access is attempted by an untrusted master, the access terminates with an error response and no peripheral access initiates.</p> <p>0 Accesses from an untrusted master are allowed. 1 Accesses from an untrusted master are not allowed.</p> |

22.2.3 Peripheral Access Control Register (AIPS_PACR_n)

This section describes PACR registers E-P, which control peripheral slots 32-127. See [Peripheral Access Control Register \(AIPS_PACR_n\)](#) for the description of these registers.

Address: 0h base + 40h offset + (4d × i), where i=0d to 11d

| | | | | | | | | | | | | | | | | |
|-------|----|-----|-----|-----|----|-----|-----|-----|----|-----|-----|-----|----|-----|-----|-----|
| Bit | 31 | 30 | 29 | 28 | 27 | 26 | 25 | 24 | 23 | 22 | 21 | 20 | 19 | 18 | 17 | 16 |
| R | 0 | SP0 | WP0 | TP0 | 0 | SP1 | WP1 | TP1 | 0 | SP2 | WP2 | TP2 | 0 | SP3 | WP3 | TP3 |
| W | | | | | | | | | | | | | | | | |
| Reset | 0* | 0* | 0* | 0* | 0* | 0* | 0* | 0* | 0* | 0* | 0* | 0* | 0* | 0* | 0* | 0* |
| Bit | 15 | 14 | 13 | 12 | 11 | 10 | 9 | 8 | 7 | 6 | 5 | 4 | 3 | 2 | 1 | 0 |
| R | 0 | SP4 | WP4 | TP4 | 0 | SP5 | WP5 | TP5 | 0 | SP6 | WP6 | TP6 | 0 | SP7 | WP7 | TP7 |
| W | | | | | | | | | | | | | | | | |
| Reset | 0* | 0* | 0* | 0* | 0* | 0* | 0* | 0* | 0* | 0* | 0* | 0* | 0* | 0* | 0* | 0* |

* Notes:

- The reset value is chip-dependent and can be found in the AIPS chip-specific information.

AIPS_PACR_n field descriptions

| Field | Description |
|----------------|--|
| 31 Reserved | <p>This field is reserved.</p> <p>This read-only field is reserved and always has the value 0.</p> |
| 30 SP0 | <p>Supervisor Protect</p> <p>Determines whether the peripheral requires supervisor privilege level for accesses. When this field is set, the master privilege level must indicate the supervisor access attribute, and the MPRx[MPL_n] control field</p> |

Table continues on the next page...

AIPS_PACR_n field descriptions (continued)

| Field | Description |
|----------------|---|
| | for the master must be set. If not, access terminates with an error response and no peripheral access initiates. 0 This peripheral does not require supervisor privilege level for accesses. 1 This peripheral requires supervisor privilege level for accesses. |
| 29 WP0 | Write Protect Determines whether the peripheral allows write accesses. When this field is set and a write access is attempted, access terminates with an error response and no peripheral access initiates. 0 This peripheral allows write accesses. 1 This peripheral is write protected. |
| 28 TP0 | Trusted Protect Determines whether the peripheral allows accesses from an untrusted master. When this bit is set and an access is attempted by an untrusted master, the access terminates with an error response and no peripheral access initiates. 0 Accesses from an untrusted master are allowed. 1 Accesses from an untrusted master are not allowed. |
| 27 Reserved | This field is reserved. This read-only field is reserved and always has the value 0. |
| 26 SP1 | Supervisor Protect Determines whether the peripheral requires supervisor privilege level for access. When this field is set, the master privilege level must indicate the supervisor access attribute, and the MPR _x [MPL _n] control field for the master must be set. If not, access terminates with an error response and no peripheral access initiates. 0 This peripheral does not require supervisor privilege level for accesses. 1 This peripheral requires supervisor privilege level for accesses. |
| 25 WP1 | Write Protect Determines whether the peripheral allows write accesses. When this field is set and a write access is attempted, access terminates with an error response and no peripheral access initiates. 0 This peripheral allows write accesses. 1 This peripheral is write protected. |
| 24 TP1 | Trusted Protect Determines whether the peripheral allows accesses from an untrusted master. When this field is set and an access is attempted by an untrusted master, the access terminates with an error response and no peripheral access initiates. 0 Accesses from an untrusted master are allowed. 1 Accesses from an untrusted master are not allowed. |
| 23 Reserved | This field is reserved. This read-only field is reserved and always has the value 0. |
| 22 SP2 | Supervisor Protect Determines whether the peripheral requires supervisor privilege level for access. When this bit is set, the master privilege level must indicate the supervisor access attribute, and the MPR _x [MPL _n] control bit for |

Table continues on the next page...

AIPS_PACR_n field descriptions (continued)

| Field | Description |
|----------------|---|
| | <p>the master must be set. If not, access terminates with an error response and no peripheral access initiates.</p> <p>0 This peripheral does not require supervisor privilege level for accesses. 1 This peripheral requires supervisor privilege level for accesses.</p> |
| 21 WP2 | <p>Write Protect</p> <p>Determines whether the peripheral allows write accesses. When this field is set and a write access is attempted, access terminates with an error response and no peripheral access initiates.</p> <p>0 This peripheral allows write accesses. 1 This peripheral is write protected.</p> |
| 20 TP2 | <p>Trusted Protect</p> <p>Determines whether the peripheral allows accesses from an untrusted master. When this bit is set and an access is attempted by an untrusted master, the access terminates with an error response and no peripheral access initiates.</p> <p>0 Accesses from an untrusted master are allowed. 1 Accesses from an untrusted master are not allowed.</p> |
| 19 Reserved | <p>This field is reserved. This read-only field is reserved and always has the value 0.</p> |
| 18 SP3 | <p>Supervisor Protect</p> <p>Determines whether the peripheral requires supervisor privilege level for accesses. When this field is set, the master privilege level must indicate the supervisor access attribute, and the MPR_x[MPL_n] control field for the master must be set. If not, access terminates with an error response and no peripheral access initiates.</p> <p>0 This peripheral does not require supervisor privilege level for accesses. 1 This peripheral requires supervisor privilege level for accesses.</p> |
| 17 WP3 | <p>Write Protect</p> <p>Determines whether the peripheral allows write access. When this bit is set and a write access is attempted, access terminates with an error response and no peripheral access initiates.</p> <p>0 This peripheral allows write accesses. 1 This peripheral is write protected.</p> |
| 16 TP3 | <p>Trusted Protect</p> <p>Determines whether the peripheral allows accesses from an untrusted master. When this field is set and an access is attempted by an untrusted master, the access terminates with an error response and no peripheral access initiates.</p> <p>0 Accesses from an untrusted master are allowed. 1 Accesses from an untrusted master are not allowed.</p> |
| 15 Reserved | <p>This field is reserved. This read-only field is reserved and always has the value 0.</p> |
| 14 SP4 | <p>Supervisor Protect</p> <p>Determines whether the peripheral requires supervisor privilege level for access. When this bit is set, the master privilege level must indicate the supervisor access attribute, and the MPR_x[MPL_n] control bit for</p> |

Table continues on the next page...

AIPS_PACR_n field descriptions (continued)

| Field | Description |
|----------------|--|
| | <p>the master must be set. If not, access terminates with an error response and no peripheral access initiates.</p> <p>0 This peripheral does not require supervisor privilege level for accesses. 1 This peripheral requires supervisor privilege level for accesses.</p> |
| 13 WP4 | <p>Write Protect</p> <p>Determines whether the peripheral allows write accesses. When this field is set and a write access is attempted, access terminates with an error response and no peripheral access initiates.</p> <p>0 This peripheral allows write accesses. 1 This peripheral is write protected.</p> |
| 12 TP4 | <p>Trusted Protect</p> <p>Determines whether the peripheral allows accesses from an untrusted master. When this bit is set and an access is attempted by an untrusted master, the access terminates with an error response and no peripheral access initiates.</p> <p>0 Accesses from an untrusted master are allowed. 1 Accesses from an untrusted master are not allowed.</p> |
| 11 Reserved | <p>This field is reserved. This read-only field is reserved and always has the value 0.</p> |
| 10 SP5 | <p>Supervisor Protect</p> <p>Determines whether the peripheral requires supervisor privilege level for accesses. When this field is set, the master privilege level must indicate the supervisor access attribute, and the MPRx[MPL_n] control field for the master must be set. If not, access terminates with an error response and no peripheral access initiates.</p> <p>0 This peripheral does not require supervisor privilege level for accesses. 1 This peripheral requires supervisor privilege level for accesses.</p> |
| 9 WP5 | <p>Write Protect</p> <p>Determines whether the peripheral allows write accesses. When this field is set and a write access is attempted, access terminates with an error response and no peripheral access initiates.</p> <p>0 This peripheral allows write accesses. 1 This peripheral is write protected.</p> |
| 8 TP5 | <p>Trusted Protect</p> <p>Determines whether the peripheral allows accesses from an untrusted master. When this field is set and an access is attempted by an untrusted master, the access terminates with an error response and no peripheral access initiates.</p> <p>0 Accesses from an untrusted master are allowed. 1 Accesses from an untrusted master are not allowed.</p> |
| 7 Reserved | <p>This field is reserved. This read-only field is reserved and always has the value 0.</p> |
| 6 SP6 | <p>Supervisor Protect</p> <p>Determines whether the peripheral requires supervisor privilege level for accesses. When this field is set, the master privilege level must indicate the supervisor access attribute, and the MPRx[MPL_n] control field</p> |

Table continues on the next page...

AIPS_PACR_n field descriptions (continued)

| Field | Description |
|-----------------------|---|
| | <p>for the master must be set. If not, access terminates with an error response and no peripheral access initiates.</p> <p>0 This peripheral does not require supervisor privilege level for accesses. 1 This peripheral requires supervisor privilege level for accesses.</p> |
| <p>5 WP6</p> | <p>Write Protect</p> <p>Determines whether the peripheral allows write accesses. When this field is set and a write access is attempted, access terminates with an error response and no peripheral access initiates.</p> <p>0 This peripheral allows write accesses. 1 This peripheral is write protected.</p> |
| <p>4 TP6</p> | <p>Trusted Protect</p> <p>Determines whether the peripheral allows accesses from an untrusted master. When this field is set and an access is attempted by an untrusted master, the access terminates with an error response and no peripheral access initiates.</p> <p>0 Accesses from an untrusted master are allowed. 1 Accesses from an untrusted master are not allowed.</p> |
| <p>3 Reserved</p> | <p>This field is reserved. This read-only field is reserved and always has the value 0.</p> |
| <p>2 SP7</p> | <p>Supervisor Protect</p> <p>Determines whether the peripheral requires supervisor privilege level for accesses. When this field is set, the master privilege level must indicate the supervisor access attribute, and the MPRx[MPL_n] control field for the master must be set. If not, access terminates with an error response and no peripheral access initiates.</p> <p>0 This peripheral does not require supervisor privilege level for accesses. 1 This peripheral requires supervisor privilege level for accesses.</p> |
| <p>1 WP7</p> | <p>Write Protect</p> <p>Determines whether the peripheral allows write accesses. When this field is set and a write access is attempted, access terminates with an error response and no peripheral access initiates.</p> <p>0 This peripheral allows write accesses. 1 This peripheral is write protected.</p> |
| <p>0 TP7</p> | <p>Trusted Protect</p> <p>Determines whether the peripheral allows accesses from an untrusted master. When this field is set and an access is attempted by an untrusted master, the access terminates with an error response and no peripheral access initiates.</p> <p>0 Accesses from an untrusted master are allowed. 1 Accesses from an untrusted master are not allowed.</p> |

22.3 Functional description

The peripheral bridge functions as a bus protocol translator between the crossbar switch and the slave peripheral bus.

The peripheral bridge manages all transactions destined for the attached slave devices and generates select signals for modules on the peripheral bus by decoding accesses within the attached address space.

22.3.1 Access support

All combinations of access size and peripheral data port width are supported. An access that is larger than the target peripheral's data width will be decomposed to multiple, smaller accesses. Bus decomposition is terminated by a transfer error caused by an access to an empty register area.

Chapter 23

Direct Memory Access Multiplexer (DMAMUX)

DMA MUX provides flexibility in the system's use of the available DMA channels. The DMA MUX routes up to 63 DMA sources, which are called slots to be mapped to any of the 4 DMA channels. Functionally, the DMA MUX channels may be divided into two classes: Channels that implement the normal routing functionality plus periodic triggering capability, and channels that implement only the normal routing functionality.

23.1 Introduction

23.1.1 Overview

The Direct Memory Access Multiplexer (DMAMUX) routes DMA sources, called slots, to any of the four DMA channels. This process is illustrated in the following figure.

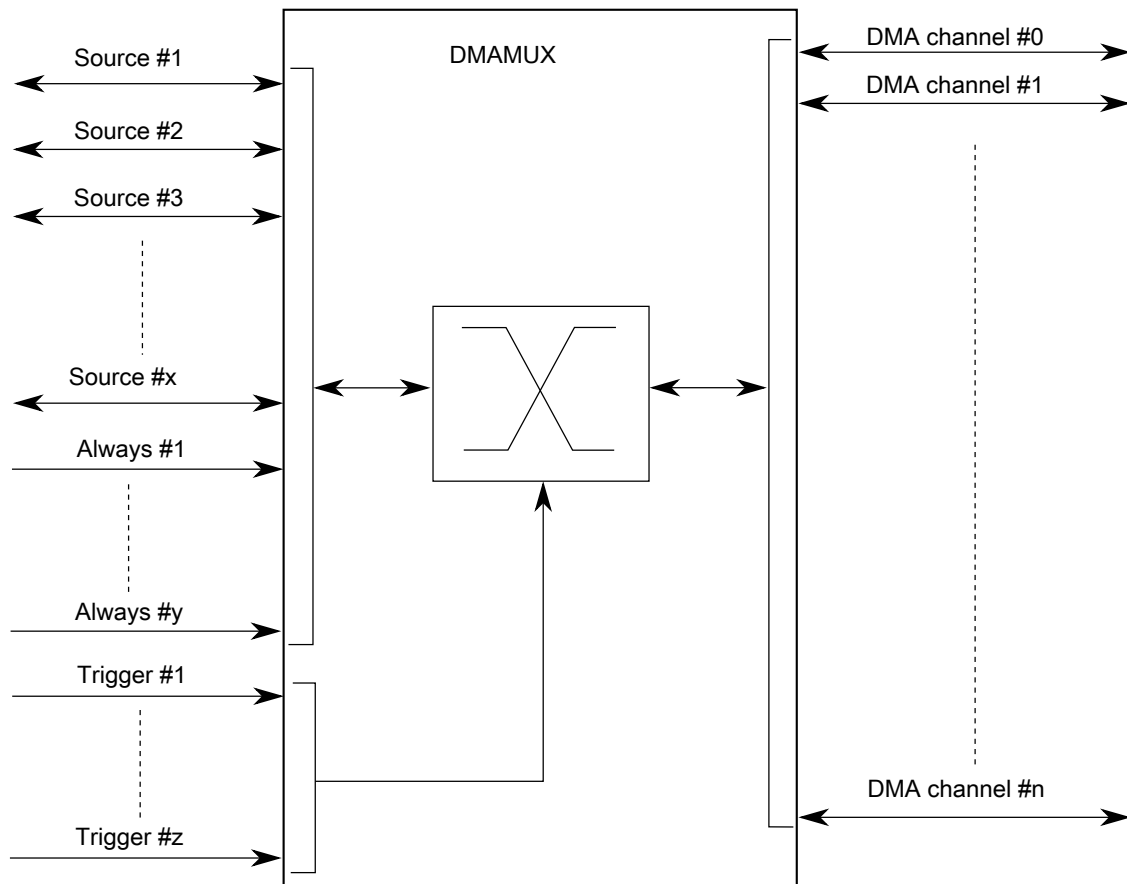

Figure 23-1. DMAMUX block diagram

23.1.2 Features

The DMAMUX module provides these features:

- Up to 63 peripheral slots and up to four always-on slots can be routed to four channels.
- four independently selectable DMA channel routers.
 - The first two channels additionally provide a trigger functionality.
- Each channel router can be assigned to one of the possible peripheral DMA slots or to one of the always-on slots.

23.1.3 Modes of operation

The following operating modes are available:

- Disabled mode

In this mode, the DMA channel is disabled. Because disabling and enabling of DMA channels is done primarily via the DMA configuration registers, this mode is used mainly as the reset state for a DMA channel in the DMA channel MUX. It may also be used to temporarily suspend a DMA channel while reconfiguration of the system takes place, for example, changing the period of a DMA trigger.

- Normal mode

In this mode, a DMA source is routed directly to the specified DMA channel. The operation of the DMAMUX in this mode is completely transparent to the system.

- Periodic Trigger mode

In this mode, a DMA source may only request a DMA transfer, such as when a transmit buffer becomes empty or a receive buffer becomes full, periodically.

23.2 External signal description

The DMAMUX has no external pins.

23.3 Memory map/register definition

This section provides a detailed description of all memory-mapped registers in the DMAMUX.

DMAMUX memory map

| Absolute address (hex) | Register name | Width (in bits) | Access | Reset value | Section/page |
|------------------------|---|-----------------|--------|-------------|----------------------------|
| 4002_1000 | Channel Configuration register (DMAMUX0_CHCFG0) | 8 | R/W | 00h | 23.3.1/445 |
| 4002_1001 | Channel Configuration register (DMAMUX0_CHCFG1) | 8 | R/W | 00h | 23.3.1/445 |
| 4002_1002 | Channel Configuration register (DMAMUX0_CHCFG2) | 8 | R/W | 00h | 23.3.1/445 |
| 4002_1003 | Channel Configuration register (DMAMUX0_CHCFG3) | 8 | R/W | 00h | 23.3.1/445 |

23.3.1 Channel Configuration register (DMAMUXx_CHCFGn)

Each of the DMA channels can be independently enabled/disabled and associated with one of the DMA slots (peripheral slots or always-on slots) in the system.

NOTE

Setting multiple CHCFG registers with the same source value will result in unpredictable behavior. This is true, even if a channel is disabled (ENBL==0).

Before changing the trigger or source settings, a DMA channel must be disabled via CHCFGn[ENBL].

Address: 4002_1000h base + 0h offset + (1d × i), where i=0d to 3d

| | | | | | | | | |
|-------|------|------|--------|---|---|---|---|---|
| Bit | 7 | 6 | 5 | 4 | 3 | 2 | 1 | 0 |
| Read | ENBL | TRIG | SOURCE | | | | | |
| Write | | | | | | | | |
| Reset | 0 | 0 | 0 | 0 | 0 | 0 | 0 | 0 |

DMAMUXx_CHCFGn field descriptions

| Field | Description |
|-----------|--|
| 7 ENBL | <p>DMA Channel Enable</p> <p>Enables the DMA channel.</p> <p>0 DMA channel is disabled. This mode is primarily used during configuration of the DMAMux. The DMA has separate channel enables/disables, which should be used to disable or reconfigure a DMA channel.</p> <p>1 DMA channel is enabled</p> |
| 6 TRIG | <p>DMA Channel Trigger Enable</p> <p>Enables the periodic trigger capability for the triggered DMA channel.</p> <p>0 Triggering is disabled. If triggering is disabled and ENBL is set, the DMA Channel will simply route the specified source to the DMA channel. (Normal mode)</p> <p>1 Triggering is enabled. If triggering is enabled and ENBL is set, the DMAMUX is in Periodic Trigger mode.</p> |
| SOURCE | <p>DMA Channel Source (Slot)</p> <p>Specifies which DMA source, if any, is routed to a particular DMA channel. See the chip-specific DMAMUX information for details about the peripherals and their slot numbers.</p> |

23.4 Functional description

The primary purpose of the DMAMUX is to provide flexibility in the system's use of the available DMA channels.

As such, configuration of the DMAMUX is intended to be a static procedure done during execution of the system boot code. However, if the procedure outlined in [Enabling and configuring sources](#) is followed, the configuration of the DMAMUX may be changed during the normal operation of the system.

Functionally, the DMAMUX channels may be divided into two classes:

- Channels that implement the normal routing functionality plus periodic triggering capability
- Channels that implement only the normal routing functionality

23.4.1 DMA channels with periodic triggering capability

Besides the normal routing functionality, the first 2 channels of the DMAMUX provide a special periodic triggering capability that can be used to provide an automatic mechanism to transmit bytes, frames, or packets at fixed intervals without the need for processor intervention.

Note

Because of the dynamic nature of the system (due to DMA channel priorities, bus arbitration, interrupt service routine lengths, etc.), the number of clock cycles between a trigger and the actual DMA transfer cannot be guaranteed.

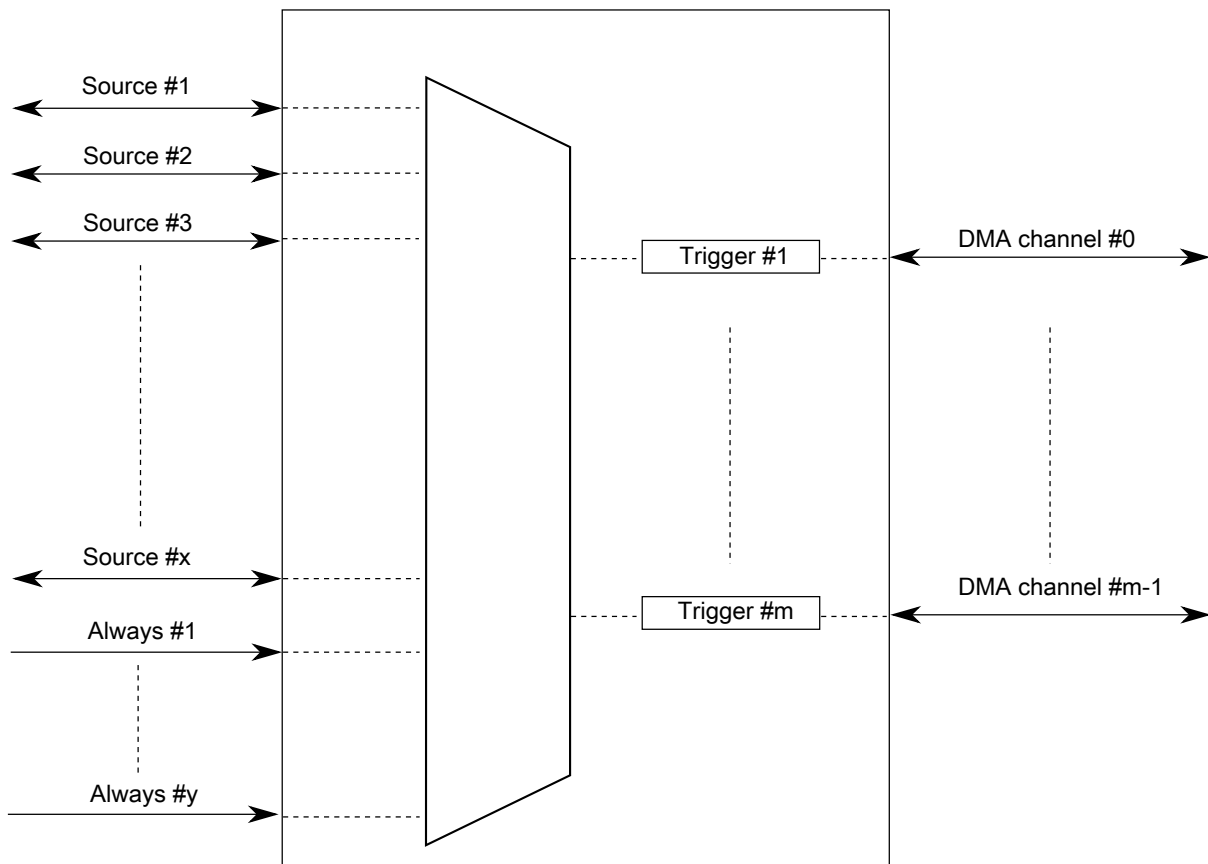

Figure 23-2. DMAMUX triggered channels

The DMA channel triggering capability allows the system to schedule regular DMA transfers, usually on the transmit side of certain peripherals, without the intervention of the processor. This trigger works by gating the request from the peripheral to the DMA until a trigger event has been seen. This is illustrated in the following figure.

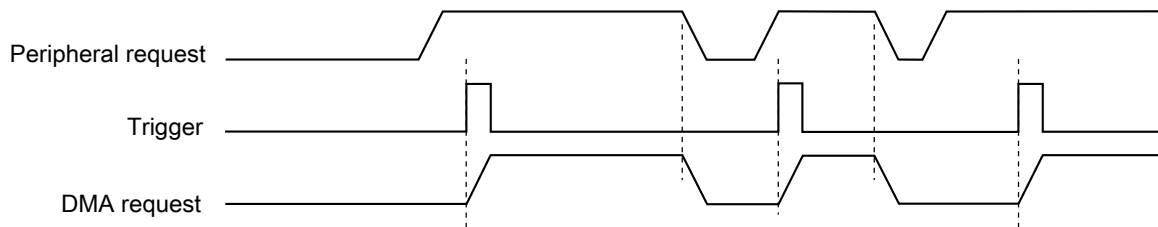

Figure 23-3. DMAMUX channel triggering: normal operation

After the DMA request has been serviced, the peripheral will negate its request, effectively resetting the gating mechanism until the peripheral reasserts its request and the next trigger event is seen. This means that if a trigger is seen, but the peripheral is not requesting a transfer, then that trigger will be ignored. This situation is illustrated in the following figure.

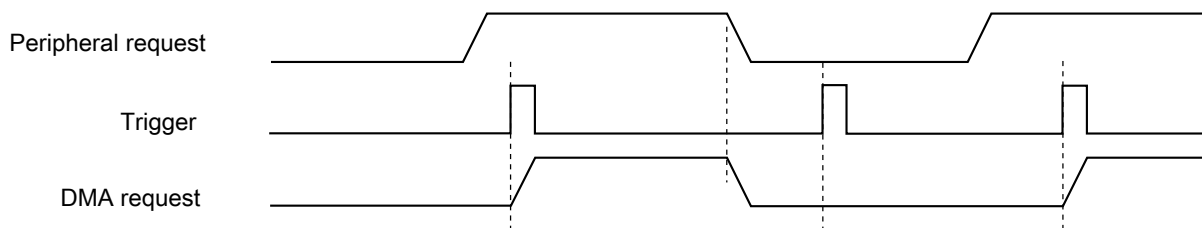

Figure 23-4. DMAMUX channel triggering: ignored trigger

This triggering capability may be used with any peripheral that supports DMA transfers, and is most useful for two types of situations:

- Periodically polling external devices on a particular bus

As an example, the transmit side of an SPI is assigned to a DMA channel with a trigger, as described above. After it has been set up, the SPI will request DMA transfers, presumably from memory, as long as its transmit buffer is empty. By using a trigger on this channel, the SPI transfers can be automatically performed every 5 μ s (as an example). On the receive side of the SPI, the SPI and DMA can be configured to transfer receive data into memory, effectively implementing a method to periodically read data from external devices and transfer the results into memory without processor intervention.

- Using the GPIO ports to drive or sample waveforms

By configuring the DMA to transfer data to one or more GPIO ports, it is possible to create complex waveforms using tabular data stored in on-chip memory. Conversely, using the DMA to periodically transfer data from one or more GPIO ports, it is possible to sample complex waveforms and store the results in tabular form in on-chip memory.

A more detailed description of the capability of each trigger, including resolution, range of values, and so on, may be found in the periodic interrupt timer section.

23.4.2 DMA channels with no triggering capability

The other channels of the DMAMUX provide the normal routing functionality as described in [Modes of operation](#).

23.4.3 Always-enabled DMA sources

In addition to the peripherals that can be used as DMA sources, there are four additional DMA sources that are always enabled. Unlike the peripheral DMA sources, where the peripheral controls the flow of data during DMA transfers, the sources that are always enabled provide no such "throttling" of the data transfers. These sources are most useful in the following cases:

- Performing DMA transfers to/from GPIO—Moving data from/to one or more GPIO pins, either unthrottled (that is, as fast as possible), or periodically (using the DMA triggering capability).
- Performing DMA transfers from memory to memory—Moving data from memory to memory, typically as fast as possible, sometimes with software activation.
- Performing DMA transfers from memory to the external bus, or vice-versa—Similar to memory to memory transfers, this is typically done as quickly as possible.
- Any DMA transfer that requires software activation—Any DMA transfer that should be explicitly started by software.

In cases where software should initiate the start of a DMA transfer, an always-enabled DMA source can be used to provide maximum flexibility. When activating a DMA channel via software, subsequent executions of the minor loop require that a new start event be sent. This can either be a new software activation, or a transfer request from the DMA channel MUX. The options for doing this are:

- Transfer all data in a single minor loop.

By configuring the DMA to transfer all of the data in a single minor loop (that is, major loop counter = 1), no reactivation of the channel is necessary. The disadvantage to this option is the reduced granularity in determining the load that the DMA transfer will impose on the system. For this option, the DMA channel must be disabled in the DMA channel MUX.

- Use explicit software reactivation.

In this option, the DMA is configured to transfer the data using both minor and major loops, but the processor is required to reactivate the channel by writing to the DMA registers *after every minor loop*. For this option, the DMA channel must be disabled in the DMA channel MUX.

- Use an always-enabled DMA source.

In this option, the DMA is configured to transfer the data using both minor and major loops, and the DMA channel MUX does the channel reactivation. For this option, the DMA channel should be enabled and pointing to an "always enabled" source. Note that the reactivation of the channel can be continuous (DMA triggering is disabled) or can use the DMA triggering capability. In this manner, it is possible to execute periodic transfers of packets of data from one source to another, without processor intervention.

23.4.4 DMA sources with cancel_rewind capability

If the DMA sources (or peripherals) determine the current packet being received is corrupt or incomplete, then they signal the DMA to discard the packet through DMA Channel Multiplexer. Discarding the packet involves two procedures: first, terminating the current data transfer, and second, restoring the DMA's program state back to its beginning - thus being ready for a new packet. This allows the processor to handle other critical tasks (or stay in low-power mode) while the DMA automatically discards the bad packet. Cancel_rewind capability support on each of the DMA channels and for every DMA source (or peripheral) except always-enabled DMA sources.

23.5 Initialization/application information

This section provides instructions for initializing the DMA channel MUX.

23.5.1 Reset

The reset state of each individual bit is shown in [Memory map/register definition](#). In summary, after reset, all channels are disabled and must be explicitly enabled before use.

23.5.2 Enabling and configuring sources

To enable a source with periodic triggering:

1. Determine with which DMA channel the source will be associated. Note that only the first 2 DMA channels have periodic triggering capability.
2. Clear the CHCFG[ENBL] and CHCFG[TRIG] fields of the DMA channel.
3. Ensure that the DMA channel is properly configured in the DMA. The DMA channel may be enabled at this point.
4. Configure the corresponding timer.
5. Select the source to be routed to the DMA channel. Write to the corresponding CHCFG register, ensuring that the CHCFG[ENBL] and CHCFG[TRIG] fields are set.

NOTE

The following is an example. See the chip configuration details for the number of this device's DMA channels that have triggering capability.

To configure source #5 transmit for use with DMA channel 1, with periodic triggering capability:

1. Write 0x00 to CHCFG1.
2. Configure channel 1 in the DMA, including enabling the channel.
3. Configure a timer for the desired trigger interval.
4. Write 0xC5 to CHCFG1.

The following code example illustrates steps 1 and 4 above:

```
void DMAMUX_Init(uint8_t DMA_CH, uint8_t DMAMUX_SOURCE)
{
    DMAMUX_0.CHCFG[DMA_CH].B.SOURCE = DMAMUX_SOURCE;
    DMAMUX_0.CHCFG[DMA_CH].B.ENBL   = 1;
    DMAMUX_0.CHCFG[DMA_CH].B.TRIG   = 1;
}
```

To enable a source, without periodic triggering:

1. Determine with which DMA channel the source will be associated. Note that only the first 2 DMA channels have periodic triggering capability.
2. Clear the CHCFG[ENBL] and CHCFG[TRIG] fields of the DMA channel.

3. Ensure that the DMA channel is properly configured in the DMA. The DMA channel may be enabled at this point.
4. Select the source to be routed to the DMA channel. Write to the corresponding CHCFG register, ensuring that CHCFG[ENBL] is set while CHCFG[TRIG] is cleared.

NOTE

The following is an example. See the chip configuration details for the number of this device's DMA channels that have triggering capability.

To configure source #5 transmit for use with DMA channel 1, with no periodic triggering capability:

1. Write 0x00 to CHCFG1.
2. Configure channel 1 in the DMA, including enabling the channel.
3. Write 0x85 to CHCFG1.

The following code example illustrates steps 1 and 3 above:

To disable a source:

A particular DMA source may be disabled by not writing the corresponding source value into any of the CHCFG registers. Additionally, some module-specific configuration may be necessary. See the appropriate section for more details.

To switch the source of a DMA channel:

1. Disable the DMA channel in the DMA and reconfigure the channel for the new source.
2. Clear the CHCFG[ENBL] and CHCFG[TRIG] bits of the DMA channel.
3. Select the source to be routed to the DMA channel. Write to the corresponding CHCFG register, ensuring that the CHCFG[ENBL] and CHCFG[TRIG] fields are set.

To switch DMA channel 8 from source #5 transmit to source #7 transmit:

1. In the DMA configuration registers, disable DMA channel 8 and reconfigure it to handle the transfers to peripheral slot 7. This example assumes channel 8 doesn't have triggering capability.
2. Write 0x00 to CHCFG8.
3. Write 0x87 to CHCFG8. (In this example, setting CHCFG[TRIG] would have no effect due to the assumption that channel 8 does not support the periodic triggering functionality.)

The following code example illustrates steps 2 and 3 above:

Chapter 24

DMA Controller Module

DMA Controller Module describes in detail its signals and programming model. It also explains operations, features, and supported data transfer modes.

24.1 Introduction

The enhanced direct memory access (eDMA) controller is a second-generation module capable of performing complex data transfers with minimal intervention from a host processor. The hardware microarchitecture includes:

- A DMA engine that performs:
 - Source address and destination address calculations
 - Data-movement operations
- Local memory containing transfer control descriptors for each of the 4 channels

24.1.1 eDMA system block diagram

[Figure 24-1](#) illustrates the components of the eDMA system, including the eDMA module ("engine").

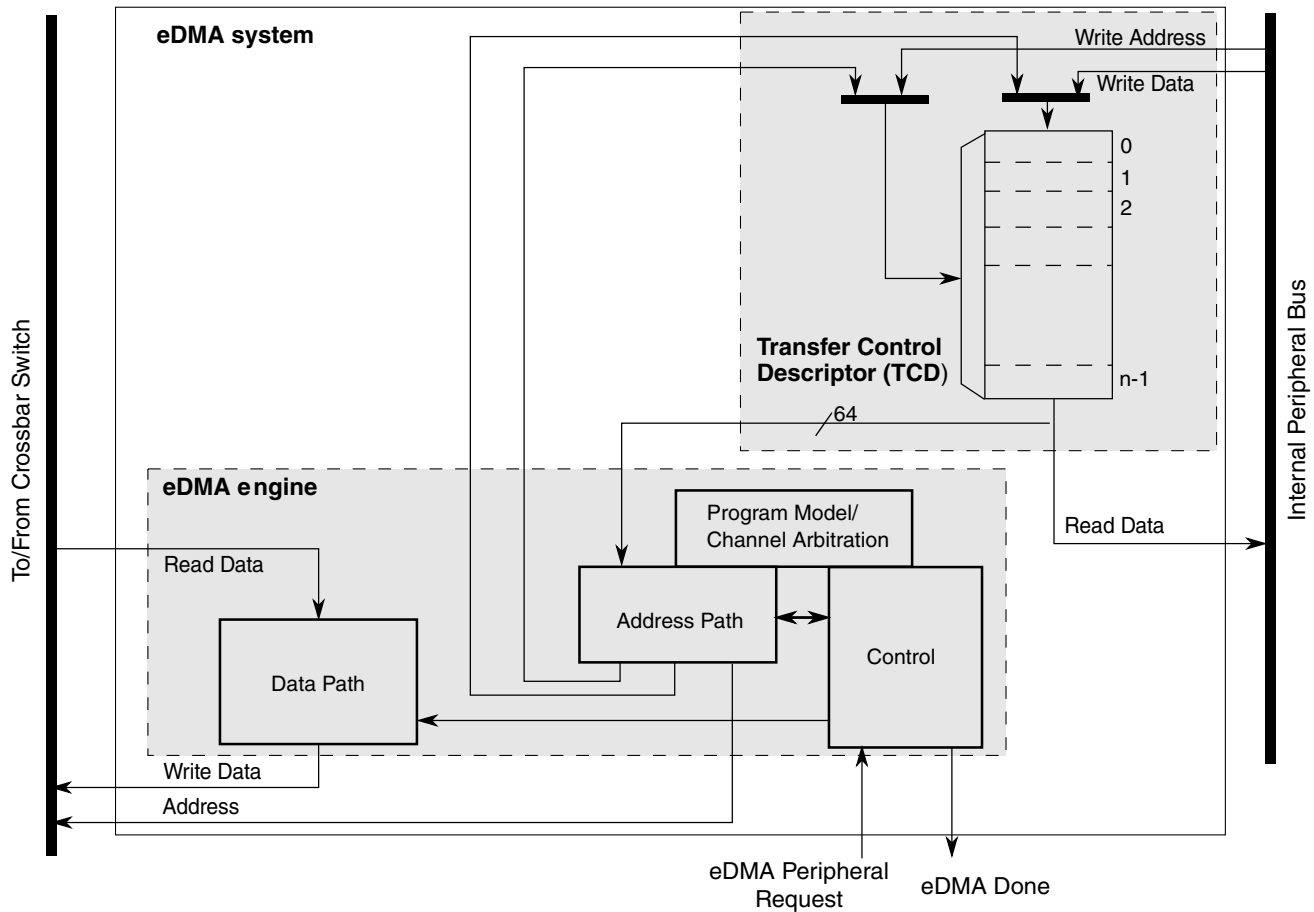

Figure 24-1. eDMA system block diagram

24.1.2 Block parts

The eDMA module is partitioned into two major modules: the eDMA engine and the transfer-control descriptor local memory.

The eDMA engine is further partitioned into four submodules:

Table 24-1. eDMA engine submodules

| Submodule | Function |
|--------------|---|
| Address path | <p>This block implements registered versions of two channel transfer control descriptors, channel x and channel y, and manages all master bus-address calculations. All the channels provide the same functionality. This structure allows data transfers associated with one channel to be preempted after the completion of a read/write sequence if a higher priority channel activation is asserted while the first channel is active. After a channel is activated, it runs until the minor loop is completed, unless preempted by a higher priority channel. This provides a mechanism (enabled by DCHPRI_n[ECP]) where a large data move operation can be preempted to minimize the time another channel is blocked from execution.</p> <p>When any channel is selected to execute, the contents of its TCD are read from local memory and loaded into the address path channel x registers for a normal start and into channel y registers for a preemption start. After the minor loop completes execution, the address path hardware writes</p> |

Table continues on the next page...

Table 24-1. eDMA engine submodules (continued)

| Submodule | Function |
|-----------------------------------|--|
| | the new values for the TCD _n _{SADDR, DADDR, CITER} back to local memory. If the major iteration count is exhausted, additional processing is performed, including the final address pointer updates, reloading the TCD _n _CITER field, and a possible fetch of the next TCD _n from memory as part of a scatter/gather operation. |
| Data path | This block implements the bus master read/write datapath. It includes a data buffer and the necessary multiplex logic to support any required data alignment. The internal read data bus is the primary input, and the internal write data bus is the primary output. The address and data path modules directly support the 2-stage pipelined internal bus. The address path module represents the 1st stage of the bus pipeline (address phase), while the data path module implements the 2nd stage of the pipeline (data phase). |
| Program model/channel arbitration | This block implements the first section of the eDMA programming model as well as the channel arbitration logic. The programming model registers are connected to the internal peripheral bus. The eDMA peripheral request inputs and interrupt request outputs are also connected to this block (via control logic). |
| Control | This block provides all the control functions for the eDMA engine. For data transfers where the source and destination sizes are equal, the eDMA engine performs a series of source read/destination write operations until the number of bytes specified in the minor loop byte count has moved. For descriptors where the sizes are not equal, multiple accesses of the smaller size data are required for each reference of the larger size. As an example, if the source size references 16-bit data and the destination is 32-bit data, two reads are performed, then one 32-bit write. |

The transfer-control descriptor local memory is further partitioned into:

Table 24-2. Transfer control descriptor memory

| Submodule | Description |
|-------------------|---|
| Memory controller | This logic implements the required dual-ported controller, managing accesses from the eDMA engine as well as references from the internal peripheral bus. As noted earlier, in the event of simultaneous accesses, the eDMA engine is given priority and the peripheral transaction is stalled. |
| Memory array | TCD storage for each channel's transfer profile. |

24.1.3 Features

The eDMA is a highly programmable data-transfer engine optimized to minimize any required intervention from the host processor. It is intended for use in applications where the data size to be transferred is statically known and not defined within the transferred data itself. The eDMA module features:

- All data movement via dual-address transfers: read from source, write to destination
 - Programmable source and destination addresses and transfer size
 - Support for enhanced addressing modes

- 4-channel implementation that performs complex data transfers with minimal intervention from a host processor
 - Connections to the crossbar switch for bus mastering the data movement
- Transfer control descriptor (TCD) organized to support two-deep, nested transfer operations
 - 32-byte TCD stored in local memory for each channel
 - An inner data transfer loop defined by a minor byte transfer count
 - An outer data transfer loop defined by a major iteration count
- Channel activation via one of three methods:
 - Explicit software initiation
 - Initiation via a channel-to-channel linking mechanism for continuous transfers
 - Peripheral-paced hardware requests, one per channel
- Fixed-priority and round-robin channel arbitration
- Channel completion reported via programmable interrupt requests
 - One interrupt per channel, which can be asserted at completion of major iteration count
 - Programmable error terminations per channel and logically summed together to form one error interrupt to the interrupt controller
- Programmable support for scatter/gather DMA processing
- Support for complex data structures

In the discussion of this module, n is used to reference the channel number.

24.2 Modes of operation

The eDMA operates in the following modes:

Table 24-3. Modes of operation

| Mode | Description |
|--------|--|
| Normal | In Normal mode, the eDMA transfers data between a source and a destination. The source and destination can be a memory block or an I/O block capable of operation with the eDMA. |

Table continues on the next page...

Table 24-3. Modes of operation (continued)

| Mode | Description |
|-------|--|
| | A service request initiates a transfer of a specific number of bytes (NBYTES) as specified in the transfer control descriptor (TCD). The minor loop is the sequence of read-write operations that transfers these NBYTES per service request. Each service request executes one iteration of the major loop, which transfers NBYTES of data. |
| Debug | DMA operation is configurable in Debug mode via the control register: <ul style="list-style-type: none"> • If CR[EDBG] is cleared, the DMA continues to operate. • If CR[EDBG] is set, the eDMA stops transferring data. If Debug mode is entered while a channel is active, the eDMA continues operation until the channel retires. |

24.3 Memory map/register definition

The eDMA's programming model is partitioned into two regions:

- The first region defines a number of registers providing control functions
- The second region corresponds to the local transfer control descriptor (TCD) memory

24.3.1 TCD memory

Each channel requires a 32-byte transfer control descriptor for defining the desired data movement operation. The channel descriptors are stored in the local memory in sequential order: channel 0, channel 1, ... channel 3. Each TCD_n definition is presented as 11 registers of 16 or 32 bits.

24.3.2 TCD initialization

Prior to activating a channel, you must initialize its TCD with the appropriate transfer profile.

24.3.3 TCD structure

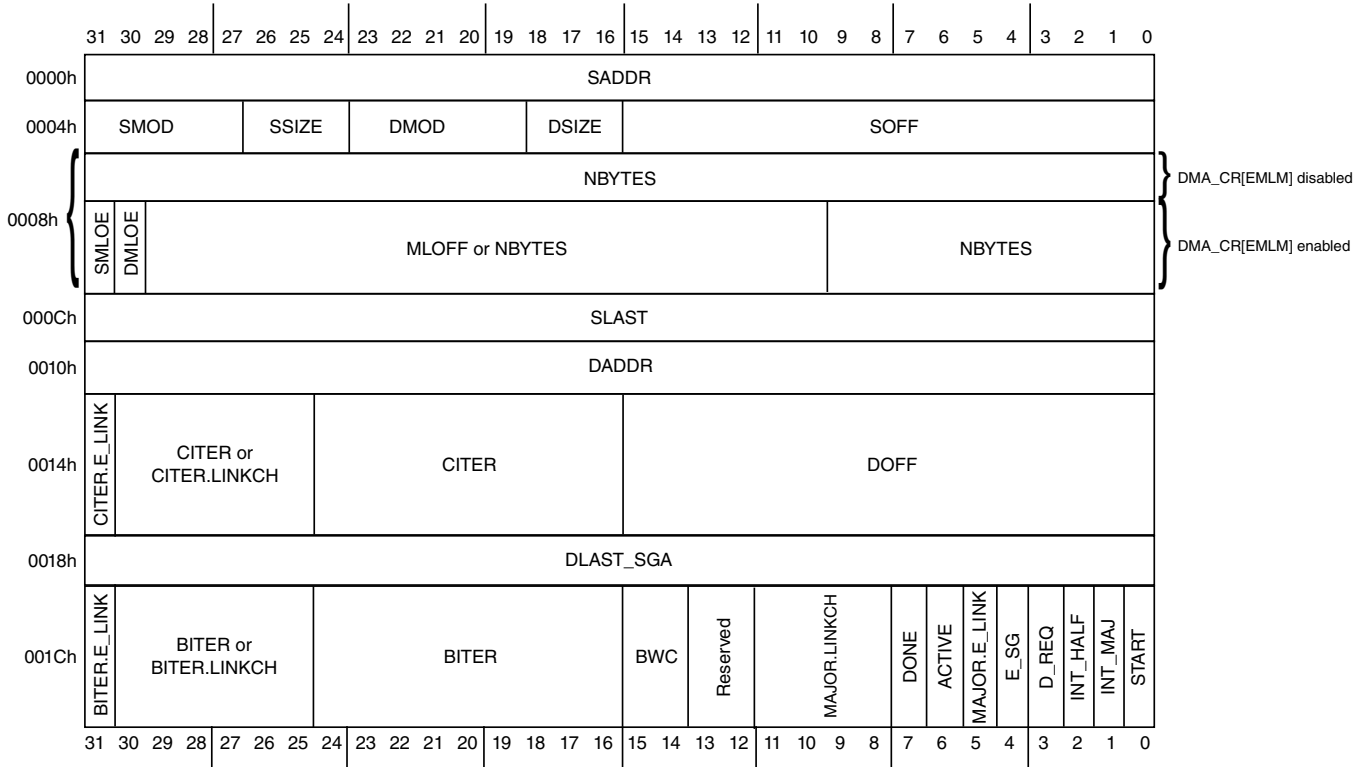

24.3.4 Reserved memory and bit fields

- Reading reserved bits in a register returns the value of zero.
- Writes to reserved bits in a register are ignored.
- Reading or writing a reserved memory location generates a bus error.

DMA memory map

| Absolute address (hex) | Register name | Width (in bits) | Access | Reset value | Section/page |
|------------------------|--|-----------------|-----------------------|-----------------------------|-----------------------------|
| 4000_8000 | Control Register (DMA_CR) | 32 | R/W | See section | 24.3.5/462 |
| 4000_8004 | Error Status Register (DMA_ES) | 32 | R | 0000_0000h | 24.3.6/465 |
| 4000_800C | Enable Request Register (DMA_ERQ) | 32 | R/W | 0000_0000h | 24.3.7/467 |
| 4000_8014 | Enable Error Interrupt Register (DMA_EEI) | 32 | R/W | 0000_0000h | 24.3.8/468 |
| 4000_8018 | Clear Enable Error Interrupt Register (DMA_CEEI) | 8 | W (always reads 0) | 00h | 24.3.9/469 |
| 4000_8019 | Set Enable Error Interrupt Register (DMA_SEEI) | 8 | W (always reads 0) | 00h | 24.3.10/470 |

Table continues on the next page...

DMA memory map (continued)

| Absolute address (hex) | Register name | Width (in bits) | Access | Reset value | Section/page |
|------------------------|---|-----------------|-----------------------|-----------------------------|-----------------------------|
| 4000_801A | Clear Enable Request Register (DMA_CERQ) | 8 | W (always reads 0) | 00h | 24.3.11/471 |
| 4000_801B | Set Enable Request Register (DMA_SERQ) | 8 | W (always reads 0) | 00h | 24.3.12/472 |
| 4000_801C | Clear DONE Status Bit Register (DMA_CDNE) | 8 | W (always reads 0) | 00h | 24.3.13/473 |
| 4000_801D | Set START Bit Register (DMA_SSRT) | 8 | W (always reads 0) | 00h | 24.3.14/474 |
| 4000_801E | Clear Error Register (DMA_CERR) | 8 | W (always reads 0) | 00h | 24.3.15/475 |
| 4000_801F | Clear Interrupt Request Register (DMA_CINT) | 8 | W (always reads 0) | 00h | 24.3.16/476 |
| 4000_8024 | Interrupt Request Register (DMA_INT) | 32 | R/W | 0000_0000h | 24.3.17/477 |
| 4000_802C | Error Register (DMA_ERR) | 32 | R/W | 0000_0000h | 24.3.18/478 |
| 4000_8034 | Hardware Request Status Register (DMA_HRS) | 32 | R | 0000_0000h | 24.3.19/479 |
| 4000_8044 | Enable Asynchronous Request in Stop Register (DMA_EARS) | 32 | R/W | 0000_0000h | 24.3.20/481 |
| 4000_8100 | Channel n Priority Register (DMA_DCHPRI3) | 8 | R/W | See section | 24.3.21/482 |
| 4000_8101 | Channel n Priority Register (DMA_DCHPRI2) | 8 | R/W | See section | 24.3.21/482 |
| 4000_8102 | Channel n Priority Register (DMA_DCHPRI1) | 8 | R/W | See section | 24.3.21/482 |
| 4000_8103 | Channel n Priority Register (DMA_DCHPRI0) | 8 | R/W | See section | 24.3.21/482 |
| 4000_9000 | TCD Source Address (DMA_TCD0_SADDR) | 32 | R/W | Undefined | 24.3.22/483 |
| 4000_9004 | TCD Signed Source Address Offset (DMA_TCD0_SOFF) | 16 | R/W | Undefined | 24.3.23/483 |
| 4000_9006 | TCD Transfer Attributes (DMA_TCD0_ATTR) | 16 | R/W | Undefined | 24.3.24/484 |
| 4000_9008 | TCD Minor Byte Count (Minor Loop Mapping Disabled) (DMA_TCD0_NBYTES_MLNO) | 32 | R/W | Undefined | 24.3.25/485 |
| 4000_9008 | TCD Signed Minor Loop Offset (Minor Loop Mapping Enabled and Offset Disabled) (DMA_TCD0_NBYTES_MLOFFNO) | 32 | R/W | Undefined | 24.3.26/485 |
| 4000_9008 | TCD Signed Minor Loop Offset (Minor Loop Mapping and Offset Enabled) (DMA_TCD0_NBYTES_MLOFFYES) | 32 | R/W | Undefined | 24.3.27/487 |
| 4000_900C | TCD Last Source Address Adjustment (DMA_TCD0_SLAST) | 32 | R/W | Undefined | 24.3.28/488 |
| 4000_9010 | TCD Destination Address (DMA_TCD0_DADDR) | 32 | R/W | Undefined | 24.3.29/489 |
| 4000_9014 | TCD Signed Destination Address Offset (DMA_TCD0_DOFF) | 16 | R/W | Undefined | 24.3.30/489 |
| 4000_9016 | TCD Current Minor Loop Link, Major Loop Count (Channel Linking Enabled) (DMA_TCD0_CITER_ELINKYES) | 16 | R/W | Undefined | 24.3.31/490 |

Table continues on the next page...

DMA memory map (continued)

| Absolute address (hex) | Register name | Width (in bits) | Access | Reset value | Section/page |
|------------------------|---|-----------------|--------|-------------|-----------------------------|
| 4000_9016 | DMA_TCD0_CITER_ELINKNO | 16 | R/W | Undefined | 24.3.32/491 |
| 4000_9018 | TCD Last Destination Address Adjustment/Scatter Gather Address (DMA_TCD0_DLASTGA) | 32 | R/W | Undefined | 24.3.33/492 |
| 4000_901C | TCD Control and Status (DMA_TCD0_CSR) | 16 | R/W | Undefined | 24.3.34/493 |
| 4000_901E | TCD Beginning Minor Loop Link, Major Loop Count (Channel Linking Enabled) (DMA_TCD0_BITER_ELINKYES) | 16 | R/W | Undefined | 24.3.35/495 |
| 4000_901E | TCD Beginning Minor Loop Link, Major Loop Count (Channel Linking Disabled) (DMA_TCD0_BITER_ELINKNO) | 16 | R/W | Undefined | 24.3.36/496 |
| 4000_9020 | TCD Source Address (DMA_TCD1_SADDR) | 32 | R/W | Undefined | 24.3.22/483 |
| 4000_9024 | TCD Signed Source Address Offset (DMA_TCD1_SOFF) | 16 | R/W | Undefined | 24.3.23/483 |
| 4000_9026 | TCD Transfer Attributes (DMA_TCD1_ATTR) | 16 | R/W | Undefined | 24.3.24/484 |
| 4000_9028 | TCD Minor Byte Count (Minor Loop Mapping Disabled) (DMA_TCD1_NBYTES_MLNO) | 32 | R/W | Undefined | 24.3.25/485 |
| 4000_9028 | TCD Signed Minor Loop Offset (Minor Loop Mapping Enabled and Offset Disabled) (DMA_TCD1_NBYTES_MLOFFNO) | 32 | R/W | Undefined | 24.3.26/485 |
| 4000_9028 | TCD Signed Minor Loop Offset (Minor Loop Mapping and Offset Enabled) (DMA_TCD1_NBYTES_MLOFFYES) | 32 | R/W | Undefined | 24.3.27/487 |
| 4000_902C | TCD Last Source Address Adjustment (DMA_TCD1_SLAST) | 32 | R/W | Undefined | 24.3.28/488 |
| 4000_9030 | TCD Destination Address (DMA_TCD1_DADDR) | 32 | R/W | Undefined | 24.3.29/489 |
| 4000_9034 | TCD Signed Destination Address Offset (DMA_TCD1_DOFF) | 16 | R/W | Undefined | 24.3.30/489 |
| 4000_9036 | TCD Current Minor Loop Link, Major Loop Count (Channel Linking Enabled) (DMA_TCD1_CITER_ELINKYES) | 16 | R/W | Undefined | 24.3.31/490 |
| 4000_9036 | DMA_TCD1_CITER_ELINKNO | 16 | R/W | Undefined | 24.3.32/491 |
| 4000_9038 | TCD Last Destination Address Adjustment/Scatter Gather Address (DMA_TCD1_DLASTGA) | 32 | R/W | Undefined | 24.3.33/492 |
| 4000_903C | TCD Control and Status (DMA_TCD1_CSR) | 16 | R/W | Undefined | 24.3.34/493 |
| 4000_903E | TCD Beginning Minor Loop Link, Major Loop Count (Channel Linking Enabled) (DMA_TCD1_BITER_ELINKYES) | 16 | R/W | Undefined | 24.3.35/495 |
| 4000_903E | TCD Beginning Minor Loop Link, Major Loop Count (Channel Linking Disabled) (DMA_TCD1_BITER_ELINKNO) | 16 | R/W | Undefined | 24.3.36/496 |
| 4000_9040 | TCD Source Address (DMA_TCD2_SADDR) | 32 | R/W | Undefined | 24.3.22/483 |
| 4000_9044 | TCD Signed Source Address Offset (DMA_TCD2_SOFF) | 16 | R/W | Undefined | 24.3.23/483 |
| 4000_9046 | TCD Transfer Attributes (DMA_TCD2_ATTR) | 16 | R/W | Undefined | 24.3.24/484 |
| 4000_9048 | TCD Minor Byte Count (Minor Loop Mapping Disabled) (DMA_TCD2_NBYTES_MLNO) | 32 | R/W | Undefined | 24.3.25/485 |
| 4000_9048 | TCD Signed Minor Loop Offset (Minor Loop Mapping Enabled and Offset Disabled) (DMA_TCD2_NBYTES_MLOFFNO) | 32 | R/W | Undefined | 24.3.26/485 |

Table continues on the next page...

DMA memory map (continued)

| Absolute address (hex) | Register name | Width (in bits) | Access | Reset value | Section/page |
|------------------------|---|-----------------|--------|-------------|-----------------------------|
| 4000_9048 | TCD Signed Minor Loop Offset (Minor Loop Mapping and Offset Enabled) (DMA_TCD2_NBYTES_MLOFFYES) | 32 | R/W | Undefined | 24.3.27/487 |
| 4000_904C | TCD Last Source Address Adjustment (DMA_TCD2_SLAST) | 32 | R/W | Undefined | 24.3.28/488 |
| 4000_9050 | TCD Destination Address (DMA_TCD2_DADDR) | 32 | R/W | Undefined | 24.3.29/489 |
| 4000_9054 | TCD Signed Destination Address Offset (DMA_TCD2_DOFF) | 16 | R/W | Undefined | 24.3.30/489 |
| 4000_9056 | TCD Current Minor Loop Link, Major Loop Count (Channel Linking Enabled) (DMA_TCD2_CITER_ELINKYES) | 16 | R/W | Undefined | 24.3.31/490 |
| 4000_9056 | DMA_TCD2_CITER_ELINKNO | 16 | R/W | Undefined | 24.3.32/491 |
| 4000_9058 | TCD Last Destination Address Adjustment/Scatter Gather Address (DMA_TCD2_DLASTSGA) | 32 | R/W | Undefined | 24.3.33/492 |
| 4000_905C | TCD Control and Status (DMA_TCD2_CSR) | 16 | R/W | Undefined | 24.3.34/493 |
| 4000_905E | TCD Beginning Minor Loop Link, Major Loop Count (Channel Linking Enabled) (DMA_TCD2_BITER_ELINKYES) | 16 | R/W | Undefined | 24.3.35/495 |
| 4000_905E | TCD Beginning Minor Loop Link, Major Loop Count (Channel Linking Disabled) (DMA_TCD2_BITER_ELINKNO) | 16 | R/W | Undefined | 24.3.36/496 |
| 4000_9060 | TCD Source Address (DMA_TCD3_SADDR) | 32 | R/W | Undefined | 24.3.22/483 |
| 4000_9064 | TCD Signed Source Address Offset (DMA_TCD3_SOFF) | 16 | R/W | Undefined | 24.3.23/483 |
| 4000_9066 | TCD Transfer Attributes (DMA_TCD3_ATTR) | 16 | R/W | Undefined | 24.3.24/484 |
| 4000_9068 | TCD Minor Byte Count (Minor Loop Mapping Disabled) (DMA_TCD3_NBYTES_MLNO) | 32 | R/W | Undefined | 24.3.25/485 |
| 4000_9068 | TCD Signed Minor Loop Offset (Minor Loop Mapping Enabled and Offset Disabled) (DMA_TCD3_NBYTES_MLOFFNO) | 32 | R/W | Undefined | 24.3.26/485 |
| 4000_9068 | TCD Signed Minor Loop Offset (Minor Loop Mapping and Offset Enabled) (DMA_TCD3_NBYTES_MLOFFYES) | 32 | R/W | Undefined | 24.3.27/487 |
| 4000_906C | TCD Last Source Address Adjustment (DMA_TCD3_SLAST) | 32 | R/W | Undefined | 24.3.28/488 |
| 4000_9070 | TCD Destination Address (DMA_TCD3_DADDR) | 32 | R/W | Undefined | 24.3.29/489 |
| 4000_9074 | TCD Signed Destination Address Offset (DMA_TCD3_DOFF) | 16 | R/W | Undefined | 24.3.30/489 |
| 4000_9076 | TCD Current Minor Loop Link, Major Loop Count (Channel Linking Enabled) (DMA_TCD3_CITER_ELINKYES) | 16 | R/W | Undefined | 24.3.31/490 |
| 4000_9076 | DMA_TCD3_CITER_ELINKNO | 16 | R/W | Undefined | 24.3.32/491 |
| 4000_9078 | TCD Last Destination Address Adjustment/Scatter Gather Address (DMA_TCD3_DLASTSGA) | 32 | R/W | Undefined | 24.3.33/492 |
| 4000_907C | TCD Control and Status (DMA_TCD3_CSR) | 16 | R/W | Undefined | 24.3.34/493 |
| 4000_907E | TCD Beginning Minor Loop Link, Major Loop Count (Channel Linking Enabled) (DMA_TCD3_BITER_ELINKYES) | 16 | R/W | Undefined | 24.3.35/495 |

Table continues on the next page...

DMA memory map (continued)

| Absolute address (hex) | Register name | Width (in bits) | Access | Reset value | Section/page |
|------------------------|---|-----------------|--------|-------------|-----------------------------|
| 4000_907E | TCD Beginning Minor Loop Link, Major Loop Count (Channel Linking Disabled) (DMA_TCD3_BITER_ELINKNO) | 16 | R/W | Undefined | 24.3.36/496 |

24.3.5 Control Register (DMA_CR)

The CR defines the basic operating configuration of the DMA.

Arbitration can be configured to use either a fixed-priority or a round-robin scheme. For fixed-priority arbitration, the highest priority channel requesting service is selected to execute. The channel priority registers assign the priorities; see the DCHPRIn registers. For round-robin arbitration, the channel priorities are ignored and channels are cycled through (from high to low channel number) without regard to priority.

NOTE

For correct operation, writes to the CR register must be performed only when the DMA channels are inactive; that is, when TCDn_CSR[ACTIVE] bits are cleared.

Minor loop offsets are address offset values added to the final source address (TCDn_SADDR) or destination address (TCDn_DADDR) upon minor loop completion. When minor loop offsets are enabled, the minor loop offset (MLOFF) is added to the final source address (TCDn_SADDR), to the final destination address (TCDn_DADDR), or to both prior to the addresses being written back into the TCD. If the major loop is complete, the minor loop offset is ignored and the major loop address offsets (TCDn_SLAST and TCDn_DLAST_SGA) are used to compute the next TCDn_SADDR and TCDn_DADDR values.

When minor loop mapping is enabled (EMLM is 1), TCDn word2 is redefined. A portion of TCDn word2 is used to specify multiple fields: a source enable bit (SMLOE) to specify the minor loop offset should be applied to the source address (TCDn_SADDR) upon minor loop completion, a destination enable bit (DMLOE) to specify the minor loop offset should be applied to the destination address (TCDn_DADDR) upon minor loop completion, and the sign extended minor loop offset value (MLOFF). The same offset value (MLOFF) is used for both source and destination minor loop offsets. When either minor loop offset is enabled (SMLOE set or DMLOE set), the NBYTES field is reduced to 10 bits. When both minor loop offsets are disabled (SMLOE cleared and DMLOE cleared), the NBYTES field is a 30-bit vector.

When minor loop mapping is disabled (EMLM is 0), all 32 bits of TCDn word2 are assigned to the NBYTES field.

Address: 4000_8000h base + 0h offset = 4000_8000h

| | | | | | | | | | | | | | | | | | |
|-------|----------|----------|----|----|----|----|----|----|------|-----|------|-----|----------|------|------|----------|-----|
| Bit | 31 | 30 | 29 | 28 | 27 | 26 | 25 | 24 | 23 | 22 | 21 | 20 | 19 | 18 | 17 | 16 | |
| R | ACTIVE | Reserved | | | | | | | 0 | | | | | | | CX | ECX |
| W | [Shaded] | | | | | | | | | | | | | | | | |
| Reset | 0 | x* | x* | x* | x* | x* | x* | x* | 0 | 0 | 0 | 0 | 0 | 0 | 0 | 0 | |
| Bit | 15 | 14 | 13 | 12 | 11 | 10 | 9 | 8 | 7 | 6 | 5 | 4 | 3 | 2 | 1 | 0 | |
| R | 0 | | | | | | | | EMLM | CLM | HALT | HOE | Reserved | ERCA | EDBG | Reserved | |
| W | [Shaded] | | | | | | | | | | | | | | | | |
| Reset | 0 | 0 | 0 | 0 | 0 | 0 | 0 | 0 | 0 | 0 | 0 | 0 | 0 | 0 | 0 | 0 | |

- * Notes:
- x = Undefined at reset.

DMA_CR field descriptions

| Field | Description |
|-------------------|---|
| 31 ACTIVE | DMA Active Status 0 eDMA is idle. 1 eDMA is executing a channel. |
| 30–24 Reserved | This field is reserved. Reserved |
| 23–18 Reserved | This field is reserved. This read-only field is reserved and always has the value 0. |
| 17 CX | Cancel Transfer 0 Normal operation 1 Cancel the remaining data transfer. Stop the executing channel and force the minor loop to finish. The cancel takes effect after the last write of the current read/write sequence. The CX bit clears itself after |

Table continues on the next page...

DMA_CR field descriptions (continued)

| Field | Description |
|------------------|--|
| | the cancel has been honored. This cancel retires the channel normally as if the minor loop was completed. |
| 16 ECX | <p>Error Cancel Transfer</p> <p>0 Normal operation</p> <p>1 Cancel the remaining data transfer in the same fashion as the CX bit. Stop the executing channel and force the minor loop to finish. The cancel takes effect after the last write of the current read/write sequence. The ECX bit clears itself after the cancel is honored. In addition to cancelling the transfer, ECX treats the cancel as an error condition, thus updating the Error Status register (DMAx_ES) and generating an optional error interrupt.</p> |
| 15–8 Reserved | <p>This field is reserved.</p> <p>This read-only field is reserved and always has the value 0.</p> |
| 7 EMLM | <p>Enable Minor Loop Mapping</p> <p>0 Disabled. TCDn.word2 is defined as a 32-bit NBYTES field.</p> <p>1 Enabled. TCDn.word2 is redefined to include individual enable fields, an offset field, and the NBYTES field. The individual enable fields allow the minor loop offset to be applied to the source address, the destination address, or both. The NBYTES field is reduced when either offset is enabled.</p> |
| 6 CLM | <p>Continuous Link Mode</p> <p>NOTE: Do not use continuous link mode with a channel linking to itself if there is only one minor loop iteration per service request, e.g., if the channel's NBYTES value is the same as either the source or destination size. The same data transfer profile can be achieved by simply increasing the NBYTES value, which provides more efficient, faster processing.</p> <p>0 A minor loop channel link made to itself goes through channel arbitration before being activated again.</p> <p>1 A minor loop channel link made to itself does not go through channel arbitration before being activated again. Upon minor loop completion, the channel activates again if that channel has a minor loop channel link enabled and the link channel is itself. This effectively applies the minor loop offsets and restarts the next minor loop.</p> |
| 5 HALT | <p>Halt DMA Operations</p> <p>0 Normal operation</p> <p>1 Stall the start of any new channels. Executing channels are allowed to complete. Channel execution resumes when this bit is cleared.</p> |
| 4 HOE | <p>Halt On Error</p> <p>0 Normal operation</p> <p>1 Any error causes the HALT bit to set. Subsequently, all service requests are ignored until the HALT bit is cleared.</p> |
| 3 Reserved | <p>This field is reserved.</p> <p>Reserved</p> |
| 2 ERCA | <p>Enable Round Robin Channel Arbitration</p> <p>0 Fixed priority arbitration is used for channel selection .</p> <p>1 Round robin arbitration is used for channel selection .</p> |
| 1 EDBG | <p>Enable Debug</p> |

Table continues on the next page...

DMA_CR field descriptions (continued)

| Field | Description |
|---------------|---|
| 0 | When in debug mode, the DMA continues to operate. |
| 1 | When in debug mode, the DMA stalls the start of a new channel. Executing channels are allowed to complete. Channel execution resumes when the system exits debug mode or the EDBG bit is cleared. |
| 0 Reserved | This field is reserved. Reserved |

24.3.6 Error Status Register (DMA_ES)

The ES provides information concerning the last recorded channel error. Channel errors can be caused by:

- A configuration error, that is:
 - An illegal setting in the transfer-control descriptor, or
 - An illegal priority register setting in fixed-arbitration
- An error termination to a bus master read or write cycle
- A cancel transfer with error bit that will be set when a transfer is canceled via the corresponding cancel transfer control bit

See [Fault reporting and handling](#) for more details.

Address: 4000_8000h base + 4h offset = 4000_8004h

| | | | | | | | | | | | | | | | | |
|-------|----------|-----|----|----|----|----|--------|-----|-----|-----|-----|-----|-----|-----|-----|-----|
| Bit | 31 | 30 | 29 | 28 | 27 | 26 | 25 | 24 | 23 | 22 | 21 | 20 | 19 | 18 | 17 | 16 |
| R | VLD | 0 | | | | | | | | | | | | | | ECX |
| W | Reserved | | | | | | | | | | | | | | | |
| Reset | 0 | 0 | 0 | 0 | 0 | 0 | 0 | 0 | 0 | 0 | 0 | 0 | 0 | 0 | 0 | 0 |
| Bit | 15 | 14 | 13 | 12 | 11 | 10 | 9 | 8 | 7 | 6 | 5 | 4 | 3 | 2 | 1 | 0 |
| R | 0 | CPE | 0 | | | | ERRCHN | SAE | SOE | DAE | DOE | NCE | SGE | SBE | DBE | |
| W | Reserved | | | | | | | | | | | | | | | |
| Reset | 0 | 0 | 0 | 0 | 0 | 0 | 0 | 0 | 0 | 0 | 0 | 0 | 0 | 0 | 0 | 0 |

DMA_ES field descriptions

| Field | Description |
|-------------------|---|
| 31 VLD | Logical OR of all ERR status bits 0 No ERR bits are set. 1 At least one ERR bit is set indicating a valid error exists that has not been cleared. |
| 30–17 Reserved | This field is reserved. This read-only field is reserved and always has the value 0. |
| 16 ECX | Transfer Canceled |

Table continues on the next page...

DMA_ES field descriptions (continued)

| Field | Description |
|-------------------|--|
| | 0 No canceled transfers 1 The last recorded entry was a canceled transfer by the error cancel transfer input |
| 15 Reserved | This field is reserved. This read-only field is reserved and always has the value 0. |
| 14 CPE | Channel Priority Error 0 No channel priority error 1 The last recorded error was a configuration error in the channel priorities . Channel priorities are not unique. |
| 13–10 Reserved | This field is reserved. This read-only field is reserved and always has the value 0. |
| 9–8 ERRCHN | Error Channel Number or Canceled Channel Number The channel number of the last recorded error, excluding CPE errors, or last recorded error canceled transfer. |
| 7 SAE | Source Address Error 0 No source address configuration error. 1 The last recorded error was a configuration error detected in the TCDn_SADDR field. TCDn_SADDR is inconsistent with TCDn_ATTR[SSIZE]. |
| 6 SOE | Source Offset Error 0 No source offset configuration error 1 The last recorded error was a configuration error detected in the TCDn_SOFF field. TCDn_SOFF is inconsistent with TCDn_ATTR[SSIZE]. |
| 5 DAE | Destination Address Error 0 No destination address configuration error 1 The last recorded error was a configuration error detected in the TCDn_DADDR field. TCDn_DADDR is inconsistent with TCDn_ATTR[DSIZE]. |
| 4 DOE | Destination Offset Error 0 No destination offset configuration error 1 The last recorded error was a configuration error detected in the TCDn_DOFF field. TCDn_DOFF is inconsistent with TCDn_ATTR[DSIZE]. |
| 3 NCE | NBYTES/CITER Configuration Error 0 No NBYTES/CITER configuration error 1 The last recorded error was a configuration error detected in the TCDn_NBYTES or TCDn_CITER fields. <ul style="list-style-type: none"> • TCDn_NBYTES is not a multiple of TCDn_ATTR[SSIZE] and TCDn_ATTR[DSIZE], or • TCDn_CITER[CITER] is equal to zero, or • TCDn_CITER[ELINK] is not equal to TCDn_BITER[ELINK] |
| 2 SGE | Scatter/Gather Configuration Error 0 No scatter/gather configuration error 1 The last recorded error was a configuration error detected in the TCDn_DLASTSGA field. This field is checked at the beginning of a scatter/gather operation after major loop completion if TCDn_CSR[ESG] is enabled. TCDn_DLASTSGA is not on a 32 byte boundary. |

Table continues on the next page...

DMA_ES field descriptions (continued)

| Field | Description |
|----------|---|
| 1 SBE | Source Bus Error 0 No source bus error 1 The last recorded error was a bus error on a source read |
| 0 DBE | Destination Bus Error 0 No destination bus error 1 The last recorded error was a bus error on a destination write |

24.3.7 Enable Request Register (DMA_ERQ)

The ERQ register provides a bit map for the 4 channels to enable the request signal for each channel. The state of any given channel enable is directly affected by writes to this register; it is also affected by writes to the SERQ and CERQ registers. These registers are provided so the request enable for a single channel can easily be modified without needing to perform a read-modify-write sequence to the ERQ.

DMA request input signals and this enable request flag must be asserted before a channel's hardware service request is accepted. The state of the DMA enable request flag does not affect a channel service request made explicitly through software or a linked channel request.

NOTE

Disable a channel's hardware service request at the source before clearing the channel's ERQ bit.

Address: 4000_8000h base + Ch offset = 4000_800Ch

| | | | | | | | | | | | | | | | | |
|-------|----|----|----|----|----|----|----|----|----|----|----|----|------|------|------|------|
| Bit | 31 | 30 | 29 | 28 | 27 | 26 | 25 | 24 | 23 | 22 | 21 | 20 | 19 | 18 | 17 | 16 |
| R | 0 | | | | | | | | | | | | | | | |
| W | | | | | | | | | | | | | | | | |
| Reset | 0 | 0 | 0 | 0 | 0 | 0 | 0 | 0 | 0 | 0 | 0 | 0 | 0 | 0 | 0 | 0 |
| Bit | 15 | 14 | 13 | 12 | 11 | 10 | 9 | 8 | 7 | 6 | 5 | 4 | 3 | 2 | 1 | 0 |
| R | 0 | | | | | | | | | | | | ERQ3 | ERQ2 | ERQ1 | ERQ0 |
| W | | | | | | | | | | | | | | | | |
| Reset | 0 | 0 | 0 | 0 | 0 | 0 | 0 | 0 | 0 | 0 | 0 | 0 | 0 | 0 | 0 | 0 |

DMA_ERQ field descriptions

| Field | Description |
|------------------|---|
| 31–4 Reserved | This field is reserved. This read-only field is reserved and always has the value 0. |

Table continues on the next page...

DMA_ERQ field descriptions (continued)

| Field | Description |
|-----------|---|
| 3 ERQ3 | Enable DMA Request 3 0 The DMA request signal for the corresponding channel is disabled 1 The DMA request signal for the corresponding channel is enabled |
| 2 ERQ2 | Enable DMA Request 2 0 The DMA request signal for the corresponding channel is disabled 1 The DMA request signal for the corresponding channel is enabled |
| 1 ERQ1 | Enable DMA Request 1 0 The DMA request signal for the corresponding channel is disabled 1 The DMA request signal for the corresponding channel is enabled |
| 0 ERQ0 | Enable DMA Request 0 0 The DMA request signal for the corresponding channel is disabled 1 The DMA request signal for the corresponding channel is enabled |

24.3.8 Enable Error Interrupt Register (DMA_EEI)

The EEI register provides a bit map for the 4 channels to enable the error interrupt signal for each channel. The state of any given channel’s error interrupt enable is directly affected by writes to this register; it is also affected by writes to the SEEI and CEEI. These registers are provided so that the error interrupt enable for a single channel can easily be modified without the need to perform a read-modify-write sequence to the EEI register.

The DMA error indicator and the error interrupt enable flag must be asserted before an error interrupt request for a given channel is asserted to the interrupt controller.

Address: 4000_8000h base + 14h offset = 4000_8014h

| | | | | | | | | | | | | | | | | | |
|-------|----------|----|----|----|----|----|----|----|--|----|----|----|----------|----------|----------|----------|----|
| Bit | 31 | 30 | 29 | 28 | 27 | 26 | 25 | 24 | | 23 | 22 | 21 | 20 | 19 | 18 | 17 | 16 |
| R | 0 | | | | | | | | | | | | | | | | |
| W | [Shaded] | | | | | | | | | | | | | | | | |
| Reset | 0 | 0 | 0 | 0 | 0 | 0 | 0 | 0 | | 0 | 0 | 0 | 0 | 0 | 0 | 0 | 0 |
| Bit | 15 | 14 | 13 | 12 | 11 | 10 | 9 | 8 | | 7 | 6 | 5 | 4 | 3 | 2 | 1 | 0 |
| R | 0 | | | | | | | | | | | | EEI3 | EEI2 | EEI1 | EEI0 | |
| W | [Shaded] | | | | | | | | | | | | [Shaded] | [Shaded] | [Shaded] | [Shaded] | |
| Reset | 0 | 0 | 0 | 0 | 0 | 0 | 0 | 0 | | 0 | 0 | 0 | 0 | 0 | 0 | 0 | 0 |

DMA_EEI field descriptions

| Field | Description |
|------------------|---|
| 31–4 Reserved | This field is reserved. This read-only field is reserved and always has the value 0. |
| 3 EEI3 | Enable Error Interrupt 3 0 The error signal for corresponding channel does not generate an error interrupt 1 The assertion of the error signal for corresponding channel generates an error interrupt request |
| 2 EEI2 | Enable Error Interrupt 2 0 The error signal for corresponding channel does not generate an error interrupt 1 The assertion of the error signal for corresponding channel generates an error interrupt request |
| 1 EEI1 | Enable Error Interrupt 1 0 The error signal for corresponding channel does not generate an error interrupt 1 The assertion of the error signal for corresponding channel generates an error interrupt request |
| 0 EEI0 | Enable Error Interrupt 0 0 The error signal for corresponding channel does not generate an error interrupt 1 The assertion of the error signal for corresponding channel generates an error interrupt request |

24.3.9 Clear Enable Error Interrupt Register (DMA_CEEI)

The CEEI provides a simple memory-mapped mechanism to clear a given bit in the EEI to disable the error interrupt for a given channel. The data value on a register write causes the corresponding bit in the EEI to be cleared. Setting the CAEE bit provides a global clear function, forcing the EEI contents to be cleared, disabling all DMA request inputs. If the NOP bit is set, the command is ignored. This allows you to write multiple-byte registers as a 32-bit word. Reads of this register return all zeroes.

Address: 4000_8000h base + 18h offset = 4000_8018h

| Bit | 7 | 6 | 5 | 4 | 3 | 2 | 1 | 0 |
|-------|-----|------|---|---|---|---|---|------|
| Read | 0 | 0 | | | | | | 0 |
| Write | NOP | CAEE | | | 0 | | | CEEI |
| Reset | 0 | 0 | 0 | 0 | 0 | 0 | 0 | 0 |

DMA_CEEI field descriptions

| Field | Description |
|----------|--|
| 7 NOP | No Op enable 0 Normal operation 1 No operation, ignore the other bits in this register |

Table continues on the next page...

DMA_CEEI field descriptions (continued)

| Field | Description |
|-----------------|--|
| 6 CAEE | Clear All Enable Error Interrupts 0 Clear only the EEI bit specified in the CEEI field 1 Clear all bits in EEI |
| 5–2 Reserved | This field is reserved. |
| CEEI | Clear Enable Error Interrupt Clears the corresponding bit in EEI |

24.3.10 Set Enable Error Interrupt Register (DMA_SEEI)

The SEEI provides a simple memory-mapped mechanism to set a given bit in the EEI to enable the error interrupt for a given channel. The data value on a register write causes the corresponding bit in the EEI to be set. Setting the SAEI bit provides a global set function, forcing the entire EEI contents to be set. If the NOP bit is set, the command is ignored. This allows you to write multiple-byte registers as a 32-bit word. Reads of this register return all zeroes.

Address: 4000_8000h base + 19h offset = 4000_8019h

| Bit | 7 | 6 | 5 | 4 | 3 | 2 | 1 | 0 |
|-------|-----|------|---|---|---|---|------|---|
| Read | 0 | 0 | | | | | 0 | |
| Write | NOP | SAEE | 0 | | | | SEEI | |
| Reset | 0 | 0 | 0 | 0 | 0 | 0 | 0 | 0 |

DMA_SEEI field descriptions

| Field | Description |
|-----------------|---|
| 7 NOP | No Op enable 0 Normal operation 1 No operation, ignore the other bits in this register |
| 6 SAEE | Sets All Enable Error Interrupts 0 Set only the EEI bit specified in the SEEI field. 1 Sets all bits in EEI |
| 5–2 Reserved | This field is reserved. |
| SEEI | Set Enable Error Interrupt Sets the corresponding bit in EEI |

24.3.11 Clear Enable Request Register (DMA_CERQ)

The CERQ provides a simple memory-mapped mechanism to clear a given bit in the ERQ to disable the DMA request for a given channel. The data value on a register write causes the corresponding bit in the ERQ to be cleared. Setting the CAER bit provides a global clear function, forcing the entire contents of the ERQ to be cleared, disabling all DMA request inputs. If NOP is set, the command is ignored. This allows you to write multiple-byte registers as a 32-bit word. Reads of this register return all zeroes.

NOTE

Disable a channel's hardware service request at the source before clearing the channel's ERQ bit.

Address: 4000_8000h base + 1Ah offset = 4000_801Ah

| Bit | 7 | 6 | 5 | 4 | 3 | 2 | 1 | 0 |
|-------|-----|------|---|---|---|---|------|---|
| Read | 0 | 0 | | | | | 0 | |
| Write | NOP | CAER | 0 | | | | CERQ | |
| Reset | 0 | 0 | 0 | 0 | 0 | 0 | 0 | 0 |

DMA_CERQ field descriptions

| Field | Description |
|-----------------|--|
| 7 NOP | No Op enable 0 Normal operation 1 No operation, ignore the other bits in this register |
| 6 CAER | Clear All Enable Requests 0 Clear only the ERQ bit specified in the CERQ field 1 Clear all bits in ERQ |
| 5-2 Reserved | This field is reserved. |
| CERQ | Clear Enable Request Clears the corresponding bit in ERQ. |

24.3.12 Set Enable Request Register (DMA_SERQ)

The SERQ provides a simple memory-mapped mechanism to set a given bit in the ERQ to enable the DMA request for a given channel. The data value on a register write causes the corresponding bit in the ERQ to be set. Setting the SAER bit provides a global set function, forcing the entire contents of ERQ to be set. If the NOP bit is set, the command is ignored. This allows you to write multiple-byte registers as a 32-bit word. Reads of this register return all zeroes.

Address: 4000_8000h base + 1Bh offset = 4000_801Bh

| | | | | | | | | |
|-------|-----|------|---|---|---|---|------|---|
| Bit | 7 | 6 | 5 | 4 | 3 | 2 | 1 | 0 |
| Read | 0 | 0 | | | | | 0 | |
| Write | NOP | SAER | 0 | | | | SERQ | |
| Reset | 0 | 0 | 0 | 0 | 0 | 0 | 0 | 0 |

DMA_SERQ field descriptions

| Field | Description |
|-----------------|--|
| 7 NOP | No Op enable 0 Normal operation 1 No operation, ignore the other bits in this register |
| 6 SAER | Set All Enable Requests 0 Set only the ERQ bit specified in the SERQ field 1 Set all bits in ERQ |
| 5-2 Reserved | This field is reserved. |
| SERQ | Set Enable Request Sets the corresponding bit in ERQ. |

24.3.13 Clear DONE Status Bit Register (DMA_CDNE)

The CDNE provides a simple memory-mapped mechanism to clear the DONE bit in the TCD of the given channel. The data value on a register write causes the DONE bit in the corresponding transfer control descriptor to be cleared. Setting the CADN bit provides a global clear function, forcing all DONE bits to be cleared. If the NOP bit is set, the command is ignored. This allows you to write multiple-byte registers as a 32-bit word. Reads of this register return all zeroes.

Address: 4000_8000h base + 1Ch offset = 4000_801Ch

| | | | | | | | | |
|-------|-----|------|---|---|---|---|------|---|
| Bit | 7 | 6 | 5 | 4 | 3 | 2 | 1 | 0 |
| Read | 0 | 0 | | | | | 0 | |
| Write | NOP | CADN | 0 | | | | CDNE | |
| Reset | 0 | 0 | 0 | 0 | 0 | 0 | 0 | 0 |

DMA_CDNE field descriptions

| Field | Description |
|-----------------|---|
| 7 NOP | No Op enable 0 Normal operation 1 No operation, ignore the other bits in this register |
| 6 CADN | Clears All DONE Bits 0 Clears only the TCDn_CSR[DONE] bit specified in the CDNE field 1 Clears all bits in TCDn_CSR[DONE] |
| 5–2 Reserved | This field is reserved. |
| CDNE | Clear DONE Bit Clears the corresponding bit in TCDn_CSR[DONE] |

24.3.14 Set START Bit Register (DMA_SSRT)

The SSRT provides a simple memory-mapped mechanism to set the START bit in the TCD of the given channel. The data value on a register write causes the START bit in the corresponding transfer control descriptor to be set. Setting the SAST bit provides a global set function, forcing all START bits to be set. If the NOP bit is set, the command is ignored. This allows you to write multiple-byte registers as a 32-bit word. Reads of this register return all zeroes.

Address: 4000_8000h base + 1Dh offset = 4000_801Dh

| | | | | | | | | |
|-------|-----|------|---|---|---|---|------|---|
| Bit | 7 | 6 | 5 | 4 | 3 | 2 | 1 | 0 |
| Read | 0 | 0 | | | | | 0 | |
| Write | NOP | SAST | 0 | | | | SSRT | |
| Reset | 0 | 0 | 0 | 0 | 0 | 0 | 0 | 0 |

DMA_SSRT field descriptions

| Field | Description |
|-----------------|--|
| 7 NOP | No Op enable 0 Normal operation 1 No operation, ignore the other bits in this register |
| 6 SAST | Set All START Bits (activates all channels) 0 Set only the TCDn_CSR[START] bit specified in the SSRT field 1 Set all bits in TCDn_CSR[START] |
| 5–2 Reserved | This field is reserved. |
| SSRT | Set START Bit Sets the corresponding bit in TCDn_CSR[START] |

24.3.15 Clear Error Register (DMA_CERR)

The CERR provides a simple memory-mapped mechanism to clear a given bit in the ERR to disable the error condition flag for a given channel. The given value on a register write causes the corresponding bit in the ERR to be cleared. Setting the CAEI bit provides a global clear function, forcing the ERR contents to be cleared, clearing all channel error indicators. If the NOP bit is set, the command is ignored. This allows you to write multiple-byte registers as a 32-bit word. Reads of this register return all zeroes.

Address: 4000_8000h base + 1Eh offset = 4000_801Eh

| | | | | | | | | |
|-------|-----|------|---|---|---|---|------|---|
| Bit | 7 | 6 | 5 | 4 | 3 | 2 | 1 | 0 |
| Read | 0 | 0 | | | | | 0 | |
| Write | NOP | CAEI | 0 | | | | CERR | |
| Reset | 0 | 0 | 0 | 0 | 0 | 0 | 0 | 0 |

DMA_CERR field descriptions

| Field | Description |
|-----------------|---|
| 7 NOP | No Op enable 0 Normal operation 1 No operation, ignore the other bits in this register |
| 6 CAEI | Clear All Error Indicators 0 Clear only the ERR bit specified in the CERR field 1 Clear all bits in ERR |
| 5–2 Reserved | This field is reserved. |
| CERR | Clear Error Indicator Clears the corresponding bit in ERR |

24.3.16 Clear Interrupt Request Register (DMA_CINT)

The CINT provides a simple, memory-mapped mechanism to clear a given bit in the INT to disable the interrupt request for a given channel. The given value on a register write causes the corresponding bit in the INT to be cleared. Setting the CAIR bit provides a global clear function, forcing the entire contents of the INT to be cleared, disabling all DMA interrupt requests. If the NOP bit is set, the command is ignored. This allows you to write multiple-byte registers as a 32-bit word. Reads of this register return all zeroes.

Address: 4000_8000h base + 1Fh offset = 4000_801Fh

| | | | | | | | | |
|-------|-----|------|---|---|---|---|---|------|
| Bit | 7 | 6 | 5 | 4 | 3 | 2 | 1 | 0 |
| Read | 0 | 0 | | | | | | 0 |
| Write | NOP | CAIR | | | 0 | | | CINT |
| Reset | 0 | 0 | 0 | 0 | 0 | 0 | 0 | 0 |

DMA_CINT field descriptions

| Field | Description |
|-----------------|---|
| 7 NOP | No Op enable 0 Normal operation 1 No operation, ignore the other bits in this register |
| 6 CAIR | Clear All Interrupt Requests 0 Clear only the INT bit specified in the CINT field 1 Clear all bits in INT |
| 5–2 Reserved | This field is reserved. |
| CINT | Clear Interrupt Request Clears the corresponding bit in INT |

24.3.17 Interrupt Request Register (DMA_INT)

The INT register provides a bit map for the 4 channels signaling the presence of an interrupt request for each channel. Depending on the appropriate bit setting in the transfer-control descriptors, the eDMA engine generates an interrupt on data transfer completion. The outputs of this register are directly routed to the interrupt controller. During the interrupt-service routine associated with any given channel, it is the software's responsibility to clear the appropriate bit, negating the interrupt request. Typically, a write to the CINT register in the interrupt service routine is used for this purpose.

The state of any given channel's interrupt request is directly affected by writes to this register; it is also affected by writes to the CINT register. On writes to INT, a 1 in any bit position clears the corresponding channel's interrupt request. A zero in any bit position has no effect on the corresponding channel's current interrupt status. The CINT register is provided so the interrupt request for a single channel can easily be cleared without the need to perform a read-modify-write sequence to the INT register.

Address: 4000_8000h base + 24h offset = 4000_8024h

| | | | | | | | | | | | | | | | | |
|-------|----------|----|----|----|----|----|----|----|----|----|----|----|------|------|------|------|
| Bit | 31 | 30 | 29 | 28 | 27 | 26 | 25 | 24 | 23 | 22 | 21 | 20 | 19 | 18 | 17 | 16 |
| R | 0 | | | | | | | | | | | | | | | |
| W | [Shaded] | | | | | | | | | | | | | | | |
| Reset | 0 | 0 | 0 | 0 | 0 | 0 | 0 | 0 | 0 | 0 | 0 | 0 | 0 | 0 | 0 | 0 |
| Bit | 15 | 14 | 13 | 12 | 11 | 10 | 9 | 8 | 7 | 6 | 5 | 4 | 3 | 2 | 1 | 0 |
| R | 0 | | | | | | | | | | | | INT3 | INT2 | INT1 | INT0 |
| W | [Shaded] | | | | | | | | | | | | w1c | w1c | w1c | w1c |
| Reset | 0 | 0 | 0 | 0 | 0 | 0 | 0 | 0 | 0 | 0 | 0 | 0 | 0 | 0 | 0 | 0 |

DMA_INT field descriptions

| Field | Description |
|------------------|--|
| 31–4 Reserved | This field is reserved. This read-only field is reserved and always has the value 0. |
| 3 INT3 | Interrupt Request 3 0 The interrupt request for corresponding channel is cleared 1 The interrupt request for corresponding channel is active |
| 2 INT2 | Interrupt Request 2 0 The interrupt request for corresponding channel is cleared 1 The interrupt request for corresponding channel is active |
| 1 INT1 | Interrupt Request 1 |

Table continues on the next page...

DMA_INT field descriptions (continued)

| Field | Description |
|-----------|--|
| | 0 The interrupt request for corresponding channel is cleared 1 The interrupt request for corresponding channel is active |
| 0 INT0 | Interrupt Request 0 0 The interrupt request for corresponding channel is cleared 1 The interrupt request for corresponding channel is active |

24.3.18 Error Register (DMA_ERR)

The ERR provides a bit map for the 4 channels, signaling the presence of an error for each channel. The eDMA engine signals the occurrence of an error condition by setting the appropriate bit in this register. The outputs of this register are enabled by the contents of the EEI, and then routed to the interrupt controller. During the execution of the interrupt-service routine associated with any DMA errors, it is software’s responsibility to clear the appropriate bit, negating the error-interrupt request. Typically, a write to the CERR in the interrupt-service routine is used for this purpose. The normal DMA channel completion indicators (setting the transfer control descriptor DONE flag and the possible assertion of an interrupt request) are not affected when an error is detected.

The contents of this register can also be polled because a non-zero value indicates the presence of a channel error regardless of the state of the EEI. The state of any given channel’s error indicators is affected by writes to this register; it is also affected by writes to the CERR. On writes to the ERR, a one in any bit position clears the corresponding channel’s error status. A zero in any bit position has no affect on the corresponding channel’s current error status. The CERR is provided so the error indicator for a single channel can easily be cleared.

Address: 4000_8000h base + 2Ch offset = 4000_802Ch

| | | | | | | | | | | | | | | | | | |
|-------|----------|----|----|----|----|----|----|----|--|----|----|----|------|------|------|------|----|
| Bit | 31 | 30 | 29 | 28 | 27 | 26 | 25 | 24 | | 23 | 22 | 21 | 20 | 19 | 18 | 17 | 16 |
| R | 0 | | | | | | | | | | | | | | | | |
| W | [Shaded] | | | | | | | | | | | | | | | | |
| Reset | 0 | 0 | 0 | 0 | 0 | 0 | 0 | 0 | | 0 | 0 | 0 | 0 | 0 | 0 | 0 | 0 |
| Bit | 15 | 14 | 13 | 12 | 11 | 10 | 9 | 8 | | 7 | 6 | 5 | 4 | 3 | 2 | 1 | 0 |
| R | 0 | | | | | | | | | | | | ERR3 | ERR2 | ERR1 | ERR0 | |
| W | [Shaded] | | | | | | | | | | | | w1c | w1c | w1c | w1c | |
| Reset | 0 | 0 | 0 | 0 | 0 | 0 | 0 | 0 | | 0 | 0 | 0 | 0 | 0 | 0 | 0 | 0 |

DMA_ERR field descriptions

| Field | Description |
|------------------|--|
| 31–4 Reserved | This field is reserved. This read-only field is reserved and always has the value 0. |
| 3 ERR3 | Error In Channel 3 0 An error in this channel has not occurred 1 An error in this channel has occurred |
| 2 ERR2 | Error In Channel 2 0 An error in this channel has not occurred 1 An error in this channel has occurred |
| 1 ERR1 | Error In Channel 1 0 An error in this channel has not occurred 1 An error in this channel has occurred |
| 0 ERR0 | Error In Channel 0 0 An error in this channel has not occurred 1 An error in this channel has occurred |

24.3.19 Hardware Request Status Register (DMA_HRS)

The HRS register provides a bit map for the DMA channels, signaling the presence of a hardware request for each channel. The hardware request status bits reflect the current state of the register and qualified (via the ERQ fields) DMA request signals as seen by the DMA's arbitration logic. This view into the hardware request signals may be used for debug purposes.

NOTE

These bits reflect the state of the request as seen by the arbitration logic. Therefore, this status is affected by the ERQ bits.

Address: 4000_8000h base + 34h offset = 4000_8034h

| | | | | | | | | | | | | | | | | | |
|-------|----------|----|----|----|----|----|----|----|--|----|----|----|----------|----------|----------|----------|----|
| Bit | 31 | 30 | 29 | 28 | 27 | 26 | 25 | 24 | | 23 | 22 | 21 | 20 | 19 | 18 | 17 | 16 |
| R | 0 | | | | | | | | | | | | | | | | |
| W | [Shaded] | | | | | | | | | | | | | | | | |
| Reset | 0 | 0 | 0 | 0 | 0 | 0 | 0 | 0 | | 0 | 0 | 0 | 0 | 0 | 0 | 0 | 0 |
| Bit | 15 | 14 | 13 | 12 | 11 | 10 | 9 | 8 | | 7 | 6 | 5 | 4 | 3 | 2 | 1 | 0 |
| R | 0 | | | | | | | | | | | | HRS3 | HRS2 | HRS1 | HRS0 | |
| W | [Shaded] | | | | | | | | | | | | [Shaded] | [Shaded] | [Shaded] | [Shaded] | |
| Reset | 0 | 0 | 0 | 0 | 0 | 0 | 0 | 0 | | 0 | 0 | 0 | 0 | 0 | 0 | 0 | 0 |

DMA_HRS field descriptions

| Field | Description |
|------------------|--|
| 31–4 Reserved | This field is reserved. This read-only field is reserved and always has the value 0. |
| 3 HRS3 | Hardware Request Status Channel 3 The HRS bit for its respective channel remains asserted for the period when a Hardware Request is Present on the Channel. After the Request is completed and Channel is free, the HRS bit is automatically cleared by hardware. 0 A hardware service request for channel 3 is not present 1 A hardware service request for channel 3 is present |
| 2 HRS2 | Hardware Request Status Channel 2 The HRS bit for its respective channel remains asserted for the period when a Hardware Request is Present on the Channel. After the Request is completed and Channel is free, the HRS bit is automatically cleared by hardware. 0 A hardware service request for channel 2 is not present 1 A hardware service request for channel 2 is present |
| 1 HRS1 | Hardware Request Status Channel 1 The HRS bit for its respective channel remains asserted for the period when a Hardware Request is Present on the Channel. After the Request is completed and Channel is free, the HRS bit is automatically cleared by hardware. 0 A hardware service request for channel 1 is not present 1 A hardware service request for channel 1 is present |
| 0 HRS0 | Hardware Request Status Channel 0 The HRS bit for its respective channel remains asserted for the period when a Hardware Request is Present on the Channel. After the Request is completed and Channel is free, the HRS bit is automatically cleared by hardware. 0 A hardware service request for channel 0 is not present 1 A hardware service request for channel 0 is present |

24.3.20 Enable Asynchronous Request in Stop Register (DMA_EARS)

Address: 4000_8000h base + 44h offset = 4000_8044h

| | | | | | | | | | | | | | | | | | |
|-------|------------|----|----|----|----|----|----|----|--|----|----|----|---------|---------|---------|---------|----|
| Bit | 31 | 30 | 29 | 28 | 27 | 26 | 25 | 24 | | 23 | 22 | 21 | 20 | 19 | 18 | 17 | 16 |
| R | 0 | | | | | | | | | | | | | | | | |
| W | [Reserved] | | | | | | | | | | | | | | | | |
| Reset | 0 | 0 | 0 | 0 | 0 | 0 | 0 | 0 | | 0 | 0 | 0 | 0 | 0 | 0 | 0 | 0 |
| Bit | 15 | 14 | 13 | 12 | 11 | 10 | 9 | 8 | | 7 | 6 | 5 | 4 | 3 | 2 | 1 | 0 |
| R | 0 | | | | | | | | | | | | EDREQ_3 | EDREQ_2 | EDREQ_1 | EDREQ_0 | |
| W | [Reserved] | | | | | | | | | | | | | | | | |
| Reset | 0 | 0 | 0 | 0 | 0 | 0 | 0 | 0 | | 0 | 0 | 0 | 0 | 0 | 0 | 0 | 0 |

DMA_EARS field descriptions

| Field | Description |
|------------------|--|
| 31–4 Reserved | This field is reserved. This read-only field is reserved and always has the value 0. |
| 3 EDREQ_3 | Enable asynchronous DMA request in stop mode for channel 3. 0 Disable asynchronous DMA request for channel 3. 1 Enable asynchronous DMA request for channel 3. |
| 2 EDREQ_2 | Enable asynchronous DMA request in stop mode for channel 2. 0 Disable asynchronous DMA request for channel 2. 1 Enable asynchronous DMA request for channel 2. |
| 1 EDREQ_1 | Enable asynchronous DMA request in stop mode for channel 1. 0 Disable asynchronous DMA request for channel 1 1 Enable asynchronous DMA request for channel 1. |
| 0 EDREQ_0 | Enable asynchronous DMA request in stop mode for channel 0. 0 Disable asynchronous DMA request for channel 0. 1 Enable asynchronous DMA request for channel 0. |

24.3.21 Channel n Priority Register (DMA_DCHPRIn)

When fixed-priority channel arbitration is enabled (CR[ERCA] = 0), the contents of these registers define the unique priorities associated with each channel. The channel priorities are evaluated by numeric value; for example, 0 is the lowest priority, 1 is the next higher priority, then 2, 3, etc. Software must program the channel priorities with unique values; otherwise, a configuration error is reported. The range of the priority value is limited to the values of 0 through 3.

Address: 4000_8000h base + 100h offset + (1d × i), where i=0d to 3d

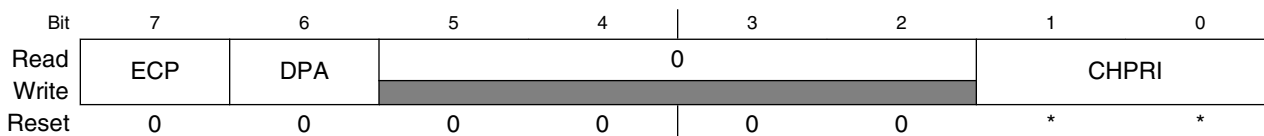

* Notes:

- CHPRI field: See bit field description.

DMA_DCHPRIn field descriptions

| Field | Description |
|-----------------|---|
| 7 ECP | Enable Channel Preemption. 0 Channel n cannot be suspended by a higher priority channel's service request. 1 Channel n can be temporarily suspended by the service request of a higher priority channel. |
| 6 DPA | Disable Preempt Ability. 0 Channel n can suspend a lower priority channel. 1 Channel n cannot suspend any channel, regardless of channel priority. |
| 5-2 Reserved | This field is reserved. This read-only field is reserved and always has the value 0. |
| CHPRI | Channel n Arbitration Priority Channel priority when fixed-priority arbitration is enabled NOTE: Reset value for the channel priority field, CHPRI, is equal to the corresponding channel number for each priority register, that is, DCHPRI3[CHPRI] = 0b11. |

24.3.22 TCD Source Address (DMA_TCDn_SADDR)

Address: 4000_8000h base + 1000h offset + (32d × i), where i=0d to 3d

| | | | | | | | | | | | | | | | | | | | | | | | | | | | | | | | | |
|-------|----|----|----|----|----|----|----|----|----|----|----|----|----|----|----|----|----|----|----|----|----|----|----|----|----|----|----|----|----|----|----|----|
| Bit | 31 | 30 | 29 | 28 | 27 | 26 | 25 | 24 | 23 | 22 | 21 | 20 | 19 | 18 | 17 | 16 | 15 | 14 | 13 | 12 | 11 | 10 | 9 | 8 | 7 | 6 | 5 | 4 | 3 | 2 | 1 | 0 |
| R | | | | | | | | | | | | | | | | | | | | | | | | | | | | | | | | |
| W | | | | | | | | | | | | | | | | | | | | | | | | | | | | | | | | |
| Reset | x* | x* | x* | x* | x* | x* | x* | x* | x* | x* | x* | x* | x* | x* | x* | x* | x* | x* | x* | x* | x* | x* | x* | x* | x* | x* | x* | x* | x* | x* | x* | x* |

* Notes:

- x = Undefined at reset.

DMA_TCDn_SADDR field descriptions

| Field | Description |
|-------|---|
| SADDR | Source Address Memory address pointing to the source data. |

24.3.23 TCD Signed Source Address Offset (DMA_TCDn_SOFF)

Address: 4000_8000h base + 1004h offset + (32d × i), where i=0d to 3d

| | | | | | | | | | | | | | | | | |
|-------|----|----|----|----|----|----|----|----|----|----|----|----|----|----|----|----|
| Bit | 15 | 14 | 13 | 12 | 11 | 10 | 9 | 8 | 7 | 6 | 5 | 4 | 3 | 2 | 1 | 0 |
| Read | | | | | | | | | | | | | | | | |
| Write | | | | | | | | | | | | | | | | |
| Reset | x* | x* | x* | x* | x* | x* | x* | x* | x* | x* | x* | x* | x* | x* | x* | x* |

* Notes:

- x = Undefined at reset.

DMA_TCDn_SOFF field descriptions

| Field | Description |
|-------|---|
| SOFF | Source address signed offset Sign-extended offset applied to the current source address to form the next-state value as each source read is completed. |

24.3.24 TCD Transfer Attributes (DMA_TCDn_ATTR)

Address: 4000_8000h base + 1006h offset + (32d × i), where i=0d to 3d

| Bit | 15 | 14 | 13 | 12 | 11 | 10 | 9 | 8 | 7 | 6 | 5 | 4 | 3 | 2 | 1 | 0 | | | | |
|-------|------|----|----|----|----|----|----|----|-------|----|----|----|------|----|----|----|-------|--|--|--|
| Read | SMOD | | | | | | | | SSIZE | | | | DMOD | | | | DSIZE | | | |
| Write | | | | | | | | | | | | | | | | | | | | |
| Reset | x* | x* | x* | x* | x* | x* | x* | x* | x* | x* | x* | x* | x* | x* | x* | x* | | | | |

* Notes:

- x = Undefined at reset.

DMA_TCDn_ATTR field descriptions

| Field | Description |
|---------------|--|
| 15–11 SMOD | <p>Source Address Modulo</p> <p>0 Source address modulo feature is disabled</p> <p>≠0 This value defines a specific address range specified to be the value after SADDR + SOFF calculation is performed on the original register value. Setting this field provides the ability to implement a circular data queue easily. For data queues requiring power-of-2 size bytes, the queue should start at a 0-modulo-size address and the SMOD field should be set to the appropriate value for the queue, freezing the desired number of upper address bits. The value programmed into this field specifies the number of lower address bits allowed to change. For a circular queue application, the SOFF is typically set to the transfer size to implement post-increment addressing with the SMOD function constraining the addresses to a 0-modulo-size range.</p> |
| 10–8 SSIZE | <p>Source data transfer size</p> <p>NOTE: Using a Reserved value causes a configuration error.</p> <p>The eDMA defaults to privileged data access for all transactions.</p> <p>000 8-bit</p> <p>001 16-bit</p> <p>010 32-bit</p> <p>011 Reserved</p> <p>100 16-byte</p> <p>101 32-byte</p> <p>110 Reserved</p> <p>111 Reserved</p> |
| 7–3 DMOD | <p>Destination Address Modulo</p> <p>See the SMOD definition</p> |
| DSIZE | <p>Destination data transfer size</p> <p>See the SSIZE definition</p> |

24.3.25 TCD Minor Byte Count (Minor Loop Mapping Disabled) (DMA_TCDn_NBYTES_MLNO)

This register, or one of the next two registers (TCD_NBYTES_MLOFFNO, TCD_NBYTES_MLOFFYES), defines the number of bytes to transfer per request. Which register to use depends on whether minor loop mapping is disabled, enabled but not used for this channel, or enabled and used.

TCD word 2 is defined as follows if:

- Minor loop mapping is disabled (CR[EMLM] = 0)

If minor loop mapping is enabled, see the TCD_NBYTES_MLOFFNO and TCD_NBYTES_MLOFFYES register descriptions for the definition of TCD word 2.

Address: 4000_8000h base + 1008h offset + (32d × i), where i=0d to 3d

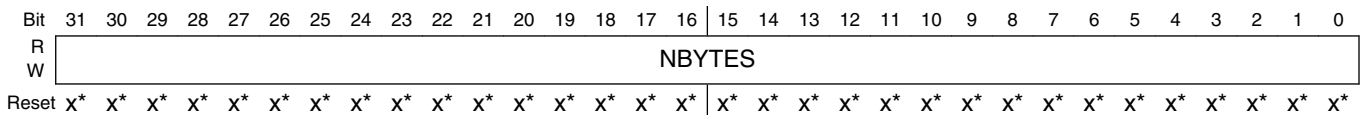

* Notes:

- x = Undefined at reset.

DMA_TCDn_NBYTES_MLNO field descriptions

| Field | Description |
|--------|--|
| NBYTES | <p>Minor Byte Transfer Count</p> <p>Number of bytes to be transferred in each service request of the channel. As a channel activates, the appropriate TCD contents load into the eDMA engine, and the appropriate reads and writes perform until the minor byte transfer count has transferred. This is an indivisible operation and cannot be halted. It can, however, be stalled by using the bandwidth control field, or via preemption. After the minor count is exhausted, the SADDR and DADDR values are written back into the TCD memory, the major iteration count is decremented and restored to the TCD memory. If the major iteration count is completed, additional processing is performed.</p> <p>NOTE: An NBYTES value of 0x0000_0000 is interpreted as a 4 GB transfer.</p> |

24.3.26 TCD Signed Minor Loop Offset (Minor Loop Mapping Enabled and Offset Disabled) (DMA_TCDn_NBYTES_MLOFFNO)

One of three registers (this register, TCD_NBYTES_MLNO, or TCD_NBYTES_MLOFFYES), defines the number of bytes to transfer per request. Which register to use depends on whether minor loop mapping is disabled, enabled but not used for this channel, or enabled and used.

Memory map/register definition

TCD word 2 is defined as follows if:

- Minor loop mapping is enabled (CR[EMLM] = 1) and
- SMLOE = 0 and DMLOE = 0

If minor loop mapping is enabled and SMLOE or DMLOE is set, then refer to the TCD_NBYTES_MLOFFYES register description. If minor loop mapping is disabled, then refer to the TCD_NBYTES_MLNO register description.

Address: 4000_8000h base + 1008h offset + (32d × i), where i=0d to 3d

| | | | | | | | | | | | | | | | | |
|-------|--------|-------|--------|----|----|----|----|----|----|----|----|----|----|----|----|----|
| Bit | 31 | 30 | 29 | 28 | 27 | 26 | 25 | 24 | 23 | 22 | 21 | 20 | 19 | 18 | 17 | 16 |
| R | | | NBYTES | | | | | | | | | | | | | |
| W | SMLOE | DMLOE | | | | | | | | | | | | | | |
| Reset | x* | x* | x* | x* | x* | x* | x* | x* | x* | x* | x* | x* | x* | x* | x* | x* |
| Bit | 15 | 14 | 13 | 12 | 11 | 10 | 9 | 8 | 7 | 6 | 5 | 4 | 3 | 2 | 1 | 0 |
| R | NBYTES | | | | | | | | | | | | | | | |
| W | | | | | | | | | | | | | | | | |
| Reset | x* | x* | x* | x* | x* | x* | x* | x* | x* | x* | x* | x* | x* | x* | x* | x* |

* Notes:

- x = Undefined at reset.

DMA_TCDn_NBYTES_MLOFFNO field descriptions

| Field | Description |
|-------------|--|
| 31 SMLOE | Source Minor Loop Offset Enable Selects whether the minor loop offset is applied to the source address upon minor loop completion. 0 The minor loop offset is not applied to the SADDR 1 The minor loop offset is applied to the SADDR |
| 30 DMLOE | Destination Minor Loop Offset enable Selects whether the minor loop offset is applied to the destination address upon minor loop completion. 0 The minor loop offset is not applied to the DADDR 1 The minor loop offset is applied to the DADDR |
| NBYTES | Minor Byte Transfer Count Number of bytes to be transferred in each service request of the channel. As a channel activates, the appropriate TCD contents load into the eDMA engine, and the appropriate reads and writes perform until the minor byte transfer count has transferred. This is an indivisible operation and cannot be halted. It can, however, be stalled by using the bandwidth control field, or via preemption. After the minor count is exhausted, the SADDR and DADDR values are written back into the TCD memory, the major iteration count is decremented and restored to the TCD memory. If the major iteration count is completed, additional processing is performed. |

24.3.27 TCD Signed Minor Loop Offset (Minor Loop Mapping and Offset Enabled) (DMA_TCDn_NBYTES_MLOFFYES)

One of three registers (this register, TCD_NBYTES_MLNO, or TCD_NBYTES_MLOFFNO), defines the number of bytes to transfer per request. Which register to use depends on whether minor loop mapping is disabled, enabled but not used for this channel, or enabled and used.

TCD word 2 is defined as follows if:

- Minor loop mapping is enabled (CR[EMLM] = 1) and
- Minor loop offset is enabled (SMLOE or DMLOE = 1)

If minor loop mapping is enabled and SMLOE and DMLOE are cleared, then refer to the TCD_NBYTES_MLOFFNO register description. If minor loop mapping is disabled, then refer to the TCD_NBYTES_MLNO register description.

Address: 4000_8000h base + 1008h offset + (32d × i), where i=0d to 3d

| | | | | | | | | | | | | | | | | | |
|-------|-------|-------|-------|----|----|----|----|--------|----|----|----|----|----|----|----|----|----|
| Bit | 31 | 30 | 29 | 28 | 27 | 26 | 25 | 24 | 23 | 22 | 21 | 20 | 19 | 18 | 17 | 16 | |
| R | | | | | | | | | | | | | | | | | |
| W | SMLOE | DMLOE | MLOFF | | | | | | | | | | | | | | |
| Reset | x* | x* | x* | x* | x* | x* | x* | x* | x* | x* | x* | x* | x* | x* | x* | x* | x* |
| Bit | 15 | 14 | 13 | 12 | 11 | 10 | 9 | 8 | 7 | 6 | 5 | 4 | 3 | 2 | 1 | 0 | |
| R | MLOFF | | | | | | | NBYTES | | | | | | | | | |
| W | MLOFF | | | | | | | NBYTES | | | | | | | | | |
| Reset | x* | x* | x* | x* | x* | x* | x* | x* | x* | x* | x* | x* | x* | x* | x* | x* | x* |

* Notes:

- x = Undefined at reset.

DMA_TCDn_NBYTES_MLOFFYES field descriptions

| Field | Description |
|-------------|---|
| 31 SMLOE | Source Minor Loop Offset Enable Selects whether the minor loop offset is applied to the source address upon minor loop completion. 0 The minor loop offset is not applied to the SADDR 1 The minor loop offset is applied to the SADDR |
| 30 DMLOE | Destination Minor Loop Offset enable Selects whether the minor loop offset is applied to the destination address upon minor loop completion. |

Table continues on the next page...

DMA_TCDn_NBYTES_MLOFFYES field descriptions (continued)

| Field | Description |
|-------------|--|
| | 0 The minor loop offset is not applied to the DADDR 1 The minor loop offset is applied to the DADDR |
| 29–10 MLOFF | If SMLOE or DMLOE is set, this field represents a sign-extended offset applied to the source or destination address to form the next-state value after the minor loop completes. |
| NBYTES | Minor Byte Transfer Count Number of bytes to be transferred in each service request of the channel. As a channel activates, the appropriate TCD contents load into the eDMA engine, and the appropriate reads and writes perform until the minor byte transfer count has transferred. This is an indivisible operation and cannot be halted. It can, however, be stalled by using the bandwidth control field, or via preemption. After the minor count is exhausted, the SADDR and DADDR values are written back into the TCD memory, the major iteration count is decremented and restored to the TCD memory. If the major iteration count is completed, additional processing is performed. |

24.3.28 TCD Last Source Address Adjustment (DMA_TCDn_SLAST)

Address: 4000_8000h base + 100Ch offset + (32d × i), where i=0d to 3d

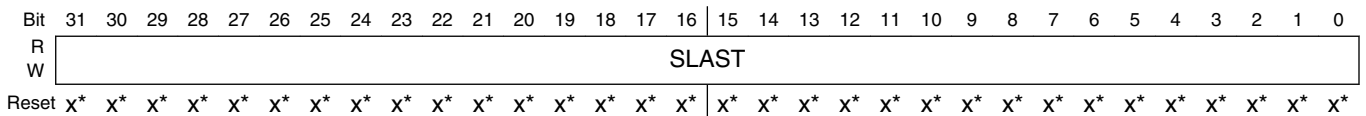

- * Notes:
- x = Undefined at reset.

DMA_TCDn_SLAST field descriptions

| Field | Description |
|-------|--|
| SLAST | Last Source Address Adjustment Adjustment value added to the source address at the completion of the major iteration count. This value can be applied to restore the source address to the initial value, or adjust the address to reference the next data structure. This register uses two's complement notation; the overflow bit is discarded. |

24.3.29 TCD Destination Address (DMA_TCDn_DADDR)

Address: 4000_8000h base + 1010h offset + (32d × i), where i=0d to 3d

| | | | | | | | | | | | | | | | | | | | | | | | | | | | | | | | | | |
|-------|----|----|----|----|----|----|----|----|----|----|----|----|----|----|----|----|--|----|----|----|----|----|----|----|----|----|----|----|----|----|----|----|----|
| Bit | 31 | 30 | 29 | 28 | 27 | 26 | 25 | 24 | 23 | 22 | 21 | 20 | 19 | 18 | 17 | 16 | | 15 | 14 | 13 | 12 | 11 | 10 | 9 | 8 | 7 | 6 | 5 | 4 | 3 | 2 | 1 | 0 |
| R | | | | | | | | | | | | | | | | | | | | | | | | | | | | | | | | | |
| W | | | | | | | | | | | | | | | | | | | | | | | | | | | | | | | | | |
| Reset | x* | x* | x* | x* | x* | x* | x* | x* | x* | x* | x* | x* | x* | x* | x* | x* | | x* | x* | x* | x* | x* | x* | x* | x* | x* | x* | x* | x* | x* | x* | x* | x* |

* Notes:

- x = Undefined at reset.

DMA_TCDn_DADDR field descriptions

| Field | Description |
|-------|---|
| DADDR | Destination Address Memory address pointing to the destination data. |

24.3.30 TCD Signed Destination Address Offset (DMA_TCDn_DOFF)

Address: 4000_8000h base + 1014h offset + (32d × i), where i=0d to 3d

| | | | | | | | | | | | | | | | | | |
|-------|----|----|----|----|----|----|----|----|--|----|----|----|----|----|----|----|----|
| Bit | 15 | 14 | 13 | 12 | 11 | 10 | 9 | 8 | | 7 | 6 | 5 | 4 | 3 | 2 | 1 | 0 |
| Read | | | | | | | | | | | | | | | | | |
| Write | | | | | | | | | | | | | | | | | |
| Reset | x* | x* | x* | x* | x* | x* | x* | x* | | x* | x* | x* | x* | x* | x* | x* | x* |

* Notes:

- x = Undefined at reset.

DMA_TCDn_DOFF field descriptions

| Field | Description |
|-------|---|
| DOFF | Destination Address Signed Offset Sign-extended offset applied to the current destination address to form the next-state value as each destination write is completed. |

24.3.31 TCD Current Minor Loop Link, Major Loop Count (Channel Linking Enabled) (DMA_TCDn_CITER_ELINKYES)

If TCDn_CITER[ELINK] is set, the TCDn_CITER register is defined as follows.

Address: 4000_8000h base + 1016h offset + (32d × i), where i=0d to 3d

| | | | | | | | | |
|-------|-------|----|----|----|----|--------|----|-------|
| Bit | 15 | 14 | 13 | 12 | 11 | 10 | 9 | 8 |
| Read | ELINK | 0 | | | | LINKCH | | CITER |
| Write | | | | | | | | |
| Reset | x* | x* | x* | x* | x* | x* | x* | x* |
| Bit | 7 | 6 | 5 | 4 | 3 | 2 | 1 | 0 |
| Read | CITER | | | | | | | |
| Write | | | | | | | | |
| Reset | x* | x* | x* | x* | x* | x* | x* | x* |

* Notes:

- x = Undefined at reset.

DMA_TCDn_CITER_ELINKYES field descriptions

| Field | Description |
|-------------------|---|
| 15 ELINK | <p>Enable channel-to-channel linking on minor-loop complete</p> <p>As the channel completes the minor loop, this flag enables linking to another channel, defined by the LINKCH field. The link target channel initiates a channel service request via an internal mechanism that sets the TCDn_CSR[START] bit of the specified channel.</p> <p>If channel linking is disabled, the CITER value is extended to 15 bits in place of a link channel number. If the major loop is exhausted, this link mechanism is suppressed in favor of the MAJORELINK channel linking.</p> <p>NOTE: This bit must be equal to the BITER[ELINK] bit; otherwise, a configuration error is reported.</p> <p>0 The channel-to-channel linking is disabled 1 The channel-to-channel linking is enabled</p> |
| 14–11 Reserved | This field is reserved. |
| 10–9 LINKCH | <p>Minor Loop Link Channel Number</p> <p>If channel-to-channel linking is enabled (ELINK = 1), then after the minor loop is exhausted, the eDMA engine initiates a channel service request to the channel defined by this field by setting that channel's TCDn_CSR[START] bit.</p> |
| CITER | <p>Current Major Iteration Count</p> <p>This 9-bit (ELINK = 1) or 15-bit (ELINK = 0) count represents the current major loop count for the channel. It is decremented each time the minor loop is completed and updated in the transfer control descriptor memory. After the major iteration count is exhausted, the channel performs a number of operations, for example, final source and destination address calculations, optionally generating an interrupt to signal channel completion before reloading the CITER field from the Beginning Iteration Count (BITER) field.</p> |

Table continues on the next page...

DMA_TCDn_CITER_ELINKYES field descriptions (continued)

| Field | Description |
|-------|--|
| | <p>NOTE: When the CITER field is initially loaded by software, it must be set to the same value as that contained in the BITER field.</p> <p>NOTE: If the channel is configured to execute a single service request, the initial values of BITER and CITER should be 0x0001.</p> |

24.3.32 TCD Current Minor Loop Link, Major Loop Count (Channel Linking Disabled) (DMA_TCDn_CITER_ELINKNO)

If TCDn_CITER[ELINK] is cleared, the TCDn_CITER register is defined as follows.

Address: 4000_8000h base + 1016h offset + (32d × i), where i=0d to 3d

| | | | | | | | | |
|-------|-------|----|----|----|-------|----|----|----|
| Bit | 15 | 14 | 13 | 12 | 11 | 10 | 9 | 8 |
| Read | ELINK | | | | CITER | | | |
| Write | | | | | | | | |
| Reset | x* | x* | x* | x* | x* | x* | x* | x* |
| Bit | 7 | 6 | 5 | 4 | 3 | 2 | 1 | 0 |
| Read | CITER | | | | | | | |
| Write | | | | | | | | |
| Reset | x* | x* | x* | x* | x* | x* | x* | x* |

* Notes:

- x = Undefined at reset.

DMA_TCDn_CITER_ELINKNO field descriptions

| Field | Description |
|-------------|---|
| 15 ELINK | <p>Enable channel-to-channel linking on minor-loop complete</p> <p>As the channel completes the minor loop, this flag enables linking to another channel, defined by the LINKCH field. The link target channel initiates a channel service request via an internal mechanism that sets the TCDn_CSR[START] bit of the specified channel.</p> <p>If channel linking is disabled, the CITER value is extended to 15 bits in place of a link channel number. If the major loop is exhausted, this link mechanism is suppressed in favor of the MAJORELINK channel linking.</p> <p>NOTE: This bit must be equal to the BITER[ELINK] bit; otherwise, a configuration error is reported.</p> <p>0 The channel-to-channel linking is disabled 1 The channel-to-channel linking is enabled</p> |
| CITER | <p>Current Major Iteration Count</p> <p>This 9-bit (ELINK = 1) or 15-bit (ELINK = 0) count represents the current major loop count for the channel. It is decremented each time the minor loop is completed and updated in the transfer control descriptor memory. After the major iteration count is exhausted, the channel performs a number of operations, for</p> |

Table continues on the next page...

DMA_TCDn_CITER_ELINKNO field descriptions (continued)

| Field | Description |
|-------|--|
| | <p>example, final source and destination address calculations, optionally generating an interrupt to signal channel completion before reloading the CITER field from the Beginning Iteration Count (BITER) field.</p> <p>NOTE: When the CITER field is initially loaded by software, it must be set to the same value as that contained in the BITER field.</p> <p>NOTE: If the channel is configured to execute a single service request, the initial values of BITER and CITER should be 0x0001.</p> |

24.3.33 TCD Last Destination Address Adjustment/Scatter Gather Address (DMA_TCDn_DLASTSGA)

Address: 4000_8000h base + 1018h offset + (32d × i), where i=0d to 3d

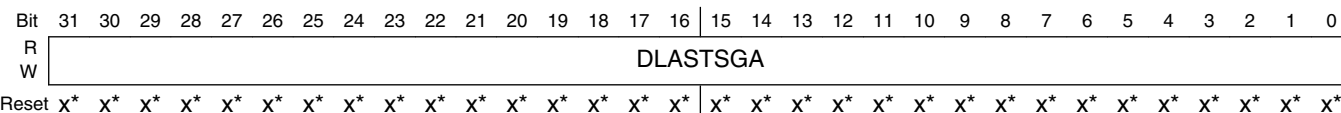

- * Notes:
- x = Undefined at reset.

DMA_TCDn_DLASTSGA field descriptions

| Field | Description |
|----------|---|
| DLASTSGA | <p>Destination last address adjustment or the memory address for the next transfer control descriptor to be loaded into this channel (scatter/gather).</p> <p>If (TCDn_CSR[ESG] = 0) then:</p> <ul style="list-style-type: none"> • Adjustment value added to the destination address at the completion of the major iteration count. This value can apply to restore the destination address to the initial value or adjust the address to reference the next data structure. • This field uses two's complement notation for the final destination address adjustment. <p>Otherwise:</p> <ul style="list-style-type: none"> • This address points to the beginning of a 0-modulo-32-byte region containing the next transfer control descriptor to be loaded into this channel. This channel reload is performed as the major iteration count completes. The scatter/gather address must be 0-modulo-32-byte, otherwise a configuration error is reported. |

24.3.34 TCD Control and Status (DMA_TCDn_CSR)

Address: 4000_8000h base + 101Ch offset + (32d × i), where i=0d to 3d

| | | | | | | | | |
|-------|------|--------|----------------|-----|------|---------|-------------|-------|
| Bit | 15 | 14 | 13 | 12 | 11 | 10 | 9 | 8 |
| Read | BWC | | | | | | MAJORLINKCH | |
| Write | | | 0 | | | | | |
| Reset | x* | x* | x* | x* | x* | x* | x* | x* |
| Bit | 7 | 6 | 5 | 4 | 3 | 2 | 1 | 0 |
| Read | DONE | ACTIVE | MAJORELI NK | ESG | DREQ | INTHALF | INTMAJOR | START |
| Write | | | | | | | | |
| Reset | x* | x* | x* | x* | x* | x* | x* | x* |

* Notes:

- x = Undefined at reset.

DMA_TCDn_CSR field descriptions

| Field | Description |
|--------------------|---|
| 15–14 BWC | <p>Bandwidth Control</p> <p>Throttles the amount of bus bandwidth consumed by the eDMA. Generally, as the eDMA processes the minor loop, it continuously generates read/write sequences until the minor count is exhausted. This field forces the eDMA to stall after the completion of each read/write access to control the bus request bandwidth seen by the crossbar switch.</p> <p>00 No eDMA engine stalls. 01 Reserved 10 eDMA engine stalls for 4 cycles after each R/W. 11 eDMA engine stalls for 8 cycles after each R/W.</p> |
| 13–10 Reserved | This field is reserved. |
| 9–8 MAJORLINKCH | <p>Major Loop Link Channel Number</p> <p>If (MAJORELINK = 0) then:</p> <ul style="list-style-type: none"> • No channel-to-channel linking, or chaining, is performed after the major loop counter is exhausted. <p>Otherwise:</p> <ul style="list-style-type: none"> • After the major loop counter is exhausted, the eDMA engine initiates a channel service request at the channel defined by this field by setting that channel's TCDn_CSR[START] bit. |
| 7 DONE | <p>Channel Done</p> <p>This flag indicates the eDMA has completed the major loop. The eDMA engine sets it as the CITER count reaches zero. The software clears it, or the hardware when the channel is activated.</p> <p>The access of this field is W0C, write-zero-to-clear.</p> <p>NOTE: This bit must be cleared to write the MAJORELINK or ESG bits.</p> |
| 6 ACTIVE | Channel Active |

Table continues on the next page...

DMA_TCDn_CSR field descriptions (continued)

| Field | Description |
|-----------------|--|
| | This flag signals the channel is currently in execution. It is set when channel service begins, and is cleared by the eDMA as the minor loop completes or when any error condition is detected. |
| 5 MAJORELINK | <p>Enable channel-to-channel linking on major loop complete</p> <p>As the channel completes the major loop, this flag enables the linking to another channel, defined by MAJORLINKCH. The link target channel initiates a channel service request via an internal mechanism that sets the TCDn_CSR[START] bit of the specified channel.</p> <p>NOTE: To support the dynamic linking coherency model, this field is forced to zero when written to while the TCDn_CSR[DONE] bit is set.</p> <p>0 The channel-to-channel linking is disabled. 1 The channel-to-channel linking is enabled.</p> |
| 4 ESG | <p>Enable Scatter/Gather Processing</p> <p>As the channel completes the major loop, this flag enables scatter/gather processing in the current channel. If enabled, the eDMA engine uses DLASTSGA as a memory pointer to a 0-modulo-32 address containing a 32-byte data structure loaded as the transfer control descriptor into the local memory.</p> <p>NOTE: To support the dynamic scatter/gather coherency model, this field is forced to zero when written to while the TCDn_CSR[DONE] bit is set.</p> <p>0 The current channel's TCD is normal format. 1 The current channel's TCD specifies a scatter gather format. The DLASTSGA field provides a memory pointer to the next TCD to be loaded into this channel after the major loop completes its execution.</p> |
| 3 DREQ | <p>Disable Request</p> <p>If this flag is set, the eDMA hardware automatically clears the corresponding ERQ bit when the current major iteration count reaches zero.</p> <p>0 The channel's ERQ bit is not affected. 1 The channel's ERQ bit is cleared when the major loop is complete.</p> |
| 2 INTHALF | <p>Enable an interrupt when major counter is half complete.</p> <p>If this flag is set, the channel generates an interrupt request by setting the appropriate bit in the INT register when the current major iteration count reaches the halfway point. Specifically, the comparison performed by the eDMA engine is (CITER == (BITER >> 1)). This halfway point interrupt request is provided to support double-buffered, also known as ping-pong, schemes or other types of data movement where the processor needs an early indication of the transfer's progress.</p> <p>NOTE: If BITER = 1, do not use INTHALF. Use INTMAJOR instead.</p> <p>0 The half-point interrupt is disabled. 1 The half-point interrupt is enabled.</p> |
| 1 INTMAJOR | <p>Enable an interrupt when major iteration count completes.</p> <p>If this flag is set, the channel generates an interrupt request by setting the appropriate bit in the INT when the current major iteration count reaches zero.</p> <p>0 The end-of-major loop interrupt is disabled. 1 The end-of-major loop interrupt is enabled.</p> |
| 0 START | Channel Start |

Table continues on the next page...

DMA_TCDn_CSR field descriptions (continued)

| Field | Description |
|-------|--|
| | If this flag is set, the channel is requesting service. The eDMA hardware automatically clears this flag after the channel begins execution. |
| 0 | The channel is not explicitly started. |
| 1 | The channel is explicitly started via a software initiated service request. |

24.3.35 TCD Beginning Minor Loop Link, Major Loop Count (Channel Linking Enabled) (DMA_TCDn_BITER_ELINKYES)

If the TCDn_BITER[ELINK] bit is set, the TCDn_BITER register is defined as follows.

Address: 4000_8000h base + 101Eh offset + (32d × i), where i=0d to 3d

| | | | | | | | | |
|-------|-------|----|----|----|----|--------|----|-------|
| Bit | 15 | 14 | 13 | 12 | 11 | 10 | 9 | 8 |
| Read | ELINK | 0 | | | | LINKCH | | BITER |
| Write | | | | | | | | |
| Reset | x* | x* | x* | x* | x* | x* | x* | x* |
| Bit | 7 | 6 | 5 | 4 | 3 | 2 | 1 | 0 |
| Read | BITER | | | | | | | |
| Write | | | | | | | | |
| Reset | x* | x* | x* | x* | x* | x* | x* | x* |

* Notes:

- x = Undefined at reset.

DMA_TCDn_BITER_ELINKYES field descriptions

| Field | Description |
|-------------------|--|
| 15 ELINK | <p>Enables channel-to-channel linking on minor loop complete</p> <p>As the channel completes the minor loop, this flag enables the linking to another channel, defined by BITER[LINKCH]. The link target channel initiates a channel service request via an internal mechanism that sets the TCDn_CSR[START] bit of the specified channel. If channel linking disables, the BITER value extends to 15 bits in place of a link channel number. If the major loop is exhausted, this link mechanism is suppressed in favor of the MAJORELINK channel linking.</p> <p>NOTE: When the software loads the TCD, this field must be set equal to the corresponding CITER field; otherwise, a configuration error is reported. As the major iteration count is exhausted, the contents of this field are reloaded into the CITER field.</p> <p>0 The channel-to-channel linking is disabled 1 The channel-to-channel linking is enabled</p> |
| 14–11 Reserved | This field is reserved. |
| 10–9 LINKCH | Link Channel Number |

Table continues on the next page...

DMA_TCDn_BITER_ELINKYES field descriptions (continued)

| Field | Description |
|-------|--|
| | <p>If channel-to-channel linking is enabled (ELINK = 1), then after the minor loop is exhausted, the eDMA engine initiates a channel service request at the channel defined by this field by setting that channel's TCDn_CSR[START] bit.</p> <p>NOTE: When the software loads the TCD, this field must be set equal to the corresponding CITER field; otherwise, a configuration error is reported. As the major iteration count is exhausted, the contents of this field are reloaded into the CITER field.</p> |
| BITER | <p>Starting major iteration count</p> <p>As the transfer control descriptor is first loaded by software, this 9-bit (ELINK = 1) or 15-bit (ELINK = 0) field must be equal to the value in the CITER field. As the major iteration count is exhausted, the contents of this field are reloaded into the CITER field.</p> <p>NOTE: When the software loads the TCD, this field must be set equal to the corresponding CITER field; otherwise, a configuration error is reported. As the major iteration count is exhausted, the contents of this field are reloaded into the CITER field. If the channel is configured to execute a single service request, the initial values of BITER and CITER should be 0x0001.</p> |

24.3.36 TCD Beginning Minor Loop Link, Major Loop Count (Channel Linking Disabled) (DMA_TCDn_BITER_ELINKNO)

If the TCDn_BITER[ELINK] bit is cleared, the TCDn_BITER register is defined as follows.

Address: 4000_8000h base + 101Eh offset + (32d × i), where i=0d to 3d

| | | | | | | | | |
|-------|-------|----|----|----|-------|----|----|----|
| Bit | 15 | 14 | 13 | 12 | 11 | 10 | 9 | 8 |
| Read | ELINK | | | | BITER | | | |
| Write | | | | | | | | |
| Reset | x* | x* | x* | x* | x* | x* | x* | x* |
| Bit | 7 | 6 | 5 | 4 | 3 | 2 | 1 | 0 |
| Read | BITER | | | | | | | |
| Write | | | | | | | | |
| Reset | x* | x* | x* | x* | x* | x* | x* | x* |

* Notes:

- x = Undefined at reset.

DMA_TCDn_BITER_ELINKNO field descriptions

| Field | Description |
|-------------|--|
| 15 ELINK | <p>Enables channel-to-channel linking on minor loop complete</p> <p>As the channel completes the minor loop, this flag enables the linking to another channel, defined by BITER[LINKCH]. The link target channel initiates a channel service request via an internal mechanism that sets the TCDn_CSR[START] bit of the specified channel. If channel linking is disabled, the BITER value extends to 15 bits in place of a link channel number. If the major loop is exhausted, this link mechanism is suppressed in favor of the MAJORELINK channel linking.</p> |

Table continues on the next page...

DMA_TCDn_BITER_ELINKNO field descriptions (continued)

| Field | Description |
|-------|---|
| | <p>NOTE: When the software loads the TCD, this field must be set equal to the corresponding CITER field; otherwise, a configuration error is reported. As the major iteration count is exhausted, the contents of this field are reloaded into the CITER field.</p> <p>0 The channel-to-channel linking is disabled 1 The channel-to-channel linking is enabled</p> |
| BITER | <p>Starting Major Iteration Count</p> <p>As the transfer control descriptor is first loaded by software, this 9-bit (ELINK = 1) or 15-bit (ELINK = 0) field must be equal to the value in the CITER field. As the major iteration count is exhausted, the contents of this field are reloaded into the CITER field.</p> <p>NOTE: When the software loads the TCD, this field must be set equal to the corresponding CITER field; otherwise, a configuration error is reported. As the major iteration count is exhausted, the contents of this field is reloaded into the CITER field. If the channel is configured to execute a single service request, the initial values of BITER and CITER should be 0x0001.</p> |

24.4 Functional description

The operation of the eDMA is described in the following subsections.

24.4.1 eDMA basic data flow

The basic flow of a data transfer can be partitioned into three segments.

As shown in the following diagram, the first segment involves the channel activation:

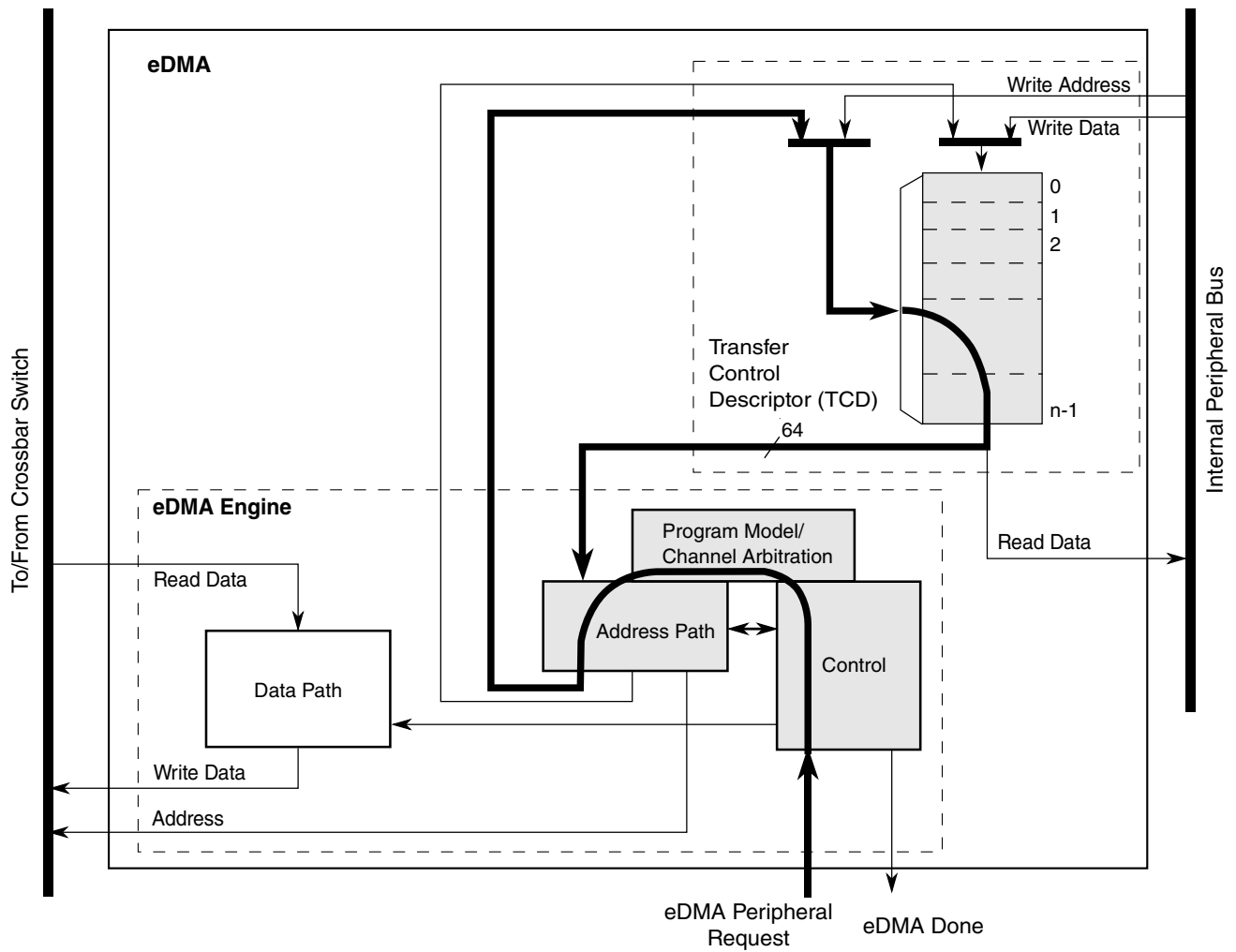

Figure 24-2. eDMA operation, part 1

This example uses the assertion of the eDMA peripheral request signal to request service for channel n . Channel activation via software and the $TCD_n_CSR[START]$ bit follows the same basic flow as peripheral requests. The eDMA request input signal is registered internally and then routed through the eDMA engine: first through the control module, then into the program model and channel arbitration. In the next cycle, the channel arbitration performs, using the fixed-priority or round-robin algorithm. After arbitration is complete, the activated channel number is sent through the address path and converted into the required address to access the local memory for TCD_n . Next, the TCD memory is accessed and the required descriptor read from the local memory and loaded into the eDMA engine address path channel x or y registers. The TCD memory is 64 bits wide to minimize the time needed to fetch the activated channel descriptor and load it into the address path channel x or y registers.

The following diagram illustrates the second part of the basic data flow:

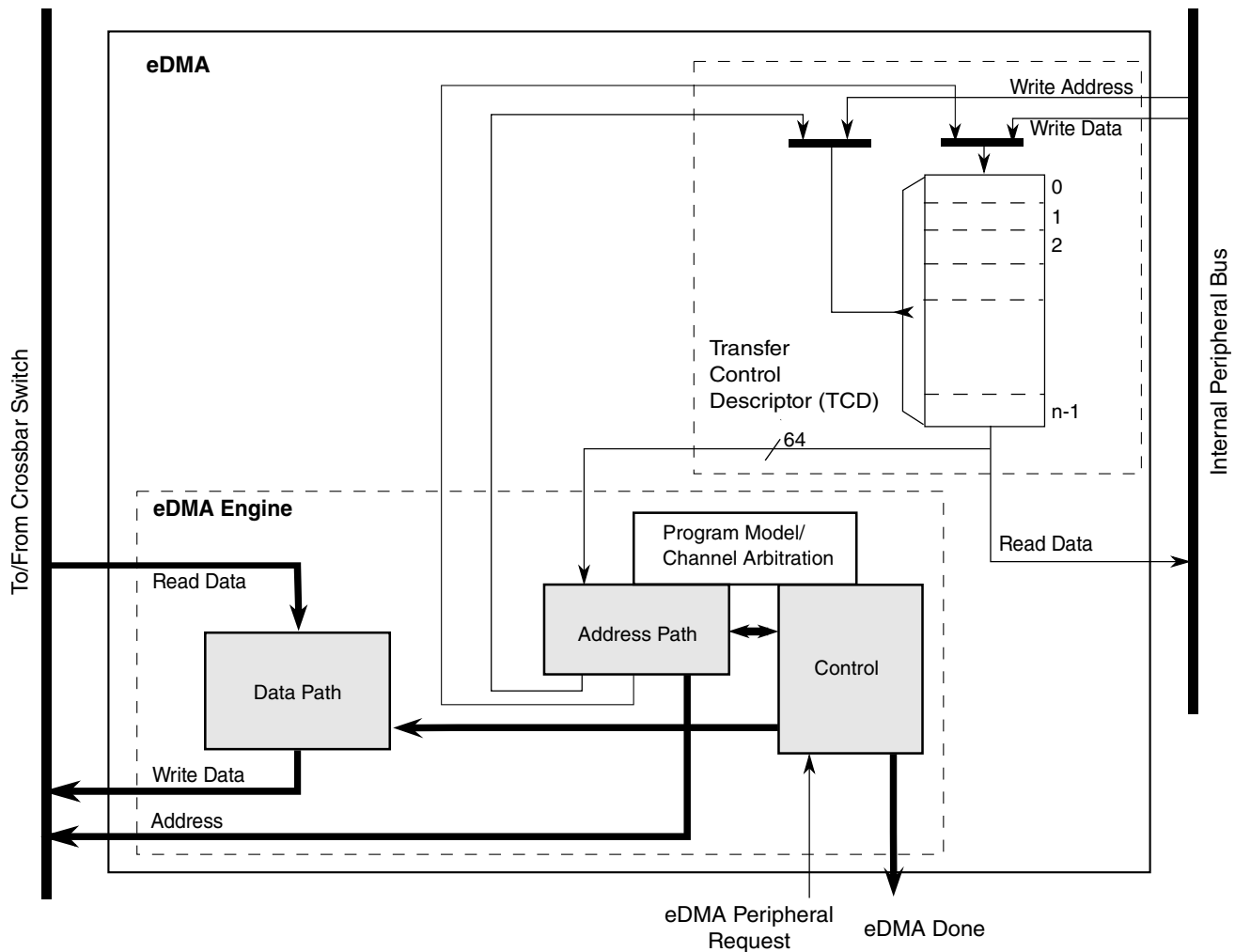

Figure 24-3. eDMA operation, part 2

The modules associated with the data transfer (address path, data path, and control) sequence through the required source reads and destination writes to perform the actual data movement. The source reads are initiated and the fetched data is temporarily stored in the data path block until it is gated onto the internal bus during the destination write. This source read/destination write processing continues until the minor byte count has transferred.

After the minor byte count has moved, the final phase of the basic data flow is performed. In this segment, the address path logic performs the required updates to certain fields in the appropriate TCD, for example, SADDR, DADDR, CITER. If the major iteration count is exhausted, additional operations are performed. These include the final address adjustments and reloading of the BITER field into the CITER. Assertion of an optional interrupt request also occurs at this time, as does a possible fetch of a new TCD from memory using the scatter/gather address pointer included in the descriptor (if scatter/gather is enabled). The updates to the TCD memory and the assertion of an interrupt request are shown in the following diagram.

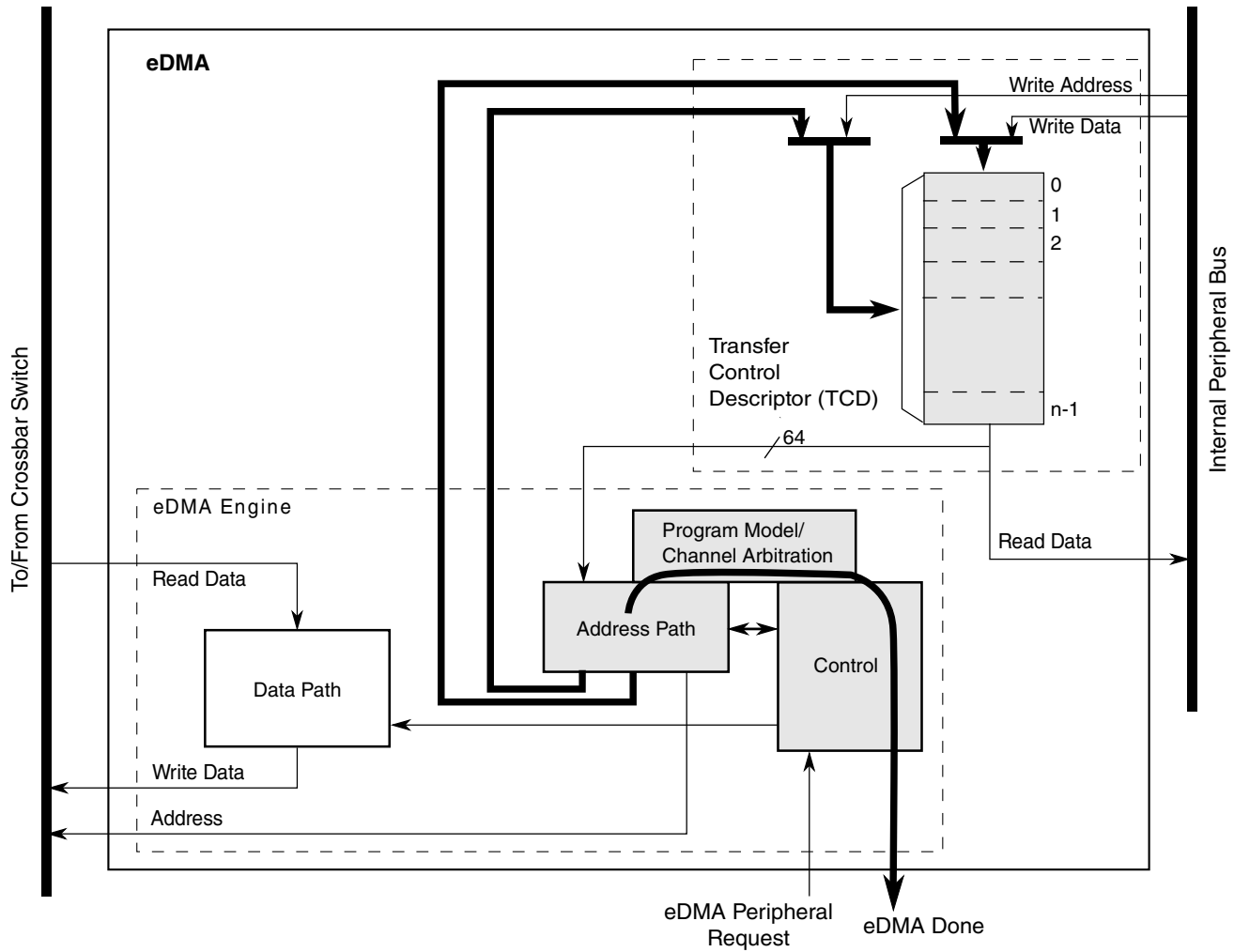

Figure 24-4. eDMA operation, part 3

24.4.2 Fault reporting and handling

Channel errors are reported in the Error Status register (DMAx_ES) and can be caused by:

- A configuration error, which is an illegal setting in the transfer-control descriptor or an illegal priority register setting in Fixed-Arbitration mode, or
- An error termination to a bus master read or write cycle

A configuration error is reported when the starting source or destination address, source or destination offsets, minor loop byte count, or the transfer size represent an inconsistent state. Each of these possible causes are detailed below:

- The addresses and offsets must be aligned on 0-modulo-transfer-size boundaries.
- The minor loop byte count must be a multiple of the source and destination transfer sizes.

- All source reads and destination writes must be configured to the natural boundary of the programmed transfer size respectively.
- In fixed arbitration mode, a configuration error is caused by any two channel priorities being equal. All channel priority levels must be unique when fixed arbitration mode is enabled.

NOTE

When two channels have the same priority, a channel priority error exists and will be reported in the Error Status register. However, the channel number will not be reported in the Error Status register. When all of the channel priorities within a group are not unique, the channel number selected by arbitration is undetermined.

To aid in Channel Priority Error (CPE) debug, set the Halt On Error bit in the DMA's Control Register. If all of the channel priorities within a group are not unique, the DMA will be halted after the CPE error is recorded. The DMA will remain halted and will not process any channel service requests. Once all of the channel priorities are set to unique numbers, the DMA may be enabled again by clearing the Halt bit.

- If a scatter/gather operation is enabled upon channel completion, a configuration error is reported if the scatter/gather address (DLAST_SGA) is not aligned on a 32-byte boundary.
- If minor loop channel linking is enabled upon channel completion, a configuration error is reported when the link is attempted if the TCDn_CITER[E_LINK] bit does not equal the TCDn_BITER[E_LINK] bit.

If enabled, all configuration error conditions, except the scatter/gather and minor-loop link errors, report as the channel activates and asserts an error interrupt request. A scatter/gather configuration error is reported when the scatter/gather operation begins at major loop completion when properly enabled. A minor loop channel link configuration error is reported when the link operation is serviced at minor loop completion.

If a system bus read or write is terminated with an error, the data transfer is stopped and the appropriate bus error flag set. In this case, the state of the channel's transfer control descriptor is updated by the eDMA engine with the current source address, destination address, and current iteration count at the point of the fault. When a system bus error occurs, the channel terminates after the next transfer. Due to pipeline effect, the next transfer is already in progress when the bus error is received by the eDMA. If a bus error

occurs on the last read prior to beginning the write sequence, the write executes using the data captured during the bus error. If a bus error occurs on the last write prior to switching to the next read sequence, the read sequence executes before the channel terminates due to the destination bus error.

A transfer may be cancelled by software with the CR[CX] bit. When a cancel transfer request is recognized, the DMA engine stops processing the channel. The current read-write sequence is allowed to finish. If the cancel occurs on the last read-write sequence of a major or minor loop, the cancel request is discarded and the channel retires normally.

The error cancel transfer is the same as a cancel transfer except the Error Status register (DMAx_ES) is updated with the cancelled channel number and ECX is set. The TCD of a cancelled channel contains the source and destination addresses of the last transfer saved in the TCD. If the channel needs to be restarted, you must re-initialize the TCD because the aforementioned fields no longer represent the original parameters. When a transfer is cancelled by the error cancel transfer mechanism, the channel number is loaded into DMA_ES[ERRCHN] and ECX and VLD are set. In addition, an error interrupt may be generated if enabled.

NOTE

The cancel transfer request allows the user to stop a large data transfer in the event the full data transfer is no longer needed. The cancel transfer bit does not abort the channel. It simply stops the transferring of data and then retires the channel through its normal shutdown sequence. The application software must handle the context of the cancel. If an interrupt is desired (or not), then the interrupt should be enabled (or disabled) before the cancel request. The application software must clean up the transfer control descriptor since the full transfer did not occur.

The occurrence of any error causes the eDMA engine to stop normal processing of the active channel immediately (it goes to its error processing states and the transaction to the system bus still has pipeline effect), and the appropriate channel bit in the eDMA error register is asserted. At the same time, the details of the error condition are loaded into the Error Status register (DMAx_ES). The major loop complete indicators, setting the transfer control descriptor DONE flag and the possible assertion of an interrupt request, are not affected when an error is detected. After the error status has been updated, the eDMA engine continues operating by servicing the next appropriate channel. A channel that experiences an error condition is not automatically disabled. If a channel is terminated by an error and then issues another service request before the error is fixed, that channel executes and terminates with the same error condition.

24.4.3 Channel preemption

Channel preemption is enabled on a per-channel basis by setting the DCHPRIn[ECP] bit. Channel preemption allows the executing channel's data transfers to temporarily suspend in favor of starting a higher priority channel. After the preempting channel has completed all its minor loop data transfers, the preempted channel is restored and resumes execution. After the restored channel completes one read/write sequence, it is again eligible for preemption. If any higher priority channel is requesting service, the restored channel is suspended and the higher priority channel is serviced. Nested preemption, that is, attempting to preempt a preempting channel, is not supported. After a preempting channel begins execution, it cannot be preempted. Preemption is available only when fixed arbitration is selected.

A channel's ability to preempt another channel can be disabled by setting DCHPRIn[DPA]. When a channel's preempt ability is disabled, that channel cannot suspend a lower priority channel's data transfer, regardless of the lower priority channel's ECP setting. This allows for a pool of low priority, large data-moving channels to be defined. These low priority channels can be configured to not preempt each other, thus preventing a low priority channel from consuming the preempt slot normally available to a true, high priority channel.

24.4.4 Performance

This section addresses the performance of the eDMA module, focusing on two separate metrics:

- In the traditional data movement context, performance is best expressed as the peak data transfer rates achieved using the eDMA. In most implementations, this transfer rate is limited by the speed of the source and destination address spaces.
- In a second context where device-paced movement of single data values to/from peripherals is dominant, a measure of the requests that can be serviced in a fixed time is a more relevant metric. In this environment, the speed of the source and destination address spaces remains important. However, the microarchitecture of the eDMA also factors significantly into the resulting metric.

24.4.4.1 Peak transfer rates

The peak transfer rates for several different source and destination transfers are shown in the following tables. These tables assume:

Functional description

- Internal SRAM can be accessed with zero wait-states when viewed from the system bus data phase
- All internal peripheral bus reads require two wait-states, and internal peripheral bus writes three wait-states, when viewed from the system bus data phase
- All internal peripheral bus accesses are 32-bits in size

NOTE

All architectures will not meet the assumptions listed above.
See the SRAM configuration section for more information.

This table compares peak transfer rates based on different possible system speeds. Specific chips/devices may not support all system speeds listed.

Table 24-4. eDMA peak transfer rates (Mbytes/sec)

| System Speed, Width | Internal SRAM-to-Internal SRAM | 32 bit internal peripheral bus-to-Internal SRAM | Internal SRAM-to-32 bit internal peripheral bus |
|---------------------|--------------------------------|---|---|
| 48 MHz, 32 bit | 96.0 | 48.0 | 38.4 |
| 66.7 MHz, 32 bit | 133.3 | 66.7 | 53.3 |
| 83.3 MHz, 32 bit | 166.7 | 83.3 | 66.7 |
| 100.0 MHz, 32 bit | 200.0 | 100.0 | 80.0 |
| 133.3 MHz, 32 bit | 266.7 | 133.3 | 106.7 |
| 150.0 MHz, 32 bit | 300.0 | 150.0 | 120.0 |

Internal-SRAM-to-internal-SRAM transfers occur at the core's datapath width. For all transfers involving the internal peripheral bus, 32-bit transfer sizes are used. In all cases, the transfer rate includes the time to read the source plus the time to write the destination.

24.4.4.2 Peak request rates

The second performance metric is a measure of the number of DMA requests that can be serviced in a given amount of time. For this metric, assume that the peripheral request causes the channel to move a single internal peripheral bus-mapped operand to/from internal SRAM. The same timing assumptions used in the previous example apply to this calculation. In particular, this metric also reflects the time required to activate the channel.

The eDMA design supports the following hardware service request sequence. Note that the exact timing from Cycle 7 is a function of the response times for the channel's read and write accesses. In the case of an internal peripheral bus read and internal SRAM write, the combined data phase time is 4 cycles. For an SRAM read and internal peripheral bus write, it is 5 cycles.

Table 24-5. Hardware service request process

| Cycle | | Description |
|---|--|--|
| With internal peripheral bus read and internal SRAM write | With SRAM read and internal peripheral bus write | |
| 1 | | eDMA peripheral request is asserted. |
| 2 | | The eDMA peripheral request is registered locally in the eDMA module and qualified. TCD _n _CSR[START] bit initiated requests start at this point with the registering of the user write to TCD _n word 7. |
| 3 | | Channel arbitration begins. |
| 4 | | Channel arbitration completes. The transfer control descriptor local memory read is initiated. |
| 5–6 | | The first two parts of the activated channel's TCD is read from the local memory. The memory width to the eDMA engine is 64 bits, so the entire descriptor can be accessed in four cycles |
| 7 | | The first system bus read cycle is initiated, as the third part of the channel's TCD is read from the local memory. Depending on the state of the crossbar switch, arbitration at the system bus may insert an additional cycle of delay here. |
| 8–11 | 8–12 | The last part of the TCD is read in. This cycle represents the first data phase for the read, and the address phase for the destination write. |
| 12 | 13 | This cycle represents the data phase of the last destination write. |
| 13 | 14 | The eDMA engine completes the execution of the inner minor loop and prepares to write back the required TCD _n fields into the local memory. The TCD _n word 7 is read and checked for channel linking or scatter/gather requests. |
| 14 | 15 | The appropriate fields in the first part of the TCD _n are written back into the local memory. |
| 15 | 16 | The fields in the second part of the TCD _n are written back into the local memory. This cycle coincides with the next channel arbitration cycle start. |
| 16 | 17 | The next channel to be activated performs the read of the first part of its TCD from the local memory. This is equivalent to Cycle 4 for the first channel's service request. |

Assuming zero wait states on the system bus, DMA requests can be processed every 9 cycles. Assuming an average of the access times associated with internal peripheral bus-to-SRAM (4 cycles) and SRAM-to-internal peripheral bus (5 cycles), DMA requests can

be processed every 11.5 cycles ($4 + (4+5)/2 + 3$). This is the time from Cycle 4 to Cycle $x + 5$. The resulting peak request rate, as a function of the system frequency, is shown in the following table.

Table 24-6. eDMA peak request rate (MReq/sec)

| System frequency (MHz) | Request rate with zero wait states | Request rate with wait states |
|------------------------|------------------------------------|-------------------------------|
| 48.0 | 5.3 | 4.2 |
| 66.6 | 7.4 | 5.8 |
| 83.3 | 9.2 | 7.2 |
| 100.0 | 11.1 | 8.7 |
| 133.3 | 14.8 | 11.6 |
| 150.0 | 16.6 | 13.0 |

A general formula to compute the peak request rate with overlapping requests is:

$$PEAKreq = freq / [entry + (1 + read_ws) + (1 + write_ws) + exit]$$

where:

Table 24-7. Peak request formula operands

| Operand | Description |
|----------|---|
| PEAKreq | Peak request rate |
| freq | System frequency |
| entry | Channel startup (4 cycles) |
| read_ws | Wait states seen during the system bus read data phase |
| write_ws | Wait states seen during the system bus write data phase |
| exit | Channel shutdown (3 cycles) |

24.4.4.3 eDMA performance example

Consider a system with the following characteristics:

- Internal SRAM can be accessed with one wait-state when viewed from the system bus data phase
- All internal peripheral bus reads require two wait-states, and internal peripheral bus writes three wait-states viewed from the system bus data phase
- System operates at 150 MHz

For an SRAM to internal peripheral bus transfer,

$$\text{PEAKreq} = 150 \text{ MHz} / [4 + (1 + 1) + (1 + 3) + 3] \text{ cycles} = 11.5 \text{ Mreq/sec}$$

For an internal peripheral bus to SRAM transfer,

$$\text{PEAKreq} = 150 \text{ MHz} / [4 + (1 + 2) + (1 + 1) + 3] \text{ cycles} = 12.5 \text{ Mreq/sec}$$

Assuming an even distribution of the two transfer types, the average peak request rate would be:

$$\text{PEAKreq} = (11.5 \text{ Mreq/sec} + 12.5 \text{ Mreq/sec}) / 2 = 12.0 \text{ Mreq/sec}$$

The minimum number of cycles to perform a single read/write, zero wait states on the system bus, from a cold start where no channel is executing and eDMA is idle are:

- 11 cycles for a software, that is, a TCD n _CSR[START] bit, request
- 12 cycles for a hardware, that is, an eDMA peripheral request signal, request

Two cycles account for the arbitration pipeline and one extra cycle on the hardware request resulting from the internal registering of the eDMA peripheral request signals. For the peak request rate calculations above, the arbitration and request registering is absorbed in or overlaps the previous executing channel.

Note

When channel linking or scatter/gather is enabled, a two cycle delay is imposed on the next channel selection and startup. This allows the link channel or the scatter/gather channel to be eligible and considered in the arbitration pool for next channel selection.

24.5 Initialization/application information

The following sections discuss initialization of the eDMA and programming considerations.

24.5.1 eDMA initialization

To initialize the eDMA:

1. Write to the CR if a configuration other than the default is desired.
2. Write the channel priority levels to the DCHPRI n registers if a configuration other than the default is desired.

3. Enable error interrupts in the EEI register if so desired.
4. Write the 32-byte TCD for each channel that may request service.
5. Enable any hardware service requests via the ERQ register.
6. Request channel service via either:
 - Software: setting the TCD n _CSR[START]
 - Hardware: slave device asserting its eDMA peripheral request signal

After any channel requests service, a channel is selected for execution based on the arbitration and priority levels written into the programmer's model. The eDMA engine reads the entire TCD, including the TCD control and status fields, as shown in the following table, for the selected channel into its internal address path module.

As the TCD is read, the first transfer is initiated on the internal bus, unless a configuration error is detected. Transfers from the source, as defined by TCD n _SADDR, to the destination, as defined by TCD n _DADDR, continue until the number of bytes specified by TCD n _NBYTES are transferred.

When the transfer is complete, the eDMA engine's local TCD n _SADDR, TCD n _DADDR, and TCD n _CITER are written back to the main TCD memory and any minor loop channel linking is performed, if enabled. If the major loop is exhausted, further post processing executes, such as interrupts, major loop channel linking, and scatter/gather operations, if enabled.

Table 24-8. TCD Control and Status fields

| TCD n _CSR field name | Description |
|-------------------------|---|
| START | Control bit to start channel explicitly when using a software initiated DMA service (Automatically cleared by hardware) |
| ACTIVE | Status bit indicating the channel is currently in execution |
| DONE | Status bit indicating major loop completion (cleared by software when using a software initiated DMA service) |
| D_REQ | Control bit to disable DMA request at end of major loop completion when using a hardware initiated DMA service |
| BWC | Control bits for throttling bandwidth control of a channel |
| E_SG | Control bit to enable scatter-gather feature |
| INT_HALF | Control bit to enable interrupt when major loop is half complete |
| INT_MAJ | Control bit to enable interrupt when major loop completes |

The following figure shows how each DMA request initiates one minor-loop transfer, or iteration, without CPU intervention. DMA arbitration can occur after each minor loop, and one level of minor loop DMA preemption is allowed. The number of minor loops in a major loop is specified by the beginning iteration count (BITER).

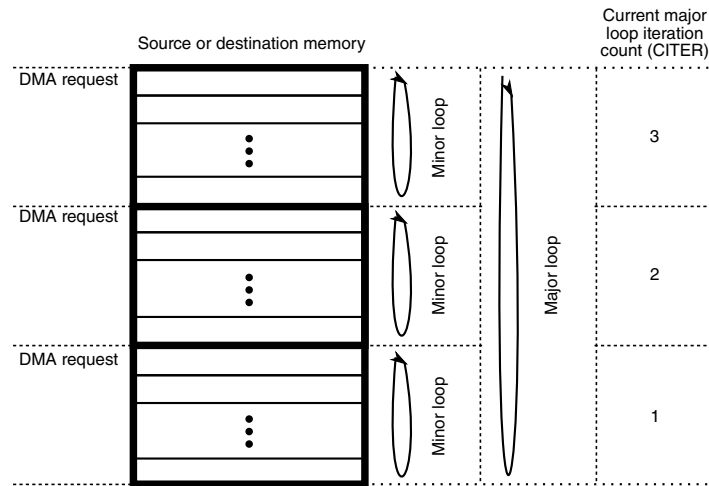

Figure 24-5. Example of multiple loop iterations

The following figure lists the memory array terms and how the TCD settings interrelate.

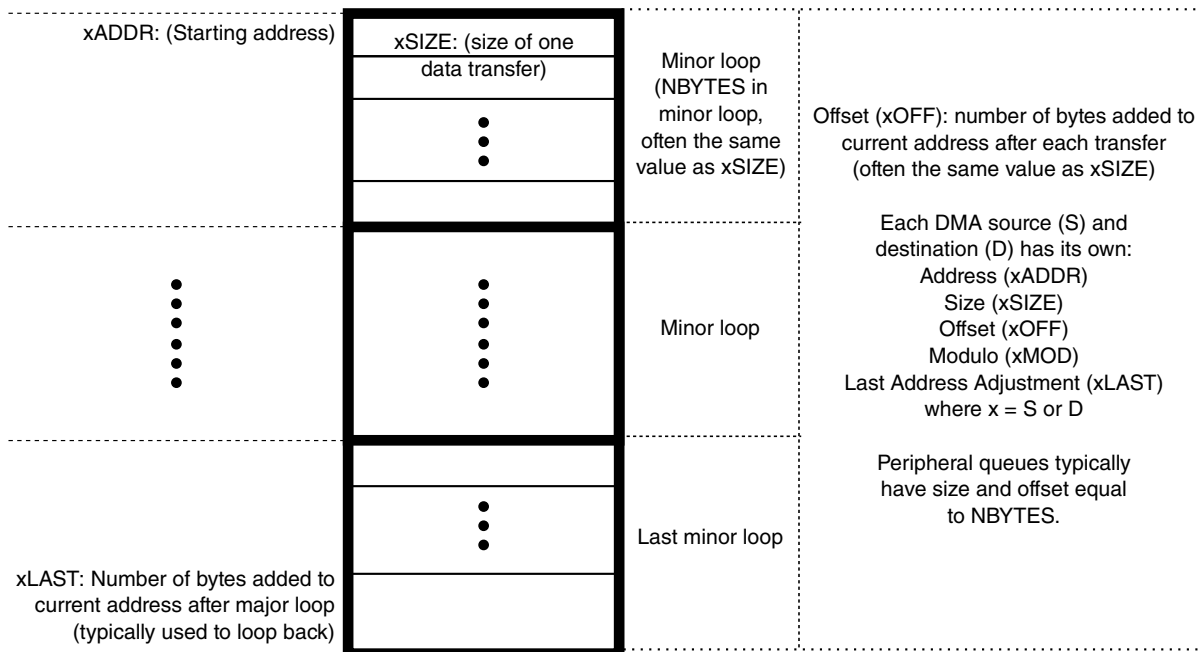

Figure 24-6. Memory array terms

24.5.2 Programming errors

The eDMA performs various tests on the transfer control descriptor to verify consistency in the descriptor data. Most programming errors are reported on a per channel basis with the exception of channel priority error (ES[CPE]).

For all error types other than channel priority error, the channel number causing the error is recorded in the Error Status register (DMAx_ES). If the error source is not removed before the next activation of the problem channel, the error is detected and recorded again.

If priority levels are not unique, when any channel requests service, a channel priority error is reported. The highest channel priority with an active request is selected, but the lowest numbered channel with that priority is selected by arbitration and executed by the eDMA engine. The hardware service request handshake signals, error interrupts, and error reporting is associated with the selected channel.

24.5.3 Arbitration mode considerations

This section discusses arbitration considerations for the eDMA.

24.5.3.1 Fixed channel arbitration

In this mode, the channel service request from the highest priority channel is selected to execute.

24.5.3.2 Round-robin channel arbitration

Channels are serviced starting with the highest channel number and rotating through to the lowest channel number without regard to the channel priority levels.

24.5.4 Performing DMA transfers

This section presents examples on how to perform DMA transfers with the eDMA.

24.5.4.1 Single request

To perform a simple transfer of n bytes of data with one activation, set the major loop to one ($TCDn_CITER = TCDn_BITER = 1$). The data transfer begins after the channel service request is acknowledged and the channel is selected to execute. After the transfer is complete, the $TCDn_CSR[DONE]$ bit is set and an interrupt generates if properly enabled.

For example, the following TCD entry is configured to transfer 16 bytes of data. The eDMA is programmed for one iteration of the major loop transferring 16 bytes per iteration. The source memory has a byte wide memory port located at 0x1000. The destination memory has a 32-bit port located at 0x2000. The address offsets are programmed in increments to match the transfer size: one byte for the source and four bytes for the destination. The final source and destination addresses are adjusted to return to their beginning values.

```
TCDn_CITER = TCDn_BITER = 1
TCDn_NBYTES = 16
TCDn_SADDR = 0x1000
TCDn_SOFF = 1
TCDn_ATTR[SSIZE] = 0
TCDn_SLAST = -16
TCDn_DADDR = 0x2000
TCDn_DOFF = 4
TCDn_ATTR[DSIZE] = 2
TCDn_DLAST_SGA = -16
TCDn_CSR[INT_MAJ] = 1
TCDn_CSR[START] = 1 (Should be written last after all other fields have been initialized)
All other TCDn fields = 0
```

This generates the following event sequence:

1. User write to the TCDn_CSR[START] bit requests channel service.
2. The channel is selected by arbitration for servicing.
3. eDMA engine writes: TCDn_CSR[DONE] = 0, TCDn_CSR[START] = 0, TCDn_CSR[ACTIVE] = 1.
4. eDMA engine reads: channel TCD data from local memory to internal register file.
5. The source-to-destination transfers are executed as follows:
 - a. Read byte from location 0x1000, read byte from location 0x1001, read byte from 0x1002, read byte from 0x1003.
 - b. Write 32-bits to location 0x2000 → first iteration of the minor loop.
 - c. Read byte from location 0x1004, read byte from location 0x1005, read byte from 0x1006, read byte from 0x1007.
 - d. Write 32-bits to location 0x2004 → second iteration of the minor loop.
 - e. Read byte from location 0x1008, read byte from location 0x1009, read byte from 0x100A, read byte from 0x100B.
 - f. Write 32-bits to location 0x2008 → third iteration of the minor loop.
 - g. Read byte from location 0x100C, read byte from location 0x100D, read byte from 0x100E, read byte from 0x100F.

- h. Write 32-bits to location 0x200C → last iteration of the minor loop → major loop complete.
6. The eDMA engine writes: $TCDn_SADDR = 0x1000$, $TCDn_DADDR = 0x2000$, $TCDn_CITER = 1$ ($TCDn_BITER$).
7. The eDMA engine writes: $TCDn_CSR[ACTIVE] = 0$, $TCDn_CSR[DONE] = 1$, $INT[n] = 1$.
8. The channel retires and the eDMA goes idle or services the next channel.

24.5.4.2 Multiple requests

The following example transfers 32 bytes via two hardware requests, but is otherwise the same as the previous example. The only fields that change are the major loop iteration count and the final address offsets. The eDMA is programmed for two iterations of the major loop transferring 16 bytes per iteration. After the channel's hardware requests are enabled in the ERQ register, the slave device initiates channel service requests.

```
TCDn_CITER = TCDn_BITER = 2
TCDn_SLAST = -32
TCDn_DLAST_SGA = -32
```

This would generate the following sequence of events:

1. First hardware, that is, eDMA peripheral, request for channel service.
2. The channel is selected by arbitration for servicing.
3. eDMA engine writes: $TCDn_CSR[DONE] = 0$, $TCDn_CSR[START] = 0$, $TCDn_CSR[ACTIVE] = 1$.
4. eDMA engine reads: channel $TCDn$ data from local memory to internal register file.
5. The source to destination transfers are executed as follows:
 - a. Read byte from location 0x1000, read byte from location 0x1001, read byte from 0x1002, read byte from 0x1003.
 - b. Write 32-bits to location 0x2000 → first iteration of the minor loop.
 - c. Read byte from location 0x1004, read byte from location 0x1005, read byte from 0x1006, read byte from 0x1007.
 - d. Write 32-bits to location 0x2004 → second iteration of the minor loop.
 - e. Read byte from location 0x1008, read byte from location 0x1009, read byte from 0x100A, read byte from 0x100B.

- f. Write 32-bits to location 0x2008 → third iteration of the minor loop.
 - g. Read byte from location 0x100C, read byte from location 0x100D, read byte from 0x100E, read byte from 0x100F.
 - h. Write 32-bits to location 0x200C → last iteration of the minor loop.
6. eDMA engine writes: $TCDn_SADDR = 0x1010$, $TCDn_DADDR = 0x2010$, $TCDn_CITER = 1$.
 7. eDMA engine writes: $TCDn_CSR[ACTIVE] = 0$.
 8. The channel retires → one iteration of the major loop. The eDMA goes idle or services the next channel.
 9. Second hardware, that is, eDMA peripheral, requests channel service.
 10. The channel is selected by arbitration for servicing.
 11. eDMA engine writes: $TCDn_CSR[DONE] = 0$, $TCDn_CSR[START] = 0$, $TCDn_CSR[ACTIVE] = 1$.
 12. eDMA engine reads: channel TCD data from local memory to internal register file.
 13. The source to destination transfers are executed as follows:
 - a. Read byte from location 0x1010, read byte from location 0x1011, read byte from 0x1012, read byte from 0x1013.
 - b. Write 32-bits to location 0x2010 → first iteration of the minor loop.
 - c. Read byte from location 0x1014, read byte from location 0x1015, read byte from 0x1016, read byte from 0x1017.
 - d. Write 32-bits to location 0x2014 → second iteration of the minor loop.
 - e. Read byte from location 0x1018, read byte from location 0x1019, read byte from 0x101A, read byte from 0x101B.
 - f. Write 32-bits to location 0x2018 → third iteration of the minor loop.
 - g. Read byte from location 0x101C, read byte from location 0x101D, read byte from 0x101E, read byte from 0x101F.
 - h. Write 32-bits to location 0x201C → last iteration of the minor loop → major loop complete.
 14. eDMA engine writes: $TCDn_SADDR = 0x1000$, $TCDn_DADDR = 0x2000$, $TCDn_CITER = 2$ ($TCDn_BITER$).

15. eDMA engine writes: $TCDn_CSR[ACTIVE] = 0$, $TCDn_CSR[DONE] = 1$, $INT[n] = 1$.
16. The channel retires → major loop complete. The eDMA goes idle or services the next channel.

24.5.4.3 Using the modulo feature

The modulo feature of the eDMA provides the ability to implement a circular data queue in which the size of the queue is a power of 2. MOD is a 5-bit field for the source and destination in the TCD, and it specifies which lower address bits increment from their original value after the address+offset calculation. All upper address bits remain the same as in the original value. A setting of 0 for this field disables the modulo feature.

The following table shows how the transfer addresses are specified based on the setting of the MOD field. Here a circular buffer is created where the address wraps to the original value while the 28 upper address bits ($0x1234567x$) retain their original value. In this example the source address is set to $0x12345670$, the offset is set to 4 bytes and the MOD field is set to 4, allowing for a 2^4 byte (16-byte) size queue.

Table 24-9. Modulo example

| Transfer Number | Address |
|-----------------|------------|
| 1 | 0x12345670 |
| 2 | 0x12345674 |
| 3 | 0x12345678 |
| 4 | 0x1234567C |
| 5 | 0x12345670 |
| 6 | 0x12345674 |

24.5.5 Monitoring transfer descriptor status

This section discusses how to monitor eDMA status.

24.5.5.1 Testing for minor loop completion

There are two methods to test for minor loop completion when using software initiated service requests. The first is to read the $TCDn_CITER$ field and test for a change. Another method may be extracted from the sequence shown below. The second method is

to test the $TCDn_CSR[START]$ bit and the $TCDn_CSR[ACTIVE]$ bit. The minor-loop-complete condition is indicated by both bits reading zero after the $TCDn_CSR[START]$ was set. Polling the $TCDn_CSR[ACTIVE]$ bit may be inconclusive, because the active status may be missed if the channel execution is short in duration.

The TCD status bits execute the following sequence for a software activated channel:

| Stage | TCDn_CSR bits | | | State |
|-------|---------------|--------|------|--|
| | START | ACTIVE | DONE | |
| 1 | 1 | 0 | 0 | Channel service request via software |
| 2 | 0 | 1 | 0 | Channel is executing |
| 3a | 0 | 0 | 0 | Channel has completed the minor loop and is idle |
| 3b | 0 | 0 | 1 | Channel has completed the major loop and is idle |

The best method to test for minor-loop completion when using hardware, that is, peripheral, initiated service requests is to read the $TCDn_CITER$ field and test for a change. The hardware request and acknowledge handshake signals are not visible in the programmer's model.

The TCD status bits execute the following sequence for a hardware-activated channel:

| Stage | TCDn_CSR bits | | | State |
|-------|---------------|--------|------|--|
| | START | ACTIVE | DONE | |
| 1 | 0 | 0 | 0 | Channel service request via hardware (peripheral request asserted) |
| 2 | 0 | 1 | 0 | Channel is executing |
| 3a | 0 | 0 | 0 | Channel has completed the minor loop and is idle |
| 3b | 0 | 0 | 1 | Channel has completed the major loop and is idle |

For both activation types, the major-loop-complete status is explicitly indicated via the $TCDn_CSR[DONE]$ bit.

The $TCDn_CSR[START]$ bit is cleared automatically when the channel begins execution regardless of how the channel activates.

24.5.5.2 Reading the transfer descriptors of active channels

The eDMA reads back the true $TCDn_SADDR$, $TCDn_DADDR$, and $TCDn_NBYTES$ values if read while a channel executes. The true values of the $SADDR$, $DADDR$, and $NBYTES$ are the values the eDMA engine currently uses in its internal register file and not the values in the TCD local memory for that channel. The addresses, $SADDR$ and

DADDR, and NBYTES, which decrement to zero as the transfer progresses, can give an indication of the progress of the transfer. All other values are read back from the TCD local memory.

24.5.5.3 Checking channel preemption status

Preemption is available only when fixed arbitration is selected as the channel arbitration mode. A preemptive situation is one in which a preempt-enabled channel runs and a higher priority request becomes active. When the eDMA engine is not operating in fixed channel arbitration mode, the determination of the actively running relative priority outstanding requests become undefined. Channel priorities are treated as equal, that is, constantly rotating, when Round-Robin Arbitration mode is selected.

The `TCDn_CSR[ACTIVE]` bit for the preempted channel remains asserted throughout the preemption. The preempted channel is temporarily suspended while the preempting channel executes one major loop iteration. If two `TCDn_CSR[ACTIVE]` bits are set simultaneously in the global TCD map, a higher priority channel is actively preempting a lower priority channel.

24.5.6 Channel Linking

Channel linking (or chaining) is a mechanism where one channel sets the `TCDn_CSR[START]` bit of another channel (or itself), therefore initiating a service request for that channel. When properly enabled, the EDMA engine automatically performs this operation at the major or minor loop completion.

The minor loop channel linking occurs at the completion of the minor loop (or one iteration of the major loop). The `TCDn_CITER[E_LINK]` field determines whether a minor loop link is requested. When enabled, the channel link is made after each iteration of the major loop except for the last. When the major loop is exhausted, only the major loop channel link fields are used to determine if a channel link should be made. For example, the initial fields of:

```
TCDn_CITER[E_LINK] = 1
TCDn_CITER[LINKCH] = 0xC
TCDn_CITER[CITER] value = 0x4
TCDn_CSR[MAJOR_E_LINK] = 1
TCDn_CSR[MAJOR_LINKCH] = 0x7
```

executes as:

1. Minor loop done → set `TCD12_CSR[START]` bit

2. Minor loop done → set TCD12_CSR[START] bit
3. Minor loop done → set TCD12_CSR[START] bit
4. Minor loop done, major loop done → set TCD7_CSR[START] bit

When minor loop linking is enabled ($TCDn_CITER[E_LINK] = 1$), the $TCDn_CITER[CITER]$ field uses a nine bit vector to form the current iteration count. When minor loop linking is disabled ($TCDn_CITER[E_LINK] = 0$), the $TCDn_CITER[CITER]$ field uses a 15-bit vector to form the current iteration count. The bits associated with the $TCDn_CITER[LINKCH]$ field are concatenated onto the CITER value to increase the range of the CITER.

Note

The $TCDn_CITER[E_LINK]$ bit and the $TCDn_BITER[E_LINK]$ bit must equal or a configuration error is reported. The CITER and BITER vector widths must be equal to calculate the major loop, half-way done interrupt point.

The following table summarizes how a DMA channel can link to another DMA channel, i.e, use another channel's TCD, at the end of a loop.

Table 24-10. Channel Linking Parameters

| Desired Link Behavior | TCD Control Field Name | Description |
|---------------------------|------------------------|--|
| Link at end of Minor Loop | CITER[E_LINK] | Enable channel-to-channel linking on minor loop completion (current iteration) |
| | CITER[LINKCH] | Link channel number when linking at end of minor loop (current iteration) |
| Link at end of Major Loop | CSR[MAJOR_E_LINK] | Enable channel-to-channel linking on major loop completion |
| | CSR[MAJOR_LINKCH] | Link channel number when linking at end of major loop |

24.5.7 Dynamic programming

This section provides recommended methods to change the programming model during channel execution.

24.5.7.1 Dynamically changing the channel priority

The following two options are recommended for dynamically changing channel priority levels:

1. Switch to Round-Robin Channel Arbitration mode, change the channel priorities, then switch back to Fixed Arbitration mode,
2. Disable all the channels, change the channel priorities, then enable the appropriate channels.

24.5.7.2 Dynamic channel linking

Dynamic channel linking is the process of setting the TCD.major.e_link bit during channel execution (see the diagram in [TCD structure](#)). This bit is read from the TCD local memory at the end of channel execution, thus allowing the user to enable the feature during channel execution.

Because the user is allowed to change the configuration during execution, a coherency model is needed. Consider the scenario where the user attempts to execute a dynamic channel link by enabling the TCD.major.e_link bit at the same time the eDMA engine is retiring the channel. The TCD.major.e_link would be set in the programmer's model, but it would be unclear whether the actual link was made before the channel retired.

The following coherency model is recommended when executing a dynamic channel link request.

1. Write 1 to the TCD.major.e_link bit.
2. Read back the TCD.major.e_link bit.
3. Test the TCD.major.e_link request status:
 - If TCD.major.e_link = 1, the dynamic link attempt was successful.
 - If TCD.major.e_link = 0, the attempted dynamic link did not succeed (the channel was already retiring).

For this request, the TCD local memory controller forces the TCD.major.e_link bit to zero on any writes to a channel's TCD.word7 after that channel's TCD.done bit is set, indicating the major loop is complete.

NOTE

The user must clear the TCD.done bit before writing the TCD.major.e_link bit. The TCD.done bit is cleared automatically by the eDMA engine after a channel begins execution.

24.5.7.3 Dynamic scatter/gather

Scatter/gather is the process of automatically loading a new TCD into a channel. It allows a DMA channel to use multiple TCDs; this enables a DMA channel to scatter the DMA data to multiple destinations or gather it from multiple sources. When scatter/gather is enabled and the channel has finished its major loop, a new TCD is fetched from system memory and loaded into that channel's descriptor location in eDMA programmer's model, thus replacing the current descriptor.

Because the user is allowed to change the configuration during execution, a coherency model is needed. Consider the scenario where the user attempts to execute a dynamic scatter/gather operation by enabling the TCD.e_sg bit at the same time the eDMA engine is retiring the channel. The TCD.e_sg would be set in the programmer's model, but it would be unclear whether the actual scatter/gather request was honored before the channel retired.

Two methods for this coherency model are shown in the following subsections. Method 1 has the advantage of reading the major.linkch field and the e_sg bit with a single read. For both dynamic channel linking and scatter/gather requests, the TCD local memory controller forces the TCD.major.e_link and TCD.e_sg bits to zero on any writes to a channel's TCD.word7 if that channel's TCD.done bit is set indicating the major loop is complete.

NOTE

The user must clear the TCD.done bit before writing the TCD.major.e_link or TCD.e_sg bits. The TCD.done bit is cleared automatically by the eDMA engine after a channel begins execution.

24.5.7.3.1 Method 1 (channel not using major loop channel linking)

For a channel not using major loop channel linking, the coherency model described here may be used for a dynamic scatter/gather request.

When the TCD.major.e_link bit is zero, the TCD.major.linkch field is not used by the eDMA. In this case, the TCD.major.linkch bits may be used for other purposes. This method uses the TCD.major.linkch field as a TCD identification (ID).

1. When the descriptors are built, write a unique TCD ID in the TCD.major.linkch field for each TCD associated with a channel using dynamic scatter/gather.
2. Write 1b to the TCD.d_req bit.

Should a dynamic scatter/gather attempt fail, setting the TCD.d_req bit will prevent a future hardware activation of this channel. This stops the channel from executing with a destination address (daddr) that was calculated using a scatter/gather address (written in the next step) instead of a dlast final offset value.

3. Write the TCD.dlast_sga field with the scatter/gather address.
4. Write 1b to the TCD.e_sg bit.
5. Read back the 16 bit TCD control/status field.
6. Test the TCD.e_sg request status and TCD.major.linkch value:

If e_sg = 1b, the dynamic link attempt was successful.

If e_sg = 0b and the major.linkch (ID) did not change, the attempted dynamic link did not succeed (the channel was already retiring).

If e_sg = 0b and the major.linkch (ID) changed, the dynamic link attempt was successful (the new TCD's e_sg value cleared the e_sg bit).

24.5.7.3.2 Method 2 (channel using major loop channel linking)

For a channel using major loop channel linking, the coherency model described here may be used for a dynamic scatter/gather request. This method uses the TCD.dlast_sga field as a TCD identification (ID).

1. Write 1b to the TCD.d_req bit.

Should a dynamic scatter/gather attempt fail, setting the d_req bit will prevent a future hardware activation of this channel. This stops the channel from executing with a destination address (daddr) that was calculated using a scatter/gather address (written in the next step) instead of a dlast final offset value.

2. Write the TCD.dlast_sga field with the scatter/gather address.
3. Write 1b to the TCD.e_sg bit.
4. Read back the TCD.e_sg bit.
5. Test the TCD.e_sg request status:

If e_sg = 1b, the dynamic link attempt was successful.

If e_sg = 0b, read the 32 bit TCD dlast_sga field.

If e_sg = 0b and the dlast_sga did not change, the attempted dynamic link did not succeed (the channel was already retiring).

If `e_sg = 0b` and the `dlast_sga` changed, the dynamic link attempt was successful (the new TCD's `e_sg` value cleared the `e_sg` bit).

24.5.8 Suspend/resume a DMA channel with active hardware service requests

The DMA allows the user to move data from memory or peripheral registers to another location in memory or peripheral registers without CPU interaction. Once the DMA and peripherals have been configured and are active, it is rare to suspend a peripheral's service request dynamically. In this scenario, there are certain restrictions to disabling a DMA hardware service request. For coherency, a specific procedure must be followed. This section provides guidance on how to coherently suspend and resume a Direct Memory Access (DMA) channel when the DMA is triggered by a slave module such as the Serial Peripheral Interface (DSPI), ADC, or other module.

24.5.8.1 Suspend an active DMA channel

To suspend an active DMA channel:

1. Stop the DMA service request at the peripheral first. Confirm it has been disabled by reading back the appropriate register in the peripheral.
2. Check [Hardware Request Status Register \(DMA_HRS\)](#) to ensure there is no service request to the DMA channel being suspended. Then disable the hardware service request by clearing the ERQ bit on the appropriate DMA channel.

24.5.8.2 Resume a DMA channel

To resume a DMA channel:

1. Enable the DMA service request on the appropriate channel by setting its ERQ bit.
2. Enable the DMA service request at the peripheral.

For example, assume a DSPI module is set as a master for transmitting data via a DMA service request when the DSPI_TXFIFO has an empty slot. The DMA will transfer the next command and data to the TXFIFO upon the request. If the user needs to suspend the DMA/DSPI transfer loop, perform the following steps:

1. Disable the DMA service request at the source by writing 0 to DSPI_RSER[TFFF_RE] . Confirm that DSPI_RSER[TFFF_RE] is 0.

2. Ensure there is no DMA service request from the DSPI by verifying that `DMA_HRS[HRS n]` is 0 for the appropriate channel. If no service request is present, disable the DMA channel by clearing the channel's ERQ bit. If a service request is present, wait until the request has been processed and the HRS bit reads zero.

24.5.9 Lockstep

This chip contains an eDMA Checker which, when enabled, operates in Lockstep mode with the primary eDMA, executing the exact same transfer profiles. The eDMA Checker checks to ensure the primary eDMA is operating correctly. A block diagram is shown below.

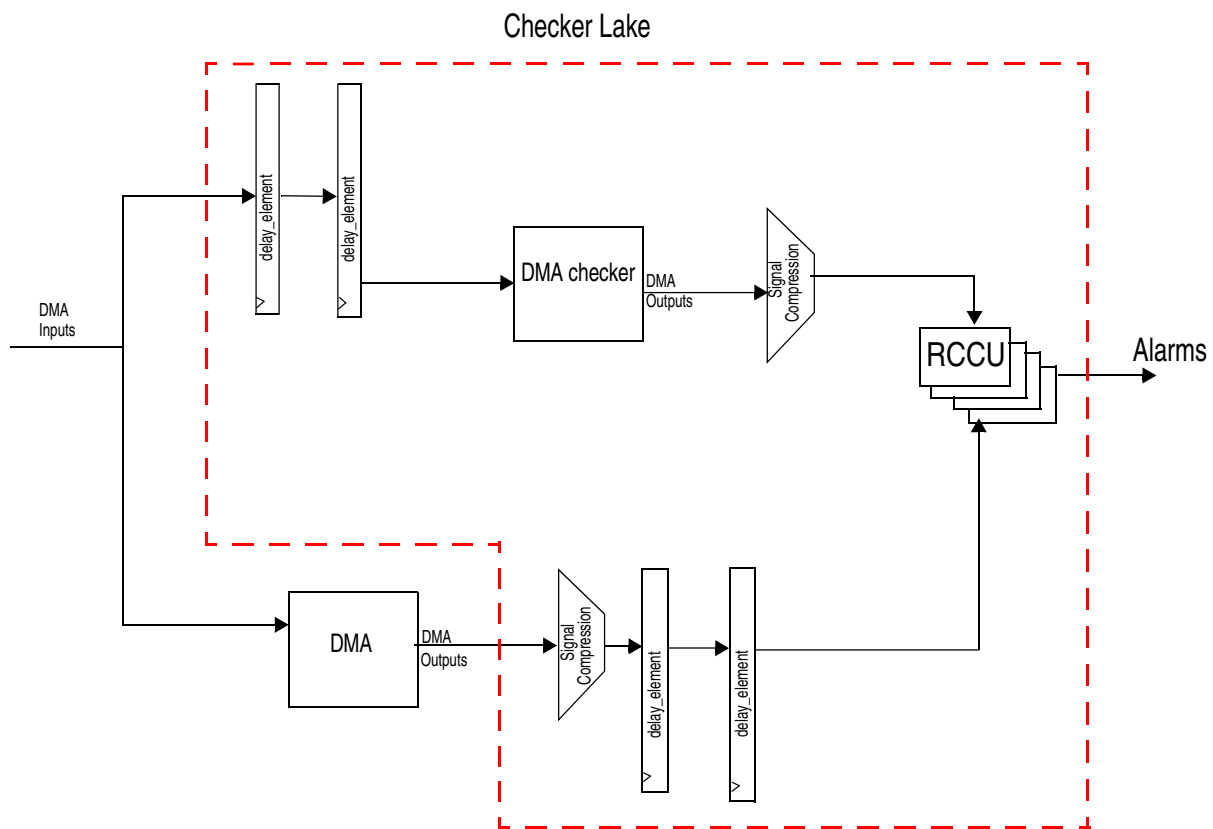

Figure 24-7. Lockstep block diagram

24.5.9.1 Initialization

To prevent the eDMA Checker from generating a false comparison error after power-on-reset, the eDMA's data output buffer must be initialized prior to enabling the Checker. To initialize the eDMA data output buffer, the eDMA must perform a one or more 32-bit data transfers using any data value.

24.5.9.2 Errors

To handle source-address errors (SAE), perform the following steps.

1. Fix the addressing error.
2. Clear the error bit in [Error Register \(DMA_ERR\)](#).
3. Start the channel in a normal fashion.

NOTE

[Error Status Register \(DMA_ES\)](#) is read-only; the bits cannot be cleared. It saves the last recorded error. The VLD bit shows the user whether any error bits in the Error Register are set, thus indicating an error occurred that hasn't been cleared.

Chapter 25

Multipurpose Clock Generator (MCG)

The Multipurpose Clock Generator (MCG) module provides several clock source choices for the MCU. The MCG operates in conjunction with a crystal oscillator, which allows an external crystal, ceramic resonator, or another external clock source to produce the external reference clock.

25.1 Introduction

The multipurpose clock generator (MCG) module provides several clock source choices for the MCU.

The module contains a frequency-locked loop (FLL). The FLL is controllable by either an internal or an external reference clock. The module can select either an FLL output clock, or a reference clock (internal or external) as a source for the MCU system clock. The MCG operates in conjunction with a crystal oscillator, which allows an external crystal, ceramic resonator, or another external clock source to produce the external reference clock.

25.1.1 Features

Key features of the MCG module are:

- Frequency-locked loop (FLL):
 - Digitally-controlled oscillator (DCO)
 - DCO frequency range is programmable for up to four different frequency ranges.
 - Option to program and maximize DCO output frequency for a low frequency external reference clock source.

- Option to prevent FLL from resetting its current locked frequency when switching clock modes if FLL reference frequency is not changed.
- Internal or external reference clock can be used as the FLL source.
- Can be used as a clock source for other on-chip peripherals.
- Internal reference clock generator:
 - Slow clock with nine trim bits for accuracy
 - Fast clock with four trim bits
 - Can be used as source clock for the FLL. In FEI mode, only the slow Internal Reference Clock (IRC) can be used as the FLL source.
 - Either the slow or the fast clock can be selected as the clock source for the MCU.
 - Can be used as a clock source for other on-chip peripherals.
- External clock from the RF Oscillator :
 - Can be used as a source for the FLL.
 - Can be selected as the clock source for the MCU.
- External clock from the Real Time Counter (RTC):
 - Can be used as a source for the FLL only.
 - Can be selected as the clock source for the MCU.
- External clock monitor with reset and interrupt request capability to check for external clock failure when running in FBE, BLPE, or FEE modes
- Internal Reference Clocks Auto Trim Machine (ATM) capability using an external clock as a reference
- Reference dividers for the FLL are provided
- Reference dividers for the Fast Internal Reference Clock are provided
- MCG FLL Clock (MCGFLLCLK) is provided as a clock source for other on-chip peripherals
- MCG Internal Reference Clock (MCGIRCLK) is provided as a clock source for other on-chip peripherals

This figure presents the block diagram of the MCG module.

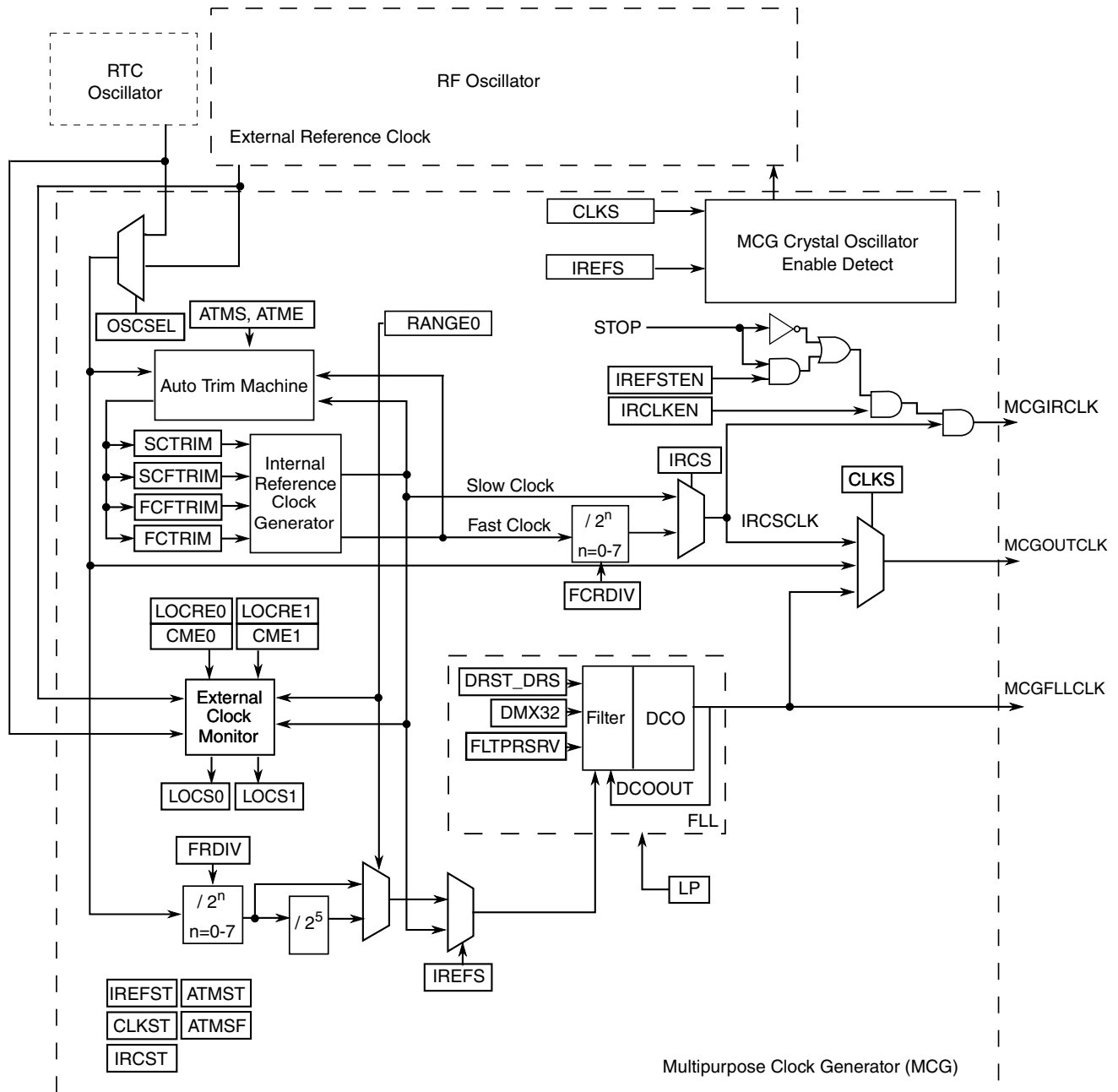

Figure 25-1. Multipurpose Clock Generator (MCG) block diagram

25.1.2 Modes of Operation

The MCG has the following modes of operation: FEI, FEE, FBI, FBE, BLPI, BLPE, and Stop. For details, see [MCG modes of operation](#).

25.2 External Signal Description

There are no MCG signals that connect off chip.

25.3 Memory Map/Register Definition

This section includes the memory map and register definition.

The MCG registers can only be written when in supervisor mode. Write accesses when in user mode will result in a bus error. Read accesses may be performed in both supervisor and user mode.

MCG memory map

| Absolute address (hex) | Register name | Width (in bits) | Access | Reset value | Section/page |
|------------------------|---|-----------------|--------|-----------------------------|-----------------------------|
| 4006_4000 | MCG Control 1 Register (MCG_C1) | 8 | R/W | 04h | 25.3.1/529 |
| 4006_4001 | MCG Control 2 Register (MCG_C2) | 8 | R/W | See section | 25.3.2/530 |
| 4006_4002 | MCG Control 3 Register (MCG_C3) | 8 | R/W | Undefined | 25.3.3/531 |
| 4006_4003 | MCG Control 4 Register (MCG_C4) | 8 | R/W | See section | 25.3.4/532 |
| 4006_4004 | MCG Control 5 Register (MCG_C5) | 8 | R/W | 00h | 25.3.5/533 |
| 4006_4005 | MCG Control 6 Register (MCG_C6) | 8 | R/W | 00h | 25.3.5/533 |
| 4006_4006 | MCG Status Register (MCG_S) | 8 | R | 10h | 25.3.6/534 |
| 4006_4008 | MCG Status and Control Register (MCG_SC) | 8 | R/W | 02h | 25.3.7/535 |
| 4006_400A | MCG Auto Trim Compare Value High Register (MCG_ATCVH) | 8 | R/W | 00h | 25.3.8/536 |
| 4006_400B | MCG Auto Trim Compare Value Low Register (MCG_ATCVL) | 8 | R/W | 00h | 25.3.9/537 |
| 4006_400C | MCG Control 7 Register (MCG_C7) | 8 | R/W | 00h | 25.3.10/537 |
| 4006_400D | MCG Control 8 Register (MCG_C8) | 8 | R/W | See section | 25.3.11/538 |
| 4006_4011 | MCG Control 12 Register (MCG_C12) | 8 | R/W | 00h | 25.3.12/539 |
| 4006_4012 | MCG Status 2 Register (MCG_S2) | 8 | R/W | 00h | 25.3.12/539 |
| 4006_4013 | MCG Test 3 Register (MCG_T3) | 8 | R/W | 00h | 25.3.12/539 |

25.3.1 MCG Control 1 Register (MCG_C1)

Address: 4006_4000h base + 0h offset = 4006_4000h

| Bit | 7 | 6 | 5 | 4 | 3 | 2 | 1 | 0 |
|-------|------|---|-------|---|---|-------|---------|----------|
| Read | CLKS | | FRDIV | | | IREFS | IRCLKEN | IREFSTEN |
| Write | | | | | | | | |
| Reset | 0 | 0 | 0 | 0 | 0 | 1 | 0 | 0 |

MCG_C1 field descriptions

| Field | Description |
|---------------|---|
| 7–6 CLKS | <p>Clock Source Select</p> <p>Selects the clock source for MCGOUTCLK .</p> <p>00 Encoding 0 — Output of FLL is selected. 01 Encoding 1 — Internal reference clock is selected. 10 Encoding 2 — External reference clock is selected. 11 Encoding 3 — Reserved.</p> |
| 5–3 FRDIV | <p>FLL External Reference Divider</p> <p>Selects the amount to divide down the external reference clock for the FLL. The resulting frequency must be in the range 31.25 kHz to 39.0625 kHz (This is required when FLL/DCO is the clock source for MCGOUTCLK . In FBE mode, it is not required to meet this range, but it is recommended in the cases when trying to enter a FLL mode from FBE).</p> <p>000 If RANGE = 0 or OSCSEL=1 , Divide Factor is 1; for all other RANGE values, Divide Factor is 32. 001 If RANGE = 0 or OSCSEL=1 , Divide Factor is 2; for all other RANGE values, Divide Factor is 64. 010 If RANGE = 0 or OSCSEL=1 , Divide Factor is 4; for all other RANGE values, Divide Factor is 128. 011 If RANGE = 0 or OSCSEL=1 , Divide Factor is 8; for all other RANGE values, Divide Factor is 256. 100 If RANGE = 0 or OSCSEL=1 , Divide Factor is 16; for all other RANGE values, Divide Factor is 512. 101 If RANGE = 0 or OSCSEL=1 , Divide Factor is 32; for all other RANGE values, Divide Factor is 1024. 110 If RANGE = 0 or OSCSEL=1 , Divide Factor is 64; for all other RANGE values, Divide Factor is 1280 . 111 If RANGE = 0 or OSCSEL=1 , Divide Factor is 128; for all other RANGE values, Divide Factor is 1536 .</p> |
| 2 IREFS | <p>Internal Reference Select</p> <p>Selects the reference clock source for the FLL.</p> <p>0 External reference clock is selected. 1 The slow internal reference clock is selected.</p> |
| 1 IRCLKEN | <p>Internal Reference Clock Enable</p> <p>Enables the internal reference clock for use as MCGIRCLK.</p> <p>0 MCGIRCLK inactive. 1 MCGIRCLK active.</p> |
| 0 IREFSTEN | <p>Internal Reference Stop Enable</p> <p>Controls whether or not the internal reference clock remains enabled when the MCG enters Stop mode.</p> |

Table continues on the next page...

MCG_C1 field descriptions (continued)

| Field | Description |
|-------|---|
| 0 | Internal reference clock is disabled in Stop mode. |
| 1 | Internal reference clock is enabled in Stop mode if IRCLKEN is set or if MCG is in FEI, FBI, or BLPI modes before entering Stop mode. |

25.3.2 MCG Control 2 Register (MCG_C2)

Address: 4006_4000h base + 1h offset = 4006_4001h

| Bit | 7 | 6 | 5 | 4 | 3 | 2 | 1 | 0 |
|-------|--------|---------|-------|---|-----|-------|----|------|
| Read | LOCRE0 | FCFTRIM | RANGE | | HGO | EREFS | LP | IRCS |
| Write | | | | | | | | |
| Reset | 1 | 1 | 0 | 0 | 0 | 0 | 0 | 0 |

MCG_C2 field descriptions

| Field | Description |
|--------------|--|
| 7 LOCRE0 | <p>Loss of Clock Reset Enable</p> <p>Determines whether an interrupt or a reset request is made following a loss of OSC0 external reference clock. The LOCRE0 only has an affect when CME0 is set.</p> <p>0 Interrupt request is generated on a loss of OSC0 external reference clock. 1 Generate a reset request on a loss of OSC0 external reference clock.</p> |
| 6 FCFTRIM | <p>Fast Internal Reference Clock Fine Trim</p> <p>FCFTRIM controls the smallest adjustment of the fast internal reference clock frequency. Setting FCFTRIM increases the period and clearing FCFTRIM decreases the period by the smallest amount possible. If an FCFTRIM value stored in nonvolatile memory is to be used, it is your responsibility to copy that value from the nonvolatile memory location to this bit.</p> |
| 5–4 RANGE | <p>Frequency Range Select</p> <p>Selects the frequency range for the crystal oscillator or external clock source. See the Oscillator (OSC) chapter for more details and the device data sheet for the frequency ranges used.</p> <p>00 Encoding 0 — Low frequency range selected for the crystal oscillator . 01 Encoding 1 — High frequency range selected for the crystal oscillator . 1X Encoding 2 — Very high frequency range selected for the crystal oscillator .</p> |
| 3 HGO | <p>High Gain Oscillator Select</p> <p>Controls the crystal oscillator mode of operation. See the Oscillator (OSC) chapter for more details.</p> <p>0 Configure crystal oscillator for low-power operation. 1 Configure crystal oscillator for high-gain operation.</p> |
| 2 EREFS | <p>External Reference Select</p> <p>Selects the source for the external reference clock. See the Oscillator (OSC) chapter for more details.</p> <p>0 External reference clock requested. 1 Oscillator requested.</p> |

Table continues on the next page...

MCG_C2 field descriptions (continued)

| Field | Description |
|-----------|--|
| 1 LP | <p>Low Power Select</p> <p>Controls whether the FLL is disabled in BLPI and BLPE modes. In FBE mode, setting this bit to 1 will transition the MCG into BLPE mode; in FBI mode, setting this bit to 1 will transition the MCG into BLPI mode. In any other MCG mode, LP bit has no affect.</p> <p>0 FLL is not disabled in bypass modes. 1 FLL is disabled in bypass modes (lower power)</p> |
| 0 IRCS | <p>Internal Reference Clock Select</p> <p>Selects between the fast or slow internal reference clock source.</p> <p>0 Slow internal reference clock selected. 1 Fast internal reference clock selected.</p> |

25.3.3 MCG Control 3 Register (MCG_C3)

Address: 4006_4000h base + 2h offset = 4006_4002h

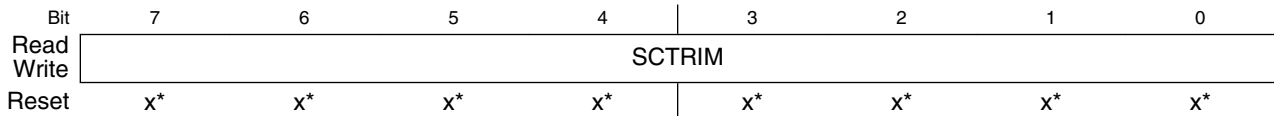

* Notes:

- x = Undefined at reset.

MCG_C3 field descriptions

| Field | Description |
|---------|--|
| SCTTRIM | <p>Slow Internal Reference Clock Trim Setting</p> <p>SCTTRIM¹ controls the slow internal reference clock frequency by controlling the slow internal reference clock period. The SCTTRIM bits are binary weighted, that is, bit 1 adjusts twice as much as bit 0. Increasing the binary value increases the period, and decreasing the value decreases the period.</p> <p>An additional fine trim bit is available in C4 register as the SCFTRIM bit. Upon reset, this value is loaded with a factory trim value.</p> <p>If an SCTTRIM value stored in nonvolatile memory is to be used, it is your responsibility to copy that value from the nonvolatile memory location to this register.</p> |

1. A value for SCTTRIM is loaded during reset from a factory programmed location.

25.3.4 MCG Control 4 Register (MCG_C4)

Address: 4006_4000h base + 3h offset = 4006_4003h

| | | | | | | | | |
|-------|-------|----------|---|--------|----|----|----|---------|
| Bit | 7 | 6 | 5 | 4 | 3 | 2 | 1 | 0 |
| Read | DMX32 | DRST_DRS | | FCTRIM | | | | SCFTRIM |
| Write | | | | | | | | |
| Reset | 0 | 0 | 0 | x* | x* | x* | x* | x* |

* Notes:

- x = Undefined at reset.

MCG_C4 field descriptions

| Field | Description | | | | | | | | | | | | | | | | | | | | | | | | | | | | | | | | | | | | | | | | | |
|-----------------|--|-------------------|------------|-----------------|------------|-----------|----|---|-------------------|-----|-----------|---|------------|-----|--------|----|---|-------------------|------|-----------|---|------------|------|--------|----|---|-------------------|------|-----------|---|------------|------|--------|----|---|-------------------|------|------------|---|------------|------|--------|
| 7 DMX32 | <p>DCO Maximum Frequency with 32.768 kHz Reference</p> <p>The DMX32 bit controls whether the DCO frequency range is narrowed to its maximum frequency with a 32.768 kHz reference.</p> <p>The following table identifies settings for the DCO frequency range.</p> <p>NOTE: The system clocks derived from this source should not exceed their specified maximums.</p> <table border="1"> <thead> <tr> <th>DRST_DRS</th> <th>DMX32</th> <th>Reference Range</th> <th>FLL Factor</th> <th>DCO Range</th> </tr> </thead> <tbody> <tr> <td rowspan="2">00</td> <td>0</td> <td>31.25–39.0625 kHz</td> <td>640</td> <td>20–25 MHz</td> </tr> <tr> <td>1</td> <td>32.768 kHz</td> <td>732</td> <td>24 MHz</td> </tr> <tr> <td rowspan="2">01</td> <td>0</td> <td>31.25–39.0625 kHz</td> <td>1280</td> <td>40–50 MHz</td> </tr> <tr> <td>1</td> <td>32.768 kHz</td> <td>1464</td> <td>48 MHz</td> </tr> <tr> <td rowspan="2">10</td> <td>0</td> <td>31.25–39.0625 kHz</td> <td>1920</td> <td>60–75 MHz</td> </tr> <tr> <td>1</td> <td>32.768 kHz</td> <td>2197</td> <td>72 MHz</td> </tr> <tr> <td rowspan="2">11</td> <td>0</td> <td>31.25–39.0625 kHz</td> <td>2560</td> <td>80–100 MHz</td> </tr> <tr> <td>1</td> <td>32.768 kHz</td> <td>2929</td> <td>96 MHz</td> </tr> </tbody> </table> <p>0 DCO has a default range of 25%. 1 DCO is fine-tuned for maximum frequency with 32.768 kHz reference.</p> | DRST_DRS | DMX32 | Reference Range | FLL Factor | DCO Range | 00 | 0 | 31.25–39.0625 kHz | 640 | 20–25 MHz | 1 | 32.768 kHz | 732 | 24 MHz | 01 | 0 | 31.25–39.0625 kHz | 1280 | 40–50 MHz | 1 | 32.768 kHz | 1464 | 48 MHz | 10 | 0 | 31.25–39.0625 kHz | 1920 | 60–75 MHz | 1 | 32.768 kHz | 2197 | 72 MHz | 11 | 0 | 31.25–39.0625 kHz | 2560 | 80–100 MHz | 1 | 32.768 kHz | 2929 | 96 MHz |
| DRST_DRS | DMX32 | Reference Range | FLL Factor | DCO Range | | | | | | | | | | | | | | | | | | | | | | | | | | | | | | | | | | | | | | |
| 00 | 0 | 31.25–39.0625 kHz | 640 | 20–25 MHz | | | | | | | | | | | | | | | | | | | | | | | | | | | | | | | | | | | | | | |
| | 1 | 32.768 kHz | 732 | 24 MHz | | | | | | | | | | | | | | | | | | | | | | | | | | | | | | | | | | | | | | |
| 01 | 0 | 31.25–39.0625 kHz | 1280 | 40–50 MHz | | | | | | | | | | | | | | | | | | | | | | | | | | | | | | | | | | | | | | |
| | 1 | 32.768 kHz | 1464 | 48 MHz | | | | | | | | | | | | | | | | | | | | | | | | | | | | | | | | | | | | | | |
| 10 | 0 | 31.25–39.0625 kHz | 1920 | 60–75 MHz | | | | | | | | | | | | | | | | | | | | | | | | | | | | | | | | | | | | | | |
| | 1 | 32.768 kHz | 2197 | 72 MHz | | | | | | | | | | | | | | | | | | | | | | | | | | | | | | | | | | | | | | |
| 11 | 0 | 31.25–39.0625 kHz | 2560 | 80–100 MHz | | | | | | | | | | | | | | | | | | | | | | | | | | | | | | | | | | | | | | |
| | 1 | 32.768 kHz | 2929 | 96 MHz | | | | | | | | | | | | | | | | | | | | | | | | | | | | | | | | | | | | | | |
| 6–5 DRST_DRS | <p>DCO Range Select</p> <p>The DRS bits select the frequency range for the FLL output, DCOOUT. When the LP bit is set, writes to the DRS bits are ignored. The DRST read field indicates the current frequency range for DCOOUT. The DRST field does not update immediately after a write to the DRS field due to internal synchronization between clock domains. See the DCO Frequency Range table for more details.</p> <p>00 Encoding 0 — Low range (reset default). 01 Encoding 1 — Mid range. 10 Encoding 2 — Mid-high range. 11 Encoding 3 — High range.</p> | | | | | | | | | | | | | | | | | | | | | | | | | | | | | | | | | | | | | | | | | |
| 4–1 FCTRIM | Fast Internal Reference Clock Trim Setting | | | | | | | | | | | | | | | | | | | | | | | | | | | | | | | | | | | | | | | | | |

Table continues on the next page...

MCG_C4 field descriptions (continued)

| Field | Description |
|--------------|---|
| | FCTRIM ¹ controls the fast internal reference clock frequency by controlling the fast internal reference clock period. The FCTRIM bits are binary weighted, that is, bit 1 adjusts twice as much as bit 0. Increasing the binary value increases the period, and decreasing the value decreases the period. If an FCTRIM[3:0] value stored in nonvolatile memory is to be used, it is your responsibility to copy that value from the nonvolatile memory location to this register. |
| 0 SCFTRIM | Slow Internal Reference Clock Fine Trim SCFTRIM ² controls the smallest adjustment of the slow internal reference clock frequency. Setting SCFTRIM increases the period and clearing SCFTRIM decreases the period by the smallest amount possible. If an SCFTRIM value stored in nonvolatile memory is to be used, it is your responsibility to copy that value from the nonvolatile memory location to this bit. |

1. A value for FCTRIM is loaded during reset from a factory programmed location.
2. A value for SCFTRIM is loaded during reset from a factory programmed location.

25.3.5 MCG Control 5 Register (MCG_C5)

Address: 4006_4000h base + 4h offset = 4006_4004h

| Bit | 7 | 6 | 5 | 4 | 3 | 2 | 1 | 0 |
|-------|---|---|---|---|---|---|---|---|
| Read | 0 | | | | | | | |
| Write | | | | | | | | |
| Reset | 0 | 0 | 0 | 0 | 0 | 0 | 0 | 0 |

MCG_C5 field descriptions

| Field | Description |
|----------|---|
| Reserved | Reserved This field is reserved. This read-only field is reserved and always has the value 0. |

25.3.5 MCG Control 6 Register (MCG_C6)

Address: 4006_4000h base + 5h offset = 4006_4005h

| Bit | 7 | 6 | 5 | 4 | 3 | 2 | 1 | 0 |
|-------|---|---|------|---|---|---|---|---|
| Read | 0 | | CME0 | 0 | | | | |
| Write | | | | | | | | |
| Reset | 0 | 0 | 0 | 0 | 0 | 0 | 0 | 0 |

MCG_C6 field descriptions

| Field | Description |
|-----------------|-------------|
| 7–6 Reserved | Reserved |

Table continues on the next page...

MCG_C6 field descriptions (continued)

| Field | Description |
|-----------|--|
| | This field is reserved. This read-only field is reserved and always has the value 0. |
| 5 CME0 | <p>Clock Monitor Enable</p> <p>Determines if an interrupt or a reset request (see MCG_C2[LOCRE0]) is made following a loss of external clock indication. The CME0 bit should only be set to a logic 1 when the MCG is in an operational mode that uses the external clock (FEE, FBE, or BLPE). Whenever the CME0 bit is set to a logic 1, the value of the RANGE bits in the C2 register should not be changed. CME0 bit should be set to a logic 0 before the MCG enters any Stop mode. Otherwise, a reset request may occur when in Stop mode. CME0 should also be set to a logic 0 before entering VLPR or VLPW power modes if the MCG is in BLPE mode.</p> <p>0 External clock monitor is disabled. 1 Generate an interrupt or a reset request (see MCG_C2[LOCRE0]) on loss of external clock.</p> |
| Reserved | <p>Reserved</p> <p>This field is reserved. This read-only field is reserved and always has the value 0.</p> |

25.3.6 MCG Status Register (MCG_S)

Address: 4006_4000h base + 6h offset = 4006_4006h

| | | | | | | | | | |
|-------|---|---|---|--------|---|-------|---|----------|-------|
| Bit | 7 | 6 | 5 | 4 | 3 | 2 | 1 | 0 | |
| Read | | 0 | | IREFST | | CLKST | | OSCINIT0 | IRCST |
| Write | | | | | | | | | |
| Reset | 0 | 0 | 0 | 1 | 0 | 0 | 0 | 0 | |

MCG_S field descriptions

| Field | Description |
|-----------------|--|
| 7–5 Reserved | <p>Reserved</p> <p>This field is reserved. This read-only field is reserved and always has the value 0.</p> |
| 4 IREFST | <p>Internal Reference Status</p> <p>This bit indicates the current source for the FLL reference clock. The IREFST bit does not update immediately after a write to the IREFS bit due to internal synchronization between clock domains.</p> <p>0 Source of FLL reference clock is the external reference clock. 1 Source of FLL reference clock is the internal reference clock.</p> |
| 3–2 CLKST | <p>Clock Mode Status</p> <p>These bits indicate the current clock mode. The CLKST bits do not update immediately after a write to the CLKS bits due to internal synchronization between clock domains.</p> <p>00 Encoding 0 — Output of the FLL is selected (reset default). 01 Encoding 1 — Internal reference clock is selected.</p> |

Table continues on the next page...

MCG_S field descriptions (continued)

| Field | Description |
|---------------|--|
| | 10 Encoding 2 — External reference clock is selected. 11 Reserved. |
| 1 OSCINIT0 | OSC Initialization This bit, which resets to 0, is set to 1 after the initialization cycles of the RF oscillator clock have completed. After being set, the bit is cleared to 0 if the OSC is subsequently disabled. See the OSC module's detailed description for more information. |
| 0 IRCST | Internal Reference Clock Status The IRCST bit indicates the current source for the internal reference clock select clock (IRCSCLK). The IRCST bit does not update immediately after a write to the IRCS bit due to internal synchronization between clock domains. The IRCST bit will only be updated if the internal reference clock is enabled, either by the MCG being in a mode that uses the IRC or by setting the C1[IRCLKEN] bit. 0 Source of internal reference clock is the slow clock (32 kHz IRC). 1 Source of internal reference clock is the fast clock (4 MHz IRC). |

25.3.7 MCG Status and Control Register (MCG_SC)

Address: 4006_4000h base + 8h offset = 4006_4008h

| Bit | 7 | 6 | 5 | 4 | 3 | 2 | 1 | 0 |
|-------|------|------|------|----------|--------|---|---|-------|
| Read | ATME | ATMS | ATMF | FLTPRSRV | FCRDIV | | | LOCS0 |
| Write | | | w1c | | | | | w1c |
| Reset | 0 | 0 | 0 | 0 | 0 | 0 | 1 | 0 |

MCG_SC field descriptions

| Field | Description |
|-----------|---|
| 7 ATME | Automatic Trim Machine Enable Enables the Auto Trim Machine to start automatically trimming the selected Internal Reference Clock. NOTE: ATME deasserts after the Auto Trim Machine has completed trimming all trim bits of the IRCS clock selected by the ATMS bit. Writing to C1, C3, C4, and SC registers or entering Stop mode aborts the auto trim operation and clears this bit. 0 Auto Trim Machine disabled. 1 Auto Trim Machine enabled. |
| 6 ATMS | Automatic Trim Machine Select Selects the IRCS clock for Auto Trim Test. 0 32 kHz Internal Reference Clock selected. 1 4 MHz Internal Reference Clock selected. |
| 5 ATMF | Automatic Trim Machine Fail Flag |

Table continues on the next page...

MCG_SC field descriptions (continued)

| Field | Description |
|---------------|--|
| | <p>Fail flag for the Automatic Trim Machine (ATM). This bit asserts when the Automatic Trim Machine is enabled, ATME=1, and a write to the C1, C3, C4, and SC registers is detected or the MCG enters into any Stop mode. A write to ATMF clears the flag.</p> <p>0 Automatic Trim Machine completed normally. 1 Automatic Trim Machine failed.</p> |
| 4 FLTPRSRV | <p>FLL Filter Preserve Enable</p> <p>This bit will prevent the FLL filter values from resetting allowing the FLL output frequency to remain the same during clock mode changes where the FLL/DCO output is still valid. (Note: This requires that the FLL reference frequency to remain the same as what it was prior to the new clock mode switch. Otherwise FLL filter and frequency values will change.)</p> <p>0 FLL filter and FLL frequency will reset on changes to correct clock mode. 1 FLL filter and FLL frequency retain their previous values during new clock mode change.</p> |
| 3-1 FCRDIV | <p>Fast Clock Internal Reference Divider</p> <p>Selects the amount to divide down the fast internal reference clock. The resulting frequency will be in the range 31.25 kHz to 4 MHz (Note: Changing the divider when the Fast IRC is enabled is not supported).</p> <p>000 Divide Factor is 1 001 Divide Factor is 2. 010 Divide Factor is 4. 011 Divide Factor is 8. 100 Divide Factor is 16 101 Divide Factor is 32 110 Divide Factor is 64 111 Divide Factor is 128.</p> |
| 0 LOCS0 | <p>OSC0 Loss of Clock Status</p> <p>The LOCS0 indicates when a loss of OSC0 reference clock has occurred. The LOCS0 bit only has an effect when CME0 is set. This bit is cleared by writing a logic 1 to it when set.</p> <p>0 Loss of OSC0 has not occurred. 1 Loss of OSC0 has occurred.</p> |

25.3.8 MCG Auto Trim Compare Value High Register (MCG_ATCVH)

Address: 4006_4000h base + Ah offset = 4006_400Ah

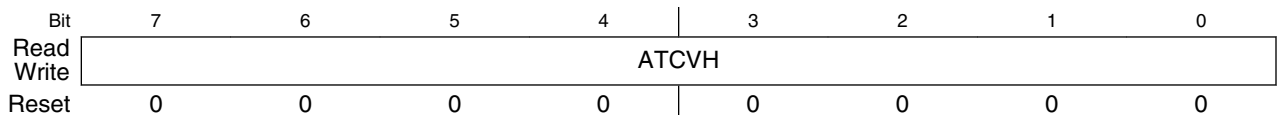

MCG_ATCVH field descriptions

| Field | Description |
|-------|--|
| ATCVH | ATM Compare Value High Values are used by Auto Trim Machine to compare and adjust Internal Reference trim values during ATM SAR conversion. |

25.3.9 MCG Auto Trim Compare Value Low Register (MCG_ATCVL)

Address: 4006_4000h base + Bh offset = 4006_400Bh

| Bit | 7 | 6 | 5 | 4 | 3 | 2 | 1 | 0 |
|-------|-------|---|---|---|---|---|---|---|
| Read | ATCVL | | | | | | | |
| Write | ATCVL | | | | | | | |
| Reset | 0 | 0 | 0 | 0 | 0 | 0 | 0 | 0 |

MCG_ATCVL field descriptions

| Field | Description |
|-------|---|
| ATCVL | ATM Compare Value Low Values are used by Auto Trim Machine to compare and adjust Internal Reference trim values during ATM SAR conversion. |

25.3.10 MCG Control 7 Register (MCG_C7)

Address: 4006_4000h base + Ch offset = 4006_400Ch

| Bit | 7 | 6 | 5 | 4 | 3 | 2 | 1 | 0 |
|-------|---|---|---|---|---|---|---|--------|
| Read | 0 | | | | 0 | | 0 | OSCSEL |
| Write | | | | | | | | |
| Reset | 0 | 0 | 0 | 0 | 0 | 0 | 0 | 0 |

MCG_C7 field descriptions

| Field | Description |
|-----------------|---|
| 7–6 Reserved | This field is reserved. This read-only field is reserved and always has the value 0. |
| 5–2 Reserved | Reserved This field is reserved. This read-only field is reserved and always has the value 0. |
| 1 Reserved | Reserved This field is reserved. This read-only field is reserved and always has the value 0. |

Table continues on the next page...

MCG_C7 field descriptions (continued)

| Field | Description |
|-------------|--|
| 0 OSCSEL | <p>MCG OSC Clock Select</p> <p>Selects the MCG FLL external reference clock</p> <p>0 Selects Oscillator (OSCCLK). 1 Selects 32 kHz RTC Oscillator.</p> |

25.3.11 MCG Control 8 Register (MCG_C8)

Address: 4006_4000h base + Dh offset = 4006_400Dh



MCG_C8 field descriptions

| Field | Description |
|-----------------|--|
| 7 LOCRE1 | <p>Loss of Clock Reset Enable</p> <p>Determines if a interrupt or a reset request is made following a loss of RTC external reference clock. The LOCRE1 only has an affect when CME1 is set.</p> <p>0 Interrupt request is generated on a loss of RTC external reference clock. 1 Generate a reset request on a loss of RTC external reference clock</p> |
| 6 Reserved | <p>This field is reserved. This read-only field is reserved and always has the value 0.</p> |
| 5 CME1 | <p>Clock Monitor Enable1</p> <p>Enables the loss of clock monitoring circuit for the output of the RTC external reference clock. The LOCRE1 bit will determine whether an interrupt or a reset request is generated following a loss of RTC clock indication. The CME1 bit should be set to a logic 1 when the MCG is in an operational mode that uses the RTC as its external reference clock or if the RTC is operational. CME1 bit must be set to a logic 0 before the MCG enters any Stop mode. Otherwise, a reset request may occur when in Stop mode. CME1 should also be set to a logic 0 before entering VLPR or VLPW power modes.</p> <p>0 External clock monitor is disabled for RTC clock. 1 External clock monitor is enabled for RTC clock.</p> |
| 4-1 Reserved | <p>This field is reserved. This read-only field is reserved and always has the value 0.</p> |
| 0 LOCS1 | <p>RTC Loss of Clock Status</p> <p>This bit indicates when a loss of clock has occurred. This bit is cleared by writing a logic 1 to it when set.</p> <p>0 Loss of RTC has not occur. 1 Loss of RTC has occur</p> |

25.3.12 MCG Control 12 Register (MCG_C12)

Address: 4006_4000h base + 11h offset = 4006_4011h

| | | | | | | | | |
|-------|---|---|---|---|---|---|---|---|
| Bit | 7 | 6 | 5 | 4 | 3 | 2 | 1 | 0 |
| Read | 0 | | | | | | | |
| Write | | | | | | | | |
| Reset | 0 | 0 | 0 | 0 | 0 | 0 | 0 | 0 |

MCG_C12 field descriptions

| Field | Description |
|----------|---|
| Reserved | This field is reserved. This read-only field is reserved and always has the value 0. |

25.3.12 MCG Status 2 Register (MCG_S2)

Address: 4006_4000h base + 12h offset = 4006_4012h

| | | | | | | | | |
|-------|---|---|---|---|---|---|---|---|
| Bit | 7 | 6 | 5 | 4 | 3 | 2 | 1 | 0 |
| Read | 0 | | | | | | | |
| Write | | | | | | | | |
| Reset | 0 | 0 | 0 | 0 | 0 | 0 | 0 | 0 |

MCG_S2 field descriptions

| Field | Description |
|----------|---|
| Reserved | This field is reserved. This read-only field is reserved and always has the value 0. |

25.3.12 MCG Test 3 Register (MCG_T3)

Address: 4006_4000h base + 13h offset = 4006_4013h

| | | | | | | | | |
|-------|---|---|---|---|---|---|---|---|
| Bit | 7 | 6 | 5 | 4 | 3 | 2 | 1 | 0 |
| Read | 0 | | | | | | | |
| Write | | | | | | | | |
| Reset | 0 | 0 | 0 | 0 | 0 | 0 | 0 | 0 |

MCG_T3 field descriptions

| Field | Description |
|----------|---|
| Reserved | This field is reserved. This read-only field is reserved and always has the value 0. |

25.4 Functional description

25.4.1 MCG mode state diagram

The seven states of the MCG are shown in the following figure and are described in [Table 25-1](#). The arrows indicate the permitted MCG mode transitions.

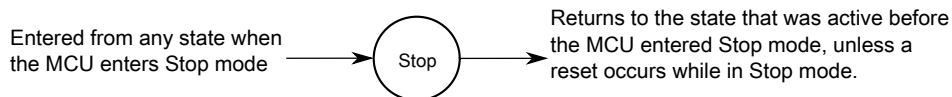
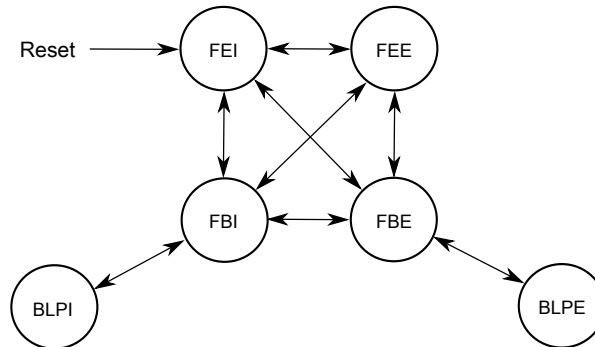

Figure 25-2. MCG mode state diagram

25.4.1.1 MCG modes of operation

The MCG operates in one of the following modes.

Note

The MCG restricts transitions between modes. For the permitted transitions, see [Figure 25-2](#).

Table 25-1. MCG modes of operation

| Mode | Description |
|------------------------------------|---|
| FLL Engaged Internal (FEI) | <p>FLL engaged internal (FEI) is the default mode of operation and is entered when all the following conditions occur:</p> <ul style="list-style-type: none"> • 00 is written to C1[CLKS]. • 1 is written to C1[IREFS]. <p>In FEI mode, MCGOUTCLK is derived from the FLL clock (DCOCLK) that is controlled by the 32 kHz Internal Reference Clock (IRC). The FLL loop will lock the DCO frequency to the FLL factor, as selected by C4[DRST_DRS] and C4[DMX32] bits, times the internal reference frequency. See the C4[DMX32] bit description for more details.</p> |
| FLL Engaged External (FEE) | <p>FLL engaged external (FEE) mode is entered when all the following conditions occur:</p> <ul style="list-style-type: none"> • 00 is written to C1[CLKS]. • 0 is written to C1[IREFS]. • C1[FRDIV] must be written to divide external reference clock to be within the range of 31.25 kHz to 39.0625 kHz <p>In FEE mode, MCGOUTCLK is derived from the FLL clock (DCOCLK) that is controlled by the external reference clock. The FLL loop will lock the DCO frequency to the FLL factor, as selected by C4[DRST_DRS] and C4[DMX32] bits, times the external reference frequency, as specified by C1[FRDIV] and C2[RANGE]. See the C4[DMX32] bit description for more details.</p> |
| FLL Bypassed Internal (FBI) | <p>FLL bypassed internal (FBI) mode is entered when all the following conditions occur:</p> <ul style="list-style-type: none"> • 01 is written to C1[CLKS]. • 1 is written to C1[IREFS]. • 0 is written to C2[LP]. <p>In FBI mode, the MCGOUTCLK is derived either from the slow (32 kHz IRC) or fast (4 MHz IRC) internal reference clock, as selected by the C2[IRCS] bit. The FLL is operational but its output is not used. This mode is useful to allow the FLL to acquire its target frequency while the MCGOUTCLK is driven from the C2[IRCS] selected internal reference clock. The FLL clock (DCOCLK) is controlled by the slow internal reference clock, and the DCO clock frequency locks to a multiplication factor, as selected by C4[DRST_DRS] and C4[DMX32] bits, times the internal reference frequency. See the C4[DMX32] bit description for more details.</p> |
| FLL Bypassed External (FBE) | <p>FLL bypassed external (FBE) mode is entered when all the following conditions occur:</p> <ul style="list-style-type: none"> • 10 is written to C1[CLKS]. • 0 is written to C1[IREFS]. • C1[FRDIV] must be written to divide external reference clock to be within the range of 31.25 kHz to 39.0625 kHz. • 0 is written to C2[LP]. <p>In FBE mode, the MCGOUTCLK is derived from the OSCSEL external reference clock. The FLL is operational but its output is not used. This mode is useful to allow the FLL to acquire its target frequency while the MCGOUTCLK is driven from the external reference clock. The FLL clock (DCOCLK) is controlled by the external reference clock, and the DCO clock frequency locks to a multiplication factor, as selected by C4[DRST_DRS] and C4[DMX32] bits, times the divided external reference frequency. See the C4[DMX32] bit description for more details.</p> |
| Bypassed Low Power Internal (BLPI) | <p>Bypassed Low Power Internal (BLPI) mode is entered when all the following conditions occur:</p> |

Table continues on the next page...

Table 25-1. MCG modes of operation (continued)

| Mode | Description |
|------------------------------------|---|
| | <ul style="list-style-type: none"> • 01 is written to C1[CLKS]. • 1 is written to C1[IREFS]. • 1 is written to C2[LP]. <p>In BLPI mode, MCGOUTCLK is derived from the internal reference clock. The FLL is disabled</p> |
| Bypassed Low Power External (BLPE) | <p>Bypassed Low Power External (BLPE) mode is entered when all the following conditions occur:</p> <ul style="list-style-type: none"> • 10 is written to C1[CLKS]. • 0 is written to C1[IREFS]. • 1 is written to C2[LP]. <p>In BLPE mode, MCGOUTCLK is derived from the OSCSEL external reference clock. The FLL is disabled</p> |
| Stop | <p>Entered whenever the MCU enters a Stop state. The power modes are chip specific. For power mode assignments, see the Power management chapter that describes how modules are configured and MCG behavior during Stop recovery. Entering Stop mode, the FLL is disabled, and all MCG clock signals are static except in the following case:</p> <p>MCGIRCLK is active in Normal Stop mode when all the following conditions become true:</p> <ul style="list-style-type: none"> • C1[IRCLKEN] = 1 • C1[IREFSTEN] = 1 <p>NOTE:</p> <ul style="list-style-type: none"> • In VLPS Stop Mode, the MCGIRCLK can be programmed to stay enabled and continue running if C1[IRCLKEN] = 1, C1[IREFSTEN]=1, and Fast IRC clock is selected (C2[IRCS] = 1) |

NOTE

For the chip-specific modes of operation, see the power management chapter of this MCU.

25.4.1.2 MCG mode switching

C1[IREFS] can be changed at any time, but the actual switch to the newly selected reference clocks is shown by S[IREFST]. When switching between engaged internal and engaged external modes, the FLL will begin locking again after the switch is completed.

C1[CLKS] can also be changed at any time, but the actual switch to the newly selected clock is shown by S[CLKST]. If the newly selected clock is not available, the previous clock will remain selected.

The C4[DRST_DRS] write bits can be changed at any time except when C2[LP] bit is 1. If C4[DRST_DRS] write bits are changed while in FLL engaged internal (FEI) or FLL engaged external (FEE) mode, the MCGOUTCLK switches to the new selected DCO

range within three clocks of the selected DCO clock. After switching to the new DCO (indicated by the updated C4[DRST_DRS] read bits), the FLL remains unlocked for several reference cycles. The FLL lock time is provided in the device data sheet as $t_{\text{fll_acquire}}$.

25.4.2 Low-power bit usage

C2[LP] is provided to allow the FLL to be disabled and thus conserve power when these systems are not being used. C4[DRST_DRS] can not be written while C2[LP] is 1. However, in some applications, it may be desirable to enable the FLL and allow it to lock for maximum accuracy before switching to an engaged mode. Do this by writing 0 to C2[LP].

25.4.3 MCG Internal Reference Clocks

This module supports two internal reference clocks with nominal frequencies of 32 kHz (slow IRC) and 4 MHz (fast IRC). The fast IRC frequency can be divided down by programming of the FCRDIV to produce a frequency range of 32 kHz to 4 MHz.

25.4.3.1 MCG Internal Reference Clock

The MCG Internal Reference Clock (MCGIRCLK) provides a clock source for other on-chip peripherals and is enabled when C1[IRCLKEN]=1. When enabled, MCGIRCLK is driven by either the fast internal reference clock (4 MHz IRC which can be divided down by the FCRDIV factors) or the slow internal reference clock (32 kHz IRC). The IRCS clock frequency can be re-targeted by trimming the period of its IRCS selected internal reference clock. This can be done by writing a new trim value to the C3[SCTRIM]:C4[SCFTRIM] bits when the slow IRC clock is selected or by writing a new trim value to C4[FCTRIM]:C2[FCFTRIM] when the fast IRC clock is selected. The internal reference clock period is proportional to the trim value written. C3[SCTRIM]:C4[SCFTRIM] (if C2[IRCS]=0) and C4[FCTRIM]:C2[FCFTRIM] (if C2[IRCS]=1) bits affect the MCGOUTCLK frequency if the MCG is in FBI or BLPI modes. C3[SCTRIM]:C4[SCFTRIM] (if C2[IRCS]=0) bits also affect the MCGOUTCLK frequency if the MCG is in FEI mode.

Additionally, this clock can be enabled in Stop mode by setting C1[IRCLKEN] and C1[IREFSTEN], otherwise this clock is disabled in Stop mode.

25.4.4 External Reference Clock

The MCG module can support an external reference clock in all modes. See the device datasheet for external reference frequency range. When C1[IREFS] is set, the external reference clock will not be used by the FLL. In these mode, the frequency can be equal to the maximum frequency the chip-level timing specifications will support.

If any of the CME bits are asserted the slow internal reference clock is enabled along with the enabled external clock monitor. For the case when C6[CME0]=1, a loss of clock is detected if the OSC0 external reference falls below a minimum frequency (f_{loc_high} or f_{loc_low} depending on C2[RANGE0]). For the case when C8[CME1]=1, a loss of clock is detected if the RTC external reference falls below a minimum frequency (f_{loc_low}).

NOTE

All clock monitors must be disabled before entering these low-power modes: Stop, VLPS, VLPR, VLPW, LLS, and VLLSx.

On detecting a loss-of-clock event, the MCU generates a system reset if the respective LOCRE bit is set. Otherwise the MCG sets the respective LOCS bit and the MCG generates a LOCS interrupt request.

25.4.5 MCG Auto TRIM (ATM)

The MCG Auto Trim (ATM) is a MCG feature that when enabled, it configures the MCG hardware to automatically trim the MCG Internal Reference Clocks using an external clock as a reference. The selection between which MCG IRC clock gets tested and enabled is controlled by the ATC[ATMS] control bit (ATC[ATMS]=0 selects the 32 kHz IRC and ATC[ATMS]=1 selects the 4 MHz IRC). If 4 MHz IRC is selected for the ATM, a divide by 128 is enabled to divide down the 4 MHz IRC to a range of 31.250 kHz.

When MCG ATM is enabled by writing ATC[ATME] bit to 1, The ATM machine will start auto trimming the selected IRC clock. During the autotrim process, ATC[ATME] will remain asserted and will deassert after ATM is completed or an abort occurs. The MCG ATM is aborted if a write to any of the following control registers is detected : C1, C3, C4, or ATC or if Stop mode is entered. If an abort occurs, ATC[ATMF] fail flag is asserted.

The ATM machine uses the bus clock as the external reference clock to perform the IRC auto-trim. Therefore, it is required that the MCG is configured in a clock mode where the reference clock used to generate the system clock is the external reference clock such as FBE clock mode. The MCG must not be configured in a clock mode where selected IRC ATM clock is used to generate the system clock. The bus clock is also required to be running with in the range of 8–16 MHz.

To perform the ATM on the selected IRC, the ATM machine uses the successive approximation technique to adjust the IRC trim bits to generate the desired IRC trimmed frequency. The ATM SARs each of the ATM IRC trim bits starting with the MSB. For each trim bit test, the ATM uses a pulse that is generated by the ATM selected IRC clock to enable a counter that counts number of ATM external clocks. At end of each trim bit, the ATM external counter value is compared to the ATCV[15:0] register value. Based on the comparison result, the ATM trim bit under test will get cleared or stay asserted. This is done until all trim bits have been tested by ATM SAR machine.

Before the ATM can be enabled, the ATM expected count needs to be derived and stored into the ATCV register. The ATCV expected count is derived based on the required target Internal Reference Clock (IRC) frequency, and the frequency of the external reference clock using the following formula:

$$\text{ATCV ExpectedCount Value} = 21 * (\text{Fe} / \text{Fr})$$

- Fr = Target Internal Reference Clock (IRC) Trimmed Frequency
- Fe = External Clock Frequency

If the auto trim is being performed on the 4 MHz IRC, the calculated expected count value must be multiplied by 128 before storing it in the ATCV register. Therefore, the ATCV Expected Count Value for trimming the 4 MHz IRC is calculated using the following formula.

$$\text{ExpectedCount Value} = (\text{Fe} / \text{Fr}) * 21 * (128)$$

25.5 Initialization / Application information

This section describes how to initialize and configure the MCG module in an application.

The following sections include examples on how to initialize the MCG and properly switch between the various available modes.

25.5.1 MCG module initialization sequence

The MCG comes out of reset configured for FEI mode.

The internal reference will stabilize in t_{refsts} microseconds before the FLL can acquire lock. As soon as the internal reference is stable, the FLL will acquire lock in $t_{\text{fll_acquire}}$ milliseconds.

25.5.1.1 Initializing the MCG

Because the MCG comes out of reset in FEI mode, the only MCG modes that can be directly switched to upon reset are FEE, FBE, and FBI modes (see [Figure 25-2](#)). Reaching any of the other modes requires first configuring the MCG for one of these three intermediate modes. Care must be taken to check relevant status bits in the MCG status register reflecting all configuration changes within each mode.

To change from FEI mode to FEE or FBE modes, follow this procedure:

1. Enable the external clock source by setting the appropriate bits in C2 register.
2. Write to C1 register to select the clock mode.
 - If entering FEE mode, set C1[FRDIV] appropriately, clear C1[IREFS] bit to switch to the external reference, and leave C1[CLKS] at 2'b00 so that the output of the FLL is selected as the system clock source.
 - If entering FBE, clear C1[IREFS] to switch to the external reference and change C1[CLKS] to 2'b10 so that the external reference clock is selected as the system clock source. The C1[FRDIV] bits should also be set appropriately here according to the external reference frequency to keep the FLL reference clock in the range of 31.25 kHz to 39.0625 kHz. Although the FLL is bypassed, it is still on in FBE mode.
 - The internal reference can optionally be kept running by setting C1[IRCLKEN]. This is useful if the application will switch back and forth between internal and external modes. For minimum power consumption, leave the internal reference disabled while in an external clock mode.
3. Once the proper configuration bits have been set, wait for the affected bits in the MCG status register to be changed appropriately, reflecting that the MCG has moved into the proper mode.
 - If the MCG is in FEE, FBE, or BLPE mode, and C2[EREFS] was also set in step 1, wait here for S[OSCINIT0] bit to become set indicating that the external clock source has finished its initialization cycles and stabilized.
 - If in FEE mode, check to make sure S[IREFST] is cleared before moving on.
 - If in FBE mode, check to make sure S[IREFST] is cleared and S[CLKST] bits have changed to 2'b10 indicating the external reference clock has been appropriately selected. Although the FLL is bypassed, it is still on in FBE mode.

4. Write to the C4 register to determine the DCO output (MCGFLLCLK) frequency range.
 - By default, with C4[DMX32] cleared to 0, the FLL multiplier for the DCO output is 640. For greater flexibility, if a mid-low-range FLL multiplier of 1280 is desired instead, set C4[DRST_DRS] bits to 2'b01 for a DCO output frequency of 40 MHz. If a mid high-range FLL multiplier of 1920 is desired instead, set the C4[DRST_DRS] bits to 2'b10 for a DCO output frequency of 60 MHz. If a high-range FLL multiplier of 2560 is desired instead, set the C4[DRST_DRS] bits to 2'b11 for a DCO output frequency of 80 MHz.
 - When using a 32.768 kHz external reference, if the maximum low-range DCO frequency that can be achieved with a 32.768 kHz reference is desired, set C4[DRST_DRS] bits to 2'b00 and set C4[DMX32] bit to 1. The resulting DCO output (MCGOUTCLK) frequency with the new multiplier of 732 will be 24 MHz.
 - When using a 32.768 kHz external reference, if the maximum mid-range DCO frequency that can be achieved with a 32.768 kHz reference is desired, set C4[DRST_DRS] bits to 2'b01 and set C4[DMX32] bit to 1. The resulting DCO output (MCGOUTCLK) frequency with the new multiplier of 1464 will be 48 MHz.
 - When using a 32.768 kHz external reference, if the maximum mid high-range DCO frequency that can be achieved with a 32.768 kHz reference is desired, set C4[DRST_DRS] bits to 2'b10 and set C4[DMX32] bit to 1. The resulting DCO output (MCGOUTCLK) frequency with the new multiplier of 2197 will be 72 MHz.
 - When using a 32.768 kHz external reference, if the maximum high-range DCO frequency that can be achieved with a 32.768 kHz reference is desired, set C4[DRST_DRS] bits to 2'b11 and set C4[DMX32] bit to 1. The resulting DCO output (MCGOUTCLK) frequency with the new multiplier of 2929 will be 96 MHz.
5. Wait for the FLL lock time to guarantee FLL is running at new C4[DRST_DRS] and C4[DMX32] programmed frequency.

To change from FEI clock mode to FBI clock mode, follow this procedure:

1. Change C1[CLKS] bits in C1 register to 2'b01 so that the internal reference clock is selected as the system clock source.

2. Wait for S[CLKST] bits in the MCG status register to change to 2'b01, indicating that the internal reference clock has been appropriately selected.
3. Write to the C2 register to determine the IRCS output (IRCSCLK) frequency range.
 - By default, with C2[IRCS] cleared to 0, the IRCS selected output clock is the slow internal reference clock (32 kHz IRC). If the faster IRC is desired, set C2[IRCS] to 1 for a IRCS clock derived from the 4 MHz IRC source.

25.5.2 Using a 32.768 kHz reference

In FEE and FBE modes, if using a 32.768 kHz external reference, at the default FLL multiplication factor of 640, the DCO output (MCGFLLCLK) frequency is 20.97 MHz at low-range.

If C4[DRST_DRS] bits are set to 2'b01, the multiplication factor is doubled to 1280, and the resulting DCO output frequency is 41.94 MHz at mid-low-range. If C4[DRST_DRS] bits are set to 2'b10, the multiplication factor is set to 1920, and the resulting DCO output frequency is 62.91 MHz at mid high-range. If C4[DRST_DRS] bits are set to 2'b11, the multiplication factor is set to 2560, and the resulting DCO output frequency is 83.89 MHz at high-range.

In FBI and FEI modes, setting C4[DMX32] bit is not recommended. If the internal reference is trimmed to a frequency above 32.768 kHz, the greater FLL multiplication factor could potentially push the microcontroller system clock out of specification, potentially resulting in unpredictable behavior.

25.5.3 MCG mode switching

When switching between operational modes of the MCG, certain configuration bits must be changed in order to properly move from one mode to another.

Each time any of these bits are changed (C1[IREFS], C1[CLKS], C2[IRCS], or C2[EREFS]), the corresponding bits in the MCG status register (IREFST, CLKST, IRCST, or OSCINIT) must be checked before moving on in the application software.

Additionally, care must be taken to ensure that the reference clock divider (C1[FRDIV]) is set properly for the mode being switched to. For instance, in FEE mode, if using a 4MHz crystal, C1[FRDIV] must be set to 3'b010 (divide-by-128) to divide the external frequency down to the required frequency between 31.25 and 39.0625 kHz.

In FBE, FEE, FBI, and FEI modes, at any time, the application can switch the FLL multiplication factor between 640, 1280, 1920, and 2560 with C4[DRST_DRS] bits. Writes to C4[DRST_DRS] bits will be ignored if C2[LP]=1.

The table below shows MCGOUTCLK frequency calculations using C1[FRDIV] settings for each clock mode.

Table 25-2. MCGOUTCLK Frequency Calculation Options

| Clock Mode | $f_{\text{MCGOUTCLK}}^1$ | Note |
|------------------------------------|---|---|
| FEI (FLL engaged internal) | $f_{\text{int}} \times F$ | Typical $f_{\text{MCGOUTCLK}} = 21$ MHz immediately after reset. |
| FEE (FLL engaged external) | $(f_{\text{ext}} / \text{FLL_R}) \times F$ | $f_{\text{ext}} / \text{FLL_R}$ must be in the range of 31.25 kHz to 39.0625 kHz |
| FBE (FLL bypassed external) | OSCCLK | OSCCLK / FLL_R must be in the range of 31.25 kHz to 39.0625 kHz |
| FBI (FLL bypassed internal) | MCGIRCLK | Selectable between slow and fast IRC |
| BLPI (Bypassed low power internal) | MCGIRCLK | Selectable between slow and fast IRC |
| BLPE (Bypassed low power external) | OSCCLK | |

1. FLL_R is the reference divider selected by the C1[FRDIV] bits, F is the FLL factor selected by C4[DRST_DRS] and C4[DMX32] bits .

This section will include several mode switching examples, using an MHz external crystal..

Chapter 26

32 kHz Oscillator (32kRTC)

The 32 kHz RTC module is a crystal oscillator. The module, in conjunction with an external crystal, generates a 32kHz clock for the MCU with very low power.

26.1 Introduction

The RTC oscillator module provides the clock source for the RTC. The RTC oscillator module, in conjunction with an external crystal, generates a reference clock for the RTC.

26.1.1 Features and Modes

The key features of the RTC oscillator are as follows:

- Supports 32 kHz crystals with very low power
- Consists of internal feed back resistor
- Consists of internal programmable capacitors as the C_{load} of the oscillator
- Automatic Gain Control (AGC) to optimize power consumption

The RTC oscillator operations are described in detail in [Functional Description](#) .

26.1.2 Block Diagram

The following is the block diagram of the RTC oscillator.

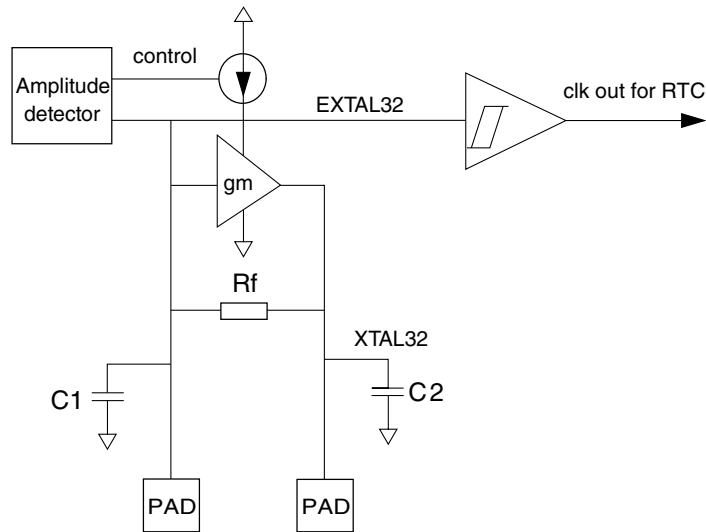

Figure 26-1. RTC Oscillator Block Diagram

26.2 RTC Signal Descriptions

The following table shows the user-accessible signals available for the RTC oscillator. See the Pinouts or Signal Multiplexing and Pin Assignment section to find out which signals are actually connected to the external pins.

Table 26-1. RTC Signal Descriptions

| Signal | Description | I/O |
|---------|-------------------|-----|
| EXTAL32 | Oscillator Input | I |
| XTAL32 | Oscillator Output | O |

26.2.1 EXTAL32 — Oscillator Input

This signal is the analog input of the RTC oscillator.

26.2.2 XTAL32 — Oscillator Output

This signal is the analog output of the RTC oscillator module.

26.3 External Crystal Connections

The connections with a crystal is shown in the following figure. External load capacitors and feedback resistor are not required.

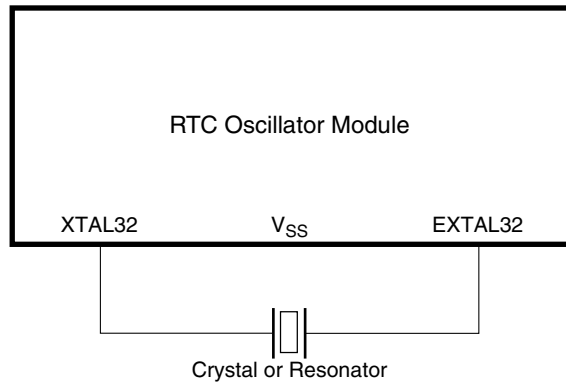

Figure 26-2. Crystal Connections

26.4 Memory Map/Register Descriptions

RTC oscillator control bits are part of the RTC registers. Refer to RTC Control Register (RTC_CR) in the RTC chapter, or RTC_GP_DATA_REG (if this General Purpose Data Register exists in the RTC registers) description in the chip-specific information section, for more details.

26.5 Functional Description

As shown in [Figure 26-1](#), the module includes an amplifier which supplies the negative resistor for the RTC oscillator. The gain of the amplifier is controlled by the amplitude detector, which optimizes the power consumption. A schmitt trigger is used to translate the sine-wave generated by this oscillator to a pulse clock out, which is a reference clock for the RTC digital core.

The oscillator includes an internal feedback resistor of approximately 100 M Ω between EXTAL32 and XTAL32.

In addition, there are two programmable capacitors with this oscillator, which can be used as the Cload of the oscillator. The programmable range is from 0pF to 30pF.

26.6 Reset Overview

There is no reset state associated with the RTC oscillator.

26.7 Interrupts

The RTC oscillator does not generate any interrupts.

Chapter 27

Flash Memory Controller (FMC)

27.1 Introduction

The Flash Memory Controller (FMC) is a memory acceleration unit that provides:

- an interface between the device and the nonvolatile memory.
- buffers that can accelerate flash memory transfers.

27.1.1 Overview

The Flash Memory Controller manages the interface between the device and the flash memory. The FMC receives status information detailing the configuration of the memory and uses this information to ensure a proper interface. The following table shows the supported read/write operations.

| Flash memory type | Read | Write |
|----------------------|---------------------------------|-------|
| Program flash memory | 8-bit, 16-bit, and 32-bit reads | — |

The FMC has a 32-bit interface to the device. The flash memory has a 2-bank structure, with independent lower and upper banks (both banks are 64-bits wide). The FMC has a single 64-bit interface to the flash memory, used to access each bank.

In addition, the FMC provides 2 separate mechanisms for accelerating the interface between the device and the flash memory. A 64-bit speculation buffer can prefetch the next 64-bit flash memory location, and a shared 4-way, 4-set cache can store previously accessed flash memory data for quick access times.

27.1.2 Features

Interface features between the device and the flash memory include:

- 8-bit, 16-bit, and 32-bit read operations to program flash memory.

- Read accesses to consecutive 32-bit spaces in memory *that do not hit speculation buffer or cache* return the 2nd read data with no wait states.
- 64-bit prefetch speculation buffer with controls for instruction/data access per master
- Invalidation control for the speculation buffer
- 128 bytes = 4-way by 4-set by 64 bits per entry cache, with controls for caching instructions and/or data
- Enable and invalidation controls for cache
- Read accesses that hit a valid speculation or cache entry return the read data with no wait states

27.2 Modes of operation

The FMC only operates when a bus master accesses the flash memory.

For any device power mode where the flash memory cannot be accessed, the FMC is disabled.

27.3 External signal description

The FMC has no external signals.

27.4 Memory map and register descriptions

In this device, the PFC = Platform Flash Controller does not have any program model; therefore, there are no register definitions in the PFC chapter. All PFC operating controls are in the Platform Control Register (MCMx_PLACR) in the MCM module.

27.5 Flash Access Control (FAC) Function

The Flash Access Control (FAC) is a configurable memory protection scheme optimized to allow end users to use software libraries while offering programmable restrictions to these libraries. The flash memory is divided into *equal size segments* that provide protection to proprietary software libraries. The protection of these segments is controlled: the FAC provides a cycle-by-cycle evaluation of the access rights for each

transaction routed to the on-chip flash memory. Two levels of vendors can add their proprietary software to a device; FAC protection of segments for each level are defined once, using the PGMONCE command.

Flash access control aligns to the 3 privilege levels supported by ARM Cortex-M family products:

- Most secure state is supervisor/privileged secure: allows execute-only and provides supervisor-only access control.
- Mid-level state is execute-only.
- Unsecure state is where no access control states are set.

Features:

- Lightweight access control logic for on-chip flash memory
- Flash address space divided into (32 or 64) equal-sized segments (segment size is defined as $\text{flash_size [bytes]}/(32 \text{ or } 64)$)
- Separate control bits for supervisor-only access and execute-only access per segment
- Access control evaluated on each bus cycle routed to the flash
- Access violation errors terminate the bus cycle and return zeroes for read data
- Programming model allows 2 levels of protected segments

27.5.1 Memory map and register definitions

The FAC registers are documented in the FTFA chapter.

27.5.2 FAC functional description

The access control functionality is implemented in 2 separate blocks within the SoC. The Flash Management Unit (FMU) includes non-volatile configuration information that is retrieved during reset and sent to the platform to control access to the flash array during normal operation.

There are (4) 64-bit NVM storage locations to support access control features. These NVM locations are summarized in the table below.

Table 27-1. NVM Locations

| NVM location | Description | |
|------------------|---|--|
| NVSACC1, NVSACC2 | Two locations are ANDed together and loaded during reset into the x_SACC register to provide access configuration. | Segment-wise control for supervisor-only access vs. supervisor and user access |

Table continues on the next page...

Table 27-1. NVM Locations (continued)

| NVM location | Description | |
|------------------|--|--|
| NVXACC1, NVXACC2 | Two locations are ANDed together and loaded during reset into the x_XACC register to provide access configuration. | Segment-wise control for execute-only vs. data and execute |

Each of these NVM locations is programmable through a Program Once flash command and can be programmed one time. These NVM locations are unaffected by Erase All Blocks flash command and debug interface initiated mass erase operations. Since the 2 NVXACCx fields are ANDed, the access protection can only be increased. A segment's access controls can be changed from data read and execute ($XAn = 1$) to execute-only ($XAn = 0$), or from supervisor and user mode ($SAn = 1$) to supervisor-only mode ($SAn = 0$).

The flash is released from reset early while the core continues to be held in reset. The FMU captures the NVM access control information in internal registers. The FMU ANDs the multiple execute-only fields to create a single execute-only field. This execute-only field driven to the platform is static prior to the core being released from reset. The supervisor-only field is handled in the same manner.

The FMU includes the FAC registers that provide control access to the flash address space. During the address phase of every attempted flash transfer, the supervisor access (SAn) and execute access (XAn) bits are examined to either allow or deny access. If access is denied, then the access is aborted and terminates with a bus error; the read data is also zeroed.

The next table shows segment assignments relative to the flash location.

Table 27-2. Flash Protection Ranges

| SAn and XAn Bit | Protected Segment Address Range | Segment Size (Fraction of total Flash) |
|-----------------------------|---|--|
| 64 Segment Encodings | | |
| 0 | $0x0_0000_0000 - (\text{Flash_size}/64-1)$ | 1/64 |
| 1 | $(\text{Flash_size}/64) - 2^*(\text{Flash_size}/64-1)$ | 1/64 |
| | | |
| 63 | $63^*(\text{Flash_size}/64) - 62^*(\text{Flash_size}/64-1)$ | 1/64 |
| 32 Segment Encodings | | |
| 0 | $0x0_0000_0000 - (\text{Flash_size}/32-1)$ | 1/32 |
| 1 | $(\text{Flash_size}/32) - 2^*(\text{Flash_size}/32-1)$ | 1/32 |
| | | |
| 31 | $31^*(\text{Flash_size}/32) - 30^*(\text{Flash_size}/32-1)$ | 1/32 |

Individual segments within the flash memory can be independently protected from user access and data access. Protection is controlled by the individual bits within the *x_SACC* and *x_XACC* registers, as shown in the next figure.

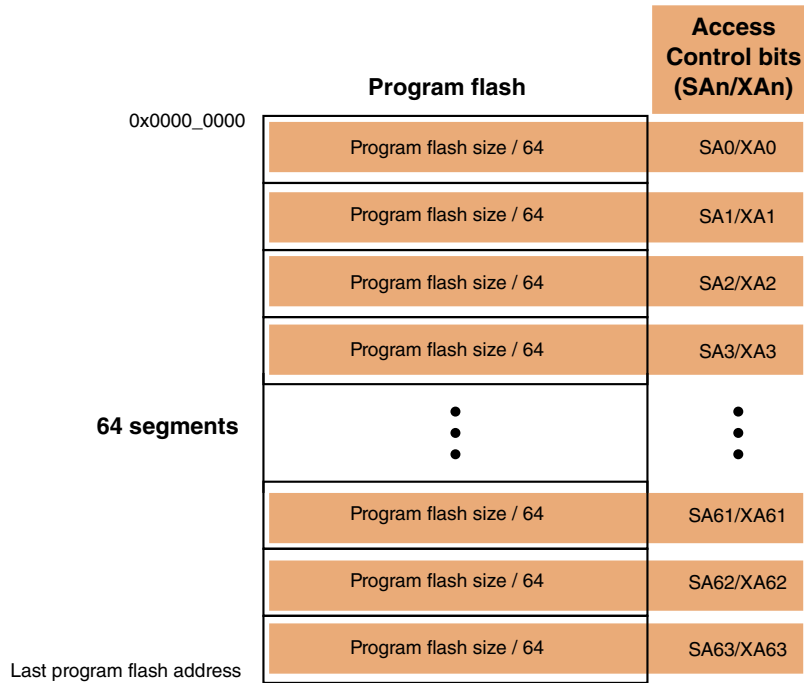

Figure 27-1. Program flash protection (64 segments)

27.5.2.1 Interface Signals

Table 27-3. Interface Signals

| Signal | Width | From | To | Description |
|------------|----------|------|----------|---|
| xacc | 64 or 32 | FMU | Platform | Direct xacc (execute-only access control) register |
| sacc | 64 or 32 | FMU | Platform | Direct sacc (supervisor access control) register |
| numsg | 8 | FMU | Platform | NUMSG bit field - Binary encoded number of segments 0x40 for 64 segments 0x20 for 32 segments |
| fac_enable | 1 | SIM | FMU | SIM Option bit - derived from an IFR bit and captured in SIM_SOPTx. A way to disable the flash access control for phantom devices without this feature. fac_enable==1 - Access Control feature is enabled fac_enable==0 - Access Control feature is disabled <ul style="list-style-type: none"> During the reset sequence, XACC registers are written to all "1"s. During the reset sequence, SACC registers are written to all "1"s. Implied protection based on XACC registers is turned off. |

27.5.2.2 Flash Command Impact

| | |
|--|---|
| Program Longword/Phrase/Section | If the targeted flash location is in an execute-only protected segment, then these program commands are not allowed unless a Read 1s All Blocks command is executed and returns with a pass code (which means the part has been fully erased). After the Read 1s All Blocks command is executed with a pass code returned, then the protected segment is open to program commands. To close off programmability to execute-only spaces once again, the device must be reset or a Read 1s All Blocks command is executed with a fail result. Attempts to program in a protected segment <i>when not open to program commands</i> causes a Protection Violation flag. |
| PGMCHK | The FMU will not execute the PGMCHK on a segment that has been configured as execute-only. The Flash Protection Violation flag is set if an attempt is made to execute PGMCHK command on an execute-only address. |
| Erase Flash Sector | If the targeted flash sector is in an execute-only protected segment, then the Erase Flash Sector command is not allowed, and sets the Protection Violation flag. The only means of erasing protected space is by an Erase All operation. |
| ERSALL | The Erase All Blocks command is not affected by Access Control. An Erase All Blocks command will erase any libraries that have been programmed in any execute-only segment. The programmed execute-only assignment is not erased as part of the Erase All Blocks command, and access control regions remain as previously programmed. NOTE: The ERSALL command may be used for field upgrades. Access control states remain programmed. Software must plan accordingly, possibly making extra space available for future use. |

27.5.2.3 Core Platform Impact

| | |
|---|--|
| Platform core caches (Flash and LMEM caches) | If any segment is marked as <i>execute-only</i> , then the caches are hidden from the user. The tag is read-only and cannot be written, and the data caches cannot be read or written. Writes to the tag and data arrays are ignored, and reads of the data array return 0's. This will impact debug breakpoints. See the debug section for details. |
| Debug | The debugger is a non-processor bus master and cannot step, trace or break in execute-only regions. In supervisor-only mode, the debugger is restricted from changing modes. Debug accesses to any segment of flash space marked as execute-only also terminate with a bus error. |
| PC-relative addressing | Hardware cannot track speculative instruction fetches (ifetches) across boundaries, and hardware cannot determine if PC-relative data references are crossing segment boundaries; therefore restrictions for PC-relative addressing are placed on software. <ul style="list-style-type: none"> • If ifetch is executing in a protected segment, then data references will be allowed; if ifetch is executing in a nonprotected segment, then data references to a protected segment are not allowed. • PC-relative re-entry to execute-only segments is allowed. |
| Interrupts | If function calls are used to move into an execute-only segment, then this can be tracked by hardware when typical software controls are used (i.e., saving registers and states before executing new code). |
| Reset Vector | In the ARM core, the reset vector fetch is supervisor data, which poses issues if the reset vector is located in a segment marked execute-only. Additional logic has been implemented to allow supervisor data fetches to execute-only spaces, after reset until the first valid instruction fetch. After the first valid instruction fetch, the FAC logic follows normal checks. |

27.5.2.4 Software considerations

There are software considerations that need to be communicated to tool and library vendors. The hardware cannot see all states of the ARM core and cannot track the software flow, therefore software restrictions are required, to work with the hardware for a robust solution.

- **Any segment marked as execute-only can see all code in the system.** This means one execute-only segment can read the execute-only code in another segment. Therefore, if a company is sending pre-loaded code to another vendor, then that vendor will have access to that pre-loaded code. To deal with this issue, NDAs and legal agreements can be used.
- **If using single software pre-loads** (for example, if a company is pre-loading for a general purpose market or if a vendor with a blank part is pre-loading proprietary code), then both levels of access control must be programmed, to protect the pre-loaded code.
- **If any portion of a protected segment is not used by pre-loaded code**, then the portion of a protected segment that is not used by pre-loaded code should be programmed with NOPs, to prevent additional code from being programmed in that segment by hackers.

27.5.2.5 Access Check Evaluation

The flash controller FAC provides a cycle-by-cycle evaluation of the access rights for each data transaction routed to the on-chip flash memory.

The entire flash storage capacity is partitioned into equal sized segments. Two registers include a supervisor-only access control indicator and a execute-only access control indicator for each segment.

The FAC logic performs the required access control evaluation using the reference address and a 2-bit attribute (or "protection" field) as inputs from the bus cycle plus the contents of the programming model registers.

The following code example illustrates C code for FAC evaluation:

```
unsigned long long sacc; // supervisor-only map
unsigned long long xacc; // execute-only map
unsigned int seg_size; // 8-bit segment size
unsigned int fac_error;

fac_evaluation (addr, prot)
    unsigned int addr; // access address
    unsigned int hprot; // encoded 2-bit "protection" field {supv, data}
{
```

Initialization and application information

```
unsigned int sacc_flag; // sacc flag for this segment
unsigned int xacc_flag; // xacc flag for this segment
unsigned int i;        // segment index

i          = (addr >> (8 + seg_size & 0x0f)) & 0x3f; // form 6-bit segment index
sacc_flag = (sacc >> i) & 1;           // extract sacc bit for this segment
xacc_flag = (xacc >> i) & 1;           // extract xacc bit for this segment

// create a 4-tuple concatenating the 2-bit protection field + {sacc, xacc} flags

switch ((hprot & 3) << 2 | (sacc_flag << 1) | xacc_flag) {
// all these combinations are allowed accesses
case 0x2: // {user, ifetch} && {supv+user, ifetch-only}
case 0x3: // {user, ifetch} && {supv+user, ifetch+data}
case 0x7: // {user, data} && {supv+user, ifetch+data}
case 0x8: // {supv, ifetch} && {supv-only, ifetch-only}
case 0x9: // {supv, ifetch} && {supv-only, ifetch+data}
case 0xa: // {supv, ifetch} && {supv+user, ifetch-only}
case 0xb: // {supv, ifetch} && {supv+user, ifetch+data}
case 0xd: // {supv, data} && {supv-only, ifetch+data}
case 0xf: // {supv, data} && {supv+user, ifetch+data}
    fac_error = 00;
    break;

// all these combinations are unallowed, that is, errored accesses
case 0x0: // {user, ifetch} && {supv-only, ifetch-only}
case 0x1: // {user, ifetch} && {supv-only, ifetch+data}
case 0x4: // {user, data} && {supv-only, ifetch-only}
case 0x5: // {user, data} && {supv-only, ifetch+data}
case 0x6: // {user, data} && {supv+user, ifetch-only}
case 0xc: // {supv, data} && {supv-only, ifetch-only}
case 0xe: // {supv, data} && {supv+user, ifetch-only}
    fac_error = 1;
    break;

} // switch()
} // fac_evaluation()
```

27.5.2.6 FAC application tips

In one use case, the NVSACC1 and NVXACC1 locations are programmed by NXP and they protect NXP libraries that have been programmed into associated flash segments in a device. Later, the NVSACC2 and NVXACC2 NVM locations can optionally be programmed by a third-party vendor who wants to program their proprietary software and to extend the protection of protected flash segments to include their software libraries before supplying it all to their customers.

Their customer would then develop their own code to use the available libraries, and program their code into the remaining available on-chip flash. The device continues to support the end user with standard security features that further limit external access to flash resources.

27.6 Initialization and application information

The FMC does not require user initialization. Flash acceleration features are enabled by default.

The FMC has no visibility into flash memory erase and program cycles, because the Flash Memory module manages them directly. As a result, if an application is executing flash memory commands, then the FMC's cache might need to be disabled and/or flushed, to prevent the possibility of returning stale data. To invalidate the cache in this manner, use the Flash Cache Invalidate control register in the MCM.

Chapter 28

Flash Memory Module (FTFA)

28.1 Introduction

The flash memory module includes the following accessible memory regions:

- Program flash memory for vector space and code store

Flash memory is ideal for single-supply applications, permitting in-the-field erase and reprogramming operations without the need for any external high voltage power sources.

The flash memory module includes a memory controller that executes commands to modify flash memory contents. An erased bit reads '1' and a programmed bit reads '0'. The programming operation is unidirectional; it can only move bits from the '1' state (erased) to the '0' state (programmed). Only the erase operation restores bits from '0' to '1'; bits cannot be programmed from a '0' to a '1'.

CAUTION

A flash memory location must be in the erased state before being programmed. Cumulative programming of bits (back-to-back program operations without an intervening erase) within a flash memory location is not allowed. Re-programming of existing 0s to 0 is not allowed as this overstresses the device.

The standard shipping condition for flash memory is erased with security disabled. Data loss over time may occur due to degradation of the erased ('1') states and/or programmed ('0') states. Therefore, it is recommended that each flash block or sector be re-erased immediately prior to factory programming to ensure that the full data retention capability is achieved.

28.1.1 Features

The flash memory module includes the following features.

NOTE

See the device's Chip Configuration details for the exact amount of flash memory available on your device.

28.1.1.1 Program Flash Memory Features

- Sector size of 2 KB
- Program flash protection scheme prevents accidental program or erase of stored data
- Program flash access control scheme prevents unauthorized access to selected code segments
- Automated, built-in, program and erase algorithms with verify
- Read access to one program flash block is possible while programming or erasing data in the other program flash block

28.1.1.2 Other Flash Memory Module Features

- Internal high-voltage supply generator for flash memory program and erase operations
- Optional interrupt generation upon flash command completion
- Supports MCU security mechanisms which prevent unauthorized access to the flash memory contents

28.1.2 Block Diagram

The block diagram of the flash memory module is shown in the following figure.

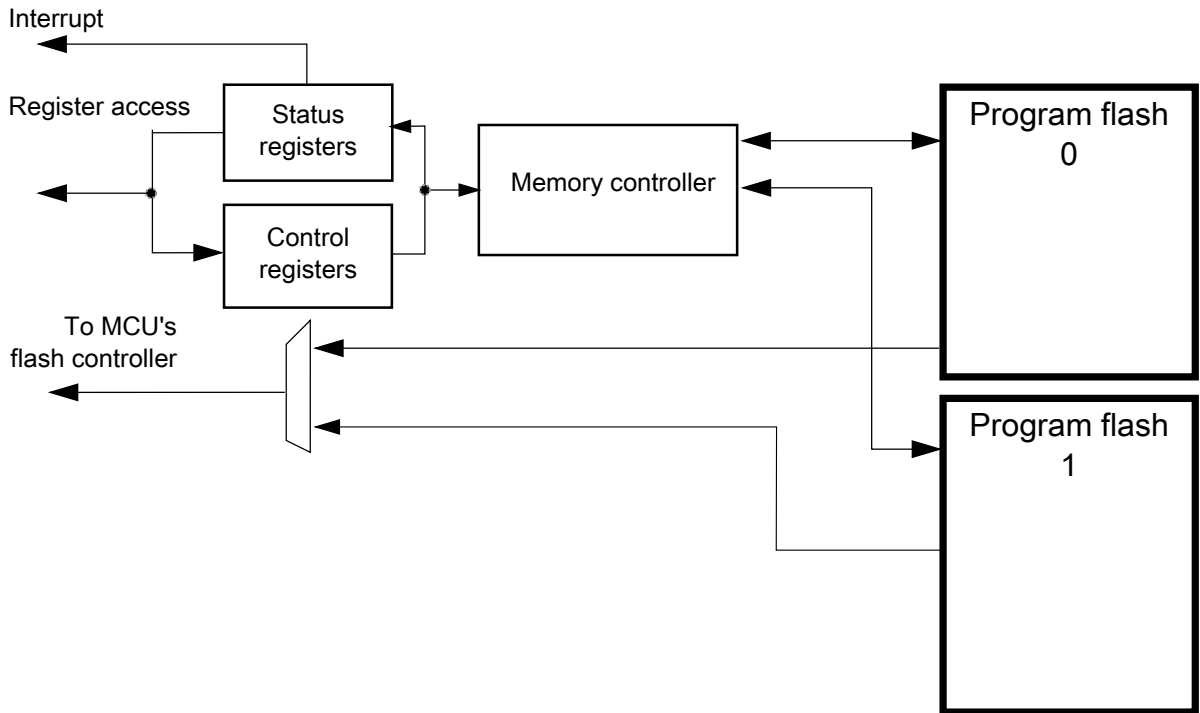

Figure 28-1. Flash Block Diagram

28.1.3 Glossary

Command write sequence — A series of MCU writes to the flash FCCOB register group that initiates and controls the execution of flash algorithms that are built into the flash memory module.

Endurance — The number of times that a flash memory location can be erased and reprogrammed.

FCCOB (Flash Common Command Object) — A group of flash registers that are used to pass command, address, data, and any associated parameters to the memory controller in the flash memory module.

Flash block — A macro within the flash memory module which provides the nonvolatile memory storage.

Flash Memory Module — All flash blocks plus a flash management unit providing high-level control and an interface to MCU buses.

IFR — Nonvolatile information register found in each flash block, separate from the main memory array.

Longword — 32 bits of data with an aligned longword having byte-address[1:0] = 00.

NVM — Nonvolatile memory. A memory technology that maintains stored data during power-off. The flash array is an NVM using NOR-type flash memory technology.

NVM Normal Mode — An NVM mode that provides basic user access to flash memory module resources. The CPU or other bus masters initiate flash program and erase operations (or other flash commands) using writes to the FCCOB register group in the flash memory module.

NVM Special Mode — An NVM mode enabling external, off-chip access to the memory resources in the flash memory module. A reduced flash command set is available when the MCU is secured. See the Chip Configuration details for information on when this mode is used.

Phrase — 64 bits of data with an aligned phrase having $\text{byte-address}[2:0] = 000$.

Program flash — The program flash memory provides nonvolatile storage for vectors and code store.

Program flash Sector — The smallest portion of the program flash memory (consecutive addresses) that can be erased.

Retention — The length of time that data can be kept in the NVM without experiencing errors upon readout. Since erased (1) states are subject to degradation just like programmed (0) states, the data retention limit may be reached from the last erase operation (not from the programming time).

RWW— Read-While-Write. The ability to simultaneously read from one memory resource while commanded operations are active in another memory resource.

Secure — An MCU state conveyed to the flash memory module as described in the Chip Configuration details for this device. In the secure state, reading and changing NVM contents is restricted.

Word — 16 bits of data with an aligned word having $\text{byte-address}[0] = 0$.

28.2 External Signal Description

The flash memory module contains no signals that connect off-chip.

28.3 Memory Map and Registers

This section describes the memory map and registers for the flash memory module.

Data read from unimplemented memory space in the flash memory module is undefined. Writes to unimplemented or reserved memory space (registers) in the flash memory module are ignored.

28.3.1 Flash Configuration Field Description

The program flash memory contains a 16-byte flash configuration field that stores default protection settings (loaded on reset) and security information that allows the MCU to restrict access to the flash memory module.

| Flash Configuration Field Offset Address | Size (Bytes) | Field Description |
|--|--------------|--|
| 0x0_0400–0x0_0407 | 8 | Backdoor Comparison Key. Refer to Verify Backdoor Access Key Command and Unsecuring the Chip Using Backdoor Key Access . |
| 0x0_0408–0x0_040B | 4 | Program flash protection bytes. Refer to the description of the Program Flash Protection Registers (FPROT0-3). |
| 0x0_040F | 1 | Reserved |
| 0x0_040E | 1 | Reserved |
| 0x0_040D | 1 | Flash nonvolatile option byte. Refer to the description of the Flash Option Register (FOPT). |
| 0x0_040C | 1 | Flash security byte. Refer to the description of the Flash Security Register (FSEC). |

28.3.2 Program Flash IFR Map

The program flash IFR is nonvolatile information memory that can be read freely, but the user has no erase and limited program capabilities (see the Read Once, Program Once, and Read Resource commands in [Read Once Command](#), [Program Once Command](#) and [Read Resource Command](#)).

The contents of the program flash IFR are summarized in the table found here and further described in the subsequent paragraphs.

The program flash IFR is located within the program flash 0 memory block .

| Address Range | Size (Bytes) | Field Description |
|---------------|--------------|----------------------------|
| 0x00 – 0x9F | 160 | Reserved |
| 0xA0 – 0xA3 | 4 | Program Once XACCH-1 Field |

Table continues on the next page...

Memory Map and Registers

| Address Range | Size (Bytes) | Field Description |
|---------------|--------------|--|
| | | (index = 0x10) |
| 0xA4 – 0xA7 | 4 | Program Once XACCL-1 Field (index = 0x10) |
| 0xA8 – 0xAB | 4 | Program Once XACCH-2 Field (index = 0x11) |
| 0xAC – 0xAF | 4 | Program Once XACCL-2 Field (index = 0x11) |
| 0xB0 – 0xB3 | 4 | Program Once SACCH-1 Field (index = 0x12) |
| 0xB4 – 0xB7 | 4 | Program Once SACCL-1 Field (index = 0x12) |
| 0xB8 – 0xBB | 4 | Program Once SACCH-2 Field (index = 0x13) |
| 0xBC – 0xBF | 4 | Program Once SACCL-2 Field (index = 0x13) |
| 0xC0 – 0xFF | 64 | Program Once ID Field (index = 0x00 - 0x0F) |

28.3.2.1 Program Once Field

The Program Once Field in the program flash IFR provides 96 bytes of user data storage separate from the program flash main array. The user can program the Program Once Field one time only as there is no program flash IFR erase mechanism available to the user. The Program Once Field can be read any number of times. This section of the program flash IFR is accessed in 4-byte or 8-Byte records using the Read Once and Program Once commands (see [Read Once Command](#) and [Program Once Command](#)).

28.3.3 Register Descriptions

The flash memory module contains a set of memory-mapped control and status registers.

NOTE

While a command is running (FSTAT[CCIF]=0), register writes are not accepted to any register except FCNFG and FSTAT. The no-write rule is relaxed during the start-up reset sequence, prior to the initial rise of CCIF. During this initialization period the user may write any register. All register writes are also disabled (except for registers FCNFG and

FSTAT) whenever an erase suspend request is active (FCNFG[ERSSUSP]=1).

FTFA memory map

| Absolute address (hex) | Register name | Width (in bits) | Access | Reset value | Section/page |
|------------------------|---|-----------------|--------|-------------|------------------------------|
| 4002_0000 | Flash Status Register (FTFA_FSTAT) | 8 | R/W | 00h | 28.3.3.1/572 |
| 4002_0001 | Flash Configuration Register (FTFA_FCENFG) | 8 | R/W | 00h | 28.3.3.2/574 |
| 4002_0002 | Flash Security Register (FTFA_FSEC) | 8 | R | Undefined | 28.3.3.3/575 |
| 4002_0003 | Flash Option Register (FTFA_FOPT) | 8 | R | Undefined | 28.3.3.4/576 |
| 4002_0004 | Flash Common Command Object Registers (FTFA_FCCOB3) | 8 | R/W | 00h | 28.3.3.5/577 |
| 4002_0005 | Flash Common Command Object Registers (FTFA_FCCOB2) | 8 | R/W | 00h | 28.3.3.5/577 |
| 4002_0006 | Flash Common Command Object Registers (FTFA_FCCOB1) | 8 | R/W | 00h | 28.3.3.5/577 |
| 4002_0007 | Flash Common Command Object Registers (FTFA_FCCOB0) | 8 | R/W | 00h | 28.3.3.5/577 |
| 4002_0008 | Flash Common Command Object Registers (FTFA_FCCOB7) | 8 | R/W | 00h | 28.3.3.5/577 |
| 4002_0009 | Flash Common Command Object Registers (FTFA_FCCOB6) | 8 | R/W | 00h | 28.3.3.5/577 |
| 4002_000A | Flash Common Command Object Registers (FTFA_FCCOB5) | 8 | R/W | 00h | 28.3.3.5/577 |
| 4002_000B | Flash Common Command Object Registers (FTFA_FCCOB4) | 8 | R/W | 00h | 28.3.3.5/577 |
| 4002_000C | Flash Common Command Object Registers (FTFA_FCCOBB) | 8 | R/W | 00h | 28.3.3.5/577 |
| 4002_000D | Flash Common Command Object Registers (FTFA_FCCOBA) | 8 | R/W | 00h | 28.3.3.5/577 |
| 4002_000E | Flash Common Command Object Registers (FTFA_FCCOB9) | 8 | R/W | 00h | 28.3.3.5/577 |
| 4002_000F | Flash Common Command Object Registers (FTFA_FCCOB8) | 8 | R/W | 00h | 28.3.3.5/577 |
| 4002_0010 | Program Flash Protection Registers (FTFA_FPROT3) | 8 | R/W | Undefined | 28.3.3.6/578 |
| 4002_0011 | Program Flash Protection Registers (FTFA_FPROT2) | 8 | R/W | Undefined | 28.3.3.6/578 |
| 4002_0012 | Program Flash Protection Registers (FTFA_FPROT1) | 8 | R/W | Undefined | 28.3.3.6/578 |
| 4002_0013 | Program Flash Protection Registers (FTFA_FPROT0) | 8 | R/W | Undefined | 28.3.3.6/578 |

Table continues on the next page...

FTFA memory map (continued)

| Absolute address (hex) | Register name | Width (in bits) | Access | Reset value | Section/page |
|------------------------|---|-----------------|--------|-------------|-------------------------------|
| 4002_0018 | Execute-only Access Registers (FTFA_XACCH3) | 8 | R | Undefined | 28.3.3.7/580 |
| 4002_0019 | Execute-only Access Registers (FTFA_XACCH2) | 8 | R | Undefined | 28.3.3.7/580 |
| 4002_001A | Execute-only Access Registers (FTFA_XACCH1) | 8 | R | Undefined | 28.3.3.7/580 |
| 4002_001B | Execute-only Access Registers (FTFA_XACCH0) | 8 | R | Undefined | 28.3.3.7/580 |
| 4002_001C | Execute-only Access Registers (FTFA_XACCL3) | 8 | R | Undefined | 28.3.3.7/580 |
| 4002_001D | Execute-only Access Registers (FTFA_XACCL2) | 8 | R | Undefined | 28.3.3.7/580 |
| 4002_001E | Execute-only Access Registers (FTFA_XACCL1) | 8 | R | Undefined | 28.3.3.7/580 |
| 4002_001F | Execute-only Access Registers (FTFA_XACCL0) | 8 | R | Undefined | 28.3.3.7/580 |
| 4002_0020 | Supervisor-only Access Registers (FTFA_SACCH3) | 8 | R | Undefined | 28.3.3.8/581 |
| 4002_0021 | Supervisor-only Access Registers (FTFA_SACCH2) | 8 | R | Undefined | 28.3.3.8/581 |
| 4002_0022 | Supervisor-only Access Registers (FTFA_SACCH1) | 8 | R | Undefined | 28.3.3.8/581 |
| 4002_0023 | Supervisor-only Access Registers (FTFA_SACCH0) | 8 | R | Undefined | 28.3.3.8/581 |
| 4002_0024 | Supervisor-only Access Registers (FTFA_SACCL3) | 8 | R | Undefined | 28.3.3.8/581 |
| 4002_0025 | Supervisor-only Access Registers (FTFA_SACCL2) | 8 | R | Undefined | 28.3.3.8/581 |
| 4002_0026 | Supervisor-only Access Registers (FTFA_SACCL1) | 8 | R | Undefined | 28.3.3.8/581 |
| 4002_0027 | Supervisor-only Access Registers (FTFA_SACCL0) | 8 | R | Undefined | 28.3.3.8/581 |
| 4002_0028 | Flash Access Segment Size Register (FTFA_FACSS) | 8 | R | Undefined | 28.3.3.9/582 |
| 4002_002B | Flash Access Segment Number Register (FTFA_FACSN) | 8 | R | Undefined | 28.3.3.10/583 |

28.3.3.1 Flash Status Register (FTFA_FSTAT)

The FSTAT register reports the operational status of the flash memory module.

The CCIF, RDCOLERR, ACCERR, and FPVIOL bits are readable and writable. The MGSTAT0 bit is read only. The unassigned bits read 0 and are not writable.

NOTE

When set, the Access Error (ACCERR) and Flash Protection Violation (FPVIOL) bits in this register prevent the launch of any more commands until the flag is cleared (by writing a one to it).

Address: 4002_0000h base + 0h offset = 4002_0000h

| Bit | 7 | 6 | 5 | 4 | 3 | 2 | 1 | 0 |
|-------|------|----------|--------|--------|---|---|---|---------|
| Read | CCIF | RDCOLERR | ACCERR | FPVIOL | 0 | | | MGSTAT0 |
| Write | w1c | w1c | w1c | w1c | | | | |
| Reset | 0 | 0 | 0 | 0 | 0 | 0 | 0 | 0 |

FTFA_FSTAT field descriptions

| Field | Description |
|---------------|---|
| 7 CCIF | <p>Command Complete Interrupt Flag</p> <p>Indicates that a flash command has completed. The CCIF flag is cleared by writing a 1 to CCIF to launch a command, and CCIF stays low until command completion or command violation.</p> <p>CCIF is reset to 0 but is set to 1 by the memory controller at the end of the reset initialization sequence. Depending on how quickly the read occurs after reset release, the user may or may not see the 0 hardware reset value.</p> <p>0 Flash command in progress 1 Flash command has completed</p> |
| 6 RDCOLERR | <p>Flash Read Collision Error Flag</p> <p>Indicates that the MCU attempted a read from a flash memory resource that was being manipulated by a flash command (CCIF=0). Any simultaneous access is detected as a collision error by the block arbitration logic. The read data in this case cannot be guaranteed. The RDCOLERR bit is cleared by writing a 1 to it. Writing a 0 to RDCOLERR has no effect.</p> <p>0 No collision error detected 1 Collision error detected</p> |
| 5 ACCERR | <p>Flash Access Error Flag</p> <p>Indicates an illegal access has occurred to a flash memory resource caused by a violation of the command write sequence or issuing an illegal flash command. While ACCERR is set, the CCIF flag cannot be cleared to launch a command. The ACCERR bit is cleared by writing a 1 to ACCERR while CCIF is set. Writing a 0 to the ACCERR bit has no effect.</p> <p>0 No access error detected 1 Access error detected</p> |
| 4 FPVIOL | <p>Flash Protection Violation Flag</p> <p>Indicates an attempt was made to program or erase an address in a protected area of program flash memory during a command write sequence. While FPVIOL is set, the CCIF flag cannot be cleared to launch a command. The FPVIOL bit is cleared by writing a 1 to FPVIOL while CCIF is set. Writing a 0 to the FPVIOL bit has no effect.</p> <p>0 No protection violation detected 1 Protection violation detected</p> |

Table continues on the next page...

FTFA_FSTAT field descriptions (continued)

| Field | Description |
|-----------------|---|
| 3-1 Reserved | This field is reserved. This read-only field is reserved and always has the value 0. |
| 0 MGSTAT0 | Memory Controller Command Completion Status Flag The MGSTAT0 status flag is set if an error is detected during execution of a flash command or during the flash reset sequence. As a status flag, this field cannot (and need not) be cleared by the user like the other error flags in this register. The value of the MGSTAT0 bit for "command-N" is valid only at the end of the "command-N" execution when CCIF=1 and before the next command has been launched. At some point during the execution of "command-N+1," the previous result is discarded and any previous error is cleared. |

28.3.3.2 Flash Configuration Register (FTFA_FCNFG)

This register provides information on the current functional state of the flash memory module.

The erase control bits (ERSAREQ and ERSSUSP) have write restrictions. The unassigned bits read as noted and are not writable.

Address: 4002_0000h base + 1h offset = 4002_0001h

| Bit | 7 | 6 | 5 | 4 | 3 | 2 | 1 | 0 |
|-------|------|----------|---------|---------|---|---|---|---|
| Read | CCIE | RDCOLLIE | ERSAREQ | ERSSUSP | 0 | 0 | 0 | 0 |
| Write | | | | | | | | |
| Reset | 0 | 0 | 0 | 0 | 0 | 0 | 0 | 0 |

FTFA_FCNFG field descriptions

| Field | Description |
|---------------|--|
| 7 CCIE | Command Complete Interrupt Enable Controls interrupt generation when a flash command completes. 0 Command complete interrupt disabled 1 Command complete interrupt enabled. An interrupt request is generated whenever the FSTAT[CCIF] flag is set. |
| 6 RDCOLLIE | Read Collision Error Interrupt Enable Controls interrupt generation when a flash memory read collision error occurs. 0 Read collision error interrupt disabled 1 Read collision error interrupt enabled. An interrupt request is generated whenever a flash memory read collision error is detected (see the description of FSTAT[RDCOLERR]). |
| 5 ERSAREQ | Erase All Request |

Table continues on the next page...

FTFA_FCENFG field descriptions (continued)

| Field | Description |
|---------------|---|
| | <p>Issues a request to the memory controller to execute the Erase All Blocks command and release security. ERSAREQ is not directly writable but is under indirect user control. Refer to the device's Chip Configuration details on how to request this command.</p> <p>ERSAREQ sets when an erase all request is triggered external to the flash memory module and CCIF is set (no command is currently being executed). ERSAREQ is cleared by the flash memory module when the operation completes.</p> <p>0 No request or request complete 1 Request to: <ol style="list-style-type: none"> run the Erase All Blocks command, verify the erased state, program the security byte in the Flash Configuration Field to the unsecure state, and release MCU security by setting the FSEC[SEC] field to the unsecure state. </p> |
| 4 ERSSUSP | <p>Erase Suspend</p> <p>Allows the user to suspend (interrupt) the Erase Flash Sector command while it is executing.</p> <p>0 No suspend requested 1 Suspend the current Erase Flash Sector command execution.</p> |
| 3 Reserved | <p>This field is reserved. This read-only field is reserved and always has the value 0.</p> |
| 2 Reserved | <p>This field is reserved. This read-only field is reserved and always has the value 0.</p> |
| 1 Reserved | <p>This field is reserved. This read-only field is reserved and always has the value 0.</p> |
| 0 Reserved | <p>This field is reserved. This read-only field is reserved and always has the value 0.</p> |

28.3.3.3 Flash Security Register (FTFA_FSEC)

This read-only register holds all bits associated with the security of the MCU and flash memory module.

During the reset sequence, the register is loaded with the contents of the flash security byte in the Flash Configuration Field located in program flash memory. The flash basis for the values is signified by X in the reset value.

Address: 4002_0000h base + 2h offset = 4002_0002h

| Bit | 7 | 6 | 5 | 4 | 3 | 2 | 1 | 0 |
|-------|-------|----|------|----|--------|----|-----|----|
| Read | KEYEN | | MEEN | | FSLACC | | SEC | |
| Write | | | | | | | | |
| Reset | x* | x* | x* | x* | x* | x* | x* | x* |

* Notes:

- x = Undefined at reset.

FTFA_FSEC field descriptions

| Field | Description |
|---------------|---|
| 7–6 KEYEN | <p>Backdoor Key Security Enable</p> <p>Enables or disables backdoor key access to the flash memory module.</p> <p>00 Backdoor key access disabled 01 Backdoor key access disabled (preferred KEYEN state to disable backdoor key access) 10 Backdoor key access enabled 11 Backdoor key access disabled</p> |
| 5–4 MEEN | <p>Mass Erase Enable</p> <p>Enables and disables mass erase capability of the flash memory module at all times in all NVM modes.</p> <p>00 Mass erase is enabled 01 Mass erase is enabled 10 Mass erase is disabled 11 Mass erase is enabled</p> |
| 3–2 FSLACC | <p>Factory Security Level Access Code</p> <p>Enables or disables access to the flash memory contents during returned part failure analysis at NXP. When SEC is secure and FSLACC is denied, access to the program flash contents is denied and any failure analysis performed by NXP factory test must begin with a full erase to unsecure the part.</p> <p>When access is granted (SEC is unsecure, or SEC is secure and FSLACC is granted), NXP factory testing has visibility of the current flash contents. The state of the FSLACC bits is only relevant when SEC is set to secure. When SEC is set to unsecure, the FSLACC setting does not matter.</p> <p>00 NXP factory access granted 01 NXP factory access denied 10 NXP factory access denied 11 NXP factory access granted</p> |
| SEC | <p>Flash Security</p> <p>Defines the security state of the MCU. In the secure state, the MCU limits access to flash memory module resources. The limitations are defined per device and are detailed in the Chip Configuration details. If the flash memory module is unsecured using backdoor key access, SEC is forced to 10b.</p> <p>00 MCU security status is secure. 01 MCU security status is secure. 10 MCU security status is unsecure. (The standard shipping condition of the flash memory module is unsecure.) 11 MCU security status is secure.</p> |

28.3.3.4 Flash Option Register (FTFA_FOPT)

The flash option register allows the MCU to customize its operations by examining the state of these read-only bits, which are loaded from NVM at reset. The function of the bits is defined in the device's Chip Configuration details.

All bits in the register are read-only .

During the reset sequence, the register is loaded from the flash nonvolatile option byte in the Flash Configuration Field located in program flash memory. The flash basis for the values is signified by X in the reset value. However, the register is written to 0xFF if the contents of the flash nonvolatile option byte are 0x00.

Address: 4002_0000h base + 3h offset = 4002_0003h

| | | | | | | | | |
|-------|-----|----|----|----|----|----|----|----|
| Bit | 7 | 6 | 5 | 4 | 3 | 2 | 1 | 0 |
| Read | OPT | | | | | | | |
| Write | | | | | | | | |
| Reset | x* | x* | x* | x* | x* | x* | x* | x* |

* Notes:

- x = Undefined at reset.

FTFA_FOPT field descriptions

| Field | Description |
|-------|--|
| OPT | Nonvolatile Option These bits are loaded from flash to this register at reset. Refer to the device's Chip Configuration details for the definition and use of these bits. |

28.3.3.5 Flash Common Command Object Registers (FTFA_FCCOBn)

The FCCOB register group provides 12 bytes for command codes and parameters. The individual bytes within the set append a 0-B hex identifier to the FCCOB register name: FCCOB0, FCCOB1, ..., FCCOBB.

Address: 4002_0000h base + 4h offset + (1d × i), where i=0d to 11d

| | | | | | | | | |
|-------|-------|---|---|---|---|---|---|---|
| Bit | 7 | 6 | 5 | 4 | 3 | 2 | 1 | 0 |
| Read | CCOBn | | | | | | | |
| Write | | | | | | | | |
| Reset | 0 | 0 | 0 | 0 | 0 | 0 | 0 | 0 |

FTFA_FCCOBn field descriptions

| Field | Description |
|-------|--|
| CCOBn | The FCCOB register provides a command code and relevant parameters to the memory controller. The individual registers that compose the FCCOB data set can be written in any order, but you must provide all needed values, which vary from command to command. First, set up all required FCCOB fields and then initiate the command's execution by writing a 1 to the FSTAT[CCIF] bit. This clears the CCIF bit, which locks all FCCOB parameter fields and they cannot be changed by the user until the command completes (CCIF returns to 1). No command buffering or queueing is provided; the next command can be loaded only after the current command completes. Some commands return information to the FCCOB registers. Any values returned to FCCOB are available for reading after the FSTAT[CCIF] flag returns to 1 by the memory controller. |

FTFA_FCCOB n field descriptions (continued)

| Field | Description | | | | | | | | | | | | | | | | | | | | | | | | | | |
|--------------|---|--------------|--|---|--|---|-----------------------|---|----------------------|---|---------------------|---|-------------|---|-------------|---|-------------|---|-------------|---|-------------|---|-------------|---|-------------|---|-------------|
| | <p>The following table shows a generic flash command format. The first FCCOB register, FCCOB0, always contains the command code. This 8-bit value defines the command to be executed. The command code is followed by the parameters required for this specific flash command, typically an address and/or data values.</p> <p>NOTE: The command parameter table is written in terms of FCCOB Number (which is equivalent to the byte number). This number is a reference to the FCCOB register name and is not the register address.</p> <table border="1"> <thead> <tr> <th>FCCOB Number</th> <th>Typical Command Parameter Contents [7:0]</th> </tr> </thead> <tbody> <tr> <td>0</td> <td>FCMD (a code that defines the flash command)</td> </tr> <tr> <td>1</td> <td>Flash address [23:16]</td> </tr> <tr> <td>2</td> <td>Flash address [15:8]</td> </tr> <tr> <td>3</td> <td>Flash address [7:0]</td> </tr> <tr> <td>4</td> <td>Data Byte 0</td> </tr> <tr> <td>5</td> <td>Data Byte 1</td> </tr> <tr> <td>6</td> <td>Data Byte 2</td> </tr> <tr> <td>7</td> <td>Data Byte 3</td> </tr> <tr> <td>8</td> <td>Data Byte 4</td> </tr> <tr> <td>9</td> <td>Data Byte 5</td> </tr> <tr> <td>A</td> <td>Data Byte 6</td> </tr> <tr> <td>B</td> <td>Data Byte 7</td> </tr> </tbody> </table> <p>FCCOB Endianness and Multi-Byte Access :</p> <p>The FCCOB register group uses a big endian addressing convention. For all command parameter fields larger than 1 byte, the most significant data resides in the lowest FCCOB register number. The FCCOB register group may be read and written as individual bytes, aligned words (2 bytes) or aligned longwords (4 bytes).</p> | FCCOB Number | Typical Command Parameter Contents [7:0] | 0 | FCMD (a code that defines the flash command) | 1 | Flash address [23:16] | 2 | Flash address [15:8] | 3 | Flash address [7:0] | 4 | Data Byte 0 | 5 | Data Byte 1 | 6 | Data Byte 2 | 7 | Data Byte 3 | 8 | Data Byte 4 | 9 | Data Byte 5 | A | Data Byte 6 | B | Data Byte 7 |
| FCCOB Number | Typical Command Parameter Contents [7:0] | | | | | | | | | | | | | | | | | | | | | | | | | | |
| 0 | FCMD (a code that defines the flash command) | | | | | | | | | | | | | | | | | | | | | | | | | | |
| 1 | Flash address [23:16] | | | | | | | | | | | | | | | | | | | | | | | | | | |
| 2 | Flash address [15:8] | | | | | | | | | | | | | | | | | | | | | | | | | | |
| 3 | Flash address [7:0] | | | | | | | | | | | | | | | | | | | | | | | | | | |
| 4 | Data Byte 0 | | | | | | | | | | | | | | | | | | | | | | | | | | |
| 5 | Data Byte 1 | | | | | | | | | | | | | | | | | | | | | | | | | | |
| 6 | Data Byte 2 | | | | | | | | | | | | | | | | | | | | | | | | | | |
| 7 | Data Byte 3 | | | | | | | | | | | | | | | | | | | | | | | | | | |
| 8 | Data Byte 4 | | | | | | | | | | | | | | | | | | | | | | | | | | |
| 9 | Data Byte 5 | | | | | | | | | | | | | | | | | | | | | | | | | | |
| A | Data Byte 6 | | | | | | | | | | | | | | | | | | | | | | | | | | |
| B | Data Byte 7 | | | | | | | | | | | | | | | | | | | | | | | | | | |

28.3.3.6 Program Flash Protection Registers (FTFA_FPROT n)

The FPROT registers define which program flash regions are protected from program and erase operations. Protected flash regions cannot have their content changed; that is, these regions cannot be programmed and cannot be erased by any flash command. Unprotected regions can be changed by program and erase operations.

The four FPROT registers allow up to 32 protectable regions. Each bit protects a 1/32 region of the program flash memory except for memory configurations with less than 64 KB of program flash where each assigned bit protects 2 KB. For configurations with 48 KB of program flash memory or less, FPROT0 is not used. For configurations with 32

KB of program flash memory or less, FPROT1 is not used. For configurations with 16 KB of program flash memory, FPROT2 is not used. The bitfields are defined in each register as follows:

| Program flash protection register | Program flash protection bits |
|-----------------------------------|-------------------------------|
| FPROT0 | PROT[31:24] |
| FPROT1 | PROT[23:16] |
| FPROT2 | PROT[15:8] |
| FPROT3 | PROT[7:0] |

During the reset sequence, the FPROT registers are loaded with the contents of the program flash protection bytes in the Flash Configuration Field as indicated in the following table.

| Program flash protection register | Flash Configuration Field offset address |
|-----------------------------------|--|
| FPROT0 | 0x000B |
| FPROT1 | 0x000A |
| FPROT2 | 0x0009 |
| FPROT3 | 0x0008 |

To change the program flash protection that is loaded during the reset sequence, unprotect the sector of program flash memory that contains the Flash Configuration Field. Then, reprogram the program flash protection byte.

Address: 4002_0000h base + 10h offset + (1d × i), where i=0d to 3d

| Bit | 7 | 6 | 5 | 4 | 3 | 2 | 1 | 0 |
|-------|------|----|----|----|----|----|----|----|
| Read | PROT | | | | | | | |
| Write | PROT | | | | | | | |
| Reset | x* | x* | x* | x* | x* | x* | x* | x* |

* Notes:

- x = Undefined at reset.

FTFA_FPROT_n field descriptions

| Field | Description |
|-------|---|
| PROT | <p>Program Flash Region Protect</p> <p>Each program flash region can be protected from program and erase operations by setting the associated PROT bit.</p> <p>In NVM Normal mode: The protection can only be increased, meaning that currently unprotected memory can be protected, but currently protected memory cannot be unprotected. Since unprotected regions are marked with a 1 and protected regions use a 0, only writes changing 1s to 0s are accepted. This 1-to-0 transition check is performed on a bit-by-bit basis. Those FPROT bits with 1-to-0 transitions are accepted while all bits with 0-to-1 transitions are ignored.</p> |

FTFA_FPROT_n field descriptions (continued)

| Field | Description |
|-------|---|
| | <p>In NVM Special mode: All bits of FPROT are writable without restriction. Unprotected areas can be protected and protected areas can be unprotected.</p> <p>Restriction: The user must never write to any FPROT register while a command is running (CCIF=0). Trying to alter data in any protected area in the program flash memory results in a protection violation error and sets the FSTAT[FPVIOL] bit. A full block erase of a program flash block is not possible if it contains any protected region.</p> <p>Each bit in the 32-bit protection register represents 1/32 of the total program flash except for memory configurations with less than 64 KB of program flash where each assigned bit protects 2 KB .</p> <p>0 Program flash region is protected. 1 Program flash region is not protected</p> |

28.3.3.7 Execute-only Access Registers (FTFA_XACC_n)

The XACC registers define which program flash segments are restricted to data read or execute only or both data and instruction fetches.

The eight XACC registers allow up to 64 restricted segments of equal memory size.

| Execute-only access register | Program flash execute-only access bits |
|------------------------------|--|
| XACCH0 | XA[63:56] |
| XACCH1 | XA[55:48] |
| XACCH2 | XA[47:40] |
| XACCH3 | XA[39:32] |
| XACCL0 | XA[31:24] |
| XACCL1 | XA[23:16] |
| XACCL2 | XA[15:8] |
| XACCL3 | XA[7:0] |

During the reset sequence, the XACC registers are loaded with the logical AND of Program Flash IFR addresses A and B as indicated in the following table.

| Execute-only access register | Program Flash IFR address A | Program Flash IFR address B |
|------------------------------|-----------------------------|-----------------------------|
| XACCH0 | 0xA3 | 0xAB |
| XACCH1 | 0xA2 | 0xAA |
| XACCH2 | 0xA1 | 0xA9 |
| XACCH3 | 0xA0 | 0xA8 |
| XACCL0 | 0xA7 | 0xAF |
| XACCL1 | 0xA6 | 0xAE |
| XACCL2 | 0xA5 | 0xAD |

Table continues on the next page...

| Execute-only access register | Program Flash IFR address A | Program Flash IFR address B |
|------------------------------|-----------------------------|-----------------------------|
| XACCL3 | 0xA4 | 0xAC |

Use the Program Once command to program the execute-only access control fields that are loaded during the reset sequence.

Address: 4002_0000h base + 18h offset + (1d × i), where i=0d to 7d

| Bit | 7 | 6 | 5 | 4 | 3 | 2 | 1 | 0 |
|-------|----------|----|----|----|----|----|----|----|
| Read | XA | | | | | | | |
| Write | [Shaded] | | | | | | | |
| Reset | x* | x* | x* | x* | x* | x* | x* | x* |

* Notes:

- x = Undefined at reset.

FTFA_XACCn field descriptions

| Field | Description |
|-------|---|
| XA | Execute-only access control |
| 0 | Associated segment is accessible in execute mode only (as an instruction fetch) |
| 1 | Associated segment is accessible as data or in execute mode |

28.3.3.8 Supervisor-only Access Registers (FTFA_SACCn)

The SACC registers define which program flash segments are restricted to supervisor only or user and supervisor access.

The eight SACC registers allow up to 64 restricted segments of equal memory size.

| Supervisor-only access register | Program flash supervisor-only access bits |
|---------------------------------|---|
| SACCH0 | SA[63:56] |
| SACCH1 | SA[55:48] |
| SACCH2 | SA[47:40] |
| SACCH3 | SA[39:32] |
| SACCL0 | SA[31:24] |
| SACCL1 | SA[23:16] |
| SACCL2 | SA[15:8] |
| SACCL3 | SA[7:0] |

During the reset sequence, the SACC registers are loaded with the logical AND of Program Flash IFR addresses A and B as indicated in the following table.

Memory Map and Registers

| Supervisor-only access register | Program Flash IFR address A | Program Flash IFR address B |
|---------------------------------|-----------------------------|-----------------------------|
| SACCH0 | 0xB3 | 0xBB |
| SACCH1 | 0xB2 | 0xBA |
| SACCH2 | 0xB1 | 0xB9 |
| SACCH3 | 0xB0 | 0xB8 |
| SACCL0 | 0xB7 | 0xBF |
| SACCL1 | 0xB6 | 0xBE |
| SACCL2 | 0xB5 | 0xBD |
| SACCL3 | 0xB4 | 0xBC |

Use the Program Once command to program the supervisor-only access control fields that are loaded during the reset sequence.

Address: 4002_0000h base + 20h offset + (1d × i), where i=0d to 7d

| Bit | 7 | 6 | 5 | 4 | 3 | 2 | 1 | 0 |
|-------|----|----|----|----|----|----|----|----|
| Read | SA | | | | | | | |
| Write | | | | | | | | |
| Reset | x* | x* | x* | x* | x* | x* | x* | x* |

* Notes:

- x = Undefined at reset.

FTFA_SACCN field descriptions

| Field | Description |
|-------|---|
| SA | Supervisor-only access control |
| 0 | Associated segment is accessible in supervisor mode only |
| 1 | Associated segment is accessible in user or supervisor mode |

28.3.3.9 Flash Access Segment Size Register (FTFA_FACSS)

The flash access segment size register determines which bits in the address are used to index into the SACC and XACC bitmaps to get the appropriate permission flags.

All bits in the register are read-only.

The contents of this register are loaded during the reset sequence.

Address: 4002_0000h base + 28h offset = 4002_0028h

| Bit | 7 | 6 | 5 | 4 | 3 | 2 | 1 | 0 |
|-------|--------|----|----|----|----|----|----|----|
| Read | SGSIZE | | | | | | | |
| Write | | | | | | | | |
| Reset | x* | x* | x* | x* | x* | x* | x* | x* |

* Notes:

- x = Undefined at reset.

FTFA_FACSS field descriptions

| Field | Description | | | | | | | | | |
|------------|---|--------------------|-----------------------|-----------------------|------------|----------|-----|------------|----------|-----|
| SGSIZE | Segment Size | | | | | | | | | |
| | The segment size is a fixed value based on the available program flash size divided by NUMSG. | | | | | | | | | |
| | <table border="1"> <thead> <tr> <th>Program Flash Size</th> <th>Segment Size</th> <th>Segment Size Encoding</th> </tr> </thead> <tbody> <tr> <td>256 KBytes</td> <td>4 KBytes</td> <td>0x4</td> </tr> <tr> <td>512 KBytes</td> <td>8 KBytes</td> <td>0x5</td> </tr> </tbody> </table> | Program Flash Size | Segment Size | Segment Size Encoding | 256 KBytes | 4 KBytes | 0x4 | 512 KBytes | 8 KBytes | 0x5 |
| | Program Flash Size | Segment Size | Segment Size Encoding | | | | | | | |
| 256 KBytes | 4 KBytes | 0x4 | | | | | | | | |
| 512 KBytes | 8 KBytes | 0x5 | | | | | | | | |
| | | | | | | | | | | |

28.3.3.10 Flash Access Segment Number Register (FTFA_FACSN)

The flash access segment number register provides the number of program flash segments that are available for XACC and SACC permissions.

All bits in the register are read-only.

The contents of this register are loaded during the reset sequence.

Address: 4002_0000h base + 2Bh offset = 4002_002Bh

| Bit | 7 | 6 | 5 | 4 | 3 | 2 | 1 | 0 |
|-------|-------|----|----|----|----|----|----|----|
| Read | NUMSG | | | | | | | |
| Write | | | | | | | | |
| Reset | x* | x* | x* | x* | x* | x* | x* | x* |

* Notes:

- x = Undefined at reset.

FTFA_FACSN field descriptions

| Field | Description |
|-------|---|
| NUMSG | <p>Number of Segments Indicator</p> <p>The NUMSG field indicates the number of equal-sized segments in the program flash.</p> <p>0x4x Program flash memory is divided into 64 segments (256 Kbytes, 512 Kbytes)</p> |

28.4 Functional Description

The information found here describes functional details of the flash memory module.

28.4.1 Flash Protection

Individual regions within the flash memory can be protected from program and erase operations.

Protection is controlled by the following registers:

- FPROT_n —
 - For 2ⁿ program flash sizes, four registers typically protect 32 regions of the program flash memory as shown in the following figure

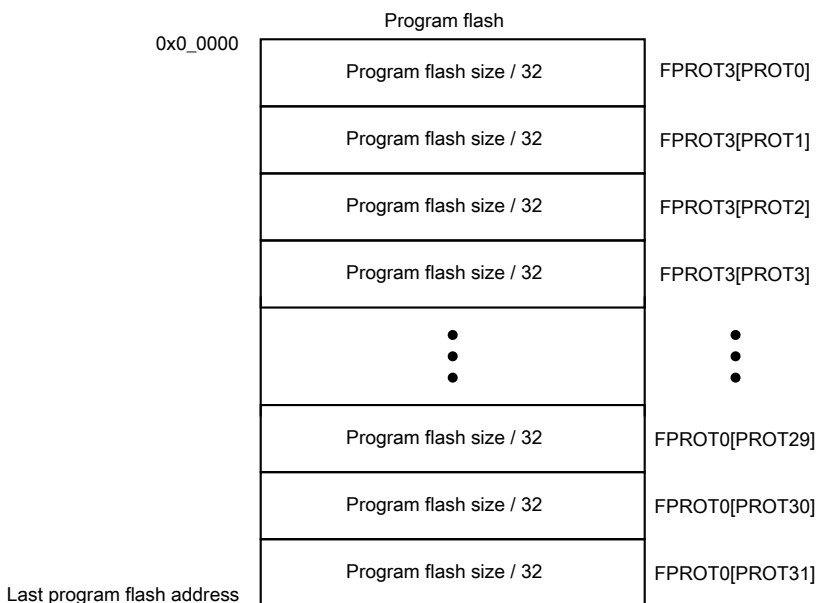

Figure 28-2. Program flash protection

NOTE

Flash protection features are discussed further in [AN4507: Using the Kinetis Security and Flash Protection Features](#) . Not all features described in the application note are available on this device.

28.4.2 Flash Access Protection

Individual segments within the program flash memory can be designated for restricted access. Specific flash commands (Program Check, Program Longword, Erase Flash Block, Erase Flash Sector) monitor FXACC contents to protect flash memory but the FSACC contents do not impact flash command operation.

See [AN5112: Using the Kinetis Flash Execute-Only Access Control Feature](#) for further details.

Access is controlled by the following registers:

- FTFA_XACC —
 - For 2^n program flash sizes greater than 128KB, eight registers control 64 segments of the program flash memory as shown in the following figure

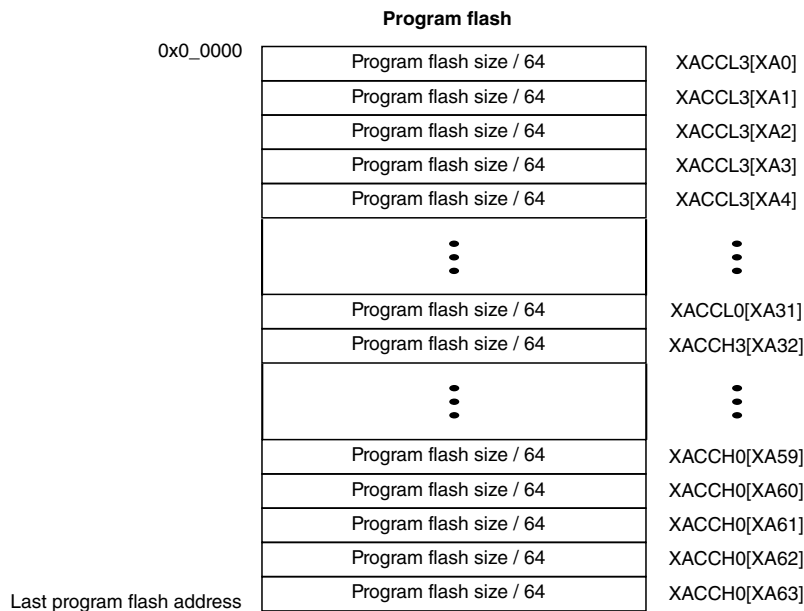

Figure 28-3. Program flash execute-only access control (256KB or 512KB of program flash)

- FTFA_SACC —
 - For 2^n program flash sizes greater than 128KB, eight registers control 64 segments of the program flash memory as shown in the following figure

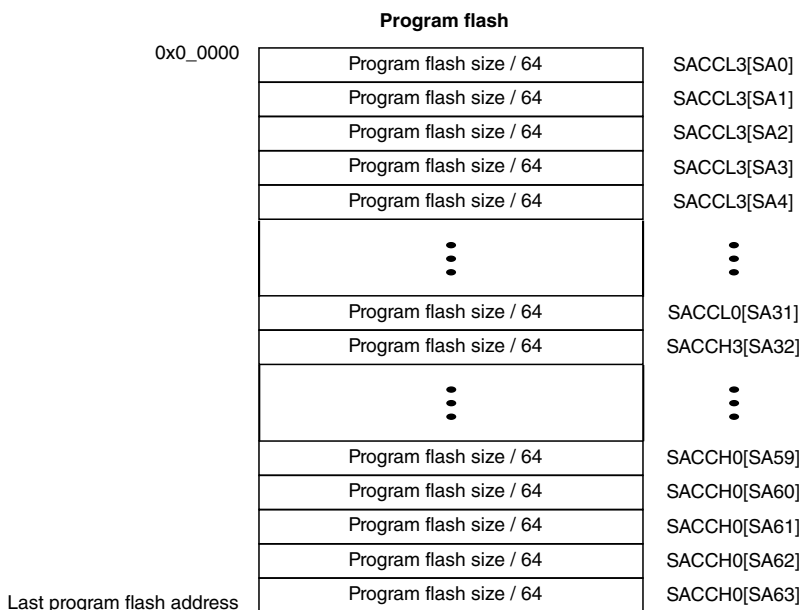

Figure 28-4. Program flash supervisor access control (256KB or 512KB of program flash)

28.4.3 Interrupts

The flash memory module can generate interrupt requests to the MCU upon the occurrence of various flash events.

These interrupt events and their associated status and control bits are shown in the following table.

Table 28-1. Flash Interrupt Sources

| Flash Event | Readable Status Bit | Interrupt Enable Bit |
|----------------------------|---------------------|----------------------|
| Flash Command Complete | FSTAT[CCIF] | FCNFG[CCIE] |
| Flash Read Collision Error | FSTAT[RDCOLERR] | FCNFG[RDCOLLIE] |

Note

Vector addresses and their relative interrupt priority are determined at the MCU level.

Some devices also generate a bus error response as a result of a Read Collision Error event. See the chip configuration information to determine if a bus error response is also supported.

28.4.4 Flash Operation in Low-Power Modes

28.4.4.1 Wait Mode

When the MCU enters wait mode, the flash memory module is not affected. The flash memory module can recover the MCU from wait via the command complete interrupt (see [Interrupts](#)).

28.4.4.2 Stop Mode

When the MCU requests stop mode, if a flash command is active ($CCIF = 0$) the command execution completes before the MCU is allowed to enter stop mode.

CAUTION

The MCU should never enter stop mode while any flash command is running ($CCIF = 0$).

NOTE

While the MCU is in very-low-power modes (VLPR, VLPW, VLPS), the flash memory module does not accept flash commands.

28.4.5 Functional Modes of Operation

The flash memory module has two operating modes: NVM Normal and NVM Special.

The operating mode affects the command set availability (see [Table 28-2](#)). Refer to the Chip Configuration details of this device for how to activate each mode.

28.4.6 Flash Reads and Ignored Writes

The flash memory module requires only the flash address to execute a flash memory read.

The MCU must not read from the flash memory while commands are running (as evidenced by CCIF=0) on that block. Read data cannot be guaranteed from a flash block while any command is processing within that block. The block arbitration logic detects any simultaneous access and reports this as a read collision error (see the FSTAT[RDCOLERR] bit).

28.4.7 Read While Write (RWW)

The following simultaneous accesses are allowed:

- The user may read from one logical program flash memory space while flash commands are active in the other logical program flash memory space.

Simultaneous operations are further discussed in [Allowed Simultaneous Flash Operations](#).

28.4.8 Flash Program and Erase

All flash functions except read require the user to setup and launch a flash command through a series of peripheral bus writes.

The user cannot initiate any further flash commands until notified that the current command has completed. The flash command structure and operation are detailed in [Flash Command Operations](#).

28.4.9 Flash Command Operations

Flash command operations are typically used to modify flash memory contents.

The next sections describe:

- The command write sequence used to set flash command parameters and launch execution
- A description of all flash commands available

28.4.9.1 Command Write Sequence

Flash commands are specified using a command write sequence illustrated in [Figure 28-5](#). The flash memory module performs various checks on the command (FCCOB) content and continues with command execution if all requirements are fulfilled.

Before launching a command, the ACCERR and FPVIOL bits in the FSTAT register must be zero and the CCIF flag must read 1 to verify that any previous command has completed. If CCIF is zero, the previous command execution is still active, a new command write sequence cannot be started, and all writes to the FCCOB registers are ignored.

Attempts to launch a flash command in VLP mode will be ignored. Attempts to launch a flash command while the BLE radio is active are ignored.

28.4.9.1.1 Load the FCCOB Registers

The user must load the FCCOB registers with all parameters required by the desired flash command. The individual registers that make up the FCCOB data set can be written in any order.

28.4.9.1.2 Launch the Command by Clearing CCIF

Once all relevant command parameters have been loaded, the user launches the command by clearing FSTAT[CCIF] by writing a '1' to it. FSTAT[CCIF] remains 0 until the flash command completes.

The FSTAT register contains a blocking mechanism that prevents a new command from launching (can't clear FSTAT[CCIF]) if the previous command resulted in an access error (FSTAT[ACCERR]=1) or a protection violation (FSTAT[FPVIOL]=1). In error scenarios, two writes to FSTAT are required to initiate the next command: the first write clears the error flags, the second write clears CCIF.

28.4.9.1.3 Command Execution and Error Reporting

The command processing has several steps:

1. The flash memory module reads the command code and performs a series of parameter checks and protection checks, if applicable, which are unique to each command.

Functional Description

If the parameter check fails, the FSTAT[ACCERR] (access error) flag is set. FSTAT[ACCERR] reports invalid instruction codes and out-of bounds addresses. Usually, access errors suggest that the command was not set-up with valid parameters in the FCCOB register group.

Program and erase commands also check the address to determine if the operation is requested to execute on protected areas. If the protection check fails, FSTAT[FPVIOL] (protection error) flag is set.

Command processing never proceeds to execution when the parameter or protection step fails. Instead, command processing is terminated after setting FSTAT[CCIF].

2. If the parameter and protection checks pass, the command proceeds to execution. Run-time errors, such as failure to erase verify, may occur during the execution phase. Run-time errors are reported in FSTAT[MGSTAT0]. A command may have access errors, protection errors, and run-time errors, but the run-time errors are not seen until all access and protection errors have been corrected.
3. Command execution results, if applicable, are reported back to the user via the FCCOB and FSTAT registers.
4. The flash memory module sets FSTAT[CCIF] signifying that the command has completed.

The flow for a generic command write sequence is illustrated in the following figure.

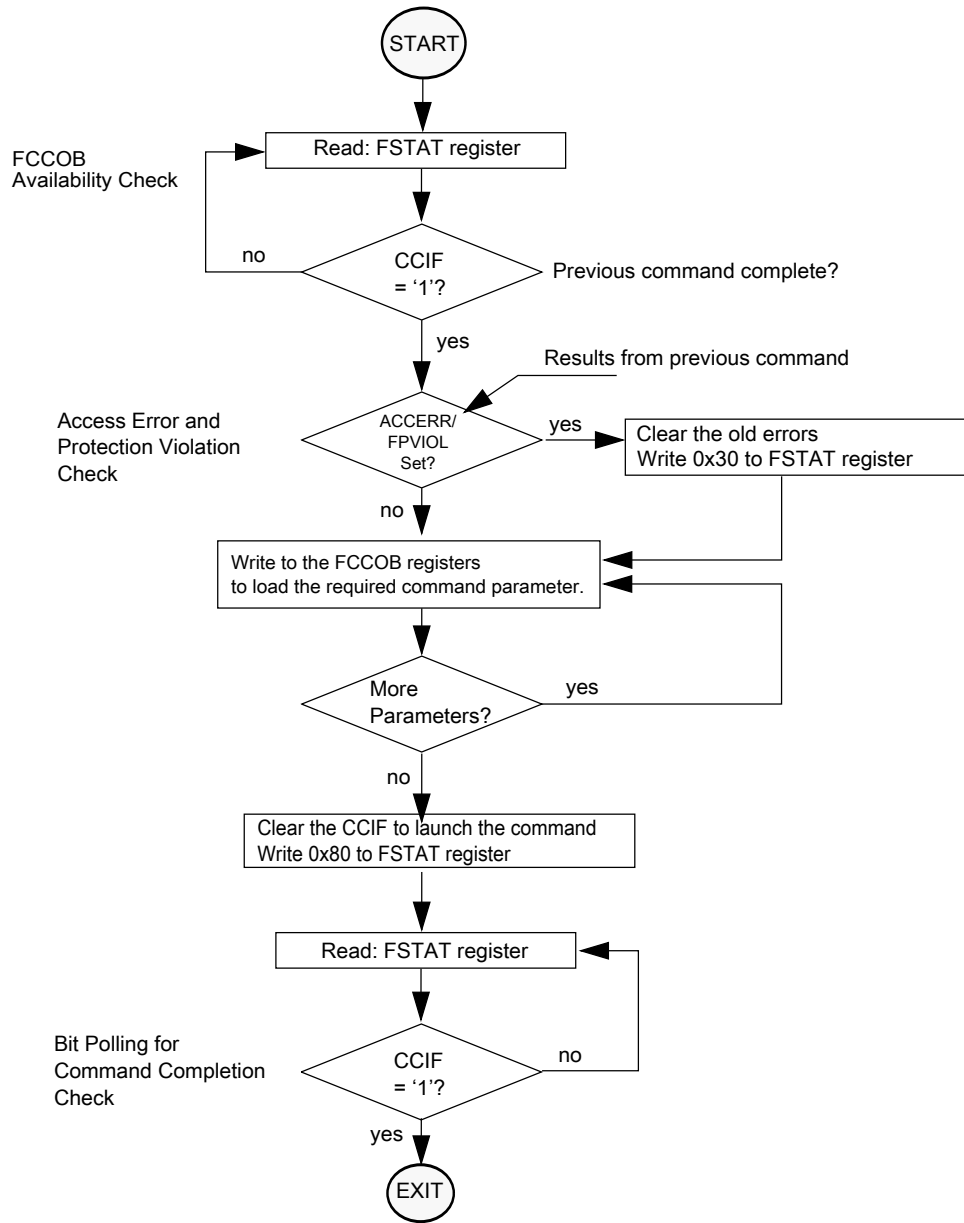

Figure 28-5. Generic flash command write sequence flowchart

28.4.9.2 Flash Commands

The following table summarizes the function of all flash commands.

| FCMD | Command | Program flash 0 | Program flash 1 | Function |
|------|---------------|-----------------|-----------------|--|
| 0x00 | Read 1s Block | x | x | Verify that a program flash block is erased. |

Table continues on the next page...

Functional Description

| FCMD | Command | Program flash 0 | Program flash 1 | Function |
|------|----------------------------|-----------------|-----------------|---|
| 0x01 | Read 1s Section | × | × | Verify that a given number of program flash locations from a starting address are erased. |
| 0x02 | Program Check | × | × | Tests previously-programmed locations at margin read levels. |
| 0x03 | Read Resource | IFR, ID | IFR | Read 4 bytes from program flash IFR or version ID. |
| 0x06 | Program Longword | × | × | Program 4 bytes in a program flash block. |
| 0x08 | Erase Flash Block | × | × | Erase a program flash block. An erase of any flash block is only possible when unprotected. |
| 0x09 | Erase Flash Sector | × | × | Erase all bytes in a program flash sector. |
| 0x40 | Read 1s All Blocks | × | × | Verify that all program flash blocks are erased then release MCU security. |
| 0x41 | Read Once | IFR | | Read 4 bytes of a dedicated 64 byte field in the program flash 0 IFR. |
| 0x43 | Program Once | IFR | | One-time program of 4 bytes of a dedicated 64-byte field in the program flash 0 IFR. |
| 0x44 | Erase All Blocks | × | × | Erase all program flash blocks. Then, verify-erase and release MCU security. NOTE: An erase is only possible when all memory locations are unprotected. |
| 0x45 | Verify Backdoor Access Key | × | × | Release MCU security after comparing a set of user-supplied security keys to those stored in the program flash. |

Table continues on the next page...

| FCMD | Command | Program flash 0 | Program flash 1 | Function |
|------|-----------------------------------|-----------------|-----------------|--|
| 0x49 | Erase All Blocks Unsecure | × | × | Erase all program flash blocks, verify-erase, program security byte to unsecure state, release MCU security. |
| 0x4A | Read 1s All Execute-only Segments | × | × | Verify that all program flash execute-only (XA) segments are erased then release flash access control. |
| 0x4B | Erase All Execute-only Segments | × | × | Erase all program flash execute-only (XA) segments then release flash access control. |

28.4.9.3 Flash Commands by Mode

The following table shows the flash commands that can be executed in each flash operating mode.

Table 28-2. Flash Commands by Mode

| FCMD | Command | NVM Normal | | | NVM Special | | |
|------|-----------------------------------|------------|--------|---------|-------------|--------|---------|
| | | Unsecure | Secure | MEEN=10 | Unsecure | Secure | MEEN=10 |
| 0x00 | Read 1s Block | × | × | × | × | — | — |
| 0x01 | Read 1s Section | × | × | × | × | — | — |
| 0x02 | Program Check | × | × | × | × | — | — |
| 0x03 | Read Resource | × | × | × | × | — | — |
| 0x06 | Program Longword | × | × | × | × | — | — |
| 0x08 | Erase Flash Block | × | × | × | × | — | — |
| 0x09 | Erase Flash Sector | × | × | × | × | — | — |
| 0x40 | Read 1s All Blocks | × | × | — | × | × | — |
| 0x41 | Read Once | × | × | × | × | — | — |
| 0x43 | Program Once | × | × | × | × | — | — |
| 0x44 | Erase All Blocks | × | × | — | × | × | — |
| 0x45 | Verify Backdoor Access Key | × | × | × | × | — | — |
| 0x49 | Erase All Blocks Unsecure | × | × | — | × | × | — |
| 0x4A | Read 1s All Execute-only Segments | × | × | × | × | — | — |
| 0x4B | Erase All Execute-only Segments | × | × | × | × | — | — |

28.4.9.4 Allowed Simultaneous Flash Operations

Only the operations marked 'OK' in the following table are permitted to run simultaneously on the program flash memories. Some operations cannot be executed simultaneously because certain hardware resources are shared by the memories.

Table 28-3. Allowed Simultaneous Memory Operations

| | | Program Flash 0 | | | Program Flash 1 | | |
|-----------------|--------------|-----------------|---------|--------------|-----------------|---------|--------------|
| | | Read | Program | Sector Erase | Read | Program | Sector Erase |
| Program flash 0 | Read | — | | | | OK | OK |
| | Program | | — | | OK | | |
| | Sector Erase | | | — | OK | | |
| Program flash 1 | Read | | OK | OK | — | | |
| | Program | OK | | | | — | |
| | Sector Erase | OK | | | | | — |

28.4.10 Margin Read Commands

The Read-1s commands (Read 1s All Blocks, Read 1s Block, Read 1s Section, Read 1s All Execute-only Segments) and the Program Check command have a margin choice parameter that allows the user to apply non-standard read reference levels to the program flash array reads performed by these commands. Using the preset 'user' and 'factory' margin levels, these commands perform their associated read operations at tighter tolerances than a 'normal' read. These non-standard read levels are applied only during the command execution. Basic flash array reads use the standard, un-margined, read reference level.

Only the 'normal' read level should be employed during normal flash usage. The non-standard, 'user' and 'factory' margin levels should be employed only in special cases. They can be used during special diagnostic routines to gain confidence that the device is not suffering from the end-of-life data loss customary of flash memory devices.

Erased ('1') and programmed ('0') bit states can degrade due to elapsed time and data cycling (number of times a bit is erased and re-programmed). The lifetime of the erased states is relative to the last erase operation. The lifetime of the programmed states is measured from the last program time.

The 'user' and 'factory' levels become, in effect, a minimum safety margin; i.e. if the reads pass at the tighter tolerances of the 'user' and 'factory' margins, then the 'normal' reads have at least this much safety margin before they experience data loss.

The 'user' margin is a small delta to the normal read reference level. 'User' margin levels can be employed to check that flash memory contents have adequate margin for normal level read operations. If unexpected read results are encountered when checking flash memory contents at the 'user' margin levels, loss of information might soon occur during 'normal' readout.

The 'factory' margin is a bigger deviation from the norm, a more stringent read criteria that should only be attempted immediately (or very soon) after completion of an erase or program command, early in the cycling life. 'Factory' margin levels can be used to check that flash memory contents have adequate margin for long-term data retention at the normal level setting. If unexpected results are encountered when checking flash memory contents at 'factory' margin levels, the flash memory contents should be erased and reprogrammed.

CAUTION

Factory margin levels must only be used during verify of the initial factory programming.

28.4.11 Flash Command Description

This section describes all flash commands that can be launched by a command write sequence.

The flash memory module sets the FSTAT[ACCERR] bit and aborts the command execution if any of the following illegal conditions occur:

- There is an unrecognized command code in the FCCOB FCMD field.
- There is an error in a FCCOB field for the specific commands. Refer to the error handling table provided for each command.

Ensure that FSTAT[ACCERR] and FSTAT[FPVIOL] are cleared prior to starting the command write sequence. As described in [Launch the Command by Clearing CCIF](#), a new command cannot be launched while these error flags are set.

Do not attempt to read a flash block while the flash memory module is running a command (FSTAT[CCIF] = 0) on that same block. The flash memory module may return invalid data to the MCU with the collision error flag (FSTAT[RDCOLERR]) set.

CAUTION

Flash data must be in the erased state before being programmed. Cumulative programming of bits (adding more zeros) is not allowed.

28.4.11.1 Read 1s Block Command

The Read 1s Block command checks to see if an entire program flash block has been erased to the specified margin level. The FCCOB flash address bits determine which flash block is erase-verified.

Table 28-4. Read 1s Block Command FCCOB Requirements

| FCCOB Number | FCCOB Contents [7:0] |
|--------------|--|
| 0 | 0x00 (RD1BLK) |
| 1 | Flash address [23:16] in the flash block to be verified |
| 2 | Flash address [15:8] in the flash block to be verified |
| 3 | Flash address [7:0] ¹ in the flash block to be verified |
| 4 | Read-1 Margin Choice |

1. Must be longword aligned (Flash address [1:0] = 00).

After clearing CCIF to launch the Read 1s Block command, the flash memory module sets the read margin for 1s according to [Table 28-5](#) and then reads all locations within the selected program flash block.

Table 28-5. Margin Level Choices for Read 1s Block

| Read Margin Choice | Margin Level Description |
|--------------------|---|
| 0x00 | Use the 'normal' read level for 1s |
| 0x01 | Apply the 'User' margin to the normal read-1 level |
| 0x02 | Apply the 'Factory' margin to the normal read-1 level |

Table 28-6. Read 1s Block Command Error Handling

| Error Condition | Error Bit |
|---|----------------|
| Command not available in current mode/security | FSTAT[ACCERR] |
| An invalid margin choice is specified | FSTAT[ACCERR] |
| Program flash is selected and the address is out of program flash range | FSTAT[ACCERR] |
| Flash address is not longword aligned | FSTAT[ACCERR] |
| Read-1s fails | FSTAT[MGSTAT0] |

28.4.11.2 Read 1s Section Command

The Read 1s Section command checks if a section of program flash memory is erased to the specified read margin level. The Read 1s Section command defines the starting address and the number of phrases to be verified.

Table 28-7. Read 1s Section Command FCCOB Requirements

| FCCOB Number | FCCOB Contents [7:0] |
|--------------|---|
| 0 | 0x01 (RD1SEC) |
| 1 | Flash address [23:16] of the first phrase to be verified |
| 2 | Flash address [15:8] of the first phrase to be verified |
| 3 | Flash address [7:0] ¹ of the first phrase to be verified |
| 4 | Number of phrases to be verified [15:8] |
| 5 | Number of phrases to be verified [7:0] |
| 6 | Read-1 Margin Choice |

1. Must be phrase aligned (Flash address [2:0] = 000).

Upon clearing CCIF to launch the Read 1s Section command, the flash memory module sets the read margin for 1s according to [Table 28-8](#) and then reads all locations within the specified section of flash memory. If the flash memory module fails to read all 1s (that is, the flash section is not erased), FSTAT[MGSTAT0] is set. FSTAT[CCIF] sets after the Read 1s Section operation completes.

Table 28-8. Margin Level Choices for Read 1s Section

| Read Margin Choice | Margin Level Description |
|--------------------|---|
| 0x00 | Use the 'normal' read level for 1s |
| 0x01 | Apply the 'User' margin to the normal read-1 level |
| 0x02 | Apply the 'Factory' margin to the normal read-1 level |

Table 28-9. Read 1s Section Command Error Handling

| Error condition | Error bit |
|---|----------------|
| Command not available in current mode/security | FSTAT[ACCERR] |
| An invalid margin code is supplied. | FSTAT[ACCERR] |
| An invalid flash address is supplied. | FSTAT[ACCERR] |
| Flash address is not phrase aligned. | FSTAT[ACCERR] |
| The requested section crosses a Flash block boundary. | FSTAT[ACCERR] |
| The requested number of phrases is 0. | FSTAT[ACCERR] |
| Read-1s fails. | FSTAT[MGSTAT0] |

28.4.11.3 Program Check Command

The Program Check command tests a previously programmed program flash longword to see if it reads correctly at the specified margin level.

Table 28-10. Program Check Command FCCOB Requirements

| FCCOB Number | FCCOB Contents [7:0] |
|--------------|----------------------------------|
| 0 | 0x02 (PGMCHK) |
| 1 | Flash address [23:16] |
| 2 | Flash address [15:8] |
| 3 | Flash address [7:0] ¹ |
| 4 | Margin Choice |
| 8 | Byte 0 expected data |
| 9 | Byte 1 expected data |
| A | Byte 2 expected data |
| B | Byte 3 expected data |

1. Must be longword aligned (Flash address [1:0] = 00).

Upon clearing CCIF to launch the Program Check command, the flash memory module sets the read margin for 1s according to [Table 28-11](#), reads the specified longword, and compares the actual read data to the expected data provided by the FCCOB. If the comparison at margin-1 fails, FSTAT[MGSTAT0] is set.

The flash memory module then sets the read margin for 0s, re-reads, and compares again. If the comparison at margin-0 fails, FSTAT[MGSTAT0] is set. FSTAT[CCIF] is set after the Program Check operation completes.

The supplied address must be longword aligned (the lowest two bits of the byte address must be 00):

- Byte 3 data is written to the supplied byte address ('start'),
- Byte 2 data is programmed to byte address start+0b01,
- Byte 1 data is programmed to byte address start+0b10,
- Byte 0 data is programmed to byte address start+0b11.

NOTE

See the description of margin reads, [Margin Read Commands](#)

Table 28-11. Margin Level Choices for Program Check

| Read Margin Choice | Margin Level Description |
|--------------------|---|
| 0x01 | Read at 'User' margin-1 and 'User' margin-0 |
| 0x02 | Read at 'Factory' margin-1 and 'Factory' margin-0 |

Table 28-12. Program Check Command Error Handling

| Error Condition | Error Bit |
|--|---------------|
| Command not available in current mode/security | FSTAT[ACCERR] |
| An invalid flash address is supplied | FSTAT[ACCERR] |

Table continues on the next page...

Table 28-12. Program Check Command Error Handling (continued)

| Error Condition | Error Bit |
|--|----------------|
| Flash address is not longword aligned | FSTAT[ACCERR] |
| An invalid margin choice is supplied | FSTAT[ACCERR] |
| Flash address is located in an XA controlled segment and the Erase All Blocks, Erase All Blocks Unsecure or the Read 1s All Blocks command has not successfully completed since the last reset | FSTAT[FPVIOL] |
| Either of the margin reads does not match the expected data | FSTAT[MGSTAT0] |

28.4.11.4 Read Resource Command

The Read Resource command allows the user to read data from special-purpose memory resources located within the flash memory module. The special-purpose memory resources available include program flash IFR space and the Version ID field. Each resource is assigned a select code as shown in [Table 28-14](#).

Table 28-13. Read Resource Command FCCOB Requirements

| FCCOB Number | FCCOB Contents [7:0] |
|----------------------|---|
| 0 | 0x03 (RDRSRC) |
| 1 | Flash address [23:16] |
| 2 | Flash address [15:8] |
| 3 | Flash address [7:0] ¹ |
| Returned Values | |
| 4 | Read Data [31:24] |
| 5 | Read Data [23:16] |
| 6 | Read Data [15:8] |
| 7 | Read Data [7:0] |
| User-provided values | |
| 8 | Resource Select Code (see Table 28-14) |

1. Must be longword aligned (Flash address [1:0] = 00).

Table 28-14. Read Resource Select Codes

| Resource Select Code | Description | Resource Size | Local Address Range |
|----------------------|---------------------|---------------|---------------------|
| 0x00 | Program Flash 0 IFR | 256 Bytes | 0x00_0000–0x00_00FF |
| 0x01 ¹ | Version ID | 8 Bytes | 0x00_0000–0x00_0007 |

1. Located in program flash 0 reserved space.

Functional Description

After clearing CCIF to launch the Read Resource command, four consecutive bytes are read from the selected resource at the provided relative address and stored in the FCCOB register. The CCIF flag sets after the Read Resource operation completes. The Read Resource command exits with an access error if an invalid resource code is provided or if the address for the applicable area is out-of-range.

Table 28-15. Read Resource Command Error Handling

| Error Condition | Error Bit |
|--|---------------|
| Command not available in current mode/security | FSTAT[ACCERR] |
| An invalid resource code is entered | FSTAT[ACCERR] |
| Flash address is out-of-range for the targeted resource. | FSTAT[ACCERR] |
| Flash address is not longword aligned | FSTAT[ACCERR] |

28.4.11.5 Program Longword Command

The Program Longword command programs four previously-erased bytes in the program flash memory using an embedded algorithm.

CAUTION

A flash memory location must be in the erased state before being programmed. Cumulative programming of bits (back-to-back program operations without an intervening erase) within a flash memory location is not allowed. Re-programming of existing 0s to 0 is not allowed as this overstresses the device.

Table 28-16. Program Longword Command FCCOB Requirements

| FCCOB Number | FCCOB Contents [7:0] |
|--------------|----------------------------------|
| 0 | 0x06 (PGM4) |
| 1 | Flash address [23:16] |
| 2 | Flash address [15:8] |
| 3 | Flash address [7:0] ¹ |
| 4 | Byte 0 program value |
| 5 | Byte 1 program value |
| 6 | Byte 2 program value |
| 7 | Byte 3 program value |

1. Must be longword aligned (Flash address [1:0] = 00).

Upon clearing CCIF to launch the Program Longword command, the flash memory module programs the data bytes into the flash using the supplied address. The targeted flash locations must be currently unprotected (see the description of the FPROT registers) to permit execution of the Program Longword operation.

The programming operation is unidirectional. It can only move NVM bits from the erased state ('1') to the programmed state ('0'). Erased bits that fail to program to the '0' state are flagged as errors in FSTAT[MGSTAT0]. The CCIF flag is set after the Program Longword operation completes.

The supplied address must be longword aligned (flash address [1:0] = 00):

- Byte 3 data is written to the supplied byte address ('start'),
- Byte 2 data is programmed to byte address start+0b01,
- Byte 1 data is programmed to byte address start+0b10, and
- Byte 0 data is programmed to byte address start+0b11.

Table 28-17. Program Longword Command Error Handling

| Error Condition | Error Bit |
|--|----------------|
| Command not available in current mode/security | FSTAT[ACCERR] |
| An invalid flash address is supplied | FSTAT[ACCERR] |
| Flash address is not longword aligned | FSTAT[ACCERR] |
| Flash address points to a protected area | FSTAT[FPVIOL] |
| Flash address is located in an XA controlled segment and the Erase All Blocks, Erase All Blocks Unsecure or the Read 1s All Blocks command has not successfully completed since the last reset | FSTAT[FPVIOL] |
| Any errors have been encountered during the verify operation | FSTAT[MGSTAT0] |

28.4.11.6 Erase Flash Block Command

The Erase Flash Block operation erases all addresses in a single program flash.

Table 28-18. Erase Flash Block Command FCCOB Requirements

| FCCOB Number | FCCOB Contents [7:0] |
|--------------|--|
| 0 | 0x08 (ERSBLK) |
| 1 | Flash address [23:16] in the flash block to be erased |
| 2 | Flash address [15:8] in the flash block to be erased |
| 3 | Flash address [7:0] ¹ in the flash block to be erased |

1. Must be longword aligned (Flash address [1:0] = 00).

Functional Description

Upon clearing CCIF to launch the Erase Flash Block command, the flash memory module erases the main array of the selected flash block and verifies that it is erased. The Erase Flash Block command aborts and sets the FSTAT[FPVIOL] bit if any region within the block is protected (see the description of the FPROT registers). If the erase verify fails, FSTAT[MGSTAT0] is set. The CCIF flag will set after the Erase Flash Block operation has completed.

CAUTION

The Erase Flash Block operation will not react to the early indicator for BLE radio activity. Therefore, the Erase Flash Block command must not be launched if there is a concern about inadequate power available to support both BLE radio activity and the Erase Flash Block operation.

Table 28-19. Erase Flash Block Command Error Handling

| Error Condition | Error Bit |
|--|----------------|
| Command not available in current mode/security | FSTAT[ACCERR] |
| Program flash is selected and the address is out of program flash range | FSTAT[ACCERR] |
| Flash address is not longword aligned | FSTAT[ACCERR] |
| Any area of the selected flash block is protected | FSTAT[FPVIOL] |
| The selected program flash block contains an XA controlled segment and the Erase All Blocks, Erase All Blocks Unsecure or the Read 1s All Blocks command has not successfully completed since the last reset | FSTAT[FPVIOL] |
| Any errors have been encountered during the verify operation ¹ | FSTAT[MGSTAT0] |

1. User margin read may be run using the Read 1s Block command to verify all bits are erased.

28.4.11.7 Erase Flash Sector Command

The Erase Flash Sector operation erases all addresses in a flash sector.

Table 28-20. Erase Flash Sector Command FCCOB Requirements

| FCCOB Number | FCCOB Contents [7:0] |
|--------------|---|
| 0 | 0x09 (ERSSCR) |
| 1 | Flash address [23:16] in the flash sector to be erased |
| 2 | Flash address [15:8] in the flash sector to be erased |
| 3 | Flash address [7:0] ¹ in the flash sector to be erased |

1. Must be phrase aligned (flash address [2:0] = 000).

After clearing CCIF to launch the Erase Flash Sector command, the flash memory module erases the selected program flash sector and then verifies that it is erased. The Erase Flash Sector command aborts if the selected sector is protected (see the description

of the FPROT registers). If the erase-verify fails the FSTAT[MGSTAT0] bit is set. The CCIF flag is set after the Erase Flash Sector operation completes. The Erase Flash Sector command is suspendable (see the FCNFG[ERSSUSP] bit and [Figure 28-6](#)).

Table 28-21. Erase Flash Sector Command Error Handling

| Error Condition | Error Bit |
|--|----------------|
| Command not available in current mode/security | FSTAT[ACCERR] |
| An invalid Flash address is supplied | FSTAT[ACCERR] |
| Flash address is not phrase aligned | FSTAT[ACCERR] |
| The selected program flash sector is protected | FSTAT[FPVIOL] |
| The selected program flash sector is located in an XA controlled segment and the Erase All Blocks, Erase All Blocks Unsecure or the Read 1s All Blocks command has not successfully completed since the last reset | FSTAT[FPVIOL] |
| Any errors have been encountered during the verify operation ¹ | FSTAT[MGSTAT0] |

1. User margin read may be run using the Read 1s Section command to verify all bits are erased.

28.4.11.7.1 Suspending an Erase Flash Sector Operation

To suspend an Erase Flash Sector operation set the FCNFG[ERSSUSP] bit when CCIF, ACCERR, and FPVIOL are clear and the CCOB command field holds the code for the Erase Flash Sector command. During the Erase Flash Sector operation (see [Erase Flash Sector Command](#)), the flash memory module samples the state of the ERSSUSP bit at convenient points. If the flash memory module detects that the ERSSUSP bit is set, the Erase Flash Sector operation is suspended and the flash memory module sets CCIF. While ERSSUSP is set, all writes to flash registers are ignored except for writes to the FSTAT and FCNFG registers.

If an Erase Flash Sector operation effectively completes before the flash memory module detects that a suspend request has been made, the flash memory module clears the ERSSUSP bit prior to setting CCIF. When an Erase Flash Sector operation has been successfully suspended, the flash memory module sets CCIF and leaves the ERSSUSP bit set. While CCIF is set, the ERSSUSP bit can only be cleared to prevent the withdrawal of a suspend request before the flash memory module has acknowledged it.

28.4.11.7.2 Resuming a Suspended Erase Flash Sector Operation

If the ERSSUSP bit is still set when CCIF is cleared to launch the next command, the previous Erase Flash Sector operation resumes. The flash memory module acknowledges the request to resume a suspended operation by clearing the ERSSUSP bit. A new suspend request can then be made by setting ERSSUSP. A single Erase Flash Sector operation can be suspended and resumed multiple times.

Functional Description

There is a minimum elapsed time limit of 4.3 msec between the request to resume the Erase Flash Sector operation (CCIF is cleared) and the request to suspend the operation again (ERSSUSP is set). This minimum time period is required to ensure that the Erase Flash Sector operation will eventually complete. If the minimum period is continually violated, i.e. the suspend requests come repeatedly and too quickly, no forward progress is made by the Erase Flash Sector algorithm. The resume/suspend sequence runs indefinitely without completing the erase.

28.4.11.7.3 Aborting a Suspended Erase Flash Sector Operation

The user may choose to abort a suspended Erase Flash Sector operation by clearing the ERSSUSP bit prior to clearing CCIF for the next command launch. When a suspended operation is aborted, the flash memory module starts the new command using the new FCCOB contents.

Note

Aborting the erase leaves the bitcells in an indeterminate, partially-erased state. Data in this sector is not reliable until a new erase command fully completes.

The following figure shows how to suspend and resume the Erase Flash Sector operation.

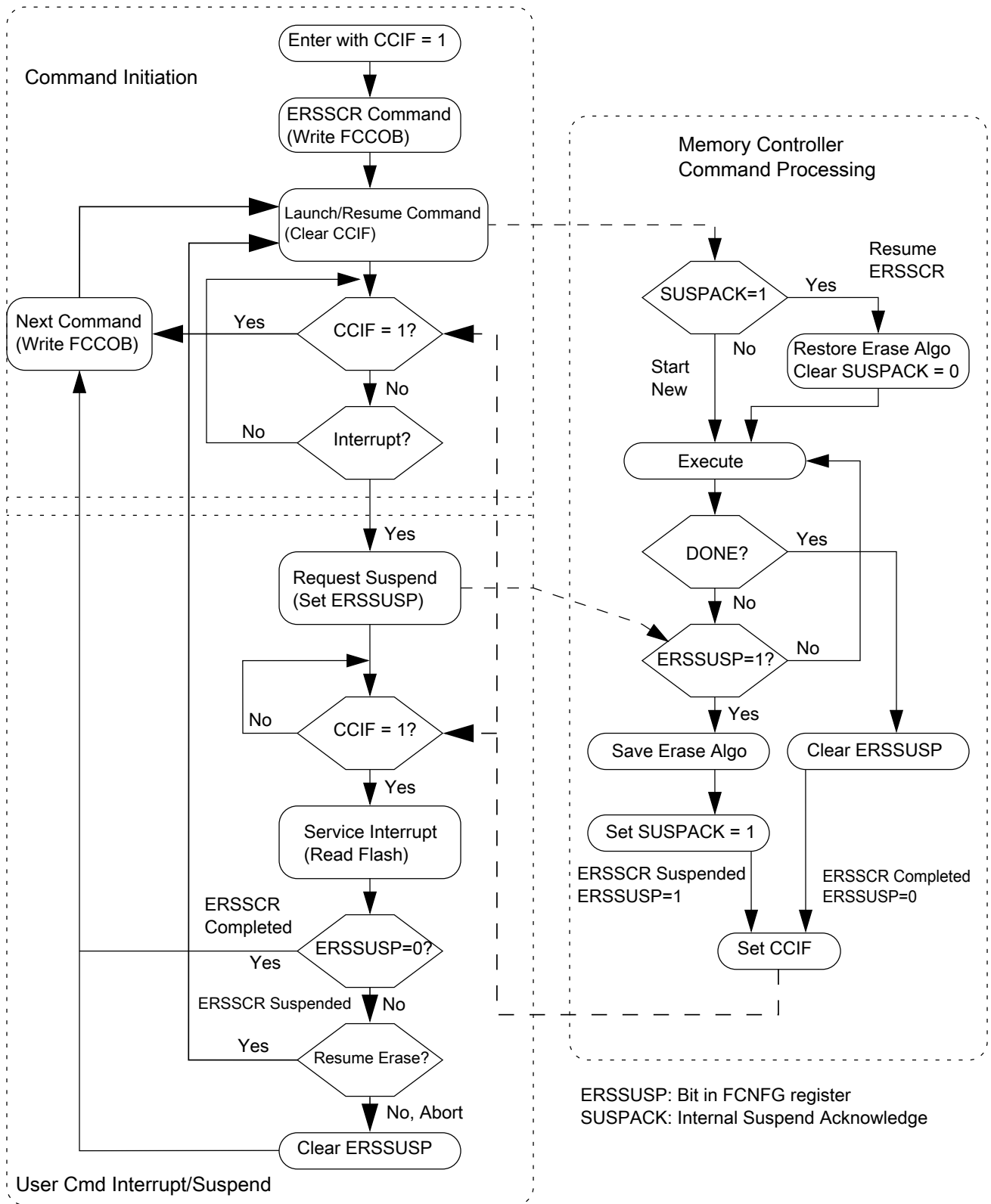

Figure 28-6. Suspend and Resume of Erase Flash Sector Operation

28.4.11.7.4 Impact of BLE radio activity on Erase Flash Sector Operation

The RSIM module provides an early indicator to the flash module that the BLE radio is going active and also indicates when the BLE radio goes inactive. If the BLE active indicator is asserted while the Erase Flash Sector operation is active, the operation will stall to reduce power consumption before the BLE radio goes active. The Erase Flash Sector operation will resume after the BLE active indicator negates. FSTAT[CCIF] remains clear during the stall to prevent disruption of the Erase Flash Sector operation while the block containing the sector being erased remains unavailable for read operations.

The following figure shows how the Erase Flash Sector operation stalls and resumes based on BLE radio activity.

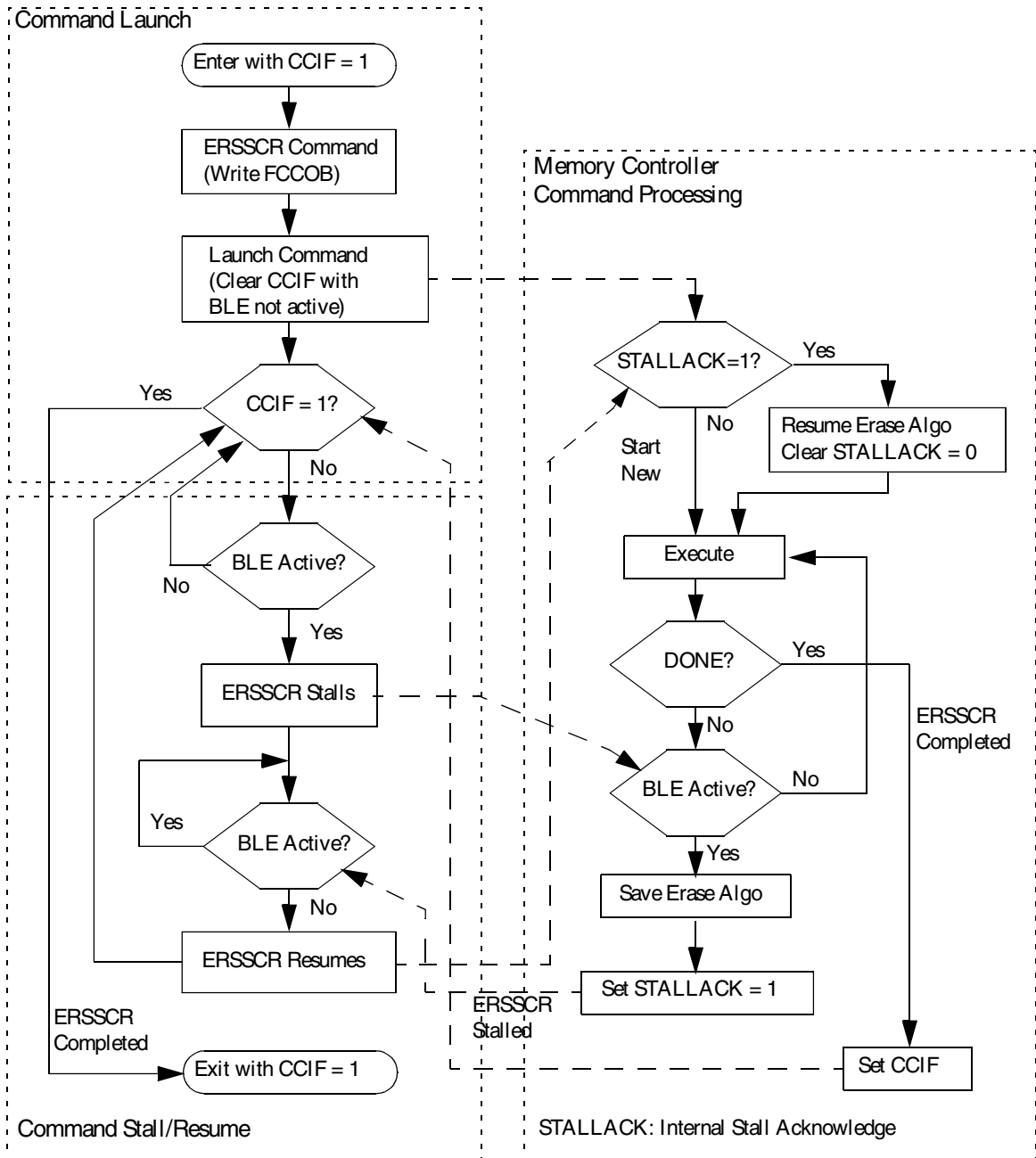

Figure 28-7. BLE Active Impact on Erase Flash Sector Operation

28.4.11.8 Read 1s All Blocks Command

The Read 1s All Blocks command checks if the program flash blocks have been erased to the specified read margin level, if applicable, and releases security if the readout passes, i.e. all data reads as '1'.

Table 28-22. Read 1s All Blocks Command FCCOB Requirements

| FCCOB Number | FCCOB Contents [7:0] |
|--------------|----------------------|
| 0 | 0x40 (RD1ALL) |
| 1 | Read-1 Margin Choice |

After clearing CCIF to launch the Read 1s All Blocks command, the flash memory module :

- sets the read margin for 1s according to [Table 28-23](#),
- checks the contents of the program flash are in the erased state.

If the flash memory module confirms that these memory resources are erased, access control is disabled and security is released by setting the FSEC[SEC] field to the unsecure state. The security byte in the flash configuration field (see [Flash Configuration Field Description](#)) remains unaffected by the Read 1s All Blocks command. If the read fails, i.e. all memory resources are not in the fully erased state, the FSTAT[MGSTAT0] bit is set.

The CCIF flag sets after the Read 1s All Blocks operation has completed.

Table 28-23. Margin Level Choices for Read 1s All Blocks

| Read Margin Choice | Margin Level Description |
|--------------------|---|
| 0x00 | Use the 'normal' read level for 1s |
| 0x01 | Apply the 'User' margin to the normal read-1 level |
| 0x02 | Apply the 'Factory' margin to the normal read-1 level |

Table 28-24. Read 1s All Blocks Command Error Handling

| Error Condition | Error Bit |
|--|----------------|
| Command not available in current mode/security | FSTAT[ACCERR] |
| An invalid margin choice is specified | FSTAT[ACCERR] |
| Read-1s fails | FSTAT[MGSTAT0] |

28.4.11.9 Read Once Command

The Read Once command provides read access to special 96-byte fields located in the program flash 0 IFR (see [Program Flash IFR Map](#) and [Program Once Field](#)). Access to the Program Once ID field is via 16 records (index values 0x00 - 0x0F), each 4 bytes

long. Access to the Program Once XACC and SACC fields are via 4 records (index values 0x10 - 0x13), each of which is 8 bytes long. These fields are programmed using the Program Once command described in [Program Once Command](#).

Table 28-25. Read Once Command FCCOB Requirements

| FCCOB Number | FCCOB Contents [7:0] |
|-----------------|---|
| 0 | 0x41 (RDONCE) |
| 1 | Program Once record index (0x00 - 0x13) |
| 2 | Not used |
| 3 | Not used |
| Returned Values | |
| 4 | Program Once byte 0 value |
| 5 | Program Once byte 1 value |
| 6 | Program Once byte 2 value |
| 7 | Program Once byte 3 value |
| 8 | Program Once byte 4 value (index 0x10 - 0x13) |
| 9 | Program Once byte 5 value (index 0x10 - 0x13) |
| 10 | Program Once byte 6 value (index 0x10 - 0x13) |
| 11 | Program Once byte 7 value (index 0x10 - 0x13) |

After clearing CCIF to launch the Read Once command, a 4-byte or 8-byte Program Once record is read and stored in the FCCOB register. The CCIF flag is set after the Read Once operation completes. Valid record index values for the Read Once command range from 0x00 - 0x13. During execution of the Read Once command, any attempt to read addresses within the program flash block containing the selected record index returns invalid data. The Read Once command can be executed any number of times.

Table 28-26. Read Once Command Error Handling

| Error Condition | Error Bit |
|--|---------------|
| Command not available in current mode/security | FSTAT[ACCERR] |
| An invalid record index is supplied | FSTAT[ACCERR] |

28.4.11.10 Program Once Command

The Program Once command enables programming to special 96-byte fields in the program flash 0 IFR (see [Program Flash IFR Map](#) and [Program Once Field](#)). Access to the Program Once ID field is via 16 records (index values 0x00 - 0x0F), each 4 bytes long. Access to the Program Once XACC and SACC fields are via 4 records (index values 0x10 - 0x13), each of which is 8 bytes long. These records can be read using the

Functional Description

Read Once command (see [Read Once Command](#)) or using the Read Resource command (see [Read Resource Command](#)). These records can be programmed only once since the program flash 0 IFR cannot be erased.

Table 28-27. Program Once Command FCCOB Requirements

| FCCOB Number | FCCOB Contents [7:0] |
|--------------|---|
| 0 | 0x43 (PGMONCE) |
| 1 | Program Once record index (0x00 - 0x13) |
| 2 | Not Used |
| 3 | Not Used |
| 4 | Program Once byte 0 value |
| 5 | Program Once byte 1 value |
| 6 | Program Once byte 2 value |
| 7 | Program Once byte 3 value |
| 8 | Program Once byte 4 value (index 0x10 - 0x13) |
| 9 | Program Once byte 5 value (index 0x10 - 0x13) |
| 10 | Program Once byte 6 value (index 0x10 - 0x13) |
| 11 | Program Once byte 7 value (index 0x10 - 0x13) |

After clearing CCIF to launch the Program Once command, the flash memory module first verifies that the selected record is erased. If erased, then the selected record is programmed using the values provided. The Program Once command also verifies that the programmed values read back correctly. The CCIF flag is set after the Program Once operation has completed.

Any attempt to program one of these records when the existing value is not Fs (erased) is not allowed. Valid record index values for the Program Once command range from 0x00 - 0x13. During execution of the Program Once command, any attempt to read addresses within the program flash block containing the selected record index returns invalid data.

Table 28-28. Program Once Command Error Handling

| Error Condition | Error Bit |
|---|----------------|
| Command not available in current mode/security | FSTAT[ACCERR] |
| An invalid record index is supplied | FSTAT[ACCERR] |
| The requested record has already been programmed to a non-FFFF value ¹ | FSTAT[ACCERR] |
| Any errors have been encountered during the verify operation | FSTAT[MGSTAT0] |

1. If a Program Once record is initially programmed to 0xFFFF_FFFF (0xFFFF_FFFF_FFFF_FFFF for index 0x10 - 0x13), the Program Once command is allowed to execute again on that same record.

28.4.11.11 Erase All Blocks Command

The Erase All Blocks operation erases all flash memory, verifies all memory contents, and releases MCU security.

Table 28-29. Erase All Blocks Command FCCOB Requirements

| FCCOB Number | FCCOB Contents [7:0] |
|--------------|----------------------|
| 0 | 0x44 (ERSALL) |

After clearing CCIF to launch the Erase All Blocks command, the flash memory module erases all program flash memory, then verifies that all are erased.

If the flash memory module verifies that all flash memories were properly erased, access control is disabled and security is released by setting the FSEC[SEC] field to the unsecure state. The Erase All Blocks command aborts if any flash region is protected. The security byte and all other contents of the flash configuration field (see [Flash Configuration Field Description](#)) are erased by the Erase All Blocks command. If the erase-verify fails, the FSTAT[MGSTAT0] bit is set. The CCIF flag is set after the Erase All Blocks operation completes.

Access control determined by the contents of the FXACC registers will not block execution of the Erase All Blocks command. While most Flash memory will be erased, the program flash IFR space containing the Program Once XACC and SACC fields will not be erased and, therefore, the contents of the Program Once XACC and SACC fields will not change. The contents of the FXACC and FSACC registers will not be impacted by the execution of the Erase All Blocks command. After completion of the Erase All Blocks command, access control is disabled until the next reset of the flash module or the Read 1s All Blocks command is executed and fails (FSTAT[MGSTAT0] is set).

CAUTION

The Erase All Blocks operation will not react to the early indicator for BLE radio activity. Therefore, the Erase All Blocks command must not be launched if there is a concern about inadequate power available to support both BLE radio activity and the Erase All Blocks operation.

Table 28-30. Erase All Blocks Command Error Handling

| Error Condition | Error Bit |
|---|----------------|
| Command not available in current mode/security | FSTAT[ACCERR] |
| Any region of the program flash memory is protected | FSTAT[FPVIOL] |
| Any errors have been encountered during the verify operation ¹ | FSTAT[MGSTAT0] |

1. User margin read may be run using the Read 1s All Blocks command to verify all bits are erased.

28.4.11.11.1 Triggering an Erase All External to the Flash Memory Module

The functionality of the Erase All Blocks/Erase All Blocks Unsecure command is also available in an uncommanded fashion outside of the flash memory. Refer to the device's Chip Configuration details for information on this functionality.

Before invoking the external erase all function, the FSTAT[ACCERR and PVIOL] flags must be cleared and the FCCOB0 register must not contain 0x44. When invoked, the erase-all function erases all program flash memory regardless of the protection settings. If the post-erase verify passes, access control determined by the contents of the FXACC registers is disabled and the routine then releases security by setting the FSEC[SEC] field register to the unsecure state. The security byte in the Flash Configuration Field is also programmed to the unsecure state. The status of the erase-all request is reflected in the FCNFG[ERSAREQ] bit. The FCNFG[ERSAREQ] bit is cleared once the operation completes and the normal FSTAT error reporting is available, except FPVIOL, as described in [Erase All Blocks Command/Erase All Blocks Unsecure Command](#).

CAUTION

The Erase All Blocks operation will not react to the early indicator for BLE radio activity. Therefore, the Erase All pin must not be asserted if there is a concern about inadequate power available to support both BLE radio activity and the Erase All Blocks operation.

28.4.11.12 Verify Backdoor Access Key Command

The Verify Backdoor Access Key command only executes if the mode and security conditions are satisfied (see [Flash Commands by Mode](#)). Execution of the Verify Backdoor Access Key command is further qualified by the FSEC[KEYEN] bits. The Verify Backdoor Access Key command releases security if user-supplied keys in the FCCOB match those stored in the Backdoor Comparison Key bytes of the Flash Configuration Field (see [Flash Configuration Field Description](#)). The column labelled Flash Configuration Field offset address shows the location of the matching byte in the Flash Configuration Field.

Table 28-31. Verify Backdoor Access Key Command FCCOB Requirements

| FCCOB Number | FCCOB Contents [7:0] | Flash Configuration Field Offset Address |
|--------------|----------------------|--|
| 0 | 0x45 (VFYKEY) | |
| 1-3 | Not Used | |
| 4 | Key Byte 0 | 0x0_0003 |

Table continues on the next page...

Table 28-31. Verify Backdoor Access Key Command FCCOB Requirements (continued)

| FCCOB Number | FCCOB Contents [7:0] | Flash Configuration Field Offset Address |
|--------------|----------------------|--|
| 5 | Key Byte 1 | 0x0_0002 |
| 6 | Key Byte 2 | 0x0_0001 |
| 7 | Key Byte 3 | 0x0_0000 |
| 8 | Key Byte 4 | 0x0_0007 |
| 9 | Key Byte 5 | 0x0_0006 |
| A | Key Byte 6 | 0x0_0005 |
| B | Key Byte 7 | 0x0_0004 |

After clearing CCIF to launch the Verify Backdoor Access Key command, the flash memory module checks the FSEC[KEYEN] bits to verify that this command is enabled. If not enabled, the flash memory module sets the FSTAT[ACCERR] bit and terminates. If the command is enabled, the flash memory module compares the key provided in FCCOB to the backdoor comparison key in the Flash Configuration Field. If the backdoor keys match, the FSEC[SEC] field is changed to the unsecure state and security is released. If the backdoor keys do not match, security is not released and all future attempts to execute the Verify Backdoor Access Key command are immediately aborted and the FSTAT[ACCERR] bit is (again) set to 1 until a reset of the flash memory module occurs. If the entire 8-byte key is all zeros or all ones, the Verify Backdoor Access Key command fails with an access error. The CCIF flag is set after the Verify Backdoor Access Key operation completes.

Table 28-32. Verify Backdoor Access Key Command Error Handling

| Error Condition | Error Bit |
|--|---------------|
| Command not available in current mode/security | FSTAT[ACCERR] |
| The supplied key is all-0s or all-Fs | FSTAT[ACCERR] |
| An incorrect backdoor key is supplied | FSTAT[ACCERR] |
| Backdoor key access has not been enabled (see the description of the FSEC register) | FSTAT[ACCERR] |
| This command is launched and the backdoor key has mismatched since the last power down reset | FSTAT[ACCERR] |

28.4.11.13 Erase All Blocks Unsecure Command

The Erase All Blocks Unsecure operation erases all flash memory, verifies all memory contents, programs the security byte in the Flash Configuration Field to the unsecure state, and releases MCU security.

Table 28-33. Erase All Blocks Unsecure Command FCCOB Requirements

| FCCOB Number | FCCOB Contents [7:0] |
|--------------|----------------------|
| 0 | 0x49 (ERSALLU) |

After clearing CCIF to launch the Erase All Blocks Unsecure command, the flash memory module erases all program flash memory, then verifies that all are erased.

If the flash memory module verifies that all program flash memory was properly erased, access control is disabled, security is released by setting the FSEC[SEC] field to the unsecure state, and the security byte (see [Flash Configuration Field Description](#)) is programmed to the unsecure state by the Erase All Blocks Unsecure command. If the erase or program verify fails, the FSTAT[MGSTAT0] bit is set. The CCIF flag is set after the Erase All Blocks Unsecure operation completes.

Access control determined by the contents of the FXACC registers will not block execution of the Erase All Blocks Unsecure command. While most Flash memory will be erased, the program flash IFR space containing the Program Once XACC and SACC fields will not be erased and, therefore, the contents of the Program Once XACC and SACC fields will not change. The contents of the FXACC and FSACC registers will not be impacted by the execution of the Erase All Blocks Unsecure command. After completion of the Erase All Blocks Unsecure command, access control is disabled until the next reset of the flash module or the Read 1s All Blocks command is executed and fails (FSTAT[MGSTAT0] is set).

CAUTION

The Erase All Blocks Unsecure operation will not react to the early indicator for BLE radio activity. Therefore, the Erase All Blocks Unsecure command must not be launched if there is a concern about inadequate power available to support both BLE radio activity and the Erase All Blocks Unsecure operation.

Table 28-34. Erase All Blocks Unsecure Command Error Handling

| Error Condition | Error Bit |
|--|----------------|
| Command not available in current mode/security | FSTAT[ACCERR] |
| Any errors have been encountered during erase or program verify operations | FSTAT[MGSTAT0] |

28.4.11.14 Read 1s All Execute-only Segments Command

The Read 1s All Execute-only Segments command checks if the program flash execute-only segments defined by the FXACC registers have been erased to the specified read margin level, if applicable, and releases flash access control if the readout passes, i.e. all data reads as '1'.

Table 28-35. Read 1s All Execute-only Segments Command FCCOB Requirements

| FCCOB Number | FCCOB Contents [7:0] |
|--------------|----------------------|
| 0 | 0x4A (RD1XA) |
| 1 | Read-1 Margin Choice |

After clearing CCIF to launch the Read 1s All Execute-only Segments command, the flash memory module :

- sets the read margin for 1s according to [Table 28-36](#),
- checks the contents of the program flash execute-only segments are in the erased state.

If the flash memory module confirms that these segments are erased, flash access control is disabled until the next reset or, after programming any of the execute-only segments, the Read 1s All Execute-only Segments command is executed and fails with the FSTAT[MGSTAT0] bit set. If the read fails, i.e. all segments are not in the fully erased state, the FSTAT[MGSTAT0] bit is set.

The CCIF flag sets after the Read 1s All Execute-only Segments operation has completed.

Table 28-36. Margin Level Choices for Read 1s All Execute-only Segments

| Read Margin Choice | Margin Level Description |
|--------------------|---|
| 0x00 | Use the 'normal' read level for 1s |
| 0x01 | Apply the 'User' margin to the normal read-1 level |
| 0x02 | Apply the 'Factory' margin to the normal read-1 level |

Table 28-37. Read 1s All Execute-only Segments Command Error Handling

| Error Condition | Error Bit |
|--|----------------|
| Command not available in current mode/security | FSTAT[ACCERR] |
| An invalid margin choice is specified | FSTAT[ACCERR] |
| Sector size is larger than segment size | FSTAT[ACCERR] |
| Read-1s fails | FSTAT[MGSTAT0] |

28.4.11.15 Erase All Execute-only Segments Command

The Erase All Execute-only Segments operation erases all program flash execute-only segments defined by the FXACC registers, verifies all segments are erased, and releases flash access control.

Table 28-38. Erase All Execute-only Segments Command FCCOB Requirements

| FCCOB Number | FCCOB Contents [7:0] |
|--------------|----------------------|
| 0 | 0x4B (ERSXA) |

After clearing CCIF to launch the Erase All Execute-only Segments command, the flash memory module erases all program flash execute-only segments, then verifies that all segments are erased.

If the flash memory module verifies that all segments were properly erased, flash access control is disabled until the next reset or, after programming any of the execute-only segments, the Read 1s All Execute-only Segments command is executed and fails with the FSTAT[MGSTAT0] bit set. The Erase All Execute-only Segments command aborts if any XA controlled segment is protected. If the erase-verify fails, the FSTAT[MGSTAT0] bit is set. The CCIF flag is set after the Erase All Execute-only Segments operation completes.

Access control determined by the contents of the FXACC registers will not block execution of the Erase All Execute-only Segments command. While all XA controlled segments will be erased, the program flash IFR space containing the Program Once XACC fields will not be erased and, therefore, the contents of the Program Once XACC fields will not change. The contents of the FXACC registers will not be impacted by the execution of the Erase All Execute-only Segments command.

Table 28-39. Erase All Execute-only Segments Command Error Handling

| Error Condition | Error Bit |
|--|----------------|
| Command not available in current mode/security | FSTAT[ACCERR] |
| Sector size is larger than segment size | FSTAT[ACCERR] |
| Any XA controlled segment in the program flash memory is protected | FSTAT[FPVIOL] |
| Any errors have been encountered during the verify operation | FSTAT[MGSTAT0] |

28.4.12 Security

The flash memory module provides security information to the MCU based on contents of the FSEC security register.

The MCU then limits access to flash memory resources as defined in the device's Chip Configuration details. During reset, the flash memory module initializes the FSEC register using data read from the security byte of the Flash Configuration Field (see [Flash Configuration Field Description](#)).

The following fields are available in the FSEC register. The settings are described in the [Flash Security Register \(FTFA_FSEC\)](#) details.

Flash security features are discussed further in [AN4507: Using the Kinetis Security and Flash Protection Features](#). Note that not all features described in the application note are available on this device.

Table 28-40. FSEC register fields

| FSEC field | Description |
|------------|-------------------------------|
| KEYEN | Backdoor Key Access |
| MEEN | Mass Erase Capability |
| FSLACC | Factory Security Level Access |
| SEC | MCU security |

28.4.12.1 Flash Memory Access by Mode and Security

The following table summarizes how access to the flash memory module is affected by security and operating mode.

Table 28-41. Flash Memory Access Summary

| Operating Mode | Chip Security State | |
|----------------|---------------------|---|
| | Unsecure | Secure |
| NVM Normal | Full command set | |
| NVM Special | Full command set | Only the Erase All Blocks, Erase All Blocks Unsecure and Read 1s All Blocks commands. |

28.4.12.2 Changing the Security State

The security state out of reset can be permanently changed by programming the security byte of the flash configuration field. This assumes that you are starting from a mode where the necessary program flash erase and program commands are available and that the region of the program flash containing the flash configuration field is unprotected. If the flash security byte is successfully programmed, its new value takes affect after the next chip reset.

28.4.12.2.1 Unsecuring the Chip Using Backdoor Key Access

The chip can be unsecured by using the backdoor key access feature, which requires knowledge of the contents of the 8-byte backdoor key value stored in the Flash Configuration Field (see [Flash Configuration Field Description](#)). If the FSEC[KEYEN] bits are in the enabled state, the Verify Backdoor Access Key command (see [Verify Backdoor Access Key Command](#)) can be run; it allows the user to present prospective keys for comparison to the stored keys. If the keys match, the FSEC[SEC] bits are changed to unsecure the chip. The entire 8-byte key cannot be all 0s or all 1s; that is, 0000_0000_0000_0000h and FFFF_FFFF_FFFF_FFFFh are not accepted by the Verify Backdoor Access Key command as valid comparison values. While the Verify Backdoor Access Key command is active, program flash memory is not available for read access and returns invalid data.

The user code stored in the program flash memory must have a method of receiving the backdoor keys from an external stimulus. This external stimulus would typically be through one of the on-chip serial ports.

If the KEYEN bits are in the enabled state, the chip can be unsecured by the following backdoor key access sequence:

1. Follow the command sequence for the Verify Backdoor Access Key command as explained in [Verify Backdoor Access Key Command](#)
2. If the Verify Backdoor Access Key command is successful, the chip is unsecured and the FSEC[SEC] bits are forced to the unsecure state

An illegal key provided to the Verify Backdoor Access Key command prohibits further use of the Verify Backdoor Access Key command. A reset of the chip is the only method to re-enable the Verify Backdoor Access Key command when a comparison fails.

After the backdoor keys have been correctly matched, the chip is unsecured by changing the FSEC[SEC] bits. A successful execution of the Verify Backdoor Access Key command changes the security in the FSEC register only. It does not alter the security byte or the keys stored in the Flash Configuration Field ([Flash Configuration Field Description](#)). After the next reset of the chip, the security state of the flash memory

module reverts back to the flash security byte in the Flash Configuration Field. The Verify Backdoor Access Key command sequence has no effect on the program and erase protections defined in the program flash protection registers.

If the backdoor keys successfully match, the unsecured chip has full control of the contents of the Flash Configuration Field. The chip may erase the sector containing the Flash Configuration Field and reprogram the flash security byte to the unsecure state and change the backdoor keys to any desired value.

28.4.13 Reset Sequence

On each system reset the flash memory module executes a sequence which establishes initial values for the flash block configuration parameters, FPROT, FOPT, FSEC, FXACC, FSACC, and FACNFG registers.

FSTAT[CCIF] is cleared throughout the reset sequence. The flash memory module holds off CPU access during the reset sequence. Flash reads are possible when the hold is removed. Completion of the reset sequence is marked by setting CCIF which enables flash user commands.

If a reset occurs while any flash command is in progress, that command is immediately aborted. The state of the word being programmed or the sector/block being erased is not guaranteed. Commands and operations do not automatically resume after exiting reset.

Chapter 29

Analog-to-digital converter (ADC)

The 16-bit analog-to-digital converter (ADC) is a linear successive approximation ADC designed for operation within an integrated microcontroller system-on-chip.

29.1 Introduction

The 16-bit analog-to-digital converter (ADC) is a successive approximation ADC designed for operation within an integrated microcontroller system-on-chip.

NOTE

For the chip specific modes of operation, see the power management information of the device.

29.1.1 Features

Following are the features of the ADC module.

- Linear successive approximation algorithm with up to 16-bit resolution
- Up to four pairs of differential and 24 single-ended external analog inputs
- Output modes:
 - differential 16-bit, 13-bit, 11-bit, and 9-bit modes
 - single-ended 16-bit, 12-bit, 10-bit, and 8-bit modes
- Output format in 2's complement 16-bit sign extended for differential modes
- Output in right-justified unsigned format for single-ended
- Single or continuous conversion, that is, automatic return to idle after single conversion

- Configurable sample time and conversion speed/power
- Conversion complete/hardware average complete flag and interrupt
- Input clock selectable from up to four sources
- Operation in low-power modes for lower noise
- Asynchronous clock source for lower noise operation with option to output the clock
- Selectable hardware conversion trigger with hardware channel select
- Automatic compare with interrupt for less-than, greater-than or equal-to, within range, or out-of-range, programmable value
- Temperature sensor
- Hardware average function
- Selectable voltage reference: external or alternate
- Self-Calibration mode

29.1.2 Block diagram

The following figure is the ADC module block diagram.

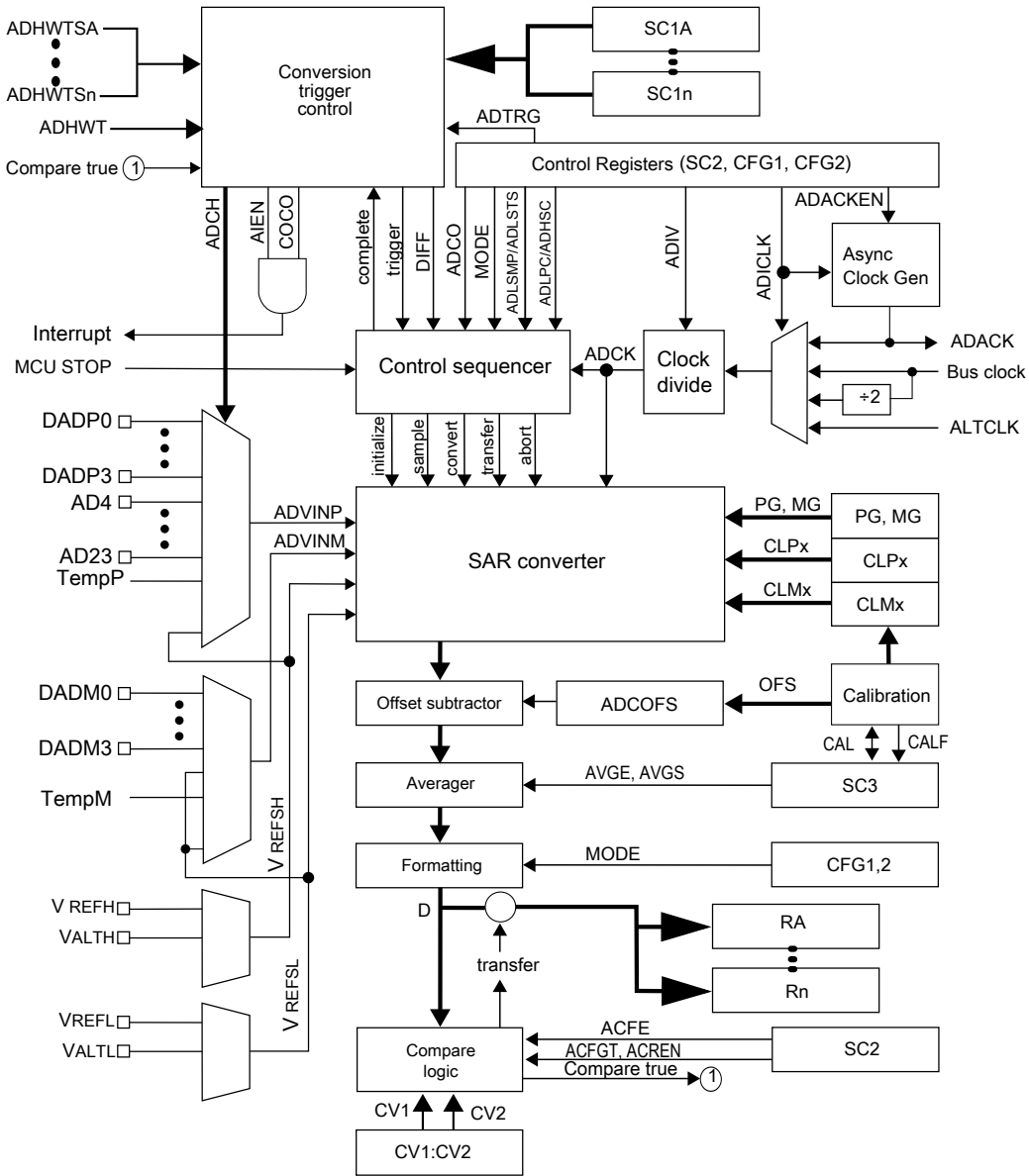

Figure 29-1. ADC block diagram

29.2 ADC signal descriptions

The ADC module supports up to 4 pairs of differential inputs and up to 24 single-ended inputs.

Each differential pair requires two inputs, DADPx and DADMx. The ADC also requires four supply/reference/ground connections.

NOTE

For the number of channels supported on this device as well as information regarding other chip-specific inputs into the ADC block, see the chip-specific ADC configuration information.

Table 29-1. ADC signal descriptions

| Signal | Description | I/O |
|--------------------|------------------------------------|-----|
| DADP3–DADP0 | Differential Analog Channel Inputs | I |
| DADM3–DADM0 | Differential Analog Channel Inputs | I |
| AD n | Single-Ended Analog Channel Inputs | I |
| V _{REFSH} | Voltage Reference Select High | I |
| V _{REFSL} | Voltage Reference Select Low | I |
| V _{DDA} | Analog Power Supply | I |
| V _{SSA} | Analog Ground | I |

29.2.1 Analog Power (V_{DDA})

The ADC analog portion uses V_{DDA} as its power connection. In some packages, V_{DDA} is connected internally to V_{DD}. If externally available, connect the V_{DDA} pin to the same voltage potential as V_{DD}. External filtering may be necessary to ensure clean V_{DDA} for good results.

29.2.2 Analog Ground (V_{SSA})

The ADC analog portion uses V_{SSA} as its ground connection. In some packages, V_{SSA} is connected internally to V_{SS}. If externally available, connect the V_{SSA} pin to the same voltage potential as V_{SS}.

29.2.3 Voltage Reference Select

V_{REFSH} and V_{REFSL} are the high and low reference voltages for the ADC module.

The ADC can be configured to accept one of two voltage reference pairs for V_{REFSH} and V_{REFSL}. Each pair contains a positive reference that must be between the minimum Ref Voltage High and V_{DDA}, and a ground reference that must be at the same potential as V_{SSA}. The two pairs are external (V_{REFH} and V_{REFL}) and alternate (V_{ALTH} and V_{ALTL}). These voltage references are selected using SC2[REFSEL]. The alternate V_{ALTH} and

V_{ALTL} voltage reference pair may select additional external pins or internal sources depending on MCU configuration. See the chip configuration information on the Voltage References specific to this MCU.

In some packages, V_{REFH} is connected in the package to V_{DDA} and V_{REFL} to V_{SSA} . If externally available, the positive reference(s) may be connected to the same potential as V_{DDA} or may be driven by an external source to a level between the minimum Ref Voltage High and the V_{DDA} potential. V_{REFH} must never exceed V_{DDA} . Connect the ground references to the same voltage potential as V_{SSA} .

29.2.4 Analog Channel Inputs (ADx)

The ADC module supports up to 24 single-ended analog inputs. A single-ended input is selected for conversion through the $SC1[ADCH]$ channel select bits when $SC1n[DIFF]$ is low.

29.2.5 Differential Analog Channel Inputs (DADx)

The ADC module supports up to four differential analog channel inputs. Each differential analog input is a pair of external pins, $DADPx$ and $DADMx$, referenced to each other to provide the most accurate analog to digital readings. A differential input is selected for conversion through $SC1[ADCH]$ when $SC1n[DIFF]$ is high. All $DADPx$ inputs may be used as single-ended inputs if $SC1n[DIFF]$ is low. In certain MCU configurations, some $DADMx$ inputs may also be used as single-ended inputs if $SC1n[DIFF]$ is low. For ADC connections specific to this device, see the chip-specific ADC information.

29.3 Memory map and register definitions

This section describes the ADC registers.

ADC memory map

| Absolute address (hex) | Register name | Width (in bits) | Access | Reset value | Section/page |
|------------------------|--|-----------------|--------|-------------|----------------------------|
| 4003_B000 | ADC Status and Control Registers 1 (ADC0_SC1A) | 32 | R/W | 0000_001Fh | 29.3.1/626 |
| 4003_B004 | ADC Status and Control Registers 1 (ADC0_SC1B) | 32 | R/W | 0000_001Fh | 29.3.1/626 |
| 4003_B008 | ADC Configuration Register 1 (ADC0_CFG1) | 32 | R/W | 0000_0000h | 29.3.2/630 |
| 4003_B00C | ADC Configuration Register 2 (ADC0_CFG2) | 32 | R/W | 0000_0000h | 29.3.3/631 |
| 4003_B010 | ADC Data Result Register (ADC0_RA) | 32 | R | 0000_0000h | 29.3.4/632 |

Table continues on the next page...

ADC memory map (continued)

| Absolute address (hex) | Register name | Width (in bits) | Access | Reset value | Section/page |
|------------------------|---|-----------------|--------|-------------|-----------------------------|
| 4003_B014 | ADC Data Result Register (ADC0_RB) | 32 | R | 0000_0000h | 29.3.4/632 |
| 4003_B018 | Compare Value Registers (ADC0_CV1) | 32 | R/W | 0000_0000h | 29.3.5/634 |
| 4003_B01C | Compare Value Registers (ADC0_CV2) | 32 | R/W | 0000_0000h | 29.3.5/634 |
| 4003_B020 | Status and Control Register 2 (ADC0_SC2) | 32 | R/W | 0000_0000h | 29.3.6/635 |
| 4003_B024 | Status and Control Register 3 (ADC0_SC3) | 32 | R/W | 0000_0000h | 29.3.7/637 |
| 4003_B028 | ADC Offset Correction Register (ADC0_OFS) | 32 | R/W | 0000_0004h | 29.3.8/638 |
| 4003_B02C | ADC Plus-Side Gain Register (ADC0_PG) | 32 | R/W | 0000_8200h | 29.3.9/639 |
| 4003_B030 | ADC Minus-Side Gain Register (ADC0_MG) | 32 | R/W | 0000_8200h | 29.3.10/639 |
| 4003_B034 | ADC Plus-Side General Calibration Value Register (ADC0_CLPD) | 32 | R/W | 0000_000Ah | 29.3.11/640 |
| 4003_B038 | ADC Plus-Side General Calibration Value Register (ADC0_CLPS) | 32 | R/W | 0000_0020h | 29.3.12/641 |
| 4003_B03C | ADC Plus-Side General Calibration Value Register (ADC0_CLP4) | 32 | R/W | 0000_0200h | 29.3.13/641 |
| 4003_B040 | ADC Plus-Side General Calibration Value Register (ADC0_CLP3) | 32 | R/W | 0000_0100h | 29.3.14/642 |
| 4003_B044 | ADC Plus-Side General Calibration Value Register (ADC0_CLP2) | 32 | R/W | 0000_0080h | 29.3.15/642 |
| 4003_B048 | ADC Plus-Side General Calibration Value Register (ADC0_CLP1) | 32 | R/W | 0000_0040h | 29.3.16/643 |
| 4003_B04C | ADC Plus-Side General Calibration Value Register (ADC0_CLP0) | 32 | R/W | 0000_0020h | 29.3.17/643 |
| 4003_B054 | ADC Minus-Side General Calibration Value Register (ADC0_CLMD) | 32 | R/W | 0000_000Ah | 29.3.18/644 |
| 4003_B058 | ADC Minus-Side General Calibration Value Register (ADC0_CLMS) | 32 | R/W | 0000_0020h | 29.3.19/644 |
| 4003_B05C | ADC Minus-Side General Calibration Value Register (ADC0_CLM4) | 32 | R/W | 0000_0200h | 29.3.20/645 |
| 4003_B060 | ADC Minus-Side General Calibration Value Register (ADC0_CLM3) | 32 | R/W | 0000_0100h | 29.3.21/645 |
| 4003_B064 | ADC Minus-Side General Calibration Value Register (ADC0_CLM2) | 32 | R/W | 0000_0080h | 29.3.22/646 |
| 4003_B068 | ADC Minus-Side General Calibration Value Register (ADC0_CLM1) | 32 | R/W | 0000_0040h | 29.3.23/646 |
| 4003_B06C | ADC Minus-Side General Calibration Value Register (ADC0_CLM0) | 32 | R/W | 0000_0020h | 29.3.24/647 |

29.3.1 ADC Status and Control Registers 1 (ADCx_SC1n)

SC1A is used for both software and hardware trigger modes of operation.

To allow sequential conversions of the ADC to be triggered by internal peripherals, the ADC can have more than one status and control register: one for each conversion. The SC1B–SC1n registers indicate potentially multiple SC1 registers for use only in hardware trigger mode. See the chip configuration information about the number of SC1n registers specific to this device. The SC1n registers have identical fields, and are used in a "ping-pong" approach to control ADC operation.

At any one point in time, only one of the SC1n registers is actively controlling ADC conversions. Updating SC1A while SC1n is actively controlling a conversion is allowed, and vice-versa for any of the SC1n registers specific to this MCU.

Writing SC1A while SC1A is actively controlling a conversion aborts the current conversion. In Software Trigger mode, when SC2[ADTRG]=0, writes to SC1A subsequently initiate a new conversion, if SC1[ADCH] contains a value other than all 1s (module disabled).

Writing any of the SC1n registers while that specific SC1n register is actively controlling a conversion aborts the current conversion. None of the SC1B–SC1n registers are used for software trigger operation and therefore writes to the SC1B–SC1n registers do not initiate a new conversion.

Address: 4003_B000h base + 0h offset + (4d × i), where i=0d to 1d

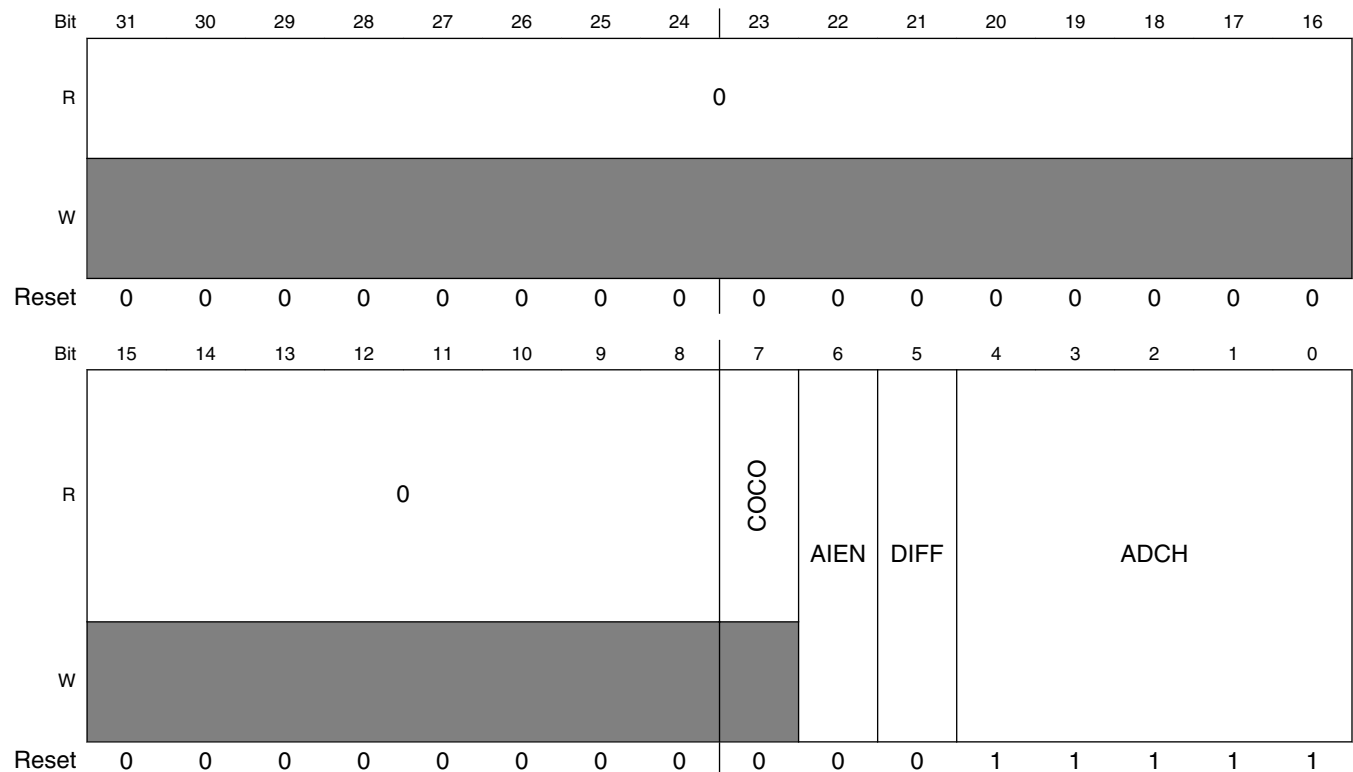

ADCx_SC1n field descriptions

| Field | Description |
|------------------|---|
| 31–8 Reserved | This field is reserved. This read-only field is reserved and always has the value 0. |
| 7 COCO | <p>Conversion Complete Flag</p> <p>This is a read-only field that is set each time a conversion is completed when the compare function is disabled, or SC2[ACFE]=0 and the hardware average function is disabled, or SC3[AVGE]=0. When the compare function is enabled, or SC2[ACFE]=1, COCO is set upon completion of a conversion only if the compare result is true. When the hardware average function is enabled, or SC3[AVGE]=1, COCO is set upon completion of the selected number of conversions (determined by AVGS). COCO in SC1A is also set at the completion of a calibration sequence. COCO is cleared when the respective SC1n register is written or when the respective Rn register is read.</p> <p>0 Conversion is not completed. 1 Conversion is completed.</p> |
| 6 AIEN | <p>Interrupt Enable</p> <p>Enables conversion complete interrupts. When COCO becomes set while the respective AIEN is high, an interrupt is asserted.</p> <p>0 Conversion complete interrupt is disabled. 1 Conversion complete interrupt is enabled.</p> |
| 5 DIFF | <p>Differential Mode Enable</p> <p>Configures the ADC to operate in differential mode. When enabled, this mode automatically selects from the differential channels, and changes the conversion algorithm and the number of cycles to complete a conversion.</p> <p>0 Single-ended conversions and input channels are selected. 1 Differential conversions and input channels are selected.</p> |
| ADCH | <p>Input channel select</p> <p>Selects one of the input channels. The input channel decode depends on the value of DIFF. DAD0-DAD3 are associated with the input pin pairs DADPx and DADMx.</p> <p>NOTE: Some of the input channel options in the bitfield-setting descriptions might not be available for your device. For the actual ADC channel assignments for your device, see the Chip Configuration details.</p> <p>The successive approximation converter subsystem is turned off when the channel select bits are all set, that is, ADCH = 11111. This feature allows explicit disabling of the ADC and isolation of the input channel from all sources. Terminating continuous conversions this way prevents an additional single conversion from being performed. It is not necessary to set ADCH to all 1s to place the ADC in a low-power state when continuous conversions are not enabled because the module automatically enters a low-power state when a conversion completes.</p> <p>00000 When DIFF=0, DADP0 is selected as input; when DIFF=1, DAD0 is selected as input. 00001 When DIFF=0, DADP1 is selected as input; when DIFF=1, DAD1 is selected as input. 00010 When DIFF=0, DADP2 is selected as input; when DIFF=1, DAD2 is selected as input. 00011 When DIFF=0, DADP3 is selected as input; when DIFF=1, DAD3 is selected as input. 00100 When DIFF=0, AD4 is selected as input; when DIFF=1, it is reserved. 00101 When DIFF=0, AD5 is selected as input; when DIFF=1, it is reserved. 00110 When DIFF=0, AD6 is selected as input; when DIFF=1, it is reserved. 00111 When DIFF=0, AD7 is selected as input; when DIFF=1, it is reserved.</p> |

Table continues on the next page...

ADCx_SC1n field descriptions (continued)

| Field | Description |
|-------|--|
| 01000 | When DIFF=0, AD8 is selected as input; when DIFF=1, it is reserved. |
| 01001 | When DIFF=0, AD9 is selected as input; when DIFF=1, it is reserved. |
| 01010 | When DIFF=0, AD10 is selected as input; when DIFF=1, it is reserved. |
| 01011 | When DIFF=0, AD11 is selected as input; when DIFF=1, it is reserved. |
| 01100 | When DIFF=0, AD12 is selected as input; when DIFF=1, it is reserved. |
| 01101 | When DIFF=0, AD13 is selected as input; when DIFF=1, it is reserved. |
| 01110 | When DIFF=0, AD14 is selected as input; when DIFF=1, it is reserved. |
| 01111 | When DIFF=0, AD15 is selected as input; when DIFF=1, it is reserved. |
| 10000 | When DIFF=0, AD16 is selected as input; when DIFF=1, it is reserved. |
| 10001 | When DIFF=0, AD17 is selected as input; when DIFF=1, it is reserved. |
| 10010 | When DIFF=0, AD18 is selected as input; when DIFF=1, it is reserved. |
| 10011 | When DIFF=0, AD19 is selected as input; when DIFF=1, it is reserved. |
| 10100 | When DIFF=0, AD20 is selected as input; when DIFF=1, it is reserved. |
| 10101 | When DIFF=0, AD21 is selected as input; when DIFF=1, it is reserved. |
| 10110 | When DIFF=0, AD22 is selected as input; when DIFF=1, it is reserved. |
| 10111 | When DIFF=0, AD23 is selected as input; when DIFF=1, it is reserved. |
| 11000 | Reserved. |
| 11001 | Reserved. |
| 11010 | When DIFF=0, Temp Sensor (single-ended) is selected as input; when DIFF=1, Temp Sensor (differential) is selected as input. |
| 11011 | When DIFF=0, Bandgap (single-ended) is selected as input; when DIFF=1, Bandgap (differential) is selected as input. |
| 11100 | Reserved. |
| 11101 | When DIFF=0, V_{REFSH} is selected as input; when DIFF=1, $-V_{REFSH}$ (differential) is selected as input. Voltage reference selected is determined by SC2[REFSEL]. |
| 11110 | When DIFF=0, V_{REFSL} is selected as input; when DIFF=1, it is reserved. Voltage reference selected is determined by SC2[REFSEL]. |
| 11111 | Module is disabled. |

29.3.2 ADC Configuration Register 1 (ADCx_CFG1)

The configuration Register 1 (CFG1) selects the mode of operation, clock source, clock divide, and configuration for low power or long sample time.

Address: 4003_B000h base + 8h offset = 4003_B008h

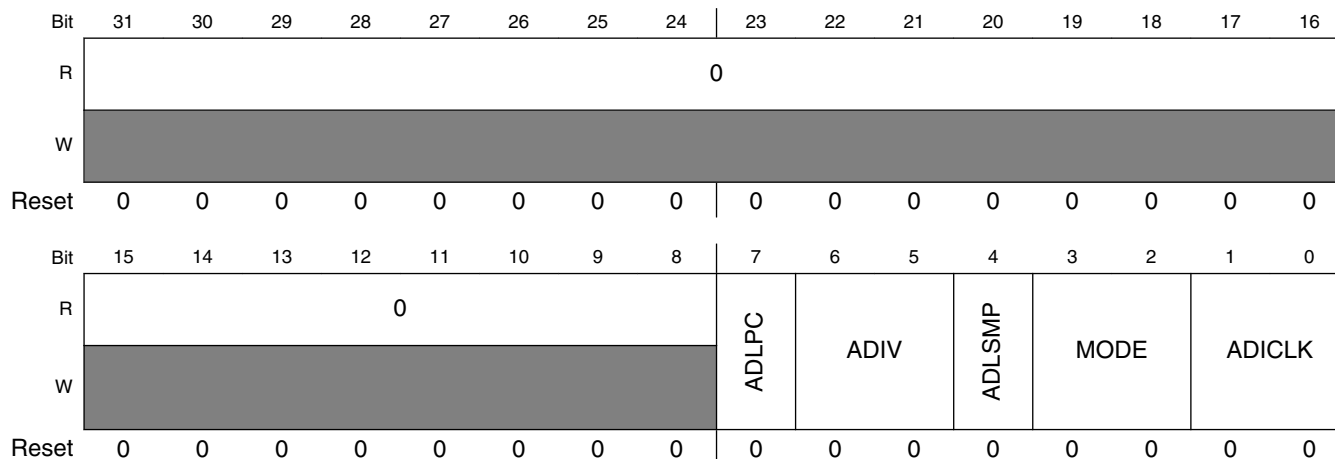

ADCx_CFG1 field descriptions

| Field | Description |
|------------------|--|
| 31–8 Reserved | This field is reserved. This read-only field is reserved and always has the value 0. |
| 7 ADLPC | Low-Power Configuration Controls the power configuration of the successive approximation converter. This optimizes power consumption when higher sample rates are not required. 0 Normal power configuration. 1 Low-power configuration. The power is reduced at the expense of maximum clock speed. |
| 6–5 ADIV | Clock Divide Select Selects the divide ratio used by the ADC to generate the internal clock ADCK. 00 The divide ratio is 1 and the clock rate is input clock. 01 The divide ratio is 2 and the clock rate is (input clock)/2. 10 The divide ratio is 4 and the clock rate is (input clock)/4. 11 The divide ratio is 8 and the clock rate is (input clock)/8. |
| 4 ADLSMP | Sample Time Configuration Selects between different sample times based on the conversion mode selected. This field adjusts the sample period to allow higher impedance inputs to be accurately sampled or to maximize conversion speed for lower impedance inputs. Longer sample times can also be used to lower overall power consumption if continuous conversions are enabled and high conversion rates are not required. When ADLSMP=1, the long sample time select bits, (ADLSTS[1:0]), can select the extent of the long sample time. |

Table continues on the next page...

ADCx_CFG1 field descriptions (continued)

| Field | Description |
|-------------|--|
| | 0 Short sample time. 1 Long sample time. |
| 3–2 MODE | Conversion mode selection Selects the ADC resolution mode. 00 When DIFF=0:It is single-ended 8-bit conversion; when DIFF=1, it is differential 9-bit conversion with 2's complement output. 01 When DIFF=0:It is single-ended 12-bit conversion ; when DIFF=1, it is differential 13-bit conversion with 2's complement output. 10 When DIFF=0:It is single-ended 10-bit conversion. ; when DIFF=1, it is differential 11-bit conversion with 2's complement output 11 When DIFF=0:It is single-ended 16-bit conversion..; when DIFF=1, it is differential 16-bit conversion with 2's complement output |
| ADICLK | Input Clock Select Selects the input clock source to generate the internal clock, ADCK. Note that when the ADACK clock source is selected, it is not required to be active prior to conversion start. When it is selected and it is not active prior to a conversion start, when CFG2[ADACKEN]=0, the asynchronous clock is activated at the start of a conversion and deactivated when conversions are terminated. In this case, there is an associated clock startup delay each time the clock source is re-activated. 00 Bus clock 01 Bus clock divided by 2(BUSCLK/2) 10 Alternate clock (ALTCLK) 11 Asynchronous clock (ADACK) |

29.3.3 ADC Configuration Register 2 (ADCx_CFG2)

Configuration Register 2 (CFG2) selects the special high-speed configuration for very high speed conversions and selects the long sample time duration during long sample mode.

Address: 4003_B000h base + Ch offset = 4003_B00Ch

| | | | | | | | | | | | | | | | | |
|-------|----|----|----|----|----|----|----|----|----|----|----|----|--------|---------|-------|--------|
| Bit | 31 | 30 | 29 | 28 | 27 | 26 | 25 | 24 | 23 | 22 | 21 | 20 | 19 | 18 | 17 | 16 |
| R | 0 | | | | | | | | | | | | | | | |
| W | | | | | | | | | | | | | | | | |
| Reset | 0 | 0 | 0 | 0 | 0 | 0 | 0 | 0 | 0 | 0 | 0 | 0 | 0 | 0 | 0 | 0 |
| Bit | 15 | 14 | 13 | 12 | 11 | 10 | 9 | 8 | 7 | 6 | 5 | 4 | 3 | 2 | 1 | 0 |
| R | 0 | | | | | | | | 0 | | | | MUXSEL | ADACKEN | ADHSC | ADLSTS |
| W | | | | | | | | | | | | | | | | |
| Reset | 0 | 0 | 0 | 0 | 0 | 0 | 0 | 0 | 0 | 0 | 0 | 0 | 0 | 0 | 0 | 0 |

ADCx_CFG2 field descriptions

| Field | Description |
|------------------|---|
| 31–8 Reserved | This field is reserved. This read-only field is reserved and always has the value 0. |
| 7–5 Reserved | This field is reserved. This read-only field is reserved and always has the value 0. |
| 4 MUXSEL | ADC Mux Select Changes the ADC mux setting to select between alternate sets of ADC channels. 0 ADxxa channels are selected. 1 ADxxb channels are selected. |
| 3 ADACKEN | Asynchronous Clock Output Enable Enables the asynchronous clock source and the clock source output regardless of the conversion and status of CFG1[ADICLK]. Based on MCU configuration, the asynchronous clock may be used by other modules. See chip configuration information. Setting this field allows the clock to be used even while the ADC is idle or operating from a different clock source. Also, latency of initiating a single or first-continuous conversion with the asynchronous clock selected is reduced because the ADACK clock is already operational. 0 Asynchronous clock output disabled; Asynchronous clock is enabled only if selected by ADICLK and a conversion is active. 1 Asynchronous clock and clock output is enabled regardless of the state of the ADC. |
| 2 ADHSC | High-Speed Configuration Configures the ADC for very high-speed operation. The conversion sequence is altered with 2 ADCK cycles added to the conversion time to allow higher speed conversion clocks. 0 Normal conversion sequence selected. 1 High-speed conversion sequence selected with 2 additional ADCK cycles to total conversion time. |
| ADLSTS | Long Sample Time Select Selects between the extended sample times when long sample time is selected, that is, when CFG1[ADLSMP]=1. This allows higher impedance inputs to be accurately sampled or to maximize conversion speed for lower impedance inputs. Longer sample times can also be used to lower overall power consumption when continuous conversions are enabled if high conversion rates are not required. 00 Default longest sample time; 20 extra ADCK cycles; 24 ADCK cycles total. 01 12 extra ADCK cycles; 16 ADCK cycles total sample time. 10 6 extra ADCK cycles; 10 ADCK cycles total sample time. 11 2 extra ADCK cycles; 6 ADCK cycles total sample time. |

29.3.4 ADC Data Result Register (ADCx_Rn)

The data result registers (Rn) contain the result of an ADC conversion of the channel selected by the corresponding status and channel control register (SC1A:SC1n). For every status and channel control register, there is a corresponding data result register.

Unused bits in R_n are cleared in unsigned right-aligned modes and carry the sign bit (MSB) in sign-extended 2's complement modes. For example, when configured for 10-bit single-ended mode, D[15:10] are cleared. When configured for 11-bit differential mode, D[15:10] carry the sign bit, that is, bit 10 extended through bit 15.

The following table describes the behavior of the data result registers in the different modes of operation.

Table 29-2. Data result register description

| Conversion mode | D15 | D14 | D13 | D12 | D11 | D10 | D9 | D8 | D7 | D6 | D5 | D4 | D3 | D2 | D1 | D0 | Format |
|---------------------|-----|-----|-----|-----|-----|-----|----|----|----|----|----|----|----|----|----|----|------------------------------|
| 16-bit differential | S | D | D | D | D | D | D | D | D | D | D | D | D | D | D | D | Signed 2's complement |
| 16-bit single-ended | D | D | D | D | D | D | D | D | D | D | D | D | D | D | D | D | Unsigned right justified |
| 13-bit differential | S | S | S | S | D | D | D | D | D | D | D | D | D | D | D | D | Sign-extended 2's complement |
| 12-bit single-ended | 0 | 0 | 0 | 0 | D | D | D | D | D | D | D | D | D | D | D | D | Unsigned right-justified |
| 11-bit differential | S | S | S | S | S | S | D | D | D | D | D | D | D | D | D | D | Sign-extended 2's complement |
| 10-bit single-ended | 0 | 0 | 0 | 0 | 0 | 0 | D | D | D | D | D | D | D | D | D | D | Unsigned right-justified |
| 9-bit differential | S | S | S | S | S | S | S | S | D | D | D | D | D | D | D | D | Sign-extended 2's complement |
| 8-bit single-ended | 0 | 0 | 0 | 0 | 0 | 0 | 0 | 0 | D | D | D | D | D | D | D | D | Unsigned right-justified |

NOTE

S: Sign bit or sign bit extension;

D: Data, which is 2's complement data if indicated

Address: 4003_B000h base + 10h offset + (4d × i), where i=0d to 1d

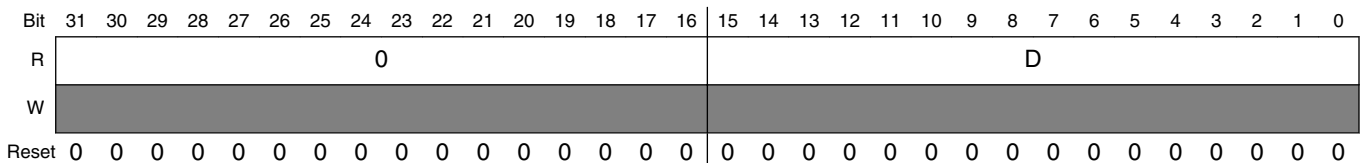

ADCx_Rn field descriptions

| Field | Description |
|----------------|--|
| 31–16 Reserved | This field is reserved. This read-only field is reserved and always has the value 0. |
| D | Data result |

29.3.5 Compare Value Registers (ADCx_CVn)

The Compare Value Registers (CV1 and CV2) contain a compare value used to compare the conversion result when the compare function is enabled, that is, SC2[ACFE]=1. This register is formatted in the same way as the Rn registers in different modes of operation for both bit position definition and value format using unsigned or sign-extended 2's complement. Therefore, the compare function uses only the CVn fields that are related to the ADC mode of operation.

The compare value 2 register (CV2) is used only when the compare range function is enabled, that is, SC2[ACREN]=1.

Address: 4003_B000h base + 18h offset + (4d × i), where i=0d to 1d

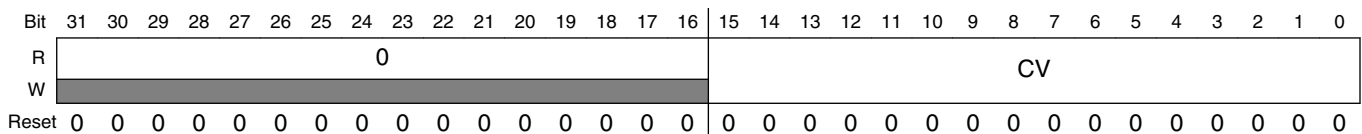

ADCx_CVn field descriptions

| Field | Description |
|-------------------|---|
| 31–16 Reserved | This field is reserved. This read-only field is reserved and always has the value 0. |
| CV | Compare Value. |

29.3.6 Status and Control Register 2 (ADCx_SC2)

The status and control register 2 (SC2) contains the conversion active, hardware/software trigger select, compare function, and voltage reference select of the ADC module.

Address: 4003_B000h base + 20h offset = 4003_B020h

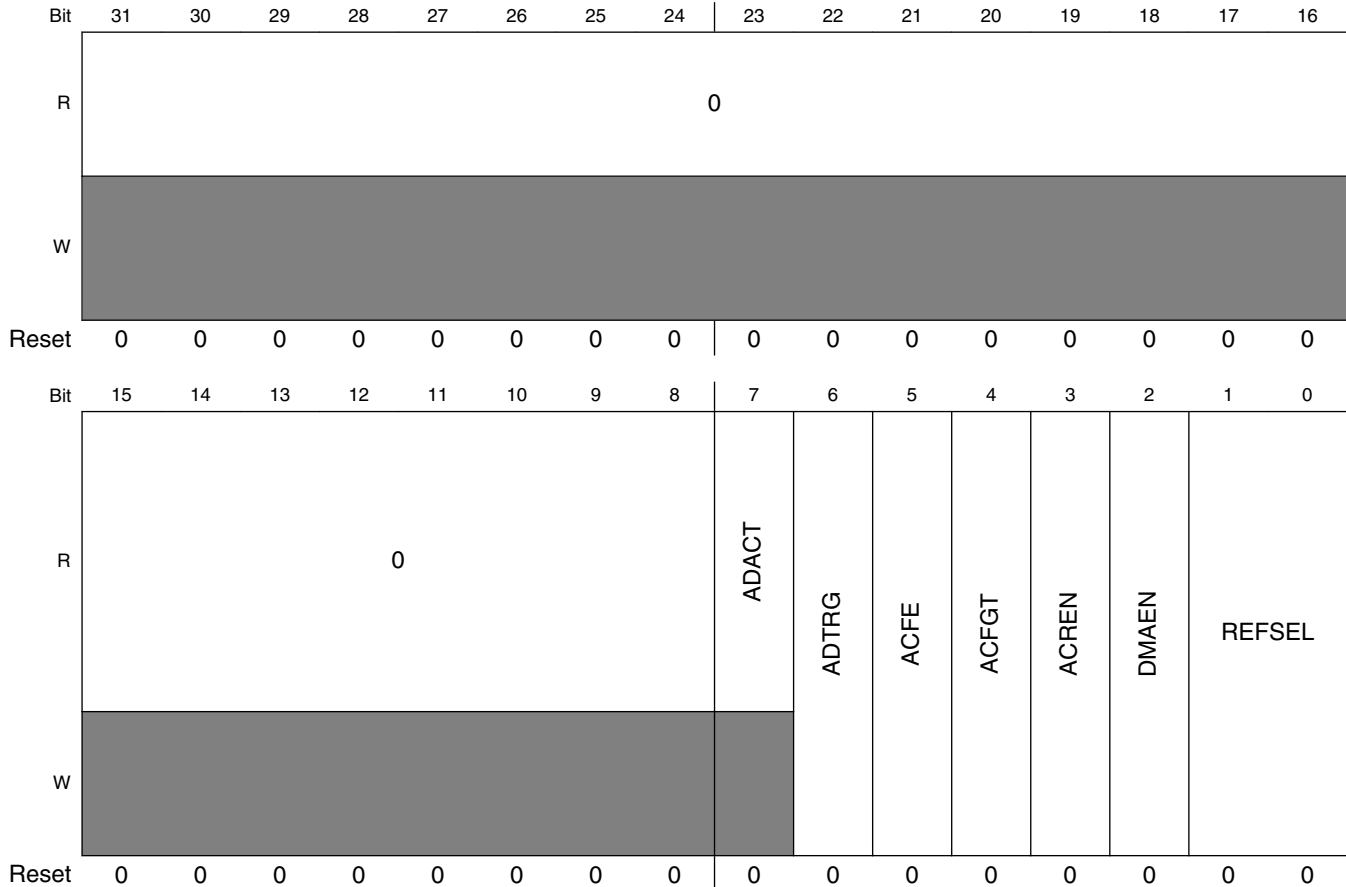

ADCx_SC2 field descriptions

| Field | Description |
|------------------|---|
| 31–8 Reserved | This field is reserved. This read-only field is reserved and always has the value 0. |
| 7 ADACT | Conversion Active Indicates that a conversion or hardware averaging is in progress. ADACT is set when a conversion is initiated and cleared when a conversion is completed or aborted. 0 Conversion not in progress. 1 Conversion in progress. |
| 6 ADTRG | Conversion Trigger Select Selects the type of trigger used for initiating a conversion. Two types of trigger are selectable: |

Table continues on the next page...

ADCx_SC2 field descriptions (continued)

| Field | Description |
|------------|--|
| | <ul style="list-style-type: none"> Software trigger: When software trigger is selected, a conversion is initiated following a write to SC1A. Hardware trigger: When hardware trigger is selected, a conversion is initiated following the assertion of the ADHWT input after a pulse of the ADHWTSn input. <p>0 Software trigger selected. 1 Hardware trigger selected.</p> |
| 5 ACFE | <p>Compare Function Enable</p> <p>Enables the compare function.</p> <p>0 Compare function disabled. 1 Compare function enabled.</p> |
| 4 ACFGT | <p>Compare Function Greater Than Enable</p> <p>Configures the compare function to check the conversion result relative to the CV1 and CV2 based upon the value of ACREN. ACFE must be set for ACFGT to have any effect.</p> <p>0 Configures less than threshold, outside range not inclusive and inside range not inclusive; functionality based on the values placed in CV1 and CV2. 1 Configures greater than or equal to threshold, outside and inside ranges inclusive; functionality based on the values placed in CV1 and CV2.</p> |
| 3 ACREN | <p>Compare Function Range Enable</p> <p>Configures the compare function to check if the conversion result of the input being monitored is either between or outside the range formed by CV1 and CV2 determined by the value of ACFGT. ACFE must be set for ACFGT to have any effect.</p> <p>0 Range function disabled. Only CV1 is compared. 1 Range function enabled. Both CV1 and CV2 are compared.</p> |
| 2 DMAEN | <p>DMA Enable</p> <p>0 DMA is disabled. 1 DMA is enabled and will assert the ADC DMA request during an ADC conversion complete event noted when any of the SC1n[COCO] flags is asserted.</p> |
| REFSEL | <p>Voltage Reference Selection</p> <p>Selects the voltage reference source used for conversions.</p> <p>00 Default voltage reference pin pair, that is, external pins V_{REFH} and V_{REFL} 01 Alternate reference pair, that is, V_{ALTH} and V_{ALT L}. This pair may be additional external pins or internal sources depending on the MCU configuration. See the chip configuration information for details specific to this MCU 10 Reserved 11 Reserved</p> |

29.3.7 Status and Control Register 3 (ADCx_SC3)

The Status and Control Register 3 (SC3) controls the calibration, continuous convert, and hardware averaging functions of the ADC module.

Address: 4003_B000h base + 24h offset = 4003_B024h

| | | | | | | | | | | | | | | | | |
|-------|------------|----|----|----|----|----|----|----|-----|------------|------------|----|------------|------------|------------|----|
| Bit | 31 | 30 | 29 | 28 | 27 | 26 | 25 | 24 | 23 | 22 | 21 | 20 | 19 | 18 | 17 | 16 |
| R | 0 | | | | | | | | | | | | | | | |
| W | [Reserved] | | | | | | | | | | | | | | | |
| Reset | 0 | 0 | 0 | 0 | 0 | 0 | 0 | 0 | 0 | 0 | 0 | 0 | 0 | 0 | 0 | 0 |
| Bit | 15 | 14 | 13 | 12 | 11 | 10 | 9 | 8 | 7 | 6 | 5 | 4 | 3 | 2 | 1 | 0 |
| R | 0 | | | | | | | | CAL | CALF | 0 | | ADCO | AVGE | AVGS | |
| W | [Reserved] | | | | | | | | w1c | [Reserved] | [Reserved] | | [Reserved] | [Reserved] | [Reserved] | |
| Reset | 0 | 0 | 0 | 0 | 0 | 0 | 0 | 0 | 0 | 0 | 0 | 0 | 0 | 0 | 0 | 0 |

ADCx_SC3 field descriptions

| Field | Description |
|------------------|---|
| 31–8 Reserved | This field is reserved. This read-only field is reserved and always has the value 0. |
| 7 CAL | Calibration Begins the calibration sequence when set. This field stays set while the calibration is in progress and is cleared when the calibration sequence is completed. CALF must be checked to determine the result of the calibration sequence. Once started, the calibration routine cannot be interrupted by writes to the ADC registers or the results will be invalid and CALF will set. Setting CAL will abort any current conversion. |
| 6 CALF | Calibration Failed Flag Displays the result of the calibration sequence. The calibration sequence will fail if SC2[ADTRG] = 1, any ADC register is written, or any stop mode is entered before the calibration sequence completes. Writing 1 to CALF clears it. 0 Calibration completed normally. 1 Calibration failed. ADC accuracy specifications are not guaranteed. |

Table continues on the next page...

ADCx_SC3 field descriptions (continued)

| Field | Description |
|-----------------|--|
| 5-4 Reserved | This field is reserved. This read-only field is reserved and always has the value 0. |
| 3 ADCO | Continuous Conversion Enable Enables continuous conversions. 0 One conversion or one set of conversions if the hardware average function is enabled, that is, AVGE=1, after initiating a conversion. 1 Continuous conversions or sets of conversions if the hardware average function is enabled, that is, AVGE=1, after initiating a conversion. |
| 2 AVGE | Hardware Average Enable Enables the hardware average function of the ADC. 0 Hardware average function disabled. 1 Hardware average function enabled. |
| AVGS | Hardware Average Select Determines how many ADC conversions will be averaged to create the ADC average result. 00 4 samples averaged. 01 8 samples averaged. 10 16 samples averaged. 11 32 samples averaged. |

29.3.8 ADC Offset Correction Register (ADCx_OFS)

The ADC Offset Correction Register (OFS) contains the user-selected or calibration-generated offset error correction value. This register is a 2’s complement, left-justified, 16-bit value . The value in OFS is subtracted from the conversion and the result is transferred into the result registers, Rn. If the result is greater than the maximum or less than the minimum result value, it is forced to the appropriate limit for the current mode of operation.

For more information regarding the calibration procedure, please refer to the [Calibration function](#) section.

Address: 4003_B000h base + 28h offset = 4003_B028h

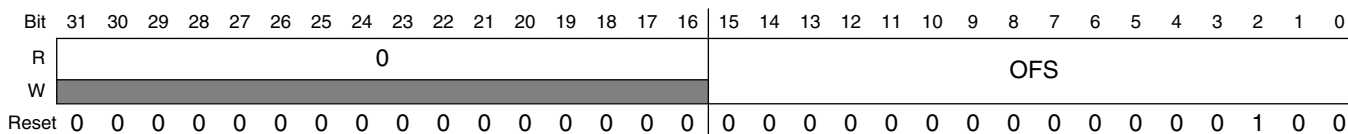

ADCx_OFS field descriptions

| Field | Description |
|-------------------|---|
| 31–16 Reserved | This field is reserved. This read-only field is reserved and always has the value 0. |
| OFS | Offset Error Correction Value |

29.3.9 ADC Plus-Side Gain Register (ADCx_PG)

The Plus-Side Gain Register (PG) contains the gain error correction for the plus-side input in differential mode or the overall conversion in single-ended mode. PG, a 16-bit real number in binary format, is the gain adjustment factor, with the radix point fixed between PG[15] and PG[14]. This register must be written by the user with the value described in the calibration procedure. Otherwise, the gain error specifications may not be met.

For more information regarding the calibration procedure, please refer to the [Calibration function](#) section.

Address: 4003_B000h base + 2Ch offset = 4003_B02Ch

| | | | | | | | | | | | | | | | | | | | | | | | | | | | | | | | | |
|-------|----|----|----|----|----|----|----|----|----|----|----|----|----|----|----|----|----|----|----|----|----|----|---|---|---|---|---|---|---|---|---|---|
| Bit | 31 | 30 | 29 | 28 | 27 | 26 | 25 | 24 | 23 | 22 | 21 | 20 | 19 | 18 | 17 | 16 | 15 | 14 | 13 | 12 | 11 | 10 | 9 | 8 | 7 | 6 | 5 | 4 | 3 | 2 | 1 | 0 |
| R | 0 | | | | | | | | | | | | | | | | PG | | | | | | | | | | | | | | | |
| W | 1 | | | | | | | | | | | | | | | | 0 | | | | | | | | | | | | | | | |
| Reset | 0 | 0 | 0 | 0 | 0 | 0 | 0 | 0 | 0 | 0 | 0 | 0 | 0 | 0 | 0 | 0 | 1 | 0 | 0 | 0 | 0 | 0 | 1 | 0 | 0 | 0 | 0 | 0 | 0 | 0 | 0 | 0 |

ADCx_PG field descriptions

| Field | Description |
|-------------------|---|
| 31–16 Reserved | This field is reserved. This read-only field is reserved and always has the value 0. |
| PG | Plus-Side Gain |

29.3.10 ADC Minus-Side Gain Register (ADCx_MG)

The Minus-Side Gain Register (MG) contains the gain error correction for the minus-side input in differential mode. This register is ignored in single-ended mode. MG, a 16-bit real number in binary format, is the gain adjustment factor, with the radix point fixed between MG[15] and MG[14]. This register must be written by the user with the value described in the calibration procedure. Otherwise, the gain error specifications may not be met.

Memory map and register definitions

For more information regarding the calibration procedure, please refer to the [Calibration function](#) section.

Address: 4003_B000h base + 30h offset = 4003_B030h

| | | | | | | | | | | | | | | | | | | | | | | | | | | | | | | | | |
|-------|----|----|----|----|----|----|----|----|----|----|----|----|----|----|----|----|----|----|----|----|----|----|---|---|---|---|---|---|---|---|---|---|
| Bit | 31 | 30 | 29 | 28 | 27 | 26 | 25 | 24 | 23 | 22 | 21 | 20 | 19 | 18 | 17 | 16 | 15 | 14 | 13 | 12 | 11 | 10 | 9 | 8 | 7 | 6 | 5 | 4 | 3 | 2 | 1 | 0 |
| R | 0 | | | | | | | | | | | | | | | | MG | | | | | | | | | | | | | | | |
| W | 0 | | | | | | | | | | | | | | | | 0 | | | | | | | | | | | | | | | |
| Reset | 0 | 0 | 0 | 0 | 0 | 0 | 0 | 0 | 0 | 0 | 0 | 0 | 0 | 0 | 0 | 0 | 1 | 0 | 0 | 0 | 0 | 0 | 1 | 0 | 0 | 0 | 0 | 0 | 0 | 0 | 0 | 0 |

ADCx_MG field descriptions

| Field | Description |
|-------------------|---|
| 31–16 Reserved | This field is reserved. This read-only field is reserved and always has the value 0. |
| MG | Minus-Side Gain |

29.3.11 ADC Plus-Side General Calibration Value Register (ADCx_CLPD)

The Plus-Side General Calibration Value Registers (CLPx) contain calibration information that is generated by the calibration function. These registers contain seven calibration values of varying widths: CLP0[5:0], CLP1[6:0], CLP2[7:0], CLP3[8:0], CLP4[9:0], CLPS[5:0], and CLPD[5:0]. CLPx are automatically set when the self-calibration sequence is done, that is, CAL is cleared. If these registers are written by the user after calibration, the linearity error specifications may not be met.

For more information regarding the calibration procedure, please refer to the [Calibration function](#) section.

Address: 4003_B000h base + 34h offset = 4003_B034h

| | | | | | | | | | | | | | | | | | | | | | | | | | | | | | | | | |
|-------|----|----|----|----|----|----|----|----|----|----|----|----|----|----|----|----|------|----|----|----|----|----|---|---|---|---|---|---|---|---|---|---|
| Bit | 31 | 30 | 29 | 28 | 27 | 26 | 25 | 24 | 23 | 22 | 21 | 20 | 19 | 18 | 17 | 16 | 15 | 14 | 13 | 12 | 11 | 10 | 9 | 8 | 7 | 6 | 5 | 4 | 3 | 2 | 1 | 0 |
| R | 0 | | | | | | | | | | | | | | | | CLPD | | | | | | | | | | | | | | | |
| W | 0 | | | | | | | | | | | | | | | | 0 | | | | | | | | | | | | | | | |
| Reset | 0 | 0 | 0 | 0 | 0 | 0 | 0 | 0 | 0 | 0 | 0 | 0 | 0 | 0 | 0 | 0 | 0 | 0 | 0 | 0 | 0 | 0 | 0 | 0 | 0 | 0 | 0 | 0 | 1 | 0 | 1 | 0 |

ADCx_CLPD field descriptions

| Field | Description |
|------------------|---|
| 31–6 Reserved | This field is reserved. This read-only field is reserved and always has the value 0. |
| CLPD | Calibration Value Calibration Value |

29.3.12 ADC Plus-Side General Calibration Value Register (ADCx_CLPS)

For more information, see CLPD register description.

Address: 4003_B000h base + 38h offset = 4003_B038h

| | | | | | | | | | | | | | | | | | | | | | | | | | | | | | | | | |
|-------|----|----|----|----|----|----|----|----|----|----|----|----|----|----|----|----|------|----|----|----|----|----|---|---|---|---|---|---|---|---|---|---|
| Bit | 31 | 30 | 29 | 28 | 27 | 26 | 25 | 24 | 23 | 22 | 21 | 20 | 19 | 18 | 17 | 16 | 15 | 14 | 13 | 12 | 11 | 10 | 9 | 8 | 7 | 6 | 5 | 4 | 3 | 2 | 1 | 0 |
| R | 0 | | | | | | | | | | | | | | | | CLPS | | | | | | | | | | | | | | | |
| W | 0 | | | | | | | | | | | | | | | | 1 | | | | | | | | | | | | | | | |
| Reset | 0 | 0 | 0 | 0 | 0 | 0 | 0 | 0 | 0 | 0 | 0 | 0 | 0 | 0 | 0 | 0 | 0 | 0 | 0 | 0 | 0 | 0 | 0 | 0 | 0 | 0 | 0 | 0 | 0 | 0 | 0 | 0 |

ADCx_CLPS field descriptions

| Field | Description |
|------------------|---|
| 31–6 Reserved | This field is reserved. This read-only field is reserved and always has the value 0. |
| CLPS | Calibration Value Calibration Value |

29.3.13 ADC Plus-Side General Calibration Value Register (ADCx_CLP4)

For more information, see CLPD register description.

Address: 4003_B000h base + 3Ch offset = 4003_B03Ch

| | | | | | | | | | | | | | | | | | | | | | | | | | | | | | | | | |
|-------|----|----|----|----|----|----|----|----|----|----|----|----|----|----|----|----|------|----|----|----|----|----|---|---|---|---|---|---|---|---|---|---|
| Bit | 31 | 30 | 29 | 28 | 27 | 26 | 25 | 24 | 23 | 22 | 21 | 20 | 19 | 18 | 17 | 16 | 15 | 14 | 13 | 12 | 11 | 10 | 9 | 8 | 7 | 6 | 5 | 4 | 3 | 2 | 1 | 0 |
| R | 0 | | | | | | | | | | | | | | | | CLP4 | | | | | | | | | | | | | | | |
| W | 0 | | | | | | | | | | | | | | | | 1 | | | | | | | | | | | | | | | |
| Reset | 0 | 0 | 0 | 0 | 0 | 0 | 0 | 0 | 0 | 0 | 0 | 0 | 0 | 0 | 0 | 0 | 0 | 0 | 0 | 0 | 0 | 0 | 0 | 0 | 0 | 0 | 0 | 0 | 0 | 0 | 0 | 0 |

ADCx_CLP4 field descriptions

| Field | Description |
|-------------------|---|
| 31–10 Reserved | This field is reserved. This read-only field is reserved and always has the value 0. |
| CLP4 | Calibration Value Calibration Value |

29.3.14 ADC Plus-Side General Calibration Value Register (ADCx_CLP3)

For more information, see CLPD register description.

Address: 4003_B000h base + 40h offset = 4003_B040h

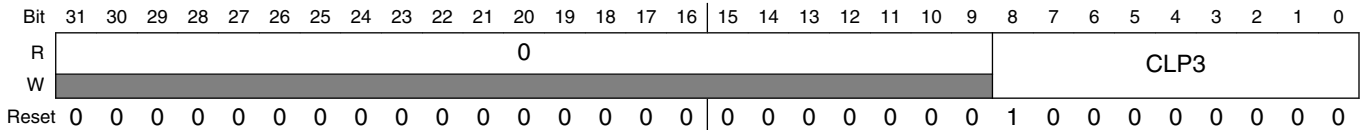

ADCx_CLP3 field descriptions

| Field | Description |
|------------------|---|
| 31–9 Reserved | This field is reserved. This read-only field is reserved and always has the value 0. |
| CLP3 | Calibration Value Calibration Value |

29.3.15 ADC Plus-Side General Calibration Value Register (ADCx_CLP2)

For more information, see CLPD register description.

Address: 4003_B000h base + 44h offset = 4003_B044h

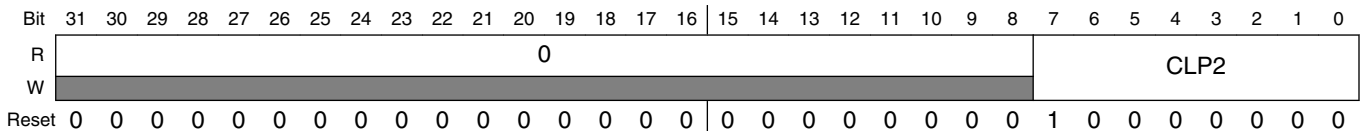

ADCx_CLP2 field descriptions

| Field | Description |
|------------------|---|
| 31–8 Reserved | This field is reserved. This read-only field is reserved and always has the value 0. |
| CLP2 | Calibration Value Calibration Value |

29.3.16 ADC Plus-Side General Calibration Value Register (ADCx_CLP1)

For more information, see CLPD register description.

Address: 4003_B000h base + 48h offset = 4003_B048h

| | | | | | | | | | | | | | | | | | | | | | | | | | | | | | | | | | |
|-------|----|----|----|----|----|----|----|----|----|----|----|----|----|----|----|----|------|----|----|----|----|----|---|---|---|---|---|---|---|---|---|---|---|
| Bit | 31 | 30 | 29 | 28 | 27 | 26 | 25 | 24 | 23 | 22 | 21 | 20 | 19 | 18 | 17 | 16 | 15 | 14 | 13 | 12 | 11 | 10 | 9 | 8 | 7 | 6 | 5 | 4 | 3 | 2 | 1 | 0 | |
| R | 0 | | | | | | | | | | | | | | | | CLP1 | | | | | | | | | | | | | | | | |
| W | 0 | | | | | | | | | | | | | | | | 1 | | | | | | | | | | | | | | | | |
| Reset | 0 | 0 | 0 | 0 | 0 | 0 | 0 | 0 | 0 | 0 | 0 | 0 | 0 | 0 | 0 | 0 | 0 | 0 | 0 | 0 | 0 | 0 | 0 | 0 | 0 | 0 | 1 | 0 | 0 | 0 | 0 | 0 | 0 |

ADCx_CLP1 field descriptions

| Field | Description |
|------------------|---|
| 31–7 Reserved | This field is reserved. This read-only field is reserved and always has the value 0. |
| CLP1 | Calibration Value Calibration Value |

29.3.17 ADC Plus-Side General Calibration Value Register (ADCx_CLP0)

For more information, see CLPD register description.

Address: 4003_B000h base + 4Ch offset = 4003_B04Ch

| | | | | | | | | | | | | | | | | | | | | | | | | | | | | | | | | | |
|-------|----|----|----|----|----|----|----|----|----|----|----|----|----|----|----|----|------|----|----|----|----|----|---|---|---|---|---|---|---|---|---|---|---|
| Bit | 31 | 30 | 29 | 28 | 27 | 26 | 25 | 24 | 23 | 22 | 21 | 20 | 19 | 18 | 17 | 16 | 15 | 14 | 13 | 12 | 11 | 10 | 9 | 8 | 7 | 6 | 5 | 4 | 3 | 2 | 1 | 0 | |
| R | 0 | | | | | | | | | | | | | | | | CLP0 | | | | | | | | | | | | | | | | |
| W | 0 | | | | | | | | | | | | | | | | 1 | | | | | | | | | | | | | | | | |
| Reset | 0 | 0 | 0 | 0 | 0 | 0 | 0 | 0 | 0 | 0 | 0 | 0 | 0 | 0 | 0 | 0 | 0 | 0 | 0 | 0 | 0 | 0 | 0 | 0 | 0 | 0 | 1 | 0 | 0 | 0 | 0 | 0 | 0 |

ADCx_CLP0 field descriptions

| Field | Description |
|------------------|---|
| 31–6 Reserved | This field is reserved. This read-only field is reserved and always has the value 0. |
| CLP0 | Calibration Value Calibration Value |

29.3.18 ADC Minus-Side General Calibration Value Register (ADCx_CLMD)

The Minus-Side General Calibration Value (CLMx) registers contain calibration information that is generated by the calibration function. These registers contain seven calibration values of varying widths: CLM0[5:0], CLM1[6:0], CLM2[7:0], CLM3[8:0], CLM4[9:0], CLMS[5:0], and CLMD[5:0]. CLMx are automatically set when the self-calibration sequence is done, that is, CAL is cleared. If these registers are written by the user after calibration, the linearity error specifications may not be met.

For more information regarding the calibration procedure, please refer to the [Calibration function](#) section.

Address: 4003_B000h base + 54h offset = 4003_B054h

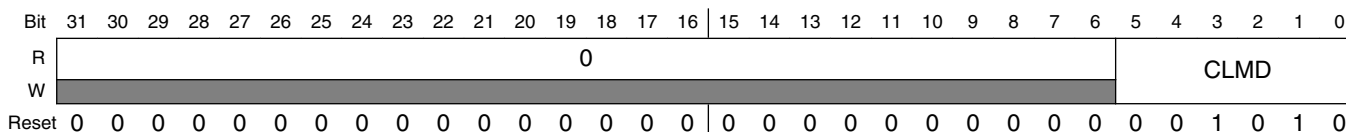

ADCx_CLMD field descriptions

| Field | Description |
|---------------|---|
| 31–6 Reserved | This field is reserved. This read-only field is reserved and always has the value 0. |
| CLMD | Calibration Value Calibration Value |

29.3.19 ADC Minus-Side General Calibration Value Register (ADCx_CLMS)

For more information, see CLMD register description.

Address: 4003_B000h base + 58h offset = 4003_B058h

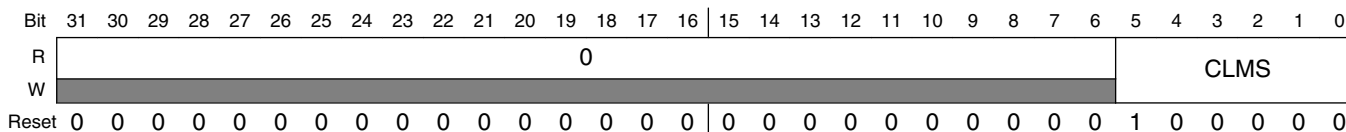

ADCx_CLMS field descriptions

| Field | Description |
|------------------|---|
| 31–6 Reserved | This field is reserved. This read-only field is reserved and always has the value 0. |
| CLMS | Calibration Value Calibration Value |

29.3.20 ADC Minus-Side General Calibration Value Register (ADCx_CLM4)

For more information, see CLMD register description.

Address: 4003_B000h base + 5Ch offset = 4003_B05Ch

| Bit | 31 | 30 | 29 | 28 | 27 | 26 | 25 | 24 | 23 | 22 | 21 | 20 | 19 | 18 | 17 | 16 | 15 | 14 | 13 | 12 | 11 | 10 | 9 | 8 | 7 | 6 | 5 | 4 | 3 | 2 | 1 | 0 | |
|-------|----|----|----|----|----|----|----|----|----|----|----|----|----|----|----|----|------|----|----|----|----|----|---|---|---|---|---|---|---|---|---|---|---|
| R | 0 | | | | | | | | | | | | | | | | | | | | | | | | | | | | | | | | |
| W | | | | | | | | | | | | | | | | | CLM4 | | | | | | | | | | | | | | | | |
| Reset | 0 | 0 | 0 | 0 | 0 | 0 | 0 | 0 | 0 | 0 | 0 | 0 | 0 | 0 | 0 | 0 | 0 | 0 | 0 | 0 | 0 | 0 | 0 | 1 | 0 | 0 | 0 | 0 | 0 | 0 | 0 | 0 | 0 |

ADCx_CLM4 field descriptions

| Field | Description |
|-------------------|---|
| 31–10 Reserved | This field is reserved. This read-only field is reserved and always has the value 0. |
| CLM4 | Calibration Value Calibration Value |

29.3.21 ADC Minus-Side General Calibration Value Register (ADCx_CLM3)

For more information, see CLMD register description.

Address: 4003_B000h base + 60h offset = 4003_B060h

| Bit | 31 | 30 | 29 | 28 | 27 | 26 | 25 | 24 | 23 | 22 | 21 | 20 | 19 | 18 | 17 | 16 | 15 | 14 | 13 | 12 | 11 | 10 | 9 | 8 | 7 | 6 | 5 | 4 | 3 | 2 | 1 | 0 | |
|-------|----|----|----|----|----|----|----|----|----|----|----|----|----|----|----|----|------|----|----|----|----|----|---|---|---|---|---|---|---|---|---|---|---|
| R | 0 | | | | | | | | | | | | | | | | | | | | | | | | | | | | | | | | |
| W | | | | | | | | | | | | | | | | | CLM3 | | | | | | | | | | | | | | | | |
| Reset | 0 | 0 | 0 | 0 | 0 | 0 | 0 | 0 | 0 | 0 | 0 | 0 | 0 | 0 | 0 | 0 | 0 | 0 | 0 | 0 | 0 | 0 | 0 | 1 | 0 | 0 | 0 | 0 | 0 | 0 | 0 | 0 | 0 |

ADCx_CLM3 field descriptions

| Field | Description |
|------------------|---|
| 31–9 Reserved | This field is reserved. This read-only field is reserved and always has the value 0. |

Table continues on the next page...

ADCx_CLM3 field descriptions (continued)

| Field | Description |
|-------|-------------------|
| CLM3 | Calibration Value |
| | Calibration Value |

29.3.22 ADC Minus-Side General Calibration Value Register (ADCx_CLM2)

For more information, see CLMD register description.

Address: 4003_B000h base + 64h offset = 4003_B064h

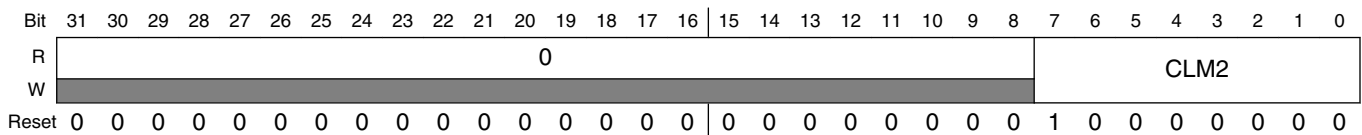

ADCx_CLM2 field descriptions

| Field | Description |
|------------------|---|
| 31–8 Reserved | This field is reserved. This read-only field is reserved and always has the value 0. |
| CLM2 | Calibration Value |
| | Calibration Value |

29.3.23 ADC Minus-Side General Calibration Value Register (ADCx_CLM1)

For more information, see CLMD register description.

Address: 4003_B000h base + 68h offset = 4003_B068h

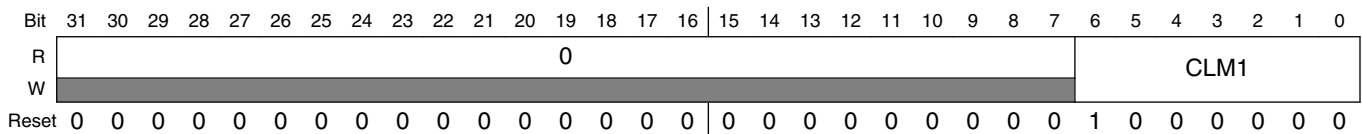

ADCx_CLM1 field descriptions

| Field | Description |
|------------------|---|
| 31–7 Reserved | This field is reserved. This read-only field is reserved and always has the value 0. |
| CLM1 | Calibration Value |
| | Calibration Value |

29.3.24 ADC Minus-Side General Calibration Value Register (ADCx_CLM0)

For more information, see CLMD register description.

Address: 4003_B000h base + 6Ch offset = 4003_B06Ch

| | | | | | | | | | | | | | | | | | | | | | | | | | | | | | | | | | |
|-------|----|----|----|----|----|----|----|----|----|----|----|----|----|----|----|----|------|----|----|----|----|----|---|---|---|---|---|---|---|---|---|---|---|
| Bit | 31 | 30 | 29 | 28 | 27 | 26 | 25 | 24 | 23 | 22 | 21 | 20 | 19 | 18 | 17 | 16 | 15 | 14 | 13 | 12 | 11 | 10 | 9 | 8 | 7 | 6 | 5 | 4 | 3 | 2 | 1 | 0 | |
| R | 0 | | | | | | | | | | | | | | | | CLM0 | | | | | | | | | | | | | | | | |
| W | 0 | | | | | | | | | | | | | | | | 1 | | | | | | | | | | | | | | | | |
| Reset | 0 | 0 | 0 | 0 | 0 | 0 | 0 | 0 | 0 | 0 | 0 | 0 | 0 | 0 | 0 | 0 | 0 | 0 | 0 | 0 | 0 | 0 | 0 | 0 | 0 | 0 | 0 | 1 | 0 | 0 | 0 | 0 | 0 |

ADCx_CLM0 field descriptions

| Field | Description |
|------------------|---|
| 31–6 Reserved | This field is reserved. This read-only field is reserved and always has the value 0. |
| CLM0 | Calibration Value Calibration Value |

29.4 Functional description

The ADC module is disabled during reset, in Low-Power Stop mode, or when SC1n[ADCH] are all high; see the power management information for details. The module is idle when a conversion has completed and another conversion has not been initiated. When it is idle and the asynchronous clock output enable is disabled, or CFG2[ADACKEN]= 0, the module is in its lowest power state. The ADC can perform an analog-to-digital conversion on any of the software selectable channels. All modes perform conversion by a successive approximation algorithm.

To meet accuracy specifications, the ADC module must be calibrated using the on-chip calibration function.

See [Calibration function](#) for details on how to perform calibration.

When the conversion is completed, the result is placed in the Rn data registers. The respective SC1n[COCO] is then set and an interrupt is generated if the respective conversion complete interrupt has been enabled, or, when SC1n[AIEN]=1.

The ADC module has the capability of automatically comparing the result of a conversion with the contents of the CV1 and CV2 registers. The compare function is enabled by setting SC2[ACFE] and operates in any of the conversion modes and configurations.

The ADC module has the capability of automatically averaging the result of multiple conversions. The hardware average function is enabled by setting SC3[AVGE] and operates in any of the conversion modes and configurations.

NOTE

For the chip specific modes of operation, see the power management information of this MCU.

29.4.1 Clock select and divide control

One of four clock sources can be selected as the clock source for the ADC module.

This clock source is then divided by a configurable value to generate the input clock ADCK, to the module. The clock is selected from one of the following sources by means of CFG1[ADICLK].

- Bus clock. This is the default selection following reset.
- Bus clock divided by two. For higher bus clock rates, this allows a maximum divide-by-16 of the bus clock using CFG1[ADIV].
- ALTCLK: As defined for this MCU. See the chip configuration information. Conversions are possible using ALTCLK as the input clock source while the MCU is in Normal Stop mode.
- Asynchronous clock (ADACK): This clock is generated from a clock source within the ADC module. When the ADACK clock source is selected, it is not required to be active prior to conversion start. When it is selected and it is not active prior to a conversion start CFG2[ADACKEN]=0, ADACK is activated at the start of a conversion and deactivated when conversions are terminated. In this case, there is an associated clock startup delay each time the clock source is re-activated. To avoid the conversion time variability and latency associated with the ADACK clock startup, set CFG2[ADACKEN]=1 and wait the worst-case startup time of 5 μ s prior to initiating any conversions using the ADACK clock source. Conversions are possible using ADACK as the input clock source while the MCU is in Normal Stop mode. See [Power Control](#) for more information.

Whichever clock is selected, its frequency must fall within the specified frequency range for ADCK. If the available clocks are too slow, the ADC may not perform according to specifications. If the available clocks are too fast, the clock must be divided to the appropriate frequency. This divider is specified by CFG1[ADIV] and can be divide-by 1, 2, 4, or 8.

29.4.2 Voltage reference selection

The ADC can be configured to accept one of the two voltage reference pairs as the reference voltage (V_{REFSH} and V_{REFSL}) used for conversions.

Each pair contains a positive reference that must be between the minimum Ref Voltage High and V_{DDA} , and a ground reference that must be at the same potential as V_{SSA} . The two pairs are external (V_{REFH} and V_{REFL}) and alternate (V_{ALTH} and V_{ALTL}). These voltage references are selected using $SC2[REFSEL]$. The alternate (V_{ALTH} and V_{ALTL}) voltage reference pair may select additional external pins or internal sources depending on MCU configuration. See the chip configuration information on the voltage references specific to this MCU.

29.4.3 Hardware trigger and channel selects

The ADC module has a selectable asynchronous hardware conversion trigger, ADHWT, that is enabled when $SC2[ADTRG]$ is set and a hardware trigger select event, ADHWTSn, has occurred.

This source is not available on all MCUs. See the chip-specific ADC information for information on the ADHWT source and the ADHWTSn configurations specific to this MCU.

When an ADHWT source is available and hardware trigger is enabled, that is $SC2[ADTRG]=1$, a conversion is initiated on the rising-edge of ADHWT after a hardware trigger select event, that is, ADHWTSn, has occurred. If a conversion is in progress when a rising-edge of a trigger occurs, the rising-edge is ignored. In continuous convert configuration, only the initial rising-edge to launch continuous conversions is observed, and until conversion is aborted, the ADC continues to do conversions on the same SCn register that initiated the conversion. The hardware trigger function operates in conjunction with any of the conversion modes and configurations.

The hardware trigger select event, ADHWTSn, must be set prior to the receipt of the ADHWT signal. If these conditions are not met, the converter may ignore the trigger or use the incorrect configuration. If a hardware trigger select event is asserted during a conversion, it must stay asserted until the end of current conversion and remain set until the receipt of the ADHWT signal to trigger a new conversion. The channel and status fields selected for the conversion depend on the active trigger select signal:

- ADHWTS_A active selects SC_{1A}.
- ADHWTS_n active selects SC_{1n}.

Note

Asserting more than one hardware trigger select signal (ADHWTSn) at the same time results in unknown results. To avoid this, select only one hardware trigger select signal (ADHWTSn) prior to the next intended conversion.

When the conversion is completed, the result is placed in the Rn registers associated with the ADHWTSn received. For example:

- ADHWTS_A active selects RA register
- ADHWTS_n active selects R_n register

The conversion complete flag associated with the ADHWTSn received, that is, SC1n[COCO], is then set and an interrupt is generated if the respective conversion complete interrupt has been enabled, that is, SC1[AIEN]=1.

29.4.4 Conversion control

Conversions can be performed as determined by CFG1[MODE] and SC1n[DIFF] as shown in the description of CFG1[MODE].

Conversions can be initiated by a software or hardware trigger.

In addition, the ADC module can be configured for:

- Low-power operation
- Long sample time
- Continuous conversion
- Hardware average
- Automatic compare of the conversion result to a software determined compare value

29.4.4.1 Initiating conversions

A conversion is initiated:

- Following a write to SC1A, with SC1n[ADCH] not all 1's, if software triggered operation is selected, that is, when SC2[ADTRG]=0.
- Following a hardware trigger, or ADHWT event, if hardware triggered operation is selected, that is, SC2[ADTRG]=1, and a hardware trigger select event, ADHWTS_n, has occurred. The channel and status fields selected depend on the active trigger select signal:
 - ADHWTS_A active selects SC1A.

- ADHWTSn active selects SC1n.
- if neither is active, the off condition is selected

Note

Selecting more than one ADHWTSn prior to a conversion completion will result in unknown results. To avoid this, select only one ADHWTSn prior to a conversion completion.

- Following the transfer of the result to the data registers when continuous conversion is enabled, that is, when $SC3[ADCO] = 1$.

If continuous conversions are enabled, a new conversion is automatically initiated after the completion of the current conversion. In software triggered operation, that is, when $SC2[ADTRG] = 0$, continuous conversions begin after SC1A is written and continue until aborted. In hardware triggered operation, that is, when $SC2[ADTRG] = 1$ and one ADHWTSn event has occurred, continuous conversions begin after a hardware trigger event and continue until aborted.

If hardware averaging is enabled, a new conversion is automatically initiated after the completion of the current conversion until the correct number of conversions are completed. In software triggered operation, conversions begin after SC1A is written. In hardware triggered operation, conversions begin after a hardware trigger. If continuous conversions are also enabled, a new set of conversions to be averaged are initiated following the last of the selected number of conversions.

29.4.4.2 Completing conversions

A conversion is completed when the result of the conversion is transferred into the data result registers, Rn. If the compare functions are disabled, this is indicated by setting of $SC1n[COCO]$. If hardware averaging is enabled, the respective $SC1n[COCO]$ sets only if the last of the selected number of conversions is completed. If the compare function is enabled, the respective $SC1n[COCO]$ sets and conversion result data is transferred only if the compare condition is true. If both hardware averaging and compare functions are enabled, then the respective $SC1n[COCO]$ sets only if the last of the selected number of conversions is completed and the compare condition is true. An interrupt is generated if the respective $SC1n[AIEN]$ is high at the time that the respective $SC1n[COCO]$ is set.

29.4.4.3 Aborting conversions

Any conversion in progress is aborted when:

- Writing to SC1A while it is actively controlling a conversion, aborts the current conversion. In Software Trigger mode, when SC2[ADTRG]=0, a write to SC1A initiates a new conversion if SC1A[ADCH] is equal to a value other than all 1s. Writing to any of the SC1B–SC1n registers while that specific SC1B–SC1n register is actively controlling a conversion aborts the current conversion. The SC1(B-n) registers are not used for software trigger operation and therefore writes to the SC1(B-n) registers do not initiate a new conversion.
- A write to any ADC register besides the SC1A-SC1n registers occurs. This indicates that a change in mode of operation has occurred and the current conversion is therefore invalid.
- The MCU is reset or enters Low-Power Stop modes.
- The MCU enters Normal Stop mode with ADACK or Alternate Clock Sources not enabled.

When a conversion is aborted, the contents of the data registers, Rn, are not altered. The data registers continue to be the values transferred after the completion of the last successful conversion. If the conversion was aborted by a reset or Low-Power Stop modes, RA and Rn return to their reset states.

29.4.4.4 Power control

The ADC module remains in its idle state until a conversion is initiated. If ADACK is selected as the conversion clock source, but the asynchronous clock output is disabled, that is CFG2[ADACKEN]=0, the ADACK clock generator also remains in its idle state (disabled) until a conversion is initiated. If the asynchronous clock output is enabled, that is, CFG2[ADACKEN]=1, it remains active regardless of the state of the ADC or the MCU power mode.

Power consumption when the ADC is active can be reduced by setting CFG1[ADLPC]. This results in a lower maximum value for f_{ADCK} .

29.4.4.5 Sample time and total conversion time

For short sample, that is, when $CFG1[ADLSMP]=0$, there is a 2-cycle adder for first conversion over the base sample time of four ADCK cycles. For high-speed conversions, that is, when $CFG2[ADHSC]=1$, there is an additional 2-cycle adder on any conversion. The table below summarizes sample times for the possible ADC configurations.

| ADC configuration | | | Sample time (ADCK cycles) | |
|-------------------|--------------|-------------|---------------------------|------------|
| CFG1[ADLSMP] | CFG2[ADLSTS] | CFG2[ADHSC] | First or Single | Subsequent |
| 0 | X | 0 | 6 | 4 |
| 1 | 00 | 0 | 24 | |
| 1 | 01 | 0 | 16 | |
| 1 | 10 | 0 | 10 | |
| 1 | 11 | 0 | 6 | |
| 0 | X | 1 | 8 | 6 |
| 1 | 00 | 1 | 26 | |
| 1 | 01 | 1 | 18 | |
| 1 | 10 | 1 | 12 | |
| 1 | 11 | 1 | 8 | |

The total conversion time depends upon:

- The sample time as determined by $CFG1[ADLSMP]$ and $CFG2[ADLSTS]$
- The MCU bus frequency
- The conversion mode, as determined by $CFG1[MODE]$ and $SC1n[DIFF]$
- The high-speed configuration, that is, $CFG2[ADHSC]$
- The frequency of the conversion clock, that is, f_{ADCK} .

$CFG2[ADHSC]$ is used to configure a higher clock input frequency. This will allow faster overall conversion times. To meet internal ADC timing requirements, $CFG2[ADHSC]$ adds additional ADCK cycles. Conversions with $CFG2[ADHSC]=1$ take two more ADCK cycles. $CFG2[ADHSC]$ must be used when the ADCLK exceeds the limit for $CFG2[ADHSC]=0$.

After the module becomes active, sampling of the input begins.

1. $CFG1[ADLSMP]$ and $CFG2[ADLSTS]$ select between sample times based on the conversion mode that is selected.
2. When sampling is completed, the converter is isolated from the input channel and a successive approximation algorithm is applied to determine the digital value of the analog signal.
3. The result of the conversion is transferred to Rn upon completion of the conversion algorithm.

Functional description

If the bus frequency is less than f_{ADCK} , precise sample time for continuous conversions cannot be guaranteed when short sample is enabled, that is, when $CFG1[ADLSMP]=0$.

The maximum total conversion time is determined by the clock source chosen and the divide ratio selected. The clock source is selectable by $CFG1[ADICLK]$, and the divide ratio is specified by $CFG1[ADIV]$.

The maximum total conversion time for all configurations is summarized in the equation below. See the following tables for the variables referenced in the equation.

$$\text{ConversionTime} = \text{SFCAdder} + \text{AverageNum} \times (\text{BCT} + \text{LSTAdder} + \text{HSCAdder})$$

Equation 1. Conversion time equation

Table 29-3. Single or first continuous time adder (SFCAdder)

| CFG1[ADLSMP] | CFG2[ADACKEN] | CFG1[ADICLK] | Single or first continuous time adder (SFCAdder) |
|--------------|---------------|--------------|--|
| 1 | x | 0x, 10 | 3 ADCK cycles + 5 bus clock cycles |
| 1 | 1 | 11 | 3 ADCK cycles + 5 bus clock cycles ¹ |
| 1 | 0 | 11 | 5 μ s + 3 ADCK cycles + 5 bus clock cycles |
| 0 | x | 0x, 10 | 5 ADCK cycles + 5 bus clock cycles |
| 0 | 1 | 11 | 5 ADCK cycles + 5 bus clock cycles ¹ |
| 0 | 0 | 11 | 5 μ s + 5 ADCK cycles + 5 bus clock cycles |

1. To achieve this time, $CFG2[ADACKEN]$ must be 1 for at least 5 μ s prior to the conversion is initiated.

Table 29-4. Average number factor (AverageNum)

| SC3[AVGE] | SC3[AVGS] | Average number factor (AverageNum) |
|-----------|-----------|------------------------------------|
| 0 | xx | 1 |
| 1 | 00 | 4 |
| 1 | 01 | 8 |
| 1 | 10 | 16 |
| 1 | 11 | 32 |

Table 29-5. Base conversion time (BCT)

| Mode | Base conversion time (BCT) |
|------------------|----------------------------|
| 8b single-ended | 17 ADCK cycles |
| 9b differential | 27 ADCK cycles |
| 10b single-ended | 20 ADCK cycles |
| 11b differential | 30 ADCK cycles |
| 12b single-ended | 20 ADCK cycles |
| 13b differential | 30 ADCK cycles |

Table continues on the next page...

Table 29-5. Base conversion time (BCT) (continued)

| Mode | Base conversion time (BCT) |
|------------------|----------------------------|
| 16b single-ended | 25 ADCK cycles |
| 16b differential | 34 ADCK cycles |

Table 29-6. Long sample time adder (LSTAdder)

| CFG1[ADLSMP] | CFG2[ADLSTS] | Long sample time adder (LSTAdder) |
|--------------|--------------|-----------------------------------|
| 0 | xx | 0 ADCK cycles |
| 1 | 00 | 20 ADCK cycles |
| 1 | 01 | 12 ADCK cycles |
| 1 | 10 | 6 ADCK cycles |
| 1 | 11 | 2 ADCK cycles |

Table 29-7. High-speed conversion time adder (HSCAdder)

| CFG2[ADHSC] | High-speed conversion time adder (HSCAdder) |
|-------------|---|
| 0 | 0 ADCK cycles |
| 1 | 2 ADCK cycles |

Note

The ADCK frequency must be between f_{ADCK} minimum and f_{ADCK} maximum to meet ADC specifications.

29.4.4.6 Conversion time examples

The following examples use the [Equation 1 on page 654](#), and the information provided in [Table 29-3](#) through [Table 29-7](#).

29.4.4.6.1 Typical conversion time configuration

A typical configuration for ADC conversion is:

- 10-bit mode, with the bus clock selected as the input clock source
- The input clock divide-by-1 ratio selected
- Bus frequency of 8 MHz
- Long sample time disabled
- High-speed conversion disabled

The conversion time for a single conversion is calculated by using the [Equation 1 on page 654](#), and the information provided in [Table 29-3](#) through [Table 29-7](#). The table below lists the variables of [Equation 1 on page 654](#).

Table 29-8. Typical conversion time

| Variable | Time |
|------------|------------------------------------|
| SFCAdder | 5 ADCK cycles + 5 bus clock cycles |
| AverageNum | 1 |
| BCT | 20 ADCK cycles |
| LSTAdder | 0 |
| HSCAdder | 0 |

The resulting conversion time is generated using the parameters listed in the preceding table. Therefore, for a bus clock and an ADCK frequency equal to 8 MHz, the resulting conversion time is 3.75 μ s.

29.4.4.6.2 Long conversion time configuration

A configuration for long ADC conversion is:

- 16-bit differential mode with the bus clock selected as the input clock source
- The input clock divide-by-8 ratio selected
- Bus frequency of 8 MHz
- Long sample time enabled
- Configured for longest adder
- High-speed conversion disabled
- Average enabled for 32 conversions

The conversion time for this conversion is calculated by using the [Equation 1 on page 654](#), and the information provided in [Table 29-3](#) through [Table 29-7](#). The following table lists the variables of the [Equation 1 on page 654](#).

Table 29-9. Typical conversion time

| Variable | Time |
|------------|------------------------------------|
| SFCAdder | 3 ADCK cycles + 5 bus clock cycles |
| AverageNum | 32 |
| BCT | 34 ADCK cycles |
| LSTAdder | 20 ADCK cycles |
| HSCAdder | 0 |

The resulting conversion time is generated using the parameters listed in the preceding table. Therefore, for bus clock equal to 8 MHz and ADCK equal to 1 MHz, the resulting conversion time is 57.625 μ s, that is, AverageNum. This results in a total conversion time of 1.844 ms.

29.4.4.6.3 Short conversion time configuration

A configuration for short ADC conversion is:

- 8-bit Single-Ended mode with the bus clock selected as the input clock source
- The input clock divide-by-1 ratio selected
- Bus frequency of 20 MHz
- Long sample time disabled
- High-speed conversion enabled

The conversion time for this conversion is calculated by using the [Equation 1 on page 654](#), and the information provided in [Table 29-3](#) through [Table 29-7](#). The table below lists the variables of [Equation 1 on page 654](#).

Table 29-10. Typical conversion time

| Variable | Time |
|------------|------------------------------------|
| SFCAdder | 5 ADCK cycles + 5 bus clock cycles |
| AverageNum | 1 |
| BCT | 17 ADCK cycles |
| LSTAdder | 0 ADCK cycles |
| HSCAdder | 2 |

The resulting conversion time is generated using the parameters listed in the preceding table. Therefore, for bus clock and ADCK frequency equal to 20 MHz, the resulting conversion time is 1.45 μ s.

29.4.4.7 Hardware average function

The hardware average function can be enabled by setting SC3[AVGE]=1 to perform a hardware average of multiple conversions. The number of conversions is determined by the AVGS[1:0] bits, which can select 4, 8, 16, or 32 conversions to be averaged. While the hardware average function is in progress, SC2[ADACT] will be set.

After the selected input is sampled and converted, the result is placed in an accumulator from which an average is calculated once the selected number of conversions have been completed. When hardware averaging is selected, the completion of a single conversion will not set SC1n[COCO].

If the compare function is either disabled or evaluates true, after the selected number of conversions are completed, the average conversion result is transferred into the data result registers, Rn, and SC1n[COCO] is set. An ADC interrupt is generated upon the setting of SC1n[COCO] if the respective ADC interrupt is enabled, that is, SC1n[AIEN]=1.

Note

The hardware average function can perform conversions on a channel while the MCU is in Wait or Normal Stop modes. The ADC interrupt wakes the MCU when the hardware average is completed if SC1n[AIEN] is set.

29.4.5 Automatic compare function

The compare function can be configured to check whether the result is less than or greater-than-or-equal-to a single compare value, or, if the result falls within or outside a range determined by two compare values.

The compare mode is determined by SC2[ACFGT], SC2[ACREN], and the values in the compare value registers, CV1 and CV2. After the input is sampled and converted, the compare values in CV1 and CV2 are used as described in the following table. There are six Compare modes as shown in the following table.

Table 29-11. Compare modes

| SC2[ACFGT] | SC2[ACREN] | ADCCV1 relative to ADCCV2 | Function | Compare mode description |
|------------|------------|---------------------------|------------------------------------|--|
| 0 | 0 | — | Less than threshold | Compare true if the result is less than the CV1 registers. |
| 1 | 0 | — | Greater than or equal to threshold | Compare true if the result is greater than or equal to CV1 registers. |
| 0 | 1 | Less than or equal | Outside range, not inclusive | Compare true if the result is less than CV1 Or the result is greater than CV2. |
| 0 | 1 | Greater than | Inside range, not inclusive | Compare true if the result is less than CV1 And the result is greater than CV2. |
| 1 | 1 | Less than or equal | Inside range, inclusive | Compare true if the result is greater than or equal to CV1 And the result is less than or equal to CV2. |
| 1 | 1 | Greater than | Outside range, inclusive | Compare true if the result is greater than or equal to CV1 Or the result is less than or equal to CV2. |

With SC2[ACREN] =1, and if the value of CV1 is less than or equal to the value of CV2, then setting SC2[ACFGT] will select a trigger-if-inside-compare-range inclusive-of-endpoints function. Clearing SC2[ACFGT] will select a trigger-if-outside-compare-range, not-inclusive-of-endpoints function.

If CV1 is greater than CV2, setting SC2[ACFGT] will select a trigger-if-outside-compare-range, inclusive-of-endpoints function. Clearing SC2[ACFGT] will select a trigger-if-inside-compare-range, not-inclusive-of-endpoints function.

If the condition selected evaluates true, SC1n[COCO] is set.

Upon completion of a conversion while the compare function is enabled, if the compare condition is not true, SC1n[COCO] is not set and the conversion result data will not be transferred to the result register, Rn. If the hardware averaging function is enabled, the compare function compares the averaged result to the compare values. The same compare function definitions apply. An ADC interrupt is generated when SC1n[COCO] is set and the respective ADC interrupt is enabled, that is, SC1n[AIEN]=1.

Note

The compare function can monitor the voltage on a channel while the MCU is in Wait or Normal Stop modes. The ADC interrupt wakes the MCU when the compare condition is met.

29.4.6 Calibration function

The ADC contains a self-calibration function that is required to achieve the specified accuracy.

Calibration must be run, or valid calibration values written, after any reset and before a conversion is initiated. The calibration function sets the offset calibration value, the minus-side calibration values, and the plus-side calibration values. The offset calibration value is automatically stored in the ADC offset correction register (OFS), and the plus-side and minus-side calibration values are automatically stored in the ADC plus-side and minus-side calibration registers, CLPx and CLMx. The user must configure the ADC correctly prior to calibration, and must generate the plus-side and minus-side gain calibration results and store them in the ADC plus-side gain register (PG) after the calibration function completes.

Prior to calibration, the user must configure the ADC's clock source and frequency, low power configuration, voltage reference selection, sample time, and high speed configuration according to the application's clock source availability and needs. If the

application uses the ADC in a wide variety of configurations, the configuration for which the highest accuracy is required should be selected, or multiple calibrations can be done for the different configurations. For best calibration results:

- Set hardware averaging to maximum, that is, $SC3[AVGE]=1$ and $SC3[AVGS]=11$ for an average of 32
- Set ADC clock frequency f_{ADCK} less than or equal to 4 MHz
- $V_{REFH}=V_{DDA}$
- Calibrate at nominal voltage and temperature

The input channel, conversion mode continuous function, compare function, resolution mode, and differential/single-ended mode are all ignored during the calibration function.

To initiate calibration, the user sets $SC3[CAL]$ and the calibration will automatically begin if the $SC2[ADTRG]$ is 0. If $SC2[ADTRG]$ is 1, $SC3[CAL]$ will not get set and $SC3[CALF]$ will be set. While calibration is active, no ADC register can be written and no stop mode may be entered, or the calibration routine will be aborted causing $SC3[CAL]$ to clear and $SC3[CALF]$ to set. At the end of a calibration sequence, $SC1n[COCO]$ will be set. $SC1n[AIEN]$ can be used to allow an interrupt to occur at the end of a calibration sequence. At the end of the calibration routine, if $SC3[CALF]$ is not set, the automatic calibration routine is completed successfully.

To complete calibration, the user must generate the gain calibration values using the following procedure:

1. Initialize or clear a 16-bit variable in RAM.
2. Add the plus-side calibration results $CLP0$, $CLP1$, $CLP2$, $CLP3$, $CLP4$, and $CLPS$ to the variable.
3. Divide the variable by two.
4. Set the MSB of the variable.
5. The previous two steps can be achieved by setting the carry bit, rotating to the right through the carry bit on the high byte and again on the low byte.
6. Store the value in the plus-side gain calibration register PG .
7. Repeat the procedure for the minus-side gain calibration value.

When calibration is complete, the user may reconfigure and use the ADC as desired. A second calibration may also be performed, if desired, by clearing and again setting $SC3[CAL]$.

Overall, the calibration routine may take as many as 14k ADCK cycles and 100 bus cycles, depending on the results and the clock source chosen. For an 8 MHz clock source, this length amounts to about 1.7 ms. To reduce this latency, the calibration values, which are offset, plus-side and minus-side gain, and plus-side and minus-side calibration values, may be stored in flash memory after an initial calibration and recovered prior to the first ADC conversion. This method can reduce the calibration latency to 20 register store operations on all subsequent power, reset, or Low-Power Stop mode recoveries.

Further information on the calibration procedure can be found in the Calibration section of [AN3949: ADC16 Calibration Procedure and Programmable Delay Block Synchronization](#).

29.4.7 User-defined offset function

OFS contains the user-selected or calibration-generated offset error correction value.

This register is a 2's complement, left-justified. The value in OFS is subtracted from the conversion and the result is transferred into the result registers, Rn. If the result is greater than the maximum or less than the minimum result value, it is forced to the appropriate limit for the current mode of operation.

The formatting of the OFS is different from the data result register, Rn, to preserve the resolution of the calibration value regardless of the conversion mode selected. Lower order bits are ignored in lower resolution modes. For example, in 8-bit single-ended mode, OFS[14:7] are subtracted from D[7:0]; OFS[15] indicates the sign (negative numbers are effectively added to the result) and OFS[6:0] are ignored. The same bits are used in 9-bit differential mode because OFS[15] indicates the sign bit, which maps to D[8]. For 16-bit differential mode, OFS[15:0] are directly subtracted from the conversion result data D[15:0]. In 16-bit single-ended mode, there is no field in the OFS corresponding to the least significant result D[0], so odd values, such as -1 or +1, cannot be subtracted from the result.

OFS is automatically set according to calibration requirements once the self-calibration sequence is done, that is, SC3[CAL] is cleared. The user may write to OFS to override the calibration result if desired. If the OFS is written by the user to a value that is different from the calibration value, the ADC error specifications may not be met. Storing the value generated by the calibration function in memory before overwriting with a user-specified value is recommended.

Note

There is an effective limit to the values of offset that can be set by the user. If the magnitude of the offset is too high, the results of the conversions will cap off at the limits.

The offset calibration function may be employed by the user to remove application offsets or DC bias values. OFS may be written with a number in 2's complement format and this offset will be subtracted from the result, or hardware averaged value. To add an offset, store the negative offset in 2's complement format and the effect will be an addition. An offset correction that results in an out-of-range value will be forced to the minimum or maximum value. The minimum value for single-ended conversions is 0x0000; for a differential conversion it is 0x8000.

To preserve accuracy, the calibrated offset value initially stored in OFS must be added to the user-defined offset. For applications that may change the offset repeatedly during operation, store the initial offset calibration value in flash so it can be recovered and added to any user offset adjustment value and the sum stored in OFS.

29.4.8 Temperature sensor

The ADC module includes a temperature sensor whose output is connected to one of the ADC analog channel inputs.

The following equation provides an approximate transfer function of the temperature sensor.

$$\text{Temp} = 25 - \left((V_{\text{TEMP}} - V_{\text{TEMP25}}) \div m \right)$$

Equation 2. Approximate transfer function of the temperature sensor

where:

- V_{TEMP} is the voltage of the temperature sensor channel at the ambient temperature.
- V_{TEMP25} is the voltage of the temperature sensor channel at 25 °C.
- m is referred as temperature sensor slope in the device data sheet. It is the hot or cold voltage versus temperature slope in V/°C.

For temperature calculations, use the V_{TEMP25} and temperature sensor slope values from the ADC Electricals table.

In application code, the user reads the temperature sensor channel, calculates V_{TEMP} , and compares to V_{TEMP25} . If V_{TEMP} is greater than V_{TEMP25} the cold slope value is applied in the preceding equation. If V_{TEMP} is less than V_{TEMP25} , the hot slope value is applied in the preceding equation. ADC Electricals table may only specify one temperature sensor slope value. In that case, the user could use the same slope for the calculation across the operational temperature range.

For more information on using the temperature sensor, see the application note titled *Temperature Sensor for the HCS08 Microcontroller Family* (document AN3031).

29.4.9 MCU wait mode operation

Wait mode is a lower-power consumption Standby mode from which recovery is fast because the clock sources remain active.

If a conversion is in progress when the MCU enters Wait mode, it continues until completion. Conversions can be initiated while the MCU is in Wait mode by means of the hardware trigger or if continuous conversions are enabled.

The bus clock, bus clock divided by two; and ADACK are available as conversion clock sources while in Wait mode. The use of ALTCLK as the conversion clock source in Wait is dependent on the definition of ALTCLK for this MCU. See the Chip Configuration information on ALTCLK specific to this MCU.

If the compare and hardware averaging functions are disabled, a conversion complete event sets SC1n[COCO] and generates an ADC interrupt to wake the MCU from Wait mode if the respective ADC interrupt is enabled, that is, when SC1n[AIEN]=1. If the hardware averaging function is enabled, SC1n[COCO] will set, and generate an interrupt if enabled, when the selected number of conversions are completed. If the compare function is enabled, SC1n[COCO] will set, and generate an interrupt if enabled, only if the compare conditions are met. If a single conversion is selected and the compare trigger is not met, the ADC will return to its idle state and cannot wake the MCU from Wait mode unless a new conversion is initiated by the hardware trigger.

29.4.10 MCU Normal Stop mode operation

Stop mode is a low-power consumption Standby mode during which most or all clock sources on the MCU are disabled.

29.4.10.1 Normal Stop mode with ADACK disabled

If the asynchronous clock, ADACK, is not selected as the conversion clock, executing a stop instruction aborts the current conversion and places the ADC in its Idle state. The contents of the ADC registers, including Rn, are unaffected by Normal Stop mode. After exiting from Normal Stop mode, a software or hardware trigger is required to resume conversions.

29.4.10.2 Normal Stop mode with ADACK enabled

If ADACK is selected as the conversion clock, the ADC continues operation during Normal Stop mode. See the chip-specific ADC information for configuration information for this device.

If a conversion is in progress when the MCU enters Normal Stop mode, it continues until completion. Conversions can be initiated while the MCU is in Normal Stop mode by means of the hardware trigger or if continuous conversions are enabled.

If the compare and hardware averaging functions are disabled, a conversion complete event sets SC1n[COCO] and generates an ADC interrupt to wake the MCU from Normal Stop mode if the respective ADC interrupt is enabled, that is, when SC1n[AIEN]=1. The result register, Rn, will contain the data from the first completed conversion that occurred during Normal Stop mode. If the hardware averaging function is enabled, SC1n[COCO] will set, and generate an interrupt if enabled, when the selected number of conversions are completed. If the compare function is enabled, SC1n[COCO] will set, and generate an interrupt if enabled, only if the compare conditions are met. If a single conversion is selected and the compare is not true, the ADC will return to its idle state and cannot wake the MCU from Normal Stop mode unless a new conversion is initiated by another hardware trigger.

29.4.11 MCU Low-Power Stop mode operation

The ADC module is automatically disabled when the MCU enters Low-Power Stop mode.

All module registers contain their reset values following exit from Low-Power Stop mode. Therefore, the module must be re-enabled and re-configured following exit from Low-Power Stop mode.

NOTE

For the chip specific modes of operation, see the power management information for the device.

29.5 Initialization information

This section gives an example that provides some basic direction on how to initialize and configure the ADC module.

The user can configure the module for 16-bit, 12-bit, 10-bit, or 8-bit single-ended resolution or 16-bit, 13-bit, 11-bit, or 9-bit differential resolution, single or continuous conversion, and a polled or interrupt approach, among many other options. For information used in this example, refer to [Table 29-6](#), [Table 29-7](#), and [Table 29-8](#).

Note

Hexadecimal values are designated by a preceding 0x, binary values designated by a preceding %, and decimal values have no preceding character.

29.5.1 ADC module initialization example

29.5.1.1 Initialization sequence

Before the ADC module can be used to complete conversions, an initialization procedure must be performed. A typical sequence is:

1. Calibrate the ADC by following the calibration instructions in [Calibration function](#).
2. Update CFG to select the input clock source and the divide ratio used to generate ADCK. This register is also used for selecting sample time and low-power configuration.
3. Update SC2 to select the conversion trigger, hardware or software, and compare function options, if enabled.
4. Update SC3 to select whether conversions will be continuous or completed only once (ADCO) and whether to perform hardware averaging.
5. Update SC1:SC1n registers to select whether conversions will be single-ended or differential and to enable or disable conversion complete interrupts. Also, select the input channel which can be used to perform conversions.

29.5.1.2 Pseudo-code example

In this example, the ADC module is set up with interrupts enabled to perform a single 10-bit conversion at low-power with a long sample time on input channel 1, where ADCK is derived from the bus clock divided by 1.

CFG1 = 0x98 (%10011000)

| | | | |
|---------|--------|----|---|
| Bit 7 | ADLPC | 1 | Configures for low power, lowers maximum clock speed. |
| Bit 6:5 | ADIV | 00 | Sets the ADCK to the input clock ÷ 1. |
| Bit 4 | ADLSMP | 1 | Configures for long sample time. |
| Bit 3:2 | MODE | 10 | Selects the single-ended 10-bit conversion, differential 11-bit conversion. |
| Bit 1:0 | ADICLK | 00 | Selects the bus clock. |

SC2 = 0x00 (%00000000)

| | | | |
|---------|--------|----|--|
| Bit 7 | ADACT | 0 | Flag indicates if a conversion is in progress. |
| Bit 6 | ADTRG | 0 | Software trigger selected. |
| Bit 5 | ACFE | 0 | Compare function disabled. |
| Bit 4 | ACFGT | 0 | Not used in this example. |
| Bit 3 | ACREN | 0 | Compare range disabled. |
| Bit 2 | DMAEN | 0 | DMA request disabled. |
| Bit 1:0 | REFSEL | 00 | Selects default voltage reference pin pair (External pins V _{REFH} and V _{REFL}). |

SC1A = 0x41 (%01000001)

| | | | |
|---------|------|-------|--|
| Bit 7 | COCO | 0 | Read-only flag which is set when a conversion completes. |
| Bit 6 | AIEN | 1 | Conversion complete interrupt enabled. |
| Bit 5 | DIFF | 0 | Single-ended conversion selected. |
| Bit 4:0 | ADCH | 00001 | Input channel 1 selected as ADC input channel. |

RA = 0xxx

Holds results of conversion.

CV = 0xxx

Holds compare value when compare function enabled.

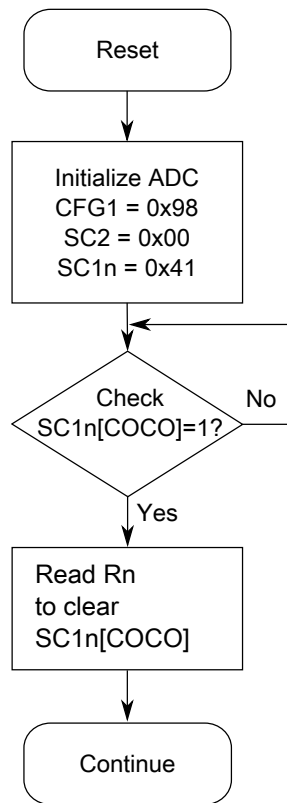

Figure 29-2. Initialization flowchart example

29.6 Application information

The ADC has been designed to be integrated into a microcontroller for use in embedded control applications requiring an ADC.

For guidance on selecting optimum external component values and converter parameters see [AN4373: Cookbook for SAR ADC Measurements](#).

29.6.1 External pins and routing

29.6.1.1 Analog supply pins

Depending on the device, the analog power and ground supplies, V_{DDA} and V_{SSA} , of the ADC module are available as:

- V_{DDA} and V_{SSA} available as separate pins—When available on a separate pin, both V_{DDA} and V_{SSA} must be connected to the same voltage potential as their corresponding MCU digital supply, V_{DD} and V_{SS} , and must be routed carefully for maximum noise immunity and bypass capacitors placed as near as possible to the package.
- V_{SSA} is shared on the same pin as the MCU digital V_{SS} .
- V_{SSA} and V_{DDA} are shared with the MCU digital supply pins—In these cases, there are separate pads for the analog supplies bonded to the same pin as the corresponding digital supply so that some degree of isolation between the supplies is maintained.

If separate power supplies are used for analog and digital power, the ground connection between these supplies must be at the V_{SSA} pin. This must be the only ground connection between these supplies, if possible. V_{SSA} makes a good single point ground location.

29.6.1.2 Analog voltage reference pins

In addition to the analog supplies, the ADC module has connections for two reference voltage inputs used by the converter:

- V_{REFSH} is the high reference voltage for the converter.
- V_{REFSL} is the low reference voltage for the converter.

The ADC can be configured to accept one of two voltage reference pairs for V_{REFSH} and V_{REFSL} . Each pair contains a positive reference and a ground reference. The two pairs are external, V_{REFH} and V_{REFL} and alternate, V_{ALTH} and V_{ALTTL} . These voltage references are selected using $SC2[REFSEL]$. The alternate voltage reference pair, V_{ALTH} and V_{ALTTL} , may select additional external pins or internal sources based on MCU configuration. See the chip configuration information on the voltage references specific to this MCU.

In some packages, the external or alternate pairs are connected in the package to V_{DDA} and V_{SSA} , respectively. One of these positive references may be shared on the same pin as V_{DDA} on some devices. One of these ground references may be shared on the same pin as V_{SSA} on some devices.

If externally available, the positive reference may be connected to the same potential as V_{DDA} or may be driven by an external source to a level between the minimum Ref Voltage High and the V_{DDA} potential. The positive reference must never exceed V_{DDA} . If externally available, the ground reference must be connected to the same voltage potential as V_{SSA} . The voltage reference pairs must be routed carefully for maximum noise immunity and bypass capacitors placed as near as possible to the package.

AC current in the form of current spikes required to supply charge to the capacitor array at each successive approximation step is drawn through the V_{REFH} and V_{REFL} loop. The best external component to meet this current demand is a 0.1 μF capacitor with good

high-frequency characteristics. This capacitor is connected between V_{REFH} and V_{REFL} and must be placed as near as possible to the package pins. Resistance in the path is not recommended because the current causes a voltage drop that could result in conversion errors. Inductance in this path must be minimum, that is, parasitic only.

29.6.1.3 Analog input pins

The external analog inputs are typically shared with digital I/O pins on MCU devices.

Empirical data shows that capacitors on the analog inputs improve performance in the presence of noise or when the source impedance is high. Use of 0.01 μF capacitors with good high-frequency characteristics is sufficient. These capacitors are not necessary in all cases, but when used, they must be placed as near as possible to the package pins and be referenced to V_{SSA} .

For proper conversion, the input voltage must fall between V_{REFH} and V_{REFL} . If the input is equal to or exceeds V_{REFH} , the converter circuit converts the signal to 0xFFF, which is full scale 12-bit representation, 0x3FF, which is full scale 10-bit representation, or 0xFF, which is full scale 8-bit representation. If the input is equal to or less than V_{REFL} , the converter circuit converts it to 0x000. Input voltages between V_{REFH} and V_{REFL} are straight-line linear conversions. There is a brief current associated with V_{REFL} when the sampling capacitor is charging.

For minimal loss of accuracy due to current injection, pins adjacent to the analog input pins must not be transitioning during conversions.

29.6.2 Sources of error

29.6.2.1 Sampling error

For proper conversions, the input must be sampled long enough to achieve the proper accuracy.

$$RAS + RADIN = SC / (FMAX * NUMTAU * CADIN)$$

Figure 29-3. Sampling equation

Where:

RAS = External analog source resistance

SC = Number of ADCK cycles used during sample window

CADIN = Internal ADC input capacitance

NUMTAU = $-\ln(\text{LSBERR} / 2^N)$

LSBERR = value of acceptable sampling error in LSBs

N = 8 in 8-bit mode, 10 in 10-bit mode, 12 in 12-bit mode or 16 in 16-bit mode

Higher source resistances or higher-accuracy sampling is possible by setting CFG1[ADLSMP] and changing CFG2[ADLSTS] to increase the sample window, or decreasing ADCK frequency to increase sample time.

29.6.2.2 Pin leakage error

Leakage on the I/O pins can cause conversion error if the external analog source resistance, R_{AS} , is high. If this error cannot be tolerated by the application, keep R_{AS} lower than $V_{REFH} / (4 \times I_{LEAK} \times 2^N)$ for less than 1/4 LSB leakage error, where N = 8 in 8-bit mode, 10 in 10-bit mode, 12 in 12-bit mode, or 16 in 16-bit mode.

29.6.2.3 Noise-induced errors

System noise that occurs during the sample or conversion process can affect the accuracy of the conversion. The ADC accuracy numbers are guaranteed as specified only if the following conditions are met:

- There is a 0.1 μF low-ESR capacitor from V_{REFH} to V_{REFL} .
- There is a 0.1 μF low-ESR capacitor from V_{DDA} to V_{SSA} .
- If inductive isolation is used from the primary supply, an additional 1 μF capacitor is placed from V_{DDA} to V_{SSA} .
- V_{SSA} , and V_{REFL} , if connected, is connected to V_{SS} at a quiet point in the ground plane.
- Operate the MCU in Wait or Normal Stop mode before initiating (hardware-triggered conversions) or immediately after initiating (hardware- or software-triggered conversions) the ADC conversion.

- For software triggered conversions, immediately follow the write to SC1 with a Wait instruction or Stop instruction.
- For Normal Stop mode operation, select ADACK as the clock source. Operation in Normal Stop reduces V_{DD} noise but increases effective conversion time due to stop recovery.
- There is no I/O switching, input or output, on the MCU during the conversion.

There are some situations where external system activity causes radiated or conducted noise emissions or excessive V_{DD} noise is coupled into the ADC. In these situations, or when the MCU cannot be placed in Wait or Normal Stop mode, or I/O activity cannot be halted, the following actions may reduce the effect of noise on the accuracy:

- Place a 0.01 μF capacitor (C_{AS}) on the selected input channel to V_{REFL} or V_{SSA} . This improves noise issues, but affects the sample rate based on the external analog source resistance.
- Average the result by converting the analog input many times in succession and dividing the sum of the results. Four samples are required to eliminate the effect of a 1 LSB, one-time error.
- Reduce the effect of synchronous noise by operating off the asynchronous clock, that is, ADACK, and averaging. Noise that is synchronous to ADCK cannot be averaged out.

29.6.2.4 Code width and quantization error

The ADC quantizes the ideal straight-line transfer function into 65536 steps in the 16-bit mode. Each step ideally has the same height, that is, 1 code, and width. The width is defined as the delta between the transition points to one code and the next. The ideal code width for an N-bit converter, where N can be 16, 12, 10, or 8, defined as 1 LSB, is:

$$1\text{LSB} = (V_{REFH}) / 2^N$$

Equation 3. Ideal code width for an N-bit converter

There is an inherent quantization error due to the digitization of the result. For 8-bit, 10-bit, or 12-bit conversions, the code transitions when the voltage is at the midpoint between the points where the straight line transfer function is exactly represented by the actual transfer function. Therefore, the quantization error will be $\pm 1/2$ LSB in 8-bit, 10-bit, or 12-bit modes. As a consequence, however, the code width of the first (0x000) conversion is only 1/2 LSB and the code width of the last (0xFF or 0x3FF) is 1.5 LSB.

For 16-bit conversions, the code transitions only after the full code width is present, so the quantization error is -1 LSB to 0 LSB and the code width of each step is 1 LSB.

29.6.2.5 Linearity errors

The ADC may also exhibit non-linearity of several forms. Every effort has been made to reduce these errors, but the system designers must be aware of these errors because they affect overall accuracy:

- Zero-scale error (E_{ZS}), sometimes called offset: This error is defined as the difference between the actual code width of the first conversion and the ideal code width. This is 1/2 LSB in 8-bit, 10-bit, or 12-bit modes and 1 LSB in 16-bit mode. If the first conversion is 0x001, the difference between the actual 0x001 code width and its ideal (1 LSB) is used.
- Full-scale error (E_{FS}): This error is defined as the difference between the actual code width of the last conversion and the ideal code width. This is 1.5 LSB in 8-bit, 10-bit, or 12-bit modes and 1 LSB in 16-bit mode. If the last conversion is 0x3FE, the difference between the actual 0x3FE code width and its ideal (1 LSB) is used.
- Differential non-linearity (DNL): This error is defined as the worst-case difference between the actual code width and the ideal code width for all conversions.
- Integral non-linearity (INL): This error is defined as the highest-value or absolute value that the running sum of DNL achieves. More simply, this is the worst-case difference of the actual transition voltage to a given code and its corresponding ideal transition voltage, for all codes.
- Total unadjusted error (TUE): This error is defined as the difference between the actual transfer function and the ideal straight-line transfer function and includes all forms of error.

29.6.2.6 Code jitter, non-monotonicity, and missing codes

Analog-to-digital converters are susceptible to three special forms of error:

- Code jitter: Code jitter occurs when a given input voltage converts to one of the two values when sampled repeatedly. Ideally, when the input voltage is infinitesimally smaller than the transition voltage, the converter yields the lower code, and vice-versa. However, even small amounts of system noise can cause the converter to be indeterminate, between two codes, for a range of input voltages around the transition voltage.

This error may be reduced by repeatedly sampling the input and averaging the result. Additionally, the techniques discussed in [Noise-induced errors](#) reduces this error.

- **Non-monotonicity:** Non-monotonicity occurs when, except for code jitter, the converter converts to a lower code for a higher input voltage.
- **Missing codes:** Missing codes are those values never converted for any input value.

In 8-bit or 10-bit mode, the ADC is guaranteed to be monotonic and have no missing codes.

Chapter 30

Comparator (CMP)

The Comparator module (CMP) provides a circuit for comparing two analog input voltages. The comparator circuit is designed to operate across the full supply voltage range (rail-to-rail operation) and supports programmable hysteresis control. The output of the comparator can be samples, windowed, or digitally filtered.

30.1 Introduction

The comparator (CMP) module provides a circuit for comparing two analog input voltages. The comparator circuit is designed to operate across the full range of the supply voltage, known as rail-to-rail operation.

The Analog MUX (ANMUX) provides a circuit for selecting an analog input signal from eight channels. One signal is provided by the 6-bit digital-to-analog converter (DAC). The mux circuit is designed to operate across the full range of the supply voltage.

The 6-bit DAC is 64-tap resistor ladder network which provides a selectable voltage reference for applications where voltage reference is needed. The 64-tap resistor ladder network divides the supply reference V_{in} into 64 voltage levels. A 6-bit digital signal input selects the output voltage level, which varies from V_{in} to $V_{in}/64$. V_{in} can be selected from two voltage sources, V_{in1} and V_{in2} . The 6-bit DAC from a comparator is available as an on-chip internal signal only and is not available externally to a pin.

30.1.1 CMP features

The CMP has the following features:

- Operational over the entire supply range
- Inputs may range from rail to rail
- Programmable hysteresis control

- Selectable interrupt on rising-edge, falling-edge, or both rising or falling edges of the comparator output
- Selectable inversion on comparator output
- Capability to produce a wide range of outputs such as:
 - Sampled
 - Digitally filtered:
 - Filter can be bypassed
 - Can be clocked via scaled bus clock
- External hysteresis can be used at the same time that the output filter is used for internal functions
- Two software selectable performance levels:
 - Shorter propagation delay at the expense of higher power
 - Low power, with longer propagation delay
- DMA transfer support
 - A comparison event can be selected to trigger a DMA transfer
- Functional in all modes of operation except VLLS0
- The filter functions are not available in the following modes:
 - Stop
 - VLPS
 - LLS
 - VLLS_x

30.1.2 6-bit DAC key features

The 6-bit DAC has the following features:

- 6-bit resolution
- Selectable supply reference source
- Power Down mode to conserve power when not in use
- Option to route the output to internal comparator input

30.1.3 ANMUX key features

The ANMUX has the following features:

- Two 8-to-1 channel mux
- Operational over the entire supply range

30.1.4 CMP, DAC and ANMUX diagram

The following figure shows the block diagram for the High-Speed Comparator, DAC, and ANMUX modules.

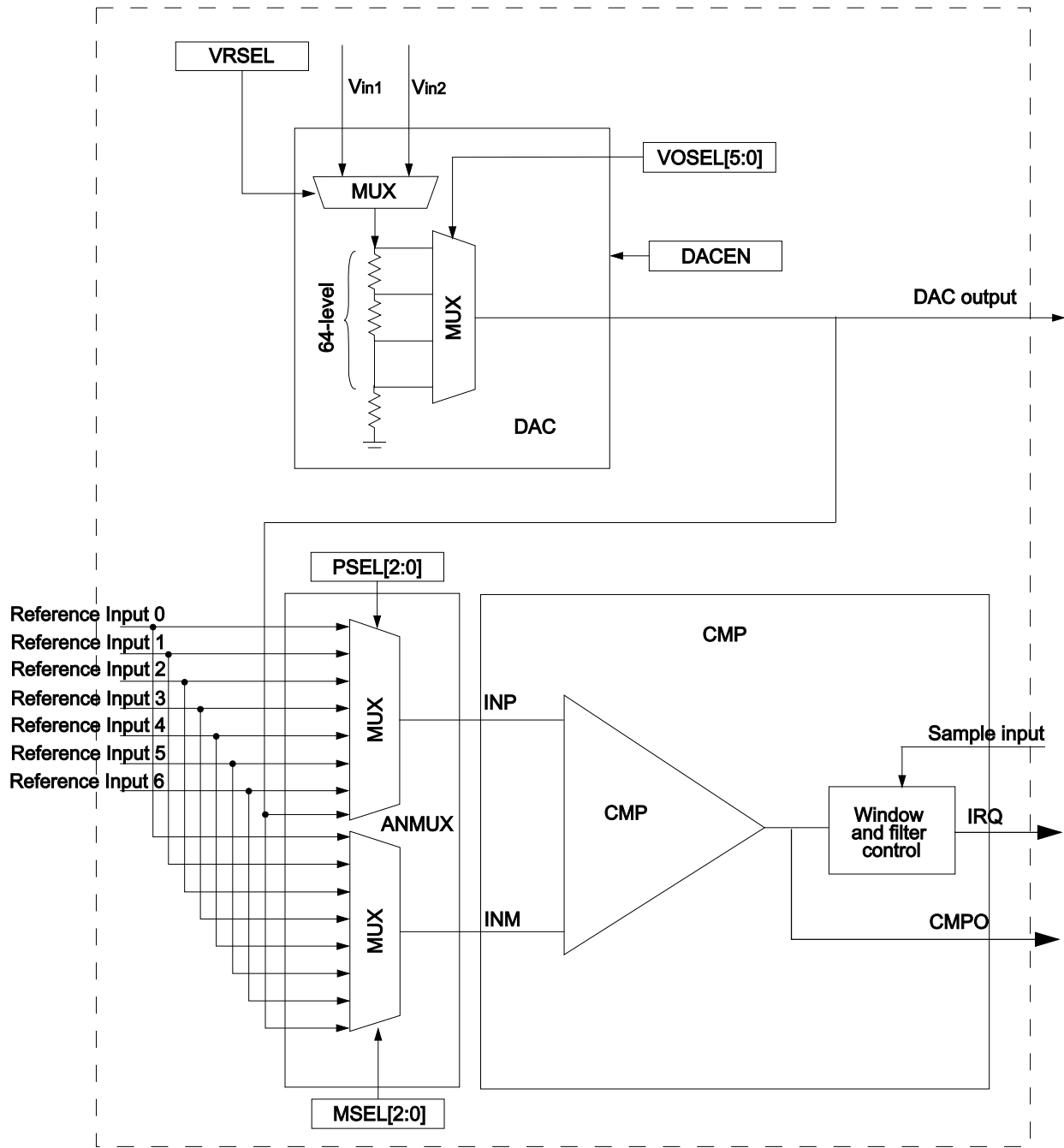

Figure 30-1. CMP, DAC and ANMUX block diagram

30.1.5 CMP block diagram

The following figure shows the block diagram for the CMP module.

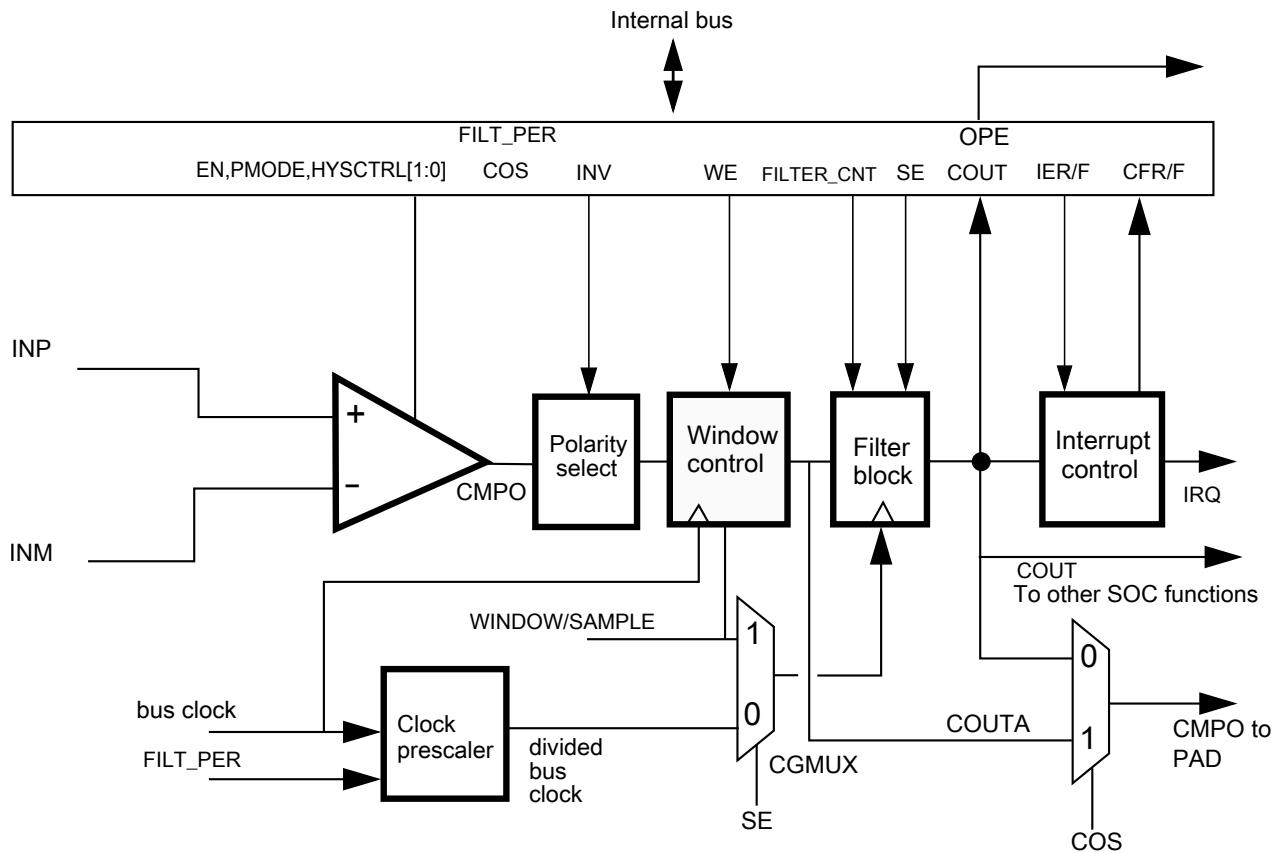

Figure 30-2. Comparator module block diagram

In the CMP block diagram:

- The Window Control block is bypassed when $CR1[WE] = 0$
- The Filter block is bypassed when not in use.
- The Filter block acts as a simple sampler if the filter is bypassed and $CR0[FILTER_CNT]$ is set to $0x01$.
- The Filter block filters based on multiple samples when the filter is bypassed and $CR0[FILTER_CNT]$ is set greater than $0x01$.
 - $CR1[SE] = 0$, the divided bus clock is used as sampling clock
- If enabled, the Filter block will incur up to one bus clock additional latency penalty on COUT due to the fact that COUT, which is crossing clock domain boundaries, must be resynchronized to the bus clock.

30.2 Memory map/register definitions

CMP memory map

| Absolute address (hex) | Register name | Width (in bits) | Access | Reset value | Section/page |
|------------------------|--|-----------------|--------|-------------|----------------------------|
| 4007_3000 | CMP Control Register 0 (CMP0_CR0) | 8 | R/W | 00h | 30.2.1/680 |
| 4007_3001 | CMP Control Register 1 (CMP0_CR1) | 8 | R/W | 00h | 30.2.2/681 |
| 4007_3002 | CMP Filter Period Register (CMP0_FPR) | 8 | R/W | 00h | 30.2.3/682 |
| 4007_3003 | CMP Status and Control Register (CMP0_SCR) | 8 | R/W | 00h | 30.2.4/683 |
| 4007_3004 | DAC Control Register (CMP0_DACCR) | 8 | R/W | 00h | 30.2.5/684 |
| 4007_3005 | MUX Control Register (CMP0_MUXCR) | 8 | R/W | 00h | 30.2.6/684 |

30.2.1 CMP Control Register 0 (CMPx_CR0)

Address: 4007_3000h base + 0h offset = 4007_3000h

| Bit | 7 | 6 | 5 | 4 | 3 | 2 | 1 | 0 |
|-------|----------|------------|---|----------|---|---|----------|---|
| Read | 0 | FILTER_CNT | | | 0 | 0 | HYSTCTR | |
| Write | [Shaded] | | | [Shaded] | | | [Shaded] | |
| Reset | 0 | 0 | 0 | 0 | 0 | 0 | 0 | 0 |

CMPx_CR0 field descriptions

| Field | Description |
|-------------------|--|
| 7 Reserved | This field is reserved. This read-only field is reserved and always has the value 0. |
| 6-4 FILTER_CNT | Filter Sample Count Represents the number of consecutive samples that must agree prior to the comparator output filter accepting a new output state. For information regarding filter programming and latency, see the Functional description . 000 Filter is disabled. SE = 0, COUT = COUTA. 001 One sample must agree. The comparator output is simply sampled. 010 2 consecutive samples must agree. 011 3 consecutive samples must agree. 100 4 consecutive samples must agree. 101 5 consecutive samples must agree. 110 6 consecutive samples must agree. 111 7 consecutive samples must agree. |
| 3 Reserved | This field is reserved. This read-only field is reserved and always has the value 0. |
| 2 Reserved | This field is reserved. This read-only field is reserved and always has the value 0. |
| HYSTCTR | Comparator hard block hysteresis control Defines the programmable hysteresis level. The hysteresis values associated with each level are device-specific. See the Data Sheet of the device for the exact values. 00 Level 0 |

Table continues on the next page...

CMPx_CR0 field descriptions (continued)

| Field | Description |
|-------|-------------|
| 01 | Level 1 |
| 10 | Level 2 |
| 11 | Level 3 |

30.2.2 CMP Control Register 1 (CMPx_CR1)

Address: 4007_3000h base + 1h offset = 4007_3001h

| Bit | 7 | 6 | 5 | 4 | 3 | 2 | 1 | 0 |
|-------|----|----|-------|-------|-----|-----|-----|----|
| Read | SE | WE | TRIGM | PMODE | INV | COS | OPE | EN |
| Write | | | | | | | | |
| Reset | 0 | 0 | 0 | 0 | 0 | 0 | 0 | 0 |

CMPx_CR1 field descriptions

| Field | Description |
|------------|---|
| 7 SE | <p>Sample Enable</p> <p>SE must be clear to 0 and usage of sample operation is limited to a divided version of the bus clock.</p> <p>0 Sampling mode is not selected. 1 Sampling mode is selected.</p> |
| 6 WE | <p>Windowing Enable</p> <p>The CMP does not support window compare function and a 0 must always be written to WE.</p> <p>0 Windowing mode is not selected. 1 Windowing mode is selected.</p> |
| 5 TRIGM | <p>Trigger Mode Enable</p> <p>CMP and DAC are configured to CMP Trigger mode when CMP_CR1[TRIGM] is set to 1. In addition, the CMP should be enabled. If the DAC is to be used as a reference to the CMP, it should also be enabled.</p> <p>CMP Trigger mode depends on an external timer resource to periodically enable the CMP and 6-bit DAC in order to generate a triggered compare.</p> <p>Upon setting TRIGM, the CMP and DAC are placed in a standby state until an external timer resource trigger is received.</p> <p>See the chip configuration for details about the external timer resource.</p> <p>0 Trigger mode is disabled. 1 Trigger mode is enabled.</p> |
| 4 PMODE | <p>Power Mode Select</p> <p>See the electrical specifications table in the device Data Sheet for details.</p> <p>0 Low-Speed (LS) Comparison mode selected. In this mode, CMP has slower output propagation delay and lower current consumption. 1 High-Speed (HS) Comparison mode selected. In this mode, CMP has faster output propagation delay and higher current consumption.</p> |

Table continues on the next page...

CMPx_CR1 field descriptions (continued)

| Field | Description |
|----------|--|
| 3 INV | <p>Comparator INVERT</p> <p>Allows selection of the polarity of the analog comparator function. It is also driven to the COUT output, on both the device pin and as SCR[COUT], when OPE=0.</p> <p>0 Does not invert the comparator output. 1 Inverts the comparator output.</p> |
| 2 COS | <p>Comparator Output Select</p> <p>0 Set the filtered comparator output (CMPO) to equal COUT. 1 Set the unfiltered comparator output (CMPO) to equal COUTA.</p> |
| 1 OPE | <p>Comparator Output Pin Enable</p> <p>0 CMPO is not available on the associated CMPO output pin. If the comparator does not own the pin, this field has no effect. 1 CMPO is available on the associated CMPO output pin.</p> <p>The comparator output (CMPO) is driven out on the associated CMPO output pin if the comparator owns the pin. If the comparator does not own the field, this bit has no effect.</p> |
| 0 EN | <p>Comparator Module Enable</p> <p>Enables the Analog Comparator module. When the module is not enabled, it remains in the off state, and consumes no power. When the user selects the same input from analog mux to the positive and negative port, the comparator is disabled automatically.</p> <p>0 Analog Comparator is disabled. 1 Analog Comparator is enabled.</p> |

30.2.3 CMP Filter Period Register (CMPx_FPR)

Address: 4007_3000h base + 2h offset = 4007_3002h

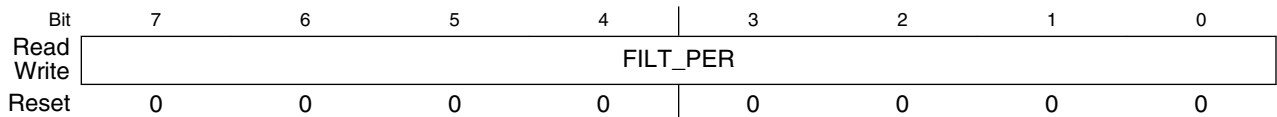

CMPx_FPR field descriptions

| Field | Description |
|----------|---|
| FILT_PER | <p>Filter Sample Period</p> <p>Specifies the sampling period, in bus clock cycles, of the comparator output filter, when CR1[SE]=0. Setting FILT_PER to 0x0 disables the filter. Filter programming and latency details appear in the Functional description.</p> |

30.2.4 CMP Status and Control Register (CMPx_SCR)

Address: 4007_3000h base + 3h offset = 4007_3003h

| Bit | 7 | 6 | 5 | 4 | 3 | 2 | 1 | 0 |
|-------|---|-------|---|-----|-----|-----|-----|------|
| Read | 0 | DMAEN | 0 | IER | IEF | CFR | CFF | COUT |
| Write | | | | | | w1c | w1c | |
| Reset | 0 | 0 | 0 | 0 | 0 | 0 | 0 | 0 |

CMPx_SCR field descriptions

| Field | Description |
|---------------|--|
| 7 Reserved | This field is reserved. This read-only field is reserved and always has the value 0. |
| 6 DMAEN | DMA Enable Control Enables the DMA transfer triggered from the CMP module. When this field is set, a DMA request is asserted when CFR or CFF is set. 0 DMA is disabled. 1 DMA is enabled. |
| 5 Reserved | This field is reserved. This read-only field is reserved and always has the value 0. |
| 4 IER | Comparator Interrupt Enable Rising Enables the CFR interrupt from the CMP. When this field is set, an interrupt will be asserted when CFR is set. 0 Interrupt is disabled. 1 Interrupt is enabled. |
| 3 IEF | Comparator Interrupt Enable Falling Enables the CFF interrupt from the CMP. When this field is set, an interrupt will be asserted when CFF is set. 0 Interrupt is disabled. 1 Interrupt is enabled. |
| 2 CFR | Analog Comparator Flag Rising Detects a rising-edge on COUT, when set, during normal operation. CFR is cleared by writing 1 to it. During Stop modes, CFR is level sensitive . 0 Rising-edge on COUT has not been detected. 1 Rising-edge on COUT has occurred. |
| 1 CFF | Analog Comparator Flag Falling Detects a falling-edge on COUT, when set, during normal operation. CFF is cleared by writing 1 to it. During Stop modes, CFF is level sensitive . 0 Falling-edge on COUT has not been detected. 1 Falling-edge on COUT has occurred. |

Table continues on the next page...

CMPx_SCR field descriptions (continued)

| Field | Description |
|-----------|---|
| 0 COUT | Analog Comparator Output Returns the current value of the Analog Comparator output, when read. The field is reset to 0 and will read as CR1[INV] when the Analog Comparator module is disabled, that is, when CR1[EN] = 0. Writes to this field are ignored. |

30.2.5 DAC Control Register (CMPx_DACCR)

Address: 4007_3000h base + 4h offset = 4007_3004h

| | | | | | | | | |
|-------|-------|-------|-------|---|---|---|---|---|
| Bit | 7 | 6 | 5 | 4 | 3 | 2 | 1 | 0 |
| Read | DACEN | VRSEL | VOSEL | | | | | |
| Write | | | | | | | | |
| Reset | 0 | 0 | 0 | 0 | 0 | 0 | 0 | 0 |

CMPx_DACCR field descriptions

| Field | Description |
|------------|---|
| 7 DACEN | DAC Enable Enables the DAC. When the DAC is disabled, it is powered down to conserve power. 0 DAC is disabled. 1 DAC is enabled. |
| 6 VRSEL | Supply Voltage Reference Source Select 0 V_{in1} is selected as resistor ladder network supply reference. 1 V_{in2} is selected as resistor ladder network supply reference. |
| VOSEL | DAC Output Voltage Select Selects an output voltage from one of 64 distinct levels. $DACO = (V_{in} / 64) * (VOSEL[5:0] + 1)$, so the DACO range is from $V_{in} / 64$ to V_{in} . |

30.2.6 MUX Control Register (CMPx_MUXCR)

Address: 4007_3000h base + 5h offset = 4007_3005h

| | | | | | | | | |
|-------|------|---|------|---|---|------|---|---|
| Bit | 7 | 6 | 5 | 4 | 3 | 2 | 1 | 0 |
| Read | PSTM | 0 | PSEL | | | MSEL | | |
| Write | | | | | | | | |
| Reset | 0 | 0 | 0 | 0 | 0 | 0 | 0 | 0 |

CMPx_MUXCR field descriptions

| Field | Description |
|---------------|--|
| 7 PSTM | <p>Pass Through Mode Enable</p> <p>This bit is used to enable to MUX pass through mode. Pass through mode is always available but for some devices this feature must be always disabled due to the lack of package pins.</p> <p>0 Pass Through Mode is disabled. 1 Pass Through Mode is enabled.</p> |
| 6 Reserved | <p>This field is reserved. This read-only field is reserved and always has the value 0.</p> |
| 5–3 PSEL | <p>Plus Input Mux Control</p> <p>Determines which input is selected for the plus input of the comparator. For INx inputs, see CMP, DAC, and ANMUX block diagrams.</p> <p>NOTE: When an inappropriate operation selects the same input for both muxes, the comparator automatically shuts down to prevent itself from becoming a noise generator.</p> <p>000 IN0 001 IN1 010 IN2 011 IN3 100 IN4 101 IN5 110 IN6 111 IN7</p> |
| MSEL | <p>Minus Input Mux Control</p> <p>Determines which input is selected for the minus input of the comparator. For INx inputs, see CMP, DAC, and ANMUX block diagrams.</p> <p>NOTE: When an inappropriate operation selects the same input for both muxes, the comparator automatically shuts down to prevent itself from becoming a noise generator.</p> <p>000 IN0 001 IN1 010 IN2 011 IN3 100 IN4 101 IN5 110 IN6 111 IN7</p> |

30.3 Functional description

The CMP module can be used to compare two analog input voltages applied to INP and INM.

CMPO is high when the non-inverting input is greater than the inverting input, and is low when the non-inverting input is less than the inverting input. This signal can be selectively inverted by setting CR1[INV] = 1.

SCR[IER] and SCR[IEF] are used to select the condition which will cause the CMP module to assert an interrupt to the processor. SCR[CFF] is set on a falling-edge and SCR[CFR] is set on rising-edge of the comparator output. The optionally filtered CMPO can be read directly through SCR[COOUT].

30.3.1 CMP functional modes

There are the following main sub-blocks to the CMP module:

- The comparator itself
- The filter function

The filter, CR0[FILTER_CNT], can be clocked from an internal clock source only. The filter is programmable with respect to the number of samples that must agree before a change in the output is registered. In the simplest case, only one sample must agree. In this case, the filter acts as a simple sampler.

The comparator filter and sampling features can be combined as shown in the following table. Individual modes are discussed below.

Table 30-1. Comparator sample/filter controls

| Mode # | CR1[EN] | CR1[WE] | CR1[SE] | CR0[FILTER_CNT] | FPR[FILT_PER] | Operation |
|--|---------|---------|---------|-----------------|---------------|---|
| 1 | 0 | X | X | X | X | Disabled See the Disabled mode (# 1) . |
| 2A | 1 | 0 | 0 | 0x00 | X | Continuous Mode See the Continuous mode (#s 2A & 2B) . |
| 2B | 1 | 0 | 0 | X | 0x00 | |
| 3B | 1 | 0 | 0 | 0x01 | > 0x00 | Sampled, Non-Filtered mode See the Sampled, Non-Filtered mode (#s 3B) . |
| 4B | 1 | 0 | 0 | > 0x01 | > 0x00 | Sampled, Filtered mode See the Sampled, Filtered mode (#s 4B) . |
| All other combinations of CR1[EN], CR1[WE], CR1[SE], CR0[FILTER_CNT], and FPR[FILT_PER] are illegal. | | | | | | |

For cases where a comparator is used to drive a fault input, for example, for a motor-control module such as FTM, it must be configured to operate in Continuous mode so that an external fault can immediately pass through the comparator to the target fault circuitry.

Note

Filtering and sampling settings must be changed only after setting $CR1[SE]=0$ and $CR0[FILTER_CNT]=0x00$. This resets the filter to a known state.

30.3.1.1 Disabled mode (# 1)

In Disabled mode, the analog comparator is non-functional and consumes no power. CMPO is 0 in this mode.

30.3.1.2 Continuous mode (#s 2A & 2B)

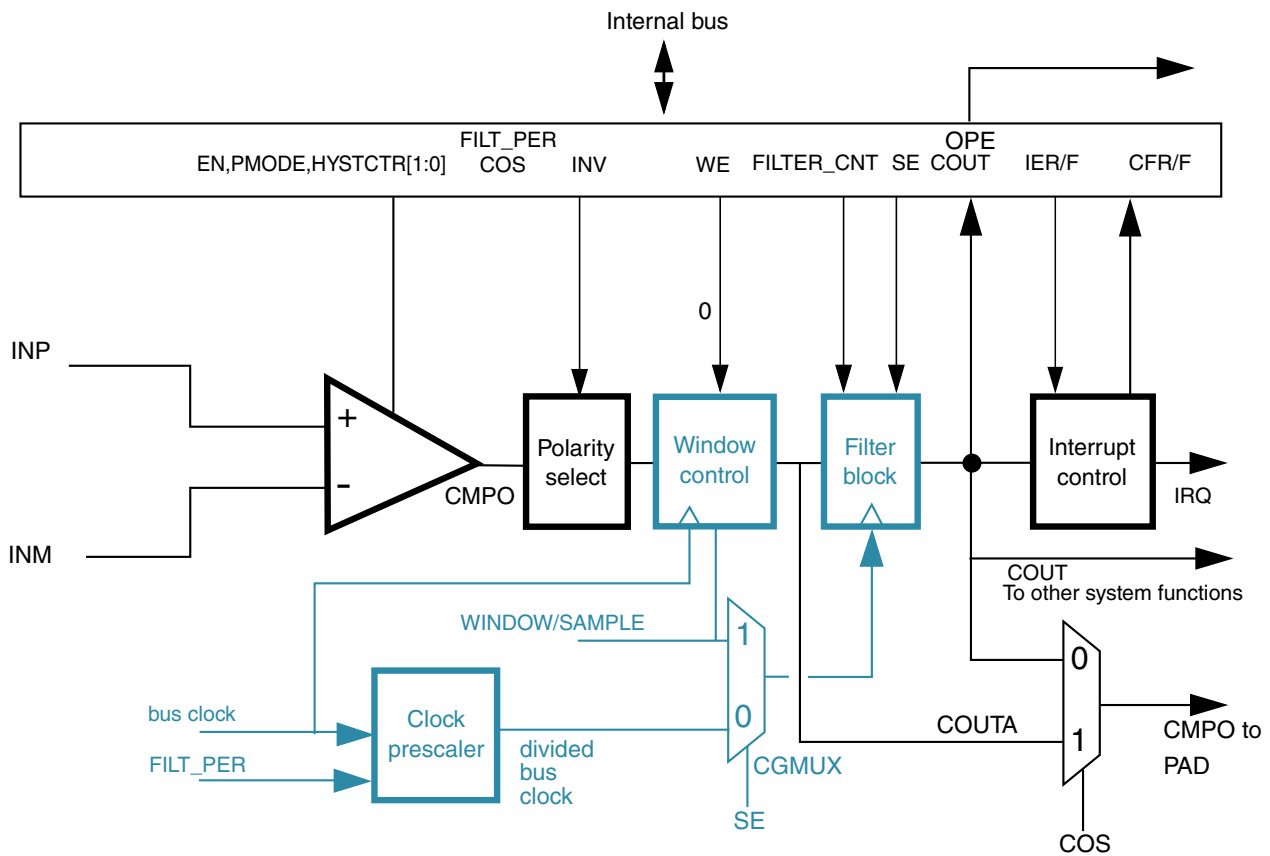

Figure 30-3. Comparator operation in Continuous mode

Functional description

The analog comparator block is powered and active. CMPO may be optionally inverted, but is not subject to external sampling or filtering. Both window control and filter blocks are completely bypassed. SCR[COUT] is updated continuously. The path from comparator input pins to output pin is operating in combinational unlocked mode. COUT and COUTA are identical.

For control configurations which result in disabling the filter block, see the [Filter Block Bypass Logic](#) diagram.

30.3.1.3 Sampled, Non-Filtered mode (#s 3B)

In Sampled, Non-Filtered mode, the analog comparator block is powered and active. The path from analog inputs to COUTA is combinational unlocked. Windowing control is completely bypassed. COUTA is sampled whenever a rising-edge is detected on the filter block clock input.

The comparator filter has no other function than sample/hold of the comparator output in this mode (# 3B).

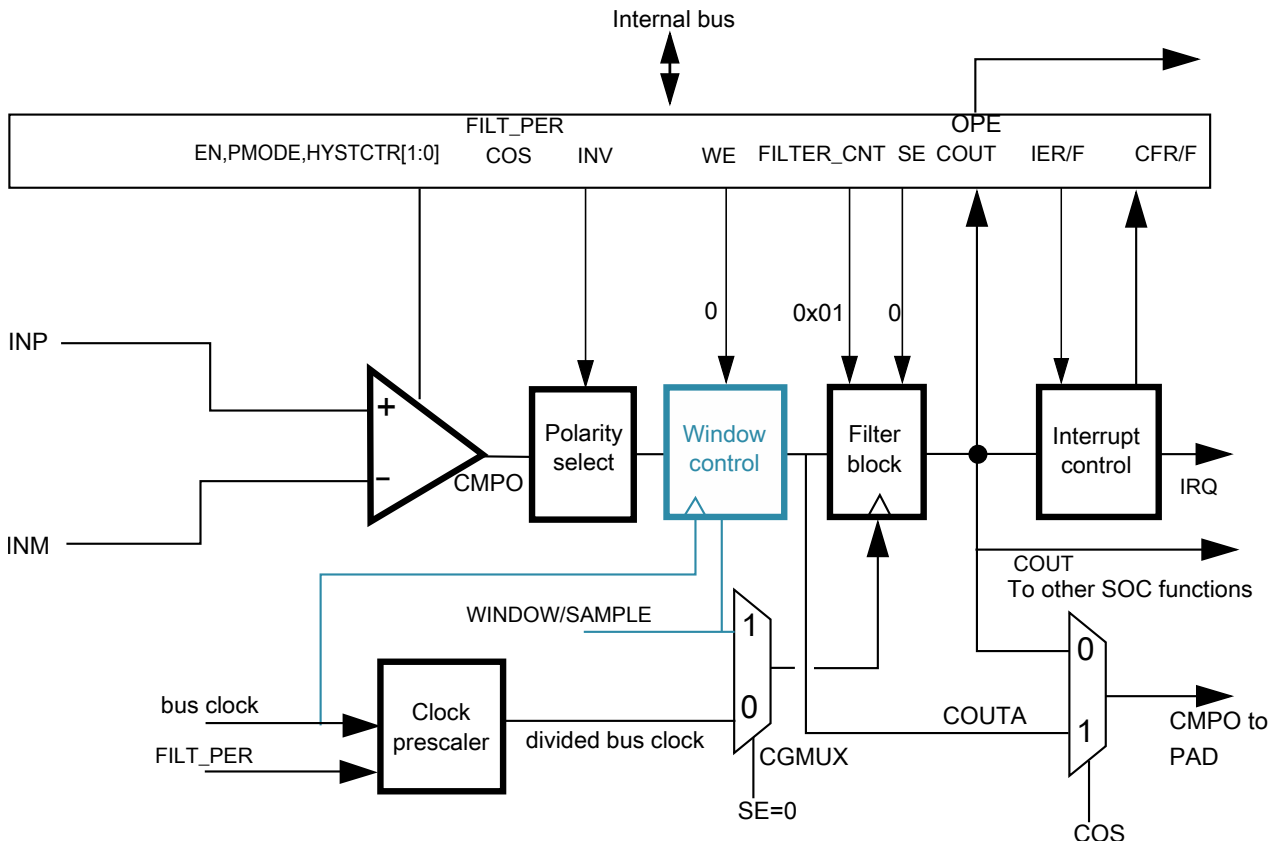

Figure 30-4. Sampled, Non-Filtered (# 3B): sampling interval internally derived

30.3.1.4 Sampled, Filtered mode (#s 4B)

In Sampled, Filtered mode, the analog comparator block is powered and active. The path from analog inputs to COUTA is combinational unlocked. Windowing control is completely bypassed. COUTA is sampled whenever a rising edge is detected on the filter block clock input.

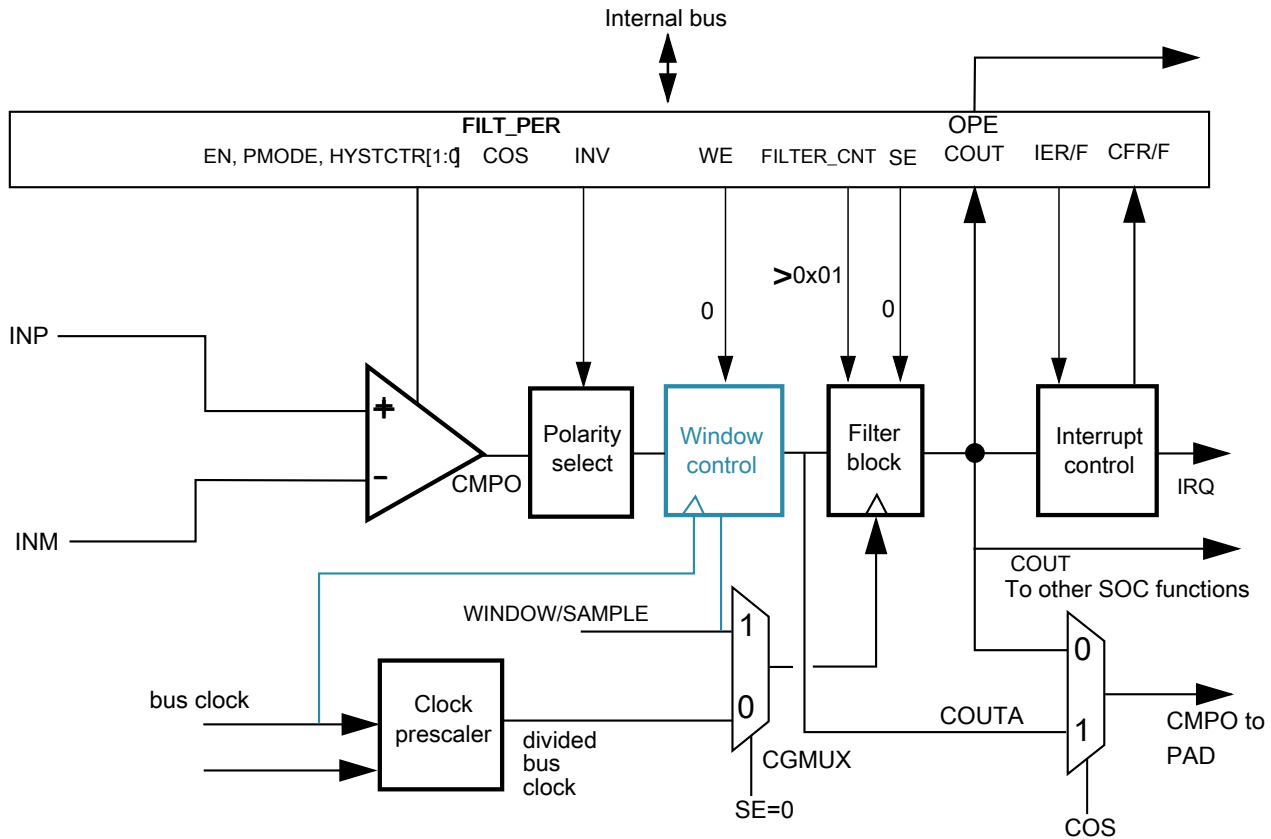

Figure 30-5. Sampled, Filtered (# 4B): sampling point internally derived

The only difference in operation between Sampled, Non-Filtered (# 3B) and Sampled, Filtered (# 4B) is that now, $CR0[FILTER_CNT] > 1$, which activates filter operation.

30.3.2 Power modes

30.3.2.1 Wait mode operation

During Wait and VLPW modes, the CMP, if enabled, continues to operate normally and a CMP interrupt can wake the MCU.

30.3.2.2 Stop mode operation

Depending on clock restrictions related to the MCU core or core peripherals, the MCU is brought out of stop when a compare event occurs and the corresponding interrupt is enabled. Similarly, if CR1[OPE] is enabled, the comparator output operates as in the normal operating mode and comparator output is placed onto the external pin. In Stop modes, the comparator can be operational in both:

- High-Speed (HS) Comparison mode when CR1[PMODE] = 1
- Low-Speed (LS) Comparison mode when CR1[PMODE] = 0

It is recommended to use the LS mode to minimize power consumption.

If stop is exited with a reset, all comparator registers are put into their reset state.

30.3.2.3 Low-Leakage mode operation

When the chip is in Low-Leakage modes:

- The CMP module is partially functional and is limited to Low-Speed mode, regardless of CR1[PMODE] setting
- Windowed, Sampled, and Filtered modes are not supported
- The CMP output pin is latched and does not reflect the compare output state.

The positive- and negative-input voltage can be supplied from external pins or the DAC output. The MCU can be brought out of the Low-Leakage mode if a compare event occurs and the CMP interrupt is enabled. After wakeup from low-leakage modes, the CMP module is in the reset state except for SCR[CFF] and SCR[CFR].

30.3.2.4 Background Debug Mode Operation

When the microcontroller is in active background debug mode, the CMP continues to operate normally.

30.3.3 Startup and operation

A typical startup sequence is listed here.

- The time required to stabilize COUT will be the power-on delay of the comparators plus the largest propagation delay from a selected analog source through the analog

comparator and filter. See the Data Sheets for power-on delays of the comparators. The filter delay is specified in the [Low-pass filter](#).

- During operation, the propagation delay of the selected data paths must always be considered. It may take many bus clock cycles for COUT and SCR[CFR]/SCR[CFF] to reflect an input change or a configuration change to one of the components involved in the data path.
- When programmed for filtering modes, COUT will initially be equal to 0, until sufficient clock cycles have elapsed to fill all stages of the filter. This occurs even if COUTA is at a logic 1.

30.3.4 Low-pass filter

The low-pass filter operates on the unfiltered and unsynchronized and optionally inverted comparator output COUTA and generates the filtered and synchronized output COUT.

Both COUTA and COUT can be configured as module outputs and are used for different purposes within the system.

Synchronization and edge detection are always used to determine status register bit values. They also apply to COUT for all sampling modes. Filtering can be performed using an internal timebase defined by FPR[FILT_PER] to determine sample time.

The need for digital filtering and the amount of filtering is dependent on user requirements. Filtering can become more useful in the absence of an external hysteresis circuit. Without external hysteresis, high-frequency oscillations can be generated at COUTA when the selected INM and INP input voltages differ by less than the offset voltage of the differential comparator.

30.3.4.1 Enabling filter modes

Filter modes can be enabled by:

- Setting CR0[FILTER_CNT] > 0x01 and
- Setting FPR[FILT_PER] to a nonzero value

Using the divided bus clock to drive the filter, it will take samples of COUTA every FPR[FILT_PER] bus clock cycles.

The filter output will be at logic 0 when first initialized, and will subsequently change when all the consecutive CR0[FILTER_CNT] samples agree that the output value has changed. In other words, SCR[COUT] will be 0 for some initial period, even when COUTA is at logic 1.

Setting FPR[FILT_PER] to 0 disables the filter and eliminates switching current associated with the filtering process.

Note

Always switch to this setting prior to making any changes in filter parameters. This resets the filter to a known state. Switching CR0[FILTER_CNT] on the fly without this intermediate step can result in unexpected behavior.

30.3.4.2 Latency issues

The value of FPR[FILT_PER] or SAMPLE period must be set such that the sampling period is just longer than the period of the expected noise. This way a noise spike will corrupt only one sample. The value of CR0[FILTER_CNT] must be chosen to reduce the probability of noisy samples causing an incorrect transition to be recognized. The probability of an incorrect transition is defined as the probability of an incorrect sample raised to the power of CR0[FILTER_CNT].

The values of FPR[FILT_PER] or SAMPLE period and CR0[FILTER_CNT] must also be traded off against the desire for minimal latency in recognizing actual comparator output transitions. The probability of detecting an actual output change within the nominal latency is the probability of a correct sample raised to the power of CR0[FILTER_CNT].

The following table summarizes maximum latency values for the various modes of operation *in the absence of noise*. Filtering latency is restarted each time an actual output transition is masked by noise.

Table 30-2. Comparator sample/filter maximum latencies

| Mode # | CR1[EN] | CR1[WE] | CR1[SE] | CR0[FILTER_CNT] | FPR[FILT_PER] | Operation | Maximum latency ¹ |
|--------|---------|---------|---------|-----------------|---------------|----------------------------|--|
| 1 | 0 | X | X | X | X | Disabled | N/A |
| 2A | 1 | 0 | 0 | 0x00 | X | Continuous Mode | T _{PD} |
| 2B | 1 | 0 | 0 | X | 0x00 | | |
| 3B | 1 | 0 | 0 | 0x01 | > 0x00 | Sampled, Non-Filtered mode | T _{PD} + (FPR[FILT_PER] * T _{per}) + T _{per} |
| 4B | 1 | 0 | 0 | > 0x01 | > 0x00 | Sampled, Filtered mode | T _{PD} + (CR0[FILTER_CNT] * FPR[FILT_PER] x T _{per}) + T _{per} |

1. T_{PD} represents the intrinsic delay of the analog component plus the polarity select logic. T_{per} is the period of the bus clock.

30.4 CMP interrupts

The CMP module is capable of generating an interrupt on either the rising- or falling-edge of the comparator output, or both.

The following table gives the conditions in which the interrupt request is asserted and deasserted.

| When | Then |
|--|-------------------------------------|
| SCR[IER] and SCR[CFR] are set | The interrupt request is asserted |
| SCR[IEF] and SCR[CFF] are set | The interrupt request is asserted |
| SCR[IER] and SCR[CFR] are cleared for a rising-edge interrupt | The interrupt request is deasserted |
| SCR[IEF] and SCR[CFF] are cleared for a falling-edge interrupt | The interrupt request is deasserted |

30.5 DMA support

Normally, the CMP generates a CPU interrupt if there is a change on the COUT. When DMA support is enabled by setting SCR[DMAEN] and the interrupt is enabled by setting SCR[IER], SCR[IEF], or both, the corresponding change on COUT forces a DMA transfer request rather than a CPU interrupt instead. When the DMA has completed the transfer, it sends a transfer completing indicator that deasserts the DMA transfer request and clears the flag to allow a subsequent change on comparator output to occur and force another DMA request.

The comparator can remain functional in STOP modes.

When DMA support is enabled by setting SCR[DMAEN] and the interrupt is enabled by setting SCR[IER], SCR[IEF], or both, the corresponding change on COUT forces a DMA transfer request to wake up the system from STOP modes. After the data transfer has finished, system will go back to STOP modes. Refer to DMA chapters in the device reference manual for the asynchronous DMA function for details.

30.6 CMP Asynchronous DMA support

The comparator can remain functional in STOP modes.

When DMA support is enabled by setting SCR[DMAEN] and the interrupt is enabled by setting SCR[IER], SCR[IEF], or both, the corresponding change on COUT forces a DMA transfer request to wake up the system from STOP modes. After the data transfer has finished, system will go back to STOP modes. Refer to DMA chapters in the device reference manual for the asynchronous DMA function for details.

30.7 Digital-to-analog converter

The figure found here shows the block diagram of the DAC module.

It contains a 64-tap resistor ladder network and a 64-to-1 multiplexer, which selects an output voltage from one of 64 distinct levels that outputs from DACO. It is controlled through the DAC Control Register (DACCR). Its supply reference source can be selected from two sources V_{in1} and V_{in2} . The module can be powered down or disabled when not in use. When in Disabled mode, DACO is connected to the analog ground.

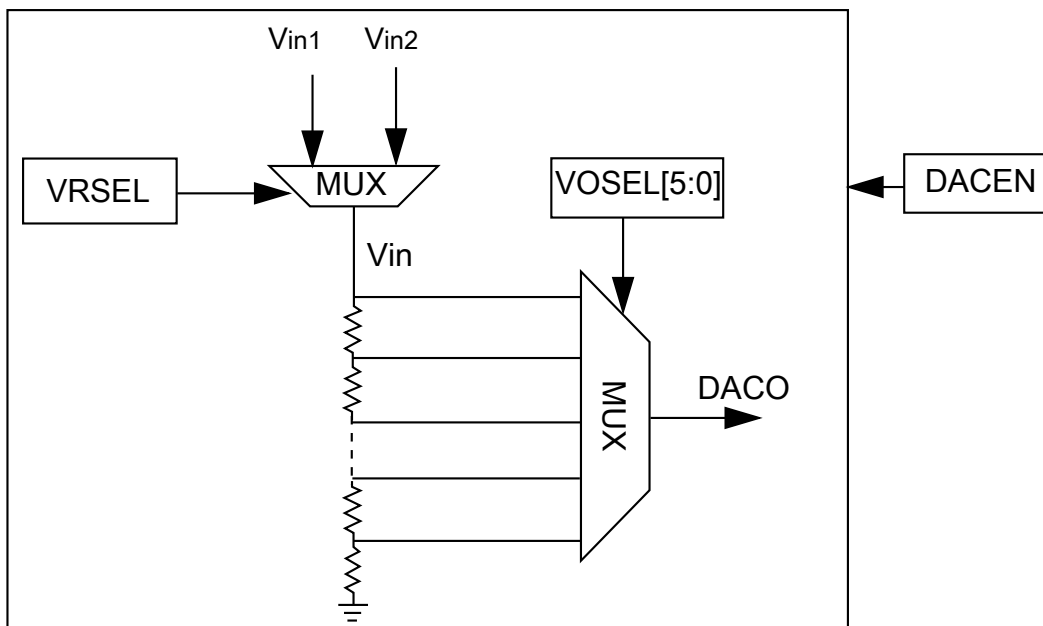

Figure 30-6. 6-bit DAC block diagram

30.8 DAC functional description

This section provides DAC functional description information.

30.8.1 Voltage reference source select

- V_{in1} connects to the primary voltage source as supply reference of 64 tap resistor ladder
- V_{in2} connects to an alternate voltage source

30.9 DAC resets

This module has a single reset input, corresponding to the chip-wide peripheral reset.

30.10 DAC clocks

This module has a single clock input, the bus clock.

30.11 DAC interrupts

This module has no interrupts.

30.12 CMP Trigger Mode

CMP and DAC are configured to CMP Trigger mode when `CMP_CR1[TRIGM]` is set to 1.

In addition, the CMP must be enabled. If the DAC is to be used as a reference to the CMP, it must also be enabled.

CMP Trigger mode depends on an external timer resource to periodically enable the CMP and 6-bit DAC in order to generate a triggered compare.

Upon setting `TRIGM`, the CMP and DAC are placed in a standby state until an external timer resource trigger is received.

Chapter 31

12-bit digital-to-analog converter (DAC)

The 12-bit digital-to-analog converter (DAC) is a low-power general purpose DAC whose output can be placed on an external pin, or set as one of the inputs to the analog comparator, OPAMPs, ADC, or other peripherals.

31.1 Introduction

The 12-bit digital-to-analog converter (DAC) is a low-power, general-purpose DAC. The output of the DAC can be placed on an external pin or set as one of the inputs to the analog comparator, op-amps, or ADC.

31.2 Features

The features of the DAC module include:

- On-chip programmable reference generator output. The voltage output range is from $1/4096 V_{in}$ to V_{in} , and the step is $1/4096 V_{in}$, where V_{in} is the input voltage.
- V_{in} can be selected from two reference sources
- Static operation in Normal Stop mode
- 2-word data buffer supported with configurable watermark and multiple operation modes
- DMA support

31.3 Block diagram

The block diagram of the DAC module is as follows:

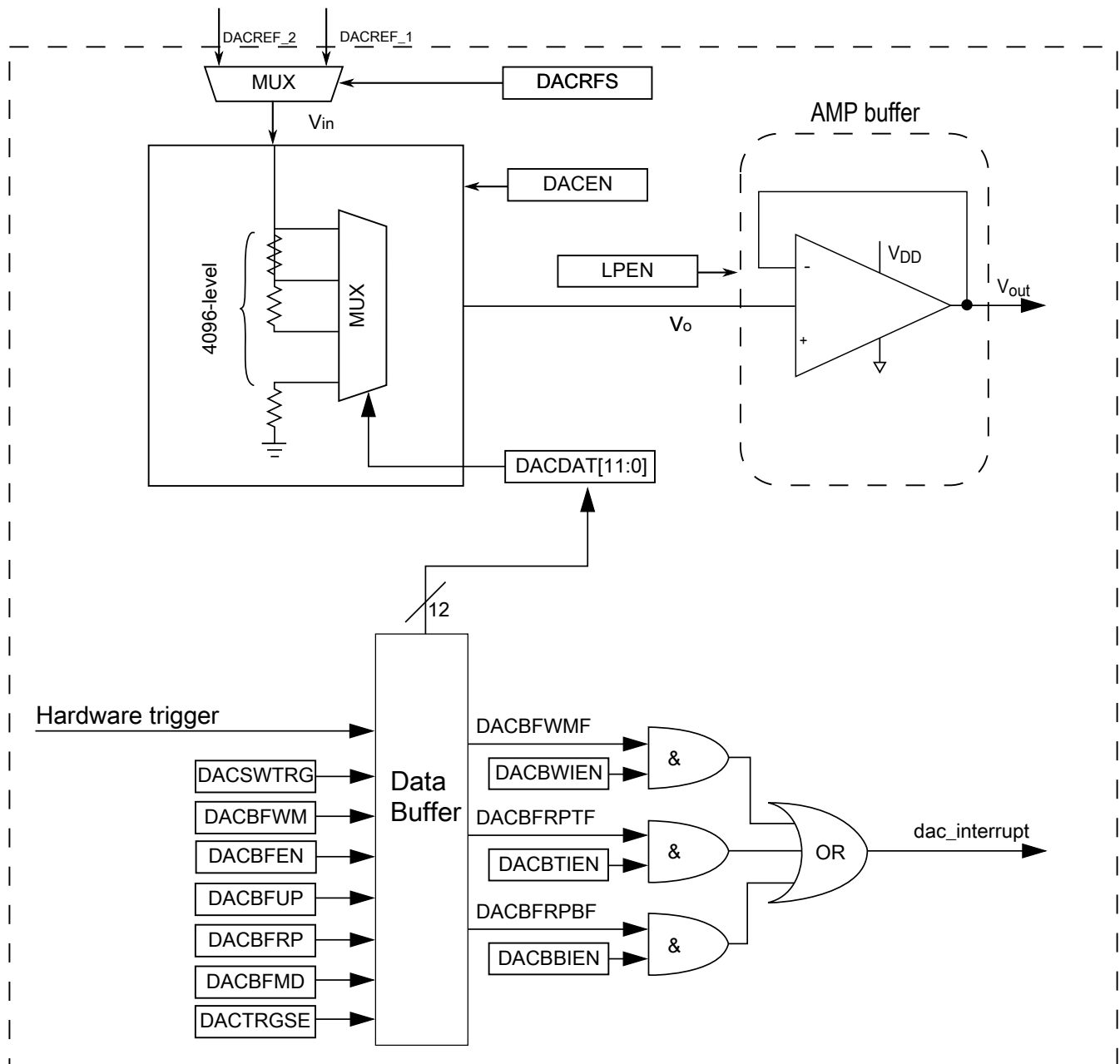

Figure 31-1. DAC block diagram

31.4 Memory map/register definition

The DAC has registers to control analog comparator and programmable voltage divider to perform the digital-to-analog functions.

DAC memory map

| Absolute address (hex) | Register name | Width (in bits) | Access | Reset value | Section/page |
|------------------------|-------------------------------------|-----------------|--------|-------------|----------------------------|
| 4003_F000 | DAC Data Low Register (DAC0_DAT0L) | 8 | R/W | 00h | 31.4.1/699 |
| 4003_F001 | DAC Data High Register (DAC0_DAT0H) | 8 | R/W | 00h | 31.4.2/699 |
| 4003_F002 | DAC Data Low Register (DAC0_DAT1L) | 8 | R/W | 00h | 31.4.1/699 |
| 4003_F003 | DAC Data High Register (DAC0_DAT1H) | 8 | R/W | 00h | 31.4.2/699 |
| 4003_F020 | DAC Status Register (DAC0_SR) | 8 | R/W | 06h | 31.4.3/700 |
| 4003_F021 | DAC Control Register (DAC0_C0) | 8 | R/W | 00h | 31.4.4/701 |
| 4003_F022 | DAC Control Register 1 (DAC0_C1) | 8 | R/W | 00h | 31.4.5/702 |
| 4003_F023 | DAC Control Register 2 (DAC0_C2) | 8 | R/W | 01h | 31.4.6/703 |

31.4.1 DAC Data Low Register (DACx_DATnL)

Address: 4003_F000h base + 0h offset + (2d × i), where i=0d to 1d

| Bit | 7 | 6 | 5 | 4 | 3 | 2 | 1 | 0 |
|-------|-------|---|---|---|---|---|---|---|
| Read | DATA0 | | | | | | | |
| Write | DATA0 | | | | | | | |
| Reset | 0 | 0 | 0 | 0 | 0 | 0 | 0 | 0 |

DACx_DATnL field descriptions

| Field | Description |
|-------|--|
| DATA0 | <p>DATA0</p> <p>When the DAC buffer is not enabled, DATA[11:0] controls the output voltage based on the following formula: $V_{out} = V_{in} * (1 + DACDAT0[11:0])/4096$</p> <p>When the DAC buffer is enabled, DATA is mapped to the 16-word buffer.</p> |

31.4.2 DAC Data High Register (DACx_DATnH)

Address: 4003_F000h base + 1h offset + (2d × i), where i=0d to 1d

| Bit | 7 | 6 | 5 | 4 | 3 | 2 | 1 | 0 |
|-------|---|---|---|---|-------|---|---|---|
| Read | 0 | | | | DATA1 | | | |
| Write | 0 | | | | DATA1 | | | |
| Reset | 0 | 0 | 0 | 0 | 0 | 0 | 0 | 0 |

DACx_DATnH field descriptions

| Field | Description |
|--------------|--|
| 7–4 Reserved | <p>This field is reserved.</p> <p>This read-only field is reserved and always has the value 0.</p> |
| DATA1 | DATA1 |

Table continues on the next page...

DACx_DATnH field descriptions (continued)

| Field | Description |
|-------|--|
| | When the DAC Buffer is not enabled, DATA[11:0] controls the output voltage based on the following formula. $V_{out} = V_{in} * (1 + DACDAT0[11:0])/4096$ |
| | When the DAC buffer is enabled, DATA[11:0] is mapped to the 16-word buffer. |

31.4.3 DAC Status Register (DACx_SR)

If DMA is enabled, the flags can be cleared automatically by DMA when the DMA request is done. Writing 0 to a field clears it whereas writing 1 has no effect. After reset, DACBFRPTF is set and can be cleared by software, if needed. The flags are set only when the data buffer status is changed.

NOTE

Do not use 32/16-bit accesses to this register.

NOTE

A watermark interrupt is generated if C0[DACBWIEN] is set after any write to DAC data register, since there is only 1 word depth for the buffer watermark. It is recommended not to set C0[DACBWIEN] to avoid repeated entry into the watermark interrupt.

Address: 4003_F000h base + 20h offset = 4003_F020h

| | | | | | | | | |
|-------|---|---|---|---|---|---------|----------|----------|
| Bit | 7 | 6 | 5 | 4 | 3 | 2 | 1 | 0 |
| Read | 0 | | | | | DACBFWM | DACBFRPT | DACBFRPB |
| Write | | | | | | F | F | F |
| Reset | 0 | 0 | 0 | 0 | 0 | 1 | 1 | 0 |

DACx_SR field descriptions

| Field | Description |
|-----------------|--|
| 7-3 Reserved | This field is reserved. This read-only field is reserved and always has the value 0. |
| 2 DACBFWMF | DAC Buffer Watermark Flag 0 The DAC buffer read pointer has not reached the watermark level. 1 The DAC buffer read pointer has reached the watermark level. |
| 1 DACBFRPTF | DAC Buffer Read Pointer Top Position Flag 0 The DAC buffer read pointer is not zero. 1 The DAC buffer read pointer is zero. |
| 0 DACBFRPBF | DAC Buffer Read Pointer Bottom Position Flag 0 The DAC buffer read pointer is not equal to C2[DACBFUP]. 1 The DAC buffer read pointer is equal to C2[DACBFUP]. |

31.4.4 DAC Control Register (DACx_C0)

NOTE

Do not use 32- or 16-bit accesses to this register.

NOTE

A watermark interrupt is generated if C0[DACBWIEN] is set after any write to DAC data register, since there is only 1 word depth for the buffer watermark. It is recommended not to set C0[DACBWIEN] to avoid repeated entry into the watermark interrupt.

Address: 4003_F000h base + 21h offset = 4003_F021h

| Bit | 7 | 6 | 5 | 4 | 3 | 2 | 1 | 0 |
|-------|-------|--------|-----------|----------|------|----------|----------|----------|
| Read | | | DACTRGSEL | 0 | LPEN | DACBWIEN | DACBTIEN | DACBBIEN |
| Write | DACEN | DACRFS | L | DACSWTRG | | | | |
| Reset | 0 | 0 | 0 | 0 | 0 | 0 | 0 | 0 |

DACx_C0 field descriptions

| Field | Description |
|----------------|--|
| 7 DACEN | <p>DAC Enable</p> <p>Starts the Programmable Reference Generator operation.</p> <p>0 The DAC system is disabled. 1 The DAC system is enabled.</p> |
| 6 DACRFS | <p>DAC Reference Select</p> <p>0 The DAC selects DACREF_1 as the reference voltage. 1 The DAC selects DACREF_2 as the reference voltage.</p> |
| 5 DACTRGSEL | <p>DAC Trigger Select</p> <p>0 The DAC hardware trigger is selected. 1 The DAC software trigger is selected.</p> |
| 4 DACSWTRG | <p>DAC Software Trigger</p> <p>Active high. This is a write-only field, which always reads 0. If DAC software trigger is selected and buffer is enabled, writing 1 to this field will advance the buffer read pointer once.</p> <p>0 The DAC soft trigger is not valid. 1 The DAC soft trigger is valid.</p> |
| 3 LPEN | <p>DAC Low Power Control</p> <p>NOTE: See the 12-bit DAC electrical characteristics of the device data sheet for details on the impact of the modes below.</p> |

Table continues on the next page...

DACx_C0 field descriptions (continued)

| Field | Description |
|---------------|---|
| | 0 High-Power mode 1 Low-Power mode |
| 2 DACBWIEN | DAC Buffer Watermark Interrupt Enable 0 The DAC buffer watermark interrupt is disabled. 1 The DAC buffer watermark interrupt is enabled. |
| 1 DACBTIEN | DAC Buffer Read Pointer Top Flag Interrupt Enable 0 The DAC buffer read pointer top flag interrupt is disabled. 1 The DAC buffer read pointer top flag interrupt is enabled. |
| 0 DACBBIEN | DAC Buffer Read Pointer Bottom Flag Interrupt Enable 0 The DAC buffer read pointer bottom flag interrupt is disabled. 1 The DAC buffer read pointer bottom flag interrupt is enabled. |

31.4.5 DAC Control Register 1 (DACx_C1)

NOTE

Do not use 32- or 16-bit accesses to this register.

Address: 4003_F000h base + 22h offset = 4003_F022h

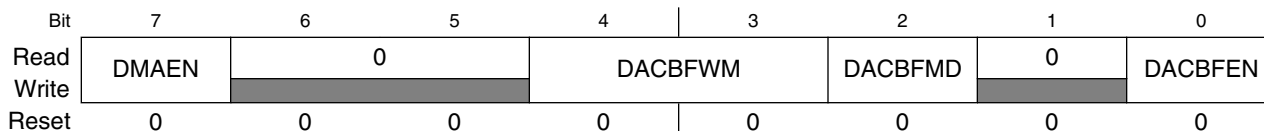

DACx_C1 field descriptions

| Field | Description |
|-----------------|--|
| 7 DMAEN | DMA Enable Select 0 DMA is disabled. 1 DMA is enabled. When DMA is enabled, the DMA request will be generated by original interrupts. The interrupts will not be presented on this module at the same time. |
| 6–5 Reserved | This field is reserved. This read-only field is reserved and always has the value 0. |
| 4–3 DACBFWM | DAC Buffer Watermark Select Controls when SR[DACBFWMF] is set. When the DAC buffer read pointer reaches the word defined by this field, which is 1–4 words away from the upper limit (DACBUP), SR[DACBFWMF] will be set. This allows user configuration of the watermark interrupt. NOTE: If FIFO depth is 2, all settings are treat the same, which means if the FIFO is not FULL the watermark status bit and DACBFRPBF are set. User may need to use one of the status bit for DMA or IRQ request. |

Table continues on the next page...

DACx_C1 field descriptions (continued)

| Field | Description |
|---------------|---|
| | 00 1 word 01 2 words 10 Reserved 11 Reserved |
| 2 DACBFMD | DAC Buffer Work Mode Select 0 Normal mode 1 One-Time Scan mode |
| 1 Reserved | This field is reserved. This read-only field is reserved and always has the value 0. |
| 0 DACBFEN | DAC Buffer Enable 0 Buffer read pointer is disabled. The converted data is always the first word of the buffer. 1 Buffer read pointer is enabled. The converted data is the word that the read pointer points to. It means converted data can be from any word of the buffer. |

31.4.6 DAC Control Register 2 (DACx_C2)

Address: 4003_F000h base + 23h offset = 4003_F023h

| Bit | 7 | 6 | 5 | 4 | 3 | 2 | 1 | 0 |
|-------|---|---|---|---------|---|---|---|---------|
| Read | 0 | | | DACBFRP | 0 | | | DACBFUP |
| Write | 0 | | | | 0 | | | |
| Reset | 0 | 0 | 0 | 0 | 0 | 0 | 0 | 1 |

DACx_C2 field descriptions

| Field | Description |
|-----------------|--|
| 7–5 Reserved | This field is reserved. This read-only field is reserved and always has the value 0. |
| 4 DACBFRP | DAC Buffer Read Pointer Keeps the current value of the buffer read pointer. |
| 3–1 Reserved | This field is reserved. This read-only field is reserved and always has the value 0. |
| 0 DACBFUP | DAC Buffer Upper Limit Selects the upper limit of the DAC buffer. The buffer read pointer cannot exceed it. |

31.5 Functional description

The 12-bit DAC module can select one of the two reference inputs—DACREF_1 and DACREF_2 as the DAC reference voltage, V_{in} by C0 [DACRFS]. See the chip-specific DAC information to determine the source options for DACREF_1 and DACREF_2.

When the DAC is enabled, it converts the data in DACDAT0[11:0] or the data from the DAC data buffer to a stepped analog output voltage. The output voltage range is from V_{in} to $V_{in}/4096$, and the step is $V_{in}/4096$.

31.5.1 DAC data buffer operation

When the DAC is enabled and the buffer is not enabled, the DAC module always converts the data in DAT0 to the analog output voltage.

When both the DAC and the buffer are enabled, the DAC converts the data in the data buffer to analog output voltage. The data buffer read pointer advances to the next word whenever a hardware or software trigger event occurs.

The data buffer can be configured to operate in Normal mode, One-Time Scan mode. When the buffer operation is switched from one mode to another, the read pointer does not change. The read pointer can be set to any value between 0 and C2[DACBFUP] by writing C2[DACBFRP].

31.5.1.1 DAC data buffer interrupts

There are several interrupts and associated flags that can be configured for the DAC buffer. SR[DACBFRPBF] is set when the DAC buffer read pointer reaches the DAC buffer upper limit, that is, C2[DACBFRP] = C2[DACBFUP]. SR[DACBFRPTF] is set when the DAC read pointer is equal to the start position, 0. Finally, SR[DACBFWMF] is set when the DAC buffer read pointer has reached the position defined by C1[DACBFWM]. C1[DACBFWM] can be used to generate an interrupt when the DAC buffer read pointer is between 1 to 4 words from C2[DACBFUP].

31.5.1.2 Modes of DAC data buffer operation

The following table describes the different modes of data buffer operation for the DAC module.

Table 31-1. Modes of DAC data buffer operation

| Modes | Description |
|--------------------|--|
| Buffer Normal mode | This is the default mode. The buffer works as a circular buffer. The read pointer increases by one, every time the trigger occurs. When the read pointer reaches the upper limit, it goes to 0 directly in the next trigger event. |

Table continues on the next page...

Table 31-1. Modes of DAC data buffer operation (continued)

| Modes | Description |
|---------------------------|---|
| Buffer One-time Scan mode | <p>The read pointer increases by 1 every time the trigger occurs. When it reaches the upper limit, it stops there. If read pointer is reset to the address other than the upper limit, it will increase to the upper address and stop there again.</p> <p>NOTE: If the software set the read pointer to the upper limit, the read pointer will not advance in this mode.</p> |

31.5.2 DMA operation

When DMA is enabled, DMA requests are generated instead of interrupt requests. The DMA Done signal clears the DMA request.

The status register flags are still set and are cleared automatically when the DMA completes.

31.5.3 Resets

During reset, the DAC is configured in the default mode and is disabled.

31.5.4 Low-Power mode operation

The following table shows the wait mode and the stop mode operation of the DAC module.

Table 31-2. Modes of operation

| Modes of operation | Description |
|--------------------|--|
| Wait mode | The DAC will operate normally, if enabled. |
| Stop mode | <p>If enabled, the DAC module continues to operate in Normal Stop mode and the output voltage will hold the value before stop.</p> <p>In low-power stop modes, the DAC is fully shut down.</p> |

NOTE

The assignment of module modes to core modes is chip-specific. For module-to-core mode assignments, see the chapter that describes how modules are configured.

Chapter 32

Voltage Reference(VREF)

32.1 Introduction

The Voltage Reference (VREF) is intended to supply an accurate voltage output that can be trimmed in 0.5 mV steps. The VREF can be used in applications to provide a reference voltage to external devices or used internally as a reference to analog peripherals such as the ADC, DAC, or CMP. The voltage reference has three operating modes that provide different levels of supply rejection and power consumption.

The following figure is a block diagram of the Voltage Reference.

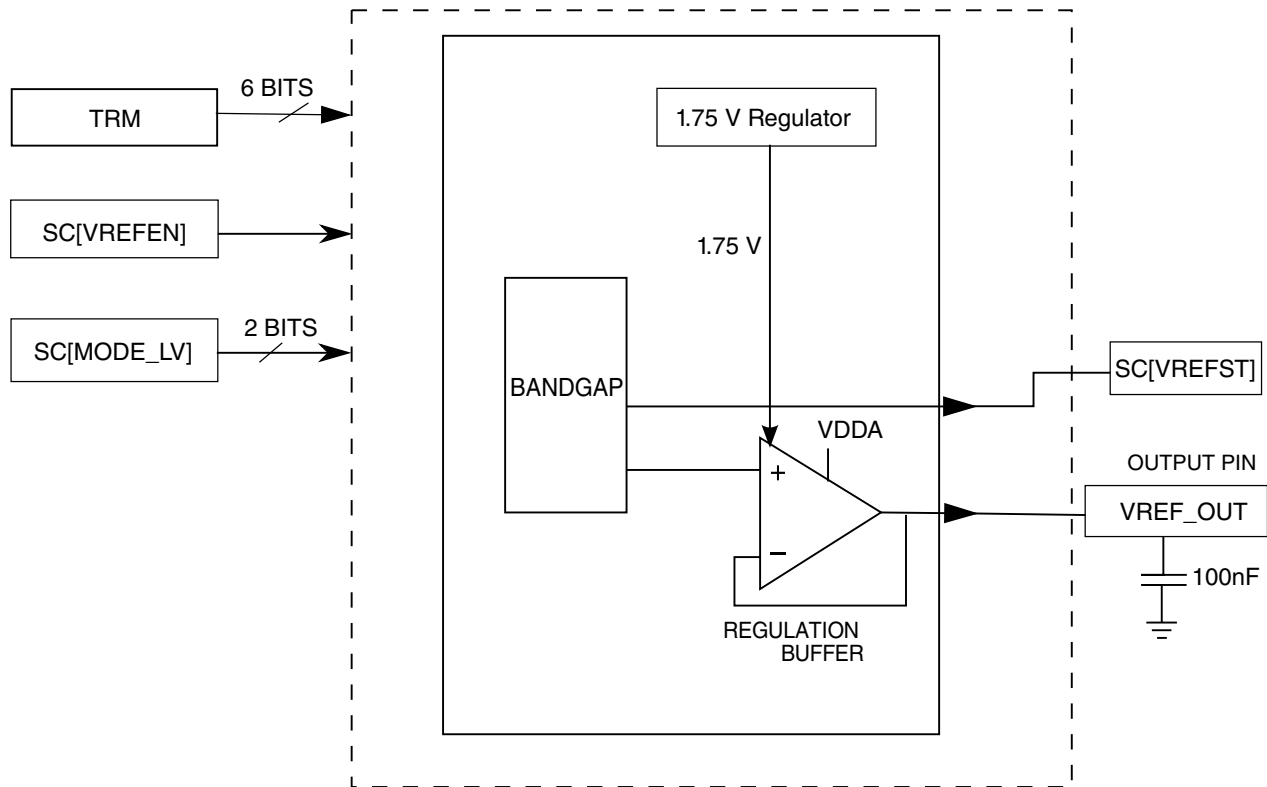

Figure 32-1. Voltage reference block diagram

32.1.1 Overview

The Voltage Reference provides a buffered reference voltage for use as an external reference. In addition, the buffered reference is available internally for use with on chip peripherals such as ADCs and DACs. Refer to the chip configuration details for a description of these options. The reference voltage signal is output when the VREF is enabled. The Voltage Reference output can be trimmed with a resolution of 0.5mV by means of the TRM register TRIM[5:0] bitfield.

32.1.2 Features

The Voltage Reference has the following features:

- Programmable trim register with 0.5 mV steps, automatically loaded with factory trimmed value upon reset
- Programmable buffer mode selection:
 - Off
 - Bandgap enabled/standby (output buffer disabled)
 - Low power buffer mode (output buffer enabled)
 - High power buffer mode (output buffer enabled)
- 1.195 V output at room temperature

32.1.3 Modes of Operation

The Voltage Reference continues normal operation in Run, Wait, and Stop modes. The Voltage Reference can also run in Very Low Power Run (VLPR), Very Low Power Wait (VLPW) and Very Low Power Stop (VLPS). If it is desired to use the VREF regulator and/or the chop oscillator in the very low power modes, the system reference voltage (also referred to as the bandgap voltage reference) must be enabled in these modes. Refer to the chip configuration details for information on enabling this mode of operation. Having the VREF regulator enabled does increase current consumption. In very low power modes it may be desirable to disable the VREF regulator to minimize current consumption. Note however that the accuracy of the output voltage will be reduced (by as much as several mVs) when the VREF regulator is not used.

NOTE

The assignment of module modes to core modes is chip-specific. For module-to-core mode assignments, see the chapter that describes how modules are configured.

32.1.4 VREF Signal Descriptions

The following table shows the Voltage Reference signals properties.

Table 32-1. VREF Signal Descriptions

| Signal | Description | I/O |
|----------|---|-----|
| VREF_OUT | Internally-generated Voltage Reference output | O |

NOTE

When the VREF output buffer is disabled, the status of the VREF_OUT signal is high-impedence.

32.2 Memory Map and Register Definition**VREF memory map**

| Absolute address (hex) | Register name | Width (in bits) | Access | Reset value | Section/page |
|------------------------|--|-----------------|--------|-----------------------------|----------------------------|
| 4007_4000 | VREF Trim Register (VREF_TRM) | 8 | R/W | See section | 32.2.1/709 |
| 4007_4001 | VREF Status and Control Register (VREF_SC) | 8 | R/W | 00h | 32.2.2/710 |

32.2.1 VREF Trim Register (VREF_TRM)

This register contains bits that contain the trim data for the Voltage Reference.

Address: 4007_4000h base + 0h offset = 4007_4000h

| Bit | 7 | 6 | 5 | 4 | 3 | 2 | 1 | 0 |
|-------|----|---|----|----|----|----|----|----|
| Read | | | | | | | | |
| Write | | | | | | | | |
| Reset | x* | 0 | x* | x* | x* | x* | x* | x* |

TRIM

* Notes:

- x = Undefined at reset.

VREF_TRM field descriptions

| Field | Description |
|---------------|---|
| 7 Reserved | This field is reserved. Upon reset this value is loaded with a factory trim value. |
| 6 CHOPEN | Chop oscillator enable. When set, internal chopping operation is enabled and the internal analog offset will be minimized. This bit is set during factory trimming of the VREF voltage. This bit should be written to 1 to achieve the performance stated in the data sheet. If the chop oscillator is to be used in very low power modes, the system (bandgap) voltage reference must also be enabled. See the chip-specific VREF information (also known as "chip configuration" details) for a description of how this can be achieved. 0 Chop oscillator is disabled. 1 Chop oscillator is enabled. |
| TRIM | Trim bits These bits change the resulting VREF by approximately ± 0.5 mV for each step. NOTE: Min = minimum and max = maximum voltage reference output. For minimum and maximum voltage reference output values, refer to the Data Sheet for this chip. 000000 Min 111111 Max |

32.2.2 VREF Status and Control Register (VREF_SC)

This register contains the control bits used to enable the internal voltage reference and to select the buffer mode to be used.

Address: 4007_4000h base + 1h offset = 4007_4001h

| | | | | | | | | |
|-------|--------|-------|---------|---|---|--------|---------|---|
| Bit | 7 | 6 | 5 | 4 | 3 | 2 | 1 | 0 |
| Read | VREFEN | REGEN | ICOMPEN | 0 | 0 | VREFST | MODE_LV | |
| Write | | | | | | | | |
| Reset | 0 | 0 | 0 | 0 | 0 | 0 | 0 | 0 |

VREF_SC field descriptions

| Field | Description |
|-------------|--|
| 7 VREFEN | Internal Voltage Reference enable This bit is used to enable the bandgap reference within the Voltage Reference module. NOTE: After the VREF is enabled, turning off the clock to the VREF module via the corresponding clock gate register will not disable the VREF. VREF must be disabled via this VREFEN bit. |

Table continues on the next page...

VREF_SC field descriptions (continued)

| Field | Description |
|---------------|---|
| | 0 The module is disabled. 1 The module is enabled. |
| 6 REGEN | Regulator enable This bit is used to enable the internal 1.75 V regulator to produce a constant internal voltage supply in order to reduce the sensitivity to external supply noise and variation. If it is desired to keep the regulator enabled in very low power modes, refer to the Chip Configuration details for a description on how this can be achieved. This bit should be written to 1 to achieve the performance stated in the data sheet. 0 Internal 1.75 V regulator is disabled. 1 Internal 1.75 V regulator is enabled. |
| 5 ICOMPEN | Second order curvature compensation enable This bit should be written to 1 to achieve the performance stated in the data sheet. 0 Disabled 1 Enabled |
| 4 Reserved | This field is reserved. This read-only field is reserved and always has the value 0. |
| 3 Reserved | This field is reserved. This read-only field is reserved and always has the value 0. |
| 2 VREFST | Internal Voltage Reference stable This bit indicates that the bandgap reference within the Voltage Reference module has completed its startup and stabilization. NOTE: This bit is valid only when the chop oscillator is not being used. 0 The module is disabled or not stable. 1 The module is stable. |
| MODE_LV | Buffer Mode selection These bits select the buffer modes for the Voltage Reference module. 00 Bandgap on only, for stabilization and startup 01 High power buffer mode enabled 10 Low-power buffer mode enabled 11 Reserved |

32.3 Functional Description

The Voltage Reference is a bandgap buffer system. Unity gain amplifiers are used.

The VREF_OUT signal can be used by both internal and external peripherals in low and high power buffer mode. A 100 nF capacitor must always be connected between VREF_OUT and VSSA if the VREF is being used.

The following table shows all possible function configurations of the Voltage Reference.

Table 32-2. Voltage Reference function configurations

| SC[VREFEN] | SC[MODE_LV] | Configuration | Functionality |
|------------|-------------|---|---|
| 0 | X | Voltage Reference disabled | Off |
| 1 | 00 | Voltage Reference enabled, bandgap on only | Startup and standby |
| 1 | 01 | Voltage Reference enabled, high-power buffer on | VREF_OUT available for internal and external use. 100 nF capacitor is required. |
| 1 | 10 | Voltage Reference enabled, low power buffer on | VREF_OUT available for internal and external use. 100 nF capacitor is required. |
| 1 | 11 | Reserved | Reserved |

32.3.1 Voltage Reference Disabled, SC[VREFEN] = 0

When SC[VREFEN] = 0, the Voltage Reference is disabled, the VREF bandgap and the output buffers are disabled. The Voltage Reference is in off mode.

32.3.2 Voltage Reference Enabled, SC[VREFEN] = 1

When SC[VREFEN] = 1, the Voltage Reference is enabled, and different modes should be set by the SC[MODE_LV] bits.

32.3.2.1 SC[MODE_LV]=00

The internal VREF bandgap is enabled to generate an accurate 1.2 V output that can be trimmed with the TRM register's TRIM[5:0] bitfield. The bandgap requires some time for startup and stabilization. SC[VREFST] can be monitored to determine if the stabilization and startup is complete when the chop oscillator is not enabled.

If the chop oscillator is being used, the internal bandgap reference voltage settles within the chop oscillator start up time, Tchop_osc_stup.

The output buffer is disabled in this mode, and there is no buffered voltage output. The Voltage Reference is in standby mode. If this mode is first selected and the low power or high power buffer mode is subsequently enabled, there will be a delay before the buffer output is settled at the final value. This is the buffer start up delay (Tstup) and the value is specified in the appropriate device data sheet.

32.3.2.2 SC[MODE_LV] = 01

The internal VREF bandgap is on. The high power buffer is enabled to generate a buffered 1.2 V voltage to VREF_OUT. It can also be used as a reference to internal analog peripherals such as an ADC channel or analog comparator input.

If this mode is entered from the standby mode (SC[MODE_LV] = 00, SC[VREFEN] = 1) there will be a delay before the buffer output is settled at the final value. This is the buffer start up delay (Tstup) and the value is specified in the appropriate device data sheet. If this mode is entered when the VREF module is enabled then you must wait the longer of Tstup or until SC[VREFST] = 1 when the chop oscillator is not enabled. If the chop oscillator is being used, you must wait the time specified by Tchop_osc_stup (chop oscillator start up time) to ensure the VREF output has stabilized.

In this mode, a 100 nF capacitor is required to connect between the VREF_OUT pin and VSSA.

32.3.2.3 SC[MODE_LV] = 10

The internal VREF bandgap is on. The low power buffer is enabled to generate a buffered 1.2 V voltage to VREF_OUT. It can also be used as a reference to internal analog peripherals such as an ADC channel or analog comparator input.

If this mode is entered from the standby mode (SC[MODE_LV] = 00, SC[VREFEN] = 1) there will be a delay before the buffer output is settled at the final value. This is the buffer start up delay (Tstup) and the value is specified in the appropriate device data sheet. If this mode is entered when the VREF module is enabled then you must wait the longer of Tstup or until SC[VREFST] = 1 when the chop oscillator is not enabled. If the chop oscillator is being used, you must wait the time specified by Tchop_osc_stup (chop oscillator start up time) to ensure the VREF output has stabilized.

In this mode, a 100 nF capacitor is required to connect between the VREF_OUT pin and VSSA.

32.3.2.4 SC[MODE_LV] = 11

Reserved

32.4 Initialization/Application Information

The Voltage Reference requires some time for startup and stabilization. After $SC[VREFEN] = 1$, $SC[VREFST]$ can be monitored to determine if the stabilization and startup is completed when the chop oscillator is not enabled. When the chop oscillator is enabled, the settling time of the internal bandgap reference is defined by $T_{chop_osc_stup}$ (chop oscillator start up time). You must wait this time ($T_{chop_osc_stup}$) after the internal bandgap has been enabled to ensure the VREF internal reference voltage has stabilized.

When the Voltage Reference is already enabled and stabilized, changing $SC[MODE_LV]$ will not clear $SC[VREFST]$ but there will be some startup time before the output voltage at the VREF_OUT pin has settled. This is the buffer start up delay (T_{stup}) and the value is specified in the appropriate device data sheet. Also, there will be some settling time when a step change of the load current is applied to the VREF_OUT pin. When the 1.75V VREF regulator is disabled, the VREF_OUT voltage will be more sensitive to supply voltage variation. It is recommended to use this regulator to achieve optimum VREF_OUT performance.

The $TRM[CHOPEN]$, $SC[REGEN]$ and $SC[ICOMPEN]$ bits must be written to 1 to achieve the performance stated in the device data sheet.

Chapter 33

Timer/PWM Module (TPM)

33.1 Introduction

The TPM (Timer/PWM Module) is a 2- to 8-channel timer which supports input capture, output compare, and the generation of PWM signals to control electric motor and power management applications.

The counter, compare and capture registers are clocked by an asynchronous clock that can remain enabled in low power modes. An example of using the TPM with the asynchronous DMA is described in [AN4631:Using the Asynchronous DMA features of the Kinetis L Series](#) .

33.1.1 TPM Philosophy

The TPM is built upon a very simple timer (HCS08 Timer PWM Module – TPM) used for many years on NXP's 8-bit microcontrollers. The TPM extends the functionality to support operation in low power modes by clocking the counter, compare and capture registers from an asynchronous clock that can remain functional in low power modes.

33.1.2 Features

The TPM features include:

- TPM clock mode is selectable
 - Can increment on every edge of the asynchronous counter clock
 - Can increment on rising edge of an external clock input synchronized to the asynchronous counter clock
- Prescaler divide-by 1, 2, 4, 8, 16, 32, 64, or 128

- TPM includes a 16-bit counter
 - It can be a free-running counter or modulo counter
 - The counting can be up or up-down
- Includes 4 channels that can be configured for input capture, output compare, edge-aligned PWM mode, or center-aligned PWM mode
 - In input capture mode the capture can occur on rising edges, falling edges or both edges
 - In output compare mode the output signal can be set, cleared, pulsed, or toggled on match
 - All channels can be configured for edge-aligned PWM mode or center-aligned PWM mode
- Support the generation of an interrupt and/or DMA request per channel
- Support the generation of an interrupt and/or DMA request when the counter overflows
- Support selectable trigger input to optionally reset or cause the counter to start incrementing.
 - The counter can also optionally stop incrementing on counter overflow
- Support the generation of hardware triggers when the counter overflows and per channel

33.1.3 Modes of operation

During debug mode, the TPM can be configured to temporarily pause all counting until the core returns to normal user operating mode or to operate normally. When the counter is paused, trigger inputs and input capture events are ignored.

During doze mode, the TPM can be configured to operate normally or to pause all counting for the duration of doze mode. When the counter is paused, trigger inputs and input capture events are ignored.

During stop mode, the TPM counter clock can remain functional and the TPM can generate an asynchronous interrupt to exit the MCU from stop mode.

33.1.4 Block diagram

The TPM uses one input/output (I/O) pin per channel, CH_n (TPM channel (n)) where n is the channel number.

The following figure shows the TPM structure. The central component of the TPM is the 16-bit counter with programmable final value and its counting can be up or up-down.

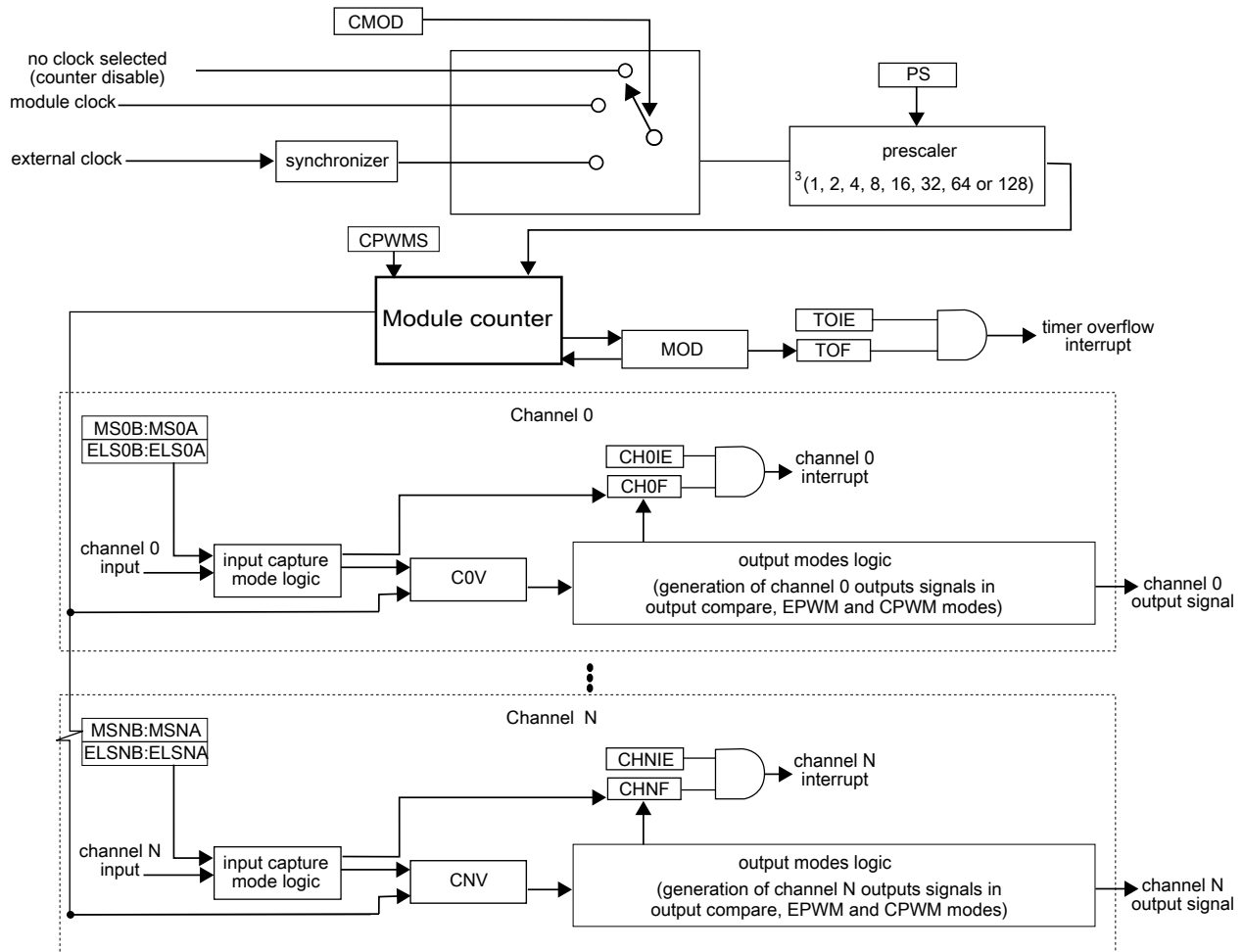

Figure 33-1. TPM block diagram

33.2 TPM Signal Descriptions

Table 33-1 shows the user-accessible signals for the TPM.

Table 33-1. TPM signal descriptions

| Signal | Description | I/O |
|------------|---|-----|
| TPM_EXTCLK | External clock. TPM external clock can be selected to increment the TPM counter on every rising edge synchronized to the counter clock. | I |
| TPM_CHn | TPM channel (n = 3 to 0). A TPM channel pin is configured as output when configured in an output compare or PWM mode and the TPM counter is enabled, otherwise the TPM channel pin is an input. | I/O |

33.2.1 TPM_EXTCLK — TPM External Clock

The rising edge of the external input signal is used to increment the TPM counter if selected by CMOD[1:0] bits in the SC register. This input signal must be less than half of the TPM counter clock frequency. The TPM counter prescaler selection and settings are also used when an external input is selected.

33.2.2 TPM_CHn — TPM Channel (n) I/O Pin

Each TPM channel can be configured to operate either as input or output. The direction associated with each channel, input or output, is selected according to the mode assigned for that channel.

33.3 Memory Map and Register Definition

This section provides a detailed description of all TPM registers.

Attempting to access a reserved register location in the TPM memory map will generate a bus error.

TPM memory map

| Absolute address (hex) | Register name | Width (in bits) | Access | Reset value | Section/page |
|------------------------|--|-----------------|--------|-------------|----------------------------|
| 4003_8000 | Status and Control (TPM0_SC) | 32 | R/W | 0000_0000h | 33.3.1/720 |
| 4003_8004 | Counter (TPM0_CNT) | 32 | R/W | 0000_0000h | 33.3.2/722 |
| 4003_8008 | Modulo (TPM0_MOD) | 32 | R/W | 0000_FFFFh | 33.3.3/722 |
| 4003_800C | Channel (n) Status and Control (TPM0_C0SC) | 32 | R/W | 0000_0000h | 33.3.4/723 |
| 4003_8010 | Channel (n) Value (TPM0_C0V) | 32 | R/W | 0000_0000h | 33.3.5/725 |
| 4003_8014 | Channel (n) Status and Control (TPM0_C1SC) | 32 | R/W | 0000_0000h | 33.3.4/723 |

Table continues on the next page...

TPM memory map (continued)

| Absolute address (hex) | Register name | Width (in bits) | Access | Reset value | Section/page |
|------------------------|---|-----------------|--------|-------------|-----------------------------|
| 4003_8018 | Channel (n) Value (TPM0_C1V) | 32 | R/W | 0000_0000h | 33.3.5/725 |
| 4003_801C | Channel (n) Status and Control (TPM0_C2SC) | 32 | R/W | 0000_0000h | 33.3.4/723 |
| 4003_8020 | Channel (n) Value (TPM0_C2V) | 32 | R/W | 0000_0000h | 33.3.5/725 |
| 4003_8024 | Channel (n) Status and Control (TPM0_C3SC) | 32 | R/W | 0000_0000h | 33.3.4/723 |
| 4003_8028 | Channel (n) Value (TPM0_C3V) | 32 | R/W | 0000_0000h | 33.3.5/725 |
| 4003_8050 | Capture and Compare Status (TPM0_STATUS) | 32 | R/W | 0000_0000h | 33.3.6/726 |
| 4003_8064 | Combine Channel Register (TPM0_COMBINE) | 32 | R/W | 0000_0000h | 33.3.7/728 |
| 4003_8070 | Channel Polarity (TPM0_POL) | 32 | R/W | 0000_0000h | 33.3.8/729 |
| 4003_8078 | Filter Control (TPM0_FILTER) | 32 | R/W | 0000_0000h | 33.3.9/730 |
| 4003_8080 | Quadrature Decoder Control and Status (TPM0_QDCTRL) | 32 | R/W | 0000_0000h | 33.3.10/731 |
| 4003_8084 | Configuration (TPM0_CONF) | 32 | R/W | 0000_0000h | 33.3.11/732 |
| 4003_9000 | Status and Control (TPM1_SC) | 32 | R/W | 0000_0000h | 33.3.1/720 |
| 4003_9004 | Counter (TPM1_CNT) | 32 | R/W | 0000_0000h | 33.3.2/722 |
| 4003_9008 | Modulo (TPM1_MOD) | 32 | R/W | 0000_FFFFh | 33.3.3/722 |
| 4003_900C | Channel (n) Status and Control (TPM1_C0SC) | 32 | R/W | 0000_0000h | 33.3.4/723 |
| 4003_9010 | Channel (n) Value (TPM1_C0V) | 32 | R/W | 0000_0000h | 33.3.5/725 |
| 4003_9014 | Channel (n) Status and Control (TPM1_C1SC) | 32 | R/W | 0000_0000h | 33.3.4/723 |
| 4003_9018 | Channel (n) Value (TPM1_C1V) | 32 | R/W | 0000_0000h | 33.3.5/725 |
| 4003_901C | Channel (n) Status and Control (TPM1_C2SC) | 32 | R/W | 0000_0000h | 33.3.4/723 |
| 4003_9020 | Channel (n) Value (TPM1_C2V) | 32 | R/W | 0000_0000h | 33.3.5/725 |
| 4003_9024 | Channel (n) Status and Control (TPM1_C3SC) | 32 | R/W | 0000_0000h | 33.3.4/723 |
| 4003_9028 | Channel (n) Value (TPM1_C3V) | 32 | R/W | 0000_0000h | 33.3.5/725 |
| 4003_9050 | Capture and Compare Status (TPM1_STATUS) | 32 | R/W | 0000_0000h | 33.3.6/726 |
| 4003_9064 | Combine Channel Register (TPM1_COMBINE) | 32 | R/W | 0000_0000h | 33.3.7/728 |
| 4003_9070 | Channel Polarity (TPM1_POL) | 32 | R/W | 0000_0000h | 33.3.8/729 |
| 4003_9078 | Filter Control (TPM1_FILTER) | 32 | R/W | 0000_0000h | 33.3.9/730 |
| 4003_9080 | Quadrature Decoder Control and Status (TPM1_QDCTRL) | 32 | R/W | 0000_0000h | 33.3.10/731 |
| 4003_9084 | Configuration (TPM1_CONF) | 32 | R/W | 0000_0000h | 33.3.11/732 |
| 4003_A000 | Status and Control (TPM2_SC) | 32 | R/W | 0000_0000h | 33.3.1/720 |
| 4003_A004 | Counter (TPM2_CNT) | 32 | R/W | 0000_0000h | 33.3.2/722 |
| 4003_A008 | Modulo (TPM2_MOD) | 32 | R/W | 0000_FFFFh | 33.3.3/722 |
| 4003_A00C | Channel (n) Status and Control (TPM2_C0SC) | 32 | R/W | 0000_0000h | 33.3.4/723 |
| 4003_A010 | Channel (n) Value (TPM2_C0V) | 32 | R/W | 0000_0000h | 33.3.5/725 |
| 4003_A014 | Channel (n) Status and Control (TPM2_C1SC) | 32 | R/W | 0000_0000h | 33.3.4/723 |
| 4003_A018 | Channel (n) Value (TPM2_C1V) | 32 | R/W | 0000_0000h | 33.3.5/725 |

Table continues on the next page...

TPM memory map (continued)

| Absolute address (hex) | Register name | Width (in bits) | Access | Reset value | Section/page |
|------------------------|---|-----------------|--------|-------------|-----------------------------|
| 4003_A01C | Channel (n) Status and Control (TPM2_C2SC) | 32 | R/W | 0000_0000h | 33.3.4/723 |
| 4003_A020 | Channel (n) Value (TPM2_C2V) | 32 | R/W | 0000_0000h | 33.3.5/725 |
| 4003_A024 | Channel (n) Status and Control (TPM2_C3SC) | 32 | R/W | 0000_0000h | 33.3.4/723 |
| 4003_A028 | Channel (n) Value (TPM2_C3V) | 32 | R/W | 0000_0000h | 33.3.5/725 |
| 4003_A050 | Capture and Compare Status (TPM2_STATUS) | 32 | R/W | 0000_0000h | 33.3.6/726 |
| 4003_A064 | Combine Channel Register (TPM2_COMBINE) | 32 | R/W | 0000_0000h | 33.3.7/728 |
| 4003_A070 | Channel Polarity (TPM2_POL) | 32 | R/W | 0000_0000h | 33.3.8/729 |
| 4003_A078 | Filter Control (TPM2_FILTER) | 32 | R/W | 0000_0000h | 33.3.9/730 |
| 4003_A080 | Quadrature Decoder Control and Status (TPM2_QDCTRL) | 32 | R/W | 0000_0000h | 33.3.10/731 |
| 4003_A084 | Configuration (TPM2_CONF) | 32 | R/W | 0000_0000h | 33.3.11/732 |

33.3.1 Status and Control (TPMx_SC)

SC contains the overflow status flag and control bits used to configure the interrupt enable, module configuration and prescaler factor. These controls relate to all channels within this module.

Address: Base address + 0h offset

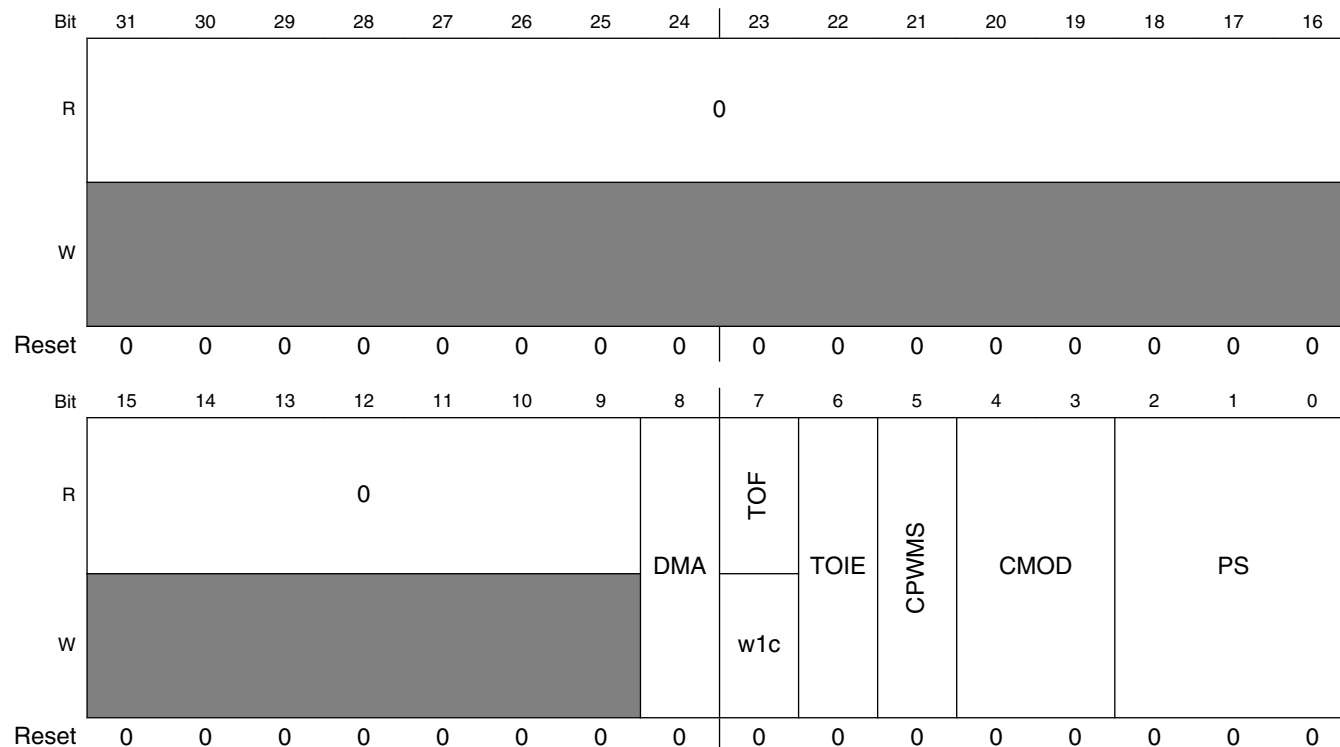

TPMx_SC field descriptions

| Field | Description |
|------------------|--|
| 31–9 Reserved | This field is reserved. This read-only field is reserved and always has the value 0. |
| 8 DMA | DMA Enable Enables DMA transfers for the overflow flag. 0 Disables DMA transfers. 1 Enables DMA transfers. |
| 7 TOF | Timer Overflow Flag Set by hardware when the TPM counter equals the value in the MOD register and increments. Writing a 1 to TOF clears it. Writing a 0 to TOF has no effect. If another TPM overflow occurs between the flag setting and the flag clearing, the write operation has no effect; therefore, TOF remains set indicating another overflow has occurred. In this case a TOF interrupt request is not lost due to a delay in clearing the previous TOF. 0 TPM counter has not overflowed. 1 TPM counter has overflowed. |
| 6 TOIE | Timer Overflow Interrupt Enable Enables TPM overflow interrupts. 0 Disable TOF interrupts. Use software polling or DMA request. 1 Enable TOF interrupts. An interrupt is generated when TOF equals one. |
| 5 CPWMS | Center-Aligned PWM Select Selects CPWM mode. This mode configures the TPM to operate in up-down counting mode. This field is write protected. It can be written only when the counter is disabled. 0 TPM counter operates in up counting mode. 1 TPM counter operates in up-down counting mode. |
| 4–3 CMOD | Clock Mode Selection Selects the TPM counter clock modes. When disabling the counter, this field remain set until acknowledged in the TPM clock domain. 00 TPM counter is disabled 01 TPM counter increments on every TPM counter clock 10 TPM counter increments on rising edge of TPM_EXTCLK synchronized to the TPM counter clock 11 Reserved. |
| PS | Prescale Factor Selection Selects one of 8 division factors for the clock mode selected by CMOD. This field is write protected. It can be written only when the counter is disabled. 000 Divide by 1 001 Divide by 2 010 Divide by 4 011 Divide by 8 100 Divide by 16 101 Divide by 32 |

Table continues on the next page...

TPMx_SC field descriptions (continued)

| Field | Description |
|-------|---------------|
| 110 | Divide by 64 |
| 111 | Divide by 128 |

33.3.2 Counter (TPMx_CNT)

The CNT register contains the TPM counter value.

Reset clears the CNT register. Writing any value to COUNT also clears the counter.

When debug is active, the TPM counter does not increment unless configured otherwise.

Reading the CNT register adds two wait states to the register access due to synchronization delays.

Address: Base address + 4h offset

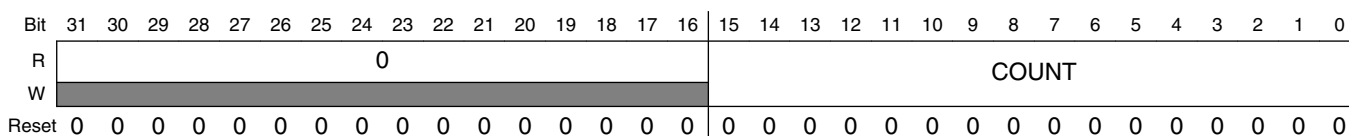

TPMx_CNT field descriptions

| Field | Description |
|-------------------|---|
| 31–16 Reserved | This field is reserved. This read-only field is reserved and always has the value 0. |
| COUNT | Counter value |

33.3.3 Modulo (TPMx_MOD)

The Modulo register contains the modulo value for the TPM counter. When the TPM counter reaches the modulo value and increments, the overflow flag (TOF) is set and the next value of TPM counter depends on the selected counting method (see [Counter](#)).

Writing to the MOD register latches the value into a buffer. The MOD register is updated with the value of its write buffer according to [MOD Register Update](#) . Additional writes to the MOD write buffer are ignored until the register has been updated.

It is recommended to initialize the TPM counter (write to CNT) before writing to the MOD register to avoid confusion about when the first counter overflow will occur.

Address: Base address + 8h offset

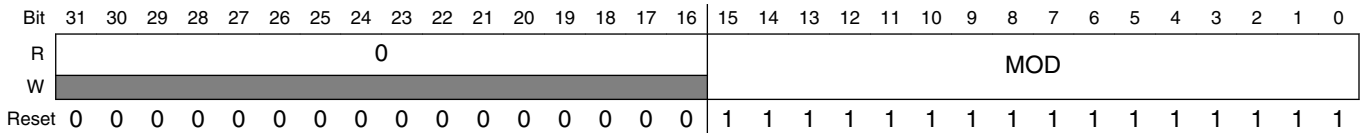

TPMx_MOD field descriptions

| Field | Description |
|-------------------|---|
| 31–16 Reserved | This field is reserved. This read-only field is reserved and always has the value 0. |
| MOD | Modulo value This field must be written with single 16-bit or 32-bit access. |

33.3.4 Channel (n) Status and Control (TPMx_CnSC)

CnSC contains the channel-interrupt-status flag and control bits used to configure the interrupt enable, channel configuration, and pin function. When switching from one channel mode to a different channel mode, the channel must first be disabled and this must be acknowledged in the TPM counter clock domain.

Table 33-2. Mode, Edge, and Level Selection

| CPWMS | MSnB:MSnA | ELSnB:ELSnA | Mode | Configuration |
|-------|-----------|-------------|------------------|--|
| X | 00 | 00 | None | Channel disabled |
| X | 01 | 00 | Software compare | Pin not used for TPM |
| 0 | 00 | 01 | Input capture | Capture on Rising Edge Only |
| | | 10 | | Capture on Falling Edge Only |
| | | 11 | | Capture on Rising or Falling Edge |
| | 01 | 01 | Output compare | Toggle Output on match |
| | | 10 | | Clear Output on match |
| | | 11 | | Set Output on match |
| | 10 | 10 | Edge-aligned PWM | High-true pulses (clear Output on match, set Output on reload) |
| | | | | Low-true pulses (set Output on match, clear Output on reload) |
| | 11 | 10 | Output compare | Pulse Output low on match |
| | | | | 01 |

Table continues on the next page...

Table 33-2. Mode, Edge, and Level Selection (continued)

| CPWMS | MSnB:MSnA | ELSnB:ELSnA | Mode | Configuration |
|-------|-----------|-------------|--------------------|---|
| 1 | 10 | 10 | Center-aligned PWM | High-true pulses (clear Output on match-up, set Output on match-down) |
| | | 01 | | Low-true pulses (set Output on match-up, clear Output on match-down) |

Address: Base address + Ch offset + (8d × i), where i=0d to 3d

| | | | | | | | | | | | | | | | | |
|-------|----------|----|----|----|----|----|----|----|-----|------|-----|-----|------|------|----------|-----|
| Bit | 31 | 30 | 29 | 28 | 27 | 26 | 25 | 24 | 23 | 22 | 21 | 20 | 19 | 18 | 17 | 16 |
| R | 0 | | | | | | | | | | | | | | | |
| W | [Shaded] | | | | | | | | | | | | | | | |
| Reset | 0 | 0 | 0 | 0 | 0 | 0 | 0 | 0 | 0 | 0 | 0 | 0 | 0 | 0 | 0 | 0 |
| Bit | 15 | 14 | 13 | 12 | 11 | 10 | 9 | 8 | 7 | 6 | 5 | 4 | 3 | 2 | 1 | 0 |
| R | 0 | | | | | | | | CHF | | | | | | 0 | |
| W | [Shaded] | | | | | | | | w1c | CHIE | MSB | MSA | ELSB | ELSA | [Shaded] | DMA |
| Reset | 0 | 0 | 0 | 0 | 0 | 0 | 0 | 0 | 0 | 0 | 0 | 0 | 0 | 0 | 0 | 0 |

TPMx_CnSC field descriptions

| Field | Description |
|------------------|---|
| 31–8 Reserved | This field is reserved. This read-only field is reserved and always has the value 0. |
| 7 CHF | Channel Flag Set by hardware when an event occurs on the channel. CHF is cleared by writing a 1 to the CHF bit. Writing a 0 to CHF has no effect. If another event occurs between the CHF sets and the write operation, the write operation has no effect; therefore, CHF remains set indicating another event has occurred. In this case a CHF interrupt request is not lost due to the delay in clearing the previous CHF. 0 No channel event has occurred. 1 A channel event has occurred. |
| 6 CHIE | Channel Interrupt Enable Enables channel interrupts. 0 Disable channel interrupts. 1 Enable channel interrupts. |
| 5 MSB | Channel Mode Select Used for further selections in the channel logic. Its functionality is dependent on the channel mode. When a channel is disabled, this field will not change state until acknowledged in the TPM counter clock domain. |
| 4 MSA | Channel Mode Select |

Table continues on the next page...

TPMx_CnSC field descriptions (continued)

| Field | Description |
|---------------|--|
| | Used for further selections in the channel logic. Its functionality is dependent on the channel mode. When a channel is disabled, this field will not change state until acknowledged in the TPM counter clock domain. |
| 3 ELSB | Edge or Level Select The functionality of ELSB and ELSA depends on the channel mode. When a channel is disabled, this field will not change state until acknowledged in the TPM counter clock domain. |
| 2 ELSA | Edge or Level Select The functionality of ELSB and ELSA depends on the channel mode. When a channel is disabled, this field will not change state until acknowledged in the TPM counter clock domain. |
| 1 Reserved | This field is reserved. This read-only field is reserved and always has the value 0. |
| 0 DMA | DMA Enable Enables DMA transfers for the channel. 0 Disable DMA transfers. 1 Enable DMA transfers. |

33.3.5 Channel (n) Value (TPMx_CnV)

These registers contain the captured TPM counter value for the input modes or the match value for the output modes.

In input capture mode, any write to a CnV register is ignored.

In compare modes, writing to a CnV register latches the value into a buffer. A CnV register is updated with the value of its write buffer according to [CnV Register Update](#). Additional writes to the CnV write buffer are ignored until the register has been updated.

Address: Base address + 10h offset + (8d × i), where i=0d to 3d

| | | | | | | | | | | | | | | | | | | | | | | | | | | | | | | | | |
|-------|----|----|----|----|----|----|----|----|----|----|----|----|----|----|----|----|-----|----|----|----|----|----|---|---|---|---|---|---|---|---|---|---|
| Bit | 31 | 30 | 29 | 28 | 27 | 26 | 25 | 24 | 23 | 22 | 21 | 20 | 19 | 18 | 17 | 16 | 15 | 14 | 13 | 12 | 11 | 10 | 9 | 8 | 7 | 6 | 5 | 4 | 3 | 2 | 1 | 0 |
| R | 0 | | | | | | | | | | | | | | | | VAL | | | | | | | | | | | | | | | |
| W | 0 | | | | | | | | | | | | | | | | 0 | | | | | | | | | | | | | | | |
| Reset | 0 | 0 | 0 | 0 | 0 | 0 | 0 | 0 | 0 | 0 | 0 | 0 | 0 | 0 | 0 | 0 | 0 | 0 | 0 | 0 | 0 | 0 | 0 | 0 | 0 | 0 | 0 | 0 | 0 | 0 | 0 | 0 |

TPMx_CnV field descriptions

| Field | Description |
|-------------------|---|
| 31–16 Reserved | This field is reserved. This read-only field is reserved and always has the value 0. |
| VAL | Channel Value Captured TPM counter value of the input modes or the match value for the output modes. This field must be written with single 16-bit or 32-bit access. |

33.3.6 Capture and Compare Status (TPMx_STATUS)

The STATUS register contains a copy of the status flag, CnSC[CHnF] for each TPM channel, as well as SC[TOF], for software convenience.

Each CHnF bit in STATUS is a mirror of CHnF bit in CnSC. All CHnF bits can be checked using only one read of STATUS. All CHnF bits can be cleared by writing all ones to STATUS.

Hardware sets the individual channel flags when an event occurs on the channel. Writing a 1 to CHF clears it. Writing a 0 to CHF has no effect.

If another event occurs between the flag setting and the write operation, the write operation has no effect; therefore, CHF remains set indicating another event has occurred. In this case a CHF interrupt request is not lost due to the clearing sequence for a previous CHF.

Address: Base address + 50h offset

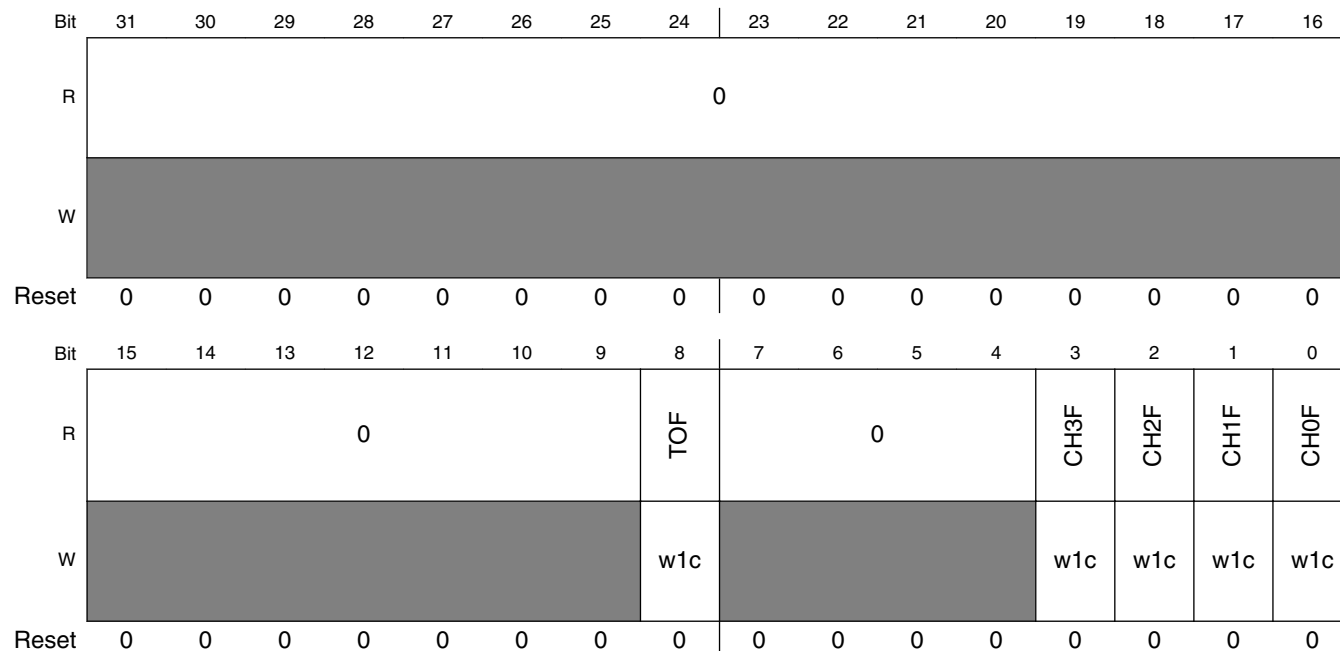

TPMx_STATUS field descriptions

| Field | Description |
|------------------|---|
| 31–9 Reserved | This field is reserved. This read-only field is reserved and always has the value 0. |
| 8 TOF | Timer Overflow Flag See register description |

Table continues on the next page...

TPMx_STATUS field descriptions (continued)

| Field | Description |
|-----------------|--|
| | 0 TPM counter has not overflowed. 1 TPM counter has overflowed. |
| 7-4 Reserved | This field is reserved. This read-only field is reserved and always has the value 0. |
| 3 CH3F | Channel 3 Flag See the register description. 0 No channel event has occurred. 1 A channel event has occurred. |
| 2 CH2F | Channel 2 Flag See the register description. 0 No channel event has occurred. 1 A channel event has occurred. |
| 1 CH1F | Channel 1 Flag See the register description. 0 No channel event has occurred. 1 A channel event has occurred. |
| 0 CH0F | Channel 0 Flag See the register description. 0 No channel event has occurred. 1 A channel event has occurred. |

33.3.7 Combine Channel Register (TPMx_COMBINE)

This register contains the control bits used to configure the combine channel modes for each pair of channels (n) and (n+1), where n is all the even numbered channels.

Address: Base address + 64h offset

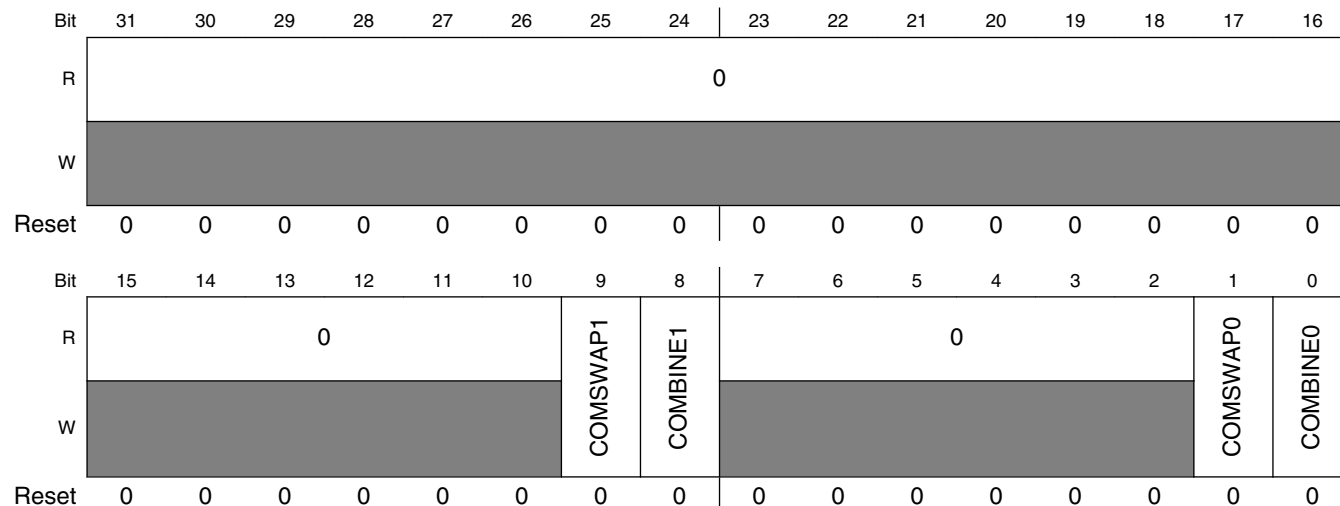

TPMx_COMBINE field descriptions

| Field | Description |
|-------------------|--|
| 31–16 Reserved | This field is reserved. This read-only field is reserved and always has the value 0. |
| 15–10 Reserved | This field is reserved. This read-only field is reserved and always has the value 0. |
| 9 COMSWAP1 | Combine Channels 2 and 3 Swap When set in combine mode, the odd channel is used for the input capture and 1st compare, the even channel is used for the 2nd compare. 0 Even channel is used for input capture and 1st compare. 1 Odd channel is used for input capture and 1st compare. |
| 8 COMBINE1 | Combine Channels 2 and 3 Enables the combine feature for channels 2 and 3. In input capture mode, the combined channels use the even channel input. In software compare modes, the even channel match asserts the output trigger and the odd channel match negates the output trigger. In PWM modes, the even channel match is used for the 1st compare and odd channel match for the 2nd compare. 0 Channels 2 and 3 are independent. 1 Channels 2 and 3 are combined. |
| 7–2 Reserved | This field is reserved. This read-only field is reserved and always has the value 0. |
| 1 COMSWAP0 | Combine Channel 0 and 1 Swap |

Table continues on the next page...

TPMx_COMBINE field descriptions (continued)

| Field | Description |
|---------------|--|
| | When set in combine mode, the even channel is used for the input capture and 1st compare, the odd channel is used for the 2nd compare. 0 Even channel is used for input capture and 1st compare. 1 Odd channel is used for input capture and 1st compare. |
| 0 COMBINE0 | Combine Channels 0 and 1 Enables the combine feature for channels 0 and 1. In input capture mode, the combined channels use the even channel input. In software compare modes, the even channel match asserts the output trigger and the odd channel match negates the output trigger. In PWM modes, the even channel match is used for the 1st compare and odd channel match for the 2nd compare. 0 Channels 0 and 1 are independent. 1 Channels 0 and 1 are combined. |

33.3.8 Channel Polarity (TPMx_POL)

This register defines the input and output polarity of each of the channels.

Address: Base address + 70h offset

| | | | | | | | | | | | | | | | | |
|-------|----|----|----|----|----|----|----|----|----|----|----|----|------|------|------|------|
| Bit | 31 | 30 | 29 | 28 | 27 | 26 | 25 | 24 | 23 | 22 | 21 | 20 | 19 | 18 | 17 | 16 |
| R | 0 | | | | | | | | | | | | | | | |
| W | | | | | | | | | | | | | | | | |
| Reset | 0 | 0 | 0 | 0 | 0 | 0 | 0 | 0 | 0 | 0 | 0 | 0 | 0 | 0 | 0 | 0 |
| Bit | 15 | 14 | 13 | 12 | 11 | 10 | 9 | 8 | 7 | 6 | 5 | 4 | 3 | 2 | 1 | 0 |
| R | 0 | | | | | | | | | | | | POL3 | POL2 | POL1 | POL0 |
| W | | | | | | | | | | | | | | | | |
| Reset | 0 | 0 | 0 | 0 | 0 | 0 | 0 | 0 | 0 | 0 | 0 | 0 | 0 | 0 | 0 | 0 |

TPMx_POL field descriptions

| Field | Description |
|------------------|---|
| 31–4 Reserved | This field is reserved. This read-only field is reserved and always has the value 0. |
| 3 POL3 | Channel 3 Polarity 0 The channel polarity is active high. 1 The channel polarity is active low. |
| 2 POL2 | Channel 2 Polarity 0 The channel polarity is active high. 1 The channel polarity is active low. |
| 1 POL1 | Channel 1 Polarity 0 The channel polarity is active high. 1 The channel polarity is active low. |

Table continues on the next page...

TPMx_POL field descriptions (continued)

| Field | Description |
|-----------|---|
| 0 POL0 | Channel 0 Polarity 0 The channel polarity is active high. 1 The channel polarity is active low. |

33.3.9 Filter Control (TPMx_FILTER)

This register selects the filter value of the channel inputs, and an additional output delay value for the channel outputs. In PWM combine modes, the filter can effectively implements deadtime insertion.

Address: Base address + 78h offset

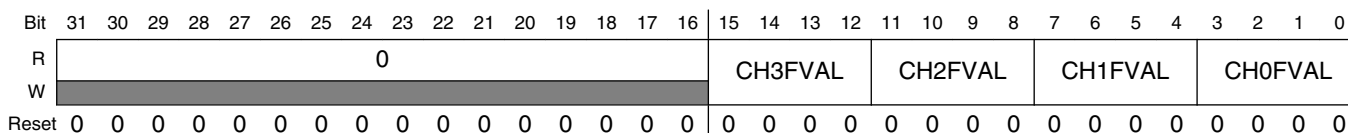

TPMx_FILTER field descriptions

| Field | Description |
|-------------------|---|
| 31–16 Reserved | This field is reserved. This read-only field is reserved and always has the value 0. |
| 15–12 CH3FVAL | Channel 3 Filter Value Selects the filter value for the channel input and the delay value for the channel output. The filter/delay is disabled when the value is zero, otherwise the filter/delay is configured as (CH3FVAL * 4) clock cycles. |
| 11–8 CH2FVAL | Channel 2 Filter Value Selects the filter value for the channel input and the delay value for the channel output. The filter/delay is disabled when the value is zero, otherwise the filter/delay is configured as (CH2FVAL * 4) clock cycles. |
| 7–4 CH1FVAL | Channel 1 Filter Value Selects the filter value for the channel input and the delay value for the channel output. The filter/delay is disabled when the value is zero, otherwise the filter/delay is configured as (CH1FVAL * 4) clock cycles. |
| CH0FVAL | Channel 0 Filter Value Selects the filter value for the channel input and the delay value for the channel output. The filter/delay is disabled when the value is zero, otherwise the filter/delay is configured as (CH0FVAL * 4) clock cycles. |

33.3.10 Quadrature Decoder Control and Status (TPMx_QDCTRL)

This register has the control and status bits for the quadrature decoder mode.

Address: Base address + 80h offset

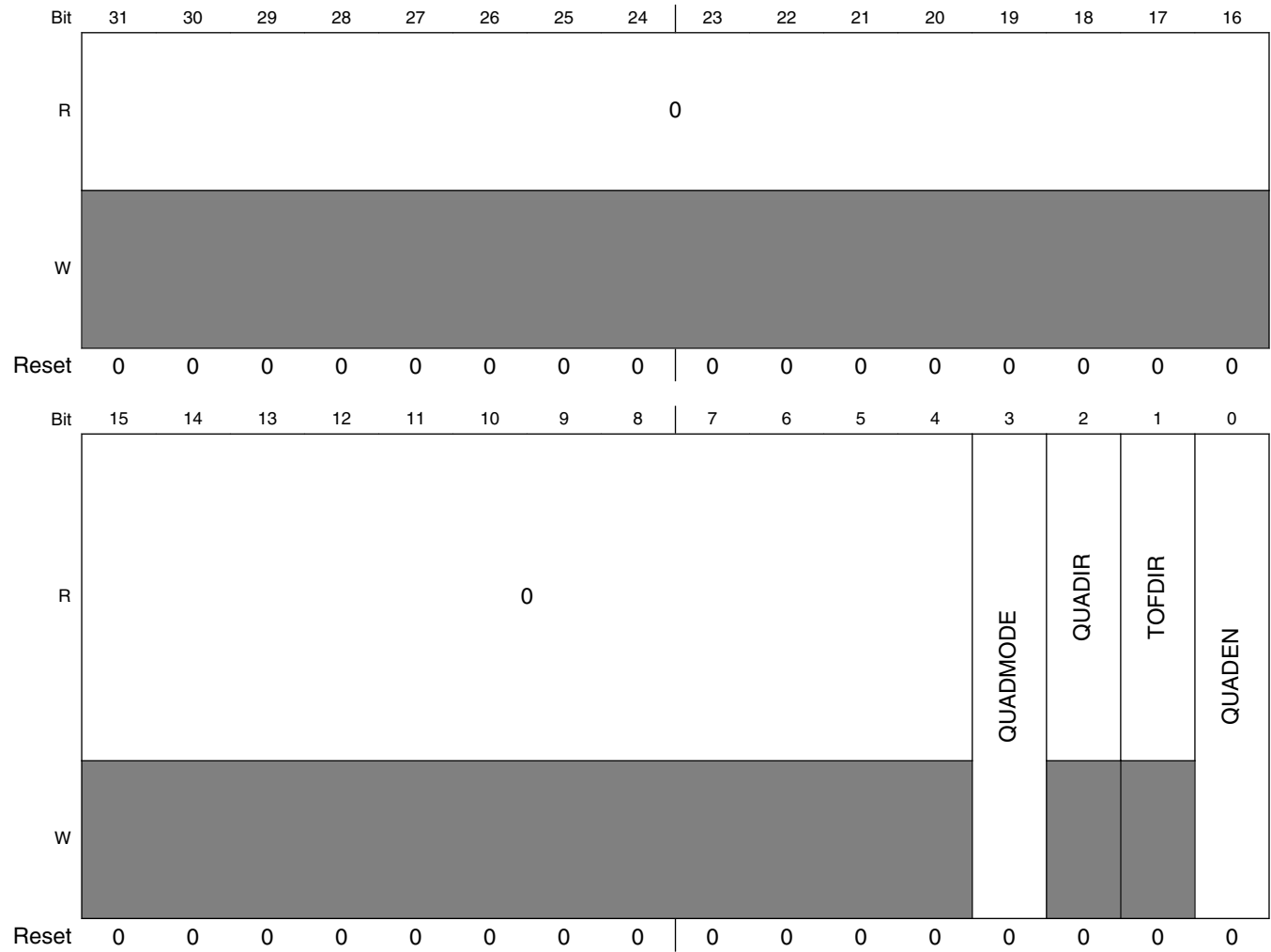

TPMx_QDCTRL field descriptions

| Field | Description |
|------------------|---|
| 31–4 Reserved | This field is reserved. This read-only field is reserved and always has the value 0. |
| 3 QUADMODE | Quadrature Decoder Mode Selects the encoding mode used in the quadrature decoder mode. 0 Phase encoding mode. 1 Count and direction encoding mode. |
| 2 QUADIR | Counter Direction in Quadrature Decode Mode |

Table continues on the next page...

TPMx_QDCTRL field descriptions (continued)

| Field | Description |
|-------------|---|
| | Indicates the counting direction. 0 Counter direction is decreasing (counter decrement). 1 Counter direction is increasing (counter increment). |
| 1 TOFDIR | Indicates if the TOF bit was set on the top or the bottom of counting. 0 TOF bit was set on the bottom of counting. There was an FTM counter decrement and FTM counter changes from its minimum value (zero) to its maximum value (MOD register). 1 TOF bit was set on the top of counting. There was an FTM counter increment and FTM counter changes from its maximum value (MOD register) to its minimum value (zero). |
| 0 QUADEN | Enables the quadrature decoder mode. In this mode, the channel 0 and channel 1 inputs control the TPM counter direction and can only be used for software compare. The quadrature decoder mode has precedence over the other modes. 0 Quadrature decoder mode is disabled. 1 Quadrature decoder mode is enabled. |

33.3.11 Configuration (TPMx_CONF)

This register selects the behavior in debug and wait modes and the use of an external global time base.

Address: Base address + 84h offset

| | | | | | | | | | | | | | | | | |
|-------|----------|----|----|----|----------|----|----|----|----------|----------|----------|----|----------|----------|----------|----------|
| Bit | 31 | 30 | 29 | 28 | 27 | 26 | 25 | 24 | 23 | 22 | 21 | 20 | 19 | 18 | 17 | 16 |
| R | 0 | | | | TRGSEL | | | | TRGSRC | TRGPOL | 0 | | CROT | CROT | CROT | CROT |
| W | [Shaded] | | | | [Shaded] | | | | [Shaded] | [Shaded] | [Shaded] | | [Shaded] | [Shaded] | [Shaded] | [Shaded] |
| Reset | 0 | 0 | 0 | 0 | 0 | 0 | 0 | 0 | 0 | 0 | 0 | 0 | 0 | 0 | 0 | 0 |
| Bit | 15 | 14 | 13 | 12 | 11 | 10 | 9 | 8 | 7 | 6 | 5 | 4 | 3 | 2 | 1 | 0 |
| R | 0 | | | | [Shaded] | | | | GTBEEN | GTBSYNC | DBGMODE | | DOZEEN | 0 | | |
| W | [Shaded] | | | | [Shaded] | | | | [Shaded] | [Shaded] | [Shaded] | | [Shaded] | [Shaded] | | |
| Reset | 0 | 0 | 0 | 0 | 0 | 0 | 0 | 0 | 0 | 0 | 0 | 0 | 0 | 0 | 0 | 0 |

TPMx_CONF field descriptions

| Field | Description |
|-------------------|---|
| 31–28 Reserved | This field is reserved. This read-only field is reserved and always has the value 0. |

Table continues on the next page...

TPMx_CONF field descriptions (continued)

| Field | Description |
|-------------------|--|
| 27–24 TRGSEL | <p>Trigger Select</p> <p>Selects the input trigger to use for starting, reloading and/or pausing the counter. The source of the trigger (external or internal to the TPM) is configured by the TRGSRC field. This field should only be changed when the TPM counter is disabled.</p> <p>Refer to the chip configuration section for available external trigger options.</p> <p>The available internal trigger sources are listed below.</p> <p>0001 Channel 0 pin input capture 0010 Channel 1 pin input capture 0011 Channel 0 or Channel 1 pin input capture 0100 Channel 2 pin input capture 0101 Channel 0 or Channel 2 pin input capture 0110 Channel 1 or Channel 2 pin input capture 0111 Channel 0 or Channel 1 or Channel 2 pin input capture 1000 Channel 3 pin input capture 1001 Channel 0 or Channel 3 pin input capture 1010 Channel 1 or Channel 3 pin input capture 1011 Channel 0 or Channel 1 or Channel 3 pin input capture 1100 Channel 2 or Channel 3 pin input capture 1101 Channel 0 or Channel 2 or Channel 3 pin input capture 1110 Channel 1 or Channel 2 or Channel 3 pin input capture 1111 Channel 0 or Channel 1 or Channel 2 or Channel 3 pin input capture</p> |
| 23 TRGSRC | <p>Trigger Source</p> <p>Selects between internal (channel pin input capture) or external trigger sources.</p> <p>When selecting an internal trigger, the channel selected should be configured for input capture. Only a rising edge input capture can be used to initially start the counter using the CSOT configuration; either rising edge or falling edge input capture can be used to reload the counter using the CROT configuration; and the state of the channel input pin is used to pause the counter using the CPOT configuration. The channel polarity register can be used to invert the polarity of the channel input pins.</p> <p>This field should only be changed when the TPM counter is disabled.</p> <p>0 Trigger source selected by TRGSEL is external. 1 Trigger source selected by TRGSEL is internal (channel pin input capture).</p> |
| 22 TRGPOL | <p>Trigger Polarity</p> <p>Selects the polarity of the external trigger source. This field should only be changed when the TPM counter is disabled.</p> <p>0 Trigger is active high. 1 Trigger is active low.</p> |
| 21–20 Reserved | <p>This field is reserved. This read-only field is reserved and always has the value 0.</p> |
| 19 CPOT | <p>Counter Pause On Trigger</p> <p>When enabled, the counter will pause incrementing while the trigger remains asserted (level sensitive). This field should only be changed when the TPM counter is disabled.</p> |
| 18 CROT | <p>Counter Reload On Trigger</p> |

Table continues on the next page...

TPMx_CONF field descriptions (continued)

| Field | Description |
|-------------------|--|
| | <p>When set, the TPM counter will reload with 0 (and initialize PWM outputs to their default value) when a rising edge is detected on the selected trigger input.</p> <p>The trigger input is ignored if the TPM counter is paused during debug mode or doze mode. This field should only be changed when the TPM counter is disabled.</p> <p>0 Counter is not reloaded due to a rising edge on the selected input trigger 1 Counter is reloaded when a rising edge is detected on the selected input trigger</p> |
| 17 CSOO | <p>Counter Stop On Overflow</p> <p>When set, the TPM counter will stop incrementing once the counter equals the MOD value and incremented (this also sets the TOF). Reloading the counter with 0 due to writing to the counter register or due to a trigger input does not cause the counter to stop incrementing. Once the counter has stopped incrementing, the counter will not start incrementing unless it is disabled and then enabled again, or a rising edge on the selected trigger input is detected when CSOT set.</p> <p>This field should only be changed when the TPM counter is disabled.</p> <p>0 TPM counter continues incrementing or decrementing after overflow 1 TPM counter stops incrementing or decrementing after overflow.</p> |
| 16 CSOT | <p>Counter Start on Trigger</p> <p>When set, the TPM counter will not start incrementing after it is enabled until a rising edge on the selected trigger input is detected. If the TPM counter is stopped due to an overflow, a rising edge on the selected trigger input will also cause the TPM counter to start incrementing again.</p> <p>The trigger input is ignored if the TPM counter is paused during debug mode or doze mode. This field should only be changed when the TPM counter is disabled.</p> <p>0 TPM counter starts to increment immediately, once it is enabled. 1 TPM counter only starts to increment when it a rising edge on the selected input trigger is detected, after it has been enabled or after it has stopped due to overflow.</p> |
| 15–10 Reserved | <p>This field is reserved. This read-only field is reserved and always has the value 0.</p> |
| 9 GTBEEN | <p>Global time base enable</p> <p>Configures the TPM to use an externally generated global time base counter. When an externally generated timebase is used, the internal TPM counter is not used by the channels but can be used to generate a periodic interruptor DMA request using the Modulo register and timer overflow flag.</p> <p>0 All channels use the internally generated TPM counter as their timebase 1 All channels use an externally generated global timebase as their timebase</p> |
| 8 GTBSYNC | <p>Global Time Base Synchronization</p> <p>When enabled, the TPM counter is synchronized to the global time base. It uses the global timebase enable, trigger and overflow to ensure the TPM counter starts incrementing at the same time as the global timebase, stops incrementing at the same time as the global timebase and is reset at the same time as the global timebase. This field should only be changed when the TPM counter is disabled.</p> <p>0 Global timebase synchronization disabled. 1 Global timebase synchronization enabled.</p> |
| 7–6 DBGMODE | <p>Debug Mode</p> <p>Configures the TPM behavior in debug mode. All other configurations are reserved.</p> |

Table continues on the next page...

TPMx_CONF field descriptions (continued)

| Field | Description |
|-------------|---|
| | 00 TPM counter is paused and does not increment during debug mode. Trigger inputs and input capture events are also ignored. 11 TPM counter continues in debug mode. |
| 5 DOZEEN | Doze Enable Configures the TPM behavior in wait mode. 0 Internal TPM counter continues in Doze mode. 1 Internal TPM counter is paused and does not increment during Doze mode. Trigger inputs and input capture events are also ignored. |
| Reserved | This field is reserved. This read-only field is reserved and always has the value 0. |

33.4 Functional description

The following sections describe the TPM features.

33.4.1 Clock domains

The TPM module supports two clock domains.

The bus clock domain is used by the register interface and for synchronizing interrupts and DMA requests.

The TPM counter clock domain is used to clock the counter and prescaler along with the output compare and input capture logic. The TPM counter clock is considered asynchronous to the bus clock, can be a higher or lower frequency than the bus clock and can remain operational in Stop mode. Multiple TPM instances are all clocked by the same TPM counter clock in support of the external timebase feature.

33.4.1.1 Counter Clock Mode

The CMOD[1:0] bits in the SC register either disable the TPM counter or select one of two possible clock modes for the TPM counter. After any reset, CMOD[1:0] = 0:0 so the TPM counter is disabled.

The CMOD[1:0] bits may be read or written at any time. Disabling the TPM counter by writing zero to the CMOD[1:0] bits does not affect the TPM counter value or other registers, but must be acknowledged by the TPM counter clock domain before they read as zero.

Functional description

The external clock input passes through a synchronizer clocked by the TPM counter clock to assure that counter transitions are properly aligned to counter clock transitions. Therefore, to meet Nyquist criteria considering also jitter, the frequency of the external clock source must be less than half of the counter clock frequency.

33.4.2 Prescaler

The selected counter clock source passes through a prescaler that is a 7-bit counter.

The value of the prescaler is selected by the PS[2:0] bits. The following figure shows an example of the prescaler counter and TPM counter.

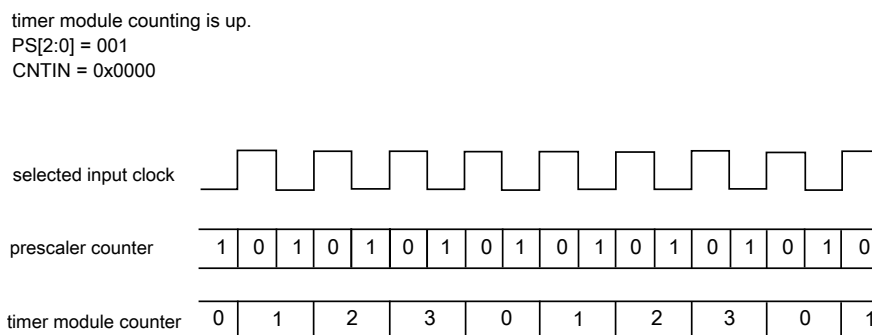

Figure 33-2. Example of the Prescaler Counter

33.4.3 Counter

The TPM has a 16-bit counter that is used by the channels either for input or output modes.

The counter updates from the selected clock divided by the prescaler.

The TPM counter has these modes of operation:

- up counting (see [Up counting](#))
- up-down counting (see [Up-down counting](#))

33.4.3.1 Up counting

Up counting is selected when SC[CPWMS] = 0.

The value of zero is loaded into the TPM counter, and the counter increments until the value of MOD is reached, at which point the counter is reloaded with zero.

The TPM period when using up counting is $(MOD + 0x0001) \times$ period of the TPM counter clock.

The TOF bit is set when the TPM counter changes from MOD to zero.

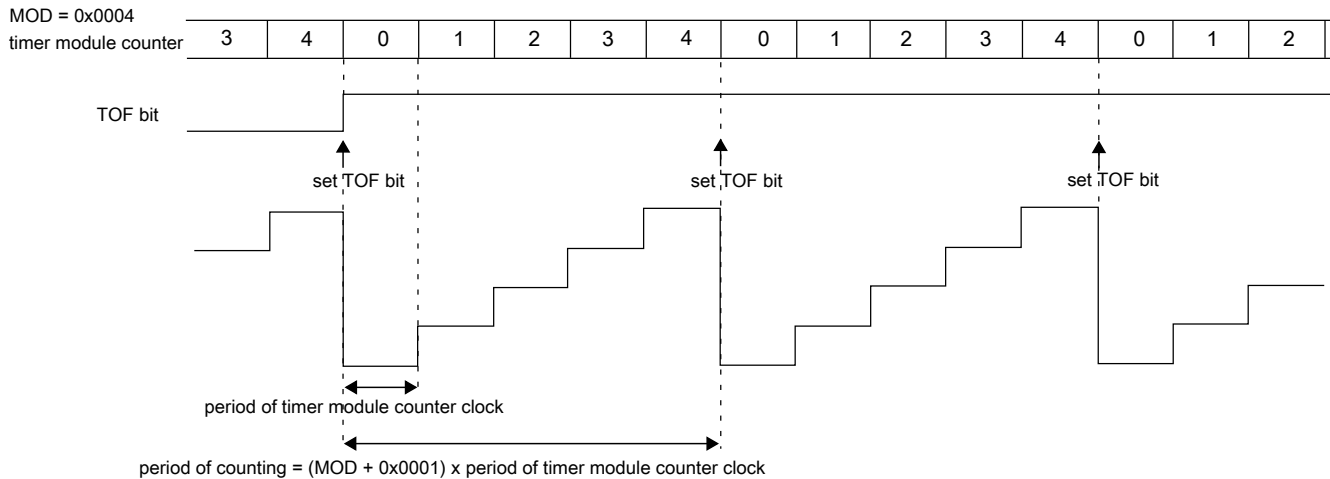

Figure 33-3. Example of TPM Up Counting

Note

- MOD = 0000 is a redundant condition. In this case, the TPM counter is always equal to MOD and the TOF bit is set in each rising edge of the TPM counter clock.

33.4.3.2 Up-down counting

Up-down counting is selected when $SC[CPWMS] = 1$. When configured for up-down counting, configuring $CONF[MOD]$ to less than 2 is not supported.

The value of 0 is loaded into the TPM counter, and the counter increments until the value of MOD is reached, at which point the counter is decremented until it returns to zero and the up-down counting restarts.

The TPM period when using up-down counting is $2 \times MOD \times$ period of the TPM counter clock.

The TOF bit is set when the TPM counter changes from MOD to $(MOD - 1)$.

Functional description

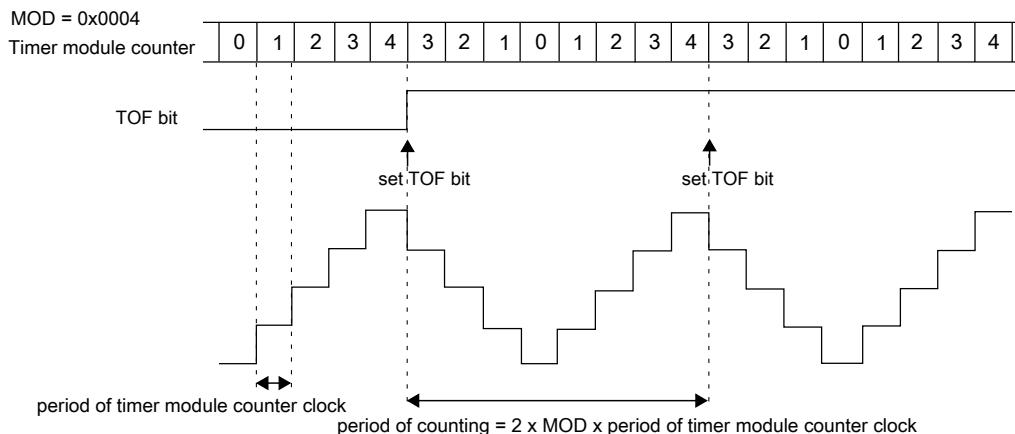

Figure 33-4. Example of up-down counting

33.4.3.3 Counter Reset

Any write to CNT resets the TPM counter and the channel outputs to their initial values (except for channels in output compare mode).

33.4.3.4 Global time base (GTB)

The global time base (GTB) is a TPM function that allows multiple TPM modules to share the same timebase. When the global time base is enabled ($\text{CONF}[\text{GTBEEN}] = 1$), the local TPM channels use the counter value, counter enable and overflow indication from the TPM generating the global time base. If the local TPM counter is not generating the global time base, then it can be used as an independent counter or pulse accumulator.

The local TPM counter can also be configured to synchronize to the global time base, by configuring ($\text{GTBSYNC} = 1$). When synchronized to the global time base, the local counter will use the counter enable and counter overflow indication from the TPM generating the global time base. This enables multiple TPM to be configured with the same phase, but with different periods (although the global time base must be configured with the longest period).

33.4.3.5 Counter trigger

The TPM counter can be configured to start, stop or reset in response to a hardware trigger input. The trigger input is synchronized to the asynchronous counter clock, so there is a 3 counter clock delay between the trigger assertion and the counter responding.

- When (CSOT = 1), the counter will not start incrementing until a rising edge is detected on the trigger input.
- When (CSOO= 1), the counter will stop incrementing whenever the TOF flag is set. The counter does not increment again unless it is disabled, or if CSOT = 1 and a rising edge is detected on the trigger input.
- When (CROT= 1), the counter will reset to zero as if an overflow occurred whenever a rising edge is detected on the trigger input.
- When (CPOT = 1), the counter will pause incrementing whenever the trigger input is asserted. The counter will continue incrementing when the trigger input negates.

The polarity of the external input trigger can be configured by the TRGPOL register bit.

When an internal trigger source is selected, the trigger input is selected from one or more channel input capture events. The input capture filters are used with the internal trigger sources and the POLn bits can be used to invert the polarity of the input channels. Note that following restrictions apply with input capture channel sources.

- When (CSOT = 1), the counter will only start incrementing on a rising edge on the channel input, provided ELSnA = 1.
- When (CROT= 1), the counter will reset to zero on either edge of the channel input, as configured by ELSnB:ELSnA.
- When (CPOT = 1), the counter will pause incrementing whenever the channel input is asserted.

33.4.4 Input Capture Mode

The input capture mode is selected when (CPWMS = 0), (MSnB:MSnA = 0:0), and (ELSnB:ELSnA ≠ 0:0).

When a selected edge occurs on the channel input, the current value of the TPM counter is captured into the CnV register, at the same time the CHnF bit is set and the channel interrupt is generated if enabled by CHnIE = 1 (see the following figure).

When a channel is configured for input capture, the TPM_CHn pin is an edge-sensitive input. ELSnB:ELSnA control bits determine which edge, falling or rising, triggers input-capture event. Note that the maximum frequency for the channel input signal to be detected correctly is counter clock divided by 4, which is required to meet Nyquist criteria for signal sampling.

Writes to the CnV register are ignored in input capture mode.

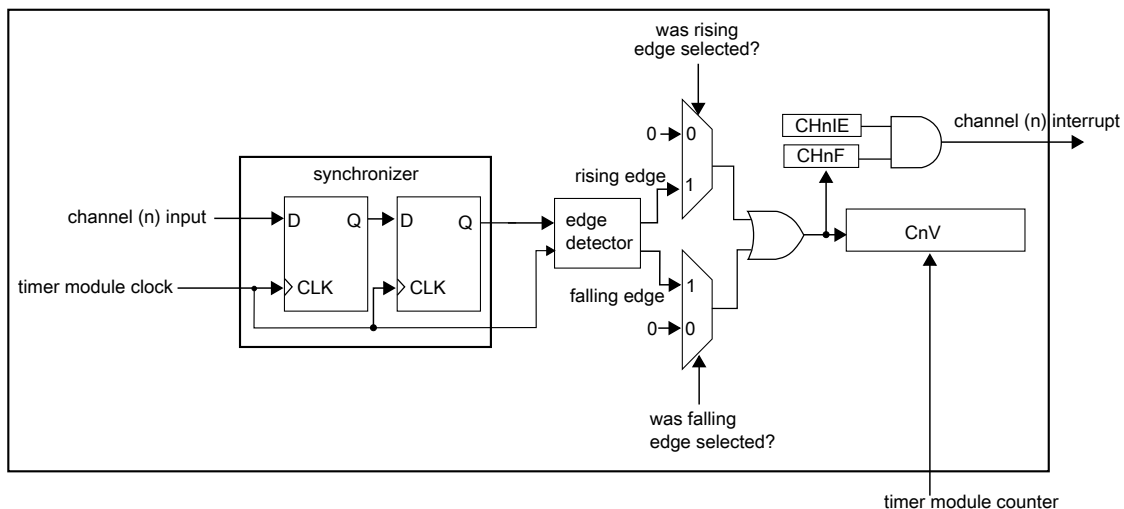

Figure 33-5. Input capture mode

The CHnF bit is set on the third rising edge of the counter clock after a valid edge occurs on the channel input.

33.4.5 Output Compare Mode

The output compare mode is selected when (CPWMS = 0), and (MSnB:MSnA = X:1).

In output compare mode, the TPM can generate timed pulses with programmable position, polarity, duration, and frequency. When the counter matches the value in the CnV register of an output compare channel, the channel (n) output can be set, cleared or toggled if MSnB is clear. If MSnB is set then the channel (n) output is pulsed high or low for as long as the counter matches the value in the CnV register.

When a channel is initially configured to output compare mode, the channel output updates with its negated value (logic 0 for set/toggle/pulse high and logic one for clear/pulse low).

The CHnF bit is set and the channel (n) interrupt is generated (if CHnIE = 1) at the channel (n) match (TPM counter = CnV).

MOD = 0x0005
CnV = 0x0003

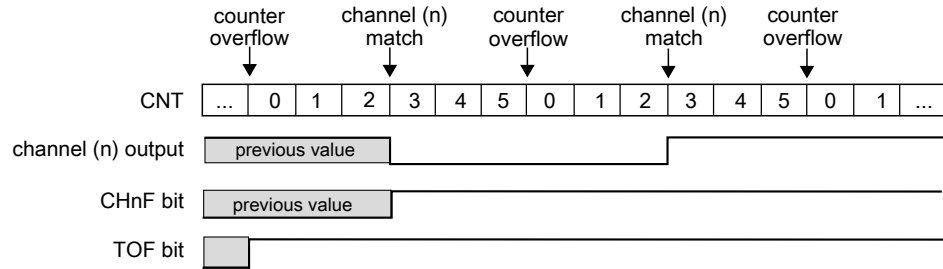

Figure 33-6. Example of the output compare mode when the match toggles the channel output

MOD = 0x0005
CnV = 0x0003

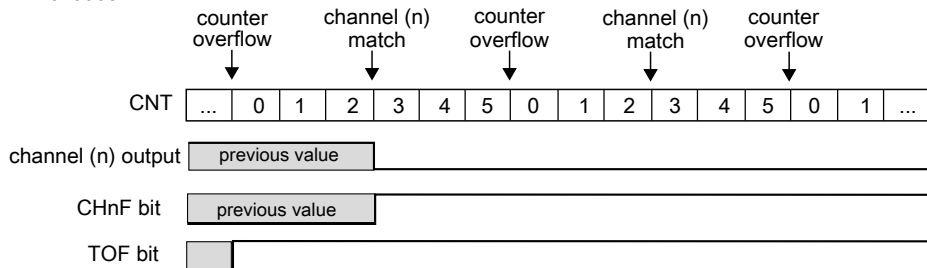

Figure 33-7. Example of the output compare mode when the match clears the channel output

MOD = 0x0005
CnV = 0x0003

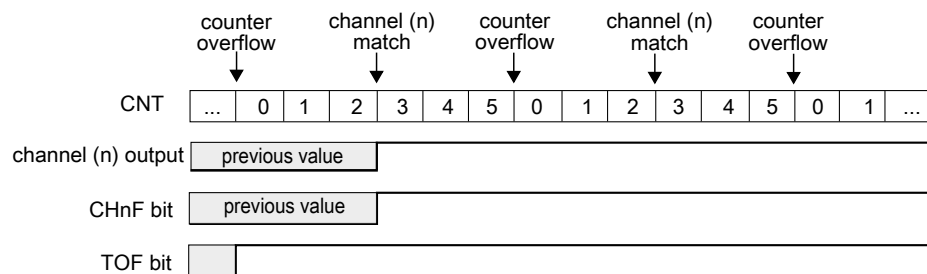

Figure 33-8. Example of the output compare mode when the match sets the channel output

It is possible to use the output compare mode with (ELSnB:ELSnA = 0:0). In this case, when the counter reaches the value in the CnV register, the CHnF bit is set and the channel (n) interrupt is generated (if CHnIE = 1), however the channel (n) output is not modified and controlled by TPM.

33.4.6 Edge-Aligned PWM (EPWM) Mode

The edge-aligned mode is selected when (CPWMS = 0), and (MSnB:MSnA = 1:0).

Functional description

The EPWM period is determined by $(MOD + 0x0001)$ and the pulse width (duty cycle) is determined by CnV .

The $CHnF$ bit is set and the channel (n) interrupt is generated (if $CHnIE = 1$) at the channel (n) match (TPM counter = CnV), that is, at the end of the pulse width.

This type of PWM signal is called edge-aligned because the leading edges of all PWM signals are aligned with the beginning of the period, which is the same for all channels within an TPM.

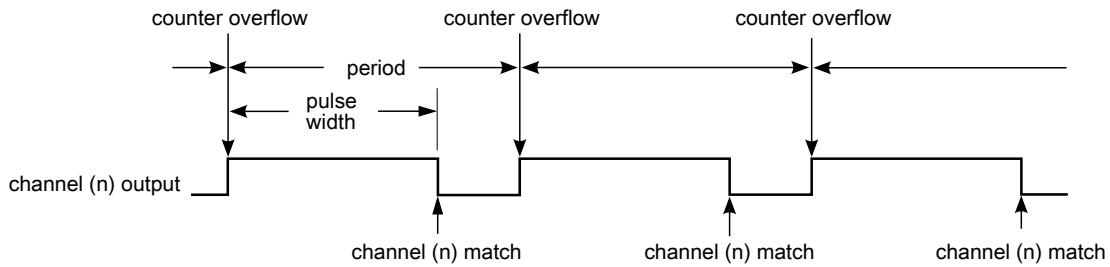

Figure 33-9. EPWM period and pulse width with $ELSnB:ELSnA = 1:0$

If ($ELSnB:ELSnA = 0:0$) when the counter reaches the value in the CnV register, the $CHnF$ bit is set and the channel (n) interrupt is generated (if $CHnIE = 1$), however the channel (n) output is not controlled by TPM.

If ($ELSnB:ELSnA = 1:0$), then the channel (n) output is forced high at the counter overflow (when the zero is loaded into the TPM counter), and it is forced low at the channel (n) match (TPM counter = CnV) (see the following figure).

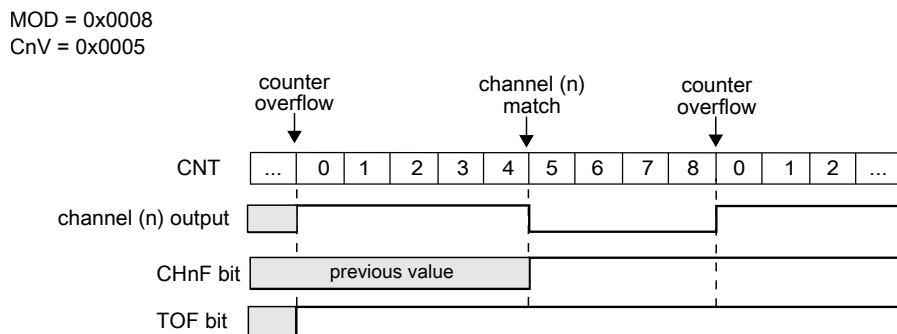

Figure 33-10. EPWM signal with $ELSnB:ELSnA = 1:0$

If ($ELSnB:ELSnA = X:1$), then the channel (n) output is forced low at the counter overflow (when zero is loaded into the TPM counter), and it is forced high at the channel (n) match (TPM counter = CnV) (see the following figure).

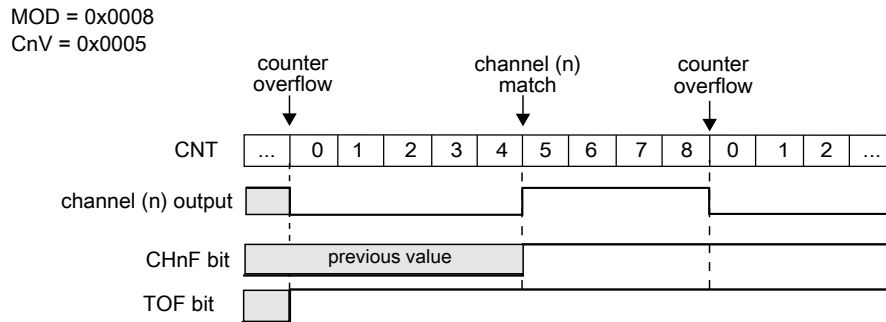

Figure 33-11. EPWM signal with ELSnB:ELSnA = X:1

If ($CnV = 0x0000$), then the channel (n) output is a 0% duty cycle EPWM signal. If ($CnV > MOD$), then the channel (n) output is a 100% duty cycle EPWM signal and CHnF bit is not set since there is never a channel (n) match. Therefore, MOD must be less than 0xFFFF in order to get a 100% duty cycle EPWM signal.

33.4.7 Center-Aligned PWM (CPWM) Mode

The center-aligned mode is selected when ($CPWMS = 1$) and ($MSnB:MSnA = 1:0$).

The CPWM pulse width (duty cycle) is determined by $2 \times CnV$ and the period is determined by $2 \times MOD$ (see the following figure). MOD must be kept in the range of 0x0001 to 0x7FFF because values outside this range can produce ambiguous results.

In the CPWM mode, the TPM counter counts up until it reaches MOD and then counts down until it reaches zero.

The CHnF bit is set and channel (n) interrupt is generated (if CHnIE = 1) at the channel (n) match (TPM counter = CnV) when the TPM counting is down (at the begin of the pulse width) and when the TPM counting is up (at the end of the pulse width).

This type of PWM signal is called center-aligned because the pulse width centers for all channels are when the TPM counter is zero.

The other channel modes are not designed to be used with the up-down counter ($CPWMS = 1$). Therefore, all TPM channels should be used in CPWM mode when ($CPWMS = 1$).

Functional description

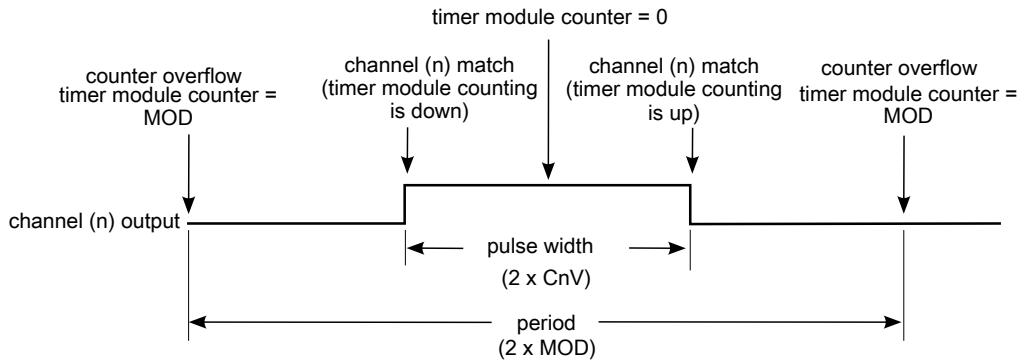

Figure 33-12. CPWM period and pulse width with ELSnB:ELSnA = 1:0

If (ELSnB:ELSnA = 0:0) when the TPM counter reaches the value in the CnV register, the CHnF bit is set and the channel (n) interrupt is generated (if CHnIE = 1), however the channel (n) output is not controlled by TPM.

If (ELSnB:ELSnA = 1:0), then the channel (n) output is forced high at the channel (n) match (TPM counter = CnV) when counting down, and it is forced low at the channel (n) match when counting up (see the following figure).

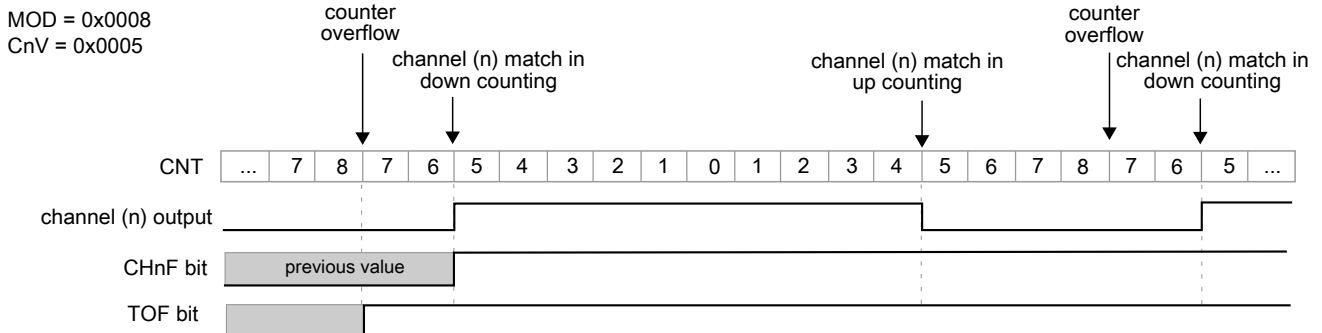

Figure 33-13. CPWM signal with ELSnB:ELSnA = 1:0

If (ELSnB:ELSnA = X:1), then the channel (n) output is forced low at the channel (n) match (TPM counter = CnV) when counting down, and it is forced high at the channel (n) match when counting up (see the following figure).

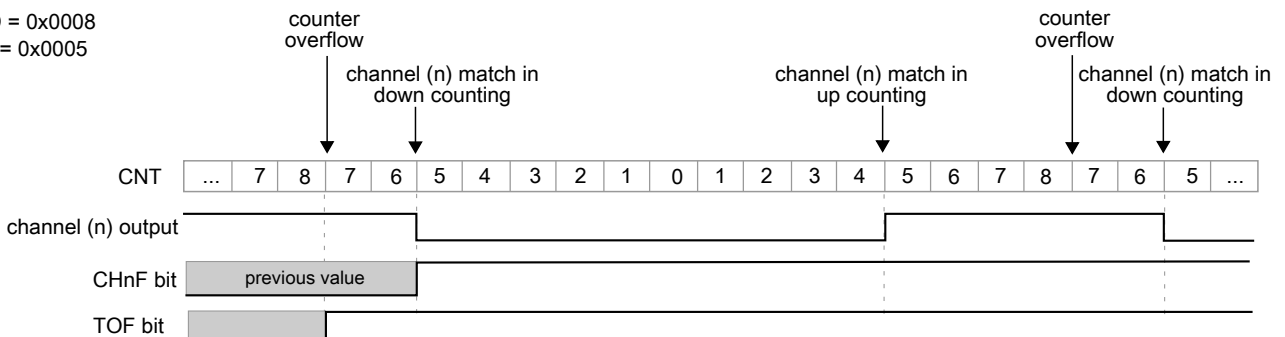

Figure 33-14. CPWM signal with ELSnB:ELSnA = X:1

If ($C_nV = 0x0000$) then the channel (n) output is a 0% duty cycle CPWM signal.

If ($C_nV > MOD$), then the channel (n) output is a 100% duty cycle CPWM signal, although the CH_nF bit is set when the counter changes from incrementing to decrementing. Therefore, MOD must be less than $0xFFFF$ in order to get a 100% duty cycle CPWM signal.

33.4.8 Combine PWM mode

The Combine PWM mode is selected when:

- $MS_nB:MS_nA = 10$
- $COMBINEn = 1$
- $QUADEN = 0$, and
- $CPWMS = 0$

In Combine PWM mode, an even channel (n) and adjacent odd channel (n+1) are combined to generate a PWM signal in the channel (n) output.

In the Combine mode, the PWM period is determined by $(MOD + 0x0001)$ and the PWM pulse width (duty cycle) is determined by $(|C_{(n+1)}V - C_{(n)}V|)$.

The CH_nF bit is set and the channel (n) interrupt is generated (if $CH_nIE = 1$) at the channel (n) match (TPM counter = $C_{(n)}V$). The $CH_{(n+1)}F$ bit is set and the channel (n+1) interrupt is generated, if $CH_{(n+1)}IE = 1$, at the channel (n+1) match (TPM counter = $C_{(n+1)}V$).

If channel (n) ($ELS_nB:ELS_nA = X:1$), then the channel (n) output is forced low at the beginning of the period (TPM counter is zero) and at the channel (n+1) match (TPM counter = $C_{(n+1)}V$). It is forced high at the channel (n) match (TPM counter = $C_{(n)}V$).

If channel (n) ($ELS_nB:ELS_nA = 1:0$), then the channel (n) output is forced high at the beginning of the period (TPM counter is zero) and at the channel (n+1) match (TPM counter = $C_{(n+1)}V$). It is forced low at the channel (n) match (TPM counter = $C_{(n)}V$).

When ($COMSWAP_n = 1$), then the channel (n) output is forced low or high at the beginning of the period (TPM counter is zero) and at the channel (n) match (TPM counter = $C_{(n)}V$). It is forced high or low at the channel (n+1) match (TPM counter = $C_{(n+1)}V$).

The channel (n+1) output is generated the same as the channel (n) output, but the output polarity is controlled by the channel (n+1) $ELS_nB:ELS_nA$ configuration.

Functional description

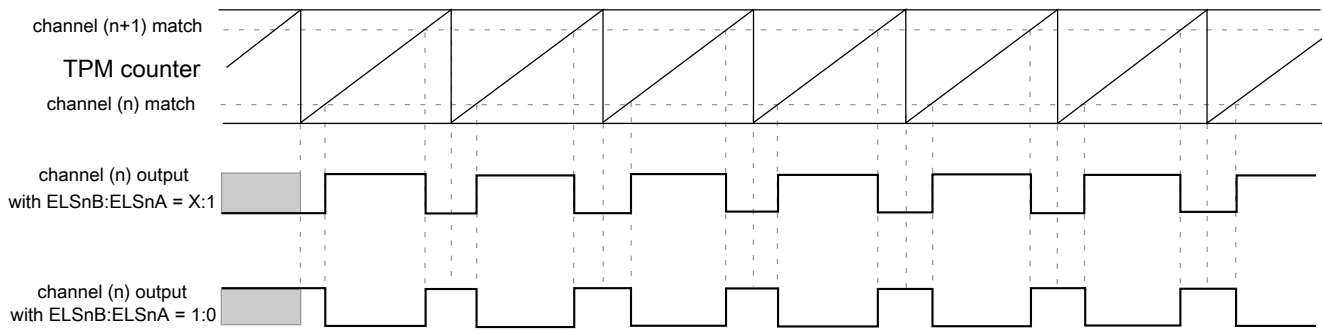

Figure 33-15. Combine mode

The following figures illustrate the PWM signals generation using Combine mode.

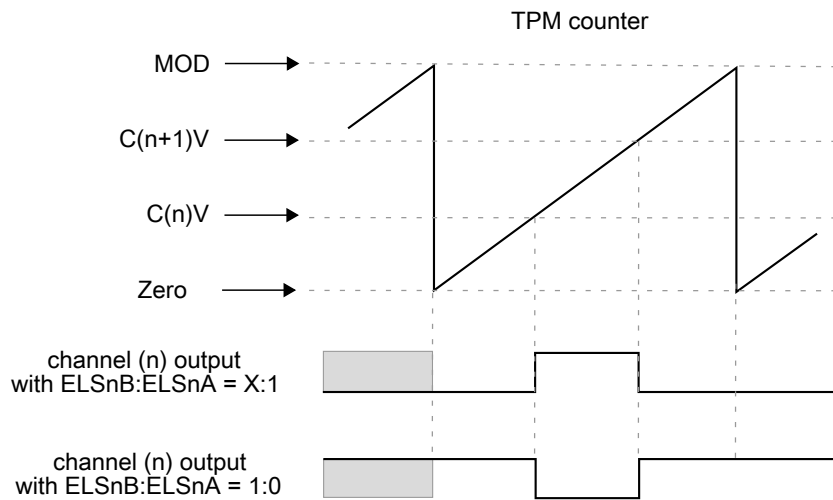

Figure 33-16. Channel (n) output if $(C(n)V < MOD)$ and $(C(n+1)V < MOD)$ and $(C(n)V < C(n+1)V)$

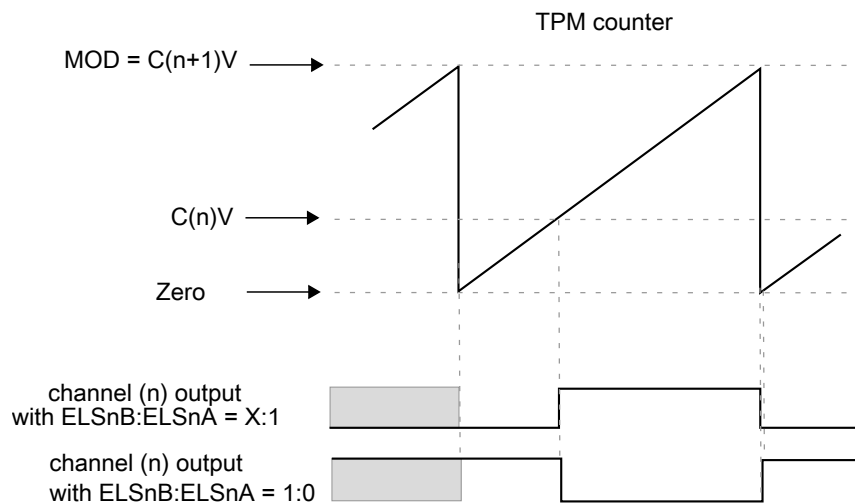

Figure 33-17. Channel (n) output if $(C(n)V < MOD)$ and $(C(n+1)V = MOD)$

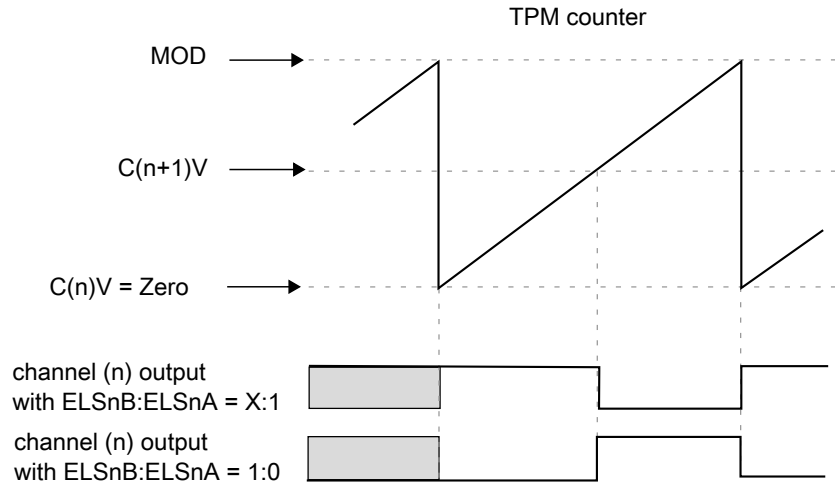

Figure 33-18. Channel (n) output if $(C(n)V = \text{zero})$ and $(C(n+1)V < \text{MOD})$

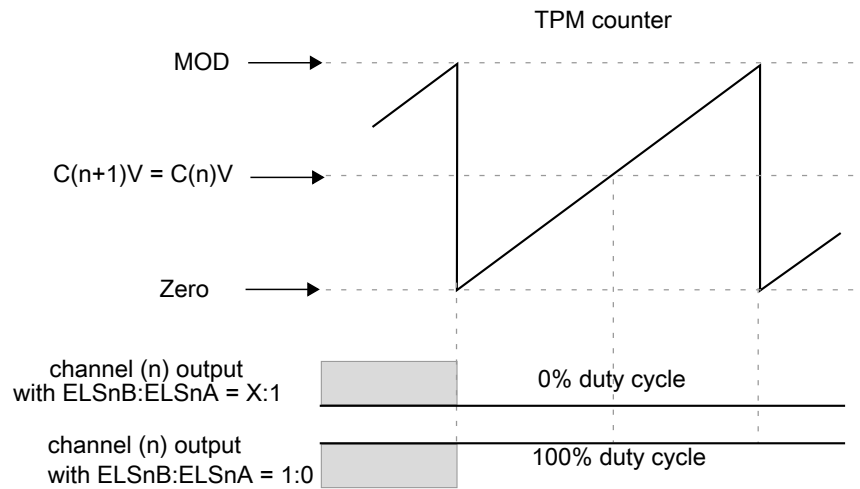

Figure 33-19. Channel (n) output if $(C(n)V < \text{MOD})$ and $(C(n+1)V < \text{MOD})$ and $(C(n)V = C(n+1)V)$

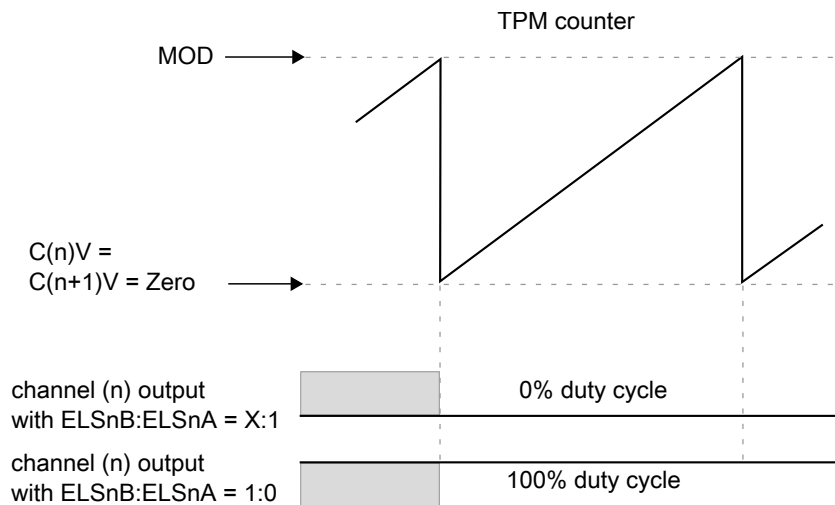

Figure 33-20. Channel (n) output if $(C(n)V = C(n+1)V = \text{zero})$

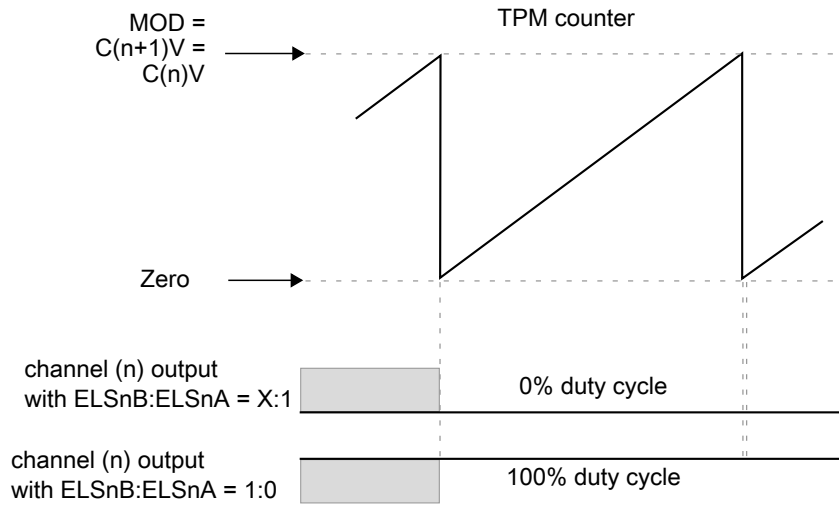

Figure 33-21. Channel (n) output if $(C(n)V = C(n+1)V = MOD)$

33.4.9 Combine Input Capture mode

The Combine Input Capture mode is selected if $COMBINEn = 1$ and $MSnB:MSnA = 00$ and $ELSnB:ELSnA \neq 00$. This mode allows to measure a pulse width of the signal on the input of channel (n) of a channel pair. The channel (n) filter can be active in this mode.

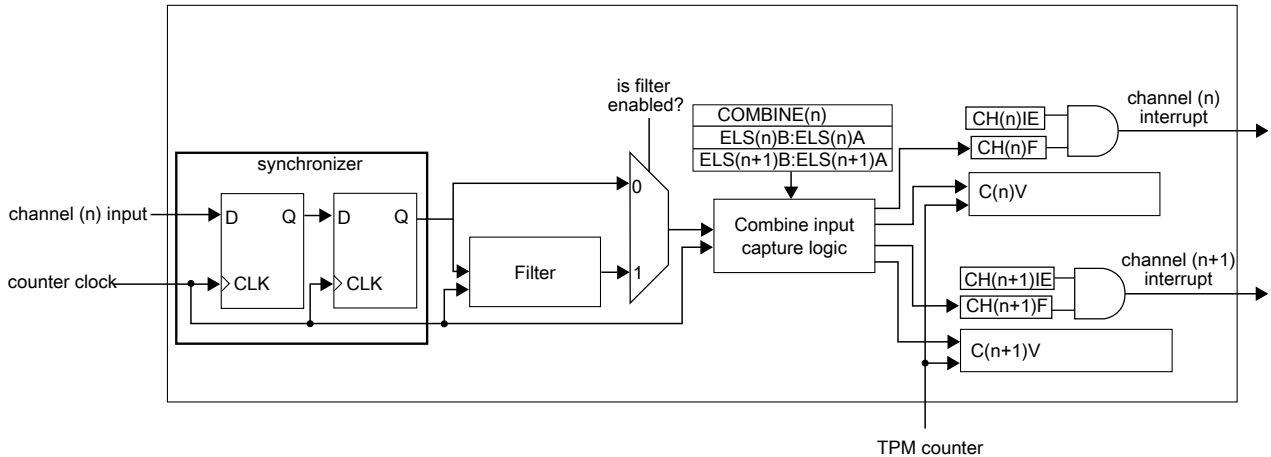

Figure 33-22. Combine Input Capture mode block diagram

The $ELSnB:ELSnA$ bits select the edge that is captured by channel (n), and $ELSn+1B:ELSn+1A$ bits select the edge that is captured by channel (n+1).

In the Combine Input Capture mode, only channel (n) input is used and channel (n+1) input is ignored, when $COMSWAPn=1$ then only channel (n+1) input is used and channel (n) input is ignored.

If the selected edge by channel (n) bits is detected at channel (n) input, then CH(n)F bit is set and the channel (n) interrupt is generated (if CH(n)IE = 1). If the selected edge by channel (n+1) bits is detected at channel (n) input, then CH(n+1)F bit is set and the channel (n+1) interrupt is generated (if CH(n+1)IE = 1).

The C(n)V register stores the value of TPM counter when the selected edge by channel (n) is detected at channel (n) input. The C(n+1)V register stores the value of TPM counter when the selected edge by channel (n+1) is detected at channel (n) input.

Note

- The CH(n)F, CH(n)IE, MS(n)A, ELS(n)B, and ELS(n)A bits are channel (n) bits.
- The CH(n+1)F, CH(n+1)IE, MS(n+1)A, ELS(n+1)B, and ELS(n+1)A bits are channel (n+1) bits.
- The Combine Input Capture mode must be used with ELS(n)B:ELS(n)A = 0:1 or 1:0, ELS(n+1)B:ELS(n+1)A = 0:1 or 1:0.

33.4.10 Input Capture Filter

The input capture filter function is only in input capture mode, or in software compare mode when quadrature decoder mode is enabled.

First, the input signal is synchronized by the counter clock. Following synchronization, the input signal enters the filter block. See the following figure.

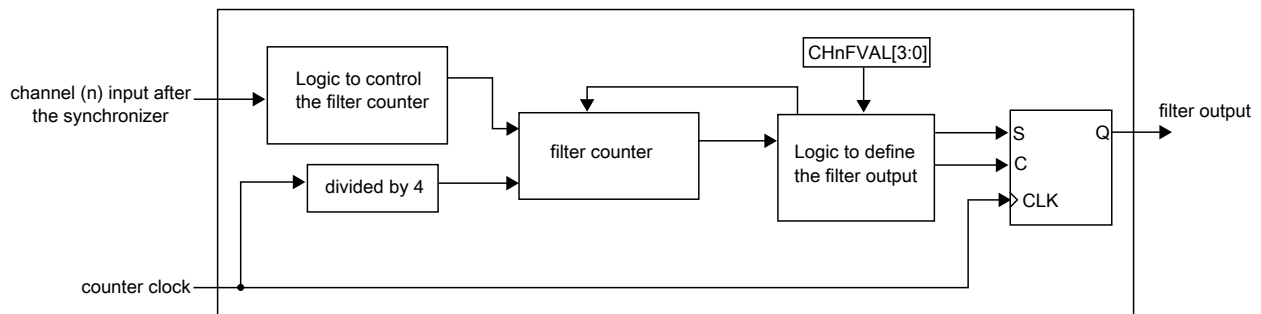

Figure 33-23. Channel input filter

When there is a state change in the input signal, the counter is reset and starts counting up. As long as the new state is stable on the input, the counter continues to increment. When the counter is equal to $(CHnFVAL[3:0] \times 4)$, the state change of the input signal is validated.

Functional description

If the opposite edge appears on the input signal before it can be validated, the counter is reset. At the next input transition, the counter starts counting again. Any pulse that is shorter than the minimum value selected by $(CHnFVAL[3:0] \times 4 \text{ counter clocks})$ is regarded as a glitch and is not passed through the filter. A timing diagram of the input filter is shown in the following figure.

The filter function is disabled when $CHnFVAL[3:0]$ bits are zero. In this case, the input signal is delayed by 2 rising edges of the counter clock. If $(CHnFVAL[3:0] \neq 0000)$, then the input signal is delayed by the minimum pulse width $(CHnFVAL[3:0] \times 4 \text{ system clocks})$ plus a further 3 rising edges of the system clock: two rising edges to the synchronizer, plus one more to the edge detector. In other words, $CHnF$ is set $(3 + 4 \times CHnFVAL[3:0])$ counter clock periods after a valid edge occurs on the channel input.

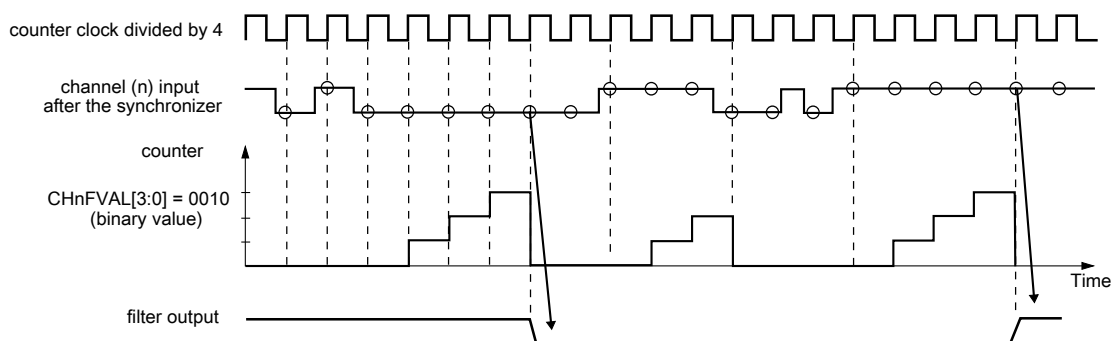

Figure 33-24. Channel input filter example

33.4.11 Deadtime insertion

The deadtime insertion is enabled in PWM combine modes when $CHnFVAL$ is non-zero. The deadtime delay that is used for each TPM channel is defined as $(CHnFVAL[3:0] \times 4)$.

The deadtime delay insertion ensures that no two complementary signals (channels (n) and (n+1)) drive the active state at the same time.

If $POL(n) = 0$, $POL(n+1) = 1$, and the deadtime is enabled, then when the channel (n) match (TPM counter = $C(n)V$) occurs, the channel (n) output remains at the low value until the end of the deadtime delay when the channel (n) output is set. Similarly, when the channel (n+1) match (TPM counter = $C(n+1)V$) occurs, the channel (n+1) output remains at the low value until the end of the deadtime delay when the channel (n+1) output is set. See the following figures.

If $POL(n) = 1$, $POL(n+1) = 0$, and the deadtime is enabled, then when the channel (n) match (TPM counter = $C(n)V$) occurs, the channel (n) output remains at the high value until the end of the deadtime delay when the channel (n) output is cleared. Similarly,

when the channel (n+1) match (TPM counter = $C(n+1)V$) occurs, the channel (n+1) output remains at the high value until the end of the deadtime delay when the channel (n+1) output is cleared.

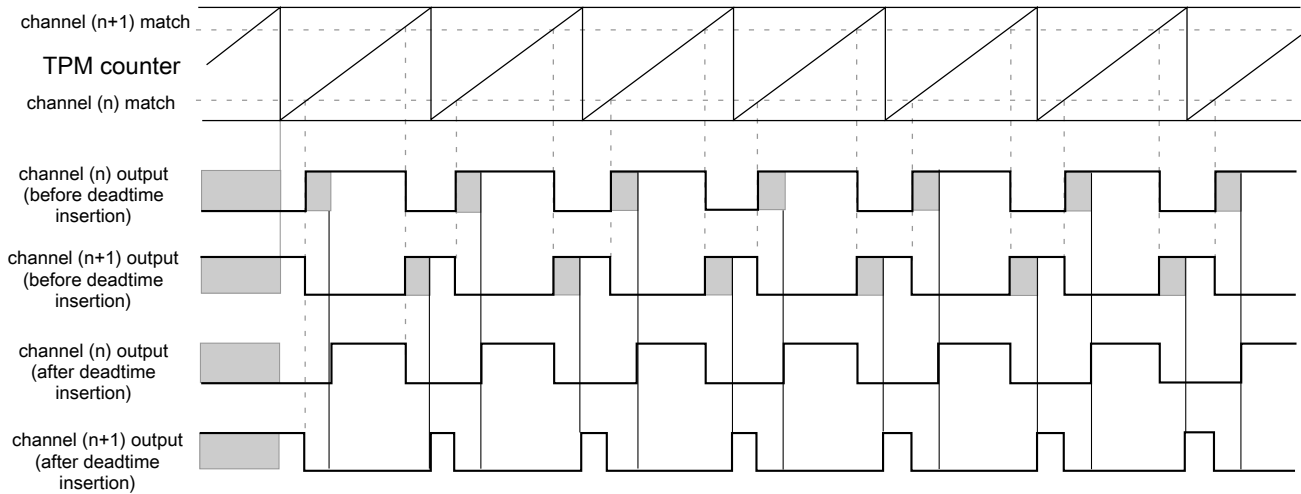

Figure 33-25. Deadtime insertion with $ELSnB:ELSnA = X:1$, $POL(n) = 0$, and $POL(n+1) = 1$

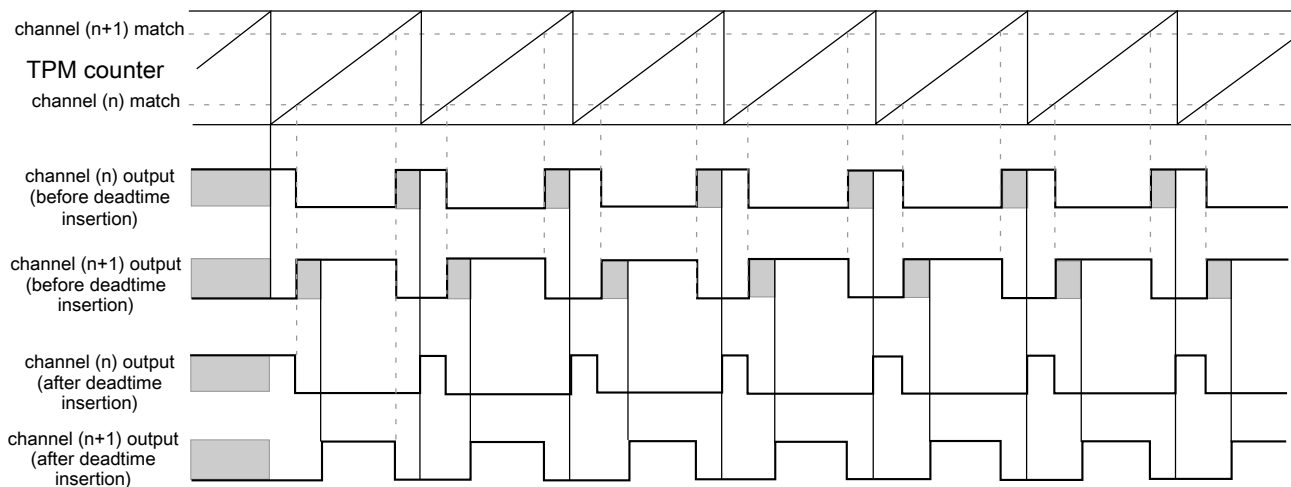

Figure 33-26. Deadtime insertion with $ELSnB:ELSnA = 1:0$, $POL(n) = 0$, and $POL(n+1) = 1$

33.4.12 Quadrature Decoder mode

The Quadrature Decoder mode is selected if ($QUADEN = 1$). The Quadrature Decoder mode uses the channel 0 (phase A) and channel 1 (phase B) input signals to control the TPM counter increment and decrement. The following figure shows the quadrature decoder block diagram.

Functional description

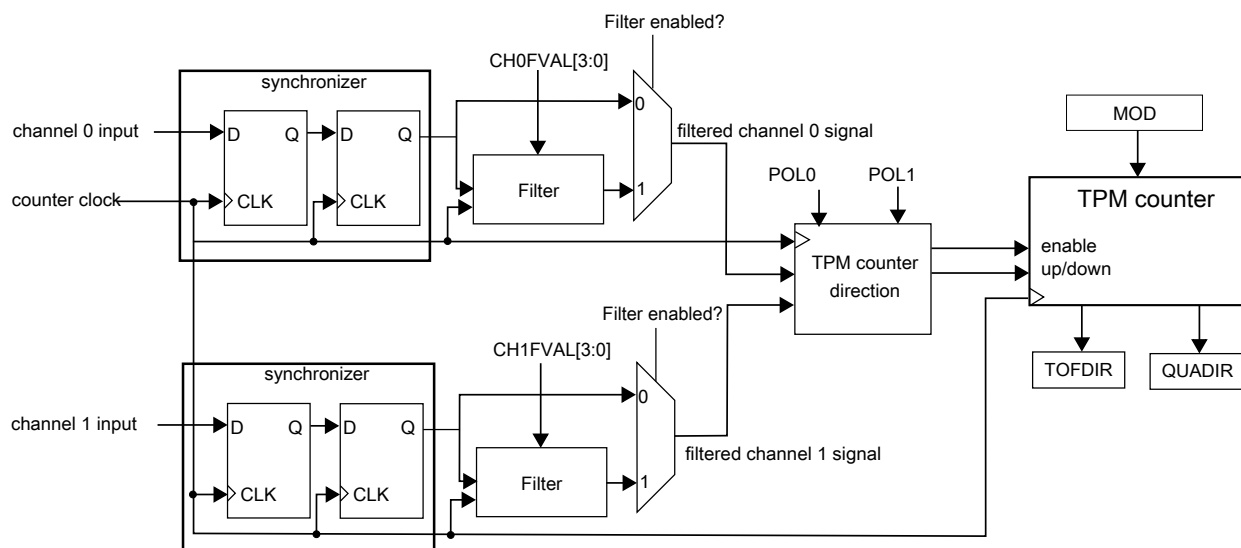

Figure 33-27. Quadrature Decoder block diagram

The input capture filter and channel polarity registers are used to configure the input filter and polarity for the channel 0 and channel 1 inputs in quadrature decode mode.

Note

Notice that the TPM counter is clocked by the channel 0 and channel 1 input signals when quadrature decoder mode is selected. Therefore In quadrature decoder mode, channel 0 and channel 1 can only be used in software compare mode and other TPM channels can only be used in input capture or output compare modes.

The QUADM0DE selects the encoding mode used in the Quadrature Decoder mode. If QUADM0DE = 1, then the count and direction encoding mode is enabled; see the following figure. In this mode, the channel 1 input value indicates the counting direction, and the channel 0 input defines the counting rate. The TPM counter is updated when there is a rising edge at channel 0 input signal.

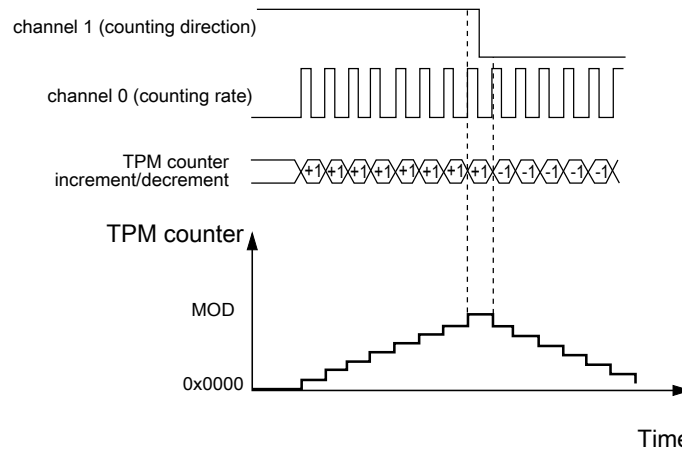

Figure 33-28. Quadrature Decoder – Count and Direction Encoding mode

If $QUADM\text{MODE} = 0$, then the Phase Encoding mode is enabled; see the following figure. In this mode, the relationship between channel 0 and channel 1 signals indicates the counting direction, and channel 0 and channel 1 signals define the counting rate. The TPM counter is updated when there is an edge either at the channel 0 or channel 1 signals.

If $CH0POL = 0$ and $CH1POL = 0$, then the TPM counter increment happens when:

- there is a rising edge at channel 0 signal and channel 1 signal is at logic zero;
- there is a rising edge at channel 1 signal and channel 0 signal is at logic one;
- there is a falling edge at channel 1 signal and channel 0 signal is at logic zero;
- there is a falling edge at channel 0 signal and channel 1 signal is at logic one;

and the TPM counter decrement happens when:

- there is a falling edge at channel 0 signal and channel 1 signal is at logic zero;
- there is a falling edge at channel 1 signal and channel 0 signal is at logic one;
- there is a rising edge at channel 1 signal and channel 0 signal is at logic zero;
- there is a rising edge at channel 0 signal and channel 1 signal is at logic one.

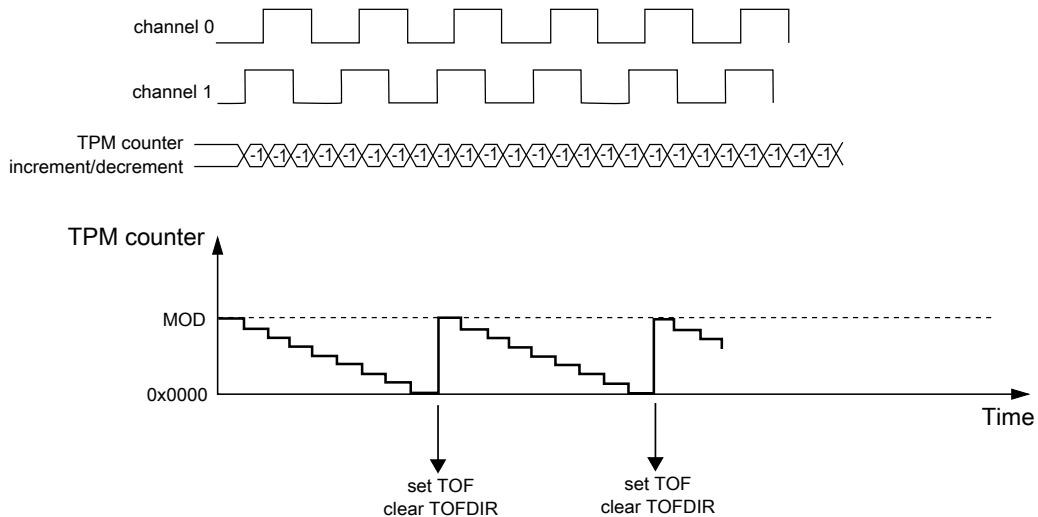

Figure 33-31. TPM counter overflow in down counting for Quadrature Decoder mode

33.4.13 Registers Updated from Write Buffers

33.4.13.1 MOD Register Update

If (CMOD[1:0] = 0:0) then MOD register is updated when MOD register is written.

If (CMOD[1:0] ≠ 0:0), then MOD register is updated according to the CPWMS bit, that is:

- If the selected mode is not CPWM then MOD register is updated after MOD register was written and the TPM counter changes from MOD to zero.
- If the selected mode is CPWM then MOD register is updated after MOD register was written and the TPM counter changes from MOD to (MOD – 1).

33.4.13.2 CnV Register Update

If (CMOD[1:0] = 0:0) then CnV register is updated when CnV register is written.

If (CMOD[1:0] ≠ 0:0), then CnV register is updated according to the selected mode, that is:

- If the selected mode is output compare then CnV register is updated on the next TPM counter increment (end of the prescaler counting) after CnV register was written.

Functional description

- If the selected mode is EPWM then CnV register is updated after CnV register was written and the TPM counter changes from MOD to zero.
- If the selected mode is CPWM then CnV register is updated after CnV register was written and the TPM counter changes from MOD to (MOD – 1).

33.4.14 DMA

The channel and overflow flags generate a DMA transfer request according to DMA and CHnIE/TOIE bits.

See the following table for more information.

Table 33-3. DMA Transfer Request

| DMA | CHnIE/ TOIE | Channel/Overflow DMA Transfer Request | Channel/Overflow Interrupt |
|-----|----------------|---|--|
| 0 | 0 | The channel/overflow DMA transfer request is not generated. | The channel/overflow interrupt is not generated. |
| 0 | 1 | The channel/overflow DMA transfer request is not generated. | The channel/overflow interrupt is generated if (CHnF/TOF = 1). |
| 1 | 0 | The channel/overflow DMA transfer request is generated if (CHnF/TOF = 1). | The channel/overflow interrupt is not generated. |
| 1 | 1 | The channel/overflow DMA transfer request is generated if (CHnF/TOF = 1). | The channel/overflow interrupt is generated if (CHnF/TOF = 1). |

If DMA = 1, the CHnF/TOF bit can be cleared either by DMA transfer done or writing a one to CHnF/TOF bit (see the following table).

Table 33-4. Clear CHnF/TOF Bit

| DMA | How CHnF/TOF Bit Can Be Cleared |
|-----|---|
| 0 | CHnF/TOF bit is cleared by writing a 1 to CHnF/TOF bit. |
| 1 | CHnF/TOF bit is cleared either when the DMA transfer is done or by writing a 1 to CHnF/TOF bit. |

33.4.15 Output triggers

The TPM generates output triggers for the counter and each channel that can be used to trigger events in other peripherals.

The counter trigger asserts whenever the TOF is set and remains asserted until the next increment.

Each TPM channel generates both a pre-trigger output and a trigger output. The pre-trigger output asserts whenever the CHnF is set, the trigger output asserts on the first counter increment after the pre-trigger asserts, and then both the trigger and pre-trigger negate on the first counter increment after the trigger asserts.

When (COMBINEn = 1) in output compare modes, the pre-trigger output for both channel (n) and channel (n+1) will assert when CH(n)F is set and will negate when CH(n+1)F is set. The trigger continues to assert on the first counter increment after the pre-trigger asserts and negates at the same time as the pre-trigger negation.

33.4.16 Reset Overview

The TPM is reset whenever any chip reset occurs.

When the TPM exits from reset:

- the TPM counter and the prescaler counter are zero and are stopped (CMOD[1:0] = 0:0);
- the timer overflow interrupt is zero;
- the channels interrupts are zero;
- the channels are in input capture mode;
- the channels outputs are zero;
- the channels pins are not controlled by TPM (ELS(n)B:ELS(n)A = 0:0).

33.4.17 TPM Interrupts

This section describes TPM interrupts.

33.4.17.1 Timer Overflow Interrupt

The timer overflow interrupt is generated when (TOIE = 1) and (TOF = 1).

33.4.17.2 Channel (n) Interrupt

The channel (n) interrupt is generated when (CHnIE = 1) and (CHnF = 1).

Chapter 34

Periodic interrupt timer (PIT)

The periodic interrupt timer (PIT) module consists of an array of timers that can be used to generate interrupts and trigger DMA channels.

34.1 Introduction

The PIT module is an array of timers that can be used to raise interrupts and trigger DMA channels.

34.1.1 Block diagram

The following figure shows the block diagram of the PIT module.

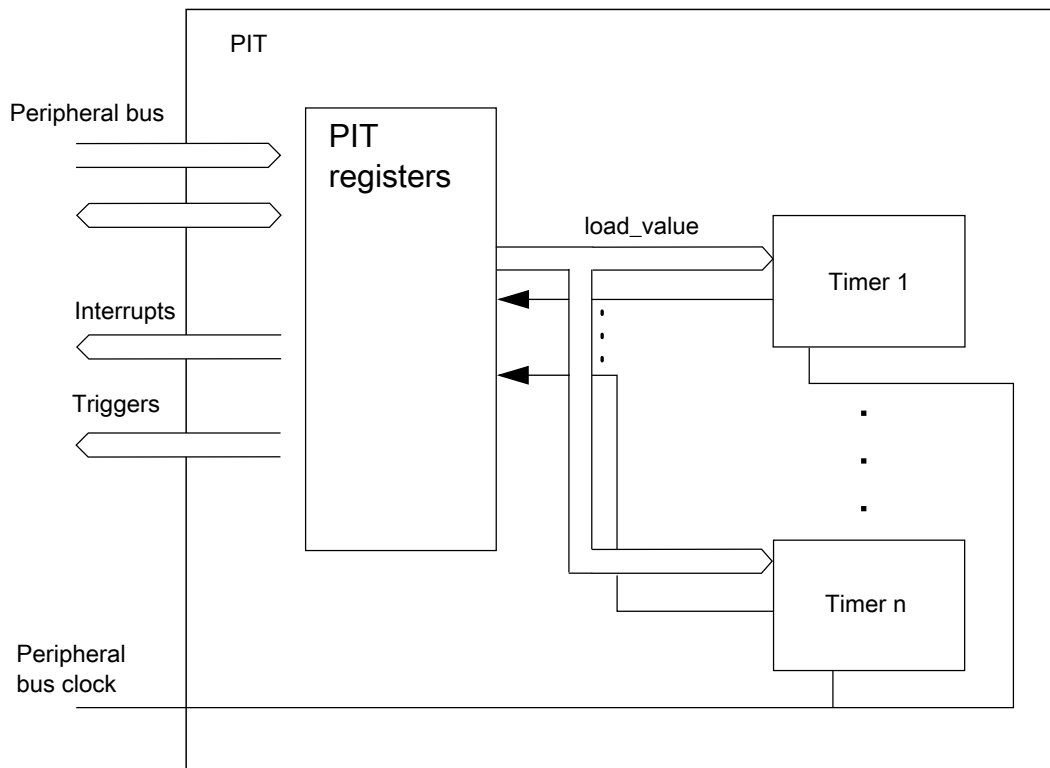

Figure 34-1. Block diagram of the PIT

NOTE

See the chip-specific PIT information for the number of PIT channels used in this MCU.

34.1.2 Features

The main features of this block are:

- Ability of timers to generate DMA trigger pulses
- Ability of timers to generate interrupts
- Maskable interrupts
- Independent timeout periods for each timer

34.2 Signal description

The PIT module has no external pins.

34.3 Memory map/register description

This section provides a detailed description of all registers accessible in the PIT module.

- Reserved registers will read as 0, writes will have no effect.
- See the chip-specific PIT information for the number of PIT channels used in this MCU.

PIT memory map

| Absolute address (hex) | Register name | Width (in bits) | Access | Reset value | Section/page |
|------------------------|---|-----------------|--------|-------------|----------------------------|
| 4003_7000 | PIT Module Control Register (PIT_MCR) | 32 | R/W | 0000_0006h | 34.3.1/761 |
| 4003_70E0 | PIT Upper Lifetime Timer Register (PIT_LTMR64H) | 32 | R | 0000_0000h | 34.3.2/762 |
| 4003_70E4 | PIT Lower Lifetime Timer Register (PIT_LTMR64L) | 32 | R | 0000_0000h | 34.3.3/763 |
| 4003_7100 | Timer Load Value Register (PIT_LDVAL0) | 32 | R/W | 0000_0000h | 34.3.4/763 |
| 4003_7104 | Current Timer Value Register (PIT_CVAL0) | 32 | R | 0000_0000h | 34.3.5/764 |
| 4003_7108 | Timer Control Register (PIT_TCTRL0) | 32 | R/W | 0000_0000h | 34.3.6/764 |
| 4003_710C | Timer Flag Register (PIT_TFLG0) | 32 | R/W | 0000_0000h | 34.3.7/765 |
| 4003_7110 | Timer Load Value Register (PIT_LDVAL1) | 32 | R/W | 0000_0000h | 34.3.4/763 |
| 4003_7114 | Current Timer Value Register (PIT_CVAL1) | 32 | R | 0000_0000h | 34.3.5/764 |
| 4003_7118 | Timer Control Register (PIT_TCTRL1) | 32 | R/W | 0000_0000h | 34.3.6/764 |
| 4003_711C | Timer Flag Register (PIT_TFLG1) | 32 | R/W | 0000_0000h | 34.3.7/765 |

34.3.1 PIT Module Control Register (PIT_MCR)

This register enables or disables the PIT timer clocks and controls the timers when the PIT enters the Debug mode.

Access: User read/write

Address: 4003_7000h base + 0h offset = 4003_7000h

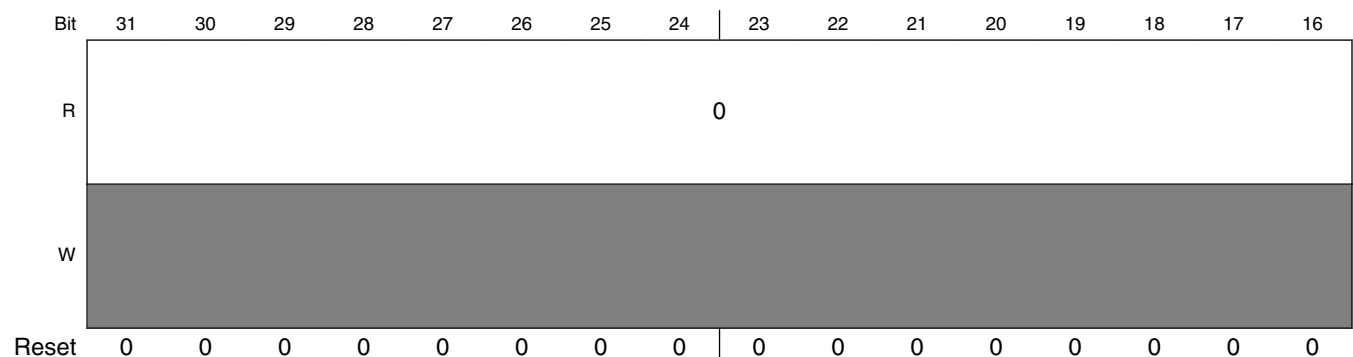

Memory map/register description

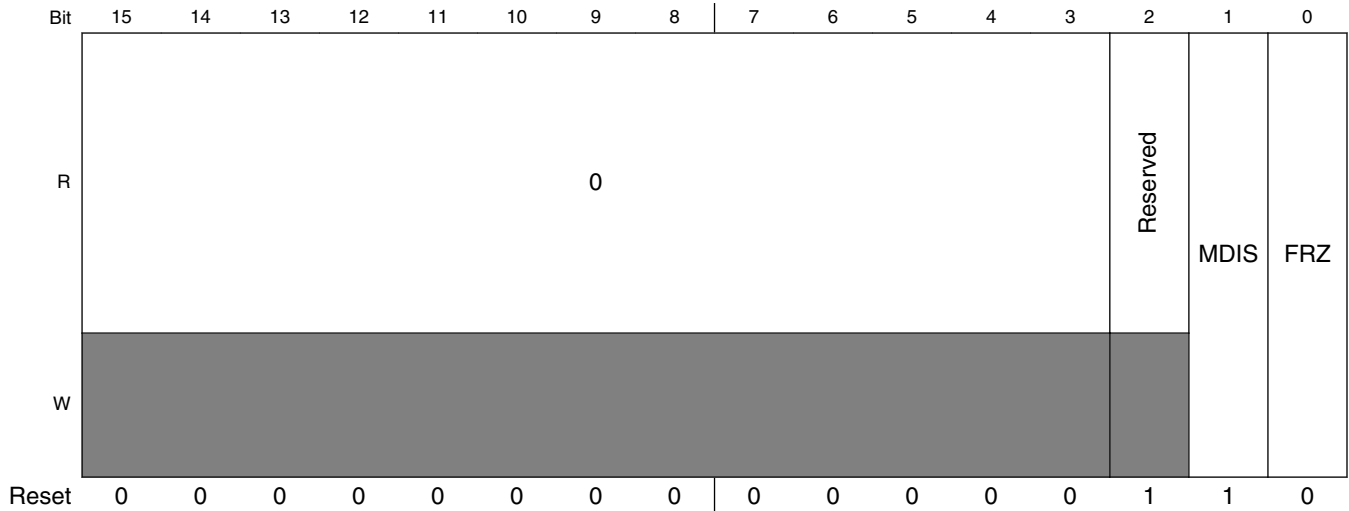

PIT_MCR field descriptions

| Field | Description |
|------------------|---|
| 31–3 Reserved | This field is reserved. This read-only field is reserved and always has the value 0. |
| 2 Reserved | This field is reserved. |
| 1 MDIS | Module Disable - (PIT section) Disables the standard timers. This field must be enabled before any other setup is done. 0 Clock for standard PIT timers is enabled. 1 Clock for standard PIT timers is disabled. |
| 0 FRZ | Freeze Allows the timers to be stopped when the device enters the Debug mode. 0 Timers continue to run in Debug mode. 1 Timers are stopped in Debug mode. |

34.3.2 PIT Upper Lifetime Timer Register (PIT_LTMR64H)

This register is intended for applications that chain timer 0 and timer 1 to build a 64-bit lifetimer.

Access: User read only

Address: 4003_7000h base + E0h offset = 4003_70E0h

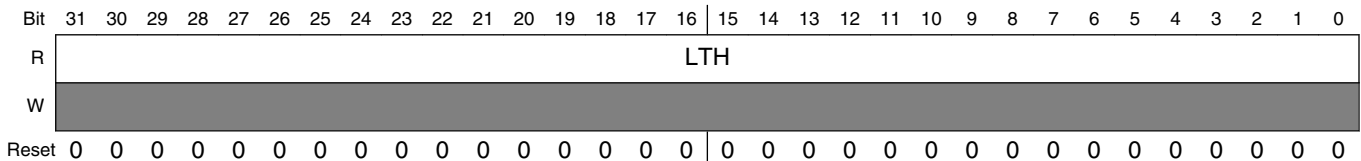

PIT_LTMR64H field descriptions

| Field | Description |
|-------|---|
| LTH | Life Timer value Shows the timer value of timer 1. If this register is read at a time t1, LTMR64L shows the value of timer 0 at time t1. |

34.3.3 PIT Lower Lifetime Timer Register (PIT_LTMR64L)

This register is intended for applications that chain timer 0 and timer 1 to build a 64-bit lifetimer.

To use LTMR64H and LTMR64L, timer 0 and timer 1 need to be chained. To obtain the correct value, first read LTMR64H and then LTMR64L. LTMR64H will have the value of CVAL1 at the time of the first access, LTMR64L will have the value of CVAL0 at the time of the first access, therefore the application does not need to worry about carry-over effects of the running counter.

Access: User read only

Address: 4003_7000h base + E4h offset = 4003_70E4h

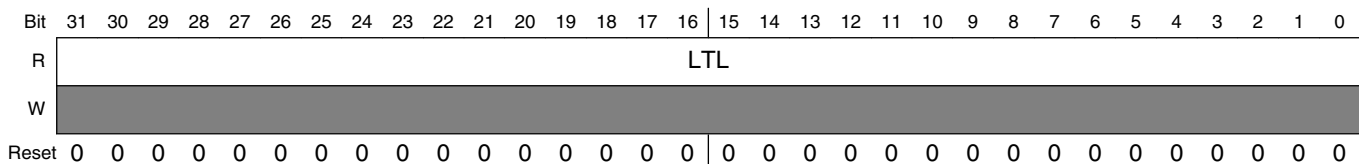

PIT_LTMR64L field descriptions

| Field | Description |
|-------|---|
| LTL | Life Timer value Shows the value of timer 0 at the time LTMR64H was last read. It will only update if LTMR64H is read. |

34.3.4 Timer Load Value Register (PIT_LDVALn)

These registers select the timeout period for the timer interrupts.

Access: User read/write

Address: 4003_7000h base + 100h offset + (16d × i), where i=0d to 1d

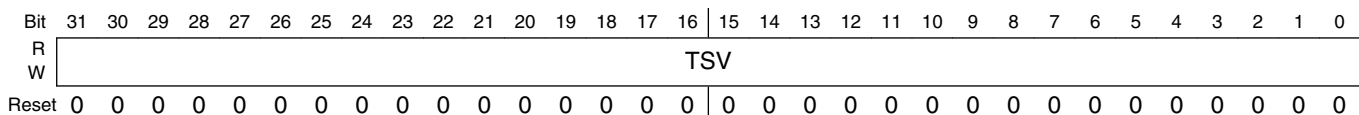

PIT_LDVALn field descriptions

| Field | Description |
|-------|---|
| TSV | <p>Timer Start Value</p> <p>Sets the timer start value. The timer will count down until it reaches 0, then it will generate an interrupt and load this register value again. Writing a new value to this register will not restart the timer; instead the value will be loaded after the timer expires. To abort the current cycle and start a timer period with the new value, the timer must be disabled and enabled again.</p> |

34.3.5 Current Timer Value Register (PIT_CVALn)

These registers indicate the current timer position.

Access: User read only

Address: 4003_7000h base + 104h offset + (16d × i), where i=0d to 1d

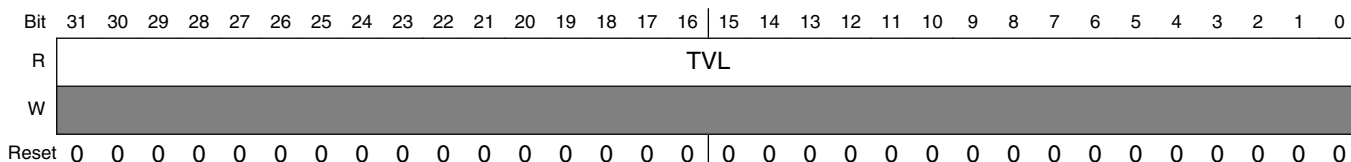

PIT_CVALn field descriptions

| Field | Description |
|-------|---|
| TVL | <p>Current Timer Value</p> <p>Represents the current timer value, if the timer is enabled.</p> <p>NOTE:</p> <ul style="list-style-type: none"> • If the timer is disabled, do not use this field as its value is unreliable. • The timer uses a downcounter. The timer values are frozen in Debug mode if MCR[FRZ] is set. |

34.3.6 Timer Control Register (PIT_TCTRLn)

These registers contain the control bits for each timer.

Access: User read/write

Address: 4003_7000h base + 108h offset + (16d × i), where i=0d to 1d

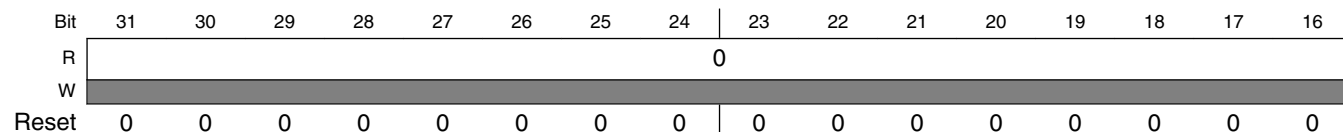



PIT_TCTRLn field descriptions

| Field | Description |
|------------------|---|
| 31–3 Reserved | This field is reserved. This read-only field is reserved and always has the value 0. |
| 2 CHN | Chain Mode When activated, Timer n-1 needs to expire before timer n can decrement by 1. Timer 0 cannot be chained. 0 Timer is not chained. 1 Timer is chained to previous timer. For example, for Channel 2, if this field is set, Timer 2 is chained to Timer 1. |
| 1 TIE | Timer Interrupt Enable When an interrupt is pending, or, TFLGn[TIF] is set, enabling the interrupt will immediately cause an interrupt event. To avoid this, the associated TFLGn[TIF] must be cleared first. 0 Interrupt requests from Timer n are disabled. 1 Interrupt will be requested whenever TIF is set. |
| 0 TEN | Timer Enable Enables or disables the timer. 0 Timer n is disabled. 1 Timer n is enabled. |

34.3.7 Timer Flag Register (PIT_TFLGn)

These registers hold the PIT interrupt flags.

Access: User read/write

Address: 4003_7000h base + 10Ch offset + (16d × i), where i=0d to 1d

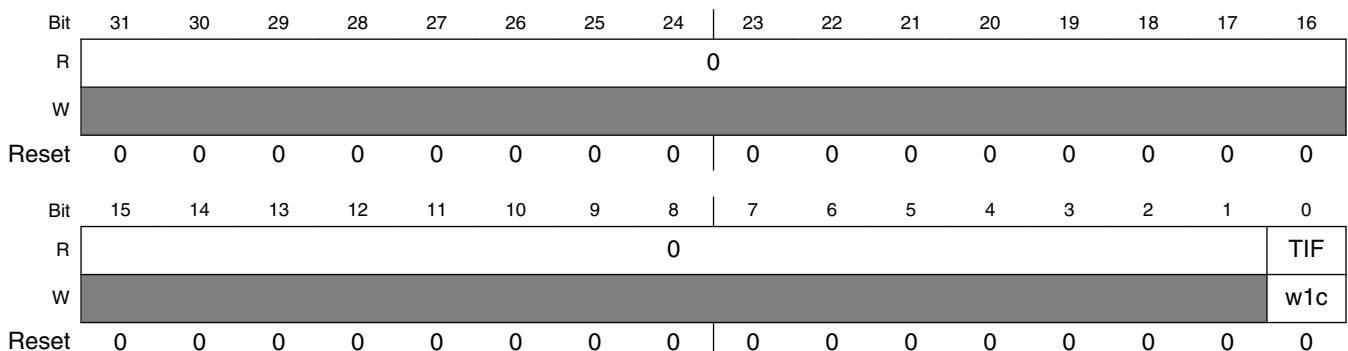

PIT_TFLG n field descriptions

| Field | Description |
|------------------|--|
| 31–1 Reserved | This field is reserved. This read-only field is reserved and always has the value 0. |
| 0 TIF | <p>Timer Interrupt Flag</p> <p>Sets to 1 at the end of the timer period. Writing 1 to this flag clears it. Writing 0 has no effect. If enabled, or, when TCTRLn[TIE] = 1, TIF causes an interrupt request.</p> <p>0 Timeout has not yet occurred. 1 Timeout has occurred.</p> |

34.4 Functional description

This section provides the functional description of the module.

34.4.1 General operation

This section gives detailed information on the internal operation of the module. Each timer can be used to generate trigger pulses and interrupts. Each interrupt is available on a separate interrupt line.

34.4.1.1 Timers

The timers generate triggers at periodic intervals, when enabled. The timers load the start values as specified in their LDVAL registers, count down to 0 and then load the respective start value again. Each time a timer reaches 0, it will generate a trigger pulse and set the interrupt flag.

All interrupts can be enabled or masked by setting TCTRL n [TIE]. A new interrupt can be generated only after the previous one is cleared.

If desired, the current counter value of the timer can be read via the CVAL registers.

The counter period can be restarted, by first disabling, and then enabling the timer with TCTRL n [TEN]. See the following figure.

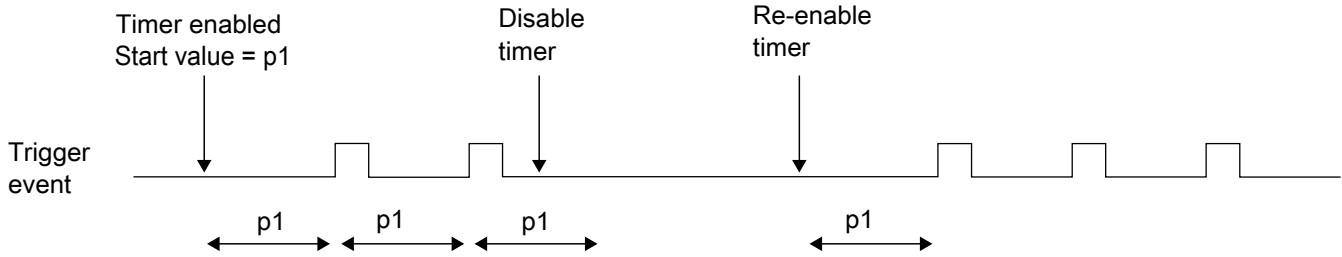

Figure 34-2. Stopping and starting a timer

The counter period of a running timer can be modified, by first disabling the timer, setting a new load value, and then enabling the timer again. See the following figure.

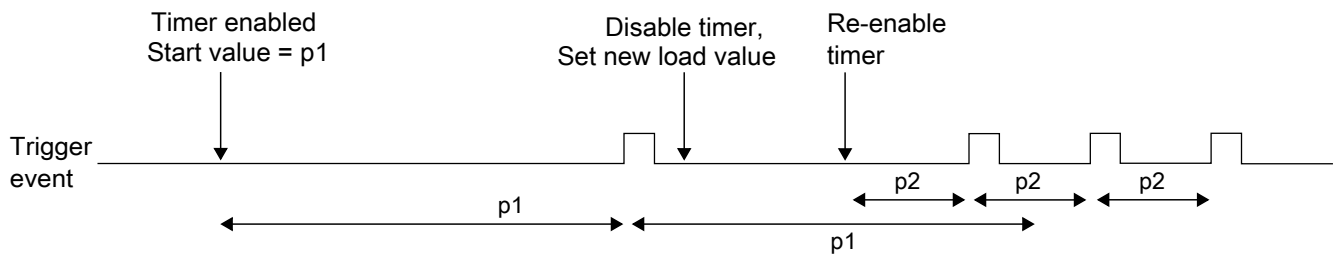

Figure 34-3. Modifying running timer period

It is also possible to change the counter period without restarting the timer by writing LDVAL with the new load value. This value will then be loaded after the next trigger event. See the following figure.

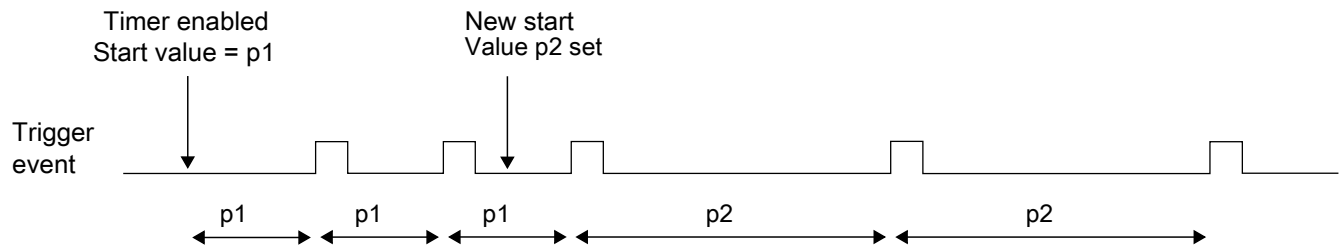

Figure 34-4. Dynamically setting a new load value

34.4.1.2 Debug mode

In Debug mode, the timers will be frozen based on MCR[FRZ]. This is intended to aid software development, allowing the developer to halt the processor, investigate the current state of the system, for example, the timer values, and then continue the operation.

34.4.2 Interrupts

All the timers support interrupt generation. See the MCU specification for related vector addresses and priorities.

Timer interrupts can be enabled by setting TCTRLn[TIE]. TFLGn[TIF] are set to 1 when a timeout occurs on the associated timer, and are cleared to 0 by writing a 1 to the corresponding TFLGn[TIF].

34.4.3 Chained timers

When a timer has chain mode enabled, it will only count after the previous timer has expired. So if timer n-1 has counted down to 0, counter n will decrement the value by one. This allows to chain some of the timers together to form a longer timer. The first timer (timer 0) cannot be chained to any other timer.

34.5 Initialization and application information

In the example configuration:

- The PIT clock has a frequency of 50 MHz.
- Timer 1 creates an interrupt every 5.12 ms.
- Timer 3 creates a trigger event every 30 ms.

The PIT module must be activated by writing a 0 to MCR[MDIS].

The 50 MHz clock frequency equates to a clock period of 20 ns. Timer 1 needs to trigger every $5.12 \text{ ms} / 20 \text{ ns} = 256,000$ cycles and Timer 3 every $30 \text{ ms} / 20 \text{ ns} = 1,500,000$ cycles. The value for the LDVAL register trigger is calculated as:

$\text{LDVAL trigger} = (\text{period} / \text{clock period}) - 1$

This means LDVAL1 and LDVAL3 must be written with 0x0003E7FF and 0x0016E35F respectively.

The interrupt for Timer 1 is enabled by setting TCTRL1[TIE]. The timer is started by writing 1 to TCTRL1[TEN].

Timer 3 shall be used only for triggering. Therefore, Timer 3 is started by writing a 1 to TCTRL3[TEN]. TCTRL3[TIE] stays at 0.

The following example code matches the described setup:

```
// turn on PIT
PIT_MCR = 0x00;

// Timer 1
PIT_LDVAL1 = 0x0003E7FF; // setup timer 1 for 256000 cycles
PIT_TCTRL1 = TIE; // enable Timer 1 interrupts
PIT_TCTRL1 |= TEN; // start Timer 1

// Timer 3
PIT_LDVAL3 = 0x0016E35F; // setup timer 3 for 1500000 cycles
PIT_TCTRL3 |= TEN; // start Timer 3
```

34.6 Example configuration for chained timers

In the example configuration:

- The PIT clock has a frequency of 100 MHz.
- Timers 1 and 2 are available.
- An interrupt shall be raised every 1 minute.

The PIT module needs to be activated by writing a 0 to MCR[MDIS].

The 100 MHz clock frequency equates to a clock period of 10 ns, so the PIT needs to count for 6000 million cycles, which is more than a single timer can do. So, Timer 1 is set up to trigger every 6 s (600 million cycles). Timer 2 is chained to Timer 1 and programmed to trigger 10 times.

The value for the LDVAL register trigger is calculated as number of cycles-1, so LDVAL1 receives the value 0x23C345FF and LDVAL2 receives the value 0x00000009.

The interrupt for Timer 2 is enabled by setting TCTRL2[TIE], the Chain mode is activated by setting TCTRL2[CHN], and the timer is started by writing a 1 to TCTRL2[TEN]. TCTRL1[TEN] needs to be set, and TCTRL1[CHN] and TCTRL1[TIE] are cleared.

The following example code matches the described setup:

```
// turn on PIT
PIT_MCR = 0x00;

// Timer 2
PIT_LDVAL2 = 0x00000009; // setup Timer 2 for 10 counts
PIT_TCTRL2 = TIE; // enable Timer 2 interrupt
PIT_TCTRL2 |= CHN; // chain Timer 2 to Timer 1
PIT_TCTRL2 |= TEN; // start Timer 2
```

Example configuration for the lifetime timer

```
// Timer 1
PIT_LDVAL1 = 0x23C345FF; // setup Timer 1 for 600 000 000 cycles
PIT_TCTRL1 = TEN; // start Timer 1
```

34.7 Example configuration for the lifetime timer

To configure the lifetime timer, channels 0 and 1 need to be chained together.

First the PIT module needs to be activated by writing a 0 to the MDIS bit in the CTRL register, then the LDVAL registers need to be set to the maximum value.

The timer is a downcounter.

The following example code matches the described setup:

```
// turn on PIT
PIT_MCR = 0x00;

// Timer 1
PIT_LDVAL1 = 0xFFFFFFFF; // setup timer 1 for maximum counting period
PIT_TCTRL1 = 0x0; // disable timer 1 interrupts
PIT_TCTRL1 |= CHN; // chain timer 1 to timer 0
PIT_TCTRL1 |= TEN; // start timer 1

// Timer 0
PIT_LDVAL0 = 0xFFFFFFFF; // setup timer 0 for maximum counting period
PIT_TCTRL0 = TEN; // start timer 0
```

To access the lifetime, read first LTMR64H and then LTMR64L.

```
current_uptime = PIT_LTMR64H<<32;
current_uptime = current_uptime + PIT_LTMR64L;
```

Chapter 35

Low-power timer (LPTMR)

The low-power timer (LPTMR) can be configured to operate as a time counter (with optional prescaler) or as a pulse counter (with optional glitch filter) across all power modes, including the low leakage modes.

35.1 Introduction

The low-power timer (LPTMR) can be configured to operate as a time counter with optional prescaler, or as a pulse counter with optional glitch filter, across all power modes, including the low-leakage modes. It can also continue operating through most system reset events, allowing it to be used as a time of day counter.

35.1.1 Features

The features of the LPTMR module include:

- 16-bit time counter or pulse counter with compare
 - Optional interrupt can generate asynchronous wakeup from any low-power mode
 - Hardware trigger output
 - Counter supports free-running mode or reset on compare
- Configurable clock source for prescaler/glitch filter
- Configurable input source for pulse counter
 - Rising-edge or falling-edge

35.1.2 Modes of operation

The following table describes the operation of the LPTMR module in various modes.

Table 35-1. Modes of operation

| Modes | Description |
|-------------|--|
| Run | The LPTMR operates normally. |
| Wait | The LPTMR continues to operate normally and may be configured to exit the low-power mode by generating an interrupt request. |
| Stop | The LPTMR continues to operate normally and may be configured to exit the low-power mode by generating an interrupt request. |
| Low-Leakage | The LPTMR continues to operate normally and may be configured to exit the low-power mode by generating an interrupt request. |
| Debug | The LPTMR operates normally in Pulse Counter mode, but counter does not increment in Time Counter mode. |

35.2 LPTMR signal descriptions

Table 35-2. LPTMR signal descriptions

| Signal | I/O | Description |
|---------------------|-----|-------------------------|
| LPTMR0_ALT <i>n</i> | I | Pulse Counter Input pin |

35.2.1 Detailed signal descriptions

Table 35-3. LPTMR interface—detailed signal descriptions

| Signal | I/O | Description |
|--------------------|-----|--|
| LPTMR_ALT <i>n</i> | I | Pulse Counter Input The LPTMR can select one of the input pins to be used in Pulse Counter mode. |
| | | State meaning Assertion—If configured for pulse counter mode with active-high input, then assertion causes the CNR to increment. Deassertion—If configured for pulse counter mode with active-low input, then deassertion causes the CNR to increment. |
| | | Timing Assertion or deassertion may occur at any time; input may assert asynchronously to the bus clock. |

35.3 Memory map and register definition

LPTMR memory map

| Absolute address (hex) | Register name | Width (in bits) | Access | Reset value | Section/page |
|------------------------|--|-----------------|--------|-------------|----------------------------|
| 4004_0000 | Low Power Timer Control Status Register (LPTMR0_CSR) | 32 | R/W | 0000_0000h | 35.3.1/773 |
| 4004_0004 | Low Power Timer Prescale Register (LPTMR0_PSR) | 32 | R/W | 0000_0000h | 35.3.2/774 |
| 4004_0008 | Low Power Timer Compare Register (LPTMR0_CMR) | 32 | R/W | 0000_0000h | 35.3.3/776 |
| 4004_000C | Low Power Timer Counter Register (LPTMR0_CNR) | 32 | R/W | 0000_0000h | 35.3.4/776 |

35.3.1 Low Power Timer Control Status Register (LPTMRx_CSR)

Address: 4004_0000h base + 0h offset = 4004_0000h

| | | | | | | | | | | | | | | | | |
|-------|----|----|----|----|----|----|----|----|-----|-----|-----|-----|-----|-----|-----|----|
| Bit | 31 | 30 | 29 | 28 | 27 | 26 | 25 | 24 | 23 | 22 | 21 | 20 | 19 | 18 | 17 | 16 |
| R | 0 | | | | | | | | | | | | | | | |
| W | | | | | | | | | | | | | | | | |
| Reset | 0 | 0 | 0 | 0 | 0 | 0 | 0 | 0 | 0 | 0 | 0 | 0 | 0 | 0 | 0 | 0 |
| Bit | 15 | 14 | 13 | 12 | 11 | 10 | 9 | 8 | 7 | 6 | 5 | 4 | 3 | 2 | 1 | 0 |
| R | 0 | | | | | | | | TCF | TIE | TPS | TPP | TFC | TMS | TEN | |
| W | | | | | | | | | w1c | | | | | | | |
| Reset | 0 | 0 | 0 | 0 | 0 | 0 | 0 | 0 | 0 | 0 | 0 | 0 | 0 | 0 | 0 | 0 |

LPTMRx_CSR field descriptions

| Field | Description |
|------------------|--|
| 31–8 Reserved | This field is reserved. This read-only field is reserved and always has the value 0. |
| 7 TCF | Timer Compare Flag TCF is set when the LPTMR is enabled and the CNR equals the CMR and increments. TCF is cleared when the LPTMR is disabled or a logic 1 is written to it. 0 The value of CNR is not equal to CMR and increments. 1 The value of CNR is equal to CMR and increments. |
| 6 TIE | Timer Interrupt Enable When TIE is set, the LPTMR Interrupt is generated whenever TCF is also set. 0 Timer interrupt disabled. 1 Timer interrupt enabled. |
| 5–4 TPS | Timer Pin Select Configures the input source to be used in Pulse Counter mode. TPS must be altered only when the LPTMR is disabled. The input connections vary by device. See the for information on the connections to these inputs. 00 Pulse counter input 0 is selected. |

Table continues on the next page...

LPTMRx_CSR field descriptions (continued)

| Field | Description |
|----------|---|
| | 01 Pulse counter input 1 is selected. 10 Pulse counter input 2 is selected. 11 Pulse counter input 3 is selected. |
| 3 TPP | Timer Pin Polarity Configures the polarity of the input source in Pulse Counter mode. TPP must be changed only when the LPTMR is disabled. 0 Pulse Counter input source is active-high, and the CNR will increment on the rising-edge. 1 Pulse Counter input source is active-low, and the CNR will increment on the falling-edge. |
| 2 TFC | Timer Free-Running Counter When clear, TFC configures the CNR to reset whenever TCF is set. When set, TFC configures the CNR to reset on overflow. TFC must be altered only when the LPTMR is disabled. 0 CNR is reset whenever TCF is set. 1 CNR is reset on overflow. |
| 1 TMS | Timer Mode Select Configures the mode of the LPTMR. TMS must be altered only when the LPTMR is disabled. 0 Time Counter mode. 1 Pulse Counter mode. |
| 0 TEN | Timer Enable When TEN is clear, it resets the LPTMR internal logic, including the CNR and TCF. When TEN is set, the LPTMR is enabled. While writing 1 to this field, CSR[5:1] must not be altered. 0 LPTMR is disabled and internal logic is reset. 1 LPTMR is enabled. |

35.3.2 Low Power Timer Prescale Register (LPTMRx_PSR)

Address: 4004_0000h base + 4h offset = 4004_0004h

| | | | | | | | | | | | | | | | | |
|-------|----|----|----|----|----|----|----|----|----------|----|----|----|------|-----|----|----|
| Bit | 31 | 30 | 29 | 28 | 27 | 26 | 25 | 24 | 23 | 22 | 21 | 20 | 19 | 18 | 17 | 16 |
| R | 0 | | | | | | | | | | | | | | | |
| W | | | | | | | | | | | | | | | | |
| Reset | 0 | 0 | 0 | 0 | 0 | 0 | 0 | 0 | 0 | 0 | 0 | 0 | 0 | 0 | 0 | 0 |
| Bit | 15 | 14 | 13 | 12 | 11 | 10 | 9 | 8 | 7 | 6 | 5 | 4 | 3 | 2 | 1 | 0 |
| R | 0 | | | | | | | | PRESCALE | | | | PBYP | PCS | | |
| W | | | | | | | | | | | | | | | | |
| Reset | 0 | 0 | 0 | 0 | 0 | 0 | 0 | 0 | 0 | 0 | 0 | 0 | 0 | 0 | 0 | 0 |

LPTMRx_PSR field descriptions

| Field | Description |
|------------------|---|
| 31–7 Reserved | This field is reserved. This read-only field is reserved and always has the value 0. |
| 6–3 PRESCALE | <p>Prescaler Value</p> <p>Configures the size of the Prescaler in Time Counter mode or width of the glitch filter in Pulse Counter mode. PRESCALE must be altered only when the LPTMR is disabled.</p> <p>0000 Prescaler divides the prescaler clock by 2; glitch filter does not support this configuration.</p> <p>0001 Prescaler divides the prescaler clock by 4; glitch filter recognizes change on input pin after 2 rising clock edges.</p> <p>0010 Prescaler divides the prescaler clock by 8; glitch filter recognizes change on input pin after 4 rising clock edges.</p> <p>0011 Prescaler divides the prescaler clock by 16; glitch filter recognizes change on input pin after 8 rising clock edges.</p> <p>0100 Prescaler divides the prescaler clock by 32; glitch filter recognizes change on input pin after 16 rising clock edges.</p> <p>0101 Prescaler divides the prescaler clock by 64; glitch filter recognizes change on input pin after 32 rising clock edges.</p> <p>0110 Prescaler divides the prescaler clock by 128; glitch filter recognizes change on input pin after 64 rising clock edges.</p> <p>0111 Prescaler divides the prescaler clock by 256; glitch filter recognizes change on input pin after 128 rising clock edges.</p> <p>1000 Prescaler divides the prescaler clock by 512; glitch filter recognizes change on input pin after 256 rising clock edges.</p> <p>1001 Prescaler divides the prescaler clock by 1024; glitch filter recognizes change on input pin after 512 rising clock edges.</p> <p>1010 Prescaler divides the prescaler clock by 2048; glitch filter recognizes change on input pin after 1024 rising clock edges.</p> <p>1011 Prescaler divides the prescaler clock by 4096; glitch filter recognizes change on input pin after 2048 rising clock edges.</p> <p>1100 Prescaler divides the prescaler clock by 8192; glitch filter recognizes change on input pin after 4096 rising clock edges.</p> <p>1101 Prescaler divides the prescaler clock by 16,384; glitch filter recognizes change on input pin after 8192 rising clock edges.</p> <p>1110 Prescaler divides the prescaler clock by 32,768; glitch filter recognizes change on input pin after 16,384 rising clock edges.</p> <p>1111 Prescaler divides the prescaler clock by 65,536; glitch filter recognizes change on input pin after 32,768 rising clock edges.</p> |
| 2 PBYP | <p>Prescaler Bypass</p> <p>When PBYP is set, the selected prescaler clock in Time Counter mode or selected input source in Pulse Counter mode directly clocks the CNR. When PBYP is clear, the CNR is clocked by the output of the prescaler/glitch filter. PBYP must be altered only when the LPTMR is disabled.</p> <p>0 Prescaler/glitch filter is enabled.</p> <p>1 Prescaler/glitch filter is bypassed.</p> |
| PCS | <p>Prescaler Clock Select</p> <p>Selects the clock to be used by the LPTMR prescaler/glitch filter. PCS must be altered only when the LPTMR is disabled. The clock connections vary by device.</p> <p>NOTE: See the chip configuration details for information on the connections to these inputs.</p> |

Table continues on the next page...

LPTMRx_PSR field descriptions (continued)

| Field | Description |
|-------|---|
| 00 | Prescaler/glitch filter clock 0 selected. |
| 01 | Prescaler/glitch filter clock 1 selected. |
| 10 | Prescaler/glitch filter clock 2 selected. |
| 11 | Prescaler/glitch filter clock 3 selected. |

35.3.3 Low Power Timer Compare Register (LPTMRx_CMCR)

Address: 4004_0000h base + 8h offset = 4004_0008h

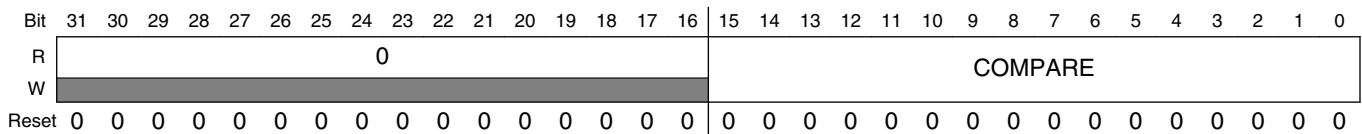

LPTMRx_CMCR field descriptions

| Field | Description |
|-------------------|---|
| 31–16 Reserved | This field is reserved. This read-only field is reserved and always has the value 0. |
| COMPARE | Compare Value When the LPTMR is enabled and the CNR equals the value in the CMR and increments, TCF is set and the hardware trigger asserts until the next time the CNR increments. If the CMR is 0, the hardware trigger will remain asserted until the LPTMR is disabled. If the LPTMR is enabled, the CMR must be altered only when TCF is set. |

35.3.4 Low Power Timer Counter Register (LPTMRx_CNR)

NOTE

See [LPTMR counter](#) for details on how to read counter value.

Address: 4004_0000h base + Ch offset = 4004_000Ch

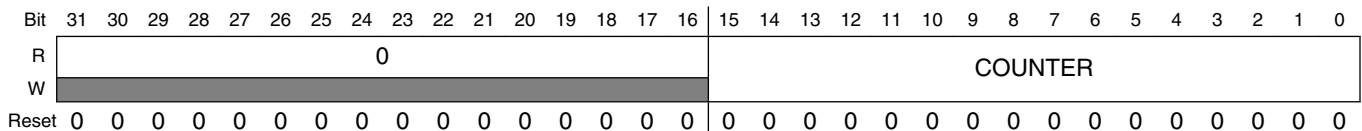

LPTMRx_CNR field descriptions

| Field | Description |
|-------------------|---|
| 31–16 Reserved | This field is reserved. This read-only field is reserved and always has the value 0. |
| COUNTER | Counter Value |

35.4 Functional description

35.4.1 LPTMR power and reset

The LPTMR remains powered in all power modes, including low-leakage modes. If the LPTMR is not required to remain operating during a low-power mode, then it must be disabled before entering the mode.

The LPTMR is reset only on global Power On Reset (POR) or Low Voltage Detect (LVD). When configuring the LPTMR registers, the CSR must be initially written with the timer disabled, before configuring the PSR and CMR. Then, CSR[TIE] must be set as the last step in the initialization. This ensures the LPTMR is configured correctly and the LPTMR counter is reset to zero following a warm reset.

35.4.2 LPTMR clocking

The LPTMR prescaler/glitch filter can be clocked by one of the four clocks. The clock source must be enabled before the LPTMR is enabled.

NOTE

The clock source selected need to be configured to remain enabled in low-power modes, otherwise the LPTMR will not operate during low-power modes.

In Pulse Counter mode with the prescaler/glitch filter bypassed, the selected input source directly clocks the CNR and no other clock source is required. To minimize power in this case, configure the prescaler clock source for a clock that is not toggling.

NOTE

The clock source or pulse input source selected for the LPTMR should not exceed the frequency f_{LPTMR} defined in the device datasheet.

35.4.3 LPTMR prescaler/glitch filter

The LPTMR prescaler and glitch filter share the same logic which operates as a prescaler in Time Counter mode and as a glitch filter in Pulse Counter mode.

NOTE

The prescaler/glitch filter configuration must not be altered when the LPTMR is enabled.

35.4.3.1 Prescaler enabled

In Time Counter mode, when the prescaler is enabled, the output of the prescaler directly clocks the CNR. When the LPTMR is enabled, the CNR will increment every 2^2 to 2^{16} prescaler clock cycles. After the LPTMR is enabled, the first increment of the CNR will take an additional one or two prescaler clock cycles due to synchronization logic.

35.4.3.2 Prescaler bypassed

In Time Counter mode, when the prescaler is bypassed, the selected prescaler clock increments the CNR on every clock cycle. When the LPTMR is enabled, the first increment will take an additional one or two prescaler clock cycles due to synchronization logic.

35.4.3.3 Glitch filter

In Pulse Counter mode, when the glitch filter is enabled, the output of the glitch filter directly clocks the CNR. When the LPTMR is first enabled, the output of the glitch filter is asserted, that is, logic 1 for active-high and logic 0 for active-low. The following table shows the change in glitch filter output with the selected input source.

| If | Then |
|--|--|
| The selected input source remains deasserted for at least 2^1 to 2^{15} consecutive prescaler clock rising edges | The glitch filter output will also deassert. |
| The selected input source remains asserted for at least 2^1 to 2^{15} consecutive prescaler clock rising-edges | The glitch filter output will also assert. |

NOTE

The input is only sampled on the rising clock edge.

The CNR will increment each time the glitch filter output asserts. In Pulse Counter mode, the maximum rate at which the CNR can increment is once every 2^2 to 2^{16} prescaler clock edges. When first enabled, the glitch filter will wait an additional one or two prescaler clock edges due to synchronization logic.

35.4.3.4 Glitch filter bypassed

In Pulse Counter mode, when the glitch filter is bypassed, the selected input source increments the CNR every time it asserts. Before the LPTMR is first enabled, the selected input source is forced to be asserted. This prevents the CNR from incrementing if the selected input source is already asserted when the LPTMR is first enabled.

35.4.4 LPTMR compare

When the CNR equals the value of the CMR and increments, the following events occur:

- CSR[TCF] is set.
- LPTMR interrupt is generated if CSR[TIE] is also set.
- LPTMR hardware trigger is generated.
- CNR is reset if CSR[TFC] is clear.

When the LPTMR is enabled, the CMR can be altered only when CSR[TCF] is set. When updating the CMR, the CMR must be written and CSR[TCF] must be cleared before the LPTMR counter has incremented past the new LPTMR compare value.

35.4.5 LPTMR counter

The CNR increments by one on every:

- Prescaler clock in Time Counter mode with prescaler bypassed
- Prescaler output in Time Counter mode with prescaler enabled
- Input source assertion in Pulse Counter mode with glitch filter bypassed
- Glitch filter output in Pulse Counter mode with glitch filter enabled

The CNR is reset when the LPTMR is disabled or if the counter register overflows. If CSR[TFC] is cleared, then the CNR is also reset whenever CSR[TCF] is set.

The CNR continues incrementing when the core is halted in Debug mode when configured for Pulse Counter mode, the CNR will stop incrementing when the core is halted in Debug mode when configured for Time Counter mode.

The CNR cannot be initialized, but can be read at any time. On each read of the CNR, software must first write to the CNR with any value. This will synchronize and register the current value of the CNR into a temporary register. The contents of the temporary register are returned on each read of the CNR.

When reading the CNR, the bus clock must be at least two times faster than the rate at which the LPTMR counter is incrementing, otherwise incorrect data may be returned.

35.4.6 LPTMR hardware trigger

The LPTMR hardware trigger asserts at the same time the CSR[TCF] is set and can be used to trigger hardware events in other peripherals without software intervention. The hardware trigger is always enabled.

| When | Then |
|---|--|
| The CMR is set to 0 with CSR[TFC] clear | The LPTMR hardware trigger will assert on the first compare and does not deassert. |
| The CMR is set to a nonzero value, or, if CSR[TFC] is set | The LPTMR hardware trigger will assert on each compare and deassert on the following increment of the CNR. |

35.4.7 LPTMR interrupt

The LPTMR interrupt is generated whenever CSR[TIE] and CSR[TCF] are set. CSR[TCF] is cleared by disabling the LPTMR or by writing a logic 1 to it.

CSR[TIE] can be altered and CSR[TCF] can be cleared while the LPTMR is enabled.

The LPTMR interrupt is generated asynchronously to the system clock and can be used to generate a wakeup from any low-power mode, including the low-leakage modes, provided the LPTMR is enabled as a wakeup source.

Chapter 36

Real Time Clock (RTC)

The Real Time Clock (RTC) presents a detail description about the features of RTC that operates in one of two modes of operation—chip power-up and chip power-down.

36.1 Introduction

36.1.1 Features

The RTC module features include:

- 32-bit seconds counter with roll-over protection and 32-bit alarm
- 16-bit prescaler with compensation that can correct errors between 0.12 ppm and 3906 ppm
- Register write protection
 - Lock register requires POR or software reset to enable write access
- 1 Hz square wave output with optional interrupt

36.1.2 Modes of operation

The RTC remains functional in all low power modes and can generate an interrupt to exit any low power mode.

36.1.3 RTC signal descriptions

Table 36-1. RTC signal descriptions

| Signal | Description | I/O |
|------------|-------------------------------------|-----|
| RTC_CLKOUT | 1 Hz square-wave output or OSCERCLK | O |

36.1.3.1 RTC clock output

The clock to the seconds counter is available on the RTC_CLKOUT signal. It is a 1 Hz square wave output.

36.2 Register definition

All registers must be accessed using 32-bit writes and all register accesses incur three wait states.

Write accesses to any register by non-supervisor mode software, when the supervisor access bit in the control register is clear, will terminate with a bus error.

Read accesses by non-supervisor mode software complete as normal.

Writing to a register protected by the lock register does not generate a bus error, but the write will not complete.

RTC memory map

| Absolute address (hex) | Register name | Width (in bits) | Access | Reset value | Section/page |
|------------------------|--|-----------------|--------|-------------|----------------------------|
| 4003_D000 | RTC Time Seconds Register (RTC_TSR) | 32 | R/W | 0000_0000h | 36.2.1/782 |
| 4003_D004 | RTC Time Prescaler Register (RTC_TPR) | 32 | R/W | 0000_0000h | 36.2.2/783 |
| 4003_D008 | RTC Time Alarm Register (RTC_TAR) | 32 | R/W | 0000_0000h | 36.2.3/783 |
| 4003_D00C | RTC Time Compensation Register (RTC_TCR) | 32 | R/W | 0000_0000h | 36.2.4/784 |
| 4003_D010 | RTC Control Register (RTC_CR) | 32 | R/W | 0000_0000h | 36.2.5/785 |
| 4003_D014 | RTC Status Register (RTC_SR) | 32 | R/W | 0000_0001h | 36.2.6/787 |
| 4003_D018 | RTC Lock Register (RTC_LR) | 32 | R/W | 0000_00FFh | 36.2.7/788 |
| 4003_D01C | RTC Interrupt Enable Register (RTC_IER) | 32 | R/W | 0000_0007h | 36.2.8/789 |

36.2.1 RTC Time Seconds Register (RTC_TSR)

Address: 4003_D000h base + 0h offset = 4003_D000h

| Bit | 31 | 30 | 29 | 28 | 27 | 26 | 25 | 24 | 23 | 22 | 21 | 20 | 19 | 18 | 17 | 16 | 15 | 14 | 13 | 12 | 11 | 10 | 9 | 8 | 7 | 6 | 5 | 4 | 3 | 2 | 1 | 0 |
|-------|----|----|----|----|----|----|----|----|----|----|----|----|----|----|----|----|----|----|----|----|----|----|---|---|---|---|---|---|---|---|---|---|
| R | | | | | | | | | | | | | | | | | | | | | | | | | | | | | | | | |
| W | | | | | | | | | | | | | | | | | | | | | | | | | | | | | | | | |
| Reset | 0 | 0 | 0 | 0 | 0 | 0 | 0 | 0 | 0 | 0 | 0 | 0 | 0 | 0 | 0 | 0 | 0 | 0 | 0 | 0 | 0 | 0 | 0 | 0 | 0 | 0 | 0 | 0 | 0 | 0 | 0 | |

RTC_TSR field descriptions

| Field | Description |
|-------|--|
| TSR | <p>Time Seconds Register</p> <p>When the time counter is enabled, the TSR is read only and increments once a second provided SR[TOF] or SR[TIF] are not set. The time counter will read as zero when SR[TOF] or SR[TIF] are set. When the time counter is disabled, the TSR can be read or written. Writing to the TSR when the time counter is disabled will clear the SR[TOF] and/or the SR[TIF]. Writing to TSR with zero is supported, but not recommended because TSR will read as zero when SR[TIF] or SR[TOF] are set (indicating the time is invalid).</p> |

36.2.2 RTC Time Prescaler Register (RTC_TPR)

Address: 4003_D000h base + 4h offset = 4003_D004h

| Bit | 31 | 30 | 29 | 28 | 27 | 26 | 25 | 24 | 23 | 22 | 21 | 20 | 19 | 18 | 17 | 16 | 15 | 14 | 13 | 12 | 11 | 10 | 9 | 8 | 7 | 6 | 5 | 4 | 3 | 2 | 1 | 0 |
|-------|----|----|----|----|----|----|----|----|----|----|----|----|----|----|----|----|-----|----|----|----|----|----|---|---|---|---|---|---|---|---|---|---|
| R | 0 | | | | | | | | | | | | | | | | TPR | | | | | | | | | | | | | | | |
| W | 0 | | | | | | | | | | | | | | | | 0 | | | | | | | | | | | | | | | |
| Reset | 0 | 0 | 0 | 0 | 0 | 0 | 0 | 0 | 0 | 0 | 0 | 0 | 0 | 0 | 0 | 0 | 0 | 0 | 0 | 0 | 0 | 0 | 0 | 0 | 0 | 0 | 0 | 0 | 0 | 0 | 0 | 0 |

RTC_TPR field descriptions

| Field | Description |
|-------------------|---|
| 31–16 Reserved | <p>This field is reserved.</p> <p>This read-only field is reserved and always has the value 0.</p> |
| TPR | <p>Time Prescaler Register</p> <p>When the time counter is enabled, the TPR is read only and increments every 32.768 kHz clock cycle. The time counter will read as zero when SR[TOF] or SR[TIF] are set. When the time counter is disabled, the TPR can be read or written. The TSR[TSR] increments when bit 14 of the TPR transitions from a logic one to a logic zero.</p> |

36.2.3 RTC Time Alarm Register (RTC_TAR)

Address: 4003_D000h base + 8h offset = 4003_D008h

| Bit | 31 | 30 | 29 | 28 | 27 | 26 | 25 | 24 | 23 | 22 | 21 | 20 | 19 | 18 | 17 | 16 | 15 | 14 | 13 | 12 | 11 | 10 | 9 | 8 | 7 | 6 | 5 | 4 | 3 | 2 | 1 | 0 |
|-------|-----|----|----|----|----|----|----|----|----|----|----|----|----|----|----|----|----|----|----|----|----|----|---|---|---|---|---|---|---|---|---|---|
| R | TAR | | | | | | | | | | | | | | | | | | | | | | | | | | | | | | | |
| W | 0 | | | | | | | | | | | | | | | | | | | | | | | | | | | | | | | |
| Reset | 0 | 0 | 0 | 0 | 0 | 0 | 0 | 0 | 0 | 0 | 0 | 0 | 0 | 0 | 0 | 0 | 0 | 0 | 0 | 0 | 0 | 0 | 0 | 0 | 0 | 0 | 0 | 0 | 0 | 0 | 0 | 0 |

RTC_TAR field descriptions

| Field | Description |
|-------|--|
| TAR | <p>Time Alarm Register</p> <p>When the time counter is enabled, the SR[TAF] is set whenever the TAR[TAR] equals the TSR[TSR] and the TSR[TSR] increments. Writing to the TAR clears the SR[TAF].</p> |

36.2.4 RTC Time Compensation Register (RTC_TCR)

Address: 4003_D000h base + Ch offset = 4003_D00Ch

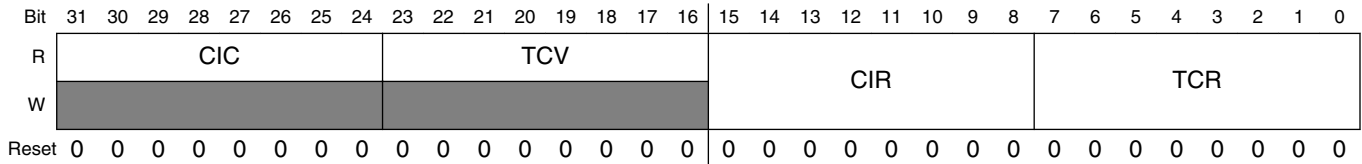

RTC_TCR field descriptions

| Field | Description |
|--------------|--|
| 31–24 CIC | <p>Compensation Interval Counter</p> <p>Current value of the compensation interval counter. If the compensation interval counter equals zero then it is loaded with the contents of the CIR. If the CIC does not equal zero then it is decremented once a second.</p> |
| 23–16 TCV | <p>Time Compensation Value</p> <p>Current value used by the compensation logic for the present second interval. Updated once a second if the CIC equals 0 with the contents of the TCR field. If the CIC does not equal zero then it is loaded with zero (compensation is not enabled for that second increment).</p> |
| 15–8 CIR | <p>Compensation Interval Register</p> <p>Configures the compensation interval in seconds from 1 to 256 to control how frequently the TCR should adjust the number of 32.768 kHz cycles in each second. The value written should be one less than the number of seconds. For example, write zero to configure for a compensation interval of one second. This register is double buffered and writes do not take affect until the end of the current compensation interval.</p> |
| TCR | <p>Time Compensation Register</p> <p>Configures the number of 32.768 kHz clock cycles in each second. This register is double buffered and writes do not take affect until the end of the current compensation interval.</p> <p>80h Time Prescaler Register overflows every 32896 clock cycles. FFh Time Prescaler Register overflows every 32769 clock cycles. 00h Time Prescaler Register overflows every 32768 clock cycles. 01h Time Prescaler Register overflows every 32767 clock cycles. 7Fh Time Prescaler Register overflows every 32641 clock cycles.</p> |

36.2.5 RTC Control Register (RTC_CR)

Address: 4003_D000h base + 10h offset = 4003_D010h

| | | | | | | | | | | | | | | | | |
|-------|------------|----------|------------|------|------|-------|------|------------|----|----|------------|-----|----|-----|-----|-----|
| Bit | 31 | 30 | 29 | 28 | 27 | 26 | 25 | 24 | 23 | 22 | 21 | 20 | 19 | 18 | 17 | 16 |
| R | 0 | | | | | | | | 0 | | | | | | | |
| W | [Reserved] | | | | | | | | | | | | | | | |
| Reset | 0 | 0 | 0 | 0 | 0 | 0 | 0 | 0 | 0 | 0 | 0 | 0 | 0 | 0 | 0 | 0 |
| Bit | 15 | 14 | 13 | 12 | 11 | 10 | 9 | 8 | 7 | 6 | 5 | 4 | 3 | 2 | 1 | 0 |
| R | 0 | Reserved | SC2P | SC4P | SC8P | SC16P | CLKO | OSCE | 0 | | | WPS | UM | SUP | WPE | SWR |
| W | [Reserved] | 0 | [Reserved] | | | | | [Reserved] | | | [Reserved] | | | | | |
| Reset | 0 | 0 | 0 | 0 | 0 | 0 | 0 | 0 | 0 | 0 | 0 | 0 | 0 | 0 | 0 | 0 |

RTC_CR field descriptions

| Field | Description |
|-------------------|---|
| 31–24 Reserved | This field is reserved. This read-only field is reserved and always has the value 0. |
| 23–15 Reserved | This field is reserved. This read-only field is reserved and always has the value 0. |
| 14 Reserved | This field is reserved. It must always be written to 0. |
| 13 SC2P | Oscillator 2pF Load Configure 0 Disable the load. 1 Enable the additional load. |
| 12 SC4P | Oscillator 4pF Load Configure 0 Disable the load. 1 Enable the additional load. |

Table continues on the next page...

RTC_CR field descriptions (continued)

| Field | Description |
|-----------------|---|
| 11 SC8P | Oscillator 8pF Load Configure 0 Disable the load. 1 Enable the additional load. |
| 10 SC16P | Oscillator 16pF Load Configure 0 Disable the load. 1 Enable the additional load. |
| 9 CLKO | Clock Output 0 The 32 kHz clock is output to other peripherals. 1 The 32 kHz clock is not output to other peripherals. |
| 8 OSCE | Oscillator Enable 0 32.768 kHz oscillator is disabled. 1 32.768 kHz oscillator is enabled. After setting this bit, wait the oscillator startup time before enabling the time counter to allow the 32.768 kHz clock time to stabilize. |
| 7–5 Reserved | This field is reserved. This read-only field is reserved and always has the value 0. |
| 4 WPS | Wakeup Pin Select The wakeup pin is optional and not available on all devices. 0 Wakeup pin asserts (active low, open drain) if the RTC interrupt asserts or the wakeup pin is turned on. 1 Wakeup pin instead outputs the RTC 32kHz clock, provided the wakeup pin is turned on and the 32kHz clock is output to other peripherals. |
| 3 UM | Update Mode Allows SR[TCE] to be written even when the Status Register is locked. When set, the SR[TCE] can always be written if the SR[TIF] or SR[TOF] are set or if the SR[TCE] is clear. 0 Registers cannot be written when locked. 1 Registers can be written when locked under limited conditions. |
| 2 SUP | Supervisor Access 0 Non-supervisor mode write accesses are not supported and generate a bus error. 1 Non-supervisor mode write accesses are supported. |
| 1 WPE | Wakeup Pin Enable The wakeup pin is optional and not available on all devices. 0 Wakeup pin is disabled. 1 Wakeup pin is enabled and wakeup pin asserts if the RTC interrupt asserts or the wakeup pin is turned on. |
| 0 SWR | Software Reset 0 No effect. 1 Resets all RTC registers except for the SWR bit . The SWR bit is cleared by POR and by software explicitly clearing it. |

36.2.6 RTC Status Register (RTC_SR)

Address: 4003_D000h base + 14h offset = 4003_D014h

| | | | | | | | | | | | | | | | | | |
|-------|----|----|----|----|----|----|----|----|--|----|----|----|----|----|----|----|----|
| Bit | 31 | 30 | 29 | 28 | 27 | 26 | 25 | 24 | | 23 | 22 | 21 | 20 | 19 | 18 | 17 | 16 |
| R | 0 | | | | | | | | | | | | | | | | |
| W | | | | | | | | | | | | | | | | | |
| Reset | 0 | 0 | 0 | 0 | 0 | 0 | 0 | 0 | | 0 | 0 | 0 | 0 | 0 | 0 | 0 | 0 |
| Bit | 15 | 14 | 13 | 12 | 11 | 10 | 9 | 8 | | 7 | 6 | 5 | 4 | 3 | 2 | 1 | 0 |
| R | 0 | | | | | | | | | | | | | | | | |
| W | | | | | | | | | | | | | | | | | |
| Reset | 0 | 0 | 0 | 0 | 0 | 0 | 0 | 0 | | 0 | 0 | 0 | 0 | 0 | 0 | 0 | 1 |

RTC_SR field descriptions

| Field | Description |
|------------------|---|
| 31–5 Reserved | This field is reserved. This read-only field is reserved and always has the value 0. |
| 4 TCE | Time Counter Enable When time counter is disabled the TSR register and TPR register are writeable, but do not increment. When time counter is enabled the TSR register and TPR register are not writeable, but increment. 0 Time counter is disabled. 1 Time counter is enabled. |
| 3 Reserved | This field is reserved. This read-only field is reserved and always has the value 0. |
| 2 TAF | Time Alarm Flag Time alarm flag is set when the TAR[TAR] equals the TSR[TSR] and the TSR[TSR] increments. This bit is cleared by writing the TAR register. 0 Time alarm has not occurred. 1 Time alarm has occurred. |
| 1 TOF | Time Overflow Flag Time overflow flag is set when the time counter is enabled and overflows. The TSR and TPR do not increment and read as zero when this bit is set. This bit is cleared by writing the TSR register when the time counter is disabled. 0 Time overflow has not occurred. 1 Time overflow has occurred and time counter is read as zero. |
| 0 TIF | Time Invalid Flag The time invalid flag is set on POR or software reset. The TSR and TPR do not increment and read as zero when this bit is set. This bit is cleared by writing the TSR register when the time counter is disabled. 0 Time is valid. 1 Time is invalid and time counter is read as zero. |

36.2.7 RTC Lock Register (RTC_LR)

Address: 4003_D000h base + 18h offset = 4003_D018h

| | | | | | | | | | | | | | | | | | |
|-------|----|----|----|----|----|----|----|----|--|----|-----|-----|-----|-----|----|----|----|
| Bit | 31 | 30 | 29 | 28 | 27 | 26 | 25 | 24 | | 23 | 22 | 21 | 20 | 19 | 18 | 17 | 16 |
| R | 0 | | | | | | | | | | | | | | | | |
| W | | | | | | | | | | | | | | | | | |
| Reset | 0 | 0 | 0 | 0 | 0 | 0 | 0 | 0 | | 0 | 0 | 0 | 0 | 0 | 0 | 0 | 0 |
| Bit | 15 | 14 | 13 | 12 | 11 | 10 | 9 | 8 | | 7 | 6 | 5 | 4 | 3 | 2 | 1 | 0 |
| R | 0 | | | | | | | | | 1 | LRL | SRL | CRL | TCL | 1 | | |
| W | | | | | | | | | | | | | | | | | |
| Reset | 0 | 0 | 0 | 0 | 0 | 0 | 0 | 0 | | 1 | 1 | 1 | 1 | 1 | 1 | 1 | 1 |

RTC_LR field descriptions

| Field | Description |
|------------------|--|
| 31–8 Reserved | This field is reserved. This read-only field is reserved and always has the value 0. |
| 7 Reserved | This field is reserved. This read-only field is reserved and always has the value 1. |
| 6 LRL | Lock Register Lock After being cleared, this bit can be set only by POR or software reset. 0 Lock Register is locked and writes are ignored. 1 Lock Register is not locked and writes complete as normal. |
| 5 SRL | Status Register Lock After being cleared, this bit can be set only by POR or software reset. 0 Status Register is locked and writes are ignored. 1 Status Register is not locked and writes complete as normal. |
| 4 CRL | Control Register Lock After being cleared, this bit can only be set by POR. 0 Control Register is locked and writes are ignored. 1 Control Register is not locked and writes complete as normal. |
| 3 TCL | Time Compensation Lock After being cleared, this bit can be set only by POR or software reset. 0 Time Compensation Register is locked and writes are ignored. 1 Time Compensation Register is not locked and writes complete as normal. |
| Reserved | This field is reserved. This read-only field is reserved and always has the value 1. |

36.2.8 RTC Interrupt Enable Register (RTC_IER)

Address: 4003_D000h base + 1Ch offset = 4003_D01Ch

| | | | | | | | | | | | | | | | | |
|-------|------------|----|----|----|----|----|----|----|------|----------|----|------|----------|------|------|-----|
| Bit | 31 | 30 | 29 | 28 | 27 | 26 | 25 | 24 | 23 | 22 | 21 | 20 | 19 | 18 | 17 | 16 |
| R | 0 | | | | | | | | | | | | | | | |
| W | [Reserved] | | | | | | | | | | | | | | | |
| Reset | 0 | 0 | 0 | 0 | 0 | 0 | 0 | 0 | 0 | 0 | 0 | 0 | 0 | 0 | 0 | 0 |
| Bit | 15 | 14 | 13 | 12 | 11 | 10 | 9 | 8 | 7 | 6 | 5 | 4 | 3 | 2 | 1 | 0 |
| R | 0 | | | | | | | | WPON | Reserved | | TSIE | Reserved | TAIE | TOIE | TIE |
| W | [Reserved] | | | | | | | | | | | | | | | |
| Reset | 0 | 0 | 0 | 0 | 0 | 0 | 0 | 0 | 0 | 0 | 0 | 0 | 0 | 1 | 1 | 1 |

RTC_IER field descriptions

| Field | Description |
|-------------------|---|
| 31–16 Reserved | This field is reserved. This read-only field is reserved and always has the value 0. |
| 15–8 Reserved | This field is reserved. This read-only field is reserved and always has the value 0. |
| 7 WPON | Wakeup Pin On The wakeup pin is optional and not available on all devices. Whenever the wakeup pin is enabled and this bit is set, the wakeup pin will assert. 0 No effect. 1 If the wakeup pin is enabled, then the wakeup pin will assert. |
| 6–5 Reserved | This field is reserved. |
| 4 TSIE | Time Seconds Interrupt Enable The seconds interrupt is an edge-sensitive interrupt with a dedicated interrupt vector. It is generated once a second and requires no software overhead (there is no corresponding status flag to clear). 0 Seconds interrupt is disabled. 1 Seconds interrupt is enabled. |
| 3 Reserved | This field is reserved. |
| 2 TAIE | Time Alarm Interrupt Enable 0 Time alarm flag does not generate an interrupt. 1 Time alarm flag does generate an interrupt. |
| 1 TOIE | Time Overflow Interrupt Enable |

Table continues on the next page...

RTC_IER field descriptions (continued)

| Field | Description |
|-----------|---|
| | 0 Time overflow flag does not generate an interrupt. 1 Time overflow flag does generate an interrupt. |
| 0 TIIE | Time Invalid Interrupt Enable 0 Time invalid flag does not generate an interrupt. 1 Time invalid flag does generate an interrupt. |

36.3 Functional description

36.3.1 Power, clocking, and reset

The RTC is an always powered block that remains active in all low power modes.

The time counter within the RTC is clocked by a 32.768 kHz clock sourced from an external crystal using the oscillator.

The power-on-reset signal initializes all RTC registers to their default state. A software reset bit can also initialize all RTC registers.

36.3.1.1 Oscillator control

The 32.768 kHz crystal oscillator is disabled at POR and must be enabled by software. After enabling the crystal oscillator, wait the oscillator startup time before setting SR[TCE] or using the oscillator clock external to the RTC.

The crystal oscillator includes tunable capacitors that can be configured by software. Do not change the capacitance unless the oscillator is disabled.

36.3.1.2 Software reset

Writing 1 to CR[SWR] forces the equivalent of a POR to the rest of the RTC module. CR[SWR] is not affected by the software reset and must be cleared by software.

36.3.1.3 Supervisor access

When the supervisor access control bit is clear, only supervisor mode software can write to the RTC registers, non-supervisor mode software will generate a bus error. Both supervisor and non-supervisor mode software can always read the RTC registers.

36.3.2 Time counter

The time counter consists of a 32-bit seconds counter that increments once every second and a 16-bit prescaler register that increments once every 32.768 kHz clock cycle.

Reading the time counter (either seconds or prescaler) while it is incrementing may return invalid data due to synchronization of the read data bus. If it is necessary for software to read the prescaler or seconds counter when they could be incrementing, it is recommended that two read accesses are performed and that software verifies that the same data was returned for both reads.

The time seconds register and time prescaler register can be written only when SR[TCE] is clear. Always write to the prescaler register before writing to the seconds register, because the seconds register increments on the falling edge of bit 14 of the prescaler register.

The time prescaler register increments provided SR[TCE] is set, SR[TIF] is clear, SR[TOF] is clear, and the 32.768 kHz clock source is present. After enabling the oscillator, wait the oscillator startup time before setting SR[TCE] to allow time for the oscillator clock output to stabilize.

If the time seconds register overflows then the SR[TOF] will set and the time prescaler register will stop incrementing. Clear SR[TOF] by initializing the time seconds register. The time seconds register and time prescaler register read as zero whenever SR[TOF] is set.

SR[TIF] is set on POR and software reset and is cleared by initializing the time seconds register. The time seconds register and time prescaler register read as zero whenever SR[TIF] is set.

36.3.3 Compensation

The compensation logic provides an accurate and wide compensation range and can correct errors as high as 3906 ppm and as low as 0.12 ppm. The compensation factor must be calculated externally to the RTC and supplied by software to the compensation

register. The RTC itself does not calculate the amount of compensation that is required, although the 1 Hz clock is output to an external pin in support of external calibration logic.

Crystal compensation can be supported by using firmware and crystal characteristics to determine the compensation amount. Temperature compensation can be supported by firmware that periodically measures the external temperature via ADC and updates the compensation register based on a look-up table that specifies the change in crystal frequency over temperature.

The compensation logic alters the number of 32.768 kHz clock cycles it takes for the prescaler register to overflow and increment the time seconds counter. The time compensation value is used to adjust the number of clock cycles between -127 and +128. Cycles are added or subtracted from the prescaler register when the prescaler register equals 0x3FFF and then increments. The compensation interval is used to adjust the frequency at which the time compensation value is used, that is, from once a second to once every 256 seconds.

Updates to the time compensation register will not take effect until the next time the time seconds register increments and provided the previous compensation interval has expired. When the compensation interval is set to other than once a second then the compensation is applied in the first second interval and the remaining second intervals receive no compensation.

Compensation is disabled by configuring the time compensation register to zero.

36.3.4 Time alarm

The Time Alarm register (TAR), SR[TAF], and IER[TAIE] allow the RTC to generate an interrupt at a predefined time. The 32-bit TAR is compared with the 32-bit Time Seconds register (TSR) each time it increments. SR[TAF] will set when TAR equals TSR and TSR increments.

SR[TAF] is cleared by writing TAR. This will usually be the next alarm value, although writing a value that is less than TSR, such as 0, will prevent SR[TAF] from setting again. SR[TAF] cannot otherwise be disabled, although the interrupt it generates is enabled or disabled by IER[TAIE].

36.3.5 Update mode

The Update Mode field in the Control register (CR[UM]) configures software write access to the Time Counter Enable (SR[TCE]) field. When CR[UM] is clear, SR[TCE] can be written only when LR[SRL] is set. When CR[UM] is set, SR[TCE] can also be written when SR[TCE] is clear or when SR[TIF] or SR[TOF] are set. This allows the time seconds and prescaler registers to be initialized whenever time is invalidated, while preventing the time seconds and prescaler registers from being changed on the fly. When LR[SRL] is set, CR[UM] has no effect on SR[TCE].

36.3.6 Register lock

The Lock register (LR) can be used to block write accesses to certain registers until the next POR or software reset. Locking the Control register (CR) will disable the software reset. Locking LR will block future updates to LR.

Write accesses to a locked register are ignored and do not generate a bus error.

36.3.7 Interrupt

The RTC interrupt is asserted whenever a status flag and the corresponding interrupt enable bit are both set. It is always asserted on POR, and software reset. The RTC interrupt is enabled at the chip level by enabling the chip-specific RTC clock gate control bit. The RTC interrupt can be used to wakeup the chip from any low-power mode.

The optional RTC seconds interrupt is an edge-sensitive interrupt with a dedicated interrupt vector that is generated once a second and requires no software overhead (there is no corresponding status flag to clear). It is enabled in the RTC by the time seconds interrupt enable bit and enabled at the chip level by setting the chip-specific RTC clock gate control bit. This interrupt is optional and may not be implemented on all devices.

Chapter 37

Serial Peripheral Interface (SPI)

37.1 Introduction

The serial peripheral interface (SPI) module provides a synchronous serial bus for communication between a chip and an external peripheral device.

37.1.1 Block Diagram

The block diagram of this module is as follows:

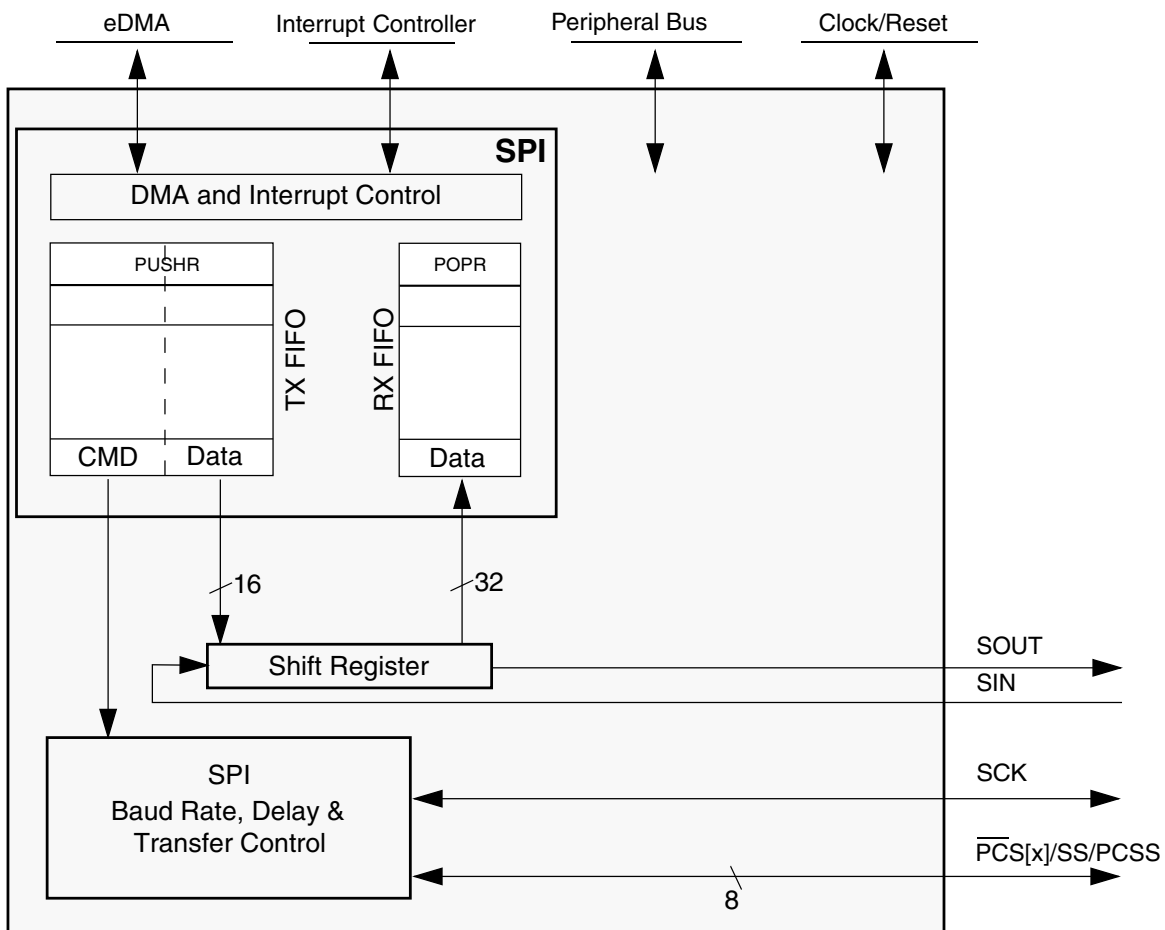

Figure 37-1. SPI Block Diagram

37.1.2 Features

The module supports the following features:

- Full-duplex, three-wire synchronous transfers
- Master mode
- Slave mode
- Data streaming operation in Slave mode with continuous slave selection
- Buffered transmit operation using the transmit first in first out (TX FIFO) with depth of 4 entries
- Buffered receive operation using the receive FIFO (RX FIFO) with depth of 4 entries
- TX and RX FIFOs can be disabled individually for low-latency updates to SPI queues

- Visibility into TX and RX FIFOs for ease of debugging
- Programmable transfer attributes on a per-frame basis:
 - two transfer attribute registers
 - Serial clock (SCK) with programmable polarity and phase
 - Various programmable delays
 - Programmable serial frame size: 4 to 324 to 16
 - SPI frames longer than 16 bits can be supported using the continuous selection format.
 - Continuously held chip select capability
- 4 peripheral chip selects (PCSEs), expandable to 16 with external demultiplexer
- Deglitching support for up to 8 peripheral chip selects (PCSEs) with external demultiplexer
- DMA support for adding entries to TX FIFO and removing entries from RX FIFO:
 - TX FIFO is not full (TFFF)
 - RX FIFO is not empty (RFDF)
- Interrupt conditions:
 - End of Queue reached (EOQF)
 - TX FIFO is not full (TFFF)
 - Transfer of current frame complete (TCF)
 - Attempt to transmit with an empty Transmit FIFO (TFUF)
 - RX FIFO is not empty (RFDF)
 - Frame received while Receive FIFO is full (RFOF)
- Global interrupt request line
- Modified SPI transfer formats for communication with slower peripheral devices
- Power-saving architectural features:
 - Support for Stop mode
 - Support for Doze mode

37.1.3 Interface configurations

37.1.3.1 SPI configuration

The Serial Peripheral Interface SPI configuration allows the module to send and receive serial data. This configuration allows the module to operate as a basic SPI block with internal FIFOs supporting external queue operation. Transmitted data and received data reside in separate FIFOs. The host CPU or a DMA controller read the received data from the Receive FIFO and write transmit data to the Transmit FIFO.

For queued operations, the SPI queues can reside in system RAM, external to the module. Data transfers between the queues and the module FIFOs are accomplished by a DMA controller or host CPU. The following figure shows a system example with DMA, SPI, and external queues in system RAM.

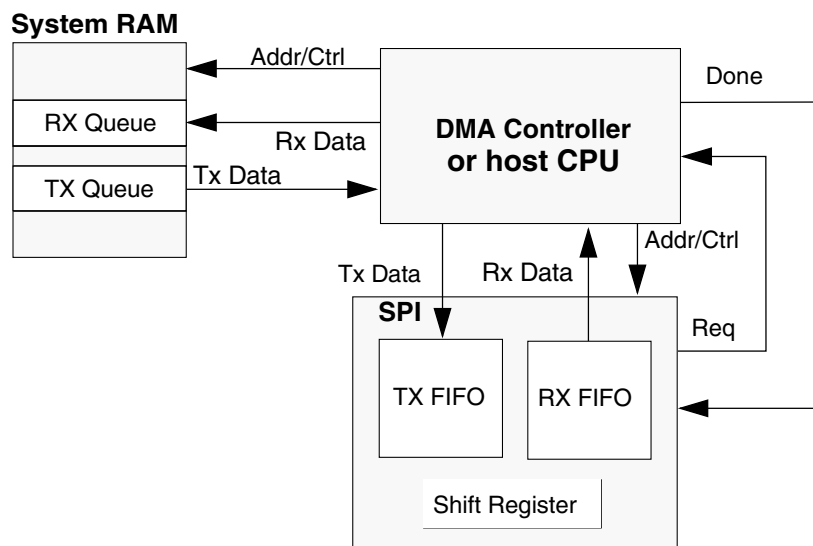

Figure 37-2. SPI with queues and DMA

37.1.4 Modes of Operation

The module supports the following modes of operation that can be divided into two categories:

- Module-specific modes:
 - Master mode

- Slave mode
- Module Disable mode
- Chip-specific modes:
 - External Stop mode
 - Debug mode

The module enters module-specific modes when the host writes a module register. The chip-specific modes are controlled by signals external to the module. The chip-specific modes are modes that a chip may enter in parallel to the block-specific modes.

37.1.4.1 Master Mode

Master mode allows the module to initiate and control serial communication. In this mode, these signals are controlled by the module and configured as outputs:

- SCK
- SOUT
- PCS[*x*]

37.1.4.2 Slave Mode

Slave mode allows the module to communicate with SPI bus masters. In this mode, the module responds to externally controlled serial transfers. The SCK signal and the PCS[0]/ \overline{SS} signals are configured as inputs and driven by an SPI bus master.

37.1.4.3 Module Disable Mode

The Module Disable mode can be used for chip power management. The clock to the non-memory mapped logic in the module can be stopped while in the Module Disable mode.

37.1.4.4 External Stop Mode

External Stop mode is used for chip power management. The module supports the Peripheral Bus Stop mode mechanism. When a request is made to enter External Stop mode, it acknowledges the request and completes the transfer that is in progress. When the module reaches the frame boundary, it signals that the protocol clock to the module may be shut off.

NOTE

In master mode, if a serial transfer is in progress, then this module waits until it reaches the frame boundary before it is ready to have its clocks shut off. In slave mode, this module waits until its chip select input signal goes high before it is ready to have its clocks shut off. It should be noted that the CS0 pad must be correctly configured to allow it to return to high when no transfer is occurring. If the pad is tied low then this could prevent the module from being correctly disabled.

37.1.4.5 Debug Mode

Debug mode is used for system development and debugging. The MCR[FRZ] bit controls module behavior in the Debug mode:

- If the bit is set, the module stops all serial transfers, when the chip is in debug mode.
- If the bit is cleared, the chip debug mode has no effect on the module.

37.2 Module signal descriptions

This table describes the signals on the boundary of the module that may connect off chip (in alphabetical order).

Table 37-1. Module signal descriptions

| Signal | Master mode | Slave mode | I/O |
|----------|------------------------------|------------------|-----|
| PCS0/SS | Peripheral Chip Select 0 (O) | Slave Select (I) | I/O |
| PCS[1:3] | Peripheral Chip Selects 1–3 | (Unused) | O |
| SCK | Serial Clock (O) | Serial Clock (I) | I/O |
| SIN | Serial Data In | Serial Data In | I |
| SOUT | Serial Data Out | Serial Data Out | O |

37.2.1 PCS0/ \overline{SS} —Peripheral Chip Select/Slave Select

Master mode: Peripheral Chip Select 0 (O)—Selects an SPI slave to receive data transmitted from the module.

Slave mode: Slave Select (I)—Selects the module to receive data transmitted from an SPI master.

NOTE

Do not tie the SPI slave select pin to ground. Otherwise, SPI cannot function properly.

37.2.2 PCS1–PCS3—Peripheral Chip Selects 1–3

Master mode: Peripheral Chip Selects 1–3 (O)—Select an SPI slave to receive data transmitted by the module.

Slave mode: Unused

37.2.3 SCK—Serial Clock

Master mode: Serial Clock (O)—Supplies a clock signal from the module to SPI slaves.

Slave mode: Serial Clock (I)—Supplies a clock signal to the module from an SPI master.

37.2.4 SIN—Serial Input

Master mode: Serial Input (I)—Receives serial data.

Slave mode: Serial Input (I)—Receives serial data.

37.2.5 SOUT—Serial Output

Master mode: Serial Output (O)—Transmits serial data.

Slave mode: Serial Output (O)—Transmits serial data.

37.3 Memory Map/Register Definition

Register accesses to memory addresses that are reserved or undefined result in a transfer error. Any Write access to the POPR and RXFRn also results in a transfer error.

SPI memory map

| Absolute address (hex) | Register name | Width (in bits) | Access | Reset value | Section/page |
|------------------------|---|-----------------|--------|-------------|-----------------------------|
| 4002_C000 | Module Configuration Register (SPI0_MCR) | 32 | R/W | 0000_4001h | 37.3.1/804 |
| 4002_C008 | Transfer Count Register (SPI0_TCR) | 32 | R/W | 0000_0000h | 37.3.2/807 |
| 4002_C00C | Clock and Transfer Attributes Register (In Master Mode) (SPI0_CTAR0) | 32 | R/W | 7800_0000h | 37.3.3/808 |
| 4002_C00C | Clock and Transfer Attributes Register (In Slave Mode) (SPI0_CTAR0_SLAVE) | 32 | R/W | 7800_0000h | 37.3.4/813 |
| 4002_C010 | Clock and Transfer Attributes Register (In Master Mode) (SPI0_CTAR1) | 32 | R/W | 7800_0000h | 37.3.3/808 |
| 4002_C02C | Status Register (SPI0_SR) | 32 | R/W | 0200_0000h | 37.3.5/814 |
| 4002_C030 | DMA/Interrupt Request Select and Enable Register (SPI0_RSER) | 32 | R/W | 0000_0000h | 37.3.6/817 |
| 4002_C034 | PUSH TX FIFO Register In Master Mode (SPI0_PUSHR) | 32 | R/W | 0000_0000h | 37.3.7/819 |
| 4002_C034 | PUSH TX FIFO Register In Slave Mode (SPI0_PUSHR_SLAVE) | 32 | R/W | 0000_0000h | 37.3.8/821 |
| 4002_C038 | POP RX FIFO Register (SPI0_POPR) | 32 | R | 0000_0000h | 37.3.9/821 |
| 4002_C03C | Transmit FIFO Registers (SPI0_TXFR0) | 32 | R | 0000_0000h | 37.3.10/822 |
| 4002_C040 | Transmit FIFO Registers (SPI0_TXFR1) | 32 | R | 0000_0000h | 37.3.10/822 |
| 4002_C044 | Transmit FIFO Registers (SPI0_TXFR2) | 32 | R | 0000_0000h | 37.3.10/822 |
| 4002_C048 | Transmit FIFO Registers (SPI0_TXFR3) | 32 | R | 0000_0000h | 37.3.10/822 |
| 4002_C07C | Receive FIFO Registers (SPI0_RXFR0) | 32 | R | 0000_0000h | 37.3.11/822 |
| 4002_C080 | Receive FIFO Registers (SPI0_RXFR1) | 32 | R | 0000_0000h | 37.3.11/822 |
| 4002_C084 | Receive FIFO Registers (SPI0_RXFR2) | 32 | R | 0000_0000h | 37.3.11/822 |
| 4002_C088 | Receive FIFO Registers (SPI0_RXFR3) | 32 | R | 0000_0000h | 37.3.11/822 |
| 4002_D000 | Module Configuration Register (SPI1_MCR) | 32 | R/W | 0000_4001h | 37.3.1/804 |
| 4002_D008 | Transfer Count Register (SPI1_TCR) | 32 | R/W | 0000_0000h | 37.3.2/807 |
| 4002_D00C | Clock and Transfer Attributes Register (In Master Mode) (SPI1_CTAR0) | 32 | R/W | 7800_0000h | 37.3.3/808 |

Table continues on the next page...

SPI memory map (continued)

| Absolute address (hex) | Register name | Width (in bits) | Access | Reset value | Section/page |
|------------------------|---|-----------------|--------|-------------|-----------------------------|
| 4002_D00C | Clock and Transfer Attributes Register (In Slave Mode) (SPI1_CTAR0_SLAVE) | 32 | R/W | 7800_0000h | 37.3.4/813 |
| 4002_D010 | Clock and Transfer Attributes Register (In Master Mode) (SPI1_CTAR1) | 32 | R/W | 7800_0000h | 37.3.3/808 |
| 4002_D02C | Status Register (SPI1_SR) | 32 | R/W | 0200_0000h | 37.3.5/814 |
| 4002_D030 | DMA/Interrupt Request Select and Enable Register (SPI1_RSER) | 32 | R/W | 0000_0000h | 37.3.6/817 |
| 4002_D034 | PUSH TX FIFO Register In Master Mode (SPI1_PUSHR) | 32 | R/W | 0000_0000h | 37.3.7/819 |
| 4002_D034 | PUSH TX FIFO Register In Slave Mode (SPI1_PUSHR_SLAVE) | 32 | R/W | 0000_0000h | 37.3.8/821 |
| 4002_D038 | POP RX FIFO Register (SPI1_POPR) | 32 | R | 0000_0000h | 37.3.9/821 |
| 4002_D03C | Transmit FIFO Registers (SPI1_TXFR0) | 32 | R | 0000_0000h | 37.3.10/822 |
| 4002_D040 | Transmit FIFO Registers (SPI1_TXFR1) | 32 | R | 0000_0000h | 37.3.10/822 |
| 4002_D044 | Transmit FIFO Registers (SPI1_TXFR2) | 32 | R | 0000_0000h | 37.3.10/822 |
| 4002_D048 | Transmit FIFO Registers (SPI1_TXFR3) | 32 | R | 0000_0000h | 37.3.10/822 |
| 4002_D07C | Receive FIFO Registers (SPI1_RXFR0) | 32 | R | 0000_0000h | 37.3.11/822 |
| 4002_D080 | Receive FIFO Registers (SPI1_RXFR1) | 32 | R | 0000_0000h | 37.3.11/822 |
| 4002_D084 | Receive FIFO Registers (SPI1_RXFR2) | 32 | R | 0000_0000h | 37.3.11/822 |
| 4002_D088 | Receive FIFO Registers (SPI1_RXFR3) | 32 | R | 0000_0000h | 37.3.11/822 |

37.3.1 Module Configuration Register (SPIx_MCR)

Contains bits to configure various attributes associated with the module operations. The HALT and MDIS bits can be changed at any time, but the effect takes place only on the next frame boundary. Only the HALT and MDIS bits in the MCR can be changed, while the module is in the Running state.

Address: Base address + 0h offset

| Bit | 31 | 30 | 29 | 28 | 27 | 26 | 25 | 24 | 23 | 22 | 21 | 20 | 19 | 18 | 17 | 16 |
|-------|------|-----------|---------|---------|---------|---------|----------|------|----------|----|----|----|----------|----------|------|----|
| R | | | DCONF | | | | Reserved | ROOE | Reserved | | | | PCISIS | | | |
| W | MSTR | CONT_SCKE | | | FRZ | MTFE | | | | | | | | | | |
| Reset | 0 | 0 | 0 | 0 | 0 | 0 | 0 | 0 | 0 | 0 | 0 | 0 | 0 | 0 | 0 | 0 |
| Bit | 15 | 14 | 13 | 12 | 11 | 10 | 9 | 8 | 7 | 6 | 5 | 4 | 3 | 2 | 1 | 0 |
| R | | | | | 0 | 0 | SMPL_PT | | 0 | | | | Reserved | Reserved | HALT | |
| W | DOZE | MDIS | DIS_TXF | DIS_RXF | CLR_TXF | CLR_RXF | | | | | | | | | | |
| Reset | 0 | 1 | 0 | 0 | 0 | 0 | 0 | 0 | 0 | 0 | 0 | 0 | 0 | 0 | 0 | 1 |

SPIx_MCR field descriptions

| Field | Description |
|-------------------|--|
| 31 MSTR | <p>Master/Slave Mode Select</p> <p>Enables either Master mode (if supported) or Slave mode (if supported) operation.</p> <p>0 Enables Slave mode 1 Enables Master mode</p> |
| 30 CONT_SCKE | <p>Continuous SCK Enable</p> <p>Enables the Serial Communication Clock (SCK) to run continuously.</p> <p>0 Continuous SCK disabled. 1 Continuous SCK enabled.</p> |
| 29–28 DCONF | <p>SPI Configuration.</p> <p>Selects among the different configurations of the module.</p> <p>00 SPI 01 Reserved 10 Reserved 11 Reserved</p> |
| 27 FRZ | <p>Freeze</p> <p>Enables transfers to be stopped on the next frame boundary when the device enters Debug mode.</p> <p>0 Do not halt serial transfers in Debug mode. 1 Halt serial transfers in Debug mode.</p> |
| 26 MTFE | <p>Modified Transfer Format Enable</p> <p>Enables a modified transfer format to be used.</p> <p>NOTE: When MTFE=1 with continuous SCK enabled (MCR [CONT_SCKE]=1) in master mode, configure CTAR[LSBFE]=0 for correct operations while receiving unequal length frames. If PUSHR[CONT] is also set for back to back frame transfer, also configure the frame size of the first frame as less than or equal to the frame size of the next frame. In this scenario, make sure that for all received frames, the bits are read equal to their respective frame sizes and any extra bits during POP operation are masked.</p> <p>0 Modified SPI transfer format disabled. 1 Modified SPI transfer format enabled.</p> |
| 25 Reserved | This field is reserved. |
| 24 ROOE | <p>Receive FIFO Overflow Overwrite Enable</p> <p>In the RX FIFO overflow condition, configures the module to ignore the incoming serial data or overwrite existing data. If the RX FIFO is full and new data is received, the data from the transfer, generating the overflow, is ignored or shifted into the shift register.</p> <p>0 Incoming data is ignored. 1 Incoming data is shifted into the shift register.</p> |
| 23–20 Reserved | <p>Always write the reset value to this field.</p> <p>This field is reserved.</p> |

Table continues on the next page...

SPIx_MCR field descriptions (continued)

| Field | Description |
|-----------------|--|
| 19–16 PC SIS | <p>Peripheral Chip Select x Inactive State</p> <p>Determines the inactive state of PCSx. Refer to the chip-specific SPI information for the number of PCS signals used in this chip.</p> <p>NOTE: The effect of this bit only takes place when module is enabled. Ensure that this bit is configured correctly before enabling the SPI interface.</p> <p>0 The inactive state of PCSx is low. 1 The inactive state of PCSx is high.</p> |
| 15 DOZE | <p>Doze Enable</p> <p>Provides support for an externally controlled Doze mode power-saving mechanism.</p> <p>0 Doze mode has no effect on the module. 1 Doze mode disables the module.</p> |
| 14 MDIS | <p>Module Disable</p> <p>Allows the clock to be stopped to the non-memory mapped logic in the module effectively putting it in a software-controlled power-saving state. The reset value of the MDIS bit is parameterized, with a default reset value of 1. When the module is used in Slave Mode, it is recommended to leave this bit 0, because a slave doesn't have control over master transactions.</p> <p>0 Enables the module clocks. 1 Allows external logic to disable the module clocks.</p> |
| 13 DIS_TXF | <p>Disable Transmit FIFO</p> <p>When the TX FIFO is disabled, the transmit part of the module operates as a simplified double-buffered SPI. This bit can be written only when the MDIS bit is cleared.</p> <p>0 TX FIFO is enabled. 1 TX FIFO is disabled.</p> |
| 12 DIS_RXF | <p>Disable Receive FIFO</p> <p>When the RX FIFO is disabled, the receive part of the module operates as a simplified double-buffered SPI. This bit can only be written when the MDIS bit is cleared.</p> <p>0 RX FIFO is enabled. 1 RX FIFO is disabled.</p> |
| 11 CLR_TXF | <p>Clear TX FIFO</p> <p>Flushes the TX FIFO. Writing a 1 to CLR_TXF clears the TX FIFO Counter. The CLR_TXF bit is always read as zero.</p> <p>0 Do not clear the TX FIFO counter. 1 Clear the TX FIFO counter.</p> |
| 10 CLR_RXF | <p>Clear RX FIFO</p> <p>Flushes the RX FIFO. Writing a 1 to CLR_RXF clears the RX Counter. The CLR_RXF bit is always read as zero.</p> <p>0 Do not clear the RX FIFO counter. 1 Clear the RX FIFO counter.</p> |

Table continues on the next page...

SPIx_MCR field descriptions (continued)

| Field | Description |
|-----------------|---|
| 9–8 SMPL_PT | <p>Sample Point</p> <p>Controls when the module master samples SIN in Modified Transfer Format. This field is valid only when CPHA bit in CTARn[CPHA] is 0.</p> <p>00 0 protocol clock cycles between SCK edge and SIN sample 01 1 protocol clock cycle between SCK edge and SIN sample 10 2 protocol clock cycles between SCK edge and SIN sample 11 Reserved</p> |
| 7–3 Reserved | This field is reserved. This read-only field is reserved and always has the value 0. |
| 2 Reserved | This field is reserved. |
| 1 Reserved | This field is reserved. |
| 0 HALT | <p>Halt</p> <p>The HALT bit starts and stops frame transfers. See Start and Stop of Module transfers</p> <p>0 Start transfers. 1 Stop transfers.</p> |

37.3.2 Transfer Count Register (SPIx_TCR)

TCR contains a counter that indicates the number of SPI transfers made. The transfer counter is intended to assist in queue management. Do not write the TCR when the module is in the Running state.

Address: Base address + 8h offset

| | | | | | | | | | | | | | | | | | | | | | | | | | | | | | | | | |
|-------|----------|----|----|----|----|----|----|----|----|----|----|----|----|----|----|----|----|----|----|----|----|----|---|---|---|---|---|---|---|---|---|---|
| Bit | 31 | 30 | 29 | 28 | 27 | 26 | 25 | 24 | 23 | 22 | 21 | 20 | 19 | 18 | 17 | 16 | 15 | 14 | 13 | 12 | 11 | 10 | 9 | 8 | 7 | 6 | 5 | 4 | 3 | 2 | 1 | 0 |
| R | SPI_TCNT | | | | | | | | | | | | | | | | 0 | | | | | | | | | | | | | | | |
| W | | | | | | | | | | | | | | | | | | | | | | | | | | | | | | | | |
| Reset | 0 | 0 | 0 | 0 | 0 | 0 | 0 | 0 | 0 | 0 | 0 | 0 | 0 | 0 | 0 | 0 | 0 | 0 | 0 | 0 | 0 | 0 | 0 | 0 | 0 | 0 | 0 | 0 | 0 | 0 | 0 | 0 |

SPIx_TCR field descriptions

| Field | Description |
|-------------------|---|
| 31–16 SPI_TCNT | <p>SPI Transfer Counter</p> <p>Counts the number of SPI transfers the module makes. The SPI_TCNT field increments every time the last bit of an SPI frame is transmitted. A value written to SPI_TCNT presets the counter to that value. SPI_TCNT is reset to zero at the beginning of the frame when the CTCNT field is set in the executing SPI command. The Transfer Counter wraps around; incrementing the counter past 65535 resets the counter to zero.</p> |

Table continues on the next page...

SPIx_TCR field descriptions (continued)

| Field | Description |
|----------|---|
| Reserved | This field is reserved. This read-only field is reserved and always has the value 0. |

37.3.3 Clock and Transfer Attributes Register (In Master Mode) (SPIx_CTARn)

CTAR registers are used to define different transfer attributes. Do not write to the CTAR registers while the module is in the Running state.

In Master mode, the CTAR registers define combinations of transfer attributes such as frame size, clock phase and polarity, data bit ordering, baud rate, and various delays. In slave mode, a subset of the bitfields in CTAR0 are used to set the slave transfer attributes.

When the module is configured as a SPI master, the CTAS field in the command portion of the TX FIFO entry selects which of the CTAR registers is used. When the module is configured as an SPI bus slave, it uses the CTAR0 register.

Address: Base address + Ch offset + (4d × i), where i=0d to 1d

| | | | | | | | | | | | | | | | | |
|-------|-------|------|----|----|-----|------|------|-------|--------|------|----|-----|-----|----|----|----|
| Bit | 31 | 30 | 29 | 28 | 27 | 26 | 25 | 24 | 23 | 22 | 21 | 20 | 19 | 18 | 17 | 16 |
| R | | | | | | | | | | | | | | | | |
| W | DBR | FMSZ | | | | CPOL | CPHA | LSBFE | PCSSCK | PASC | | PDT | PBR | | | |
| Reset | 0 | 1 | 1 | 1 | 1 | 0 | 0 | 0 | 0 | 0 | 0 | 0 | 0 | 0 | 0 | 0 |
| Bit | 15 | 14 | 13 | 12 | 11 | 10 | 9 | 8 | 7 | 6 | 5 | 4 | 3 | 2 | 1 | 0 |
| R | | | | | | | | | | | | | | | | |
| W | CSSCK | | | | ASC | | | | DT | | | | BR | | | |
| Reset | 0 | 0 | 0 | 0 | 0 | 0 | 0 | 0 | 0 | 0 | 0 | 0 | 0 | 0 | 0 | 0 |

SPIx_CTARn field descriptions

| Field | Description |
|-----------|--|
| 31 DBR | Double Baud Rate Doubles the effective baud rate of the Serial Communications Clock (SCK). This field is used only in master mode. It effectively halves the Baud Rate division ratio, supporting faster frequencies, and odd division ratios for the Serial Communications Clock (SCK). When the DBR bit is set, the duty cycle of the Serial Communications Clock (SCK) depends on the value in the Baud Rate Prescaler and the Clock |

Table continues on the next page...

SPIx_CTARn field descriptions (continued)

| Field | Description | | | | | | | | | | | | | | | | | | | | | | | | | | | | | | | | | | | | | | | | |
|---------------|---|-----|----------------|-----|----------------|---|-----|-----|-------|---|---|----|-------|---|---|----|-------|---|---|----|-------|---|---|----|-------|---|---|----|-------|---|---|----|-------|---|---|----|-------|---|---|----|-------|
| | <p>Phase bit as listed in the following table. See the BR field description for details on how to compute the baud rate.</p> <p style="text-align: center;">Table 37-2. SPI SCK Duty Cycle</p> <table border="1" style="margin-left: auto; margin-right: auto;"> <thead> <tr> <th>DBR</th> <th>CPHA</th> <th>PBR</th> <th>SCK Duty Cycle</th> </tr> </thead> <tbody> <tr> <td>0</td> <td>any</td> <td>any</td> <td>50/50</td> </tr> <tr> <td>1</td> <td>0</td> <td>00</td> <td>50/50</td> </tr> <tr> <td>1</td> <td>0</td> <td>01</td> <td>33/66</td> </tr> <tr> <td>1</td> <td>0</td> <td>10</td> <td>40/60</td> </tr> <tr> <td>1</td> <td>0</td> <td>11</td> <td>43/57</td> </tr> <tr> <td>1</td> <td>1</td> <td>00</td> <td>50/50</td> </tr> <tr> <td>1</td> <td>1</td> <td>01</td> <td>66/33</td> </tr> <tr> <td>1</td> <td>1</td> <td>10</td> <td>60/40</td> </tr> <tr> <td>1</td> <td>1</td> <td>11</td> <td>57/43</td> </tr> </tbody> </table> <p>0 The baud rate is computed normally with a 50/50 duty cycle. 1 The baud rate is doubled with the duty cycle depending on the Baud Rate Prescaler.</p> | DBR | CPHA | PBR | SCK Duty Cycle | 0 | any | any | 50/50 | 1 | 0 | 00 | 50/50 | 1 | 0 | 01 | 33/66 | 1 | 0 | 10 | 40/60 | 1 | 0 | 11 | 43/57 | 1 | 1 | 00 | 50/50 | 1 | 1 | 01 | 66/33 | 1 | 1 | 10 | 60/40 | 1 | 1 | 11 | 57/43 |
| DBR | CPHA | PBR | SCK Duty Cycle | | | | | | | | | | | | | | | | | | | | | | | | | | | | | | | | | | | | | | |
| 0 | any | any | 50/50 | | | | | | | | | | | | | | | | | | | | | | | | | | | | | | | | | | | | | | |
| 1 | 0 | 00 | 50/50 | | | | | | | | | | | | | | | | | | | | | | | | | | | | | | | | | | | | | | |
| 1 | 0 | 01 | 33/66 | | | | | | | | | | | | | | | | | | | | | | | | | | | | | | | | | | | | | | |
| 1 | 0 | 10 | 40/60 | | | | | | | | | | | | | | | | | | | | | | | | | | | | | | | | | | | | | | |
| 1 | 0 | 11 | 43/57 | | | | | | | | | | | | | | | | | | | | | | | | | | | | | | | | | | | | | | |
| 1 | 1 | 00 | 50/50 | | | | | | | | | | | | | | | | | | | | | | | | | | | | | | | | | | | | | | |
| 1 | 1 | 01 | 66/33 | | | | | | | | | | | | | | | | | | | | | | | | | | | | | | | | | | | | | | |
| 1 | 1 | 10 | 60/40 | | | | | | | | | | | | | | | | | | | | | | | | | | | | | | | | | | | | | | |
| 1 | 1 | 11 | 57/43 | | | | | | | | | | | | | | | | | | | | | | | | | | | | | | | | | | | | | | |
| 30–27 FMSZ | <p>Frame Size</p> <p>The number of bits transferred per frame is equal to the FMSZ value plus 1. Regardless of the transmission mode, the minimum valid frame size value is 4.</p> | | | | | | | | | | | | | | | | | | | | | | | | | | | | | | | | | | | | | | | | |
| 26 CPOL | <p>Clock Polarity</p> <p>Selects the inactive state of the Serial Communications Clock (SCK). This bit is used in both master and slave mode. For successful communication between serial devices, the devices must have identical clock polarities. When the Continuous Selection Format is selected, switching between clock polarities without stopping the module can cause errors in the transfer due to the peripheral device interpreting the switch of clock polarity as a valid clock edge.</p> <p>NOTE: In case of Continuous SCK mode, when the module goes in low power mode(disabled), inactive state of SCK is not guaranteed.</p> <p>0 The inactive state value of SCK is low. 1 The inactive state value of SCK is high.</p> | | | | | | | | | | | | | | | | | | | | | | | | | | | | | | | | | | | | | | | | |
| 25 CPHA | <p>Clock Phase</p> <p>Selects which edge of SCK causes data to change and which edge causes data to be captured. This bit is used in both master and slave mode. For successful communication between serial devices, the devices must have identical clock phase settings. In Continuous SCK mode, the bit value is ignored and the transfers are done as if the CPHA bit is set to 1.</p> <p>0 Data is captured on the leading edge of SCK and changed on the following edge. 1 Data is changed on the leading edge of SCK and captured on the following edge.</p> | | | | | | | | | | | | | | | | | | | | | | | | | | | | | | | | | | | | | | | | |
| 24 LSBFE | <p>LSB First</p> <p>Specifies whether the LSB or MSB of the frame is transferred first.</p> | | | | | | | | | | | | | | | | | | | | | | | | | | | | | | | | | | | | | | | | |

Table continues on the next page...

SPIx_CTARn field descriptions (continued)

| Field | Description |
|-----------------|--|
| | 0 Data is transferred MSB first. 1 Data is transferred LSB first. |
| 23–22 PCSSCK | PCS to SCK Delay Prescaler Selects the prescaler value for the delay between assertion of PCS and the first edge of the SCK. See the CSSCK field description for information on how to compute the PCS to SCK Delay. Refer PCS to SCK Delay (t_{CSC}) for more details. 00 PCS to SCK Prescaler value is 1. 01 PCS to SCK Prescaler value is 3. 10 PCS to SCK Prescaler value is 5. 11 PCS to SCK Prescaler value is 7. |
| 21–20 PASC | After SCK Delay Prescaler Selects the prescaler value for the delay between the last edge of SCK and the negation of PCS. See the ASC field description for information on how to compute the After SCK Delay. Refer After SCK Delay (t_{ASC}) for more details. 00 Delay after Transfer Prescaler value is 1. 01 Delay after Transfer Prescaler value is 3. 10 Delay after Transfer Prescaler value is 5. 11 Delay after Transfer Prescaler value is 7. |
| 19–18 PDT | Delay after Transfer Prescaler Selects the prescaler value for the delay between the negation of the PCS signal at the end of a frame and the assertion of PCS at the beginning of the next frame. The PDT field is only used in master mode. See the DT field description for details on how to compute the Delay after Transfer. Refer Delay after Transfer (t_{DT}) for more details. 00 Delay after Transfer Prescaler value is 1. 01 Delay after Transfer Prescaler value is 3. 10 Delay after Transfer Prescaler value is 5. 11 Delay after Transfer Prescaler value is 7. |
| 17–16 PBR | Baud Rate Prescaler Selects the prescaler value for the baud rate. This field is used only in master mode. The baud rate is the frequency of the SCK. The protocol clock is divided by the prescaler value before the baud rate selection takes place. See the BR field description for details on how to compute the baud rate. 00 Baud Rate Prescaler value is 2. 01 Baud Rate Prescaler value is 3. 10 Baud Rate Prescaler value is 5. 11 Baud Rate Prescaler value is 7. |
| 15–12 CSSCK | PCS to SCK Delay Scaler Selects the scaler value for the PCS to SCK delay. This field is used only in master mode. The PCS to SCK Delay is the delay between the assertion of PCS and the first edge of the SCK. The delay is a multiple of the protocol clock period, and it is computed according to the following equation: $t_{CSC} = (1/f_P) \times PCSSCK \times CSSCK$ The following table lists the delay scaler values. |

Table continues on the next page...

SPIx_CTARn field descriptions (continued)

| Field | Description | | | | | | | | | | | | | | | | | | | | | | | | | | | | | | | | | | |
|-------------|--|-------------|--------------------|------|---|------|---|------|---|------|----|------|----|------|----|------|-----|------|-----|------|-----|------|------|------|------|------|------|------|------|------|-------|------|-------|------|-------|
| | Table 37-3. Delay Scaler Encoding | | | | | | | | | | | | | | | | | | | | | | | | | | | | | | | | | | |
| | <table border="1"> <thead> <tr> <th>Field Value</th> <th>Delay Scaler Value</th> </tr> </thead> <tbody> <tr><td>0000</td><td>2</td></tr> <tr><td>0001</td><td>4</td></tr> <tr><td>0010</td><td>8</td></tr> <tr><td>0011</td><td>16</td></tr> <tr><td>0100</td><td>32</td></tr> <tr><td>0101</td><td>64</td></tr> <tr><td>0110</td><td>128</td></tr> <tr><td>0111</td><td>256</td></tr> <tr><td>1000</td><td>512</td></tr> <tr><td>1001</td><td>1024</td></tr> <tr><td>1010</td><td>2048</td></tr> <tr><td>1011</td><td>4096</td></tr> <tr><td>1100</td><td>8192</td></tr> <tr><td>1101</td><td>16384</td></tr> <tr><td>1110</td><td>32768</td></tr> <tr><td>1111</td><td>65536</td></tr> </tbody> </table> | Field Value | Delay Scaler Value | 0000 | 2 | 0001 | 4 | 0010 | 8 | 0011 | 16 | 0100 | 32 | 0101 | 64 | 0110 | 128 | 0111 | 256 | 1000 | 512 | 1001 | 1024 | 1010 | 2048 | 1011 | 4096 | 1100 | 8192 | 1101 | 16384 | 1110 | 32768 | 1111 | 65536 |
| Field Value | Delay Scaler Value | | | | | | | | | | | | | | | | | | | | | | | | | | | | | | | | | | |
| 0000 | 2 | | | | | | | | | | | | | | | | | | | | | | | | | | | | | | | | | | |
| 0001 | 4 | | | | | | | | | | | | | | | | | | | | | | | | | | | | | | | | | | |
| 0010 | 8 | | | | | | | | | | | | | | | | | | | | | | | | | | | | | | | | | | |
| 0011 | 16 | | | | | | | | | | | | | | | | | | | | | | | | | | | | | | | | | | |
| 0100 | 32 | | | | | | | | | | | | | | | | | | | | | | | | | | | | | | | | | | |
| 0101 | 64 | | | | | | | | | | | | | | | | | | | | | | | | | | | | | | | | | | |
| 0110 | 128 | | | | | | | | | | | | | | | | | | | | | | | | | | | | | | | | | | |
| 0111 | 256 | | | | | | | | | | | | | | | | | | | | | | | | | | | | | | | | | | |
| 1000 | 512 | | | | | | | | | | | | | | | | | | | | | | | | | | | | | | | | | | |
| 1001 | 1024 | | | | | | | | | | | | | | | | | | | | | | | | | | | | | | | | | | |
| 1010 | 2048 | | | | | | | | | | | | | | | | | | | | | | | | | | | | | | | | | | |
| 1011 | 4096 | | | | | | | | | | | | | | | | | | | | | | | | | | | | | | | | | | |
| 1100 | 8192 | | | | | | | | | | | | | | | | | | | | | | | | | | | | | | | | | | |
| 1101 | 16384 | | | | | | | | | | | | | | | | | | | | | | | | | | | | | | | | | | |
| 1110 | 32768 | | | | | | | | | | | | | | | | | | | | | | | | | | | | | | | | | | |
| 1111 | 65536 | | | | | | | | | | | | | | | | | | | | | | | | | | | | | | | | | | |
| | Refer PCS to SCK Delay (t_{CSC}) for more details. | | | | | | | | | | | | | | | | | | | | | | | | | | | | | | | | | | |
| 11–8 ASC | <p>After SCK Delay Scaler</p> <p>Selects the scaler value for the After SCK Delay. This field is used only in master mode. The After SCK Delay is the delay between the last edge of SCK and the negation of PCS. The delay is a multiple of the protocol clock period, and it is computed according to the following equation:</p> $t_{ASC} = (1/f_P) \times PASC \times ASC$ <p>See Delay Scaler Encoding table in CTARn[CSSCK] bit field description for scaler values. Refer After SCK Delay (t_{ASC}) for more details.</p> | | | | | | | | | | | | | | | | | | | | | | | | | | | | | | | | | | |
| 7–4 DT | <p>Delay After Transfer Scaler</p> <p>Selects the Delay after Transfer Scaler. This field is used only in master mode. The Delay after Transfer is the time between the negation of the PCS signal at the end of a frame and the assertion of PCS at the beginning of the next frame.</p> <p>In the Continuous Serial Communications Clock operation, the DT value is fixed to one SCK clock period, The Delay after Transfer is a multiple of the protocol clock period, and it is computed according to the following equation:</p> $t_{DT} = (1/f_P) \times PDT \times DT$ <p>See Delay Scaler Encoding table in CTARn[CSSCK] bit field description for scaler values.</p> | | | | | | | | | | | | | | | | | | | | | | | | | | | | | | | | | | |
| BR | <p>Baud Rate Scaler</p> <p>Selects the scaler value for the baud rate. This field is used only in master mode. The prescaled protocol clock is divided by the Baud Rate Scaler to generate the frequency of the SCK. The baud rate is computed according to the following equation:</p> | | | | | | | | | | | | | | | | | | | | | | | | | | | | | | | | | | |

Table continues on the next page...

SPIx_CTARn field descriptions (continued)

| Field | Description | | | | | | | | | | | | | | | | | | | | | | | | | | | | | | | | | | |
|-----------|--|-----------|------------------------|------|---|------|---|------|---|------|---|------|----|------|----|------|----|------|-----|------|-----|------|-----|------|------|------|------|------|------|------|------|------|-------|------|-------|
| | <p>SCK baud rate = $(f_P / PBR) \times [(1+DBR)/BR]$</p> <p>The following table lists the baud rate scaler values.</p> <p style="text-align: center;">Table 37-4. Baud Rate Scaler</p> <table border="1" data-bbox="347 379 1468 1083"> <thead> <tr> <th data-bbox="347 379 911 420">CTARn[BR]</th> <th data-bbox="911 379 1468 420">Baud Rate Scaler Value</th> </tr> </thead> <tbody> <tr><td data-bbox="347 420 911 462">0000</td><td data-bbox="911 420 1468 462">2</td></tr> <tr><td data-bbox="347 462 911 503">0001</td><td data-bbox="911 462 1468 503">4</td></tr> <tr><td data-bbox="347 503 911 544">0010</td><td data-bbox="911 503 1468 544">6</td></tr> <tr><td data-bbox="347 544 911 586">0011</td><td data-bbox="911 544 1468 586">8</td></tr> <tr><td data-bbox="347 586 911 627">0100</td><td data-bbox="911 586 1468 627">16</td></tr> <tr><td data-bbox="347 627 911 669">0101</td><td data-bbox="911 627 1468 669">32</td></tr> <tr><td data-bbox="347 669 911 710">0110</td><td data-bbox="911 669 1468 710">64</td></tr> <tr><td data-bbox="347 710 911 752">0111</td><td data-bbox="911 710 1468 752">128</td></tr> <tr><td data-bbox="347 752 911 793">1000</td><td data-bbox="911 752 1468 793">256</td></tr> <tr><td data-bbox="347 793 911 835">1001</td><td data-bbox="911 793 1468 835">512</td></tr> <tr><td data-bbox="347 835 911 876">1010</td><td data-bbox="911 835 1468 876">1024</td></tr> <tr><td data-bbox="347 876 911 917">1011</td><td data-bbox="911 876 1468 917">2048</td></tr> <tr><td data-bbox="347 917 911 959">1100</td><td data-bbox="911 917 1468 959">4096</td></tr> <tr><td data-bbox="347 959 911 1000">1101</td><td data-bbox="911 959 1468 1000">8192</td></tr> <tr><td data-bbox="347 1000 911 1042">1110</td><td data-bbox="911 1000 1468 1042">16384</td></tr> <tr><td data-bbox="347 1042 911 1083">1111</td><td data-bbox="911 1042 1468 1083">32768</td></tr> </tbody> </table> | CTARn[BR] | Baud Rate Scaler Value | 0000 | 2 | 0001 | 4 | 0010 | 6 | 0011 | 8 | 0100 | 16 | 0101 | 32 | 0110 | 64 | 0111 | 128 | 1000 | 256 | 1001 | 512 | 1010 | 1024 | 1011 | 2048 | 1100 | 4096 | 1101 | 8192 | 1110 | 16384 | 1111 | 32768 |
| CTARn[BR] | Baud Rate Scaler Value | | | | | | | | | | | | | | | | | | | | | | | | | | | | | | | | | | |
| 0000 | 2 | | | | | | | | | | | | | | | | | | | | | | | | | | | | | | | | | | |
| 0001 | 4 | | | | | | | | | | | | | | | | | | | | | | | | | | | | | | | | | | |
| 0010 | 6 | | | | | | | | | | | | | | | | | | | | | | | | | | | | | | | | | | |
| 0011 | 8 | | | | | | | | | | | | | | | | | | | | | | | | | | | | | | | | | | |
| 0100 | 16 | | | | | | | | | | | | | | | | | | | | | | | | | | | | | | | | | | |
| 0101 | 32 | | | | | | | | | | | | | | | | | | | | | | | | | | | | | | | | | | |
| 0110 | 64 | | | | | | | | | | | | | | | | | | | | | | | | | | | | | | | | | | |
| 0111 | 128 | | | | | | | | | | | | | | | | | | | | | | | | | | | | | | | | | | |
| 1000 | 256 | | | | | | | | | | | | | | | | | | | | | | | | | | | | | | | | | | |
| 1001 | 512 | | | | | | | | | | | | | | | | | | | | | | | | | | | | | | | | | | |
| 1010 | 1024 | | | | | | | | | | | | | | | | | | | | | | | | | | | | | | | | | | |
| 1011 | 2048 | | | | | | | | | | | | | | | | | | | | | | | | | | | | | | | | | | |
| 1100 | 4096 | | | | | | | | | | | | | | | | | | | | | | | | | | | | | | | | | | |
| 1101 | 8192 | | | | | | | | | | | | | | | | | | | | | | | | | | | | | | | | | | |
| 1110 | 16384 | | | | | | | | | | | | | | | | | | | | | | | | | | | | | | | | | | |
| 1111 | 32768 | | | | | | | | | | | | | | | | | | | | | | | | | | | | | | | | | | |

37.3.4 Clock and Transfer Attributes Register (In Slave Mode) (SPIx_CTARn_SLAVE)

When the module is configured as an SPI bus slave, the CTAR0 register is used.

Address: Base address + Ch offset + (0d × i), where i=0d to 0d

| | | | | | | | | | | | | | | | | |
|-------|----------|------|----|----|----|------|------|----|----|----------|----------|----|----|----|----|----|
| Bit | 31 | 30 | 29 | 28 | 27 | 26 | 25 | 24 | 23 | 22 | 21 | 20 | 19 | 18 | 17 | 16 |
| R | Reserved | FMSZ | | | | CPOL | CPHA | 0 | | Reserved | Reserved | | | | | |
| W | | | | | | | | | | | | | | | | |
| Reset | 0 | 1 | 1 | 1 | 1 | 0 | 0 | 0 | 0 | 0 | 0 | 0 | 0 | 0 | 0 | 0 |
| Bit | 15 | 14 | 13 | 12 | 11 | 10 | 9 | 8 | 7 | 6 | 5 | 4 | 3 | 2 | 1 | 0 |
| R | Reserved | | | | | | | | | | | | | | | |
| W | | | | | | | | | | | | | | | | |
| Reset | 0 | 0 | 0 | 0 | 0 | 0 | 0 | 0 | 0 | 0 | 0 | 0 | 0 | 0 | 0 | 0 |

SPIx_CTARn_SLAVE field descriptions

| Field | Description |
|----------------|--|
| 31 Reserved | Always write the reset value to this field. This field is reserved. |
| 30–27 FMSZ | Frame Size The number of bits transferred per frame is equal to the FMSZ field value plus 1. Note that the minimum valid value of frame size is 4. |
| 26 CPOL | Clock Polarity Selects the inactive state of the Serial Communications Clock (SCK). NOTE: In case of Continuous SCK mode, when the module goes in low power mode(disabled), inactive state of SCK is not guaranteed. 0 The inactive state value of SCK is low. 1 The inactive state value of SCK is high. |
| 25 CPHA | Clock Phase Selects which edge of SCK causes data to change and which edge causes data to be captured. This bit is used in both master and slave mode. For successful communication between serial devices, the devices must have identical clock phase settings. In Continuous SCK mode, the bit value is ignored and the transfers are done as if the CPHA bit is set to 1. 0 Data is captured on the leading edge of SCK and changed on the following edge. 1 Data is changed on the leading edge of SCK and captured on the following edge. |

Table continues on the next page...

SPIx_CTARn_SLAVE field descriptions (continued)

| Field | Description |
|-------------------|---|
| 24–23 Reserved | This field is reserved. This read-only field is reserved and always has the value 0. |
| 22 Reserved | This field is reserved. |
| Reserved | This field is reserved. |

37.3.5 Status Register (SPIx_SR)

SR contains status and flag bits. The bits reflect the status of the module and indicate the occurrence of events that can generate interrupt or DMA requests. Software can clear flag bits in the SR by writing a 1 to them. Writing a 0 to a flag bit has no effect. This register may not be writable in Module Disable mode due to the use of power saving mechanisms.

Address: Base address + 2Ch offset

| | | | | | | | | | | | | | | | | |
|-------|-------|-------|----|------|---------|----|------|----|-------|----|----|----|----------|----|------|----|
| Bit | 31 | 30 | 29 | 28 | 27 | 26 | 25 | 24 | 23 | 22 | 21 | 20 | 19 | 18 | 17 | 16 |
| R | TCF | TXRXS | 0 | EOQF | TFUF | 0 | TFFF | 0 | 0 | 0 | 0 | 0 | RFOF | 0 | RFDF | 0 |
| W | w1c | | | w1c | w1c | | w1c | | | | | | w1c | | w1c | |
| Reset | 0 | 0 | 0 | 0 | 0 | 0 | 1 | 0 | 0 | 0 | 0 | 0 | 0 | 0 | 0 | 0 |
| Bit | 15 | 14 | 13 | 12 | 11 | 10 | 9 | 8 | 7 | 6 | 5 | 4 | 3 | 2 | 1 | 0 |
| R | TXCTR | | | | TXNXPTR | | | | RXCTR | | | | POPNXPTR | | | |
| W | | | | | | | | | | | | | | | | |
| Reset | 0 | 0 | 0 | 0 | 0 | 0 | 0 | 0 | 0 | 0 | 0 | 0 | 0 | 0 | 0 | 0 |

SPIx_SR field descriptions

| Field | Description |
|----------------|---|
| 31 TCF | <p>Transfer Complete Flag</p> <p>Indicates that all bits in a frame have been shifted out. TCF remains set until it is cleared by writing a 1 to it.</p> <p>0 Transfer not complete. 1 Transfer complete.</p> |
| 30 TXRXS | <p>TX and RX Status</p> <p>Reflects the run status of the module.</p> <p>0 Transmit and receive operations are disabled (The module is in Stopped state). 1 Transmit and receive operations are enabled (The module is in Running state).</p> |
| 29 Reserved | <p>This field is reserved. This read-only field is reserved and always has the value 0.</p> |
| 28 EOQF | <p>End of Queue Flag</p> <p>Indicates that the last entry in a queue has been transmitted when the module is in Master mode. The EOQF bit is set when the TX FIFO entry has the EOQ bit set in the command halfword and the end of the transfer is reached. The EOQF bit remains set until cleared by writing a 1 to it. When the EOQF bit is set, the TXRXS bit is automatically cleared.</p> <p>0 EOQ is not set in the executing command. 1 EOQ is set in the executing SPI command.</p> |
| 27 TFUF | <p>Transmit FIFO Underflow Flag</p> <p>Indicates an underflow condition in the TX FIFO. The transmit underflow condition is detected only for SPI blocks operating in Slave mode and SPI configuration. TFUF is set when the TX FIFO of the module operating in SPI Slave mode is empty and an external SPI master initiates a transfer. The TFUF bit remains set until cleared by writing 1 to it.</p> <p>0 No TX FIFO underflow. 1 TX FIFO underflow has occurred.</p> |
| 26 Reserved | <p>This field is reserved. This read-only field is reserved and always has the value 0.</p> |
| 25 TFFF | <p>Transmit FIFO Fill Flag</p> <p>Indicates whether there is an available location to be filled in the FIFO. Either a DMA request or an interrupt indication can be used to add another entry to the FIFO. Note that this bit is set if at least one location is free in the FIFO. The TFFF bit can be cleared by writing 1 to it or by acknowledgement from the DMA controller to the TX FIFO full request, when the TX FIFO is full.</p> <p>NOTE: The reset value of this bit is 0 when the module is disabled,(MCR[MDIS]=1).</p> <p>0 TX FIFO is full. 1 TX FIFO is not full.</p> |
| 24 Reserved | <p>This field is reserved. This read-only field is reserved and always has the value 0.</p> |
| 23 Reserved | <p>This field is reserved. This read-only field is reserved and always has the value 0.</p> |
| 22 Reserved | <p>This field is reserved. This read-only field is reserved and always has the value 0.</p> |

Table continues on the next page...

SPIx_SR field descriptions (continued)

| Field | Description |
|------------------|---|
| 21 Reserved | This field is reserved. This read-only field is reserved and always has the value 0. |
| 20 Reserved | This field is reserved. This read-only field is reserved and always has the value 0. |
| 19 RFOF | Receive FIFO Overflow Flag Indicates an overflow condition in the RX FIFO. The field is set when the RX FIFO and shift register are full and a transfer is initiated. The bit remains set until it is cleared by writing a 1 to it. 0 No Rx FIFO overflow. 1 Rx FIFO overflow has occurred. |
| 18 Reserved | This field is reserved. This read-only field is reserved and always has the value 0. |
| 17 RFDF | Receive FIFO Drain Flag Indicates whether there is an available location to be drained from the FIFO. Either a DMA request or an interrupt indication can be used to read from the FIFO. Note that this bit is set if at least one location can be read from the FIFO. The RFDF bit can be cleared by writing 1 to it or by acknowledgement from the DMA controller when the RX FIFO is empty. 0 RX FIFO is empty. 1 RX FIFO is not empty. |
| 16 Reserved | This field is reserved. This read-only field is reserved and always has the value 0. |
| 15–12 TXCTR | TX FIFO Counter Indicates the number of valid entries in the TX FIFO. The TXCTR is incremented every time the PUSHHR is written. The TXCTR is decremented every time an SPI command is executed and the SPI data is transferred to the shift register. |
| 11–8 TXNXTPTR | Transmit Next Pointer Indicates which TX FIFO entry is transmitted during the next transfer. The TXNXTPTR field is updated every time SPI data is transferred from the TX FIFO to the shift register. NOTE: When TX FIFO is cleared by setting SPI_MCR[CLR_TXF] to 1, this field does not update immediately to 0. Only when the next transfer starts, this field reflects the latest value TXNXTPTR = 1. |
| 7–4 RXCTR | RX FIFO Counter Indicates the number of entries in the RX FIFO. The RXCTR is decremented every time the POPR is read. The RXCTR is incremented every time data is transferred from the shift register to the RX FIFO. |
| POPNTPTR | Pop Next Pointer Contains a pointer to the RX FIFO entry to be returned when the POPR is read. The POPNTPTR is updated when the POPR is read. |

37.3.6 DMA/Interrupt Request Select and Enable Register (SPIx_RSER)

RSER controls DMA and interrupt requests. Do not write to the RSER while the module is in the Running state.

Address: Base address + 30h offset

| | | | | | | | | | | | | | | | | |
|-------|----------|----------|----------|---------|---------|----------|---------|-----------|----------|----------|----------|----------|---------|----------|---------|-----------|
| Bit | 31 | 30 | 29 | 28 | 27 | 26 | 25 | 24 | 23 | 22 | 21 | 20 | 19 | 18 | 17 | 16 |
| R | TCF_RE | Reserved | Reserved | EOQF_RE | TFUF_RE | Reserved | TFFF_RE | TFFF_DIRS | Reserved | Reserved | Reserved | Reserved | RFOF_RE | Reserved | RFDF_RE | RFDF_DIRS |
| W | | | | | | | | | | | | | | | | |
| Reset | 0 | 0 | 0 | 0 | 0 | 0 | 0 | 0 | 0 | 0 | 0 | 0 | 0 | 0 | 0 | 0 |
| Bit | 15 | 14 | 13 | 12 | 11 | 10 | 9 | 8 | 7 | 6 | 5 | 4 | 3 | 2 | 1 | 0 |
| R | Reserved | Reserved | 0 | | | | | | | | | | | | | |
| W | | | | | | | | | | | | | | | | |
| Reset | 0 | 0 | 0 | 0 | 0 | 0 | 0 | 0 | 0 | 0 | 0 | 0 | 0 | 0 | 0 | 0 |

SPIx_RSER field descriptions

| Field | Description |
|----------------|---|
| 31 TCF_RE | Transmission Complete Request Enable Enables TCF flag in the SR to generate an interrupt request. 0 TCF interrupt requests are disabled. 1 TCF interrupt requests are enabled. |
| 30 Reserved | Always write the reset value to this field. This field is reserved. |
| 29 Reserved | Always write the reset value to this field. This field is reserved. |
| 28 EOQF_RE | Finished Request Enable Enables the EOQF flag in the SR to generate an interrupt request. 0 EOQF interrupt requests are disabled. 1 EOQF interrupt requests are enabled. |
| 27 TFUF_RE | Transmit FIFO Underflow Request Enable Enables the TFUF flag in the SR to generate an interrupt request. |

Table continues on the next page...

SPIx_RSER field descriptions (continued)

| Field | Description |
|-----------------|---|
| | 0 TFUF interrupt requests are disabled. 1 TFUF interrupt requests are enabled. |
| 26 Reserved | Always write the reset value to this field. This field is reserved. |
| 25 TFFF_RE | Transmit FIFO Fill Request Enable Enables the TFFF flag in the SR to generate a request. The TFFF_DIRS bit selects between generating an interrupt request or a DMA request. 0 TFFF interrupts or DMA requests are disabled. 1 TFFF interrupts or DMA requests are enabled. |
| 24 TFFF_DIRS | Transmit FIFO Fill DMA or Interrupt Request Select Selects between generating a DMA request or an interrupt request. When SR[TFFF] and RSER[TFFF_RE] are set, this field selects between generating an interrupt request or a DMA request. 0 TFFF flag generates interrupt requests. 1 TFFF flag generates DMA requests. |
| 23 Reserved | Always write the reset value to this field. This field is reserved. |
| 22 Reserved | Always write the reset value to this field. This field is reserved. |
| 21 Reserved | Always write the reset value to this field. This field is reserved. |
| 20 Reserved | Always write the reset value to this field. This field is reserved. |
| 19 RFOF_RE | Receive FIFO Overflow Request Enable Enables the RFOF flag in the SR to generate an interrupt request. 0 RFOF interrupt requests are disabled. 1 RFOF interrupt requests are enabled. |
| 18 Reserved | Always write the reset value to this field. This field is reserved. |
| 17 RFDF_RE | Receive FIFO Drain Request Enable Enables the RFDF flag in the SR to generate a request. The RFDF_DIRS bit selects between generating an interrupt request or a DMA request. 0 RFDF interrupt or DMA requests are disabled. 1 RFDF interrupt or DMA requests are enabled. |
| 16 RFDF_DIRS | Receive FIFO Drain DMA or Interrupt Request Select |

Table continues on the next page...

SPIx_RSER field descriptions (continued)

| Field | Description |
|----------------|--|
| | Selects between generating a DMA request or an interrupt request. When the RFDF flag bit in the SR is set, and the RFDF_RE bit in the RSER is set, the RFDF_DIRS bit selects between generating an interrupt request or a DMA request. 0 Interrupt request. 1 DMA request. |
| 15 Reserved | Always write the reset value to this field. This field is reserved. |
| 14 Reserved | Always write the reset value to this field. This field is reserved. |
| Reserved | This field is reserved. This read-only field is reserved and always has the value 0. |

37.3.7 PUSH TX FIFO Register In Master Mode (SPIx_PUSHR)

Specifies data to be transferred to the TX FIFO. An 8- or 16-bit write access transfers all 32 bits to the TX FIFO. In Master mode, the register transfers 16 bits of data and 16 bits of command information. A read access of PUSHR returns the topmost TX FIFO entry.

When the module is disabled, writing to this register does not update the FIFO. Therefore, any reads performed while the module is disabled return the last PUSHR write performed while the module was still enabled.

Address: Base address + 34h offset

| | | | | | | | | | | | | | | | | | |
|-------|--------|------|----|----|----|-----|-------|----------|----|----------|----|----|----|-----|----|----|--|
| Bit | 31 | 30 | 29 | 28 | 27 | 26 | 25 | 24 | 23 | 22 | 21 | 20 | 19 | 18 | 17 | 16 | |
| R | | | | | | | | | | | | | | | | | |
| W | CONT | CTAS | | | | EOQ | CTCNT | Reserved | | Reserved | | | | PCS | | | |
| Reset | 0 | 0 | 0 | 0 | 0 | 0 | 0 | 0 | 0 | 0 | 0 | 0 | 0 | 0 | 0 | 0 | |
| Bit | 15 | 14 | 13 | 12 | 11 | 10 | 9 | 8 | 7 | 6 | 5 | 4 | 3 | 2 | 1 | 0 | |
| R | | | | | | | | | | | | | | | | | |
| W | TXDATA | | | | | | | | | | | | | | | | |
| Reset | 0 | 0 | 0 | 0 | 0 | 0 | 0 | 0 | 0 | 0 | 0 | 0 | 0 | 0 | 0 | 0 | |

SPIx_PUSHR field descriptions

| Field | Description |
|-------------------|---|
| 31 CONT | <p>Continuous Peripheral Chip Select Enable</p> <p>Selects a continuous selection format. The bit is used in SPI Master mode. The bit enables the selected PCS signals to remain asserted between transfers.</p> <p>0 Return PCSn signals to their inactive state between transfers. 1 Keep PCSn signals asserted between transfers.</p> |
| 30–28 CTAS | <p>Clock and Transfer Attributes Select</p> <p>Selects which CTAR to use in master mode to specify the transfer attributes for the associated SPI frame. In SPI Slave mode, CTAR0 is used. See the chip specific section for details to determine how many CTARs this device has. You should not program a value in this field for a register that is not present.</p> <p>000 CTAR0 001 CTAR1 010 Reserved 011 Reserved 100 Reserved 101 Reserved 110 Reserved 111 Reserved</p> |
| 27 EOQ | <p>End Of Queue</p> <p>Host software uses this bit to signal to the module that the current SPI transfer is the last in a queue. At the end of the transfer, the EOQF bit in the SR is set.</p> <p>0 The SPI data is not the last data to transfer. 1 The SPI data is the last data to transfer.</p> |
| 26 CTCNT | <p>Clear Transfer Counter</p> <p>Clears the TCNT field in the TCR register. The TCNT field is cleared before the module starts transmitting the current SPI frame.</p> <p>0 Do not clear the TCR[TCNT] field. 1 Clear the TCR[TCNT] field.</p> |
| 25–24 Reserved | <p>Always write the reset value to this field.</p> <p>This field is reserved.</p> |
| 23–20 Reserved | <p>Always write the reset value to this field.</p> <p>This field is reserved.</p> |
| 19–16 PCS | <p>Select which PCS signals are to be asserted for the transfer. Refer to the chip-specific SPI information for the number of PCS signals used in this chip.</p> <p>0 Negate the PCS[x] signal 1 Assert the PCS[x] signal.</p> |
| TXDATA | <p>Transmit Data</p> <p>Holds SPI data to be transferred according to the associated SPI command.</p> |

37.3.8 PUSH TX FIFO Register In Slave Mode (SPIx_PUSHR_SLAVE)

Specifies data to be transferred to the TX FIFO in slave mode. An 8- or 16-bit write access to PUSHR transfers the 16-bit TXDATA field to the TX FIFO.

Address: Base address + 34h offset

| | | | | | | | | | | | | | | | | | | | | | | | | | | | | | | | | |
|-------|----------|----|----|----|----|----|----|----|----|----|----|----|----|----|----|----|--------|----|----|----|----|----|---|---|---|---|---|---|---|---|---|---|
| Bit | 31 | 30 | 29 | 28 | 27 | 26 | 25 | 24 | 23 | 22 | 21 | 20 | 19 | 18 | 17 | 16 | 15 | 14 | 13 | 12 | 11 | 10 | 9 | 8 | 7 | 6 | 5 | 4 | 3 | 2 | 1 | 0 |
| R | Reserved | | | | | | | | | | | | | | | | TXDATA | | | | | | | | | | | | | | | |
| W | | | | | | | | | | | | | | | | | | | | | | | | | | | | | | | | |
| Reset | 0 | 0 | 0 | 0 | 0 | 0 | 0 | 0 | 0 | 0 | 0 | 0 | 0 | 0 | 0 | 0 | 0 | 0 | 0 | 0 | 0 | 0 | 0 | 0 | 0 | 0 | 0 | 0 | 0 | 0 | 0 | 0 |

SPIx_PUSHR_SLAVE field descriptions

| Field | Description |
|-------------------|--|
| 31–16 Reserved | This field is reserved. |
| TXDATA | Transmit Data Holds SPI data to be transferred according to the associated SPI command. |

37.3.9 POP RX FIFO Register (SPIx_POPR)

POPR is used to read the RX FIFO. Eight- or sixteen-bit read accesses to the POPR have the same effect on the RX FIFO as 32-bit read accesses. A write to this register will generate a Transfer Error.

Address: Base address + 38h offset

| | | | | | | | | | | | | | | | | | | | | | | | | | | | | | | | | |
|-------|--------|----|----|----|----|----|----|----|----|----|----|----|----|----|----|----|----|----|----|----|----|----|---|---|---|---|---|---|---|---|---|---|
| Bit | 31 | 30 | 29 | 28 | 27 | 26 | 25 | 24 | 23 | 22 | 21 | 20 | 19 | 18 | 17 | 16 | 15 | 14 | 13 | 12 | 11 | 10 | 9 | 8 | 7 | 6 | 5 | 4 | 3 | 2 | 1 | 0 |
| R | RXDATA | | | | | | | | | | | | | | | | | | | | | | | | | | | | | | | |
| W | | | | | | | | | | | | | | | | | | | | | | | | | | | | | | | | |
| Reset | 0 | 0 | 0 | 0 | 0 | 0 | 0 | 0 | 0 | 0 | 0 | 0 | 0 | 0 | 0 | 0 | 0 | 0 | 0 | 0 | 0 | 0 | 0 | 0 | 0 | 0 | 0 | 0 | 0 | 0 | 0 | 0 |

SPIx_POPR field descriptions

| Field | Description |
|--------|--|
| RXDATA | Received Data Contains the SPI data from the RX FIFO entry to which the Pop Next Data Pointer points. |

37.3.10 Transmit FIFO Registers (SPIx_TXFRn)

TXFRn registers provide visibility into the TX FIFO for debugging purposes. Each register is an entry in the TX FIFO. The registers are read-only and cannot be modified. Reading the TXFRx registers does not alter the state of the TX FIFO.

Address: Base address + 3Ch offset + (4d × i), where i=0d to 3d

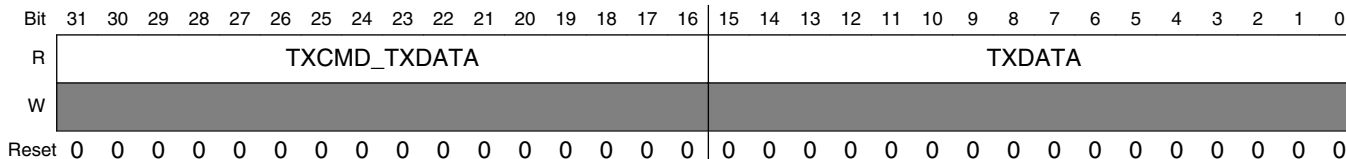

SPIx_TXFRn field descriptions

| Field | Description |
|---------------------------|---|
| 31–16 TXCMD_ TXDATA | Transmit Command or Transmit Data In Master mode the TXCMD field contains the command that sets the transfer attributes for the SPI data. In Slave mode, this field is reserved. |
| TXDATA | Transmit Data Contains the SPI data to be shifted out. |

37.3.11 Receive FIFO Registers (SPIx_RXFRn)

RXFRn provide visibility into the RX FIFO for debugging purposes. Each register is an entry in the RX FIFO. The RXFR registers are read-only. Reading the RXFRx registers does not alter the state of the RX FIFO. The field MCR[MDIS] must be 0 when RXFR is read.

Address: Base address + 7Ch offset + (4d × i), where i=0d to 3d

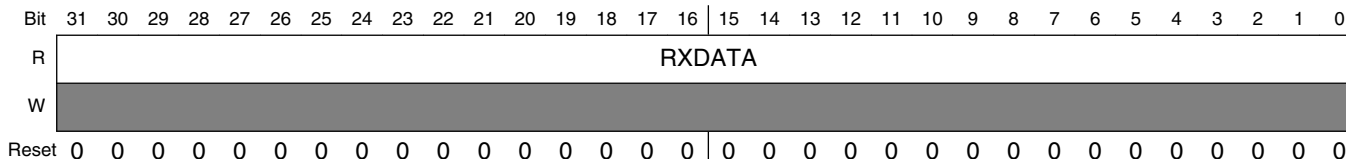

SPIx_RXFRn field descriptions

| Field | Description |
|--------|--------------|
| RXDATA | Receive Data |

SPIx_RXFRn field descriptions (continued)

| Field | Description |
|-------|---------------------------------|
| | Contains the received SPI data. |

37.4 Functional description

The module supports full-duplex, synchronous serial communications between chips and peripheral devices. The SPI configuration transfers data serially using a shift register and a selection of programmable transfer attributes.

The module has the following configuration

- The SPI Configuration in which the module operates as a basic SPI or a queued SPI.

The DCONF field in the Module Configuration Register (MCR) determines the module Configuration. SPI configuration is selected when DCONF within SPIx_MCR is 0b00.

The CTARn registers hold clock and transfer attributes. The SPI configuration allows to select which CTAR to use on a frame by frame basis by setting a field in the SPI command.

See [Clock and Transfer Attributes Register \(In Master Mode\) \(SPI_CTARn\)](#) for information on the fields of CTAR registers.

Typical master to slave connections are shown in the following figure. When a data transfer operation is performed, data is serially shifted a predetermined number of bit positions. Because the modules are linked, data is exchanged between the master and the slave. The data that was in the master shift register is now in the shift register of the slave, and vice versa. At the end of a transfer, the Transfer Control Flag(TCF) bit in the Shift Register(SR) is set to indicate a completed frame transfer.

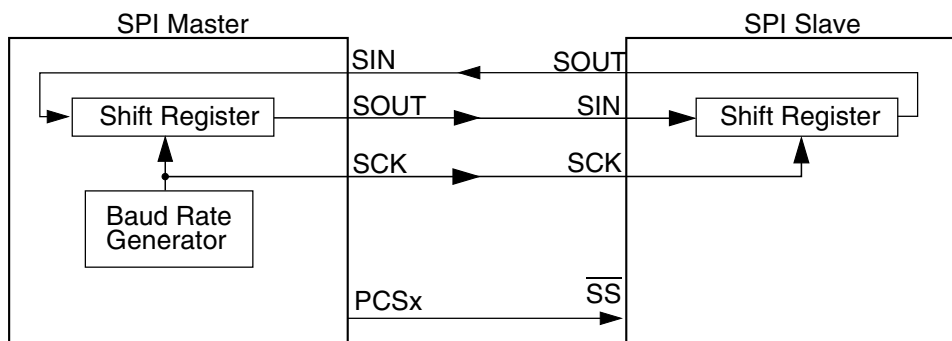

Figure 37-3. Serial protocol overview

Generally, more than one slave device can be connected to the module master. 4 Peripheral Chip Select (PCS) signals of the module masters can be used to select which of the slaves to communicate with. Refer to the chip specific section for details on the number of PCS signals used in this chip.

The SPI configuration shares transfer protocol and timing properties which are described independently of the configuration in [Transfer formats](#). The transfer rate and delay settings are described in [Module baud rate and clock delay generation](#).

37.4.1 Start and Stop of module transfers

The module has two operating states: Stopped and Running. Both the states are independent of it's configuration. The default state of the module is Stopped. In the Stopped state, no serial transfers are initiated in Master mode and no transfers are responded to in Slave mode. The Stopped state is also a safe state for writing the various configuration registers of the module without causing undetermined results. In the Running state serial transfers take place.

The TXRXS bit in the SR indicates the state of module. The bit is set if the module is in Running state.

The module starts or transitions to Running when all of the following conditions are true:

- SR[EOQF] bit is clear
- Chip is not in the Debug mode or the MCR[FRZ] bit is clear
- MCR[HALT] bit is clear

The module stops or transitions from Running to Stopped after the current frame when any one of the following conditions exist:

- SR[EOQF] bit is set
- Chip in the Debug mode and the MCR[FRZ] bit is set
- MCR[HALT] bit is set

State transitions from Running to Stopped occur on the next frame boundary if a transfer is in progress, or immediately if no transfers are in progress.

37.4.2 Serial Peripheral Interface SPI configuration

The SPI configuration transfers data serially using a shift register and a selection of programmable transfer attributes. The module is in SPI configuration when the DCONF field in the MCR is 0b00. The SPI frames can be 32 bits long. The host CPU or a DMA controller transfers the SPI data from the external to the module RAM queues to a TX FIFO buffer. The received data is stored in entries in the RX FIFO buffer. The host CPU or the DMA controller transfers the received data from the RX FIFO to memory external to the module. The operation of FIFO buffers is described in the following sections:

- [Transmit First In First Out \(TX FIFO\) buffering mechanism](#)
- [Receive First In First Out \(RX FIFO\) buffering mechanism](#)

The interrupt and DMA request conditions are described in [Interrupts/DMA requests](#).

The SPI configuration supports two block-specific modes—Master mode and Slave mode. In Master mode the module initiates and controls the transfer according to the fields of the executing SPI Command. In Slave mode, the module responds only to transfers initiated by a bus master external to it and the SPI command field space is reserved.

37.4.2.1 Master mode

In SPI Master mode, the module initiates the serial transfers by controlling the SCK and the PCS signals. The executing SPI Command determines which CTARs will be used to set the transfer attributes and which PCS signals to assert. The command field also contains various bits that help with queue management and transfer protocol. See [PUSH TX FIFO Register In Master Mode \(SPI_PUSHR\)](#) for details on the SPI command fields. The data in the executing TX FIFO entry is loaded into the shift register and shifted out on the Serial Out (SOUT) pin. In SPI Master mode, each SPI frame to be transmitted has a command associated with it, allowing for transfer attribute control on a frame by frame basis.

37.4.2.2 Slave mode

In SPI Slave mode the module responds to transfers initiated by an SPI bus master. It does not initiate transfers. Certain transfer attributes such as clock polarity, clock phase, and frame size must be set for successful communication with an SPI master. The SPI Slave mode transfer attributes are set in the CTAR0. The data is shifted out with MSB first. Shifting out of LSB is not supported in this mode.

37.4.2.3 FIFO disable operation

The FIFO disable mechanisms allow SPI transfers without using the TX FIFO or RX FIFO. The module operates as a double-buffered simplified SPI when the FIFOs are disabled. The Transmit and Receive side of the FIFOs are disabled separately. Setting the MCR[DIS_TXF] bit disables the TX FIFO, and setting the MCR[DIS_RXF] bit disables the RX FIFO.

The FIFO disable mechanisms are transparent to the user and to host software. Transmit data and commands are written to the PUSHHR and received data is read from the POPR.

When the TX FIFO is disabled:

- SR[TFFF], SR[TFUF] and SR[TXCTR] behave as if there is a one-entry FIFO
- The contents of TXFRs, SR[TXNXTPTR] are undefined

Similarly, when the RX FIFO is disabled, the RFDF, RFOF, and RXCTR fields in the SR behave as if there is a one-entry FIFO, but the contents of the RXFR registers and POPNXTPTR are undefined.

37.4.2.4 Transmit First In First Out (TX FIFO) buffering mechanism

The TX FIFO functions as a buffer of SPI data for transmission. The TX FIFO holds 4 words, each consisting of SPI data. The number of entries in the TX FIFO is device-specific. SPI data is added to the TX FIFO by writing to the Data Field of module PUSH FIFO Register (PUSHHR). TX FIFO entries can only be removed from the TX FIFO by being shifted out or by flushing the TX FIFO.

The TX FIFO Counter field (TXCTR) in the module Status Register (SR) indicates the number of valid entries in the TX FIFO. The TXCTR is updated every time a 8- or 16-bit write takes place to PUSHHR[TXDATA] or SPI data is transferred into the shift register from the TX FIFO.

The TXNXTPTR field indicates the TX FIFO Entry that will be transmitted during the next transfer. The TXNXTPTR field is incremented every time SPI data is transferred from the TX FIFO to the shift register. The maximum value of the field is equal to the maximum implemented TXFR number and it rolls over after reaching the maximum.

37.4.2.4.1 Filling the TX FIFO

Host software or other intelligent blocks can add (push) entries to the TX FIFO by writing to the PUSHHR. When the TX FIFO is not full, the TX FIFO Fill Flag (TFFF) in the SR is set. The TFFF bit is cleared when TX FIFO is full and the DMA controller

indicates that a write to PUSHHR is complete. Writing a '1' to the TFFF bit also clears it. The TFFF can generate a DMA request or an interrupt request. See [Transmit FIFO Fill Interrupt or DMA Request](#) for details.

The module ignores attempts to push data to a full TX FIFO, and the state of the TX FIFO does not change and no error condition is indicated.

37.4.2.4.2 Draining the TX FIFO

The TX FIFO entries are removed (drained) by shifting SPI data out through the shift register. Entries are transferred from the TX FIFO to the shift register and shifted out as long as there are valid entries in the TX FIFO. Every time an entry is transferred from the TX FIFO to the shift register, the TX FIFO Counter decrements by one. At the end of a transfer, the TCF bit in the SR is set to indicate the completion of a transfer. The TX FIFO is flushed by writing a '1' to the CLR_TXF bit in MCR.

If an external bus master initiates a transfer with a module slave while the slave's TX FIFO is empty, the Transmit FIFO Underflow Flag (TFUF) in the slave's SR is set. See [Transmit FIFO Underflow Interrupt Request](#) for details.

37.4.2.5 Receive First In First Out (RX FIFO) buffering mechanism

The RX FIFO functions as a buffer for data received on the SIN pin. The RX FIFO holds 4 received SPI data frames. The number of entries in the RX FIFO is device-specific. SPI data is added to the RX FIFO at the completion of a transfer when the received data in the shift register is transferred into the RX FIFO. SPI data are removed (popped) from the RX FIFO by reading the module POP RX FIFO Register (POPR). RX FIFO entries can only be removed from the RX FIFO by reading the POPR or by flushing the RX FIFO.

The RX FIFO Counter field (RXCTR) in the module's Status Register (SR) indicates the number of valid entries in the RX FIFO. The RXCTR is updated every time the POPR is read or SPI data is copied from the shift register to the RX FIFO.

The POPNXTPTR field in the SR points to the RX FIFO entry that is returned when the POPR is read. The POPNXTPTR contains the positive offset from RXFR0 in a number of 32-bit registers. For example, POPNXTPTR equal to two means that the RXFR2 contains the received SPI data that will be returned when the POPR is read. The POPNXTPTR field is incremented every time the POPR is read. The maximum value of the field is equal to the maximum implemented RXFR number and it rolls over after reaching the maximum.

37.4.2.5.1 Filling the RX FIFO

The RX FIFO is filled with the received SPI data from the shift register. While the RX FIFO is not full, SPI frames from the shift register are transferred to the RX FIFO. Every time an SPI frame is transferred to the RX FIFO, the RX FIFO Counter is incremented by one.

If the RX FIFO and shift register are full and a transfer is initiated, the RFOF bit in the SR is set indicating an overflow condition. Depending on the state of the ROOE bit in the MCR, the data from the transfer that generated the overflow is either ignored or shifted in to the shift register. If the ROOE bit is set, the incoming data is shifted in to the shift register. If the ROOE bit is cleared, the incoming data is ignored.

37.4.2.5.2 Draining the RX FIFO

Host CPU or a DMA can remove (pop) entries from the RX FIFO by reading the module POP RX FIFO Register (POPR). A read of the POPR decrements the RX FIFO Counter by one. Attempts to pop data from an empty RX FIFO are ignored and the RX FIFO Counter remains unchanged. The data, read from the empty RX FIFO, is undetermined.

When the RX FIFO is not empty, the RX FIFO Drain Flag (RFDF) in the SR is set. The RFDF bit is cleared when the RX_FIFO is empty and the DMA controller indicates that a read from POPR is complete or by writing a 1 to it.

37.4.3 Module baud rate and clock delay generation

The SCK frequency and the delay values for serial transfer are generated by dividing the system clock frequency by a prescaler and a scaler with the option for doubling the baud rate. The following figure shows conceptually how the SCK signal is generated.

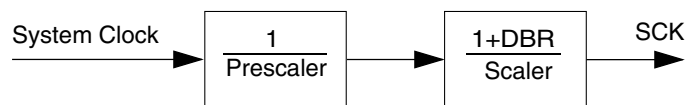

Figure 37-4. Communications clock prescalers and scalers

37.4.3.1 Baud rate generator

The baud rate is the frequency of the SCK. The protocol clock is divided by a prescaler (PBR) and scaler (BR) to produce SCK with the possibility of halving the scaler division. The DBR, PBR, and BR fields in the CTARs select the frequency of SCK by the formula in the BR field description. The following table shows an example of how to compute the baud rate.

Table 37-5. Baud rate computation example

| f_p | PBR | Prescaler | BR | Scaler | DBR | Baud rate |
|---------|------|-----------|--------|--------|-----|-----------|
| 100 MHz | 0b00 | 2 | 0b0000 | 2 | 0 | 25 Mb/s |
| 20 MHz | 0b00 | 2 | 0b0000 | 2 | 1 | 10 Mb/s |

NOTE

The clock frequencies mentioned in the preceding table are given as an example. Refer to the clocking chapter for the frequency used to drive this module in the device.

37.4.3.2 PCS to SCK Delay (t_{csc})

The PCS to SCK delay is the length of time from assertion of the PCS signal to the first SCK edge. See [Figure 37-5](#) for an illustration of the PCS to SCK delay. The PCSSCK and CSSCK fields in the CTAR_x registers select the PCS to SCK delay by the formula in the CSSCK field description. The following table shows an example of how to compute the PCS to SCK delay.

Table 37-6. PCS to SCK delay computation example

| f_{sys} | PCSSCK | Prescaler | CSSCK | Scaler | PCS to SCK Delay |
|-----------|--------|-----------|--------|--------|------------------|
| 100 MHz | 0b01 | 3 | 0b0100 | 32 | 0.96 μ s |

NOTE

The clock frequency mentioned in the preceding table is given as an example. Refer to the clocking chapter for the frequency used to drive this module in the device.

37.4.3.3 After SCK Delay (t_{ASC})

The After SCK Delay is the length of time between the last edge of SCK and the negation of PCS. See [Figure 37-5](#) and [Figure 37-6](#) for illustrations of the After SCK delay. The PASC and ASC fields in the CTAR x registers select the After SCK Delay by the formula in the ASC field description. The following table shows an example of how to compute the After SCK delay.

Table 37-7. After SCK Delay computation example

| f_p | PASC | Prescaler | ASC | Scaler | After SCK Delay |
|---------|------|-----------|--------|--------|-----------------|
| 100 MHz | 0b01 | 3 | 0b0100 | 32 | 0.96 μ s |

NOTE

The clock frequency mentioned in the preceding table is given as an example. Refer to the clocking chapter for the frequency used to drive this module in the device.

37.4.3.4 Delay after Transfer (t_{DT})

The Delay after Transfer is the minimum time between negation of the PCS signal for a frame and the assertion of the PCS signal for the next frame. See [Figure 37-5](#) for an illustration of the Delay after Transfer. The PDT and DT fields in the CTAR x registers select the Delay after Transfer by the formula in the DT field description. The following table shows an example of how to compute the Delay after Transfer.

Table 37-8. Delay after Transfer computation example

| f_p | PDT | Prescaler | DT | Scaler | Delay after Transfer |
|---------|------|-----------|--------|--------|----------------------|
| 100 MHz | 0b01 | 3 | 0b1110 | 32768 | 0.98 ms |

NOTE

The clock frequency mentioned in the preceding table is given as an example. Refer to the clocking chapter for the frequency used to drive this module in the device.

When in Non-Continuous Clock mode the t_{DT} delay is configured according to the equation specified in the CTAR[DT] field description. When in Continuous Clock mode, the delay is fixed at 1 SCK period.

37.4.4 Transfer formats

The SPI serial communication is controlled by the Serial Communications Clock (SCK) signal and the PCS signals. The SCK signal provided by the master device synchronizes shifting and sampling of the data on the SIN and SOUT pins. The PCS signals serve as enable signals for the slave devices.

In Master mode, the CPOL and CPHA bits in the Clock and Transfer Attributes Registers (CTARn) select the polarity and phase of the serial clock, SCK.

- CPOL - Selects the idle state polarity of the SCK
- CPHA - Selects if the data on SOUT is valid before or on the first SCK edge

Even though the bus slave does not control the SCK signal, in Slave mode the values of CPOL and CPHA must be identical to the master device settings to ensure proper transmission. In SPI Slave mode, only CTAR0 is used.

The module supports four different transfer formats:

- Classic SPI with CPHA=0
- Classic SPI with CPHA=1
- Modified Transfer Format with CPHA = 0
- Modified Transfer Format with CPHA = 1

A modified transfer format is supported to allow for high-speed communication with peripherals that require longer setup times. The module can sample the incoming data later than halfway through the cycle to give the peripheral more setup time. The MTFE bit in the MCR selects between Classic SPI Format and Modified Transfer Format.

In the interface configurations, the module provides the option of keeping the PCS signals asserted between frames. See [Continuous Selection Format](#) for details.

37.4.4.1 Classic SPI Transfer Format (CPHA = 0)

The transfer format shown in following figure is used to communicate with peripheral SPI slave devices where the first data bit is available on the first clock edge. In this format, the master and slave sample their SIN pins on the odd-numbered SCK edges and change the data on their SOUT pins on the even-numbered SCK edges.

Functional description

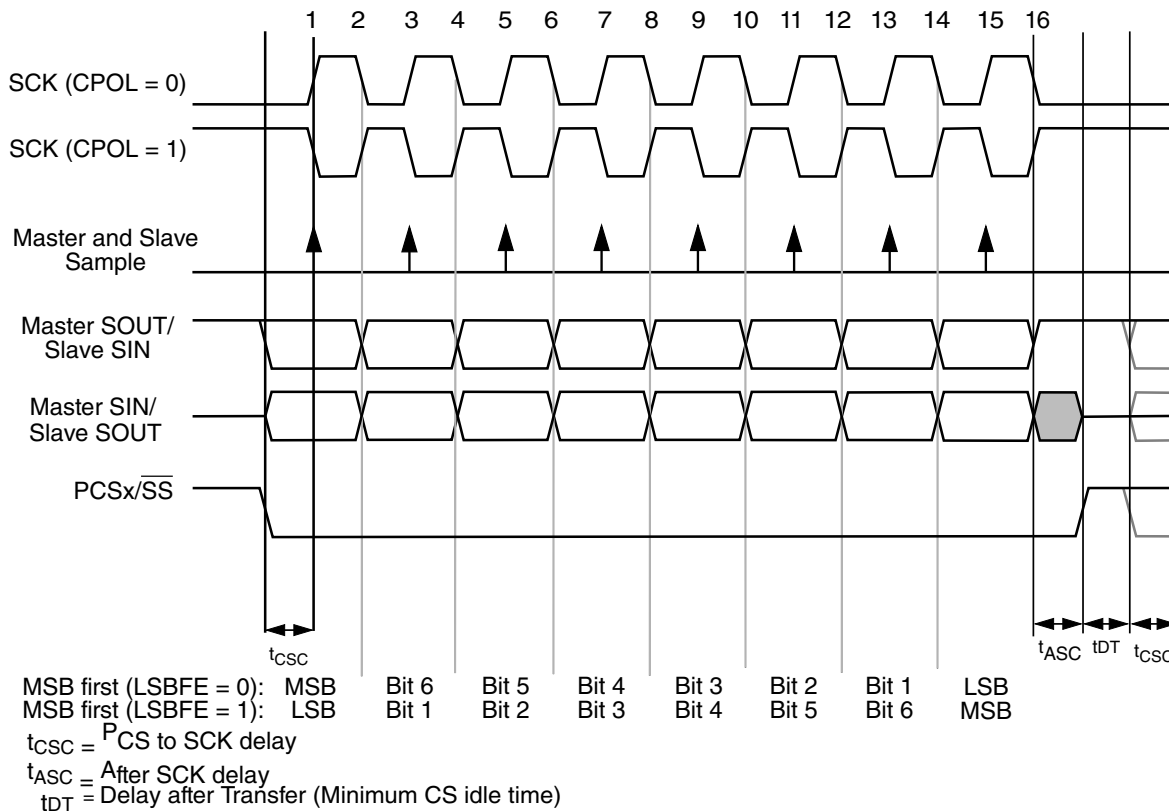

Figure 37-5. Module transfer timing diagram (MTFE=0, CPHA=0, FMSZ=8)

The master initiates the transfer by placing its first data bit on the SOUT pin and asserting the appropriate peripheral chip select signals to the slave device. The slave responds by placing its first data bit on its SOUT pin. After the t_{CSC} delay elapses, the master outputs the first edge of SCK. The master and slave devices use this edge to sample the first input data bit on their serial data input signals. At the second edge of the SCK, the master and slave devices place their second data bit on their serial data output signals. For the rest of the frame the master and the slave sample their SIN pins on the odd-numbered clock edges and changes the data on their SOUT pins on the even-numbered clock edges. After the last clock edge occurs, a delay of t_{ASC} is inserted before the master negates the PCS signals. A delay of t_{DT} is inserted before a new frame transfer can be initiated by the master.

37.4.4.2 Classic SPI Transfer Format (CPHA = 1)

This transfer format shown in the following figure is used to communicate with peripheral SPI slave devices that require the first SCK edge before the first data bit becomes available on the slave SOUT pin. In this format, the master and slave devices change the data on their SOUT pins on the odd-numbered SCK edges and sample the data on their SIN pins on the even-numbered SCK edges.

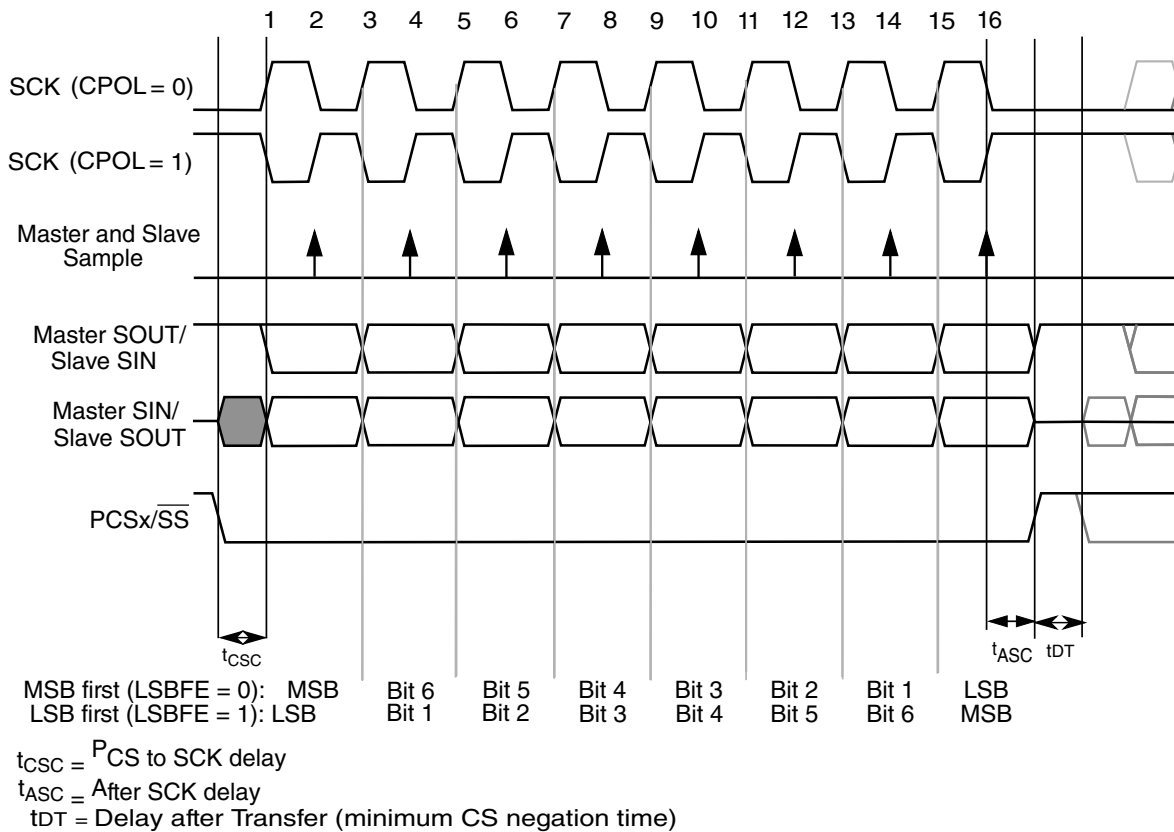

Figure 37-6. Module transfer timing diagram (MTFE=0, CPHA=1, FMSZ=8)

The master initiates the transfer by asserting the PCS signal to the slave. After the t_{CSC} delay has elapsed, the master generates the first SCK edge and at the same time places valid data on the master SOUT pin. The slave responds to the first SCK edge by placing its first data bit on its slave SOUT pin.

At the second edge of the SCK the master and slave sample their SIN pins. For the rest of the frame the master and the slave change the data on their SOUT pins on the odd-numbered clock edges and sample their SIN pins on the even-numbered clock edges. After the last clock edge occurs, a delay of t_{ASC} is inserted before the master negates the PCS signal. A delay of t_{DT} is inserted before a new frame transfer can be initiated by the master.

37.4.4.3 Modified SPI Transfer Format (MTFE = 1, CPHA = 0)

In this Modified Transfer Format both the master and the slave sample later in the SCK period than in Classic SPI mode to allow the logic to tolerate more delays in device pads and board traces. These delays become a more significant fraction of the SCK period as the SCK period decreases with increasing baud rates.

The master and the slave place data on the SOUT pins at the assertion of the PCS signal. After the PCS to SCK delay has elapsed the first SCK edge is generated. The slave samples the master SOUT signal on every odd numbered SCK edge. The SPI in the slave mode when the MTFE bit is set also places new data on the slave SOUT on every odd numbered clock edge. Regular external slave, configured with CPHA=0 format drives its SOUT output at every even numbered SCK clock edge.

The SPI master places its second data bit on the SOUT line one protocol clock after odd numbered SCK edge if the protocol clock frequency to SCK frequency ratio is higher than three. If this ratio is below four the master changes SOUT at odd numbered SCK edge. The point where the master samples the SIN is selected by the SPI_MCR[SMPL_PT] field. The master sample point can be delayed by one or two protocol clock cycles. The SMPL_PT field should be set to 0 if the protocol to SCK frequency ratio is less than 4. However if this ratio is less than 4, the actual sample point is delayed by one protocol clock cycle automatically by the design.

The following timing diagrams illustrate the SPI operation with MTFE=1. Timing delays shown are:

- T_{csc} - PCS to SCK assertion delay
- T_{acs} - After SCK PCS negation delay
- $T_{su_{ms}}$ - master SIN setup time
- $T_{hd_{ms}}$ - master SIN hold time
- $T_{vd_{sl}}$ - slave data output valid time, time between slave data output SCK driving edge and data becomes valid.
- $T_{su_{sl}}$ - data setup time on slave data input
- $T_{hd_{sl}}$ - data hold time on slave data input
- T_{sys} - protocol clock period.

The following figure shows the modified transfer format for CPHA = 0 and Fsys/Fsck = 4. Only the condition where CPOL = 0 is illustrated. Solid triangles show the data sampling clock edges. The two possible slave behavior are shown.

- Signal, marked "SOUT of Ext Slave", presents regular SPI slave serial output.
- Signal, marked "SOUT of SPI Slave", presents SPI in the slave mode with MTFE bit set.

Other MTFE = 1 diagrams show SPI SIN input as being driven by a regular external SPI slave, configured according SPI master CPHA programming.

Note

In the following diagrams, f_{sys} represents the protocol clock frequency from which the Baud frequency f_{sck} is derived.

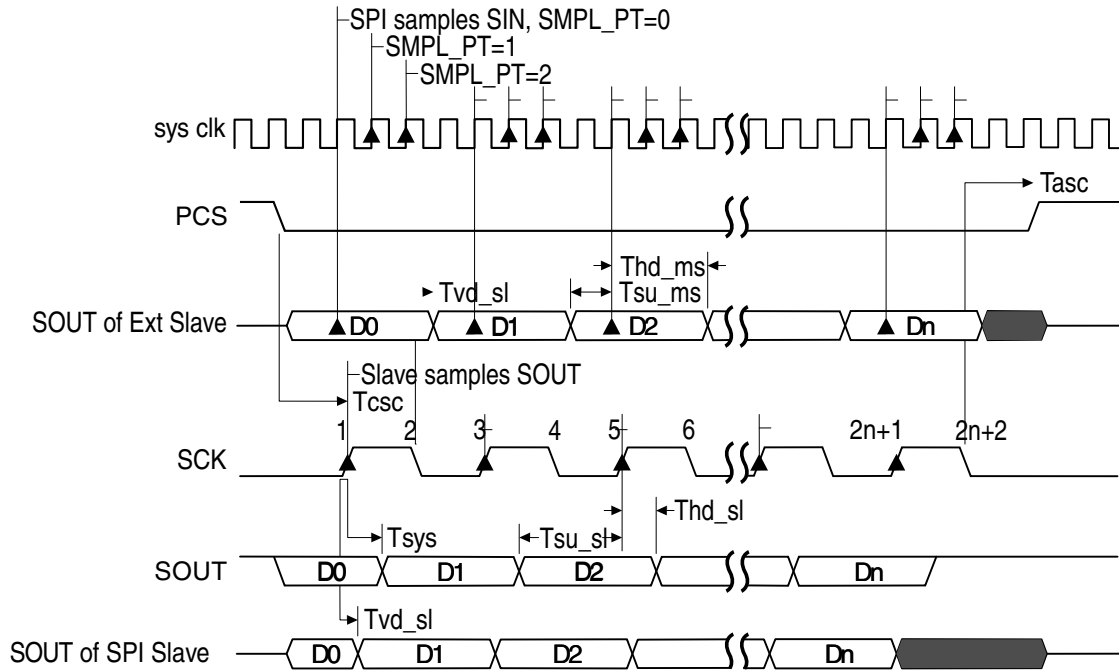

Figure 37-7. SPI Modified Transfer Format (MTFE=1, CPHA=0, $f_{sck} = f_{sys}/4$)

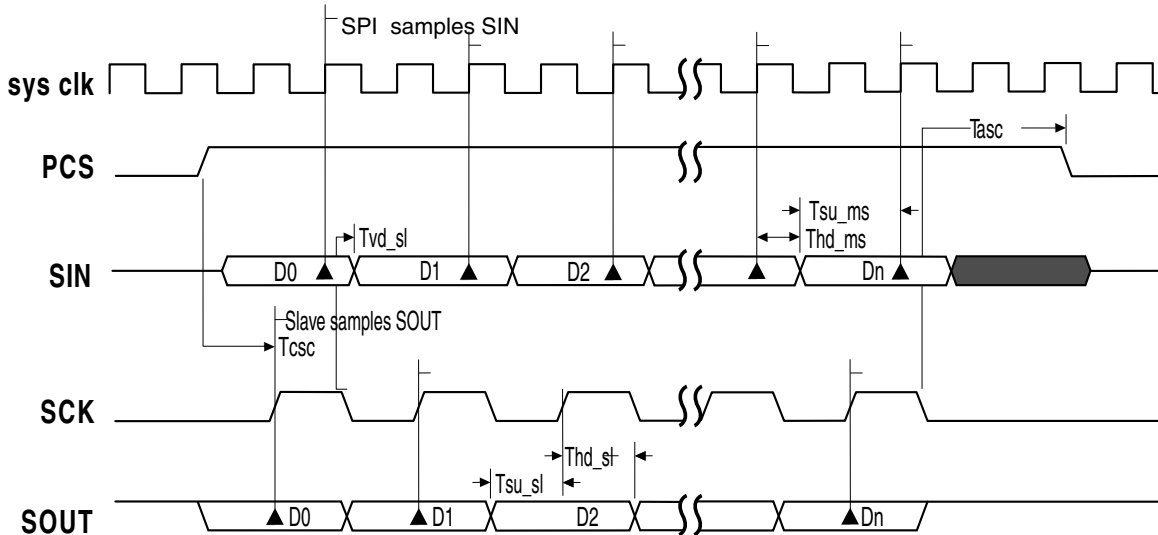

Figure 37-8. SPI Modified Transfer Format (MTFE=1, CPHA=0, $f_{sck} = f_{sys}/2$)

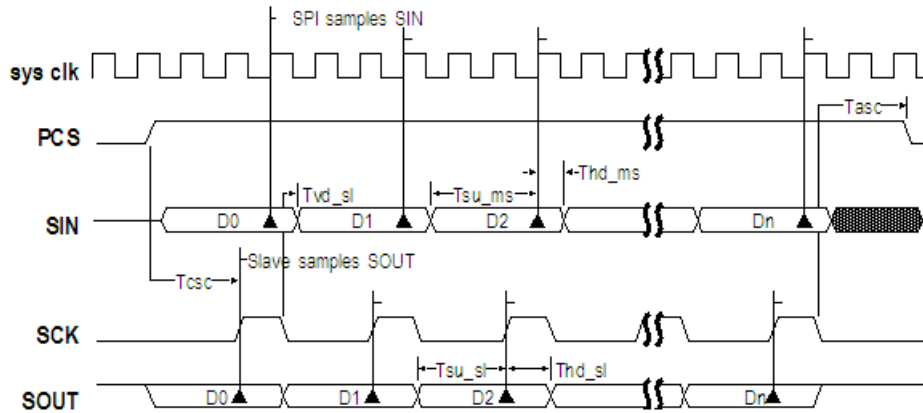

Figure 37-9. SPI Modified Transfer Format (MTFE=1, CPHA=0, $f_{sck} = f_{sys}/3$)

37.4.4.4 Modified SPI Transfer Format (MTFE = 1, CPHA = 1)

The following figures show the Modified Transfer Format for CPHA = 1. Only the condition, where CPOL = 0 is shown. At the start of a transfer the SPI asserts the PCS signal to the slave device. After the PCS to SCK delay has elapsed the master and the slave put data on their SOUT pins at the first edge of SCK. The slave samples the master SOUT signal on the even numbered edges of SCK. The master samples the slave SOUT signal on the odd numbered SCK edges starting with the third SCK edge. The slave samples the last bit on the last edge of the SCK. The master samples the last slave SOUT bit one half SCK cycle after the last edge of SCK. No clock edge will be visible on the master SCK pin during the sampling of the last bit. **The SCK to PCS delay and the After SCK delay must be greater or equal to half of the SCK period.**

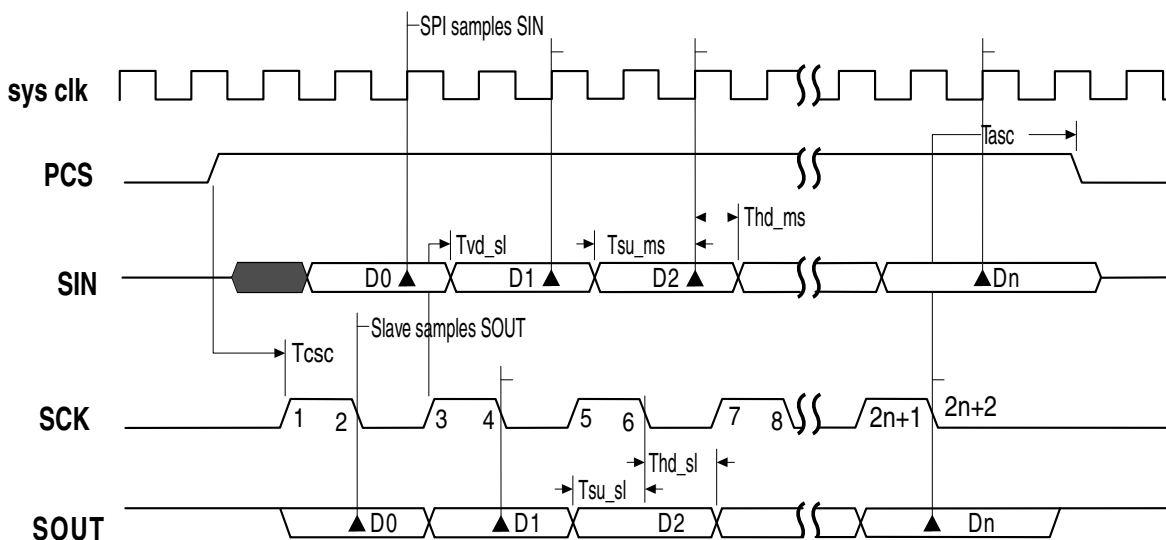

Figure 37-10. SPI Modified Transfer Format (MTFE=1, CPHA=1, $f_{sck} = f_{sys}/2$)

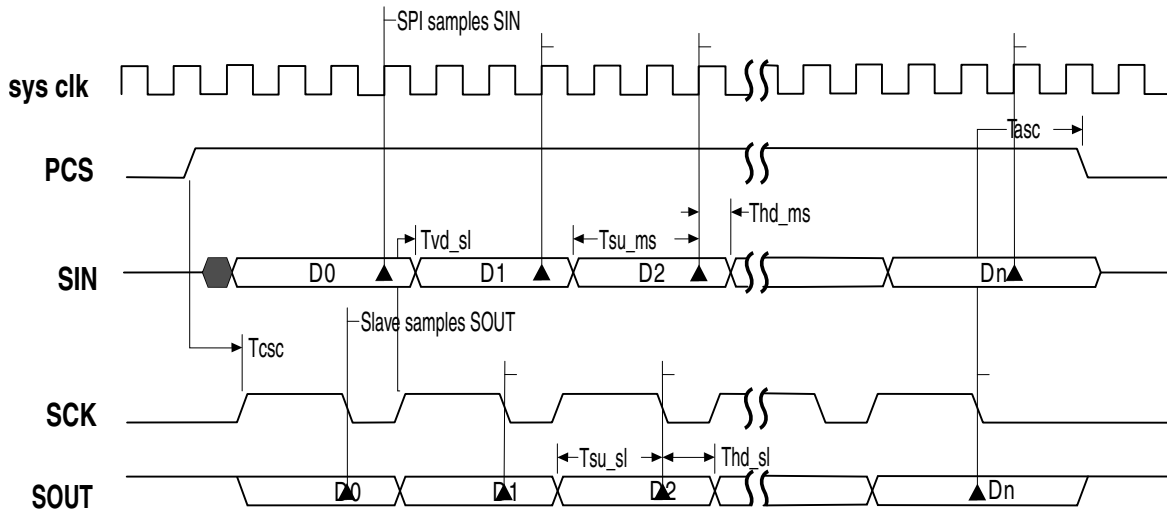

Figure 37-11. SPI Modified Transfer Format (MTFE=1, CPHA=1, $f_{sck} = f_{sys}/3$)

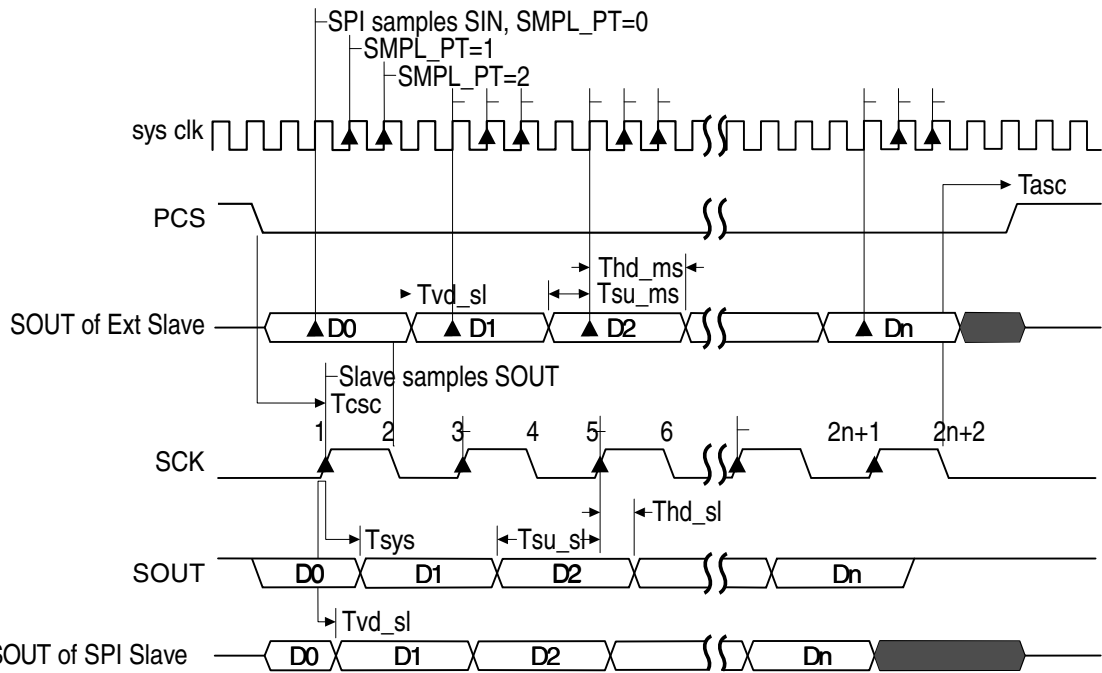

Figure 37-12. SPI Modified Transfer Format (MTFE=1, CPHA=1, $f_{sck} = f_{sys}/4$)

37.4.4.5 Continuous Selection Format

Some peripherals must be deselected between every transfer. Other peripherals must remain selected between several sequential serial transfers. The Continuous Selection Format provides the flexibility to handle the following case. The Continuous Selection Format is enabled for the SPI configuration by setting the **CONT** bit in the SPI command.

Functional description

When the CONT bit = 0, the module drives the asserted Chip Select signals to their idle states in between frames. The idle states of the Chip Select signals are selected by the PCSISn bits in the MCR. The following timing diagram is for two four-bit transfers with CPHA = 1 and CONT = 0.

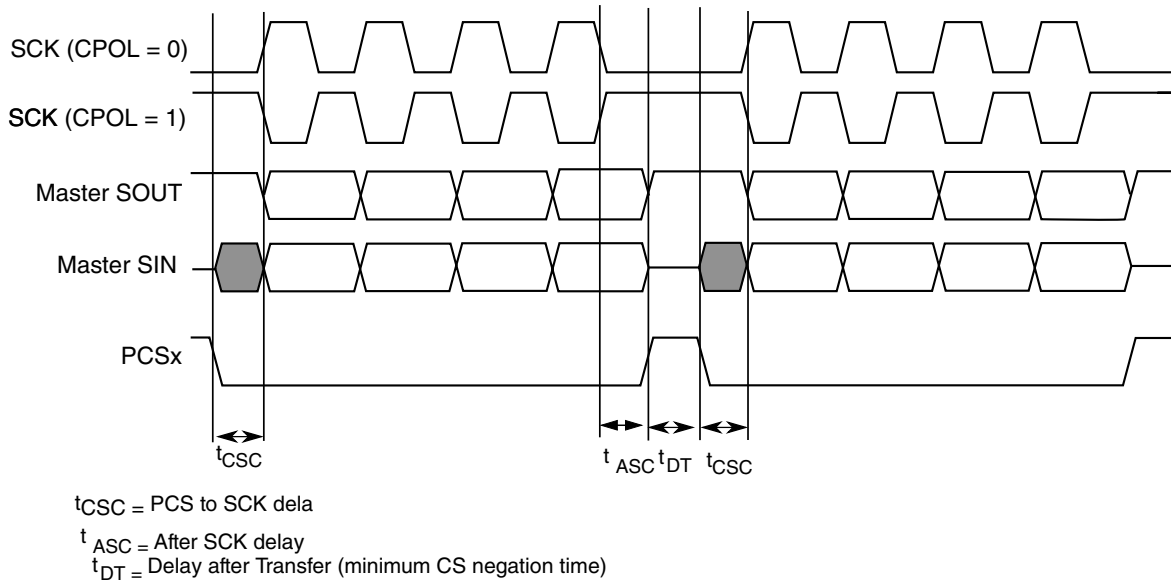

Figure 37-13. Example of non-continuous format (CPHA=1, CONT=0)

When the CONT bit = 1, the PCS signal remains asserted for the duration of the two transfers. The Delay between Transfers (t_{DT}) is not inserted between the transfers. The following figure shows the timing diagram for two four-bit transfers with CPHA = 1 and CONT = 1.

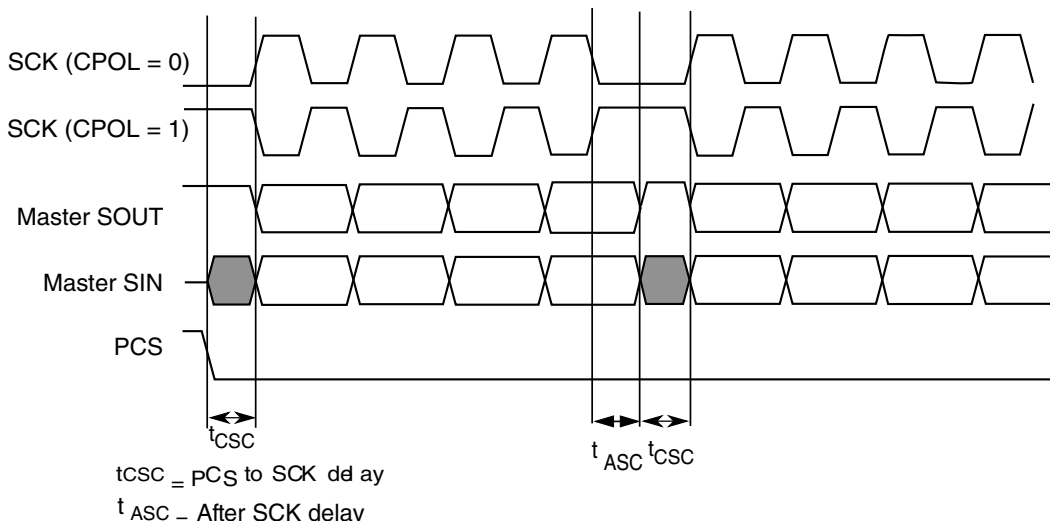

Figure 37-14. Example of continuous transfer (CPHA=1, CONT=1)

When using the module with continuous selection follow these rules:

- All transmit commands must have the same PCSn bits programming.
- The CTARs, selected by transmit commands, must be programmed with the same transfer attributes. Only FMSZ field can be programmed differently in these CTARs.
- When transmitting multiple frames in this mode, the user software must ensure that the last frame has the PUSHHR[CONT] bit deasserted in Master mode and the user software must provide sufficient frames in the TX_FIFO to be sent out in Slave mode and the master deasserts the PCSn at end of transmission of the last frame.
- PUSHHR[CONT] must be deasserted before asserting MCR[HALT] in master mode. This will make sure that the PCSn signals are deasserted. Asserting MCR[HALT] during continuous transfer will cause the PCSn signals to remain asserted and hence Slave Device cannot transition from Running to Stopped state.

NOTE

User must fill the TX FIFO with the number of entries that will be concatenated together under one PCS assertion for both master and slave before the TX FIFO becomes empty.

When operating in Slave mode, ensure that when the last entry in the TX FIFO is completely transmitted, that is, the corresponding TCF flag is asserted and TXFIFO is empty, the slave is deselected for any further serial communication; otherwise, an underflow error occurs.

37.4.5 Continuous Serial Communications Clock

The module provides the option of generating a Continuous SCK signal for slave peripherals that require a continuous clock.

Continuous SCK is enabled by setting the CONT_SCKE bit in the MCR. Enabling this bit generates the Continuous SCK only if MCR[HALT] bit is low. Continuous SCK is valid in all configurations.

Continuous SCK is only supported for CPHA=1. Clearing CPHA is ignored if the CONT_SCKE bit is set. Continuous SCK is supported for Modified Transfer Format.

Clock and transfer attributes for the Continuous SCK mode are set according to the following rules:

Functional description

- When the module is in SPI configuration, CTAR0 is used initially. At the start of each SPI frame transfer, the CTAR specified by the CTAS for the frame is used.
- In all configurations, the currently selected CTAR remains in use until the start of a frame with a different CTAR specified, or the Continuous SCK mode is terminated.

It is recommended to keep the baud rate the same while using the Continuous SCK. Switching clock polarity between frames while using Continuous SCK can cause errors in the transfer. Continuous SCK operation is not guaranteed if the module is put into the External Stop mode or Module Disable mode.

Enabling Continuous SCK disables the PCS to SCK delay and the Delay after Transfer (t_{DT}) is fixed to one SCK cycle. The following figure is the timing diagram for Continuous SCK format with Continuous Selection disabled.

NOTE

In Continuous SCK mode, for the SPI transfer CTAR0 should always be used, and the TX FIFO must be cleared using the MCR[CLR_TXF] field before initiating transfer.

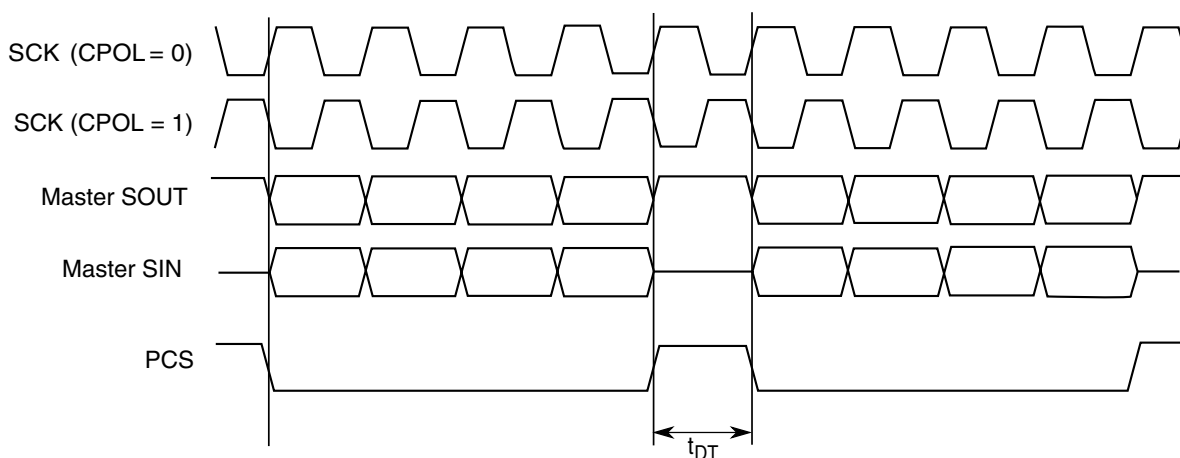

Figure 37-15. Continuous SCK Timing Diagram (CONT=0)

If the CONT bit in the TX FIFO entry is set, PCS remains asserted between the transfers. Under certain conditions, SCK can continue with PCS asserted, but with no data being shifted out of SOUT, that is, SOUT pulled high. This can cause the slave to receive incorrect data. Those conditions include:

- Continuous SCK with CONT bit set, but no data in the TX FIFO.

- Continuous SCK with CONT bit set and entering Stopped state (refer to [Start and Stop of module transfers](#)).
- Continuous SCK with CONT bit set and entering Stop mode or Module Disable mode.

The following figure shows timing diagram for Continuous SCK format with Continuous Selection enabled.

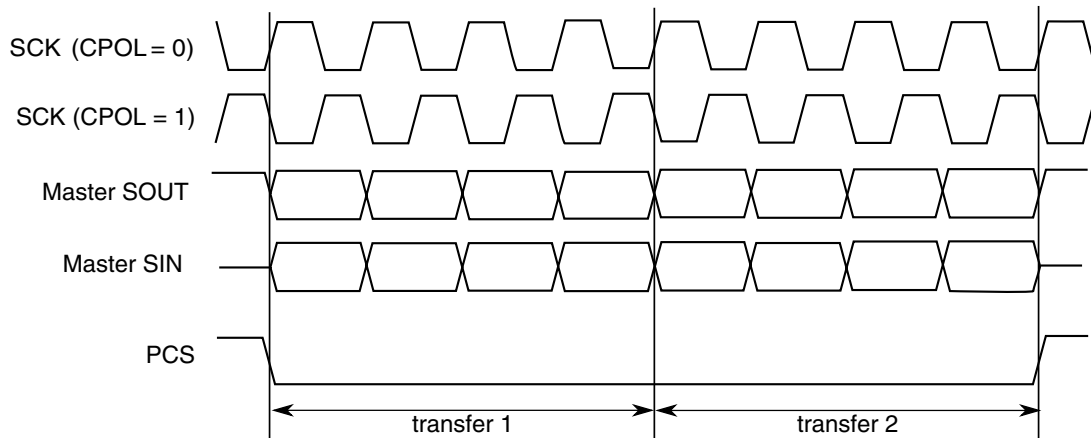

Figure 37-16. Continuous SCK timing diagram (CONT=1)

37.4.6 Slave Mode Operation Constraints

Slave mode logic shift register is buffered. This allows data streaming operation, when the module is permanently selected and data is shifted in with a constant rate.

The transmit data is transferred at second SCK clock edge of the each frame to the shift register if the \overline{SS} signal is asserted and any time when transmit data is ready and \overline{SS} signal is negated.

Received data is transferred to the receive buffer at last SCK edge of each frame, defined by frame size programmed to the CTAR0/1 register. Then the data from the buffer is transferred to the RXFIFO or DDR register.

If the \overline{SS} negates before that last SCK edge, the data from shift register is lost.

37.4.7 Interrupts/DMA requests

The module has several conditions that can generate only interrupt requests and two conditions that can generate interrupt or DMA requests. The following table lists these conditions.

Table 37-9. Interrupt and DMA request conditions

| Condition | Flag | Interrupt | DMA |
|--------------------|------|-----------|-----|
| End of Queue (EOQ) | EOQF | Yes | - |
| TX FIFO Fill | TFFF | Yes | Yes |
| Transfer Complete | TCF | Yes | - |
| TX FIFO Underflow | TFUF | Yes | - |
| RX FIFO Drain | RFDF | Yes | Yes |
| RX FIFO Overflow | RFOF | Yes | - |

Each condition has a flag bit in the module Status Register (SR) and a Request Enable bit in the DMA/Interrupt Request Select and Enable Register (RSER). Certain flags (as shown in above table) generate interrupt requests or DMA requests depending on configuration of RSER register.

The module also provides a global interrupt request line, which is asserted when any of individual interrupt requests lines is asserted.

37.4.7.1 End Of Queue interrupt request

The End Of Queue (EOQ) interrupt request indicates that the end of a transmit queue is reached. The module generates the interrupt request when EOQ interrupt requests are enabled (RSER[EOQF_RE]) and the EOQ bit in the executing SPI command is 1.

The module generates the interrupt request when the last bit of the SPI frame with EOQ bit set is transmitted.

37.4.7.2 Transmit FIFO Fill Interrupt or DMA Request

The Transmit FIFO Fill Request indicates that the TX FIFO is not full. The Transmit FIFO Fill Request is generated when the number of entries in the TX FIFO is less than the maximum number of possible entries, and the TFFF_RE bit in the RSER is set. The TFFF_DIRS bit in the RSER selects whether a DMA request or an interrupt request is generated.

NOTE

TFFF flag clears automatically when DMA is used to fill TX FIFO. Configure the DMA to fill only one FIFO location per transfer.

To clear TFFF when not using DMA, follow these steps for every PUSH performed using CPU to fill TX FIFO:

1. Wait until TFFF = 1.
2. Write data to PUSHR using CPU.
3. Clear TFFF by writing a 1 to its location. If TX FIFO is not full, this flag will not clear.

37.4.7.3 Transfer Complete Interrupt Request

The Transfer Complete Request indicates the end of the transfer of a serial frame. The Transfer Complete Request is generated at the end of each frame transfer when the TCF_RE bit is set in the RSER.

37.4.7.4 Transmit FIFO Underflow Interrupt Request

The Transmit FIFO Underflow Request indicates that an underflow condition in the TX FIFO has occurred. The transmit underflow condition is detected only for the module operating in Slave mode and SPI configuration. The TFUF bit is set when the TX FIFO of the module is empty, and a transfer is initiated from an external SPI master. If the TFUF bit is set while the TFUF_RE bit in the RSER is set, an interrupt request is generated.

37.4.7.5 Receive FIFO Drain Interrupt or DMA Request

The Receive FIFO Drain Request indicates that the RX FIFO is not empty. The Receive FIFO Drain Request is generated when the number of entries in the RX FIFO is not zero, and the RFDF_RE bit in the RSER is set. The RFDF_DIRS bit in the RSER selects whether a DMA request or an interrupt request is generated. Configure the DMA to drain only one FIFO location per transfer.

37.4.7.6 Receive FIFO Overflow Interrupt Request

The Receive FIFO Overflow Request indicates that an overflow condition in the RX FIFO has occurred. A Receive FIFO Overflow request is generated when RX FIFO and shift register are full and a transfer is initiated. The RFOF_RE bit in the RSER must be set for the interrupt request to be generated.

Depending on the state of the ROOE bit in the MCR, the data from the transfer that generated the overflow is either ignored or shifted in to the shift register. If the ROOE bit is set, the incoming data is shifted in to the shift register. If the ROOE bit is cleared, the incoming data is ignored.

37.4.8 Power saving features

The module supports following power-saving strategies:

- External Stop mode
- Module Disable mode – Clock gating of non-memory mapped logic

37.4.8.1 Stop mode (External Stop mode)

This module supports the Stop mode protocol. When a request is made to enter External Stop mode, the module acknowledges the request . If a serial transfer is in progress, then this module waits until it reaches the frame boundary before it is ready to have its clocks shut off . While the clocks are shut off, this module's memory-mapped logic is not accessible. This also puts the module in STOPPED state. The SR[TXRXS] bit is cleared to indicate STOPPED state. The states of the interrupt and DMA request signals cannot be changed while in External Stop mode.

37.4.8.2 Module Disable mode

Module Disable mode is a block-specific mode that the module can enter to save power. Host CPU can initiate the Module Disable mode by setting the MDIS bit in the MCR. The Module Disable mode can also be initiated by hardware.

When the MDIS bit is set, the module negates the Clock Enable signal at the next frame boundary. Once the Clock Enable signal is negated, it is said to have entered Module Disable Mode. This also puts the module in STOPPED state. The SR[TXRXS] bit is cleared to indicate STOPPED state. If implemented, the Clock Enable signal can stop the clock to the non-memory mapped logic. When Clock Enable is negated, the module is in a dormant state, but the memory mapped registers are still accessible. Certain read or write operations have a different effect when the module is in the Module Disable mode. Reading the RX FIFO Pop Register does not change the state of the RX FIFO. Similarly, writing to the PUSHR Register does not change the state of the TX FIFO. Clearing either of the FIFOs has no effect in the Module Disable mode. Changes to the DIS_TXF and DIS_RXF fields of the MCR have no effect in the Module Disable mode. In the Module

Disable mode, all status bits and register flags in the module return the correct values when read, but writing to them has no effect. Writing to the TCR during Module Disable mode has no effect. Interrupt and DMA request signals cannot be cleared while in the Module Disable mode.

37.5 Initialization/application information

This section describes how to initialize the module.

37.5.1 How to manage queues

The queues are not part of the module, but it includes features in support of queue management. Queues are primarily supported in SPI configuration.

1. When module executes last command word from a queue, the EOQ bit in the command word is set to indicate it that this is the last entry in the queue.
2. At the end of the transfer, corresponding to the command word with EOQ set is sampled, the EOQ flag (EOQF) in the SR is set.
3. The setting of the EOQF flag disables serial transmission and reception of data, putting the module in the Stopped state. The TXRXS bit is cleared to indicate the Stopped state.
4. The DMA can continue to fill TX FIFO until it is full or step 5 occurs.
5. Disable DMA transfers by disabling the DMA enable request for the DMA channel assigned to TX FIFO and RX FIFO. This is done by clearing the corresponding DMA enable request bits in the DMA Controller.
6. Ensure all received data in RX FIFO has been transferred to memory receive queue by reading the RXCNT in SR or by checking RFDF in the SR after each read operation of the POPR.
7. Modify DMA descriptor of TX and RX channels for new queues
8. Flush TX FIFO by writing a 1 to the CLR_TXF bit in the MCR. Flush RX FIFO by writing a '1' to the CLR_RXF bit in the MCR.
9. Clear transfer count either by setting CTCNT bit in the command word of the first entry in the new queue or via CPU writing directly to SPI_TCNT field in the TCR.

10. Enable DMA channel by enabling the DMA enable request for the DMA channel assigned to the module TX FIFO, and RX FIFO by setting the corresponding DMA set enable request bit.
11. Enable serial transmission and serial reception of data by clearing the EOQF bit.

37.5.2 Switching Master and Slave mode

When changing modes in the module, follow the steps below to guarantee proper operation.

1. Halt it by setting MCR[HALT].
2. Clear the transmit and receive FIFOs by writing a 1 to the CLR_TXF and CLR_RXF bits in MCR.
3. Set the appropriate mode in MCR[MSTR] and enable it by clearing MCR[HALT].

37.5.3 Initializing Module in Master/Slave Modes

Once the appropriate mode in MCR[MSTR] is configured, the module is enabled by clearing MCR[HALT]. It should be ensured that module Slave is enabled before enabling its Master. This ensures the Slave is ready to be communicated with, before Master initializes communication.

37.5.4 Baud rate settings

The following table shows the baud rate that is generated based on the combination of the baud rate prescaler PBR and the baud rate scaler BR in the CTARs. The values calculated assume a 100 MHz protocol frequency and the double baud rate DBR bit is cleared.

Table 37-10. Baud rate values (bps)

| | | Baud rate divider prescaler values | | | |
|-------------------------|-------|------------------------------------|-------|-------|-------|
| | | 2 | 3 | 5 | 7 |
| Baud Rate Scaler Values | 2 | 25.0M | 16.7M | 10.0M | 7.14M |
| | 4 | 12.5M | 8.33M | 5.00M | 3.57M |
| | 6 | 8.33M | 5.56M | 3.33M | 2.38M |
| | 8 | 6.25M | 4.17M | 2.50M | 1.79M |
| | 16 | 3.12M | 2.08M | 1.25M | 893k |
| | 32 | 1.56M | 1.04M | 625k | 446k |
| | 64 | 781k | 521k | 312k | 223k |
| | 128 | 391k | 260k | 156k | 112k |
| | 256 | 195k | 130k | 78.1k | 55.8k |
| | 512 | 97.7k | 65.1k | 39.1k | 27.9k |
| | 1024 | 48.8k | 32.6k | 19.5k | 14.0k |
| | 2048 | 24.4k | 16.3k | 9.77k | 6.98k |
| | 4096 | 12.2k | 8.14k | 4.88k | 3.49k |
| | 8192 | 6.10k | 4.07k | 2.44k | 1.74k |
| | 16384 | 3.05k | 2.04k | 1.22k | 872 |
| 32768 | 1.53k | 1.02k | 610 | 436 | |

37.5.5 Delay settings

The following table shows the values for the Delay after Transfer (t_{DT}) and CS to SCK Delay (T_{CSC}) that can be generated based on the prescaler values and the scaler values set in the CTARs. The values calculated assume a 100 MHz protocol frequency.

NOTE

The clock frequency mentioned above is given as an example in this chapter. See the clocking chapter for the frequency used to drive this module in the device.

Table 37-11. Delay values

| | | Delay prescaler values | | | |
|---------------------|---------------|------------------------|---------------|---------------|---------------|
| | | 1 | 3 | 5 | 7 |
| Delay scaler values | 2 | 20.0 ns | 60.0 ns | 100.0 ns | 140.0 ns |
| | 4 | 40.0 ns | 120.0 ns | 200.0 ns | 280.0 ns |
| | 8 | 80.0 ns | 240.0 ns | 400.0 ns | 560.0 ns |
| | 16 | 160.0 ns | 480.0 ns | 800.0 ns | 1.1 μ s |
| | 32 | 320.0 ns | 960.0 ns | 1.6 μ s | 2.2 μ s |
| | 64 | 640.0 ns | 1.9 μ s | 3.2 μ s | 4.5 μ s |
| | 128 | 1.3 μ s | 3.8 μ s | 6.4 μ s | 9.0 μ s |
| | 256 | 2.6 μ s | 7.7 μ s | 12.8 μ s | 17.9 μ s |
| | 512 | 5.1 μ s | 15.4 μ s | 25.6 μ s | 35.8 μ s |
| | 1024 | 10.2 μ s | 30.7 μ s | 51.2 μ s | 71.7 μ s |
| | 2048 | 20.5 μ s | 61.4 μ s | 102.4 μ s | 143.4 μ s |
| | 4096 | 41.0 μ s | 122.9 μ s | 204.8 μ s | 286.7 μ s |
| | 8192 | 81.9 μ s | 245.8 μ s | 409.6 μ s | 573.4 μ s |
| | 16384 | 163.8 μ s | 491.5 μ s | 819.2 μ s | 1.1 ms |
| | 32768 | 327.7 μ s | 983.0 μ s | 1.6 ms | 2.3 ms |
| 65536 | 655.4 μ s | 2.0 ms | 3.3 ms | 4.6 ms | |

37.5.6 Calculation of FIFO pointer addresses

Complete visibility of the FIFO contents is available through the FIFO registers, and valid entries can be identified through a memory-mapped pointer and counter for each FIFO. The pointer to the first-in entry in each FIFO is memory mapped. For the TX FIFO the first-in pointer is the Transmit Next Pointer (TXNXTPTR). For the RX FIFO the first-in pointer is the Pop Next Pointer (POPNXTPTR). The following figure illustrates the concept of first-in and last-in FIFO entries along with the FIFO Counter. The TX FIFO is chosen for the illustration, but the concepts carry over. See [Transmit First In First Out \(TX FIFO\) buffering mechanism](#) and [Receive First In First Out \(RX FIFO\) buffering mechanism](#) for details on the FIFO operation.

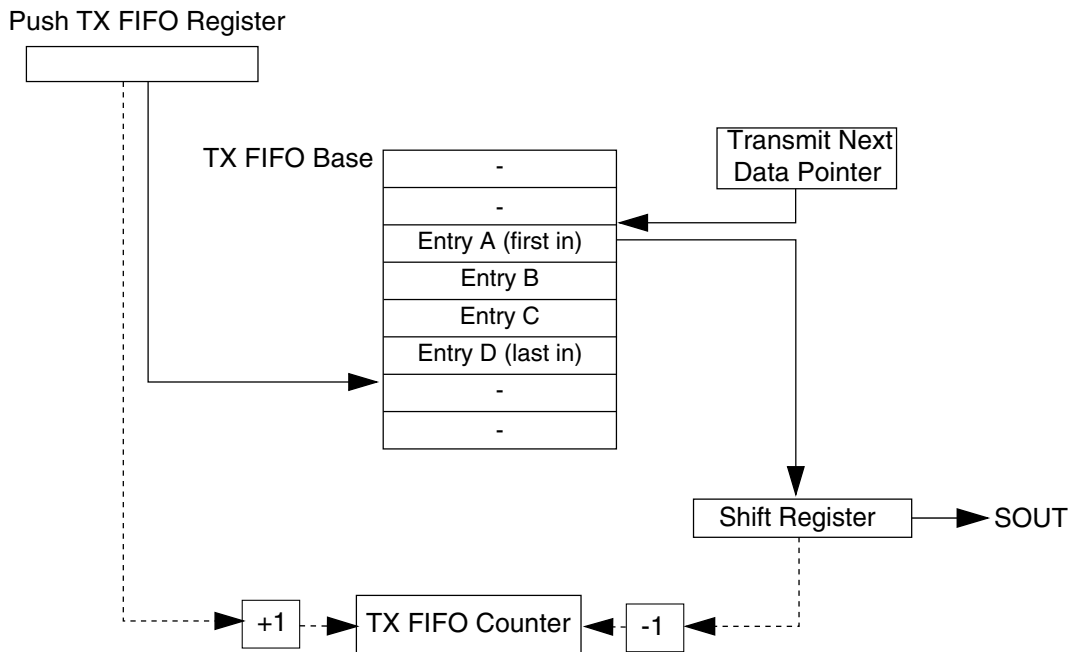

Figure 37-17. TX FIFO pointers and counter

37.5.6.1 Address Calculation for the First-in Entry and Last-in Entry in the TX FIFO

The memory address of the first-in entry in the TX FIFO is computed by the following equation:

$$\text{First-in EntryAddress} = \text{TXFIFOBase} + (4 \times \text{TXNXPTR})$$

The memory address of the last-in entry in the TX FIFO is computed by the following equation:

$$\text{Last-inEntryaddress} = \text{TXFIFOBase} + 4 \times (\text{TXCTR} + \text{TXNXPTR} - 1) \bmod (\text{TXFIFOdepth})$$

TX FIFO Base - Base address of TX FIFO

TXCTR - TX FIFO Counter

TXNXPTR - Transmit Next Pointer

TX FIFO Depth - Transmit FIFO depth, implementation specific

37.5.6.2 Address Calculation for the First-in Entry and Last-in Entry in the RX FIFO

The memory address of the first-in entry in the RX FIFO is computed by the following equation:

$$\text{First-in EntryAddress} = \text{RX FIFOBase} + (4 \times \text{POPNextPTR})$$

The memory address of the last-in entry in the RX FIFO is computed by the following equation:

$$\text{Last-inEntryaddress} = \text{RX FIFO Base} + 4 \times (\text{RXCTR} + \text{POPNextPTR} - 1) \bmod (\text{RXFIFOdepth})$$

RX FIFO Base - Base address of RX FIFO

RXCTR - RX FIFO counter

POPNextPTR - Pop Next Pointer

RX FIFO Depth - Receive FIFO depth, implementation specific

Chapter 38

Inter-Integrated Circuit (I2C)

The inter-integrated circuit (I²C, I2C, or IIC) module provides a method of communication between a number of devices.

38.1 Introduction

The inter-integrated circuit (I²C, I2C, or IIC) module provides a method of communication between a number of devices.

The interface is designed to operate up to at least 400 kbit/s with maximum bus loading and timing. The I2C device is capable of operating at higher baud rates, up to a maximum of clock/20, with reduced bus loading. The maximum communication length and the number of devices that can be connected are limited by a maximum bus capacitance of 400 pF. The I2C module also complies with the *System Management Bus (SMBus) Specification, version 2*.

38.1.1 Features

The I2C module has the following features:

- Compatible with *The I²C-Bus Specification*
- Multimaster operation
- Software programmable for one of 64 different serial clock frequencies
- Software-selectable acknowledge bit
- Interrupt-driven byte-by-byte data transfer
- Arbitration-lost interrupt with automatic mode switching from master to slave
- Calling address identification interrupt
- START and STOP signal generation and detection
- Repeated START signal generation and detection
- Acknowledge bit generation and detection

- Bus busy detection
- General call recognition
- 10-bit address extension
- Support for *System Management Bus (SMBus) Specification, version 2*
- Programmable input glitch filter
- Low power mode wakeup on slave address match
- Range slave address support
- DMA support
- Double buffering support to achieve higher baud rate

38.1.2 Modes of operation

The I2C module's operation in various low power modes is as follows:

- Run mode: This is the basic mode of operation. To conserve power in this mode, disable the module.
- Wait mode: The module continues to operate when the core is in Wait mode and can provide a wakeup interrupt.
- Stop mode: The module is inactive in Stop mode for reduced power consumption, except that address matching is enabled in Stop mode. The STOP instruction does not affect the I2C module's register states.

38.1.3 Block diagram

The following figure is a functional block diagram of the I2C module.

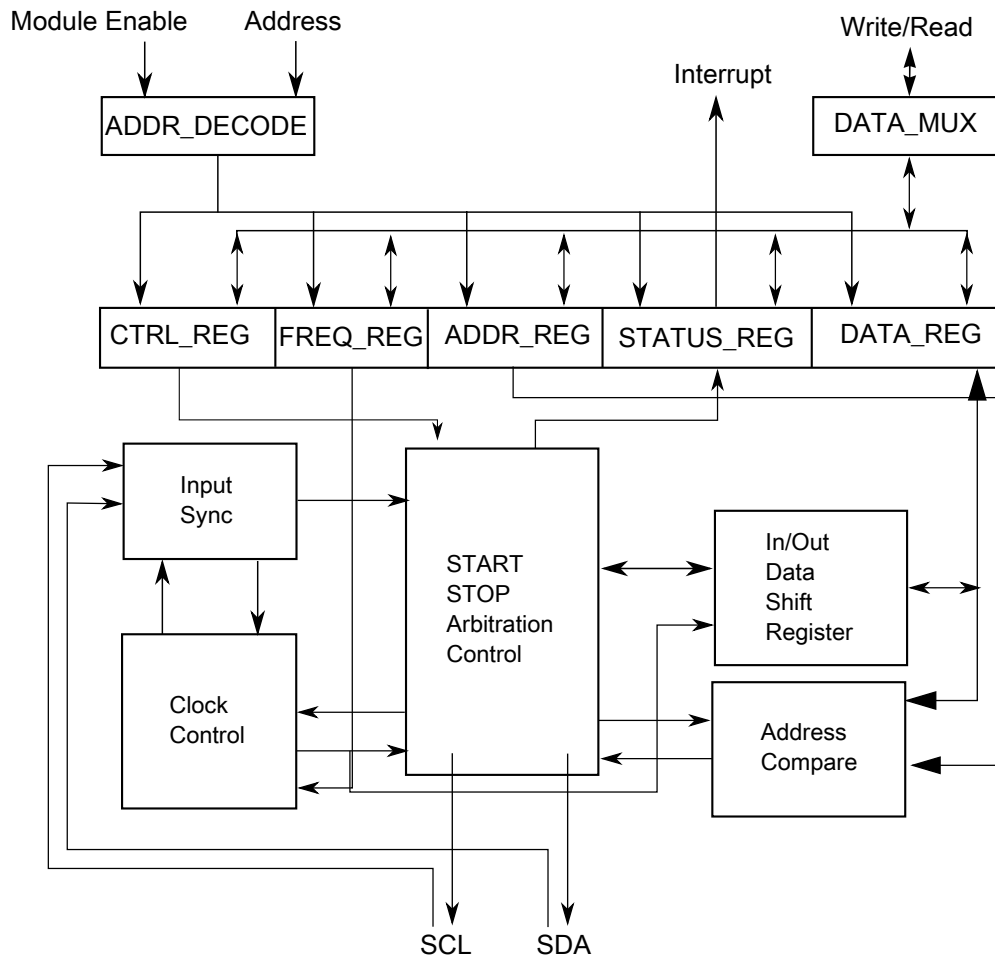

Figure 38-1. I2C Functional block diagram

38.2 I²C signal descriptions

The signal properties of I²C are shown in the table found here.

Table 38-1. I²C signal descriptions

| Signal | Description | I/O |
|--------|---|-----|
| SCL | Bidirectional serial clock line of the I ² C system. | I/O |
| SDA | Bidirectional serial data line of the I ² C system. | I/O |

38.3 Memory map/register definition

This section describes in detail all I2C registers accessible to the end user.

I2C memory map

| Absolute address (hex) | Register name | Width (in bits) | Access | Reset value | Section/page |
|------------------------|--|-----------------|--------|-------------|-----------------------------|
| 4006_6000 | I2C Address Register 1 (I2C0_A1) | 8 | R/W | 00h | 38.3.1/855 |
| 4006_6001 | I2C Frequency Divider register (I2C0_F) | 8 | R/W | 00h | 38.3.2/855 |
| 4006_6002 | I2C Control Register 1 (I2C0_C1) | 8 | R/W | 00h | 38.3.3/856 |
| 4006_6003 | I2C Status register (I2C0_S) | 8 | R/W | 80h | 38.3.4/858 |
| 4006_6004 | I2C Data I/O register (I2C0_D) | 8 | R/W | 00h | 38.3.5/860 |
| 4006_6005 | I2C Control Register 2 (I2C0_C2) | 8 | R/W | 00h | 38.3.6/860 |
| 4006_6006 | I2C Programmable Input Glitch Filter Register (I2C0_FLT) | 8 | R/W | 00h | 38.3.7/861 |
| 4006_6007 | I2C Range Address register (I2C0_RA) | 8 | R/W | 00h | 38.3.8/863 |
| 4006_6008 | I2C SMBus Control and Status register (I2C0_SMB) | 8 | R/W | 00h | 38.3.9/863 |
| 4006_6009 | I2C Address Register 2 (I2C0_A2) | 8 | R/W | C2h | 38.3.10/865 |
| 4006_600A | I2C SCL Low Timeout Register High (I2C0_SLTH) | 8 | R/W | 00h | 38.3.11/865 |
| 4006_600B | I2C SCL Low Timeout Register Low (I2C0_SLTL) | 8 | R/W | 00h | 38.3.12/866 |
| 4006_600C | I2C Status register 2 (I2C0_S2) | 8 | R/W | 01h | 38.3.13/866 |
| 4006_7000 | I2C Address Register 1 (I2C1_A1) | 8 | R/W | 00h | 38.3.1/855 |
| 4006_7001 | I2C Frequency Divider register (I2C1_F) | 8 | R/W | 00h | 38.3.2/855 |
| 4006_7002 | I2C Control Register 1 (I2C1_C1) | 8 | R/W | 00h | 38.3.3/856 |
| 4006_7003 | I2C Status register (I2C1_S) | 8 | R/W | 80h | 38.3.4/858 |
| 4006_7004 | I2C Data I/O register (I2C1_D) | 8 | R/W | 00h | 38.3.5/860 |
| 4006_7005 | I2C Control Register 2 (I2C1_C2) | 8 | R/W | 00h | 38.3.6/860 |
| 4006_7006 | I2C Programmable Input Glitch Filter Register (I2C1_FLT) | 8 | R/W | 00h | 38.3.7/861 |
| 4006_7007 | I2C Range Address register (I2C1_RA) | 8 | R/W | 00h | 38.3.8/863 |
| 4006_7008 | I2C SMBus Control and Status register (I2C1_SMB) | 8 | R/W | 00h | 38.3.9/863 |
| 4006_7009 | I2C Address Register 2 (I2C1_A2) | 8 | R/W | C2h | 38.3.10/865 |
| 4006_700A | I2C SCL Low Timeout Register High (I2C1_SLTH) | 8 | R/W | 00h | 38.3.11/865 |
| 4006_700B | I2C SCL Low Timeout Register Low (I2C1_SLTL) | 8 | R/W | 00h | 38.3.12/866 |
| 4006_700C | I2C Status register 2 (I2C1_S2) | 8 | R/W | 01h | 38.3.13/866 |

38.3.1 I2C Address Register 1 (I2Cx_A1)

This register contains the slave address to be used by the I2C module.

Address: Base address + 0h offset

| | | | | | | | | |
|-------|---------|---|---|---|---|---|---|---|
| Bit | 7 | 6 | 5 | 4 | 3 | 2 | 1 | 0 |
| Read | AD[7:1] | | | | | | | 0 |
| Write | | | | | | | | |
| Reset | 0 | 0 | 0 | 0 | 0 | 0 | 0 | 0 |

I2Cx_A1 field descriptions

| Field | Description |
|----------------|---|
| 7–1 AD[7:1] | Address Contains the primary slave address used by the I2C module when it is addressed as a slave. This field is used in the 7-bit address scheme and the lower seven bits in the 10-bit address scheme. |
| 0 Reserved | This field is reserved. This read-only field is reserved and always has the value 0. |

38.3.2 I2C Frequency Divider register (I2Cx_F)

Address: Base address + 1h offset

| | | | | | | | | |
|-------|------|---|---|-----|---|---|---|---|
| Bit | 7 | 6 | 5 | 4 | 3 | 2 | 1 | 0 |
| Read | MULT | | | ICR | | | | |
| Write | | | | | | | | |
| Reset | 0 | 0 | 0 | 0 | 0 | 0 | 0 | 0 |

I2Cx_F field descriptions

| Field | Description |
|-------------|---|
| 7–6 MULT | Multiplier Factor Defines the multiplier factor (mul). This factor is used along with the SCL divider to generate the I2C baud rate. 00 mul = 1 01 mul = 2 10 mul = 4 11 Reserved |
| ICR | ClockRate Prescales the I2C module clock for bit rate selection. This field and the MULT field determine the I2C baud rate, the SDA hold time, the SCL start hold time, and the SCL stop hold time. For a list of values corresponding to each ICR setting, see I2C divider and hold values . The SCL divider multiplied by multiplier factor (mul) determines the I2C baud rate. $\text{I2C baud rate} = \text{I2C module clock speed (Hz)} / (\text{mul} \times \text{SCL divider})$ |

Table continues on the next page...

I2Cx_F field descriptions (continued)

| Field | Description | | | | | | | | | | | | | | | | | | | | | | | | | | | | | | | | | |
|-------|--|-------|-----------|-----------------|--|--|-----|-----------|----------|----|-----|-------|-------|-------|----|-----|-------|-------|-------|----|-----|-------|-------|-------|----|-----|-------|-------|-------|----|-----|-------|-------|-------|
| | <p>The SDA hold time is the delay from the falling edge of SCL (I2C clock) to the changing of SDA (I2C data).</p> <p>SDA hold time = I2C module clock period (s) × mul × SDA hold value</p> <p>The SCL start hold time is the delay from the falling edge of SDA (I2C data) while SCL is high (start condition) to the falling edge of SCL (I2C clock).</p> <p>SCL start hold time = I2C module clock period (s) × mul × SCL start hold value</p> <p>The SCL stop hold time is the delay from the rising edge of SCL (I2C clock) to the rising edge of SDA (I2C data) while SCL is high (stop condition).</p> <p>SCL stop hold time = I2C module clock period (s) × mul × SCL stop hold value</p> <p>For example, if the I2C module clock speed is 8 MHz, the following table shows the possible hold time values with different ICR and MULT selections to achieve an I²C baud rate of 100 kbit/s.</p> <table border="1" style="margin-left: auto; margin-right: auto;"> <thead> <tr> <th rowspan="2">MULT</th> <th rowspan="2">ICR</th> <th colspan="3">Hold times (µs)</th> </tr> <tr> <th>SDA</th> <th>SCL Start</th> <th>SCL Stop</th> </tr> </thead> <tbody> <tr> <td>2h</td> <td>00h</td> <td>3.500</td> <td>3.000</td> <td>5.500</td> </tr> <tr> <td>1h</td> <td>07h</td> <td>2.500</td> <td>4.000</td> <td>5.250</td> </tr> <tr> <td>1h</td> <td>0Bh</td> <td>2.250</td> <td>4.000</td> <td>5.250</td> </tr> <tr> <td>0h</td> <td>14h</td> <td>2.125</td> <td>4.250</td> <td>5.125</td> </tr> <tr> <td>0h</td> <td>18h</td> <td>1.125</td> <td>4.750</td> <td>5.125</td> </tr> </tbody> </table> | MULT | ICR | Hold times (µs) | | | SDA | SCL Start | SCL Stop | 2h | 00h | 3.500 | 3.000 | 5.500 | 1h | 07h | 2.500 | 4.000 | 5.250 | 1h | 0Bh | 2.250 | 4.000 | 5.250 | 0h | 14h | 2.125 | 4.250 | 5.125 | 0h | 18h | 1.125 | 4.750 | 5.125 |
| MULT | ICR | | | Hold times (µs) | | | | | | | | | | | | | | | | | | | | | | | | | | | | | | |
| | | SDA | SCL Start | SCL Stop | | | | | | | | | | | | | | | | | | | | | | | | | | | | | | |
| 2h | 00h | 3.500 | 3.000 | 5.500 | | | | | | | | | | | | | | | | | | | | | | | | | | | | | | |
| 1h | 07h | 2.500 | 4.000 | 5.250 | | | | | | | | | | | | | | | | | | | | | | | | | | | | | | |
| 1h | 0Bh | 2.250 | 4.000 | 5.250 | | | | | | | | | | | | | | | | | | | | | | | | | | | | | | |
| 0h | 14h | 2.125 | 4.250 | 5.125 | | | | | | | | | | | | | | | | | | | | | | | | | | | | | | |
| 0h | 18h | 1.125 | 4.750 | 5.125 | | | | | | | | | | | | | | | | | | | | | | | | | | | | | | |

38.3.3 I2C Control Register 1 (I2Cx_C1)

Address: Base address + 2h offset

| Bit | 7 | 6 | 5 | 4 | 3 | 2 | 1 | 0 |
|-------|-------|-------|-----|----|------|------|------|-------|
| Read | IICEN | IICIE | MST | TX | TXAK | 0 | WUEN | DMAEN |
| Write | | | | | | RSTA | | |
| Reset | 0 | 0 | 0 | 0 | 0 | 0 | 0 | 0 |

I2Cx_C1 field descriptions

| Field | Description |
|------------|---|
| 7 IICEN | <p>I2C Enable</p> <p>Enables I2C module operation.</p> <p>0 Disabled</p> <p>1 Enabled</p> |
| 6 IICIE | <p>I2C Interrupt Enable</p> <p>Enables I2C interrupt requests.</p> |

Table continues on the next page...

I2Cx_C1 field descriptions (continued)

| Field | Description |
|------------|--|
| | 0 Disabled 1 Enabled |
| 5 MST | Master Mode Select When MST is changed from 0 to 1, a START signal is generated on the bus and master mode is selected. When this bit changes from 1 to 0, a STOP signal is generated and the mode of operation changes from master to slave. 0 Slave mode 1 Master mode |
| 4 TX | Transmit Mode Select Selects the direction of master and slave transfers. In master mode this bit must be set according to the type of transfer required. Therefore, for address cycles, this bit is always set. When addressed as a slave this bit must be set by software according to the SRW bit in the status register. 0 Receive 1 Transmit |
| 3 TXAK | Transmit Acknowledge Enable Specifies the value driven onto the SDA during data acknowledge cycles for both master and slave receivers. The value of SMB[FAACK] affects NACK/ACK generation. NOTE: SCL is held low until TXAK is written. 0 An acknowledge signal is sent to the bus on the following receiving byte (if FAACK is cleared) or the current receiving byte (if FAACK is set). 1 No acknowledge signal is sent to the bus on the following receiving data byte (if FAACK is cleared) or the current receiving data byte (if FAACK is set). |
| 2 RSTA | Repeat START Writing 1 to this bit generates a repeated START condition provided it is the current master. This bit will always be read as 0. Attempting a repeat at the wrong time results in loss of arbitration. |
| 1 WUEN | Wakeup Enable The I2C module can wake the MCU from low power mode with no peripheral bus running when slave address matching occurs. 0 Normal operation. No interrupt generated when address matching in low power mode. 1 Enables the wakeup function in low power mode. |
| 0 DMAEN | DMA Enable Enables or disables the DMA function. 0 All DMA signalling disabled. 1 DMA transfer is enabled. While SMB[FAACK] = 0, the following conditions trigger the DMA request: <ul style="list-style-type: none"> a data byte is received, and either address or data is transmitted. (ACK/NACK is automatic) the first byte received matches the A1 register or is a general call address. |

Table continues on the next page...

I2Cx_C1 field descriptions (continued)

| Field | Description |
|-------|---|
| | <p>If any address matching occurs, S[IAAS] and S[TCF] are set. If the direction of transfer is known from master to slave, then it is not required to check S[SRW]. With this assumption, DMA can also be used in this case. In other cases, if the master reads data from the slave, then it is required to rewrite the C1 register operation. With this assumption, DMA cannot be used.</p> <p>When FACK = 1, an address or a data byte is transmitted.</p> |

38.3.4 I2C Status register (I2Cx_S)

Address: Base address + 3h offset

| Bit | 7 | 6 | 5 | 4 | 3 | 2 | 1 | 0 |
|-------|-----|------|------|------|-----|-----|-------|------|
| Read | TCF | IAAS | BUSY | ARBL | RAM | SRW | IICIF | RXAK |
| Write | | | | w1c | | | w1c | |
| Reset | 1 | 0 | 0 | 0 | 0 | 0 | 0 | 0 |

I2Cx_S field descriptions

| Field | Description |
|-----------|--|
| 7 TCF | <p>Transfer Complete Flag</p> <p>Acknowledges a byte transfer; TCF is set on the completion of a byte transfer. This bit is valid only during or immediately following a transfer to or from the I2C module. TCF is cleared by reading the I2C data register in receive mode or by writing to the I2C data register in transmit mode.</p> <p>NOTE: In the buffer mode, TCF is cleared automatically by internal reading or writing the data register I2C_D, with no need waiting for manually reading/writing the I2C data register in Rx/Tx mode.</p> <p>0 Transfer in progress 1 Transfer complete</p> |
| 6 IAAS | <p>Addressed As A Slave</p> <p>This bit is set by one of the following conditions:</p> <ul style="list-style-type: none"> The calling address matches the programmed primary slave address in the A1 register, or matches the range address in the RA register (which must be set to a nonzero value and under the condition I2C_C2[RMEN] = 1). C2[GCAEN] is set and a general call is received. SMB[SICAEN] is set and the calling address matches the second programmed slave address. ALERTEN is set and an SMBus alert response address is received RMEN is set and an address is received that is within the range between the values of the A1 and RA registers. <p>IAAS sets before the ACK bit. The CPU must check the SRW bit and set TX/RX accordingly. Writing the C1 register with any value clears this bit.</p> <p>0 Not addressed 1 Addressed as a slave</p> |
| 5 BUSY | <p>Bus Busy</p> |

Table continues on the next page...

I2Cx_S field descriptions (continued)

| Field | Description |
|------------|--|
| | <p>Indicates the status of the bus regardless of slave or master mode. This bit is set when a START signal is detected and cleared when a STOP signal is detected.</p> <p>0 Bus is idle 1 Bus is busy</p> |
| 4 ARBL | <p>Arbitration Lost</p> <p>This bit is set by hardware when the arbitration procedure is lost. The ARBL bit must be cleared by software, by writing 1 to it.</p> <p>0 Standard bus operation. 1 Loss of arbitration.</p> |
| 3 RAM | <p>Range Address Match</p> <p>This bit is set to 1 by any of the following conditions, if I2C_C2[RMEN] = 1:</p> <ul style="list-style-type: none"> Any nonzero calling address is received that matches the address in the RA register. The calling address is within the range of values of the A1 and RA registers. <p>NOTE: For the RAM bit to be set to 1 correctly, C1[IICIE] must be set to 1.</p> <p>Writing the C1 register with any value clears this bit to 0.</p> <p>0 Not addressed 1 Addressed as a slave</p> |
| 2 SRW | <p>Slave Read/Write</p> <p>When addressed as a slave, SRW indicates the value of the R/W command bit of the calling address sent to the master.</p> <p>0 Slave receive, master writing to slave 1 Slave transmit, master reading from slave</p> |
| 1 IICIF | <p>Interrupt Flag</p> <p>This bit sets when an interrupt is pending. This bit must be cleared by software by writing 1 to it, such as in the interrupt routine. One of the following events can set this bit:</p> <ul style="list-style-type: none"> One byte transfer, including ACK/NACK bit, completes if FACK is 0. An ACK or NACK is sent on the bus by writing 0 or 1 to TXAK after this bit is set in receive mode. One byte transfer, excluding ACK/NACK bit, completes if FACK is 1. Match of slave address to calling address including primary slave address, range slave address, alert response address, second slave address, or general call address. Arbitration lost In SMBus mode, any timeouts except SCL and SDA high timeouts I2C bus stop or start detection if the SSIE bit in the Input Glitch Filter register is 1 <p>NOTE: To clear the I2C bus stop or start detection interrupt: In the interrupt service routine, first clear the STOPF or STARTF bit in the Input Glitch Filter register by writing 1 to it, and then clear the IICIF bit. If this sequence is reversed, the IICIF bit is asserted again.</p> <p>0 No interrupt pending 1 Interrupt pending</p> |
| 0 RXAK | <p>Receive Acknowledge</p> |

Table continues on the next page...

I2Cx_S field descriptions (continued)

| Field | Description |
|-------|--|
| 0 | Acknowledge signal was received after the completion of one byte of data transmission on the bus |
| 1 | No acknowledge signal detected |

38.3.5 I2C Data I/O register (I2Cx_D)

Address: Base address + 4h offset

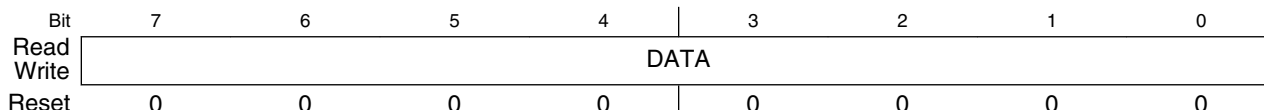

I2Cx_D field descriptions

| Field | Description |
|-------|---|
| DATA | <p>Data</p> <p>In master transmit mode, when data is written to this register, a data transfer is initiated. The most significant bit is sent first. In master receive mode, reading this register initiates receiving of the next byte of data.</p> <p>NOTE: When making the transition out of master receive mode, switch the I2C mode before reading the Data register to prevent an inadvertent initiation of a master receive data transfer.</p> <p>In slave mode, the same functions are available after an address match occurs.</p> <p>The C1[TX] bit must correctly reflect the desired direction of transfer in master and slave modes for the transmission to begin. For example, if the I2C module is configured for master transmit but a master receive is desired, reading the Data register does not initiate the receive.</p> <p>Reading the Data register returns the last byte received while the I2C module is configured in master receive or slave receive mode. The Data register does not reflect every byte that is transmitted on the I2C bus, and neither can software verify that a byte has been written to the Data register correctly by reading it back.</p> <p>In master transmit mode, the first byte of data written to the Data register following assertion of MST (start bit) or assertion of RSTA (repeated start bit) is used for the address transfer and must consist of the calling address (in bits 7-1) concatenated with the required R/W bit (in position bit 0).</p> |

38.3.6 I2C Control Register 2 (I2Cx_C2)

Address: Base address + 5h offset

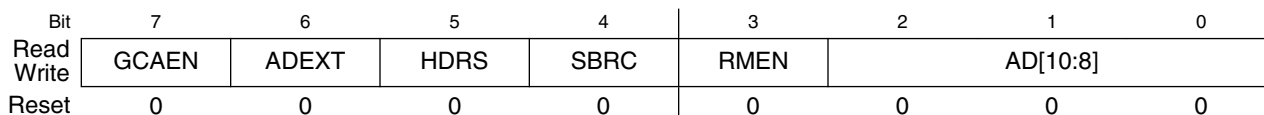

I2Cx_C2 field descriptions

| Field | Description |
|------------|--|
| 7 GCAEN | General Call Address Enable Enables general call address. 0 Disabled 1 Enabled |
| 6 ADEXT | Address Extension Controls the number of bits used for the slave address. 0 7-bit address scheme 1 10-bit address scheme |
| 5 HDRS | High Drive Select Controls the drive capability of the I2C pads. 0 Normal drive mode 1 High drive mode |
| 4 SBRC | Slave Baud Rate Control Enables independent slave mode baud rate at maximum frequency, which forces clock stretching on SCL in very fast I2C modes. To a slave, an example of a "very fast" mode is when the master transfers at 40 kbit/s but the slave can capture the master's data at only 10 kbit/s. 0 The slave baud rate follows the master baud rate and clock stretching may occur 1 Slave baud rate is independent of the master baud rate |
| 3 RMEN | Range Address Matching Enable This bit controls the slave address matching for addresses between the values of the A1 and RA registers. When this bit is set, a slave address matching occurs for any address greater than the value of the A1 register and less than or equal to the value of the RA register. 0 Range mode disabled. No address matching occurs for an address within the range of values of the A1 and RA registers. 1 Range mode enabled. Address matching occurs when a slave receives an address within the range of values of the A1 and RA registers. |
| AD[10:8] | Slave Address Contains the upper three bits of the slave address in the 10-bit address scheme. This field is valid only while the ADEXT bit is set. |

38.3.7 I2C Programmable Input Glitch Filter Register (I2Cx_FLT)

Address: Base address + 6h offset

| Bit | 7 | 6 | 5 | 4 | 3 | 2 | 1 | 0 |
|-------|------|-------|------|--------|-----|---|---|---|
| Read | SHEN | STOPF | SSIE | STARTF | FLT | | | |
| Write | | w1c | | w1c | | | | |
| Reset | 0 | 0 | 0 | 0 | 0 | 0 | 0 | 0 |

I2Cx_FLT field descriptions

| Field | Description |
|-------------|---|
| 7 SHEN | <p>Stop Hold Enable</p> <p>Set this bit to hold off entry to stop mode when any data transmission or reception is occurring. The following scenario explains the holdoff functionality:</p> <ol style="list-style-type: none"> 1. The I2C module is configured for a basic transfer, and the SHEN bit is set to 1. 2. A transfer begins. 3. The MCU signals the I2C module to enter stop mode. 4. The byte currently being transferred, including both address and data, completes its transfer. 5. The I2C slave or master acknowledges that the in-transfer byte completed its transfer and acknowledges the request to enter stop mode. 6. After receiving the I2C module's acknowledgment of the request to enter stop mode, the MCU determines whether to shut off the I2C module's clock. <p>If the SHEN bit is set to 1 and the I2C module is in an idle or disabled state when the MCU signals to enter stop mode, the module immediately acknowledges the request to enter stop mode.</p> <p>If SHEN is cleared to 0 and the overall data transmission or reception that was suspended by stop mode entry was incomplete: To resume the overall transmission or reception after the MCU exits stop mode, software must reinitialize the transfer by resending the address of the slave.</p> <p>If the I2C Control Register 1's IICIE bit was set to 1 before the MCU entered stop mode, system software will receive the interrupt triggered by the I2C Status Register's TCF bit after the MCU wakes from the stop mode.</p> <p>0 Stop holdoff is disabled. The MCU's entry to stop mode is not gated. 1 Stop holdoff is enabled.</p> |
| 6 STOPF | <p>I2C Bus Stop Detect Flag</p> <p>Hardware sets this bit when the I2C bus's stop status is detected. The STOPF bit must be cleared by writing 1 to it.</p> <p>NOTE: The stop flag is only for the matched slave devices, therefore the master will not respond for it.</p> <p>0 No stop happens on I2C bus 1 Stop detected on I2C bus</p> |
| 5 SSIE | <p>I2C Bus Stop or Start Interrupt Enable</p> <p>This bit enables the interrupt for I2C bus stop or start detection.</p> <p>NOTE: To clear the I2C bus stop or start detection interrupt: In the interrupt service routine, first clear the STOPF or STARTF bit by writing 1 to it, and then clear the IICIF bit in the status register. If this sequence is reversed, the IICIF bit is asserted again.</p> <p>0 Stop or start detection interrupt is disabled 1 Stop or start detection interrupt is enabled</p> |
| 4 STARTF | <p>I2C Bus Start Detect Flag</p> <p>Hardware sets this bit when the I2C bus's start status is detected. The STARTF bit must be cleared by writing 1 to it.</p> <p>0 No start happens on I2C bus 1 Start detected on I2C bus</p> |
| FLT | I2C Programmable Filter Factor |

Table continues on the next page...

I2Cx_FLT field descriptions (continued)

| Field | Description |
|-------|--|
| | Controls the width of the glitch, in terms of I2C module clock cycles, that the filter must absorb. For any glitch whose size is less than or equal to this width setting, the filter does not allow the glitch to pass. |
| 0h | No filter/bypass |
| 1-Fh | Filter glitches up to width of n I2C module clock cycles, where $n=1-15d$ |

38.3.8 I2C Range Address register (I2Cx_RA)

Address: Base address + 7h offset

| Bit | 7 | 6 | 5 | 4 | 3 | 2 | 1 | 0 |
|-------|-----|---|---|---|---|---|---|---|
| Read | RAD | | | | | | | 0 |
| Write | RAD | | | | | | | 0 |
| Reset | 0 | 0 | 0 | 0 | 0 | 0 | 0 | 0 |

I2Cx_RA field descriptions

| Field | Description |
|---------------|---|
| 7-1 RAD | Range Slave Address This field contains the slave address to be used by the I2C module. The field is used in the 7-bit address scheme. If I2C_C2[RMEN] is set to 1, any nonzero value write enables this register. This register value can be considered as a maximum boundary in the range matching mode. |
| 0 Reserved | This field is reserved. This read-only field is reserved and always has the value 0. |

38.3.9 I2C SMBus Control and Status register (I2Cx_SMB)**NOTE**

When the SCL and SDA signals are held high for a length of time greater than the high timeout period, the SHTF1 flag sets. Before reaching this threshold, while the system is detecting how long these signals are being held high, a master assumes that the bus is free. However, the SHTF1 bit is set to 1 in the bus transmission process with the idle bus state.

NOTE

When the TCKSEL bit is set, there is no need to monitor the SHTF1 bit because the bus speed is too high to match the protocol of SMBus.

Memory map/register definition

Address: Base address + 8h offset

| Bit | 7 | 6 | 5 | 4 | 3 | 2 | 1 | 0 |
|-------|-------|---------|---------|--------|------|-------|-------|---------|
| Read | FA CK | ALERTEN | SIICAEN | TCKSEL | SLTF | SHTF1 | SHTF2 | SHTF2IE |
| Write | | | | | w1c | | w1c | |
| Reset | 0 | 0 | 0 | 0 | 0 | 0 | 0 | 0 |

I2Cx_SMB field descriptions

| Field | Description |
|--------------|--|
| 7 FA CK | <p>Fast NACK/ACK Enable</p> <p>For SMBus packet error checking, the CPU must be able to issue an ACK or NACK according to the result of receiving data byte.</p> <p>0 An ACK or NACK is sent on the following receiving data byte 1 Writing 0 to TXAK after receiving a data byte generates an ACK. Writing 1 to TXAK after receiving a data byte generates a NACK.</p> <p>NOTE: Enable I2C_S2[DFEN] in the master receive mode.</p> |
| 6 ALERTEN | <p>SMBus Alert Response Address Enable</p> <p>Enables or disables SMBus alert response address matching.</p> <p>NOTE: After the host responds to a device that used the alert response address, you must use software to put the device's address on the bus. The alert protocol is described in the SMBus specification.</p> <p>0 SMBus alert response address matching is disabled 1 SMBus alert response address matching is enabled</p> |
| 5 SIICAEN | <p>Second I2C Address Enable</p> <p>Enables or disables SMBus device default address.</p> <p>0 I2C address register 2 matching is disabled 1 I2C address register 2 matching is enabled</p> |
| 4 TCKSEL | <p>Timeout Counter Clock Select</p> <p>Selects the clock source of the timeout counter.</p> <p>0 Timeout counter counts at the frequency of the I2C module clock / 64 1 Timeout counter counts at the frequency of the I2C module clock</p> |
| 3 SLTF | <p>SCL Low Timeout Flag</p> <p>This bit is set when the SLT register (consisting of the SLTH and SLTL registers) is loaded with a non-zero value (LoValue) and an SCL low timeout occurs. Software clears this bit by writing a logic 1 to it.</p> <p>NOTE: The low timeout function is disabled when the SLT register's value is 0.</p> <p>0 No low timeout occurs 1 Low timeout occurs</p> |
| 2 SHTF1 | <p>SCL High Timeout Flag 1</p> <p>This read-only bit sets when SCL and SDA are held high more than clock × LoValue / 512, which indicates the bus is free. This bit is cleared automatically.</p> |

Table continues on the next page...

I2Cx_SMB field descriptions (continued)

| Field | Description |
|--------------|---|
| | 0 No SCL high and SDA high timeout occurs 1 SCL high and SDA high timeout occurs |
| 1 SHTF2 | SCL High Timeout Flag 2 This bit sets when SCL is held high and SDA is held low more than $\text{clock} \times \text{LoValue} / 512$. Software clears this bit by writing 1 to it. 0 No SCL high and SDA low timeout occurs 1 SCL high and SDA low timeout occurs |
| 0 SHTF2IE | SHTF2 Interrupt Enable Enables SCL high and SDA low timeout interrupt. 0 SHTF2 interrupt is disabled 1 SHTF2 interrupt is enabled |

38.3.10 I2C Address Register 2 (I2Cx_A2)

Address: Base address + 9h offset

| Bit | 7 | 6 | 5 | 4 | 3 | 2 | 1 | 0 |
|-------|-----|---|---|---|---|---|---|---|
| Read | SAD | | | | | | | 0 |
| Write | SAD | | | | | | | 0 |
| Reset | 1 | 1 | 0 | 0 | 0 | 0 | 1 | 0 |

I2Cx_A2 field descriptions

| Field | Description |
|---------------|---|
| 7–1 SAD | SMBus Address Contains the slave address used by the SMBus. This field is used on the device default address or other related addresses. |
| 0 Reserved | This field is reserved. This read-only field is reserved and always has the value 0. |

38.3.11 I2C SCL Low Timeout Register High (I2Cx_SLTH)

Address: Base address + Ah offset

| Bit | 7 | 6 | 5 | 4 | 3 | 2 | 1 | 0 |
|-------|------------|---|---|---|---|---|---|---|
| Read | SSLT[15:8] | | | | | | | |
| Write | SSLT[15:8] | | | | | | | |
| Reset | 0 | 0 | 0 | 0 | 0 | 0 | 0 | 0 |

I2Cx_SLTH field descriptions

| Field | Description |
|------------|---|
| SSLT[15:8] | SSLT[15:8] Most significant byte of SCL low timeout value that determines the timeout period of SCL low. |

38.3.12 I2C SCL Low Timeout Register Low (I2Cx_SLTL)

Address: Base address + Bh offset

| | | | | | | | | |
|-------|-----------|---|---|---|---|---|---|---|
| Bit | 7 | 6 | 5 | 4 | 3 | 2 | 1 | 0 |
| Read | SSLT[7:0] | | | | | | | |
| Write | SSLT[7:0] | | | | | | | |
| Reset | 0 | 0 | 0 | 0 | 0 | 0 | 0 | 0 |

I2Cx_SLTL field descriptions

| Field | Description |
|-----------|---|
| SSLT[7:0] | SSLT[7:0] Least significant byte of SCL low timeout value that determines the timeout period of SCL low. |

38.3.13 I2C Status register 2 (I2Cx_S2)

Address: Base address + Ch offset

| | | | | | | | | |
|-------|---|---|---|---|---|------|-------|-------|
| Bit | 7 | 6 | 5 | 4 | 3 | 2 | 1 | 0 |
| Read | 0 | 0 | 0 | 0 | 0 | DFEN | ERROR | EMPTY |
| Write | | | | | | | | w1c |
| Reset | 0 | 0 | 0 | 0 | 0 | 0 | 0 | 1 |

I2Cx_S2 field descriptions

| Field | Description |
|---------------|---|
| 7 Reserved | This field is reserved. This read-only field is reserved and always has the value 0. |
| 6 Reserved | This field is reserved. This read-only field is reserved and always has the value 0. |
| 5 Reserved | This field is reserved. This read-only field is reserved and always has the value 0. |
| 4 Reserved | This field is reserved. This read-only field is reserved and always has the value 0. |
| 3 Reserved | This field is reserved. This read-only field is reserved and always has the value 0. |
| 2 DFEN | Double Buffer Enable |

Table continues on the next page...

I2Cx_S2 field descriptions (continued)

| Field | Description |
|------------|--|
| | Enables or disables the double buffer mode. In the double buffer mode, the clock stretch is disabled. 0 Disables the double buffer mode; clock stretch is enabled. 1 Enables the double buffer mode; clock stretch is disabled. In the slave mode, the I2C will not hold bus between data transfers. |
| 1 ERROR | Error flag Indicates if there are read or write errors with the Tx and Rx buffers. 0 The buffer is not full and all write/read operations have no errors. 1 There are 3 or more write/read errors during the data transfer phase (when the Empty flag is not set and the buffer is busy). |
| 0 EMPTY | Empty flag Indicates if the Tx or Rx buffer is empty. 0 Tx or Rx buffer is not empty and cannot be written to, that is new data cannot be loaded into the buffer. 1 Tx or Rx buffer is empty and can be written to, that is new data can be loaded into the buffer. |

38.4 Functional description

This section provides a comprehensive functional description of the I2C module.

38.4.1 I2C protocol

The I2C bus system uses a serial data line (SDA) and a serial clock line (SCL) for data transfers.

All devices connected to it must have open drain or open collector outputs. A logic AND function is exercised on both lines with external pull-up resistors. The value of these resistors depends on the system.

Normally, a standard instance of communication is composed of four parts:

1. START signal
2. Slave address transmission
3. Data transfer
4. STOP signal

The STOP signal should not be confused with the CPU STOP instruction. The following figure illustrates I2C bus system communication.

Functional description

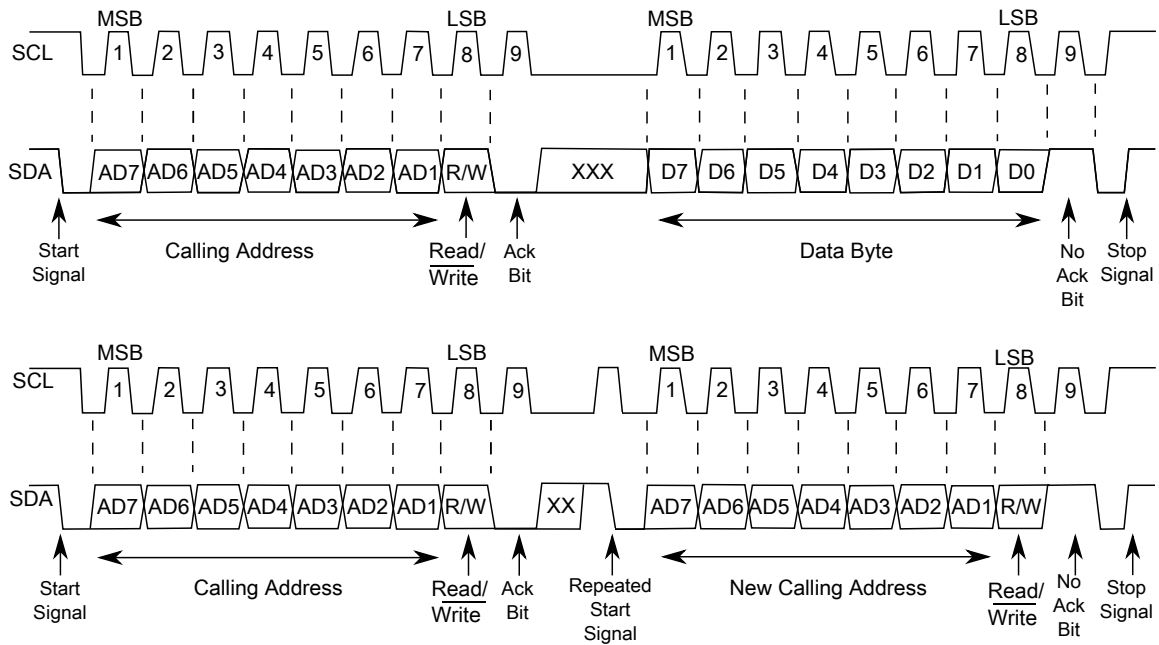

Figure 38-2. I2C bus transmission signals

38.4.1.1 START signal

The bus is free when no master device is engaging the bus (both SCL and SDA are high). When the bus is free, a master may initiate communication by sending a START signal. A START signal is defined as a high-to-low transition of SDA while SCL is high. This signal denotes the beginning of a new data transfer—each data transfer might contain several bytes of data—and brings all slaves out of their idle states.

38.4.1.2 Slave address transmission

Immediately after the START signal, the first byte of a data transfer is the slave address transmitted by the master. This address is a 7-bit calling address followed by an R/\overline{W} bit. The R/\overline{W} bit tells the slave the desired direction of data transfer.

- 1 = Read transfer: The slave transmits data to the master
- 0 = Write transfer: The master transmits data to the slave

Only the slave with a calling address that matches the one transmitted by the master responds by sending an acknowledge bit. The slave sends the acknowledge bit by pulling SDA low at the ninth clock.

No two slaves in the system can have the same address. If the I2C module is the master, it must not transmit an address that is equal to its own slave address. The I2C module cannot be master and slave at the same time. However, if arbitration is lost during an address cycle, the I2C module reverts to slave mode and operates correctly even if it is being addressed by another master.

38.4.1.3 Data transfers

When successful slave addressing is achieved, data transfer can proceed on a byte-by-byte basis in the direction specified by the $\overline{R/W}$ bit sent by the calling master.

All transfers that follow an address cycle are referred to as data transfers, even if they carry subaddress information for the slave device.

Each data byte is 8 bits long. Data may be changed only while SCL is low. Data must be held stable while SCL is high. There is one clock pulse on SCL for each data bit, and the MSB is transferred first. Each data byte is followed by a ninth (acknowledge) bit, which is signaled from the receiving device by pulling SDA low at the ninth clock. In summary, one complete data transfer needs nine clock pulses.

If the slave receiver does not acknowledge the master in the ninth bit, the slave must leave SDA high. The master interprets the failed acknowledgement as an unsuccessful data transfer.

If the master receiver does not acknowledge the slave transmitter after a data byte transmission, the slave interprets it as an end to data transfer and releases the SDA line.

In the case of a failed acknowledgement by either the slave or master, the data transfer is aborted and the master does one of two things:

- Relinquishes the bus by generating a STOP signal.
- Commences a new call by generating a repeated START signal.

38.4.1.4 STOP signal

The master can terminate the communication by generating a STOP signal to free the bus. A STOP signal is defined as a low-to-high transition of SDA while SCL is asserted.

38.4.1.5 Repeated START signal

The master may generate a START signal followed by a calling command without generating a STOP signal first. This action is called a repeated START. The master uses a repeated START to communicate with another slave or with the same slave in a different mode (transmit/receive mode) without releasing the bus. The master needs to send a NACK signal before sending repeated-START in the buffering mode.

38.4.1.6 Arbitration procedure

The I2C bus is a true multimaster bus that allows more than one master to be connected on it.

If two or more masters try to control the bus at the same time, a clock synchronization procedure determines the bus clock. The bus clock's low period is equal to the longest clock low period, and the high period is equal to the shortest one among the masters.

The relative priority of the contending masters is determined by a data arbitration procedure. A bus master loses arbitration if it transmits logic level 1 while another master transmits logic level 0. The losing masters immediately switch to slave receive mode and stop driving SDA output. In this case, the transition from master to slave mode does not generate a STOP condition. Meanwhile, hardware sets a status bit to indicate the loss of arbitration.

38.4.1.7 Clock synchronization

Because wire AND logic is performed on SCL, a high-to-low transition on SCL affects all devices connected on the bus. The devices start counting their low period and, after a device's clock has gone low, that device holds SCL low until the clock reaches its high state. However, the change of low to high in this device clock might not change the state of SCL if another device clock is still within its low period. Therefore, the synchronized clock SCL is held low by the device with the longest low period. Devices with shorter low periods enter a high wait state during this time; see the following diagram. When all applicable devices have counted off their low period, the synchronized clock SCL is released and pulled high. Afterward there is no difference between the device clocks and the state of SCL, and all devices start counting their high periods. The first device to complete its high period pulls SCL low again.

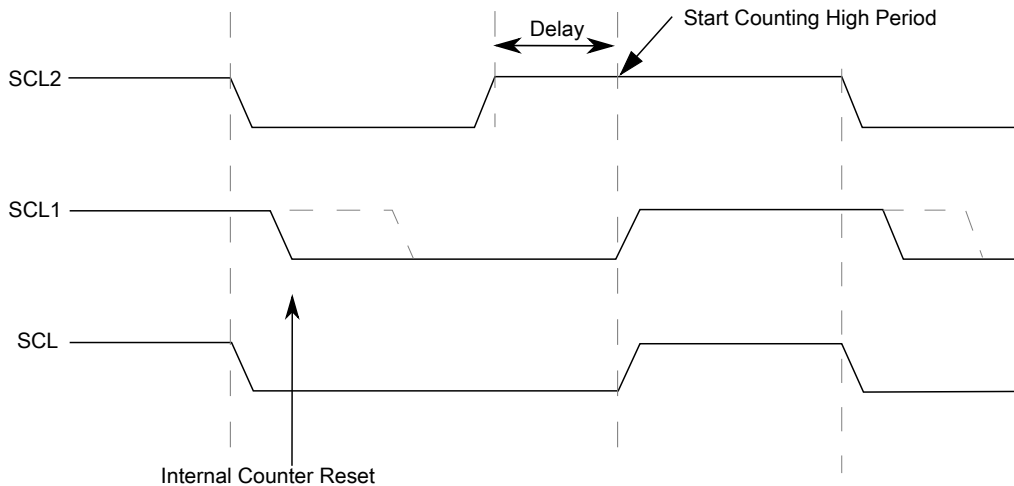

Figure 38-3. I2C clock synchronization

38.4.1.8 Handshaking

The clock synchronization mechanism can be used as a handshake in data transfers. A slave device may hold SCL low after completing a single byte transfer (9 bits). In this case, it halts the bus clock and forces the master clock into wait states until the slave releases SCL.

38.4.1.9 Clock stretching

The clock synchronization mechanism can be used by slaves to slow down the bit rate of a transfer. After the master drives SCL low, a slave can drive SCL low for the required period and then release it. If the slave's SCL low period is greater than the master's SCL low period, the resulting SCL bus signal's low period is stretched. In other words, the SCL bus signal's low period is increased to be the same length as the slave's SCL low period.

38.4.1.10 I2C divider and hold values

NOTE

For some cases on some devices, the SCL divider value may vary by ± 2 or ± 4 when ICR's value ranges from 00h to 0Fh. These potentially varying SCL divider values are highlighted in the following table.

Table 38-2. I2C divider and hold values

| ICR (hex) | SCL divider | SDA hold value | SCL hold (start) value | SCL hold (stop) value | ICR (hex) | SCL divider (clocks) | SDA hold (clocks) | SCL hold (start) value | SCL hold (stop) value |
|-----------|-------------|----------------|------------------------|-----------------------|-----------|----------------------|-------------------|------------------------|-----------------------|
| 00 | 20 | 7 | 6 | 11 | 20 | 160 | 17 | 78 | 81 |
| 01 | 22 | 7 | 7 | 12 | 21 | 192 | 17 | 94 | 97 |
| 02 | 24 | 8 | 8 | 13 | 22 | 224 | 33 | 110 | 113 |
| 03 | 26 | 8 | 9 | 14 | 23 | 256 | 33 | 126 | 129 |
| 04 | 28 | 9 | 10 | 15 | 24 | 288 | 49 | 142 | 145 |
| 05 | 30 | 9 | 11 | 16 | 25 | 320 | 49 | 158 | 161 |
| 06 | 34 | 10 | 13 | 18 | 26 | 384 | 65 | 190 | 193 |
| 07 | 40 | 10 | 16 | 21 | 27 | 480 | 65 | 238 | 241 |
| 08 | 28 | 7 | 10 | 15 | 28 | 320 | 33 | 158 | 161 |
| 09 | 32 | 7 | 12 | 17 | 29 | 384 | 33 | 190 | 193 |
| 0A | 36 | 9 | 14 | 19 | 2A | 448 | 65 | 222 | 225 |
| 0B | 40 | 9 | 16 | 21 | 2B | 512 | 65 | 254 | 257 |
| 0C | 44 | 11 | 18 | 23 | 2C | 576 | 97 | 286 | 289 |
| 0D | 48 | 11 | 20 | 25 | 2D | 640 | 97 | 318 | 321 |
| 0E | 56 | 13 | 24 | 29 | 2E | 768 | 129 | 382 | 385 |
| 0F | 68 | 13 | 30 | 35 | 2F | 960 | 129 | 478 | 481 |
| 10 | 48 | 9 | 18 | 25 | 30 | 640 | 65 | 318 | 321 |
| 11 | 56 | 9 | 22 | 29 | 31 | 768 | 65 | 382 | 385 |
| 12 | 64 | 13 | 26 | 33 | 32 | 896 | 129 | 446 | 449 |
| 13 | 72 | 13 | 30 | 37 | 33 | 1024 | 129 | 510 | 513 |
| 14 | 80 | 17 | 34 | 41 | 34 | 1152 | 193 | 574 | 577 |
| 15 | 88 | 17 | 38 | 45 | 35 | 1280 | 193 | 638 | 641 |
| 16 | 104 | 21 | 46 | 53 | 36 | 1536 | 257 | 766 | 769 |
| 17 | 128 | 21 | 58 | 65 | 37 | 1920 | 257 | 958 | 961 |
| 18 | 80 | 9 | 38 | 41 | 38 | 1280 | 129 | 638 | 641 |
| 19 | 96 | 9 | 46 | 49 | 39 | 1536 | 129 | 766 | 769 |
| 1A | 112 | 17 | 54 | 57 | 3A | 1792 | 257 | 894 | 897 |
| 1B | 128 | 17 | 62 | 65 | 3B | 2048 | 257 | 1022 | 1025 |
| 1C | 144 | 25 | 70 | 73 | 3C | 2304 | 385 | 1150 | 1153 |
| 1D | 160 | 25 | 78 | 81 | 3D | 2560 | 385 | 1278 | 1281 |
| 1E | 192 | 33 | 94 | 97 | 3E | 3072 | 513 | 1534 | 1537 |
| 1F | 240 | 33 | 118 | 121 | 3F | 3840 | 513 | 1918 | 1921 |

38.4.2 10-bit address

For 10-bit addressing, 0x11110 is used for the first 5 bits of the first address byte. Various combinations of read/write formats are possible within a transfer that includes 10-bit addressing.

38.4.2.1 Master-transmitter addresses a slave-receiver

The transfer direction is not changed. When a 10-bit address follows a START condition, each slave compares the first 7 bits of the first byte of the slave address (11110XX) with its own address and tests whether the eighth bit (R/\overline{W} direction bit) is 0. It is possible that more than one device finds a match and generates an acknowledge (A1). Each slave that finds a match compares the 8 bits of the second byte of the slave address with its own address, but only one slave finds a match and generates an acknowledge (A2). The matching slave remains addressed by the master until it receives a STOP condition (P) or a repeated START condition (Sr) followed by a different slave address.

Table 38-3. Master-transmitter addresses slave-receiver with a 10-bit address

| | | | | | | | | | | | |
|---|--|----------|----|--------------------------------------|----|------|---|-----|------|-----|---|
| S | Slave address first 7 bits 11110 + AD10 + AD9 | R/W 0 | A1 | Slave address second byte AD[8:1] | A2 | Data | A | ... | Data | A/A | P |
|---|--|----------|----|--------------------------------------|----|------|---|-----|------|-----|---|

After the master-transmitter has sent the first byte of the 10-bit address, the slave-receiver sees an I2C interrupt. User software must ensure that for this interrupt, the contents of the Data register are ignored and not treated as valid data.

38.4.2.2 Master-receiver addresses a slave-transmitter

The transfer direction is changed after the second R/\overline{W} bit. Up to and including acknowledge bit A2, the procedure is the same as that described for a master-transmitter addressing a slave-receiver. After the repeated START condition (Sr), a matching slave remembers that it was addressed before. This slave then checks whether the first seven bits of the first byte of the slave address following Sr are the same as they were after the START condition (S), and it tests whether the eighth (R/\overline{W}) bit is 1. If there is a match, the slave considers that it has been addressed as a transmitter and generates acknowledge A3. The slave-transmitter remains addressed until it receives a STOP condition (P) or a repeated START condition (Sr) followed by a different slave address.

After a repeated START condition (Sr), all other slave devices also compare the first seven bits of the first byte of the slave address with their own addresses and test the eighth (R/\overline{W}) bit. However, none of them are addressed because $R/\overline{W} = 1$ (for 10-bit devices), or the 11110XX slave address (for 7-bit devices) does not match.

Table 38-4. Master-receiver addresses a slave-transmitter with a 10-bit address

| | | | | | | | | | | | | | | | |
|---|--|------------------------|----|--------------------------------------|----|----|--|------------------------|----|------|---|-----|------|---|---|
| S | Slave address first 7 bits 11110 + AD10 + AD9 | R/ \overline{W} 0 | A1 | Slave address second byte AD[8:1] | A2 | Sr | Slave address first 7 bits 11110 + AD10 + AD9 | R/ \overline{W} 1 | A3 | Data | A | ... | Data | A | P |
|---|--|------------------------|----|--------------------------------------|----|----|--|------------------------|----|------|---|-----|------|---|---|

After the master-receiver has sent the first byte of the 10-bit address, the slave-transmitter sees an I2C interrupt. User software must ensure that for this interrupt, the contents of the Data register are ignored and not treated as valid data.

38.4.3 Address matching

All received addresses can be requested in 7-bit or 10-bit address format.

- AD[7:1] in Address Register 1, which contains the I2C primary slave address, always participates in the address matching process. It provides a 7-bit address.
- If the ADEXT bit is set, AD[10:8] in Control Register 2 participates in the address matching process. It extends the I2C primary slave address to a 10-bit address.

Additional conditions that affect address matching include:

- If the GCAEN bit is set, general call participates the address matching process.
- If the ALERTEN bit is set, alert response participates the address matching process.
- If the SIICAEN bit is set, Address Register 2 participates in the address matching process.
- If the RMEN bit is set, when the Range Address register is programmed to a nonzero value, any address within the range of values of Address Register 1 (excluded) and the Range Address register (included) participates in the address matching process. The Range Address register must be programmed to a value greater than the value of Address Register 1.

When the I2C module responds to one of these addresses, it acts as a slave-receiver and the IAAS bit is set after the address cycle. Software must read the Data register after the first byte transfer to determine that the address is matched.

38.4.4 System management bus specification

SMBus provides a control bus for system and power management related tasks. A system can use SMBus to pass messages to and from devices instead of tripping individual control lines.

Removing the individual control lines reduces pin count. Accepting messages ensures future expandability. With the system management bus, a device can provide manufacturer information, tell the system what its model/part number is, save its state for a suspend event, report different types of errors, accept control parameters, and return its status.

38.4.4.1 Timeouts

The $T_{\text{TIMEOUT,MIN}}$ parameter allows a master or slave to conclude that a defective device is holding the clock low indefinitely or a master is intentionally trying to drive devices off the bus. The slave device must release the bus (stop driving the bus and let SCL and SDA float high) when it detects any single clock held low longer than $T_{\text{TIMEOUT,MIN}}$. Devices that have detected this condition must reset their communication and be able to receive a new START condition within the timeframe of $T_{\text{TIMEOUT,MAX}}$.

SMBus defines a clock low timeout, T_{TIMEOUT} , of 35 ms, specifies $T_{\text{LOW:SEXT}}$ as the cumulative clock low extend time for a slave device, and specifies $T_{\text{LOW:MEXT}}$ as the cumulative clock low extend time for a master device.

38.4.4.1.1 SCL low timeout

If the SCL line is held low by a slave device on the bus, no further communication is possible. Furthermore, the master cannot force the SCL line high to correct the error condition. To solve this problem, the SMBus protocol specifies that devices participating in a transfer must detect any clock cycle held low longer than a timeout value condition. Devices that have detected the timeout condition must reset the communication. When the I2C module is an active master, if it detects that SMBCLK low has exceeded the value of $T_{\text{TIMEOUT,MIN}}$, it must generate a stop condition within or after the current data byte in the transfer process. When the I2C module is a slave, if it detects the $T_{\text{TIMEOUT,MIN}}$ condition, it resets its communication and is then able to receive a new START condition.

38.4.4.1.2 SCL high timeout

When the I2C module has determined that the SMBCLK and SMBDAT signals have been high for at least $T_{HIGH:MAX}$, it assumes that the bus is idle.

A HIGH timeout occurs after a START condition appears on the bus but before a STOP condition appears on the bus. Any master detecting this scenario can assume the bus is free when either of the following occurs:

- SHTF1 rises.
- The BUSY bit is high and SHTF1 is high.

When the SMBDAT signal is low and the SMBCLK signal is high for a period of time, another kind of timeout occurs. The time period must be defined in software. SHTF2 is used as the flag when the time limit is reached. This flag is also an interrupt resource, so it triggers IICIF.

38.4.4.1.3 CSMBCLK TIMEOUT MEXT and CSMBCLK TIMEOUT SEXT

The following figure illustrates the definition of the timeout intervals $T_{LOW:SEXT}$ and $T_{LOW:MEXT}$. When in master mode, the I2C module must not cumulatively extend its clock cycles for a period greater than $T_{LOW:MEXT}$ within a byte, where each byte is defined as START-to-ACK, ACK-to-ACK, or ACK-to-STOP. When CSMBCLK TIMEOUT MEXT occurs, SMBus MEXT rises and also triggers the SLTF.

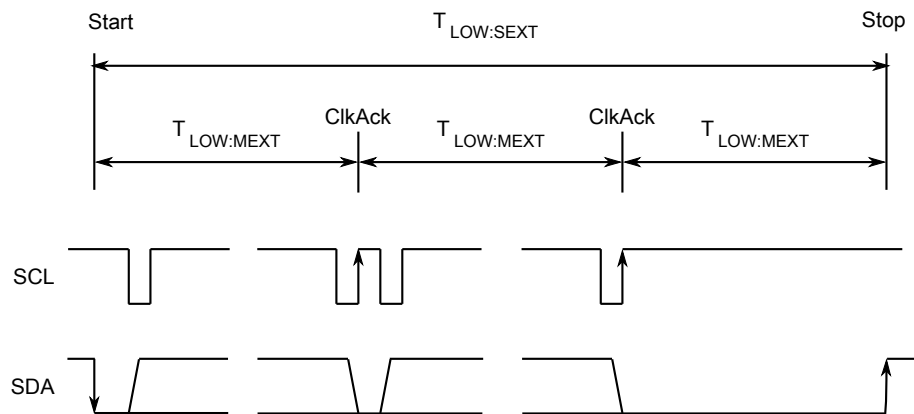

Figure 38-4. Timeout measurement intervals

A master is allowed to abort the transaction in progress to any slave that violates the $T_{LOW:SEXT}$ or $T_{TIMEOUT,MIN}$ specifications. To abort the transaction, the master issues a STOP condition at the conclusion of the byte transfer in progress. When a slave, the I2C module must not cumulatively extend its clock cycles for a period greater than $T_{LOW:SEXT}$ during any message from the initial START to the STOP. When CSMBCLK TIMEOUT SEXT occurs, SEXT rises and also triggers SLTF.

NOTE

CSMBCLK TIMEOUT SEXT and CSMBCLK TIMEOUT MEXT are optional functions that are implemented in the second step.

38.4.4.2 FAST ACK and NACK

To improve reliability and communication robustness, implementation of packet error checking (PEC) by SMBus devices is optional for SMBus devices but required for devices participating in and only during the address resolution protocol (ARP) process. The PEC is a CRC-8 error checking byte, calculated on all the message bytes. The PEC is appended to the message by the device that supplied the last data byte. If the PEC is present but not correct, a NACK is issued by the receiver. Otherwise an ACK is issued. To calculate the CRC-8 by software, this module can hold the SCL line low after receiving the eighth SCL (8th bit) if this byte is a data byte. So software can determine whether an ACK or NACK should be sent to the bus by setting or clearing the TXAK bit if the FACK (fast ACK/NACK enable) bit is enabled.

SMBus requires a device always to acknowledge its own address, as a mechanism to detect the presence of a removable device (such as a battery or docking station) on the bus. In addition to indicating a slave device busy condition, SMBus uses the NACK mechanism to indicate the reception of an invalid command or invalid data. Because such a condition may occur on the last byte of the transfer, SMBus devices are required to have the ability to generate the not acknowledge after the transfer of each byte and before the completion of the transaction. This requirement is important because SMBus does not provide any other resend signaling. This difference in the use of the NACK signaling has implications on the specific implementation of the SMBus port, especially in devices that handle critical system data such as the SMBus host and the SBS components.

NOTE

In the last byte of master receive slave transmit mode, the master must send a NACK to the bus, so FACK must be switched off before the last byte transmits.

38.4.5 Resets

The I2C module is disabled after a reset. The I2C module cannot cause a core reset.

38.4.6 Interrupts

The I2C module generates an interrupt when any of the events in the table found here occur, provided that the IICIE bit is set.

The interrupt is driven by the IICIF bit (of the I2C Status Register) and masked with the IICIE bit (of the I2C Control Register 1). The IICIF bit must be cleared (by software) by writing 1 to it in the interrupt routine. The SMBus timeouts interrupt is driven by SLTF and masked with the IICIE bit. The SLTF bit must be cleared by software by writing 1 to it in the interrupt routine. You can determine the interrupt type by reading the Status Register.

NOTE

In master receive mode, the FACK bit must be set to zero before the last byte transfer.

Table 38-5. Interrupt summary

| Interrupt source | Status | Flag | Local enable |
|--------------------------------------|--------|-------|-----------------|
| Complete 1-byte transfer | TCF | IICIF | IICIE |
| Match of received calling address | IAAS | IICIF | IICIE |
| Arbitration lost | ARBL | IICIF | IICIE |
| I ² C bus stop detection | STOPF | IICIF | IICIE & SSIE |
| I ² C bus start detection | STARTF | IICIF | IICIE & SSIE |
| SMBus SCL low timeout | SLTF | IICIF | IICIE |
| SMBus SCL high SDA low timeout | SHTF2 | IICIF | IICIE & SHTF2IE |
| Wakeup from stop or wait mode | IAAS | IICIF | IICIE & WUEN |

38.4.6.1 Byte transfer interrupt

The Transfer Complete Flag (TCF) bit is set at the falling edge of the ninth clock to indicate the completion of a byte and acknowledgement transfer. When FACK is enabled, TCF is then set at the falling edge of eighth clock to indicate the completion of byte.

38.4.6.2 Address detect interrupt

When the calling address matches the programmed slave address (I2C Address Register) or when the GCAEN bit is set and a general call is received, the IAAS bit in the Status Register is set. The CPU is interrupted, provided the IICIE bit is set. The CPU must check the SRW bit and set its Tx mode accordingly.

38.4.6.3 Stop Detect Interrupt

When the stop status is detected on the I²C bus, the STOPF bit is set to 1. The CPU is interrupted, provided the IICIE and SSIE bits are both set to 1.

38.4.6.4 Exit from low-power/stop modes

The slave receive input detect circuit and address matching feature are still active on low power modes (wait and stop). An asynchronous input matching slave address or general call address brings the CPU out of low power/stop mode if the interrupt is not masked. Therefore, TCF and IAAS both can trigger this interrupt.

38.4.6.5 Arbitration lost interrupt

The I2C is a true multimaster bus that allows more than one master to be connected on it. If two or more masters try to control the bus at the same time, the relative priority of the contending masters is determined by a data arbitration procedure. The I2C module asserts the arbitration-lost interrupt when it loses the data arbitration process and the ARBL bit in the Status Register is set.

Arbitration is lost in the following circumstances:

1. SDA is sampled as low when the master drives high during an address or data transmit cycle.
2. SDA is sampled as low when the master drives high during the acknowledge bit of a data receive cycle.
3. A START cycle is attempted when the bus is busy.
4. A repeated START cycle is requested in slave mode.
5. A STOP condition is detected when the master did not request it.

The ARBL bit must be cleared (by software) by writing 1 to it.

38.4.6.6 Timeout interrupt in SMBus

When the IICIE bit is set, the I2C module asserts a timeout interrupt (outputs SLTF and SHTF2) upon detection of any of the mentioned timeout conditions, with one exception. The SCL high and SDA high TIMEOUT mechanism must not be used to influence the timeout interrupt output, because this timeout indicates an idle condition on the bus. SHTF1 rises when it matches the SCL high and SDA high TIMEOUT and falls automatically just to indicate the bus status. The SHTF2's timeout period is the same as that of SHTF1, which is short compared to that of SLTF, so another control bit, SHTF2IE, is added to enable or disable it.

38.4.7 Programmable input glitch filter

An I2C glitch filter has been added outside legacy I2C modules but within the I2C package. This filter can absorb glitches on the I2C clock and data lines for the I2C module.

The width of the glitch to absorb can be specified in terms of the number of (half) I2C module clock cycles. A single Programmable Input Glitch Filter control register is provided. Effectively, any down-up-down or up-down-up transition on the data line that occurs within the number of clock cycles programmed in this register is ignored by the I2C module. The programmer must specify the size of the glitch (in terms of I2C module clock cycles) for the filter to absorb and not pass.

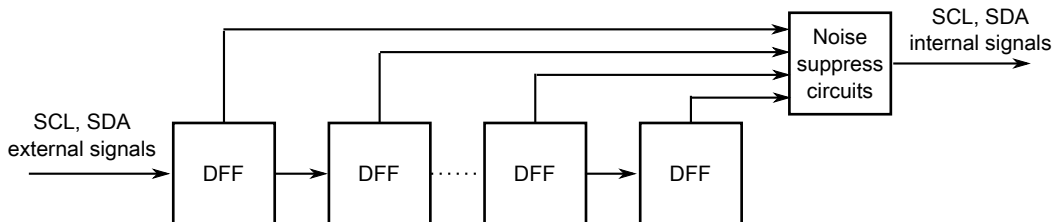

Figure 38-5. Programmable input glitch filter diagram

38.4.8 Address matching wake-up

When a primary, range, or general call address match occurs when the I2C module is in slave receive mode, the MCU wakes from a low power mode where no peripheral bus is running.

Data sent on the bus that is the same as a target device address might also wake the target MCU.

After the address matching IAAS bit is set, an interrupt is sent at the end of address matching to wake the core. The IAAS bit must be cleared after the clock recovery.

NOTE

After the system recovers and is in Run mode, restart the I2C module if it is needed to transfer packets. To avoid I2C transfer problems resulting from the situation, firmware should prevent the MCU execution of a STOP instruction when the I2C module is in the middle of a transfer unless the Stop mode holdoff feature is used during this period (set FLT[SHEN] to 1).

38.4.9 DMA support

If the DMAEN bit is cleared and the IICIE bit is set, an interrupt condition generates an interrupt request.

If the DMAEN bit is set and the IICIE bit is set, an interrupt condition generates a DMA request instead. DMA requests are generated by the transfer complete flag (TCF).

If the DMAEN bit is set, only the TCF initiates a DMA request. All other events generate CPU interrupts.

NOTE

Before the last byte of master receive mode, TXAK must be set to send a NACK after the last byte's transfer. Therefore, the DMA must be disabled before the last byte's transfer.

NOTE

In 10-bit address mode transmission, the addresses to send occupy 2–3 bytes. During this transfer period, the DMA must be disabled because the C1 register is written to send a repeat start or to change the transfer direction.

38.4.10 Double buffering mode

In the double buffering mode, the data transfer is processed byte by byte. However, the data can be transferred without waiting for the interrupt or the polling to finish. This means the write/read I2C_D operation will not block the data transfer, as the hardware has already finished the internal write or read. The benefit is that the baud rate is able to achieve higher speed.

There are several items to consider as follows:

- When initiating a double buffering transfer at Tx side, the user can write 2 values to the I2C_D buffer before transfer. However, that is allowed only at one time per package frame (due to the buffer depth, and because two-times writes in each ISR are not allowed). The second write to the I2C_D buffer must wait for the Empty flag. On the other hand, at Rx side the user can read twice in a one-byte transfer (if needed).

NOTE

Check Empty flag before write to I2C_D.

Write twice to the I2C_D buffer ONLY after the address matching byte. Do not write twice (Address+Data) before START or at the beginning of I2C transfer, especially when the baud rate is very slow.

- To write twice in one frame, during the next-to-last ISR, do a dummy read from the I2C_D buffer at Tx side (or the TCF will stay high, because the TCF is cleared by write/read operation). In the next-to-last ISR, do not send data again (the buffer data will be under running).
- To keep new ISRs software-compatible with previous ISRs, the write/read I2C_D operation will not block the internal-hardware-released SCL/SDA signals. At the ACK phase, the bus is released to accept the next byte if the master can send the clock immediately.
- On the slave side, two-times writes to the I2C_D buffer may be limited by the master's clock and START/repeated-START signal. This is not currently supported, and the master's START/repeated-START signal will break data transfers. To release the bus, do a dummy read or write to the I2C_D buffer again. It is suggested to send repeated-START/START during intervals as before.
- The master receive should send a NACK in the next-to-last ISR, if it wants to do the STOP or the repeated-START work. The transmitting slave which receives the NACK, will switch to receive mode, and do a dummy read to release SCL and SDA signals.

38.5 Initialization/application information

Module Initialization (Slave)

1. Write: Control Register 2
 - to enable or disable general call
 - to select 10-bit or 7-bit addressing mode

2. Write: Address Register 1 to set the slave address
3. Write: Control Register 1 to enable the I2C module and interrupts
4. Initialize RAM variables (IICEN = 1 and IICIE = 1) for transmit data
5. Initialize RAM variables used to achieve the routine shown in the following figure

Module Initialization (Master)

1. Write: Frequency Divider register to set the I2C baud rate (see example in description of [ICR](#))
2. Write: Control Register 1 to enable the I2C module and interrupts
3. Initialize RAM variables (IICEN = 1 and IICIE = 1) for transmit data
4. Initialize RAM variables used to achieve the routine shown in the following figure
5. Write: Control Register 1 to enable TX
6. Write: Control Register 1 to enable MST (master mode)
7. Write: Data register with the address of the target slave (the LSB of this byte determines whether the communication is master receive or transmit)

The routine shown in the following figure encompasses both master and slave I2C operations. For slave operation, an incoming I2C message that contains the proper address begins I2C communication. For master operation, communication must be initiated by writing the Data register. An example of an I2C driver which implements many of the steps described here is available in [AN4342: Using the Inter-Integrated Circuit on ColdFire+ and Kinetis](#) .

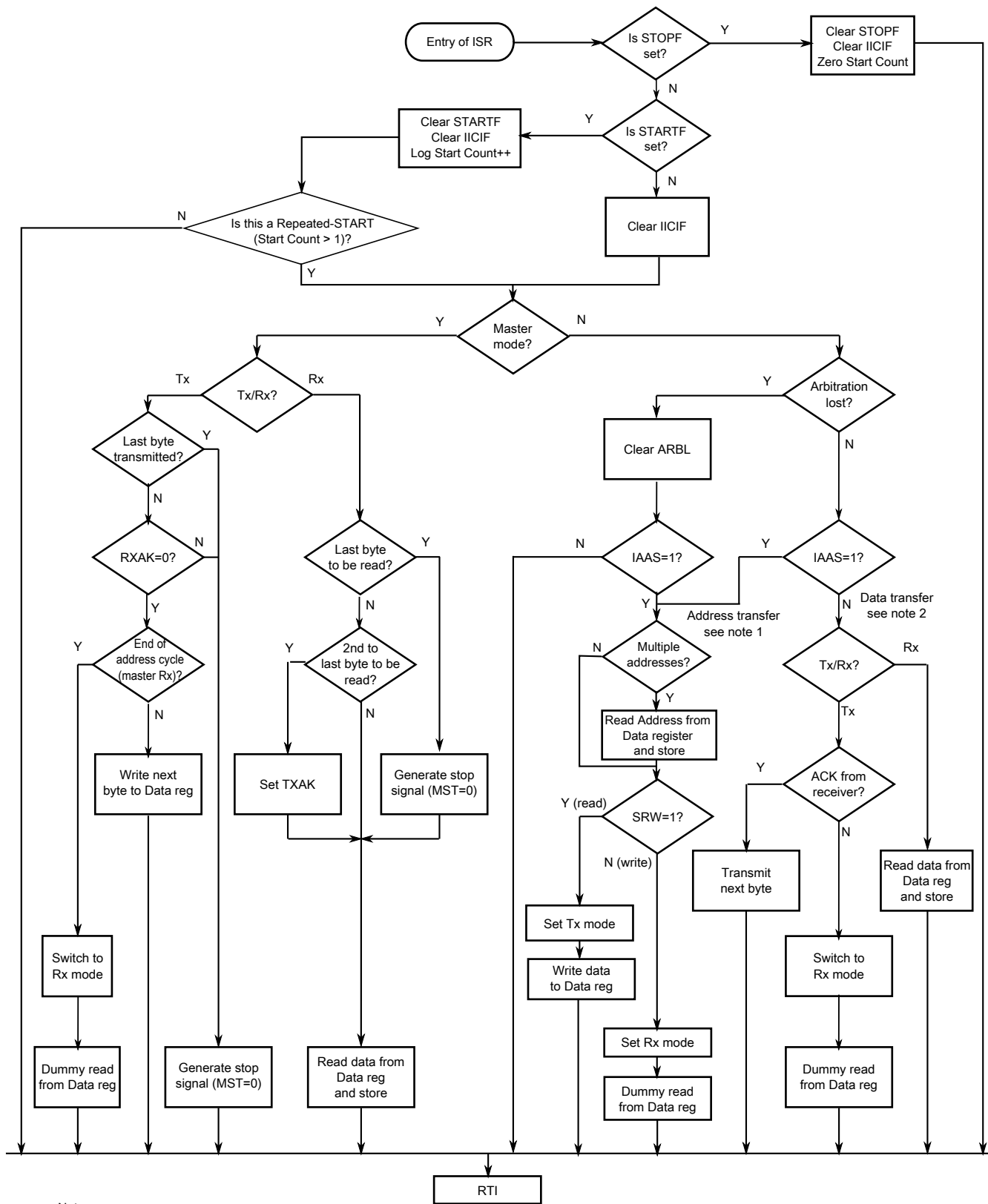

Notes:

1. If general call is enabled, check to determine if the received address is a general call address (0x00). If the received address is a general call address, the general call must be handled by user software.
2. When 10-bit addressing addresses a slave, the slave sees an interrupt following the first byte of the extended address. Ensure that for this interrupt, the contents of the Data register are ignored and not treated as a valid data transfer.

Figure 38-6. Typical I2C interrupt routine

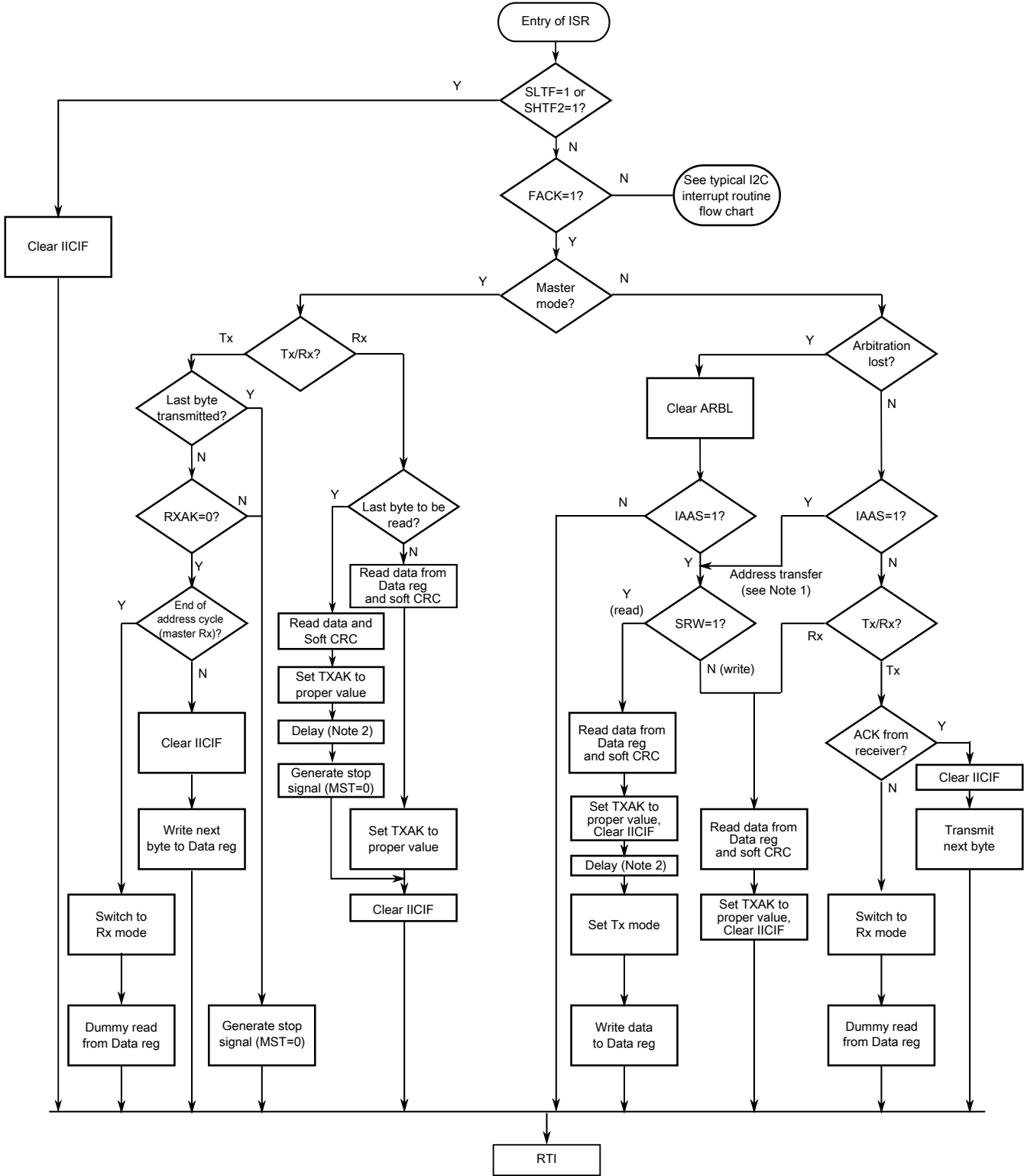

- Notes:
1. If general call or SIICAE is enabled, check to determine if the received address is a general call address (0x00) or an SMBus device default address. In either case, they must be handled by user software.
 2. In receive mode, one bit time delay may be needed before the stop signal generation, to wait for the possible longest time period (in worst case) of the 9th SCL cycle.

Figure 38-7. Typical I2C SMBus interrupt routine

Chapter 39

Low Power Universal Asynchronous Receiver/Transmitter (LPUART0)

39.1 Introduction

39.1.1 Features

Features of the LPUART module include:

- Full-duplex, standard non-return-to-zero (NRZ) format
- Programmable baud rates (13-bit modulo divider) with configurable oversampling ratio from 4x to 32x
- Transmit and receive baud rate can operate asynchronous to the bus clock:
 - Baud rate can be configured independently of the bus clock frequency
- Interrupt, DMA or polled operation:
 - Transmit data register empty and transmission complete
 - Receive data register full
 - Receive overrun, parity error, framing error, and noise error
 - Idle receiver detect
 - Active edge on receive pin
 - Break detect supporting LIN
 - Receive data match
- Hardware parity generation and checking
- Programmable 8-bit, 9-bit or 10-bit character length
- Programmable 1-bit or 2-bit stop bits
- Three receiver wakeup methods:
 - Idle line wakeup
 - Address mark wakeup
 - Receive data match
- Automatic address matching to reduce ISR overhead:
 - Address mark matching

- Idle line address matching
- Address match start, address match end
- Optional 13-bit break character generation / 11-bit break character detection
- Configurable idle length detection supporting 1, 2, 4, 8, 16, 32, 64 or 128 idle characters
- Selectable transmitter output and receiver input polarity
- Hardware flow control support for request to send (RTS) and clear to send (CTS) signals
- Selectable IrDA 1.4 return-to-zero-inverted (RZI) format with programmable pulse width

39.1.2 Modes of operation

39.1.2.1 Wait mode

The LPUART can be configured to Stop in Wait modes, when the DOZEEN bit is set. The transmitter and receiver will finish transmitting/receiving the current word.

39.1.3 Signal Descriptions

| Signal | Description | I/O |
|------------|---|-----|
| LPUART_TX | Transmit data. This pin is normally an output, but is an input (tristated) in single wire mode whenever the transmitter is disabled or transmit direction is configured for receive data. | I/O |
| LPUART_RX | Receive data. | I |
| LPUART_CTS | Clear to send. | I |
| LPUART_RTS | Request to send. | O |

39.1.4 Block diagram

The following figure shows the transmitter portion of the LPUART.

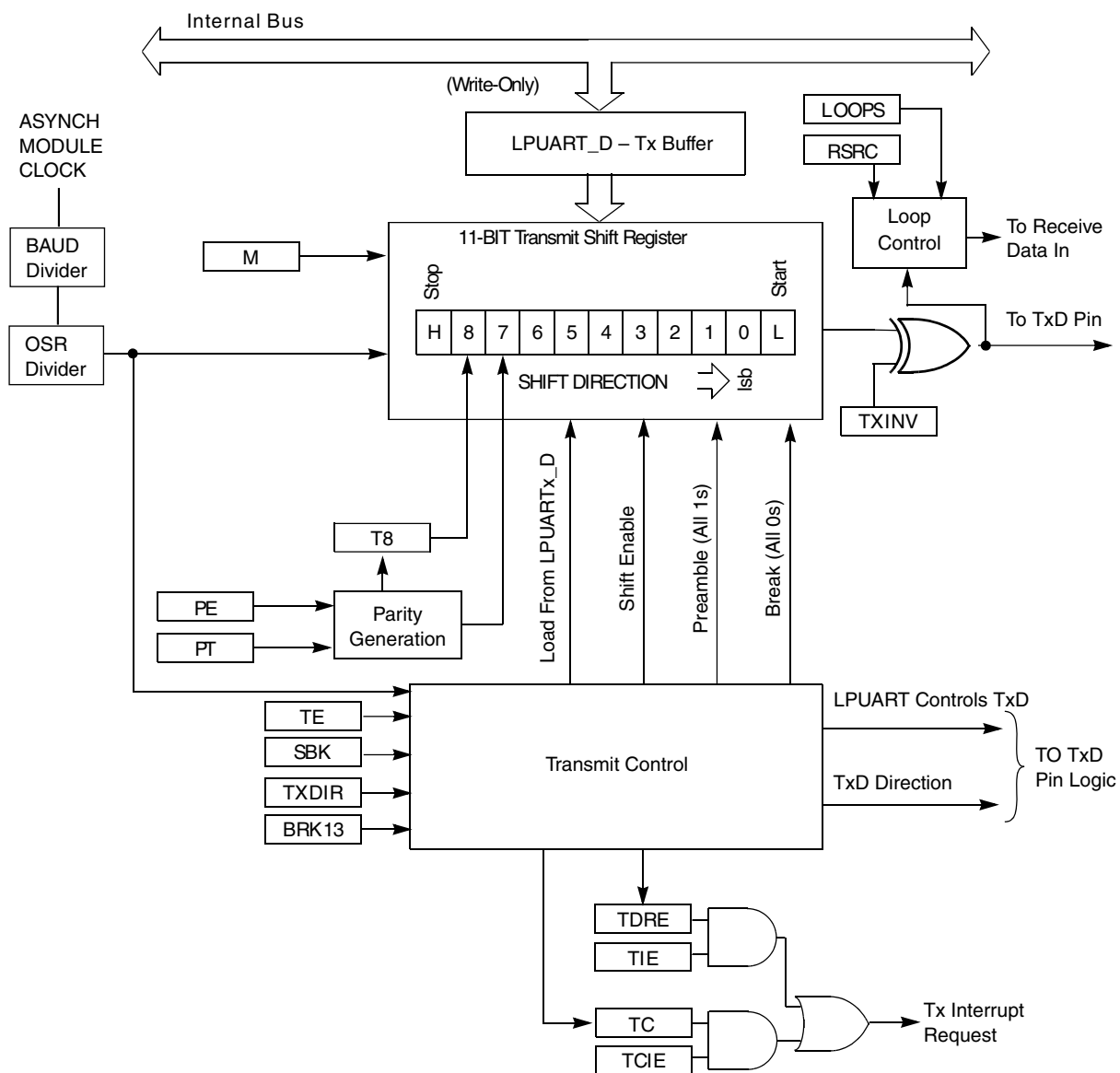

Figure 39-1. LPUART transmitter block diagram

The following figure shows the receiver portion of the LPUART.

Register definition

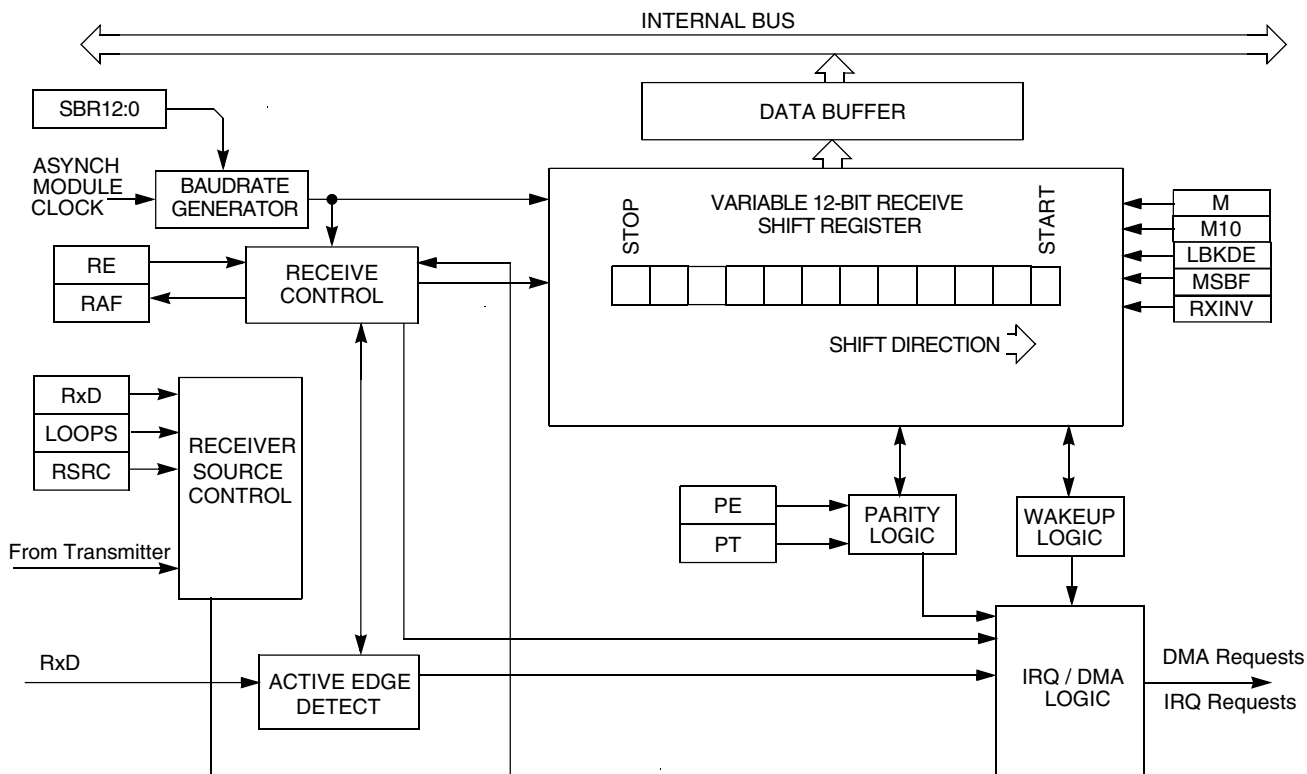

Figure 39-2. LPUART receiver block diagram

39.2 Register definition

The LPUART includes registers to control baud rate, select LPUART options, report LPUART status, and for transmit/receive data. Access to an address outside the valid memory map will generate a bus error.

LPUART memory map

| Absolute address (hex) | Register name | Width (in bits) | Access | Reset value | Section/page |
|------------------------|---|-----------------|--------|-------------|----------------------------|
| 4005_4000 | LPUART Baud Rate Register (LPUART0_BAUD) | 32 | R/W | 0F00_0004h | 39.2.1/891 |
| 4005_4004 | LPUART Status Register (LPUART0_STAT) | 32 | R/W | 00C0_0000h | 39.2.2/893 |
| 4005_4008 | LPUART Control Register (LPUART0_CTRL) | 32 | R/W | 0000_0000h | 39.2.3/897 |
| 4005_400C | LPUART Data Register (LPUART0_DATA) | 32 | R/W | 0000_1000h | 39.2.4/902 |
| 4005_4010 | LPUART Match Address Register (LPUART0_MATCH) | 32 | R/W | 0000_0000h | 39.2.5/904 |
| 4005_4014 | LPUART Modem IrDA Register (LPUART0_MODIR) | 32 | R/W | 0000_0000h | 39.2.6/904 |

39.2.1 LPUART Baud Rate Register (LPUARTx_BAUD)

Address: 4005_4000h base + 0h offset = 4005_4000h

| | | | | | | | | | | | | | | | | |
|-------|--------|-------|-----|---------|----|----|------|-------|----|-------|----|----|--------|----------|-----------|----|
| Bit | 31 | 30 | 29 | 28 | 27 | 26 | 25 | 24 | 23 | 22 | 21 | 20 | 19 | 18 | 17 | 16 |
| R | | | | OSR | | | | | | | | | MATCFG | | | |
| W | MAEN1 | MAEN2 | M10 | | | | | TDMAE | 0 | RDMAE | 0 | | | BOTHEDGE | RESYNCDIS | |
| Reset | 0 | 0 | 0 | 0 | 1 | 1 | 1 | 1 | 0 | 0 | 0 | 0 | 0 | 0 | 0 | 0 |
| Bit | 15 | 14 | 13 | 12 | 11 | 10 | 9 | 8 | 7 | 6 | 5 | 4 | 3 | 2 | 1 | 0 |
| R | LBKDIE | | | RXEDGIE | | | SBNS | | | SBR | | | | | | |
| W | LBKDIE | | | RXEDGIE | | | SBNS | | | SBR | | | | | | |
| Reset | 0 | 0 | 0 | 0 | 0 | 0 | 0 | 0 | 0 | 0 | 0 | 0 | 0 | 1 | 0 | 0 |

LPUARTx_BAUD field descriptions

| Field | Description |
|--------------|--|
| 31 MAEN1 | Match Address Mode Enable 1 0 Normal operation. 1 Enables automatic address matching or data matching mode for MATCH[MA1]. |
| 30 MAEN2 | Match Address Mode Enable 2 0 Normal operation. 1 Enables automatic address matching or data matching mode for MATCH[MA2]. |
| 29 M10 | 10-bit Mode select The M10 bit causes a tenth bit to be part of the serial transmission. This bit should only be changed when the transmitter and receiver are both disabled. 0 Receiver and transmitter use 8-bit or 9-bit data characters. 1 Receiver and transmitter use 10-bit data characters. |
| 28–24 OSR | Oversampling Ratio This field configures the oversampling ratio for the receiver between 4x (00011) and 32x (11111). Writing an invalid oversampling ratio (for example, a value not between 4x and 32x) will default to an oversampling ratio of 16 (01111). The OSR field should only be changed when the transmitter and receiver are both disabled. Note that the oversampling ratio = OSR + 1. |
| 23 TDMAE | Transmitter DMA Enable TDMAE configures the transmit data register empty flag, LPUART_STAT[TDRE], to generate a DMA request. 0 DMA request disabled. 1 DMA request enabled. |

Table continues on the next page...

LPUARTx_BAUD field descriptions (continued)

| Field | Description |
|-----------------|--|
| 22 Reserved | This field is reserved. This read-only field is reserved and always has the value 0. |
| 21 RDMAE | Receiver Full DMA Enable RDMAE configures the receiver data register full flag, LPUART_STAT[RDRF], to generate a DMA request. 0 DMA request disabled. 1 DMA request enabled. |
| 20 Reserved | This field is reserved. This read-only field is reserved and always has the value 0. |
| 19–18 MATCFG | Match Configuration Configures the match addressing mode used. 00 Address Match Wakeup 01 Idle Match Wakeup 10 Match On and Match Off 11 Enables RWU on Data Match and Match On/Off for transmitter CTS input |
| 17 BOTHEDGE | Both Edge Sampling Enables sampling of the received data on both edges of the baud rate clock, effectively doubling the number of times the receiver samples the input data for a given oversampling ratio. This bit must be set for oversampling ratios between x4 and x7 and is optional for higher oversampling ratios. This bit should only be changed when the receiver is disabled. 0 Receiver samples input data using the rising edge of the baud rate clock. 1 Receiver samples input data using the rising and falling edge of the baud rate clock. |
| 16 RESYNCDIS | Resynchronization Disable When set, disables the resynchronization of the received data word when a data one followed by data zero transition is detected. This bit should only be changed when the receiver is disabled. 0 Resynchronization during received data word is supported 1 Resynchronization during received data word is disabled |
| 15 LBKDIE | LIN Break Detect Interrupt Enable LBKDIE enables the LIN break detect flag, LBKDIF, to generate interrupt requests. 0 Hardware interrupts from LPUART_STAT[LBKDIF] disabled (use polling). 1 Hardware interrupt requested when LPUART_STAT[LBKDIF] flag is 1. |
| 14 RXEDGIE | RX Input Active Edge Interrupt Enable Enables the receive input active edge, RXEDGIF, to generate interrupt requests. Changing CTRL[LOOP] or CTRL[RSRC] when RXEDGIE is set can cause the RXEDGIF to set. 0 Hardware interrupts from LPUART_STAT[RXEDGIF] disabled (use polling). 1 Hardware interrupt requested when LPUART_STAT[RXEDGIF] flag is 1. |
| 13 SBNS | Stop Bit Number Select SBNS determines whether data characters are one or two stop bits. This bit should only be changed when the transmitter and receiver are both disabled. |

Table continues on the next page...

LPUARTx_BAUD field descriptions (continued)

| Field | Description |
|-------|---|
| | 0 One stop bit. 1 Two stop bits. |
| SBR | Baud Rate Modulo Divisor. The 13 bits in SBR[12:0] set the modulo divide rate for the baud rate generator. When SBR is 1 - 8191, the baud rate equals "baud clock / ((OSR+1) × SBR)". The 13-bit baud rate setting [SBR12:SBR0] must only be updated when the transmitter and receiver are both disabled (LPUART_CTRL[RE] and LPUART_CTRL[TE] are both 0). |

39.2.2 LPUART Status Register (LPUARTx_STAT)

Address: 4005_4000h base + 4h offset = 4005_4004h

| Bit | 31 | 30 | 29 | 28 | 27 | 26 | 25 | 24 | 23 | 22 | 21 | 20 | 19 | 18 | 17 | 16 |
|-------|--------|---------|------|-------|-------|-------|-------|-----|------|----|------|------|-----|-----|-----|-----|
| R | LBKDIF | RXEDGIF | MSBF | RXINV | RWUID | BRK13 | LBKDE | RAF | TDRE | TC | RDRF | IDLE | OR | NF | FE | PF |
| W | w1c | w1c | | | | | | | | | | w1c | w1c | w1c | w1c | w1c |
| Reset | 0 | 0 | 0 | 0 | 0 | 0 | 0 | 0 | 1 | 1 | 0 | 0 | 0 | 0 | 0 | 0 |
| Bit | 15 | 14 | 13 | 12 | 11 | 10 | 9 | 8 | 7 | 6 | 5 | 4 | 3 | 2 | 1 | 0 |
| R | MA1F | MA2F | 0 | | | | | | | | | | | | | |
| W | w1c | w1c | | | | | | | | | | | | | | |
| Reset | 0 | 0 | 0 | 0 | 0 | 0 | 0 | 0 | 0 | 0 | 0 | 0 | 0 | 0 | 0 | 0 |

LPUARTx_STAT field descriptions

| Field | Description |
|--------------|--|
| 31 LBKDIF | LIN Break Detect Interrupt Flag LBKDIF is set when the LIN break detect circuitry is enabled and a LIN break character is detected. LBKDIF is cleared by writing a 1 to it. |

Table continues on the next page...

LPUARTx_STAT field descriptions (continued)

| Field | Description |
|---------------|--|
| | 0 No LIN break character has been detected. 1 LIN break character has been detected. |
| 30 RXEDGIF | LPUART_RX Pin Active Edge Interrupt Flag RXEDGIF is set whenever the receiver is enabled and an active edge, falling if RXINV = 0, rising if RXINV=1, on the LPUART_RX pin occurs. RXEDGIF is cleared by writing a 1 to it. 0 No active edge on the receive pin has occurred. 1 An active edge on the receive pin has occurred. |
| 29 MSBF | MSB First Setting this bit reverses the order of the bits that are transmitted and received on the wire. This bit does not affect the polarity of the bits, the location of the parity bit or the location of the start or stop bits. This bit should only be changed when the transmitter and receiver are both disabled. 0 LSB (bit0) is the first bit that is transmitted following the start bit. Further, the first bit received after the start bit is identified as bit0. 1 MSB (bit9, bit8, bit7 or bit6) is the first bit that is transmitted following the start bit depending on the setting of CTRL[M], CTRL[PE] and BAUD[M10]. Further, the first bit received after the start bit is identified as bit9, bit8, bit7 or bit6 depending on the setting of CTRL[M] and CTRL[PE]. |
| 28 RXINV | Receive Data Inversion Setting this bit reverses the polarity of the received data input. NOTE: Setting RXINV inverts the LPUART_RX input for all cases: data bits, start and stop bits, break, and idle. 0 Receive data not inverted. 1 Receive data inverted. |
| 27 RWUID | Receive Wake Up Idle Detect For RWU on idle character, RWUID controls whether the idle character that wakes up the receiver sets the IDLE bit. For address match wakeup, RWUID controls if the IDLE bit is set when the address does not match. This bit should only be changed when the receiver is disabled. 0 During receive standby state (RWU = 1), the IDLE bit does not get set upon detection of an idle character. During address match wakeup, the IDLE bit does not get set when an address does not match. 1 During receive standby state (RWU = 1), the IDLE bit gets set upon detection of an idle character. During address match wakeup, the IDLE bit does get set when an address does not match. |
| 26 BRK13 | Break Character Generation Length BRK13 selects a longer transmitted break character length. Detection of a framing error is not affected by the state of this bit. This bit should only be changed when the transmitter is disabled. 0 Break character is transmitted with length of 10 bit times (if M = 0, SBNS = 0) or 11 (if M = 1, SBNS = 0 or M = 0, SBNS = 1) or 12 (if M = 1, SBNS = 1 or M10 = 1, SNBS = 0) or 13 (if M10 = 1, SNBS = 1). 1 Break character is transmitted with length of 13 bit times (if M = 0, SBNS = 0) or 14 (if M = 1, SBNS = 0 or M = 0, SBNS = 1) or 15 (if M = 1, SBNS = 1 or M10 = 1, SNBS = 0) or 16 (if M10 = 1, SNBS = 1). |
| 25 LBKDE | LIN Break Detection Enable LBKDE selects a longer break character detection length. While LBKDE is set, receive data is not stored in the receive data buffer. |

Table continues on the next page...

LPUARTx_STAT field descriptions (continued)

| Field | Description |
|------------|---|
| | <p>0 Break character is detected at length 10 bit times (if M = 0, SBNS = 0) or 11 (if M = 1, SBNS = 0 or M = 0, SBNS = 1) or 12 (if M = 1, SBNS = 1 or M10 = 1, SNBS = 0) or 13 (if M10 = 1, SNBS = 1).</p> <p>1 Break character is detected at length of 11 bit times (if M = 0, SBNS = 0) or 12 (if M = 1, SBNS = 0 or M = 0, SBNS = 1) or 14 (if M = 1, SBNS = 1 or M10 = 1, SNBS = 0) or 15 (if M10 = 1, SNBS = 1).</p> |
| 24 RAF | <p>Receiver Active Flag</p> <p>RAF is set when the receiver detects the beginning of a valid start bit, and RAF is cleared automatically when the receiver detects an idle line.</p> <p>0 LPUART receiver idle waiting for a start bit. 1 LPUART receiver active (LPUART_RX input not idle).</p> |
| 23 TDRE | <p>Transmit Data Register Empty Flag</p> <p>When the transmit FIFO is enabled, TDRE will set when the number of datawords in the transmit FIFO (LPUART_DATA) is equal to or less than the number indicated by LPUART_WATER[TXWATER]. To clear TDRE, write to the LPUART data register (LPUART_DATA) until the number of words in the transmit FIFO is greater than the number indicated by LPUART_WATER[TXWATER]. When the transmit FIFO is disabled, TDRE will set when the transmit data register (LPUART_DATA) is empty. To clear TDRE, write to the LPUART data register (LPUART_DATA).</p> <p>TDRE is not affected by a character that is in the process of being transmitted, it is updated at the start of each transmitted character.</p> <p>0 Transmit data buffer full. 1 Transmit data buffer empty.</p> |
| 22 TC | <p>Transmission Complete Flag</p> <p>TC is cleared when there is a transmission in progress or when a preamble or break character is loaded. TC is set when the transmit buffer is empty and no data, preamble, or break character is being transmitted. When TC is set, the transmit data output signal becomes idle (logic 1). TC is cleared by writing to LPUART_DATA to transmit new data, queuing a preamble by clearing and then setting LPUART_CTRL[TE], queuing a break character by writing 1 to LPUART_CTRL[SBK].</p> <p>0 Transmitter active (sending data, a preamble, or a break). 1 Transmitter idle (transmission activity complete).</p> |
| 21 RDRF | <p>Receive Data Register Full Flag</p> <p>When the receive FIFO is enabled, RDRF is set when the number of datawords in the receive buffer is greater than the number indicated by LPUART_WATER[RXWATER]. To clear RDRF, read LPUART_DATA until the number of datawords in the receive data buffer is equal to or less than the number indicated by LPUART_WATER[RXWATER]. When the receive FIFO is disabled, RDRF is set when the receive buffer (LPUART_DATA) is full. To clear RDRF, read the LPUART_DATA register.</p> <p>A character that is in the process of being received does not cause a change in RDRF until the entire character is received. Even if RDRF is set, the character will continue to be received until an overrun condition occurs once the entire character is received.</p> <p>0 Receive data buffer empty. 1 Receive data buffer full.</p> |
| 20 IDLE | <p>Idle Line Flag</p> <p>IDLE is set when the LPUART receive line becomes idle for a full character time after a period of activity. When ILT is cleared, the receiver starts counting idle bit times after the start bit. If the receive character is all 1s, these bit times and the stop bits time count toward the full character time of logic high, 10 to 13 bit times, needed for the receiver to detect an idle line. When ILT is set, the receiver doesn't start counting</p> |

Table continues on the next page...

LPUARTx_STAT field descriptions (continued)

| Field | Description |
|------------|---|
| | <p>idle bit times until after the stop bits. The stop bits and any logic high bit times at the end of the previous character do not count toward the full character time of logic high needed for the receiver to detect an idle line.</p> <p>To clear IDLE, write logic 1 to the IDLE flag. After IDLE has been cleared, it cannot become set again until after a new character has been stored in the receive buffer or a LIN break character has set the LBKDIF flag. IDLE is set only once even if the receive line remains idle for an extended period.</p> <p>0 No idle line detected. 1 Idle line was detected.</p> |
| 19 OR | <p>Receiver Overrun Flag</p> <p>OR is set when software fails to prevent the receive data register from overflowing with data. The OR bit is set immediately after the stop bit has been completely received for the dataword that overflows the buffer and all the other error flags (FE, NF, and PF) are prevented from setting. The data in the shift register is lost, but the data already in the LPUART data registers is not affected. If LBKDE is enabled and a LIN Break is detected, the OR field asserts if LBKDIF is not cleared before the next data character is received.</p> <p>While the OR flag is set, no additional data is stored in the data buffer even if sufficient room exists. To clear OR, write logic 1 to the OR flag.</p> <p>0 No overrun. 1 Receive overrun (new LPUART data lost).</p> |
| 18 NF | <p>Noise Flag</p> <p>The advanced sampling technique used in the receiver takes three samples in each of the received bits. If any of these samples disagrees with the rest of the samples within any bit time in the frame then noise is detected for that character. NF is set whenever the next character to be read from LPUART_DATA was received with noise detected within the character. To clear NF, write logic one to the NF.</p> <p>0 No noise detected. 1 Noise detected in the received character in LPUART_DATA.</p> |
| 17 FE | <p>Framing Error Flag</p> <p>FE is set whenever the next character to be read from LPUART_DATA was received with logic 0 detected where a stop bit was expected. To clear FE, write logic one to the FE.</p> <p>0 No framing error detected. This does not guarantee the framing is correct. 1 Framing error.</p> |
| 16 PF | <p>Parity Error Flag</p> <p>PF is set whenever the next character to be read from LPUART_DATA was received when parity is enabled (PE = 1) and the parity bit in the received character does not agree with the expected parity value. To clear PF, write a logic one to the PF.</p> <p>0 No parity error. 1 Parity error.</p> |
| 15 MA1F | <p>Match 1 Flag</p> <p>MA1F is set whenever the next character to be read from LPUART_DATA matches MA1. To clear MA1F, write a logic one to the MA1F.</p> <p>0 Received data is not equal to MA1 1 Received data is equal to MA1</p> |

Table continues on the next page...

LPUARTx_STAT field descriptions (continued)

| Field | Description |
|------------|--|
| 14 MA2F | Match 2 Flag MA2F is set whenever the next character to be read from LPUART_DATA matches MA2. To clear MA2F, write a logic one to the MA2F. 0 Received data is not equal to MA2 1 Received data is equal to MA2 |
| Reserved | This field is reserved. This read-only field is reserved and always has the value 0. |

39.2.3 LPUART Control Register (LPUARTx_CTRL)

This read/write register controls various optional features of the LPUART system. This register should only be altered when the transmitter and receiver are both disabled.

Address: 4005_4000h base + 8h offset = 4005_4008h

| | | | | | | | | | | | | | | | | |
|-------|-------|-------|---------|-------|------|------|-------|--------|----------|------|------|------|----|----|-----|-----|
| Bit | 31 | 30 | 29 | 28 | 27 | 26 | 25 | 24 | 23 | 22 | 21 | 20 | 19 | 18 | 17 | 16 |
| R | | | | | | | | | | | | | | | | |
| W | R8T9 | R9T8 | TXDIR | TXINV | ORIE | NEIE | FEIE | PEIE | TIE | TCIE | RIE | ILIE | TE | RE | RWU | SBK |
| Reset | 0 | 0 | 0 | 0 | 0 | 0 | 0 | 0 | 0 | 0 | 0 | 0 | 0 | 0 | 0 | 0 |
| Bit | 15 | 14 | 13 | 12 | 11 | 10 | 9 | 8 | 7 | 6 | 5 | 4 | 3 | 2 | 1 | 0 |
| R | | | | 0 | | | | | | | | | | | | |
| W | MA1IE | MA2IE | IDLECFG | | | | LOOPS | DOZEEN | RSR C | M | WAKE | ILT | PE | PT | | |
| Reset | 0 | 0 | 0 | 0 | 0 | 0 | 0 | 0 | 0 | 0 | 0 | 0 | 0 | 0 | 0 | 0 |

LPUARTx_CTRL field descriptions

| Field | Description |
|------------|--|
| 31 R8T9 | Receive Bit 8 / Transmit Bit 9 R8 is the ninth data bit received when the LPUART is configured for 9-bit or 10-bit data formats. When reading 9-bit or 10-bit data, read R8 before reading LPUART_DATA. T9 is the tenth data bit received when the LPUART is configured for 10-bit data formats. When writing 10-bit data, write T9 before writing LPUART_DATA. If T9 does not need to change from its previous value, such as when it is used to generate address mark or parity, they it need not be written each time LPUART_DATA is written. |
| 30 R9T8 | Receive Bit 9 / Transmit Bit 8 |

Table continues on the next page...

LPUARTx_CTRL field descriptions (continued)

| Field | Description |
|-------------|--|
| | <p>R9 is the tenth data bit received when the LPUART is configured for 10-bit data formats. When reading 10-bit data, read R9 before reading LPUART_DATA</p> <p>T8 is the ninth data bit received when the LPUART is configured for 9-bit or 10-bit data formats. When writing 9-bit or 10-bit data, write T8 before writing LPUART_DATA. If T8 does not need to change from its previous value, such as when it is used to generate address mark or parity, they it need not be written each time LPUART_DATA is written.</p> |
| 29 TXDIR | <p>LPUART_TX Pin Direction in Single-Wire Mode</p> <p>When the LPUART is configured for single-wire half-duplex operation (LOOPS = RSRC = 1), this bit determines the direction of data at the LPUART_TX pin. When clearing TXDIR, the transmitter will finish receiving the current character (if any) before the receiver starts receiving data from the LPUART_TX pin.</p> <p>0 LPUART_TX pin is an input in single-wire mode. 1 LPUART_TX pin is an output in single-wire mode.</p> |
| 28 TXINV | <p>Transmit Data Inversion</p> <p>Setting this bit reverses the polarity of the transmitted data output.</p> <p>NOTE: Setting TXINV inverts the LPUART_TX output for all cases: data bits, start and stop bits, break, and idle.</p> <p>0 Transmit data not inverted. 1 Transmit data inverted.</p> |
| 27 ORIE | <p>Overrun Interrupt Enable</p> <p>This bit enables the overrun flag (OR) to generate hardware interrupt requests.</p> <p>0 OR interrupts disabled; use polling. 1 Hardware interrupt requested when OR is set.</p> |
| 26 NEIE | <p>Noise Error Interrupt Enable</p> <p>This bit enables the noise flag (NF) to generate hardware interrupt requests.</p> <p>0 NF interrupts disabled; use polling. 1 Hardware interrupt requested when NF is set.</p> |
| 25 FEIE | <p>Framing Error Interrupt Enable</p> <p>This bit enables the framing error flag (FE) to generate hardware interrupt requests.</p> <p>0 FE interrupts disabled; use polling. 1 Hardware interrupt requested when FE is set.</p> |
| 24 PEIE | <p>Parity Error Interrupt Enable</p> <p>This bit enables the parity error flag (PF) to generate hardware interrupt requests.</p> <p>0 PF interrupts disabled; use polling). 1 Hardware interrupt requested when PF is set.</p> |
| 23 TIE | <p>Transmit Interrupt Enable</p> <p>Enables STAT[TDRE] to generate interrupt requests.</p> |

Table continues on the next page...

LPUARTx_CTRL field descriptions (continued)

| Field | Description |
|------------|--|
| | <p>0 Hardware interrupts from TDRE disabled; use polling.</p> <p>1 Hardware interrupt requested when TDRE flag is 1.</p> |
| 22 TCIE | <p>Transmission Complete Interrupt Enable for</p> <p>TCIE enables the transmission complete flag, TC, to generate interrupt requests.</p> <p>0 Hardware interrupts from TC disabled; use polling.</p> <p>1 Hardware interrupt requested when TC flag is 1.</p> |
| 21 RIE | <p>Receiver Interrupt Enable</p> <p>Enables STAT[RDRF] to generate interrupt requests.</p> <p>0 Hardware interrupts from RDRF disabled; use polling.</p> <p>1 Hardware interrupt requested when RDRF flag is 1.</p> |
| 20 ILIE | <p>Idle Line Interrupt Enable</p> <p>ILIE enables the idle line flag, STAT[IDLE], to generate interrupt requests.</p> <p>0 Hardware interrupts from IDLE disabled; use polling.</p> <p>1 Hardware interrupt requested when IDLE flag is 1.</p> |
| 19 TE | <p>Transmitter Enable</p> <p>Enables the LPUART transmitter. TE can also be used to queue an idle preamble by clearing and then setting TE. When TE is cleared, this register bit will read as 1 until the transmitter has completed the current character and the LPUART_TX pin is tristated.</p> <p>0 Transmitter disabled.</p> <p>1 Transmitter enabled.</p> |
| 18 RE | <p>Receiver Enable</p> <p>Enables the LPUART receiver. When RE is written to 0, this register bit will read as 1 until the receiver finishes receiving the current character (if any).</p> <p>0 Receiver disabled.</p> <p>1 Receiver enabled.</p> |
| 17 RWU | <p>Receiver Wakeup Control</p> <p>This field can be set to place the LPUART receiver in a standby state. RWU automatically clears when an RWU event occurs, that is, an IDLE event when CTRL[WAKE] is clear or an address match when CTRL[WAKE] is set with STAT[RWUID] is clear.</p> <p>NOTE: RWU must be set only with CTRL[WAKE] = 0 (wakeup on idle) if the channel is currently not idle. This can be determined by STAT[RAF]. If the flag is set to wake up an IDLE event and the channel is already idle, it is possible that the LPUART will discard data. This is because the data must be received or a LIN break detected after an IDLE is detected before IDLE is allowed to be reasserted.</p> <p>0 Normal receiver operation.</p> <p>1 LPUART receiver in standby waiting for wakeup condition.</p> |
| 16 SBK | <p>Send Break</p> <p>Writing a 1 and then a 0 to SBK queues a break character in the transmit data stream. Additional break characters of 10 to 13, or 13 to 16 if LPUART_STATBRK13] is set, bit times of logic 0 are queued as long</p> |

Table continues on the next page...

LPUARTx_CTRL field descriptions (continued)

| Field | Description |
|-------------------|--|
| | <p>as SBK is set. Depending on the timing of the set and clear of SBK relative to the information currently being transmitted, a second break character may be queued before software clears SBK.</p> <p>0 Normal transmitter operation. 1 Queue break character(s) to be sent.</p> |
| 15 MA1IE | <p>Match 1 Interrupt Enable</p> <p>0 MA1F interrupt disabled 1 MA1F interrupt enabled</p> |
| 14 MA2IE | <p>Match 2 Interrupt Enable</p> <p>0 MA2F interrupt disabled 1 MA2F interrupt enabled</p> |
| 13–11 Reserved | <p>This field is reserved. This read-only field is reserved and always has the value 0.</p> |
| 10–8 IDLECFG | <p>Idle Configuration</p> <p>Configures the number of idle characters that must be received before the IDLE flag is set.</p> <p>000 1 idle character 001 2 idle characters 010 4 idle characters 011 8 idle characters 100 16 idle characters 101 32 idle characters 110 64 idle characters 111 128 idle characters</p> |
| 7 LOOPS | <p>Loop Mode Select</p> <p>When LOOPS is set, the LPUART_RX pin is disconnected from the LPUART and the transmitter output is internally connected to the receiver input. The transmitter and the receiver must be enabled to use the loop function.</p> <p>0 Normal operation - LPUART_RX and LPUART_TX use separate pins. 1 Loop mode or single-wire mode where transmitter outputs are internally connected to receiver input (see RSRC bit).</p> |
| 6 DOZEEN | <p>Doze Enable</p> <p>0 LPUART is enabled in Doze mode. 1 LPUART is disabled in Doze mode.</p> |
| 5 RSRC | <p>Receiver Source Select</p> <p>This field has no meaning or effect unless the LOOPS field is set. When LOOPS is set, the RSRC field determines the source for the receiver shift register input.</p> <p>0 Provided LOOPS is set, RSRC is cleared, selects internal loop back mode and the LPUART does not use the LPUART_RX pin. 1 Single-wire LPUART mode where the LPUART_TX pin is connected to the transmitter output and receiver input.</p> |
| 4 M | <p>9-Bit or 8-Bit Mode Select</p> |

Table continues on the next page...

LPUARTx_CTRL field descriptions (continued)

| Field | Description |
|-----------|---|
| | 0 Receiver and transmitter use 8-bit data characters. 1 Receiver and transmitter use 9-bit data characters. |
| 3 WAKE | Receiver Wakeup Method Select Determines which condition wakes the LPUART when RWU=1: <ul style="list-style-type: none"> • Address mark in the most significant bit position of a received data character, or • An idle condition on the receive pin input signal. 0 Configures RWU for idle-line wakeup. 1 Configures RWU with address-mark wakeup. |
| 2 ILT | Idle Line Type Select Determines when the receiver starts counting logic 1s as idle character bits. The count begins either after a valid start bit or after the stop bit. If the count begins after the start bit, then a string of logic 1s preceding the stop bit can cause false recognition of an idle character. Beginning the count after the stop bit avoids false idle character recognition, but requires properly synchronized transmissions. NOTE: In case the LPUART is programmed with ILT = 1, a logic 0 is automatically shifted after a received stop bit, therefore resetting the idle count. 0 Idle character bit count starts after start bit. 1 Idle character bit count starts after stop bit. |
| 1 PE | Parity Enable Enables hardware parity generation and checking. When parity is enabled, the bit immediately before the stop bit is treated as the parity bit. 0 No hardware parity generation or checking. 1 Parity enabled. |
| 0 PT | Parity Type Provided parity is enabled (PE = 1), this bit selects even or odd parity. Odd parity means the total number of 1s in the data character, including the parity bit, is odd. Even parity means the total number of 1s in the data character, including the parity bit, is even. 0 Even parity. 1 Odd parity. |

39.2.4 LPUART Data Register (LPUARTx_DATA)

This register is actually two separate registers. Reads return the contents of the read-only receive data buffer and writes go to the write-only transmit data buffer. Reads and writes of this register are also involved in the automatic flag clearing mechanisms for some of the LPUART status flags.

Address: 4005_4000h base + Ch offset = 4005_400Ch

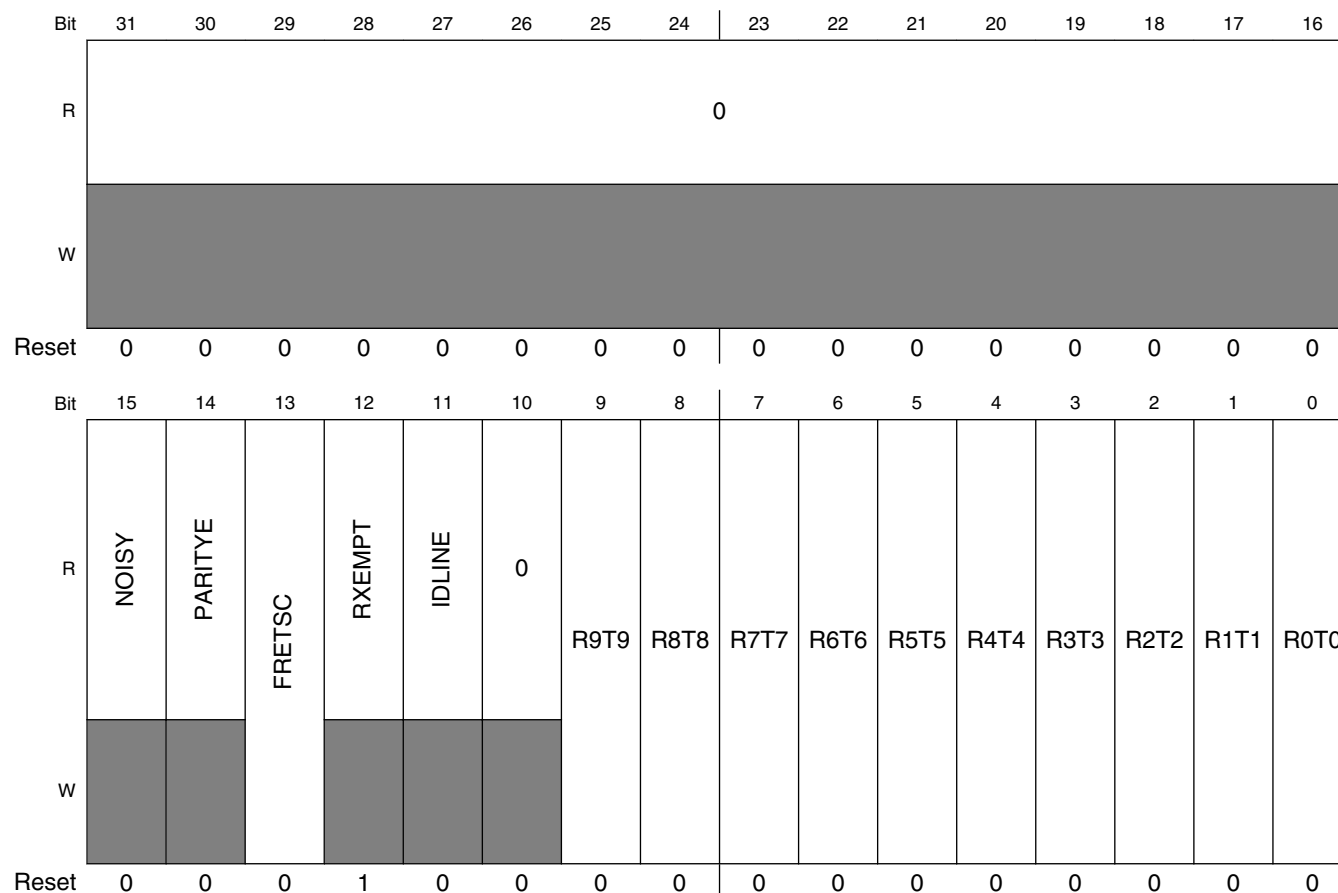

LPUARTx_DATA field descriptions

| Field | Description |
|-------------------|--|
| 31–16 Reserved | This field is reserved. This read-only field is reserved and always has the value 0. |
| 15 NOISY | The current received dataword contained in DATA[R9:R0] was received with noise. 0 The dataword was received without noise. 1 The data was received with noise. |

Table continues on the next page...

LPUARTx_DATA field descriptions (continued)

| Field | Description |
|----------------|---|
| 14 PARITYE | The current received dataword contained in DATA[R9:R0] was received with a parity error. 0 The dataword was received without a parity error. 1 The dataword was received with a parity error. |
| 13 FRETSC | Frame Error / Transmit Special Character For reads, indicates the current received dataword contained in DATA[R9:R0] was received with a frame error. For writes, indicates a break or idle character is to be transmitted instead of the contents in DATA[T9:T0]. T9 is used to indicate a break character when 0 and a idle character when 1, he contents of DATA[T8:T0] should be zero. 0 The dataword was received without a frame error on read, transmit a normal character on write. 1 The dataword was received with a frame error, transmit an idle or break character on transmit. |
| 12 RXEMPT | Receive Buffer Empty Asserts when there is no data in the receive buffer. This field does not take into account data that is in the receive shift register. 0 Receive buffer contains valid data. 1 Receive buffer is empty, data returned on read is not valid. |
| 11 IDLINE | Idle Line Indicates the receiver line was idle before receiving the character in DATA[9:0]. Unlike the IDLE flag, this bit can set for the first character received when the receiver is first enabled. 0 Receiver was not idle before receiving this character. 1 Receiver was idle before receiving this character. |
| 10 Reserved | This field is reserved. This read-only field is reserved and always has the value 0. |
| 9 R9T9 | Read receive data buffer 9 or write transmit data buffer 9. |
| 8 R8T8 | Read receive data buffer 8 or write transmit data buffer 8. |
| 7 R7T7 | Read receive data buffer 7 or write transmit data buffer 7. |
| 6 R6T6 | Read receive data buffer 6 or write transmit data buffer 6. |
| 5 R5T5 | Read receive data buffer 5 or write transmit data buffer 5. |
| 4 R4T4 | Read receive data buffer 4 or write transmit data buffer 4. |
| 3 R3T3 | Read receive data buffer 3 or write transmit data buffer 3. |
| 2 R2T2 | Read receive data buffer 2 or write transmit data buffer 2. |
| 1 R1T1 | Read receive data buffer 1 or write transmit data buffer 1. |
| 0 R0T0 | Read receive data buffer 0 or write transmit data buffer 0. |

39.2.5 LPUART Match Address Register (LPUARTx_MATCH)

Address: 4005_4000h base + 10h offset = 4005_4010h

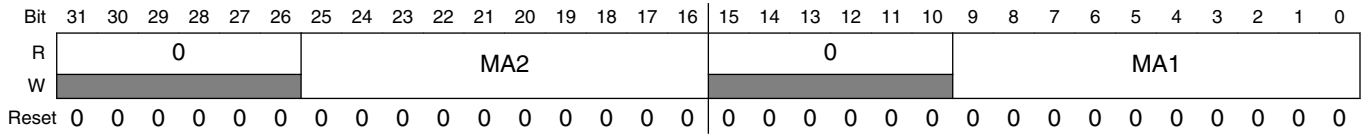

LPUARTx_MATCH field descriptions

| Field | Description |
|-------------------|--|
| 31–26 Reserved | This field is reserved. This read-only field is reserved and always has the value 0. |
| 25–16 MA2 | Match Address 2 The MA1 and MA2 registers are compared to input data addresses when the most significant bit is set and the associated BAUD[MAEN] bit is set. If a match occurs, the following data is transferred to the data register. If a match fails, the following data is discarded. Software should only write a MA register when the associated BAUD[MAEN] bit is clear. |
| 15–10 Reserved | This field is reserved. This read-only field is reserved and always has the value 0. |
| MA1 | Match Address 1 The MA1 and MA2 registers are compared to input data addresses when the most significant bit is set and the associated BAUD[MAEN] bit is set. If a match occurs, the following data is transferred to the data register. If a match fails, the following data is discarded. Software should only write a MA register when the associated BAUD[MAEN] bit is clear. |

39.2.6 LPUART Modem IrDA Register (LPUARTx_MODIR)

The MODEM register controls options for setting the modem configuration.

Address: 4005_4000h base + 14h offset = 4005_4014h

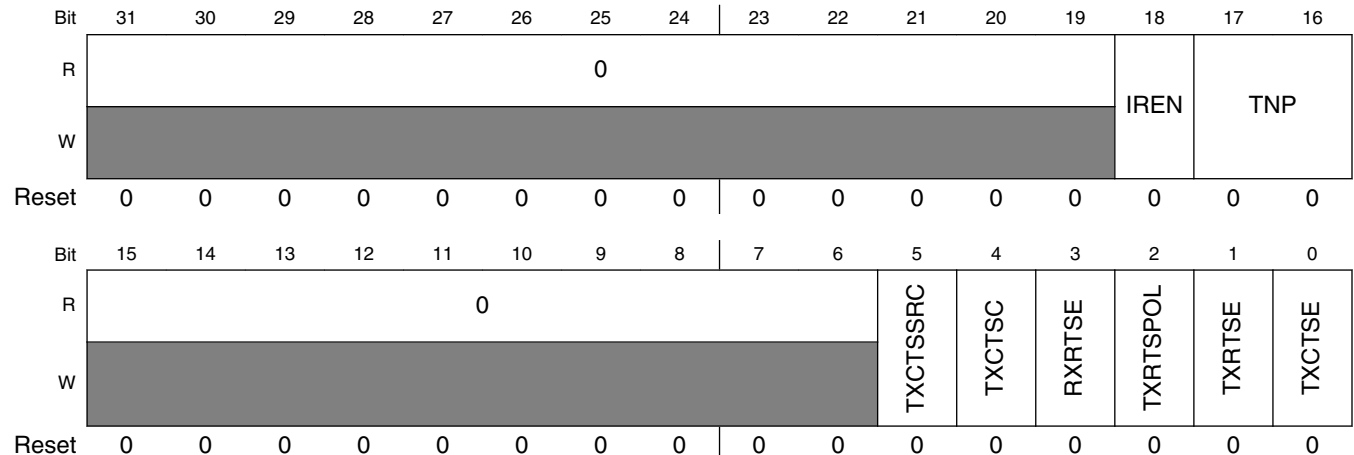

LPUARTx_MODIR field descriptions

| Field | Description |
|-------------------|---|
| 31–19 Reserved | This field is reserved. This read-only field is reserved and always has the value 0. |
| 18 IREN | Infrared enable Enables/disables the infrared modulation/demodulation. 0 IR disabled. 1 IR enabled. |
| 17–16 TNP | Transmitter narrow pulse Enables whether the LPUART transmits a 1/OSR, 2/OSR, 3/OSR or 4/OSR narrow pulse. 00 1/OSR. 01 2/OSR. 10 3/OSR. 11 4/OSR. |
| 15–6 Reserved | This field is reserved. This read-only field is reserved and always has the value 0. |
| 5 TXCTSSRC | Transmit CTS Source Configures the source of the CTS input. 0 CTS input is the LPUART_CTS pin. 1 CTS input is the inverted Receiver Match result. |
| 4 TXCTSC | Transmit CTS Configuration Configures if the CTS state is checked at the start of each character or only when the transmitter is idle. 0 CTS input is sampled at the start of each character. 1 CTS input is sampled when the transmitter is idle. |
| 3 RXRTSE | Receiver request-to-send enable Allows the RTS output to control the CTS input of the transmitting device to prevent receiver overrun. NOTE: Do not set both RXRTSE and TXRTSE. 0 The receiver has no effect on RTS. 1 RTS assertion is configured by the RTSWATER field |
| 2 TXRTSPOL | Transmitter request-to-send polarity Controls the polarity of the transmitter RTS. TXRTSPOL does not affect the polarity of the receiver RTS. RTS will remain negated in the active low state unless TXRTSE is set. 0 Transmitter RTS is active low. 1 Transmitter RTS is active high. |
| 1 TXRTSE | Transmitter request-to-send enable Controls RTS before and after a transmission. |

Table continues on the next page...

LPUARTx_MODIR field descriptions (continued)

| Field | Description |
|-------------|---|
| | 0 The transmitter has no effect on RTS. 1 When a character is placed into an empty transmitter data buffer , RTS asserts one bit time before the start bit is transmitted. RTS deasserts one bit time after all characters in the transmitter data buffer and shift register are completely sent, including the last stop bit. |
| 0 TXCTSE | Transmitter clear-to-send enable TXCTSE controls the operation of the transmitter. TXCTSE can be set independently from the state of TXRTSE and RXRTSE. 0 CTS has no effect on the transmitter. 1 Enables clear-to-send operation. The transmitter checks the state of CTS each time it is ready to send a character. If CTS is asserted, the character is sent. If CTS is deasserted, the signal TXD remains in the mark state and transmission is delayed until CTS is asserted. Changes in CTS as a character is being sent do not affect its transmission. |

39.3 Functional description

The LPUART supports full-duplex, asynchronous, NRZ serial communication and comprises a baud rate generator, transmitter, and receiver block. The transmitter and receiver operate independently, although they use the same baud rate generator. The following describes each of the blocks of the LPUART.

39.3.1 Baud rate generation

A 13-bit modulus counter in the baud rate generator derive the baud rate for both the receiver and the transmitter. The value from 1 to 8191 written to SBR[12:0] determines the baud clock divisor for the asynchronous LPUART baud clock. The SBR bits are in the LPUART baud rate registers, BDH and BDL. The baud rate clock drives the receiver, while the transmitter is driven by the baud rate clock divided by the over sampling ratio. Depending on the over sampling ratio, the receiver has an acquisition rate of 4 to 32 samples per bit time.

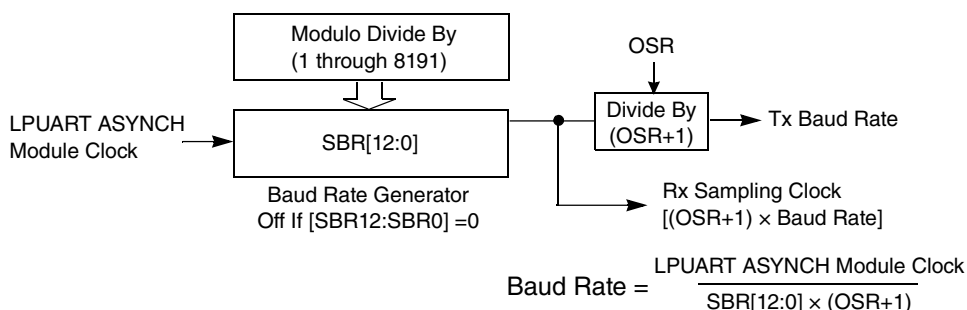

Figure 39-3. LPUART baud rate generation

Baud rate generation is subject to two sources of error:

- Integer division of the asynchronous LPUART baud clock may not give the exact target frequency.
- Synchronization with the asynchronous LPUART baud clock can cause phase shift.

39.3.2 Transmitter functional description

This section describes the overall block diagram for the LPUART transmitter, as well as specialized functions for sending break and idle characters.

The transmitter output (LPUART_TX) idle state defaults to logic high, CTRL[TXINV] is cleared following reset. The transmitter output is inverted by setting CTRL[TXINV]. The transmitter is enabled by setting the CTRL[TE] bit. This queues a preamble character that is one full character frame of the idle state. The transmitter then remains idle until data is available in the transmit data buffer. Programs store data into the transmit data buffer by writing to the LPUART data register.

The central element of the LPUART transmitter is the transmit shift register that is 10-bit to 13 bits long depending on the setting in the CTRL[M], BAUD[M10] and BAUD[SBNS] control bits. For the remainder of this section, assume CTRL[M], BAUD[M10] and BAUD[SBNS] are cleared, selecting the normal 8-bit data mode. In 8-bit data mode, the shift register holds a start bit, eight data bits, and a stop bit. When the transmit shift register is available for a new character, the value waiting in the transmit data register is transferred to the shift register, synchronized with the baud rate clock, and the transmit data register empty (STAT[TDRE]) status flag is set to indicate another character may be written to the transmit data buffer at LPUART_DATA.

If no new character is waiting in the transmit data buffer after a stop bit is shifted out the LPUART_TX pin, the transmitter sets the transmit complete flag and enters an idle mode, with LPUART_TX high, waiting for more characters to transmit.

Writing 0 to CTRL[TE] does not immediately disable the transmitter. The current transmit activity in progress must first be completed (that could include a data character, idle character or break character), although the transmitter will not start transmitting another character.

39.3.2.1 Send break and queued idle

The LPUART_CTRL[SBK] bit sends break characters originally used to gain the attention of old teletype receivers. Break characters are a full character time of logic 0, 10-bit to 12-bit times including the start and stop bits. A longer break of 13-bit times can be enabled by setting LPUART_STAT[BRK13]. Normally, a program would wait for LPUART_STAT[TDRE] to become set to indicate the last character of a message has moved to the transmit shifter, write 1, and then write 0 to the LPUART_CTRL[SBK] bit. This action queues a break character to be sent as soon as the shifter is available. If LPUART_CTRL[SBK] remains 1 when the queued break moves into the shifter, synchronized to the baud rate clock, an additional break character is queued. If the receiving device is another LPUART, the break characters are received as 0s in all data bits and a framing error (LPUART_STAT[FE] = 1) occurs.

A break character can also be transmitted by writing to the LPUART_DATA register with bit 13 set and the data bits clear. This supports transmitting the break character as part of the normal data stream and also allows the DMA to transmit a break character.

When idle-line wakeup is used, a full character time of idle (logic 1) is needed between messages to wake up any sleeping receivers. Normally, a program would wait for LPUART_STAT[TDRE] to become set to indicate the last character of a message has moved to the transmit shifter, then write 0 and then write 1 to the LPUART_CTRL[TE] bit. This action queues an idle character to be sent as soon as the shifter is available. As long as the character in the shifter does not finish while LPUART_CTRL[TE] is cleared, the LPUART transmitter never actually releases control of the LPUART_TX pin.

An idle character can also be transmitted by writing to the LPUART_DATA register with bit 13 set and the data bits also set. This supports transmitting the idle character as part of the normal data stream and also allows the DMA to transmit a break character.

The length of the break character is affected by the LPUART_STAT[BRK13], LPUART_CTRL[M], LPUART_BAUD[M10] and LPUART_BAUD[SNBS] bits as shown below.

Table 39-1. Break character length

| BRK13 | M | M10 | SBNS | Break character length |
|-------|---|-----|------|------------------------|
| 0 | 0 | 0 | 0 | 10 bit times |
| 0 | 0 | 0 | 1 | 11 bit times |
| 0 | 1 | 0 | 0 | 11 bit times |
| 0 | 1 | 0 | 1 | 12 bit times |
| 0 | X | 1 | 0 | 12 bit times |
| 0 | X | 1 | 1 | 13 bit times |
| 1 | 0 | 0 | 0 | 13 bit times |
| 1 | 0 | 0 | 1 | 13 bit times |
| 1 | 1 | 0 | 0 | 14 bit times |
| 1 | 1 | 0 | 1 | 14 bit times |
| 1 | X | 1 | 0 | 15 bit times |
| 1 | X | 1 | 1 | 15 bit times |

39.3.2.2 Hardware flow control

The transmitter supports hardware flow control by gating the transmission with the value of CTS. If the clear-to-send operation is enabled, the character is transmitted when CTS is asserted. If CTS is deasserted in the middle of a transmission with characters remaining in the receiver data buffer, the character in the shift register is sent and LPUART_TX remains in the mark state until CTS is reasserted.

If the clear-to-send operation is disabled, the transmitter ignores the state of CTS.

The transmitter's CTS signal can also be enabled even if the same LPUART receiver's RTS signal is disabled.

39.3.2.3 Transceiver driver enable

The transmitter can use LPUART_RTS as an enable signal for the driver of an external transceiver. See [Transceiver driver enable using LPUART_RTS](#) for details. If the request-to-send operation is enabled, when a character is placed into an empty transmitter data buffer, LPUART_RTS asserts one bit time before the start bit is transmitted. LPUART_RTS remains asserted for the whole time that the transmitter data buffer has any characters. LPUART_RTS deasserts one bit time after all characters in the transmitter data buffer and shift register are completely sent, including the last stop bit. Transmitting a break character also asserts LPUART_RTS, with the same assertion and deassertion timing as having a character in the transmitter data buffer.

The transmitter's LPUART_RTS signal asserts only when the transmitter is enabled. However, the transmitter's LPUART_RTS signal is unaffected by its LPUART_CTS signal. LPUART_RTS will remain asserted until the transfer is completed, even if the transmitter is disabled mid-way through a data transfer.

39.3.2.4 Transceiver driver enable using LPUART_RTS

RS-485 is a multiple drop communication protocol in which the LPUART transceiver's driver is 3-stated unless the UART is driving. The LPUART_RTS signal can be used by the transmitter to enable the driver of a transceiver. The polarity of LPUART_RTS can be matched to the polarity of the transceiver's driver enable signal.

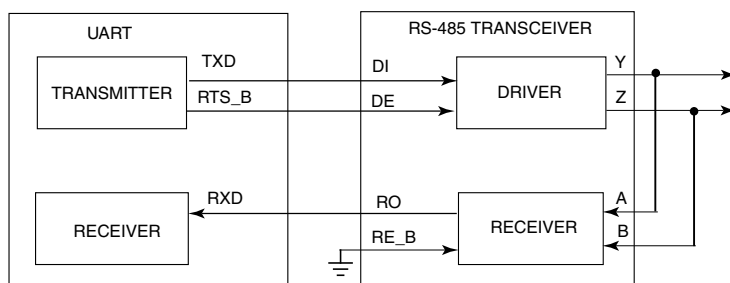

Figure 39-4. Transceiver driver enable using LPUART_RTS

In the figure, the receiver enable signal is asserted. Another option for this connection is to connect LPUART_RTS to both DE and RE_B. The transceiver's receiver is disabled while driving. A pullup can pull LPUART_RX to a non-floating value during this time. This option can be refined further by operating the LPUART in single wire mode, freeing the LPUART_RX pin for other uses.

39.3.3 Receiver functional description

In this section, the receiver block diagram is a guide for the overall receiver functional description. Next, the data sampling technique used to reconstruct receiver data is described in more detail. Finally, different variations of the receiver wakeup function are explained.

The receiver input is inverted by setting LPUART_STAT[RXINV]. The receiver is enabled by setting the LPUART_CTRL[RE] bit. Character frames consist of a start bit of logic 0, eight to ten data bits (msb or lsb first), and one or two stop bits of logic 1. For information about 9-bit or 10-bit data mode, refer to [8-bit, 9-bit and 10-bit data modes](#). For the remainder of this discussion, assume the LPUART is configured for normal 8-bit data mode.

After receiving the stop bit into the receive shifter, and provided the receive data register is not already full, the data character is transferred to the receive data register and the receive data register full (LPUART_STAT[RDRF]) status flag is set. If

LPUART_STAT[RDRF] was already set indicating the receive data register (buffer) was already full, the overrun (OR) status flag is set and the new data is lost. Because the LPUART receiver is double-buffered, the program has one full character time after LPUART_STAT[RDRF] is set before the data in the receive data buffer must be read to avoid a receiver overrun.

When a program detects that the receive data register is full (LPUART_STAT[RDRF] = 1), it gets the data from the receive data register by reading LPUART_DATA. Refer to [Interrupts and status flags](#) for details about flag clearing.

39.3.3.1 Data sampling technique

The LPUART receiver supports a configurable oversampling rate of between $4\times$ and $32\times$ of the baud rate clock for sampling. The receiver starts by taking logic level samples at the oversampling rate times the baud rate to search for a falling edge on the LPUART_RX serial data input pin. A falling edge is defined as a logic 0 sample after three consecutive logic 1 samples. The oversampling baud rate clock divides the bit time into 4 to 32 segments from 1 to OSR (where OSR is the configured oversampling ratio). When a falling edge is located, three more samples are taken at $(OSR/2)$, $(OSR/2)+1$, and $(OSR/2)+2$ to make sure this was a real start bit and not merely noise. If at least two of these three samples are 0, the receiver assumes it is synchronized to a received character. If another falling edge is detected before the receiver is considered synchronized, the receiver restarts the sampling from the first segment.

The receiver then samples each bit time, including the start and stop bits, at $(OSR/2)$, $(OSR/2)+1$, and $(OSR/2)+2$ to determine the logic level for that bit. The logic level is interpreted to be that of the majority of the samples taken during the bit time. If any sample in any bit time, including the start and stop bits, in a character frame fails to agree with the logic level for that bit, the noise flag (LPUART_STAT[NF]) is set when the received character is transferred to the receive data buffer.

When the LPUART receiver is configured to sample on both edges of the baud rate clock, the number of segments in each received bit is effectively doubled (from 1 to $OSR\times 2$). The start and data bits are then sampled at OSR, OSR+1 and OSR+2. Sampling on both edges of the clock must be enabled for oversampling rates of $4\times$ to $7\times$ and is optional for higher oversampling rates.

The falling edge detection logic continuously looks for falling edges. If an edge is detected, the sample clock is resynchronized to bit times (unless resynchronization has been disabled). This improves the reliability of the receiver in the presence of noise or mismatched baud rates. It does not improve worst case analysis because some characters do not have any extra falling edges anywhere in the character frame.

In the case of a framing error, provided the received character was not a break character, the sampling logic that searches for a falling edge is filled with three logic 1 samples so that a new start bit can be detected almost immediately.

39.3.3.2 Receiver wakeup operation

Receiver wakeup and receiver address matching is a hardware mechanism that allows an LPUART receiver to ignore the characters in a message intended for a different receiver.

During receiver wakeup, all receivers evaluate the first character(s) of each message, and as soon as they determine the message is intended for a different receiver, they write logic 1 to the receiver wake up control bit (LPUART_CTRL[RWU]). When RWU bit and LPUART_S2[RWUID] bit are set, the status flags associated with the receiver, with the exception of the idle bit, IDLE, are inhibited from setting, thus eliminating the software overhead for handling the unimportant message characters. At the end of a message, or at the beginning of the next message, all receivers automatically force LPUART_CTRL[RWU] to 0 so all receivers wake up in time to look at the first character(s) of the next message.

During receiver address matching, the address matching is performed in hardware and the LPUART receiver will ignore all characters that do not meet the address match requirements.

Table 39-2. Receiver Wakeup Options

| RWU | MA1 MA2 | MATCFG | WAKE:RWUID | Receiver Wakeup |
|-----|-----------|--------|------------|---|
| 0 | 0 | X | X | Normal operation |
| 1 | 0 | 00 | 00 | Receiver wakeup on idle line, IDLE flag not set |
| 1 | 0 | 00 | 01 | Receiver wakeup on idle line, IDLE flag set |
| 1 | 0 | 00 | 10 | Receiver wakeup on address mark |
| 1 | 1 | 11 | X0 | Receiver wakeup on data match |
| 0 | 1 | 00 | X0 | Address mark address match, IDLE flag not set |

Table continues on the next page...

Table 39-2. Receiver Wakeup Options (continued)

| RWU | MA1 MA2 | MATCFG | WAKE:RWUID | Receiver Wakeup |
|-----|-----------|--------|------------|--|
| | | | | for discarded characters |
| 0 | 1 | 00 | X1 | Address mark address match, IDLE flag set for discarded characters |
| 0 | 1 | 01 | X0 | Idle line address match |
| 0 | 1 | 10 | X0 | Address match on and address match off, IDLE flag not set for discarded characters |
| 0 | 1 | 10 | X1 | Address match on and address match off, IDLE flag set for discarded characters |

39.3.3.2.1 Idle-line wakeup

When wake is cleared, the receiver is configured for idle-line wakeup. In this mode, LPUART_CTRL[RWU] is cleared automatically when the receiver detects a full character time of the idle-line level. The LPUART_CTRL[M] and LPUART_BAUD[M10] control bit selects 8-bit to 10-bit data mode and the LPUART_BAUD[SBNS] bit selects 1-bit or 2-bit stop bit number that determines how many bit times of idle are needed to constitute a full character time, 10 to 13 bit times because of the start and stop bits.

When LPUART_CTRL[RWU] is one and LPUART_STAT[RWUID] is zero, the idle condition that wakes up the receiver does not set the LPUART_STAT[IDLE] flag. The receiver wakes up and waits for the first data character of the next message that sets the LPUART_STAT[RDRF] flag and generates an interrupt if enabled. When LPUART_STAT[RWUID] is one, any idle condition sets the LPUART_STAT[IDLE] flag and generates an interrupt if enabled, regardless of whether LPUART_CTRL[RWU] is zero or one.

The idle-line type (LPUART_CTRL[ILT]) control bit selects one of two ways to detect an idle line. When LPUART_CTRL[ILT] is cleared, the idle bit counter starts after the start bit so the stop bit and any logic 1s at the end of a character count toward the full character time of idle. When LPUART_CTRL[ILT] is set, the idle bit counter does not start until after the stop bit time, so the idle detection is not affected by the data in the last character of the previous message.

39.3.3.2.2 Address-mark wakeup

When LPUART_CTRL[WAKE] is set, the receiver is configured for address-mark wakeup. In this mode, LPUART_CTRL[RWU] is cleared automatically when the receiver detects a logic 1 in the most significant bit of a received character.

Address-mark wakeup allows messages to contain idle characters, but requires the MSB be reserved for use in address frames. The logic 1 in the MSB of an address frame clears the LPUART_CTRL[RWU] bit before the stop bits are received and sets the LPUART_STAT[RDRF] flag. In this case, the character with the MSB set is received even though the receiver was sleeping during most of this character time.

39.3.3.2.3 Data match wakeup

When LPUART_CTRL[RWU] is set and LPUART_BAUD[MATCFG] equals 11, the receiver is configured for data match wakeup. In this mode, LPUART_CTRL[RWU] is cleared automatically when the receiver detects a character that matches MATCH[MA1] field when BAUD[MAEN1] is set, or that matches MATCH[MA2] when BAUD[MAEN2] is set.

39.3.3.2.4 Address Match operation

Address match operation is enabled when the LPUART_BAUD[MAEN1] or LPUART_BAUD[MAEN2] bit is set and LPUART_BAUD[MATCFG] is equal to 00. In this function, a character received by the LPUART_RX pin with a logic 1 in the bit position immediately preceding the stop bit is considered an address and is compared with the associated MATCH[MA1] or MATCH[MA2] field. The character is only transferred to the receive buffer, and LPUART_STAT[RDRF] is set, if the comparison matches. All subsequent characters received with a logic 0 in the bit position immediately preceding the stop bit are considered to be data associated with the address and are transferred to the receive data buffer. If no marked address match occurs then no transfer is made to the receive data buffer, and all following characters with logic zero in the bit position immediately preceding the stop bit are also discarded. If both the LPUART_BAUD[MAEN1] and LPUART_BAUD[MAEN2] bits are negated, the receiver operates normally and all data received is transferred to the receive data buffer.

Address match operation functions in the same way for both MATCH[MA1] and MATCH[MA2] fields.

- If only one of LPUART_BAUD[MAEN1] and LPUART_BAUD[MAEN2] is asserted, a marked address is compared only with the associated match register and data is transferred to the receive data buffer only on a match.
- If LPUART_BAUD[MAEN1] and LPUART_BAUD[MAEN2] are asserted, a marked address is compared with both match registers and data is transferred only on a match with either register.

39.3.3.2.5 Idle Match operation

Idle match operation is enabled when the LPUART_BAUD[MAEN1] or LPUART_BAUD[MAEN2] bit is set and LPUART_BAUD[MATCFG] is equal to 01. In this function, the first character received by the LPUART_RX pin after an idle line condition is considered an address and is compared with the associated MA1 or MA2 register. The character is only transferred to the receive buffer, and LPUART_STAT[RDRF] is set, if the comparison matches. All subsequent characters are considered to be data associated with the address and are transferred to the receive data buffer until the next idle line condition is detected. If no address match occurs then no transfer is made to the receive data buffer, and all following frames until the next idle condition are also discarded. If both the LPUART_BAUD[MAEN1] and LPUART_BAUD[MAEN2] bits are negated, the receiver operates normally and all data received is transferred to the receive data buffer.

Idle match operation functions in the same way for both MA1 and MA2 registers.

- If only one of LPUART_BAUD[MAEN1] and LPUART_BAUD[MAEN2] is asserted, the first character after an idle line is compared only with the associated match register and data is transferred to the receive data buffer only on a match.
- If LPUART_BAUD[MAEN1] and LPUART_BAUD[MAEN2] are asserted, the first character after an idle line is compared with both match registers and data is transferred only on a match with either register.

39.3.3.2.6 Match On Match Off operation

Match on, match off operation is enabled when both LPUART_BAUD[MAEN1] and LPUART_BAUD[MAEN2] are set and LPUART_BAUD[MATCFG] is equal to 10. In this function, a character received by the LPUART_RX pin that matches MATCH[MA1] is received and transferred to the receive buffer, and LPUART_STAT[RDRF] is set. All subsequent characters are considered to be data and are also transferred to the receive data buffer, until a character is received that matches MATCH[MA2] register. The character that matches MATCH[MA2] and all following characters are discarded, this

continues until another character that matches MATCH[MA1] is received. If both the LPUART_BAUD[MAEN1] and LPUART_BAUD[MAEN2] bits are negated, the receiver operates normally and all data received is transferred to the receive data buffer.

NOTE

Match on, match off operation requires both LPUART_BAUD[MAEN1] and LPUART_BAUD[MAEN2] to be asserted.

39.3.3.3 Hardware flow control

To support hardware flow control, the receiver can be programmed to automatically deassert and assert LPUART_RTS.

- LPUART_RTS remains asserted until the transfer is complete, even if the transmitter is disabled midway through a data transfer. See [Transceiver driver enable using LPUART_RTS](#) for more details.
- If the receiver request-to-send functionality is enabled, the receiver automatically deasserts LPUART_RTS if the number of characters in the receiver data register is full or a start bit is detected that will cause the receiver data register to be full.
- The receiver asserts LPUART_RTS when the number of characters in the receiver data register is not full and has not detected a start bit that will cause the receiver data register to be full. It is not affected if STAT[RDRF] is asserted.
- Even if LPUART_RTS is deasserted, the receiver continues to receive characters until the receiver data buffer is overrun.
- If the receiver request-to-send functionality is disabled, the receiver LPUART_RTS remains deasserted.

39.3.3.4 Infrared decoder

The infrared decoder converts the received character from the IrDA format to the NRZ format used by the receiver. It also has a OSR oversampling baud rate clock counter that filters noise and indicates when a 1 is received.

39.3.3.4.1 Start bit detection

When STAT[RXINV] is cleared, the first falling edge of the received character corresponds to the start bit. The infrared decoder resets its counter. At this time, the receiver also begins its start bit detection process. After the start bit is detected, the

receiver synchronizes its bit times to this start bit time. For the rest of the character reception, the infrared decoder's counter and the receiver's bit time counter count independently from each other.

39.3.3.4.2 Noise filtering

Any further rising edges detected during the first half of the infrared decoder counter are ignored by the decoder. Any pulses less than one oversampling baud clock can be undetected by it regardless of whether it is seen in the first or second half of the count.

39.3.3.4.3 Low-bit detection

During the second half of the decoder count, a rising edge is decoded as a 0, which is sent to the receiver. The decoder counter is also reset.

39.3.3.4.4 High-bit detection

At OSR oversampling baud rate clocks after the previous rising edge, if a rising edge is not seen, then the decoder sends a 1 to the receiver.

If the next bit is a 0, which arrives late, then a low-bit is detected according to [Low-bit detection](#). The value sent to the receiver is changed from 1 to a 0. Then, if a noise pulse occurs outside the receiver's bit time sampling period, then the delay of a 0 is not recorded as noise.

39.3.4 Additional LPUART functions

The following sections describe additional LPUART functions.

39.3.4.1 8-bit, 9-bit and 10-bit data modes

The LPUART transmitter and receiver can be configured to operate in 9-bit data mode by setting the LPUART_CTRL[M] or 10-bit data mode by setting LPUART_CTRL[M10]. In 9-bit mode, there is a ninth data bit in 10-bit mode there is a tenth data bit. For the transmit data buffer, these bits are stored in LPUART_CTRL[T8] and LPUART_CTRL[T9]. For the receiver, these bits are held in LPUART_CTRL[R8] and LPUART_CTRL[R9]. They are also accessible via 16-bit or 32-bit accesses to the LPUART_DATA register.

For coherent 8-bit writes to the transmit data buffer, write to LPUART_CTRL[T8] and LPUART_CTRL[T9] before writing to LPUART_DATA[7:0]. For 16-bit and 32-bit writes to the LPUART_DATA register all 10 transmit bits are written to the transmit data buffer at the same time.

If the bit values to be transmitted as the ninth and tenth bit of a new character are the same as for the previous character, it is not necessary to write to LPUART_CTRL[T8] and LPUART_CTRL[T9] again. When data is transferred from the transmit data buffer to the transmit shifter, the value in LPUART_CTRL[T8] and LPUART_CTRL[T9] is copied at the same time data is transferred from LPUART_DATA[7:0] to the shifter.

The 9-bit data mode is typically used with parity to allow eight bits of data plus the parity in the ninth bit, or it is used with address-mark wakeup so the ninth data bit can serve as the wakeup bit. The 10-bit data mode is typically used with parity and address-mark wakeup so the ninth data bit can serve as the wakeup bit and the tenth bit as the parity bit. In custom protocols, the ninth and/or tenth bits can also serve as software-controlled markers.

39.3.4.2 Idle length

An idle character is a character where the start bit, all data bits and stop bits are in the mark position. The CTRL[ILT] register can be configured to start detecting an idle character from the previous start bit (any data bits and stop bits count towards the idle character detection) or from the previous stop bit.

The number of idle characters that must be received before an idle line condition is detected can also be configured using the CTRL[IDLECFG] field. This field configures the number of idle characters that must be received before the STAT[IDLE] flag is set, the STAT[RAF] flag is cleared and the DATA[IDLINE] flag is set with the next received character.

Idle-line wakeup and idle match operation are also affected by the CTRL[IDLECFG] field. When address match or match on/off operation is enabled, setting the STAT[RWUID] bit will cause any discarded characters to be treated as if they were idle characters.

39.3.4.3 Loop mode

When LPUART_CTRL[LOOPS] is set, the LPUART_CTRL[RSRC] bit in the same register chooses between loop mode (LPUART_CTRL[RSRC] = 0) or single-wire mode (LPUART_CTRL[RSRC] = 1). Loop mode is sometimes used to check software,

independent of connections in the external system, to help isolate system problems. In this mode, the transmitter output is internally connected to the receiver input and the LPUART_RX pin is not used by the LPUART.

39.3.4.4 Single-wire operation

When LPUART_CTRL[LOOPS] is set, the RSRC bit in the same register chooses between loop mode (LPUART_CTRL[RSRC] = 0) or single-wire mode (LPUART_CTRL[RSRC] = 1). Single-wire mode implements a half-duplex serial connection. The receiver is internally connected to the transmitter output and to the LPUART_TX pin (the LPUART_RX pin is not used).

In single-wire mode, the LPUART_CTRL[TXDIR] bit controls the direction of serial data on the LPUART_TX pin. When LPUART_CTRL[TXDIR] is cleared, the LPUART_TX pin is an input to the receiver and the transmitter is temporarily disconnected from the LPUART_TX pin so an external device can send serial data to the receiver. When LPUART_CTRL[TXDIR] is set, the LPUART_TX pin is an output driven by the transmitter, the internal loop back connection is disabled, and as a result the receiver cannot receive characters that are sent out by the transmitter.

39.3.5 Infrared interface

The LPUART provides the capability of transmitting narrow pulses to an IR LED and receiving narrow pulses and transforming them to serial bits, which are sent to the LPUART. The IrDA physical layer specification defines a half-duplex infrared communication link for exchanging data. The full standard includes data rates up to 16 Mbits/s. This design covers data rates only between 2.4 kbits/s and 115.2 kbits/s.

The LPUART has an infrared transmit encoder and receive decoder. The LPUART transmits serial bits of data that are encoded by the infrared submodule to transmit a narrow pulse for every zero bit. No pulse is transmitted for every one bit. When receiving data, the IR pulses are detected using an IR photo diode and transformed to CMOS levels by the IR receive decoder, external from the LPUART. The narrow pulses are then stretched by the infrared receive decoder to get back to a serial bit stream to be received by the LPUART. The polarity of transmitted pulses and expected receive pulses can be inverted so that a direct connection can be made to external IrDA transceiver modules that use active high pulses.

The infrared submodule receives its clock sources from the LPUART. One of these two clocks are selected in the infrared submodule to generate either 1/OSR, 2/OSR, 3/OSR, or 4/OSR narrow pulses during transmission.

39.3.5.1 Infrared transmit encoder

The infrared transmit encoder converts serial bits of data from transmit shift register to the LPUART_TX signal. A narrow pulse is transmitted for a zero bit and no pulse for a one bit. The narrow pulse is sent at the start of the bit with a duration of 1/OSR, 2/OSR, 3/OSR, or 4/OSR of a bit time. A narrow low pulse is transmitted for a zero bit when LPUART_CTRL[TXINV] is cleared, while a narrow high pulse is transmitted for a zero bit when LPUART_CTRL[TXINV] is set.

39.3.5.2 Infrared receive decoder

The infrared receive block converts data from the LPUART_RX signal to the receive shift register. A narrow pulse is expected for each zero received and no pulse is expected for each one received. A narrow low pulse is expected for a zero bit when LPUART_STAT[RXINV] is cleared, while a narrow high pulse is expected for a zero bit when LPUART_STAT[RXINV] is set. This receive decoder meets the edge jitter requirement as defined by the IrDA serial infrared physical layer specification.

39.3.6 Interrupts and status flags

The LPUART transmitter has two status flags that can optionally generate hardware interrupt requests. Transmit data register empty (LPUART_STAT[TDRE]) indicates when there is room in the transmit data buffer to write another transmit character to LPUART_DATA. If the transmit interrupt enable (LPUART_CTRL[TIE]) bit is set, a hardware interrupt is requested when LPUART_STAT[TDRE] is set. Transmit complete (LPUART_STAT[TC]) indicates that the transmitter is finished transmitting all data, preamble, and break characters and is idle with LPUART_TX at the inactive level. This flag is often used in systems with modems to determine when it is safe to turn off the modem. If the transmit complete interrupt enable (LPUART_CTRL[TCIE]) bit is set, a hardware interrupt is requested when LPUART_STAT[TC] is set. Instead of hardware interrupts, software polling may be used to monitor the LPUART_STAT[TDRE] and LPUART_STAT[TC] status flags if the corresponding LPUART_CTRL[TIE] or LPUART_CTRL[TCIE] local interrupt masks are cleared.

When a program detects that the receive data register is full (LPUART_STAT[RDRF] = 1), it gets the data from the receive data register by reading LPUART_DATA. The LPUART_STAT[RDRF] flag is cleared by reading LPUART_DATA.

The IDLE status flag includes logic that prevents it from getting set repeatedly when the LPUART_RX line remains idle for an extended period of time. IDLE is cleared by writing 1 to the LPUART_STAT[IDLE] flag. After LPUART_STAT[IDLE] has been cleared, it cannot become set again until the receiver has received at least one new character and has set LPUART_STAT[RDRF].

If the associated error was detected in the received character that caused LPUART_STAT[RDRF] to be set, the error flags - noise flag (LPUART_STAT[NF]), framing error (LPUART_STAT[FE]), and parity error flag (LPUART_STAT[PF]) - are set at the same time as LPUART_STAT[RDRF]. These flags are not set in overrun cases.

If LPUART_STAT[RDRF] was already set when a new character is ready to be transferred from the receive shifter to the receive data buffer, the overrun (LPUART_STAT[OR]) flag is set instead of the data along with any associated NF, FE, or PF condition is lost.

If the received character matches the contents of MATCH[MA1] and/or MATCH[MA2] then the LPUART_STAT[MA1F] and/or LPUART_STAT[MA2F] flags are set at the same time that LPUART_STAT[RDRF] is set.

At any time, an active edge on the LPUART_RX serial data input pin causes the LPUART_STAT[RXEDGIF] flag to set. The LPUART_STAT[RXEDGIF] flag is cleared by writing a 1 to it. This function depends on the receiver being enabled (LPUART_CTRL[RE] = 1).

39.4 LPUART changes

Chapter 40

Carrier Modulator Transmitter (CMT)

40.1 Introduction

The carrier modulator transmitter (CMT) module provides the means to generate the protocol timing and carrier signals for a wide variety of encoding schemes. The CMT incorporates hardware to off-load the critical and/or lengthy timing requirements associated with signal generation from the CPU, releasing much of its bandwidth to handle other tasks such as:

- Code data generation
- Data decompression, or,
- Keyboard scanning

The CMT does not include dedicated hardware configurations for specific protocols, but is intended to be sufficiently programmable in its function to handle the timing requirements of most protocols with minimal CPU intervention.

When the modulator is disabled, certain CMT registers can be used to change the state of the infrared output (IRO) signal directly. This feature allows for the generation of future protocol timing signals not readily producible by the current architecture.

40.2 Features

The features of this module include:

- Four modes of operation:
 - Time; with independent control of high and low times
 - Baseband
 - Frequency-shift key (FSK)
 - Direct software control of the IRO signal

Block diagram

- Extended space operation in Time, Baseband, and FSK modes
- Selectable input clock divider
- Interrupt on end-of-cycle
 - Ability to disable the IRO signal and use as timer interrupt

40.3 Block diagram

The following figure presents the block diagram of the CMT module.

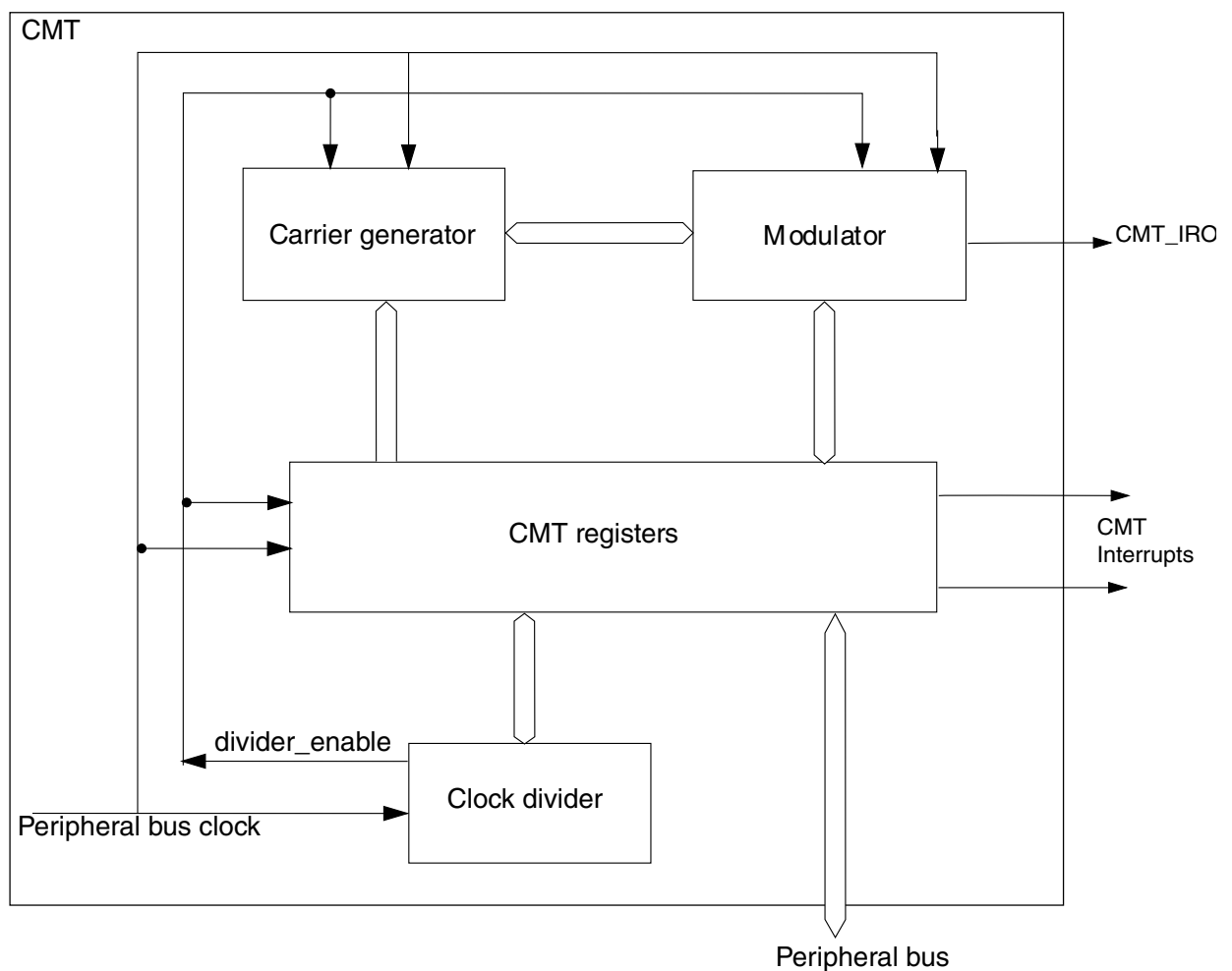

Figure 40-1. CMT module block diagram

40.4 Modes of operation

The following table describes the operation of the CMT module operates in various modes.

Table 40-1. Modes of operation

| Modes | Description |
|---------------------|--|
| Time | In Time mode, the user independently defines the high and low times of the carrier signal to determine both period and duty cycle |
| Baseband | When MSC[BASE] is set, the carrier output (f_{cg}) to the modulator is held high continuously to allow for the generation of baseband protocols. |
| Frequency-shift key | This mode allows the carrier generator to alternate between two sets of high and low times. When operating in FSK mode, the generator will toggle between the two sets when instructed by the modulator, allowing the user to dynamically switch between two carrier frequencies without CPU intervention. |

The following table summarizes the modes of operation of the CMT module.

Table 40-2. CMT modes of operation

| Mode | MSC[MCGEN] ¹ | MSC[BASE] | MSC[FSK] ² | MSC[EXSPC] | Comment |
|----------------|-------------------------|-----------|-----------------------|------------|---|
| Time | 1 | 0 | 0 | 0 | f_{cg} controlled by primary high and low registers. f_{cg} transmitted to the IRO signal when modulator gate is open. |
| Baseband | 1 | 1 | X | 0 | f_{cg} is always high. The IRO signal is high when the modulator gate is open. |
| FSK | 1 | 0 | 1 | 0 | f_{cg} control alternates between primary high/low registers and secondary high/low registers. f_{cg} transmitted to the IRO signal when modulator gate is open. |
| Extended Space | 1 | X | X | 1 | Setting MSC[EXSPC] causes subsequent modulator cycles to be spaces (modulator out not asserted) for the duration of the modulator period (mark and space times). |
| IRO Latch | 0 | X | X | X | OC[IROL] controls the state of the IRO signal. |

1. To prevent spurious operation, initialize all data and control registers before beginning a transmission when MSC[MCGEN]=1.
2. This field is not double-buffered and must not be changed during a transmission while MSC[MCGEN]=1.

NOTE

The assignment of module modes to core modes is chip-specific. For module-to-core mode assignments, see the chapter that describes how modules are configured.

40.4.1 Wait mode operation

During Wait mode, the CMT if enabled, will continue to operate normally. However, there is no change in operating modes of CMT during Wait mode, because the CPU is not operating.

40.4.2 Stop mode operation

This section describes the CMT Stop mode operations.

40.4.2.1 Normal Stop mode operation

During Normal Stop mode, clocks to the CMT module are halted. No registers are affected.

The CMT module will resume upon exit from Normal Stop mode because the clocks are halted. Software must ensure that the Normal Stop mode is not entered while the modulator is still in operation so as to prevent the IRO signal from being asserted while in Normal Stop mode. This may require a timeout period from the time that MSC[MCGEN] is cleared to allow the last modulator cycle to complete.

40.4.2.2 Low-Power Stop mode operation

During Low-Power Stop mode, the CMT module is completely powered off internally and the IRO signal state is latched and held at the time when the CMT enters this mode. To prevent the IRO signal from being asserted during Low-Power Stop mode, the software must assure that the signal is not active when entering Low-Power Stop mode. Upon wakeup from Low-Power Stop mode, the CMT module will be in the reset state.

40.5 CMT external signal descriptions

The following table shows the description of the external signal.

Table 40-3. CMT signal description

| Signal | Description | I/O |
|---------|-----------------|-----|
| CMT_IRO | Infrared Output | O |

40.5.1 CMT_IRO — Infrared Output

This output signal is driven by the modulator output when MSC[MCGEN] and OC[IROPEN] are set. The IRO signal starts a valid transmission with a delay, after MSC[MCGEN] bit be asserted to high, that can be calculated based on two register bits. [Table 40-4](#) shows how to calculate this delay.

The following table describes conditions for the IRO signal to be active.

| If | Then |
|---|--|
| MSC[MCGEN] is cleared and OC[IROPEN] is set | The signal is driven by OC[IROL] . This enables user software to directly control the state of the IRO signal by writing to OC[IROL] . |
| OC[IROPEN] is cleared | The signal is disabled and is not driven by the CMT module. Therefore, CMT can be configured as a modulo timer for generating periodic interrupts without causing signal activity. |

Table 40-4. CMT_IRO signal delay calculation

| Condition | Delay (bus clock cycles) |
|-----------------|--------------------------|
| MSC[CMTDIV] = 0 | PPS[PPSDIV] + 2 |
| MSC[CMTDIV] > 0 | (PPS[PPSDIV] *2) + 3 |

40.6 Memory map/register definition

The following registers control and monitor the CMT operation.

The address of a register is the sum of a base address and an address offset. The base address is defined at the chip level. The address offset is defined at the module level.

CMT memory map

| Absolute address (hex) | Register name | Width (in bits) | Access | Reset value | Section/page |
|------------------------|---|-----------------|--------|-------------|-----------------|
| 4006_2000 | CMT Carrier Generator High Data Register 1 (CMT_CGH1) | 8 | R/W | Undefined | 40.6.1/928 |
| 4006_2001 | CMT Carrier Generator Low Data Register 1 (CMT_CGL1) | 8 | R/W | Undefined | 40.6.2/929 |
| 4006_2002 | CMT Carrier Generator High Data Register 2 (CMT_CGH2) | 8 | R/W | Undefined | 40.6.3/929 |
| 4006_2003 | CMT Carrier Generator Low Data Register 2 (CMT_CGL2) | 8 | R/W | Undefined | 40.6.4/930 |
| 4006_2004 | CMT Output Control Register (CMT_OC) | 8 | R/W | 00h | 40.6.5/930 |
| 4006_2005 | CMT Modulator Status and Control Register (CMT_MSC) | 8 | R/W | 00h | 40.6.6/931 |
| 4006_2006 | CMT Modulator Data Register Mark High (CMT_CMD1) | 8 | R/W | Undefined | 40.6.7/933 |
| 4006_2007 | CMT Modulator Data Register Mark Low (CMT_CMD2) | 8 | R/W | Undefined | 40.6.8/934 |
| 4006_2008 | CMT Modulator Data Register Space High (CMT_CMD3) | 8 | R/W | Undefined | 40.6.9/934 |
| 4006_2009 | CMT Modulator Data Register Space Low (CMT_CMD4) | 8 | R/W | Undefined | 40.6.10/ 935 |
| 4006_200A | CMT Primary Prescaler Register (CMT_PPS) | 8 | R/W | 00h | 40.6.11/ 935 |
| 4006_200B | CMT Direct Memory Access Register (CMT_DMA) | 8 | R/W | 00h | 40.6.12/ 936 |

40.6.1 CMT Carrier Generator High Data Register 1 (CMT_CGH1)

This data register contains the primary high value for generating the carrier output.

Address: 4006_2000h base + 0h offset = 4006_2000h

| Bit | 7 | 6 | 5 | 4 | 3 | 2 | 1 | 0 |
|-------|----|----|----|----|----|----|----|----|
| Read | PH | | | | | | | |
| Write | PH | | | | | | | |
| Reset | x* | x* | x* | x* | x* | x* | x* | x* |

* Notes:

- x = Undefined at reset.

CMT_CGH1 field descriptions

| Field | Description |
|-------|---|
| PH | <p>Primary Carrier High Time Data Value</p> <p>Contains the number of input clocks required to generate the carrier high time period. When operating in Time mode, this register is always selected. When operating in FSK mode, this register and the secondary register pair are alternately selected under the control of the modulator. The primary carrier high time value is undefined out of reset. This register must be written to nonzero values before the carrier generator is enabled to avoid spurious results.</p> |

40.6.2 CMT Carrier Generator Low Data Register 1 (CMT_CGL1)

This data register contains the primary low value for generating the carrier output.

Address: 4006_2000h base + 1h offset = 4006_2001h

| | | | | | | | | |
|-------|----|----|----|----|----|----|----|----|
| Bit | 7 | 6 | 5 | 4 | 3 | 2 | 1 | 0 |
| Read | PL | | | | | | | |
| Write | PL | | | | | | | |
| Reset | x* | x* | x* | x* | x* | x* | x* | x* |

* Notes:

- x = Undefined at reset.

CMT_CGL1 field descriptions

| Field | Description |
|-------|--|
| PL | <p>Primary Carrier Low Time Data Value</p> <p>Contains the number of input clocks required to generate the carrier low time period. When operating in Time mode, this register is always selected. When operating in FSK mode, this register and the secondary register pair are alternately selected under the control of the modulator. The primary carrier low time value is undefined out of reset. This register must be written to nonzero values before the carrier generator is enabled to avoid spurious results.</p> |

40.6.3 CMT Carrier Generator High Data Register 2 (CMT_CGH2)

This data register contains the secondary high value for generating the carrier output.

Address: 4006_2000h base + 2h offset = 4006_2002h

| | | | | | | | | |
|-------|----|----|----|----|----|----|----|----|
| Bit | 7 | 6 | 5 | 4 | 3 | 2 | 1 | 0 |
| Read | SH | | | | | | | |
| Write | SH | | | | | | | |
| Reset | x* | x* | x* | x* | x* | x* | x* | x* |

* Notes:

- x = Undefined at reset.

CMT_CGH2 field descriptions

| Field | Description |
|-------|--|
| SH | <p>Secondary Carrier High Time Data Value</p> <p>Contains the number of input clocks required to generate the carrier high time period. When operating in Time mode, this register is never selected. When operating in FSK mode, this register and the primary register pair are alternately selected under control of the modulator.</p> |

CMT_CGH2 field descriptions (continued)

| Field | Description |
|-------|--|
| | The secondary carrier high time value is undefined out of reset. This register must be written to nonzero values before the carrier generator is enabled when operating in FSK mode. |

40.6.4 CMT Carrier Generator Low Data Register 2 (CMT_CGL2)

This data register contains the secondary low value for generating the carrier output.

Address: 4006_2000h base + 3h offset = 4006_2003h

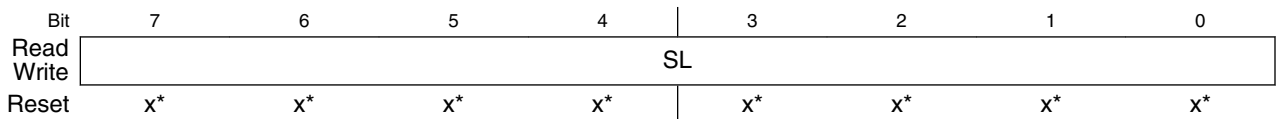

* Notes:

- x = Undefined at reset.

CMT_CGL2 field descriptions

| Field | Description |
|-------|--|
| SL | <p>Secondary Carrier Low Time Data Value</p> <p>Contains the number of input clocks required to generate the carrier low time period. When operating in Time mode, this register is never selected. When operating in FSK mode, this register and the primary register pair are alternately selected under the control of the modulator. The secondary carrier low time value is undefined out of reset. This register must be written to nonzero values before the carrier generator is enabled when operating in FSK mode.</p> |

40.6.5 CMT Output Control Register (CMT_OC)

This register is used to control the IRO signal of the CMT module.

Address: 4006_2000h base + 4h offset = 4006_2004h

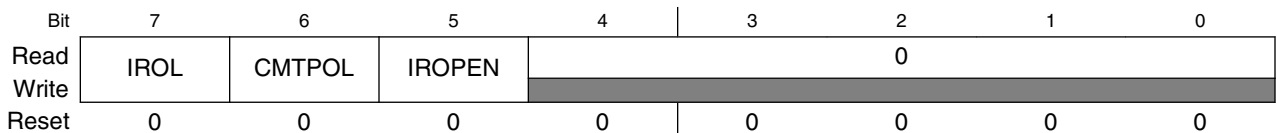

CMT_OC field descriptions

| Field | Description |
|-------------|---|
| 7 IROL | IRO Latch Control Reads the state of the IRO latch. Writing to IROL changes the state of the IRO signal when MSC[MCGEN] is cleared and IROPEN is set. |
| 6 CMTPOL | CMT Output Polarity Controls the polarity of the IRO signal. 0 The IRO signal is active-low. 1 The IRO signal is active-high. |
| 5 IROPEN | IRO Pin Enable Enables and disables the IRO signal. When the IRO signal is enabled, it is an output that drives out either the CMT transmitter output or the state of IROL depending on whether MSC[MCGEN] is set or not. Also, the state of output is either inverted or non-inverted, depending on the state of CMTPOL. When the IRO signal is disabled, it is in a high-impedance state and is unable to draw any current. This signal is disabled during reset. 0 The IRO signal is disabled. 1 The IRO signal is enabled as output. |
| Reserved | This field is reserved. This read-only field is reserved and always has the value 0. |

40.6.6 CMT Modulator Status and Control Register (CMT_MSC)

This register contains the modulator and carrier generator enable (MCGEN), end of cycle interrupt enable (EOCIE), FSK mode select (FSK), baseband enable (BASE), extended space (EXSPC), prescaler (CMTDIV) bits, and the end of cycle (EOCF) status bit.

Address: 4006_2000h base + 5h offset = 4006_2005h

| Bit | 7 | 6 | 5 | 4 | 3 | 2 | 1 | 0 |
|-------|------|--------|---|-------|------|-----|-------|-------|
| Read | EOCF | CMTDIV | | EXSPC | BASE | FSK | EOCIE | MCGEN |
| Write | | | | | | | | |
| Reset | 0 | 0 | 0 | 0 | 0 | 0 | 0 | 0 |

CMT_MSC field descriptions

| Field | Description |
|-----------|--|
| 7 EOCF | End Of Cycle Status Flag Sets when: |

Table continues on the next page...

CMT_MSC field descriptions (continued)

| Field | Description |
|---------------|---|
| | <ul style="list-style-type: none"> The modulator is not currently active and MCGEN is set to begin the initial CMT transmission. At the end of each modulation cycle while MCGEN is set. This is recognized when a match occurs between the contents of the space period register and the down counter. At this time, the counter is initialized with, possibly new contents of the mark period buffer, CMD1 and CMD2, and the space period register is loaded with, possibly new contents of the space period buffer, CMD3 and CMD4. <p>This flag is cleared by reading MSC followed by an access of CMD2 or CMD4, or by the DMA transfer.</p> <p>0 End of modulation cycle has not occurred since the flag last cleared. 1 End of modulator cycle has occurred.</p> |
| 6–5 CMTDIV | <p>CMT Clock Divide Prescaler</p> <p>Causes the CMT to be clocked at the IF signal frequency, or the IF frequency divided by 2, 4, or 8. This field must not be changed during a transmission because it is not double-buffered.</p> <p>00 IF ÷ 1 01 IF ÷ 2 10 IF ÷ 4 11 IF ÷ 8</p> |
| 4 EXSPC | <p>Extended Space Enable</p> <p>Enables the extended space operation.</p> <p>0 Extended space is disabled. 1 Extended space is enabled.</p> |
| 3 BASE | <p>Baseband Enable</p> <p>When set, BASE disables the carrier generator and forces the carrier output high for generation of baseband protocols. When BASE is cleared, the carrier generator is enabled and the carrier output toggles at the frequency determined by values stored in the carrier data registers. This field is cleared by reset. This field is not double-buffered and must not be written to during a transmission.</p> <p>0 Baseband mode is disabled. 1 Baseband mode is enabled.</p> |
| 2 FSK | <p>FSK Mode Select</p> <p>Enables FSK operation.</p> <p>0 The CMT operates in Time or Baseband mode. 1 The CMT operates in FSK mode.</p> |
| 1 EOCIE | <p>End of Cycle Interrupt Enable</p> <p>Requests to enable a CPU interrupt when EOCF is set if EOCIE is high.</p> |

Table continues on the next page...

CMT_MSC field descriptions (continued)

| Field | Description |
|------------|---|
| | 0 CPU interrupt is disabled. 1 CPU interrupt is enabled. |
| 0 MCGEN | Modulator and Carrier Generator Enable Setting MCGEN will initialize the carrier generator and modulator and will enable all clocks. When enabled, the carrier generator and modulator will function continuously. When MCGEN is cleared, the current modulator cycle will be allowed to expire before all carrier and modulator clocks are disabled to save power and the modulator output is forced low. NOTE: To prevent spurious operation, the user should initialize all data and control registers before enabling the system. 0 Modulator and carrier generator disabled 1 Modulator and carrier generator enabled |

40.6.7 CMT Modulator Data Register Mark High (CMT_CMD1)

The contents of this register are transferred to the modulator down counter upon the completion of a modulation period.

Address: 4006_2000h base + 6h offset = 4006_2006h

| | | | | | | | | |
|-------|----------|----|----|----|----|----|----|----|
| Bit | 7 | 6 | 5 | 4 | 3 | 2 | 1 | 0 |
| Read | MB[15:8] | | | | | | | |
| Write | | | | | | | | |
| Reset | x* | x* | x* | x* | x* | x* | x* | x* |

* Notes:

- x = Undefined at reset.

CMT_CMD1 field descriptions

| Field | Description |
|----------|---|
| MB[15:8] | MB[15:8] Controls the upper mark periods of the modulator for all modes. |

40.6.8 CMT Modulator Data Register Mark Low (CMT_CMD2)

The contents of this register are transferred to the modulator down counter upon the completion of a modulation period.

Address: 4006_2000h base + 7h offset = 4006_2007h

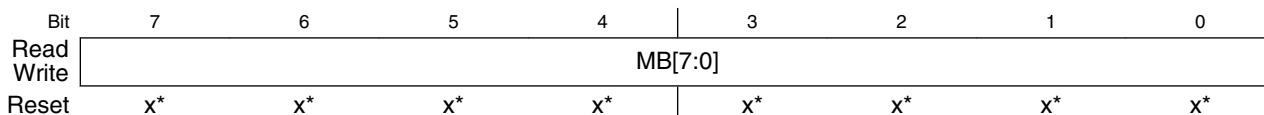

- * Notes:
- x = Undefined at reset.

CMT_CMD2 field descriptions

| Field | Description |
|---------|--|
| MB[7:0] | MB[7:0] Controls the lower mark periods of the modulator for all modes. |

40.6.9 CMT Modulator Data Register Space High (CMT_CMD3)

The contents of this register are transferred to the space period register upon the completion of a modulation period.

Address: 4006_2000h base + 8h offset = 4006_2008h

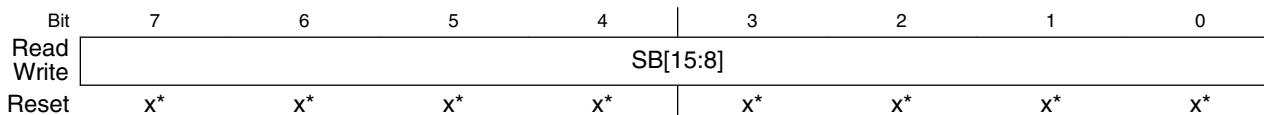

- * Notes:
- x = Undefined at reset.

CMT_CMD3 field descriptions

| Field | Description |
|----------|--|
| SB[15:8] | SB[15:8] Controls the upper space periods of the modulator for all modes. |

40.6.10 CMT Modulator Data Register Space Low (CMT_CMD4)

The contents of this register are transferred to the space period register upon the completion of a modulation period.

Address: 4006_2000h base + 9h offset = 4006_2009h

| | | | | | | | | |
|-------|---------|----|----|----|----|----|----|----|
| Bit | 7 | 6 | 5 | 4 | 3 | 2 | 1 | 0 |
| Read | SB[7:0] | | | | | | | |
| Write | SB[7:0] | | | | | | | |
| Reset | x* | x* | x* | x* | x* | x* | x* | x* |

* Notes:

- x = Undefined at reset.

CMT_CMD4 field descriptions

| Field | Description |
|---------|---|
| SB[7:0] | SB[7:0] Controls the lower space periods of the modulator for all modes. |

40.6.11 CMT Primary Prescaler Register (CMT_PPS)

This register is used to set the Primary Prescaler Divider field (PPSDIV).

Address: 4006_2000h base + Ah offset = 4006_200Ah

| | | | | | | | | |
|-------|---|---|---|---|--------|---|---|---|
| Bit | 7 | 6 | 5 | 4 | 3 | 2 | 1 | 0 |
| Read | 0 | | | | PPSDIV | | | |
| Write | 0 | | | | PPSDIV | | | |
| Reset | 0 | 0 | 0 | 0 | 0 | 0 | 0 | 0 |

CMT_PPS field descriptions

| Field | Description |
|-----------------|--|
| 7–4 Reserved | This field is reserved. This read-only field is reserved and always has the value 0. |
| PPSDIV | Primary Prescaler Divider Divides the CMT clock to generate the Intermediate Frequency clock enable to the secondary prescaler. 0000 Bus clock ÷ 1 0001 Bus clock ÷ 2 0010 Bus clock ÷ 3 |

Table continues on the next page...

CMT_PPS field descriptions (continued)

| Field | Description |
|-------|----------------|
| 0011 | Bus clock ÷ 4 |
| 0100 | Bus clock ÷ 5 |
| 0101 | Bus clock ÷ 6 |
| 0110 | Bus clock ÷ 7 |
| 0111 | Bus clock ÷ 8 |
| 1000 | Bus clock ÷ 9 |
| 1001 | Bus clock ÷ 10 |
| 1010 | Bus clock ÷ 11 |
| 1011 | Bus clock ÷ 12 |
| 1100 | Bus clock ÷ 13 |
| 1101 | Bus clock ÷ 14 |
| 1110 | Bus clock ÷ 15 |
| 1111 | Bus clock ÷ 16 |

40.6.12 CMT Direct Memory Access Register (CMT_DMA)

This register is used to enable/disable direct memory access (DMA).

Address: 4006_2000h base + Bh offset = 4006_200Bh

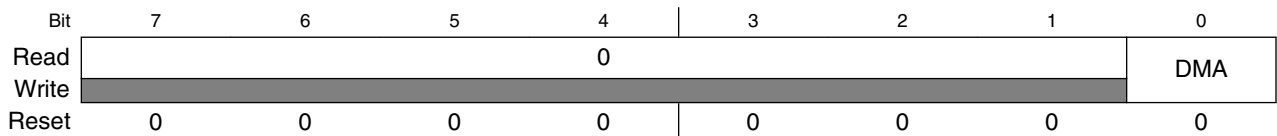

CMT_DMA field descriptions

| Field | Description |
|-----------------|--|
| 7-1 Reserved | This field is reserved. This read-only field is reserved and always has the value 0. |
| 0 DMA | DMA Enable Enables the DMA protocol. 0 DMA transfer request and done are disabled. 1 DMA transfer request and done are enabled. |

40.7 Functional description

The CMT module primarily consists of clock divider, carrier generator, and modulator.

40.7.1 Clock divider

The CMT was originally designed to be based on an 8 MHz bus clock that could be divided by 1, 2, 4, or 8 according to the specification. To be compatible with higher bus frequency, the primary prescaler (PPS) was developed to receive a higher frequency and generate a clock enable signal called intermediate frequency (IF). This IF must be approximately equal to 8 MHz and will work as a clock enable to the secondary prescaler. The following figure shows the clock divider block diagram.

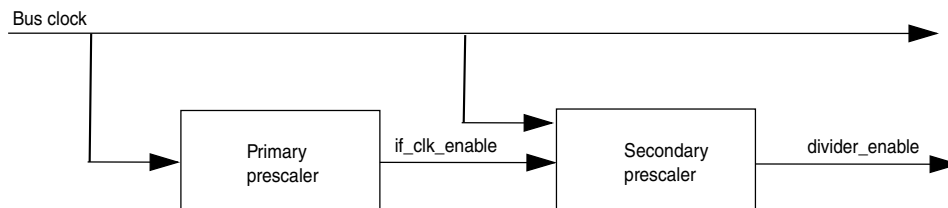

Figure 40-2. Clock divider block diagram

For compatibility with previous versions of CMT, when bus clock = 8 MHz, the PPS must be configured to zero. The PPS counter is selected according to the bus clock to generate an intermediate frequency approximately equal to 8 MHz.

40.7.2 Carrier generator

The carrier generator resolution is 125 ns when operating with an 8 MHz intermediate frequency signal and the secondary prescaler is set to divide by 1, or, when $MSC[CMTDIV] = 00$. The carrier generator can generate signals with periods between 250 ns (4 MHz) and 127.5 μ s (7.84 kHz) in steps of 125 ns. The following table shows the relationship between the clock divide bits and the carrier generator resolution, minimum carrier generator period, and minimum modulator period.

Table 40-5. Clock divider

| Bus clock (MHz) | MSC[CMTDIV] | Carrier generator resolution (μ s) | Min. carrier generator period (μ s) | Min. modulator period (μ s) |
|-----------------|-------------|---|--|----------------------------------|
| 8 | 00 | 0.125 | 0.25 | 1.0 |
| 8 | 01 | 0.25 | 0.5 | 2.0 |
| 8 | 10 | 0.5 | 1.0 | 4.0 |
| 8 | 11 | 1.0 | 2.0 | 8.0 |

The possible duty cycle options depend upon the number of counts required to complete the carrier period. For example, 1.6 MHz signal has a period of 625 ns and will therefore require 5 x 125 ns counts to generate. These counts may be split between high and low times, so the duty cycles available will be:

- 20% with one high and four low times
- 40% with two high and three low times
- 60% with three high and two low times, and
- 80% with four high and one low time

For low-frequency signals with large periods, high-resolution duty cycles as a percentage of the total period, are possible.

The carrier signal is generated by counting a register-selected number of input clocks (125 ns for an 8 MHz bus) for both the carrier high time and the carrier low time. The period is determined by the total number of clocks counted. The duty cycle is determined by the ratio of high-time clocks to total clocks counted. The high and low time values are user-programmable and are held in two registers.

An alternate set of high/low count values is held in another set of registers to allow the generation of dual-frequency FSK protocols without CPU intervention.

Note

Only nonzero data values are allowed. The carrier generator will not work if any of the count values are equal to zero.

MSC[MCGEN] must be set and MSC[BASE] must be cleared to enable carrier generator clocks. When MSC[BASE] is set, the carrier output to the modulator is held high continuously. The following figure represents the block diagram of the clock generator.

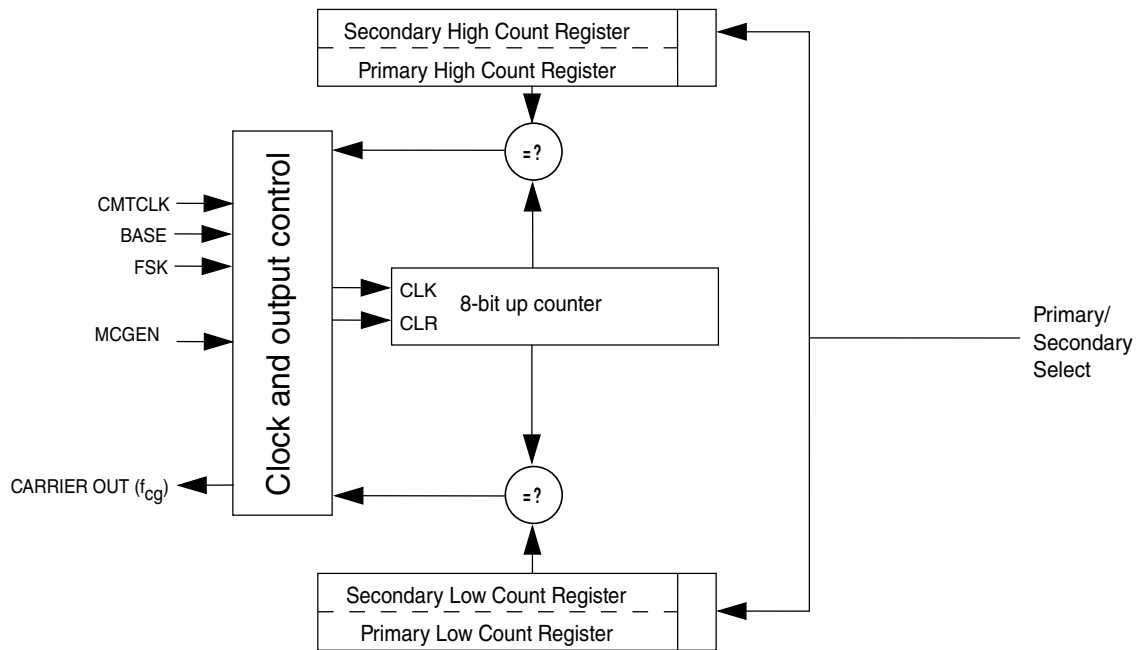

Figure 40-3. Carrier generator block diagram

The high/low time counter is an 8-bit up counter. After each increment, the contents of the counter are compared with the appropriate high or low count value register. When the compare value is reached, the counter is reset to a value of 0x01, and the compare is redirected to the other count value register.

Assuming that the high time count compare register is currently active, a valid compare will cause the carrier output to be driven low. The counter will continue to increment starting at the reset value of 0x01. When the value stored in the selected low count value register is reached, the counter will again be reset and the carrier output will be driven high.

The cycle repeats, automatically generating a periodic signal which is directed to the modulator. The lower frequency with maximum period, f_{\max} , and highest frequency with minimum period, f_{\min} , which can be generated, are defined as:

$$f_{\max} = f_{\text{CMTCLK}} \div (2 * 1) \text{ Hz}$$

$$f_{\min} = f_{\text{CMTCLK}} \div (2 * (2^8 - 1)) \text{ Hz}$$

In the general case, the carrier generator output frequency is:

$$f_{\text{cg}} = f_{\text{CMTCLK}} \div (\text{High count} + \text{Low count}) \text{ Hz}$$

Where: $0 < \text{High count} < 256$ and

$$0 < \text{Low count} < 256$$

Functional description

The duty cycle of the carrier signal is controlled by varying the ratio of high time to low + high time. As the input clock period is fixed, the duty cycle resolution will be proportional to the number of counts required to generate the desired carrier period.

$$\text{DutyCycle} = \frac{\text{Highcount}}{\text{Highcount} + \text{Lowcount}}$$

40.7.3 Modulator

The modulator block controls the state of the infrared out signal (IRO). The modulator output is gated on to the IRO signal when the modulator/carrier generator is enabled. . When the modulator/carrier generator is disabled, the IRO signal is controlled by the state of the IRO latch. OC[CMTPOL] enables the IRO signal to be active-high or active-low.

The following table describes the functions of the modulators in different modes:

Table 40-6. Mode functions

| Mode | Function |
|----------|--|
| Time | The modulator can gate the carrier onto the modulator output. |
| Baseband | The modulator can control the logic level of the modulator output. |
| FSK | The modulator can count carrier periods and instruct the carrier generator to alternate between two carrier frequencies whenever a modulation period consisting of mark and space counts, expires. |

The modulator provides a simple method to control protocol timing. The modulator has a minimum resolution of 1.0 μ s with an 8 MHz. It can count bus clocks to provide real-time control, or carrier clocks for self-clocked protocols.

The modulator includes a 17-bit down counter with underflow detection. The counter is loaded from the 16-bit modulation mark period buffer registers, CMD1 and CMD2. The most significant bit is loaded with a logic 0 and serves as a sign bit.

| When | Then |
|------------------------------------|---|
| The counter holds a positive value | The modulator gate is open and the carrier signal is driven to the transmitter block. |
| The counter underflows | The modulator gate is closed and a 16-bit comparator is enabled which compares the logical complement of the value of the down counter with the contents of the modulation space period register which has been loaded from the registers, CMD3 and CMD4. |

When a match is obtained, the cycle repeats by opening the modulator gate, reloading the counter with the contents of CMD1 and CMD2, and reloading the modulation space period register with the contents of CMD3 and CMD4.

The modulation space period is activated when the carrier signal is low to prohibit cutting off the high pulse of a carrier signal. If the carrier signal is high, the modulator extends the mark period until the carrier signal becomes low. To deassert the space period and assert the mark period, the carrier signal must have gone low to ensure that a space period is not erroneously shortened.

If the contents of the modulation space period register are all zeroes, the match will be immediate and no space period will be generated, for instance, for FSK protocols that require successive bursts of different frequencies).

MSC[MCGEN] must be set to enable the modulator timer.

The following figure presents the block diagram of the modulator.

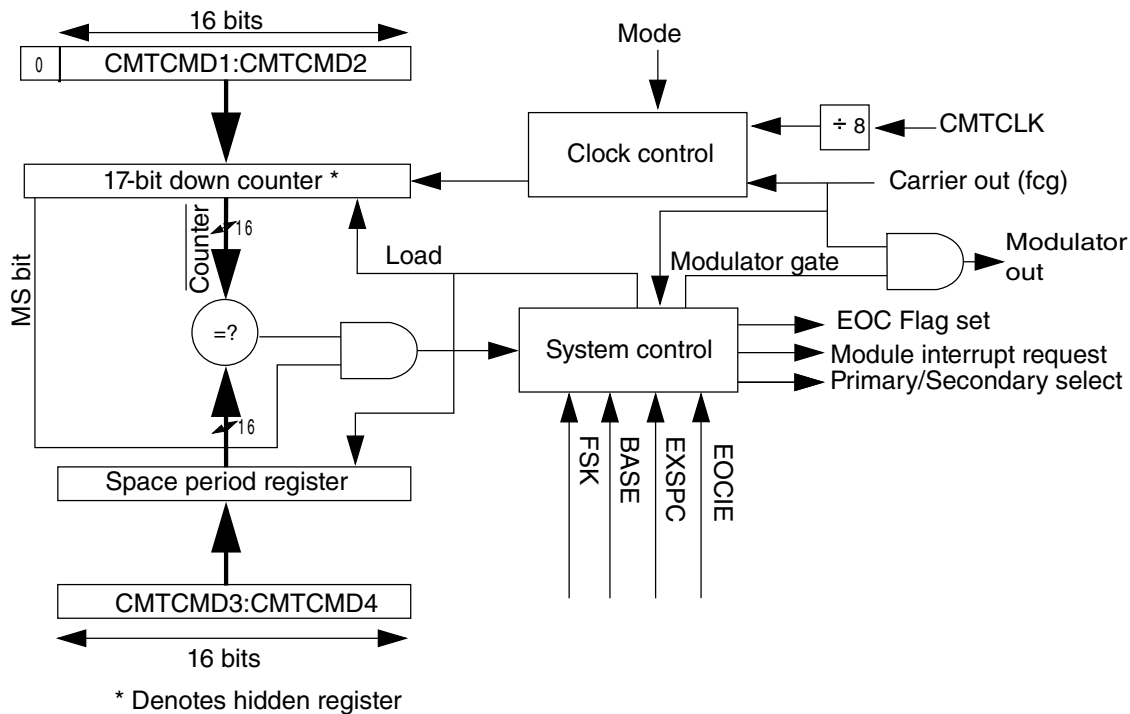

Figure 40-4. Modulator block diagram

40.7.3.1 Time mode

When the modulator operates in Time mode, or, when MSC[MCGEN] is set, and MSC[BASE] and MSC[FSK] are cleared:

Functional description

- The modulation mark period consists of an integer number of $(\text{CMTCLK} \div 8)$ clock periods.
- The modulation space period consists of 0 or an integer number of $(\text{CMTCLK} \div 8)$ clock periods.

With an 8 MHz IF and $\text{MSC}[\text{CMTDIV}] = 00$, the modulator resolution is 1 μs and has a maximum mark and space period of about 65.535 μs each. See [Figure 40-5](#) for an example of the Time and Baseband mode outputs.

The mark and space time equations for Time and Baseband mode are:

$$t_{\text{mark}} = (\text{CMD1}:\text{CMD2} + 1) \div (f_{\text{CMTCLK}} \div 8)$$

$$t_{\text{space}} = \text{CMD3}:\text{CMD4} \div (f_{\text{CMTCLK}} \div 8)$$

where $\text{CMD1}:\text{CMD2}$ and $\text{CMD3}:\text{CMD4}$ are the decimal values of the concatenated registers.

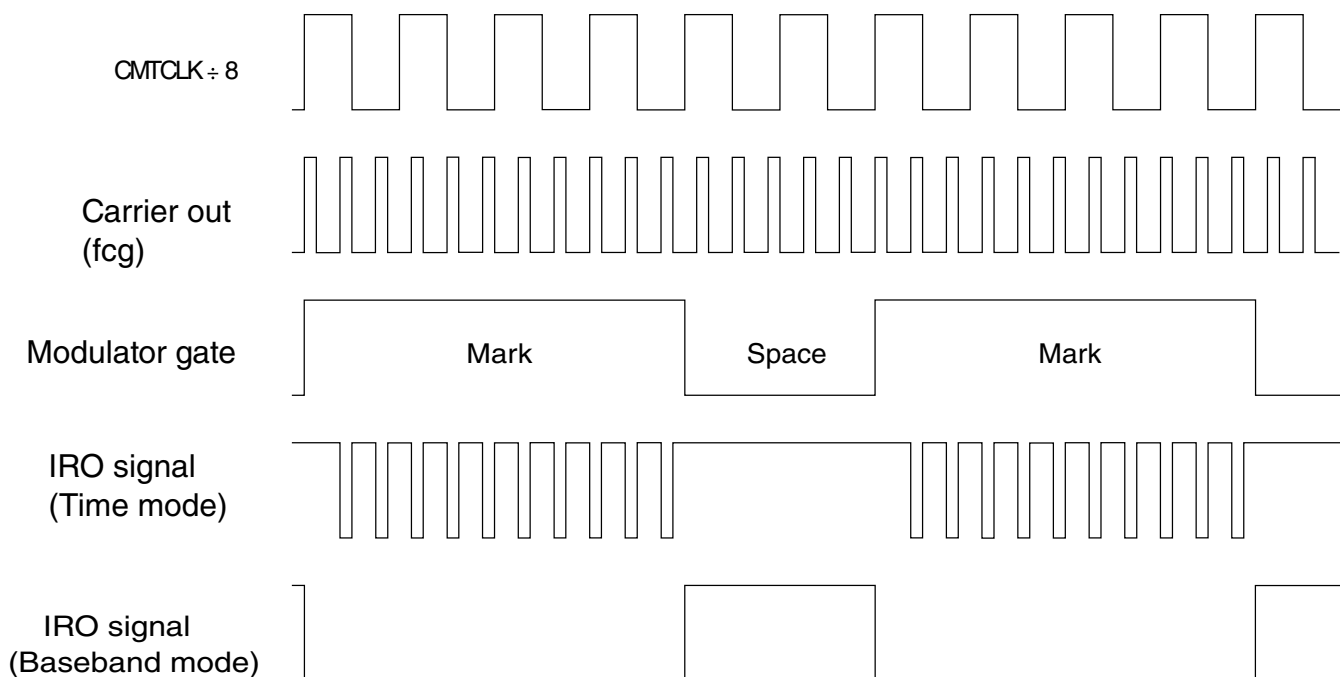

Figure 40-5. Example: CMT output in Time and Baseband modes with $\text{OC}[\text{CMTPOL}] = 0$

40.7.3.2 Baseband mode

Baseband mode, that is, when $\text{MSC}[\text{MCGEN}]$ and $\text{MSC}[\text{BASE}]$ are set, is a derivative of Time mode, where the mark and space period is based on $(\text{CMTCLK} \div 8)$ counts. The mark and space calculations are the same as in Time mode.

In this mode, the modulator output will be at a logic 1 for the duration of the mark period and at a logic 0 for the duration of a space period. See [Figure 40-5](#) for an example of the output for both Baseband and Time modes. In the example, the carrier out frequency (f_{cg}) is generated with a high count of 0x01 and a low count of 0x02 that results in a divide of 3 of CMTCLK with a 33% duty cycle. The modulator down counter was loaded with the value 0x0003 and the space period register with 0x0002.

Note

The waveforms in [Figure 40-5](#) and [Figure 40-6](#) are for the purpose of conceptual illustration and are not meant to represent precise timing relationships between the signals shown.

40.7.3.3 FSK mode

When the modulator operates in FSK mode, that is, when MSC[MCGEN] and MSC[FSK] are set, and MSC[BASE] is cleared:

- The modulation mark and space periods consist of an integer number of carrier clocks (space period can be zero).
- When the mark period expires, the space period is transparently started as in Time mode.
- The carrier generator toggles between primary and secondary data register values whenever the modulator space period expires.

The space period provides an interpulse gap (no carrier). If CMD3:CMD4 = 0x0000, then the modulator and carrier generator will switch between carrier frequencies without a gap or any carrier glitches (zero space).

Using timing data for carrier burst and interpulse gap length calculated by the CPU, FSK mode can automatically generate a phase-coherent, dual-frequency FSK signal with programmable burst and interburst gaps.

The mark and space time equations for FSK mode are:

$$t_{\text{mark}} = (\text{CMD1:CMD2} + 1) \div f_{cg}$$

$$t_{\text{space}} = (\text{CMD3:CMD4}) \div f_{cg}$$

Where f_{cg} is the frequency output from the carrier generator. The example in [Figure 40-6](#) shows what the IRO signal looks like in FSK mode with the following values:

- CMD1:CMD2 = 0x0003
- CMD3:CMD4 = 0x0002
- Primary carrier high count = 0x01
- Primary carrier low count = 0x02

Functional description

- Secondary carrier high count = 0x03
- Secondary carrier low count = 0x01

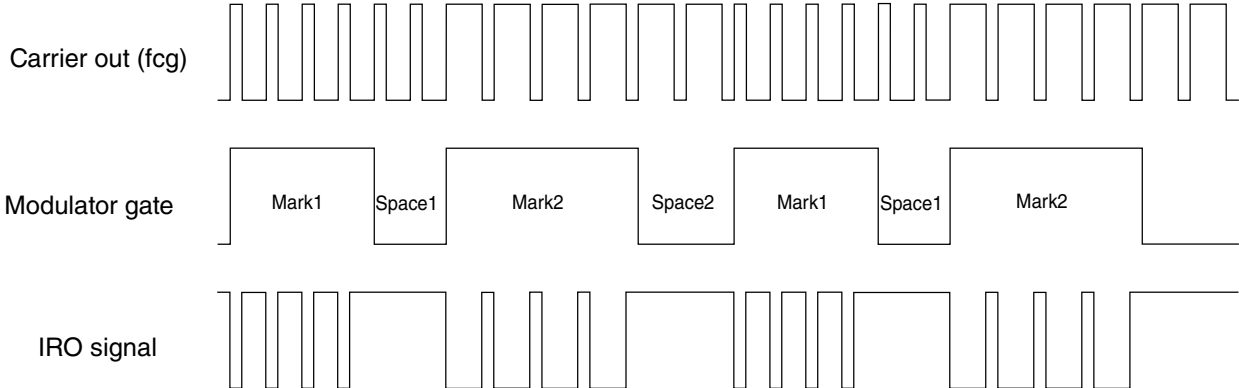

Figure 40-6. Example: CMT output in FSK mode

40.7.4 Extended space operation

In either Time, Baseband, or FSK mode, the space period can be made longer than the maximum possible value of the space period register. Setting MSC[EXSPC] will force the modulator to treat the next modulation period beginning with the next load of the counter and space period register, as a space period equal in length to the mark and space counts combined. Subsequent modulation periods will consist entirely of these extended space periods with no mark periods. Clearing MSC[EXSPC] will return the modulator to standard operation at the beginning of the next modulation period.

40.7.4.1 EXSPC operation in Time mode

To calculate the length of an extended space in Time or Baseband mode, add the mark and space times and multiply by the number of modulation periods when MSC[EXSPC] is set.

$$t_{\text{exspace}} = (t_{\text{mark}} + t_{\text{space}}) * (\text{number of modulation periods})$$

For an example of extended space operation, see [Figure 40-7](#).

Note

The extended space enable feature can be used to emulate a zero mark event.

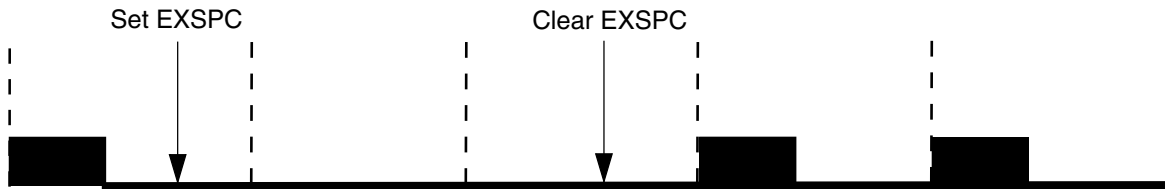

Figure 40-7. Extended space operation

40.7.4.2 EXSPC operation in FSK mode

In FSK mode, the modulator continues to count carrier out clocks, alternating between the primary and secondary registers at the end of each modulation period.

To calculate the length of an extended space in FSK mode, it is required to know whether MSC[EXSPC] was set on a primary or secondary modulation period, and the total number of both primary and secondary modulation periods completed while MSC[EXSPC] is high. A status bit for the current modulation is not accessible to the CPU. If necessary, software must maintain tracking of the current primary or secondary modulation cycle. The extended space period ends at the completion of the space period time of the modulation period during which MSC[EXSPC] is cleared.

The following table depicts the equations which can be used to calculate the extended space period depending on when MSC[EXSPC] is set.

| If | Then |
|--|--|
| MSC[EXSPC] was set during a primary modulation cycle | Use the equation: $t_{\text{exspace}} = (t_{\text{space}})_p + (t_{\text{mark}} + t_{\text{space}})_s + (t_{\text{mark}} + t_{\text{space}})_p + \dots$ |
| MSC[EXSPC] bit was set during a secondary modulation cycle | Use the equation: $t_{\text{exspace}} = (t_{\text{space}})_s + (t_{\text{mark}} + t_{\text{space}})_p + (t_{\text{mark}} + t_{\text{space}})_s + \dots$ |

Where the subscripts p and s refer to mark and space times for the primary and secondary modulation cycles.

40.8 CMT interrupts and DMA

The CMT generates an interrupt request or a DMA transfer request according to MSC[EOCIE], MSC[EOCF], DMA[DMA] bits.

Table 40-7. DMA transfer request x CMT interrupt request

| MSC[EOCF] | DMA[DMA] | MSC[EOCIE] | DMA transfer request | CMT interrupt request |
|-----------|----------|------------|----------------------|-----------------------|
| 0 | X | X | 0 | 0 |
| 1 | X | 0 | 0 | 0 |
| 1 | 0 | 1 | 0 | 1 |
| 1 | 1 | 1 | 1 | 0 |

MSC[EOCF] is set:

- When the modulator is not currently active and MSC[MCGEN] is set to begin the initial CMT transmission.
- At the end of each modulation cycle when the counter is reloaded from CMD1:CMD2, while MSC[MCGEN] is set.

When MSC[MCGEN] is cleared and then set before the end of the modulation cycle, MSC[EOCF] will not be set when MSC[MCGEN] is set, but will become set at the end of the current modulation cycle.

When MSC[MCGEN] becomes disabled, the CMT module does not set MSC[EOCF] at the end of the last modulation cycle.

If MSC[EOCIE] is high when MSC[EOCF] is set, the CMT module will generate an interrupt request or a DMA transfer request.

MSC[EOCF] must be cleared to prevent from being generated by another event like interrupt or DMA request, after exiting the service routine. See the following table.

Table 40-8. How to clear MSC[EOCF]

| DMA[DMA] | MSC[EOCIE] | Description |
|----------|------------|--|
| 0 | X | MSC[EOCF] is cleared by reading MSC followed by an access of CMD2 or CMD4. |
| 1 | X | MSC[EOCF] is cleared by the CMT DMA transfer done. |

The EOC interrupt is coincident with:

- Loading the down-counter with the contents of CMD1:CMD2
- Loading the space period register with the contents of CMD3:CMD4

The EOC interrupt provides a means for the user to reload new mark/space values into the modulator data registers. Modulator data register updates will take effect at the end of the current modulation cycle.

NOTE

The down-counter and space period register are updated at the end of every modulation cycle, irrespective of interrupt handling and the state of MSC[EOCF].

Chapter 41

General-purpose input/output (GPIO)

The general-purpose input and output (GPIO) module is accessible via the peripheral bus and also communicates to the processor core via a zero wait state interface (IOPORT) for maximum pin performance. The GPIO data direction and output data registers control the direction and output data of each pin when the pin is configured for the GPIO function.

41.1 Introduction

The general-purpose input and output (GPIO) module is accessible via the peripheral bus and also communicates to the processor core via a zero wait state interface (IOPORT) for maximum pin performance. The GPIO registers support 8-bit, 16-bit or 32-bit accesses.

The GPIO data direction and output data registers control the direction and output data of each pin when the pin is configured for the GPIO function. The GPIO input data register displays the logic value on each pin when the pin is configured for any digital function, provided the corresponding Port Control and Interrupt module for that pin is enabled.

Efficient bit manipulation of the general-purpose outputs is supported through the addition of set, clear, and toggle write-only registers for each port output data register.

41.1.1 Features

Features of the GPIO module include:

- Port Data Input register visible in all digital pin-multiplexing modes
- Port Data Output register with corresponding set/clear/toggle registers
- Port Data Direction register
- Zero wait state access to GPIO registers through IOPORT

NOTE

The GPIO module is clocked by system clock.

41.1.2 Modes of operation

The following table depicts different modes of operation and the behavior of the GPIO module in these modes.

Table 41-1. Modes of operation

| Modes of operation | Description |
|--------------------|------------------------------------|
| Run | The GPIO module operates normally. |
| Wait | The GPIO module operates normally. |
| Stop | The GPIO module is disabled. |
| Debug | The GPIO module operates normally. |

41.1.3 GPIO signal descriptions

Table 41-2. GPIO signal descriptions

| GPIO signal descriptions | Description | I/O |
|--------------------------|------------------------------|-----|
| PORTA31–PORTA0 | General-purpose input/output | I/O |
| PORTB31–PORTB0 | General-purpose input/output | I/O |
| PORTC31–PORTC0 | General-purpose input/output | I/O |

NOTE

Not all pins within each port are implemented on each device. See the chapter on signal multiplexing for the number of GPIO ports available in the device.

41.1.3.1 Detailed signal description

Table 41-3. GPIO interface-detailed signal descriptions

| Signal | I/O | Description | |
|--|-----|------------------------------|--|
| PORTA31–PORTA0 PORTB31–PORTB0 PORTC31–PORTC0 | I/O | General-purpose input/output | |
| | | State meaning | Asserted: The pin is logic 1. Deasserted: The pin is logic 0. |
| | | Timing | Assertion: When output, this signal occurs on the rising-edge of the system clock. For input, it may occur at any time and input may be asserted asynchronously to the system clock. |

Table 41-3. GPIO interface-detailed signal descriptions

| Signal | I/O | Description |
|--------|-----|--|
| | | Deassertion: When output, this signal occurs on the rising-edge of the system clock. For input, it may occur at any time and input may be asserted asynchronously to the system clock. |

NOTE

Not all pins within each port are implemented on each device. See the chapter on signal multiplexing for the number of GPIO ports available in the device.

41.2 Memory map and register definition

Any read or write access to the GPIO memory space that is outside the valid memory map results in a bus error.

NOTE

For simplicity, each GPIO port's registers appear with the same width of 32 bits, corresponding to 32 pins. The actual number of pins per port (and therefore the number of usable control bits per port register) is chip-specific. Refer to the to see the exact control bits for the non-identical port instance.

GPIO memory map

| Absolute address (hex) | Register name | Width (in bits) | Access | Reset value | Section/page |
|------------------------|---|-----------------|-----------------------|-------------|----------------------------|
| 400F_F000 | Port Data Output Register (GPIOA_PDOR) | 32 | R/W | 0000_0000h | 41.2.1/952 |
| 400F_F004 | Port Set Output Register (GPIOA_PSOR) | 32 | W (always reads 0) | 0000_0000h | 41.2.2/953 |
| 400F_F008 | Port Clear Output Register (GPIOA_PCOR) | 32 | W (always reads 0) | 0000_0000h | 41.2.3/953 |
| 400F_F00C | Port Toggle Output Register (GPIOA_PTOR) | 32 | W (always reads 0) | 0000_0000h | 41.2.4/954 |
| 400F_F010 | Port Data Input Register (GPIOA_PDIR) | 32 | R | 0000_0000h | 41.2.5/954 |
| 400F_F014 | Port Data Direction Register (GPIOA_PDDR) | 32 | R/W | 0000_0000h | 41.2.6/955 |

GPIO memory map (continued)

| Absolute address (hex) | Register name | Width (in bits) | Access | Reset value | Section/ page |
|------------------------|---|-----------------|-----------------------|-------------|----------------------------|
| 400F_F040 | Port Data Output Register (GPIOB_PDOR) | 32 | R/W | 0000_0000h | 41.2.1/952 |
| 400F_F044 | Port Set Output Register (GPIOB_PSOR) | 32 | W (always reads 0) | 0000_0000h | 41.2.2/953 |
| 400F_F048 | Port Clear Output Register (GPIOB_PCOR) | 32 | W (always reads 0) | 0000_0000h | 41.2.3/953 |
| 400F_F04C | Port Toggle Output Register (GPIOB_PTOR) | 32 | W (always reads 0) | 0000_0000h | 41.2.4/954 |
| 400F_F050 | Port Data Input Register (GPIOB_PDIR) | 32 | R | 0000_0000h | 41.2.5/954 |
| 400F_F054 | Port Data Direction Register (GPIOB_PDDR) | 32 | R/W | 0000_0000h | 41.2.6/955 |
| 400F_F080 | Port Data Output Register (GPIOC_PDOR) | 32 | R/W | 0000_0000h | 41.2.1/952 |
| 400F_F084 | Port Set Output Register (GPIOC_PSOR) | 32 | W (always reads 0) | 0000_0000h | 41.2.2/953 |
| 400F_F088 | Port Clear Output Register (GPIOC_PCOR) | 32 | W (always reads 0) | 0000_0000h | 41.2.3/953 |
| 400F_F08C | Port Toggle Output Register (GPIOC_PTOR) | 32 | W (always reads 0) | 0000_0000h | 41.2.4/954 |
| 400F_F090 | Port Data Input Register (GPIOC_PDIR) | 32 | R | 0000_0000h | 41.2.5/954 |
| 400F_F094 | Port Data Direction Register (GPIOC_PDDR) | 32 | R/W | 0000_0000h | 41.2.6/955 |

41.2.1 Port Data Output Register (GPIOx_PDOR)

This register configures the logic levels that are driven on each general-purpose output pins.

NOTE

Do not modify pin configuration registers associated with pins not available in your selected package. All unbonded pins not available in your package will default to DISABLE state for lowest power consumption.

Address: Base address + 0h offset

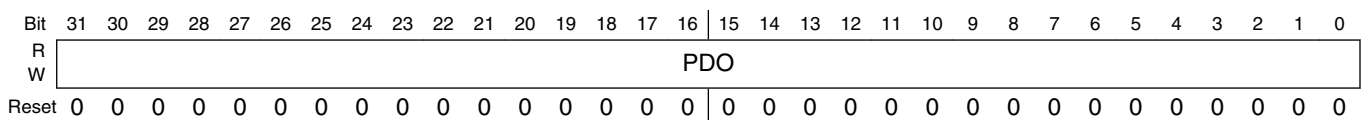

GPIOx_PDOR field descriptions

| Field | Description |
|-------|--|
| PDO | <p>Port Data Output</p> <p>Register bits for unbonded pins return a undefined value when read.</p> <p>0 Logic level 0 is driven on pin, provided pin is configured for general-purpose output.</p> <p>1 Logic level 1 is driven on pin, provided pin is configured for general-purpose output.</p> |

41.2.2 Port Set Output Register (GPIOx_PSOR)

This register configures whether to set the fields of the PDOR.

Address: Base address + 4h offset

| Bit | 31 | 30 | 29 | 28 | 27 | 26 | 25 | 24 | 23 | 22 | 21 | 20 | 19 | 18 | 17 | 16 | 15 | 14 | 13 | 12 | 11 | 10 | 9 | 8 | 7 | 6 | 5 | 4 | 3 | 2 | 1 | 0 |
|-------|------|----|----|----|----|----|----|----|----|----|----|----|----|----|----|----|----|----|----|----|----|----|---|---|---|---|---|---|---|---|---|---|
| R | 0 | | | | | | | | | | | | | | | | | | | | | | | | | | | | | | | |
| W | PTSO | | | | | | | | | | | | | | | | | | | | | | | | | | | | | | | |
| Reset | 0 | 0 | 0 | 0 | 0 | 0 | 0 | 0 | 0 | 0 | 0 | 0 | 0 | 0 | 0 | 0 | 0 | 0 | 0 | 0 | 0 | 0 | 0 | 0 | 0 | 0 | 0 | 0 | 0 | 0 | 0 | 0 |

GPIOx_PSOR field descriptions

| Field | Description |
|-------|--|
| PTSO | <p>Port Set Output</p> <p>Writing to this register will update the contents of the corresponding bit in the PDOR as follows:</p> <p>0 Corresponding bit in PDORn does not change.</p> <p>1 Corresponding bit in PDORn is set to logic 1.</p> |

41.2.3 Port Clear Output Register (GPIOx_PCOR)

This register configures whether to clear the fields of PDOR.

Address: Base address + 8h offset

| Bit | 31 | 30 | 29 | 28 | 27 | 26 | 25 | 24 | 23 | 22 | 21 | 20 | 19 | 18 | 17 | 16 | 15 | 14 | 13 | 12 | 11 | 10 | 9 | 8 | 7 | 6 | 5 | 4 | 3 | 2 | 1 | 0 |
|-------|------|----|----|----|----|----|----|----|----|----|----|----|----|----|----|----|----|----|----|----|----|----|---|---|---|---|---|---|---|---|---|---|
| R | 0 | | | | | | | | | | | | | | | | | | | | | | | | | | | | | | | |
| W | PTCO | | | | | | | | | | | | | | | | | | | | | | | | | | | | | | | |
| Reset | 0 | 0 | 0 | 0 | 0 | 0 | 0 | 0 | 0 | 0 | 0 | 0 | 0 | 0 | 0 | 0 | 0 | 0 | 0 | 0 | 0 | 0 | 0 | 0 | 0 | 0 | 0 | 0 | 0 | 0 | 0 | 0 |

GPIOx_PCOR field descriptions

| Field | Description |
|-------|-------------------|
| PTCO | Port Clear Output |

GPIOx_PCOR field descriptions (continued)

| Field | Description |
|-------|--|
| | Writing to this register will update the contents of the corresponding bit in the Port Data Output Register (PDOR) as follows: 0 Corresponding bit in PDORn does not change. 1 Corresponding bit in PDORn is cleared to logic 0. |

41.2.4 Port Toggle Output Register (GPIOx_PTOR)

Address: Base address + Ch offset

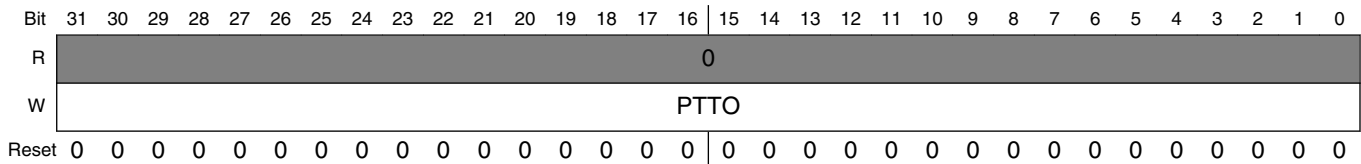

GPIOx_PTOR field descriptions

| Field | Description |
|-------|--|
| PTTO | Port Toggle Output Writing to this register will update the contents of the corresponding bit in the PDOR as follows: 0 Corresponding bit in PDORn does not change. 1 Corresponding bit in PDORn is set to the inverse of its existing logic state. |

41.2.5 Port Data Input Register (GPIOx_PDIR)

NOTE

Do not modify pin configuration registers associated with pins not available in your selected package. All unbonded pins not available in your package will default to DISABLE state for lowest power consumption.

Address: Base address + 10h offset

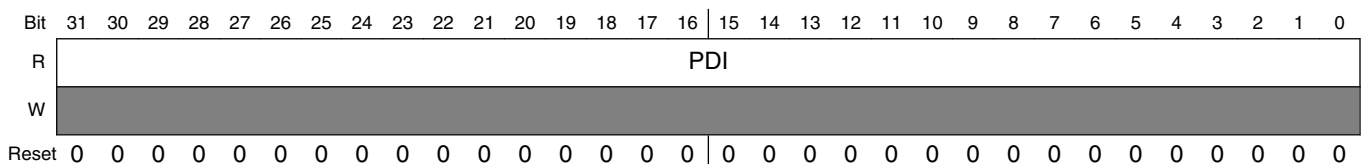

GPIOx_PDIR field descriptions

| Field | Description |
|-------|---|
| PDI | <p>Port Data Input</p> <p>Reads 0 at the unimplemented pins for a particular device. Pins that are not configured for a digital function read 0. If the Port Control and Interrupt module is disabled, then the corresponding bit in PDIR does not update.</p> <p>0 Pin logic level is logic 0, or is not configured for use by digital function. 1 Pin logic level is logic 1.</p> |

41.2.6 Port Data Direction Register (GPIOx_PDDR)

The PDDR configures the individual port pins for input or output.

Address: Base address + 14h offset

| Bit | 31 | 30 | 29 | 28 | 27 | 26 | 25 | 24 | 23 | 22 | 21 | 20 | 19 | 18 | 17 | 16 | 15 | 14 | 13 | 12 | 11 | 10 | 9 | 8 | 7 | 6 | 5 | 4 | 3 | 2 | 1 | 0 |
|-------|----|----|----|----|----|----|----|----|----|----|----|----|----|----|----|----|----|----|----|----|----|----|---|---|---|---|---|---|---|---|---|---|
| R | | | | | | | | | | | | | | | | | | | | | | | | | | | | | | | | |
| W | | | | | | | | | | | | | | | | | | | | | | | | | | | | | | | | |
| Reset | 0 | 0 | 0 | 0 | 0 | 0 | 0 | 0 | 0 | 0 | 0 | 0 | 0 | 0 | 0 | 0 | 0 | 0 | 0 | 0 | 0 | 0 | 0 | 0 | 0 | 0 | 0 | 0 | 0 | 0 | 0 | 0 |

GPIOx_PDDR field descriptions

| Field | Description |
|-------|--|
| PDD | <p>Port Data Direction</p> <p>Configures individual port pins for input or output.</p> <p>0 Pin is configured as general-purpose input, for the GPIO function. 1 Pin is configured as general-purpose output, for the GPIO function.</p> |

41.3 FGPIO memory map and register definition

The GPIO registers are also aliased to the IOPORT interface on the Cortex-M0+ from address 0xF800_0000.

Accesses via the IOPORT interface occur in parallel with any instruction fetches and will therefore complete in a single cycle. This aliased Fast GPIO memory map is called FGPIO.

Any read or write access to the FGPIO memory space that is outside the valid memory map results in a bus error. All register accesses complete with zero wait states, except error accesses which complete with one wait state.

NOTE

For simplicity, each FGPIO port's registers appear with the same width of 32 bits, corresponding to 32 pins. The actual number of pins per port (and therefore the number of usable control bits per port register) is chip-specific. Refer to the Chip Configuration chapter to see the exact control bits for the non-identical port instance.

FGPIO memory map

| Absolute address (hex) | Register name | Width (in bits) | Access | Reset value | Section/page |
|------------------------|--|-----------------|-----------------------|-------------|----------------------------|
| F800_0000 | Port Data Output Register (FGPIOA_PDOR) | 32 | R/W | 0000_0000h | 41.3.1/957 |
| F800_0004 | Port Set Output Register (FGPIOA_PSOR) | 32 | W (always reads 0) | 0000_0000h | 41.3.2/957 |
| F800_0008 | Port Clear Output Register (FGPIOA_PCOR) | 32 | W (always reads 0) | 0000_0000h | 41.3.3/958 |
| F800_000C | Port Toggle Output Register (FGPIOA_PTOR) | 32 | W (always reads 0) | 0000_0000h | 41.3.4/958 |
| F800_0010 | Port Data Input Register (FGPIOA_PDIR) | 32 | R | 0000_0000h | 41.3.5/959 |
| F800_0014 | Port Data Direction Register (FGPIOA_PDDR) | 32 | R/W | 0000_0000h | 41.3.6/959 |
| F800_0040 | Port Data Output Register (FGPIOB_PDOR) | 32 | R/W | 0000_0000h | 41.3.1/957 |
| F800_0044 | Port Set Output Register (FGPIOB_PSOR) | 32 | W (always reads 0) | 0000_0000h | 41.3.2/957 |
| F800_0048 | Port Clear Output Register (FGPIOB_PCOR) | 32 | W (always reads 0) | 0000_0000h | 41.3.3/958 |
| F800_004C | Port Toggle Output Register (FGPIOB_PTOR) | 32 | W (always reads 0) | 0000_0000h | 41.3.4/958 |
| F800_0050 | Port Data Input Register (FGPIOB_PDIR) | 32 | R | 0000_0000h | 41.3.5/959 |
| F800_0054 | Port Data Direction Register (FGPIOB_PDDR) | 32 | R/W | 0000_0000h | 41.3.6/959 |
| F800_0080 | Port Data Output Register (FGPIOC_PDOR) | 32 | R/W | 0000_0000h | 41.3.1/957 |
| F800_0084 | Port Set Output Register (FGPIOC_PSOR) | 32 | W (always reads 0) | 0000_0000h | 41.3.2/957 |
| F800_0088 | Port Clear Output Register (FGPIOC_PCOR) | 32 | W (always reads 0) | 0000_0000h | 41.3.3/958 |
| F800_008C | Port Toggle Output Register (FGPIOC_PTOR) | 32 | W (always reads 0) | 0000_0000h | 41.3.4/958 |
| F800_0090 | Port Data Input Register (FGPIOC_PDIR) | 32 | R | 0000_0000h | 41.3.5/959 |
| F800_0094 | Port Data Direction Register (FGPIOC_PDDR) | 32 | R/W | 0000_0000h | 41.3.6/959 |

41.3.1 Port Data Output Register (FGPIOx_PDOR)

This register configures the logic levels that are driven on each general-purpose output pins.

Address: Base address + 0h offset

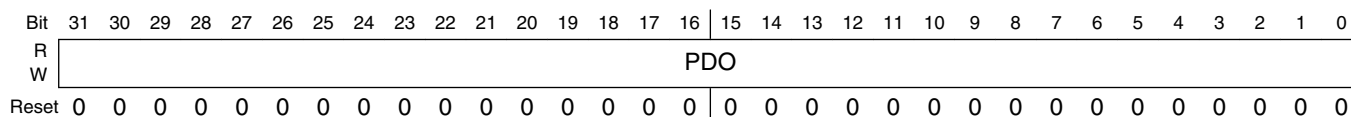

FGPIOx_PDOR field descriptions

| Field | Description |
|-------|--|
| PDO | Port Data Output Unimplemented pins for a particular device read as zero. 0 Logic level 0 is driven on pin, provided pin is configured for general-purpose output. 1 Logic level 1 is driven on pin, provided pin is configured for general-purpose output. |

41.3.2 Port Set Output Register (FGPIOx_PSOR)

This register configures whether to set the fields of the PDOR.

Address: Base address + 4h offset

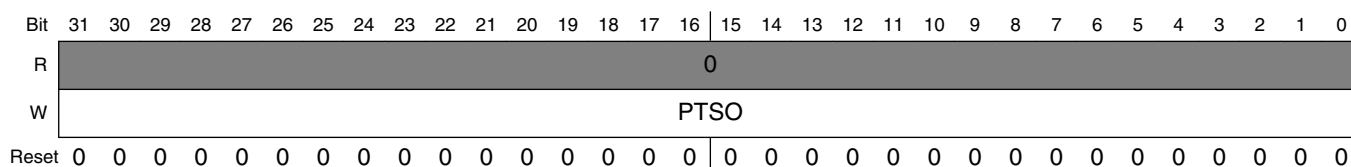

FGPIOx_PSOR field descriptions

| Field | Description |
|-------|---|
| PTSO | Port Set Output Writing to this register will update the contents of the corresponding bit in the PDOR as follows: 0 Corresponding bit in PDORn does not change. 1 Corresponding bit in PDORn is set to logic 1. |

41.3.3 Port Clear Output Register (FGPIOx_PCOR)

This register configures whether to clear the fields of PDOR.

Address: Base address + 8h offset

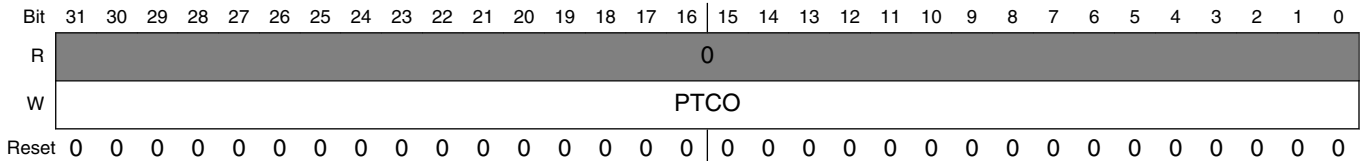

FGPIOx_PCOR field descriptions

| Field | Description |
|-------|--|
| PTCO | <p>Port Clear Output</p> <p>Writing to this register will update the contents of the corresponding bit in the Port Data Output Register (PDOR) as follows:</p> <p>0 Corresponding bit in PDORn does not change.</p> <p>1 Corresponding bit in PDORn is cleared to logic 0.</p> |

41.3.4 Port Toggle Output Register (FGPIOx_PTOR)

Address: Base address + Ch offset

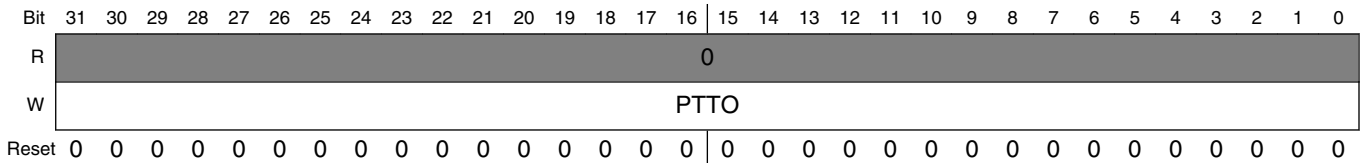

FGPIOx_PTOR field descriptions

| Field | Description |
|-------|---|
| PTTO | <p>Port Toggle Output</p> <p>Writing to this register will update the contents of the corresponding bit in the PDOR as follows:</p> <p>0 Corresponding bit in PDORn does not change.</p> <p>1 Corresponding bit in PDORn is set to the inverse of its existing logic state.</p> |

41.3.5 Port Data Input Register (FGPIOx_PDIR)

Address: Base address + 10h offset

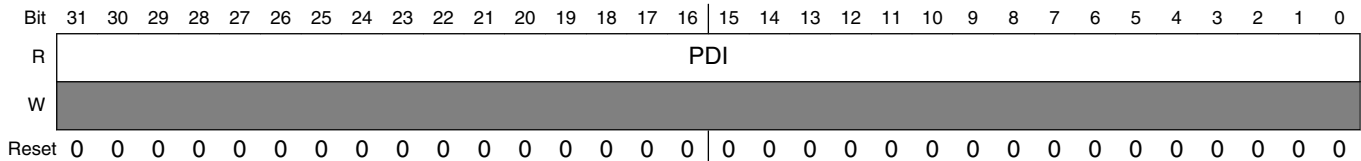

FGPIOx_PDIR field descriptions

| Field | Description |
|-------|--|
| PDI | <p>Port Data Input</p> <p>Reads 0 at the unimplemented pins for a particular device. Pins that are not configured for a digital function read 0. If the Port Control and Interrupt module is disabled, then the corresponding bit in PDIR does not update.</p> <p>0 Pin logic level is logic 0, or is not configured for use by digital function. 1 Pin logic level is logic 1.</p> |

41.3.6 Port Data Direction Register (FGPIOx_PDDR)

The PDDR configures the individual port pins for input or output.

Address: Base address + 14h offset

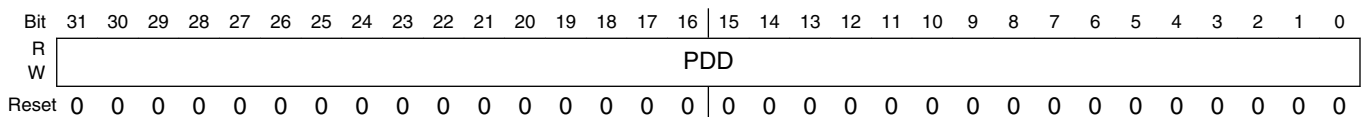

FGPIOx_PDDR field descriptions

| Field | Description |
|-------|---|
| PDD | <p>Port Data Direction</p> <p>Configures individual port pins for input or output.</p> <p>0 Pin is configured as general-purpose input, for the GPIO function. 1 Pin is configured as general-purpose output, for the GPIO function.</p> |

41.4 Functional description

41.4.1 General-purpose input

The logic state of each pin is available via the Port Data Input registers, provided the pin is configured for a digital function and the corresponding Port Control and Interrupt module is enabled.

41.4.2 General-purpose output

The logic state of each pin can be controlled via the port data output registers and port data direction registers, provided the pin is configured for the GPIO function. The following table depicts the conditions for a pin to be configured as input/output.

| If | Then |
|--|--|
| A pin is configured for the GPIO function and the corresponding port data direction register bit is clear. | The pin is configured as an input. |
| A pin is configured for the GPIO function and the corresponding port data direction register bit is set. | The pin is configured as an output and the logic state of the pin is equal to the corresponding port data output register. |

To facilitate efficient bit manipulation on the general-purpose outputs, pin data set, pin data clear, and pin data toggle registers exist to allow one or more outputs within one port to be set, cleared, or toggled from a single register write.

The corresponding Port Control and Interrupt module does not need to be enabled to update the state of the port data direction registers and port data output registers including the set/clear/toggle registers.

41.4.3 IOPORT

The GPIO registers are also aliased to the IOPORT interface on the Cortex-M0+ from address 0xF800_0000. Accesses via the IOPORT interface occur in parallel with any instruction fetches and will therefore complete in a single cycle. If the DMA attempts to access the GPIO registers on the same cycle as an IOPORT access, then the DMA access will stall until any IOPORT accesses have completed.

During Compute Operation, the GPIO registers remain accessible via the IOPORT interface only. Since the clocks to the Port Control and Interrupt modules are disabled during Compute Operation, the Pin Data Input Registers do not update with the current state of the pins.

Chapter 42

Touch Sensing Input (TSI)

The touch sensing input (TSI) module provides capacitive touch sensing detection with high sensitivity and enhanced robustness. Each TSI pin implements the capacitive measurement by a current source scan, charging and discharging the electrode, once or several times.

42.1 Introduction

The touch sensing input (TSI) module provides capacitive touch sensing detection with high sensitivity and enhanced robustness.

Each TSI pin implements the capacitive measurement by a current source scan, charging and discharging the electrode, once or several times. A reference oscillator ticks the scan time and stores the result in a 16-bit register when the scan completes. Meanwhile, an interrupt request is submitted to CPU for post-processing if TSI interrupt is enabled and DMA function is not selected. The TSI module can be periodically triggered to work in low power mode with ultra-low current adder and wake CPU at the end of scan or the conversion result is out of the range specified by TSI threshold. It provides a solid capacitive measurement module to the implementation of touch keyboard, rotaries and sliders.

42.1.1 Features

TSI features includes:

- Support up to 16 external electrodes
- Automatic detection of electrode capacitance across all operational power modes
- Internal reference oscillator for high-accuracy measurement
- Configurable software or hardware scan trigger
- Fully support NXP touch sensing software (TSS) library, see www.nxp.com/touchsensing.
- Capability to wake MCU from low power modes

Introduction

- Compensate for temperature and supply voltage variations
- High sensitivity change with 16-bit resolution register
- Configurable up to 4096 scan times.
- Support DMA data transfer
- The auxiliary noise detection mode supplies improved EMC immunity.

For electrode design recommendations, refer to [AN3863: Designing Touch Sensing Electrodes](#)

42.1.2 Modes of operation

This module supports the following operation modes.

Table 42-1. Operating modes

| Mode | Description |
|-------------------------|--|
| Stop and low power stop | TSI module is fully functional in all of the stop modes as long as TSI_GENCS[STPE] is set. The channel specified by TSI_DATA[TSICH] will be scanned upon the trigger. After scan finishes, either end-of-scan or out-of-range interrupt can be selected to bring MCU out of low power modes. |
| Wait | TSI module is fully functional in this mode. When a scan completes, TSI submits an interrupt request to CPU if the interrupt is enabled. |
| Run | TSI module is fully functional in this mode. When a scan completes, TSI submits an interrupt request to CPU if the interrupt is enabled. |

42.1.3 Block diagram

The following figure is a block diagram of the TSI module.

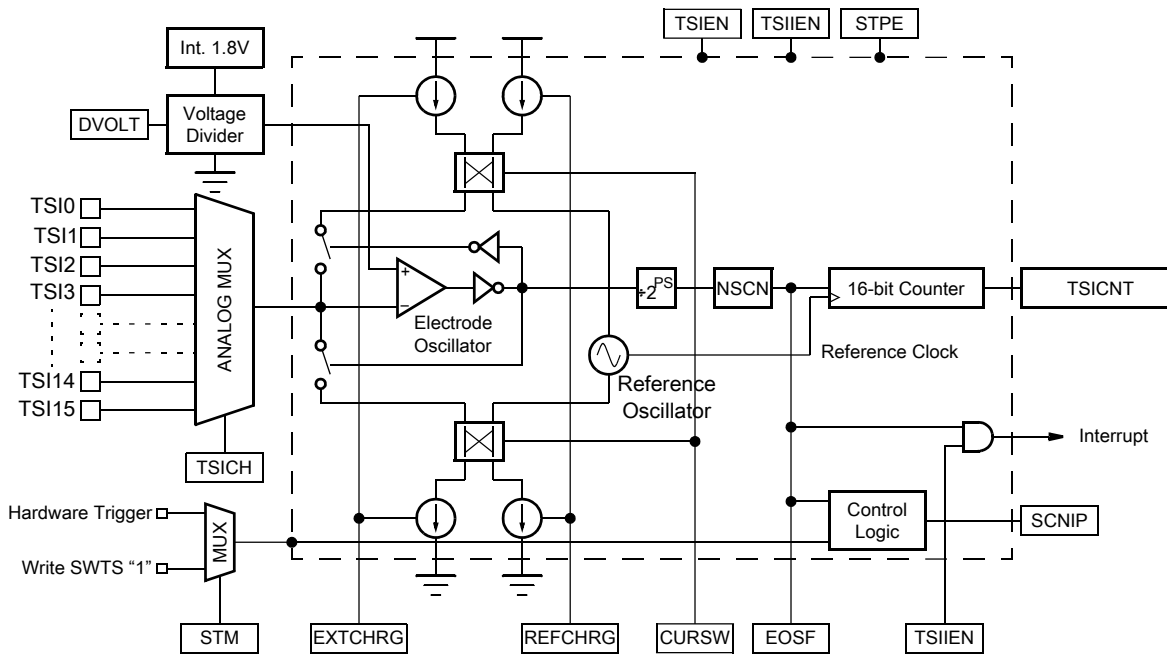

Figure 42-1. TSI module block diagram

42.2 External signal description

The TSI module contains up to 16 external pins for touch sensing. The table found here describes each of the TSI external pins.

Table 42-2. TSI signal description

| Name | Port | Direction | Function | Reset state |
|-----------|------|-----------|---|-------------|
| TSI[15:0] | TSI | I/O | TSI capacitive pins. Switches driver that connects directly to the electrode pins TSI[15:0] can operate as GPIO pins. | I/O |

42.2.1 TSI[15:0]

When TSI functionality is enabled, the TSI analog portion uses the corresponding channel to connect external on-board touch capacitors. The PCB connection between the pin and the touch pad must be kept as short as possible to reduce distribution capacity on board.

42.3 Register definition

This section describes the memory map and control/status registers for the TSI module.

TSI memory map

| Absolute address (hex) | Register name | Width (in bits) | Access | Reset value | Section/page |
|------------------------|--|-----------------|--------|-------------|----------------------------|
| 4004_5000 | TSI General Control and Status Register (TSI0_GENCS) | 32 | R/W | 0000_0000h | 42.3.1/964 |
| 4004_5004 | TSI DATA Register (TSI0_DATA) | 32 | R/W | 0000_0000h | 42.3.2/969 |
| 4004_5008 | TSI Threshold Register (TSI0_TSHD) | 32 | R/W | 0000_0000h | 42.3.3/970 |

42.3.1 TSI General Control and Status Register (TSIx_GENCS)

This control register provides various control and configuration information for the TSI module.

NOTE

When TSI is working, the configuration bits (GENCS[TSIEN], GENCS[TSIIEN], and GENCS[STM]) must not be changed. The EOSF flag is kept until the software acknowledge it.

Address: 4004_5000h base + 0h offset = 4004_5000h

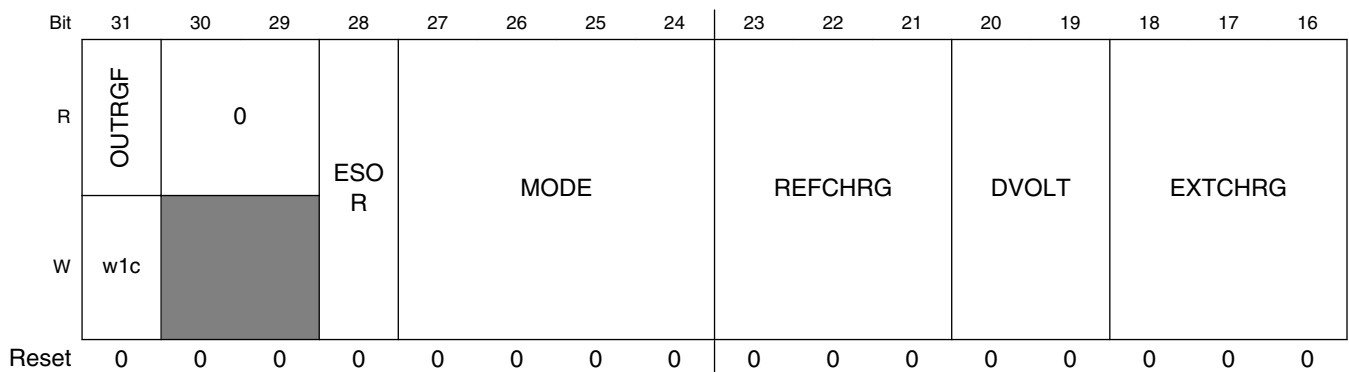

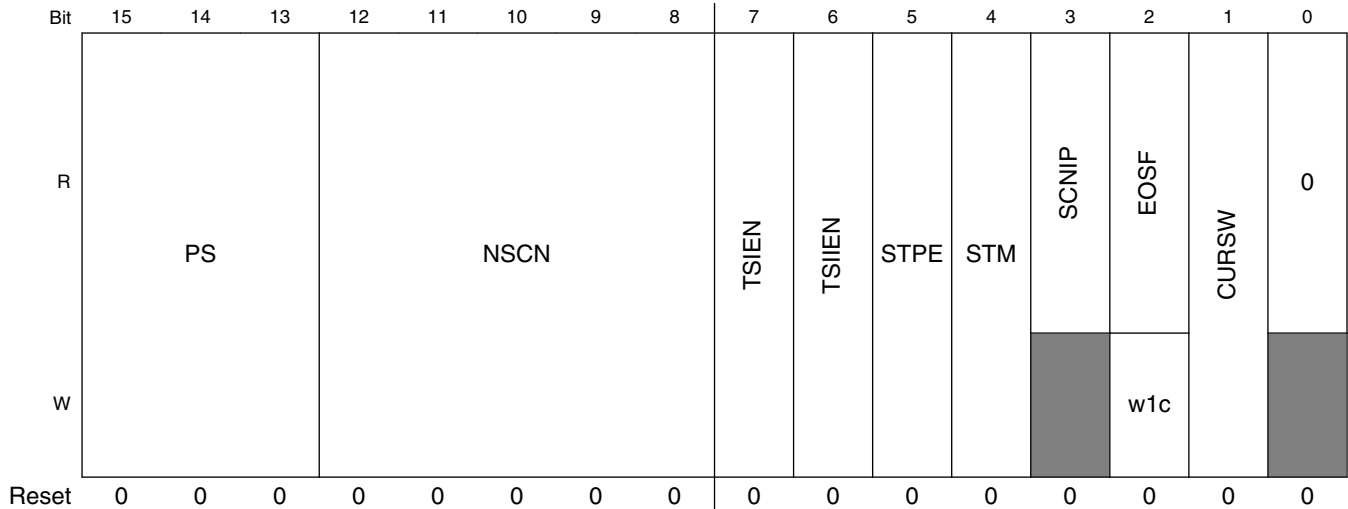

TSIx_GENCS field descriptions

| Field | Description |
|-------------------|---|
| 31 OUTRGF | Out of Range Flag. This flag is set if the result register of the enabled electrode is out of the range defined by the TSI_THRESHOLD register. This flag is set only when TSI is configured in non-noise detection mode. It can be read once the CPU wakes. Write "1" , when this flag is set, to clear it. |
| 30–29 Reserved | This field is reserved. This read-only field is reserved and always has the value 0. |
| 28 ESOR | End-of-scan or Out-of-Range Interrupt Selection This bit is used to select out-of-range or end-of-scan event to generate an interrupt. 0 Out-of-range interrupt is allowed. 1 End-of-scan interrupt is allowed. |
| 27–24 MODE | TSI analog modes setup and status When writing this field, it will set up TSI analog modes , especially, setting MODE[3:2] to not 2'b00 will configure TSI to noise detection modes. MODE[1:0] takes no effect on TSI operation mode and should always write to 2'b00 for setting up. Refer to section "Noise detection mode" for details. When reading this field, it will return the analog status . It reads the status of TSI analog bias: <ul style="list-style-type: none"> value 0000: TSI bias is not ready; value 1000: TSI bias is ready. 0000 Set TSI in capacitive sensing(non-noise detection) mode. 0100 Set TSI analog to work in single threshold noise detection mode and the frequency limitation circuit is disabled. 1000 Set TSI analog to work in single threshold noise detection mode and the frequency limitation circuit is enabled to work in higher frequencies operations. 1100 Set TSI analog to work in automatic noise detection mode. |
| 23–21 REFCHRG | REFCHRG These bits indicate the reference oscillator charge and discharge current value. 000 500 nA. 001 1 μA. 010 2 μA. |

Table continues on the next page...

TSIx_GENCS field descriptions (continued)

| Field | Description |
|------------------|---|
| | 011 4 μ A. 100 8 μ A. 101 16 μ A. 110 32 μ A. 111 64 μ A. |
| 20–19 DVOLT | DVOLT These bits indicate the oscillator's voltage rails as below. 00 DV = 1.026 V; V_P = 1.328 V; V_m = 0.302 V. 01 DV = 0.592 V; V_P = 1.111 V; V_m = 0.519 V. 10 DV = 0.342 V; V_P = 0.986 V; V_m = 0.644 V. 11 DV = 0.197 V; V_P = 0.914 V; V_m = 0.716 V. |
| 18–16 EXTCHRG | EXTCHRG These bits indicate the electrode oscillator charge and discharge current value. 000 500 nA. 001 1 μ A. 010 2 μ A. 011 4 μ A. 100 8 μ A. 101 16 μ A. 110 32 μ A. 111 64 μ A. |
| 15–13 PS | PS These bits indicate the prescaler of the output of electrode oscillator. 000 Electrode Oscillator Frequency divided by 1 001 Electrode Oscillator Frequency divided by 2 010 Electrode Oscillator Frequency divided by 4 011 Electrode Oscillator Frequency divided by 8 100 Electrode Oscillator Frequency divided by 16 101 Electrode Oscillator Frequency divided by 32 110 Electrode Oscillator Frequency divided by 64 111 Electrode Oscillator Frequency divided by 128 |
| 12–8 NSCN | NSCN These bits indicate the scan number for each electrode. The scan number is equal to NSCN + 1, which allows the scan time ranges from 1 to 32. By default, NSCN is configured as 0, which asserts the TSI scans once on the selected electrode channel. 00000 Once per electrode 00001 Twice per electrode 00010 3 times per electrode 00011 4 times per electrode 00100 5 times per electrode 00101 6 times per electrode |

Table continues on the next page...

TSIx_GENCS field descriptions (continued)

| Field | Description |
|-------------|---|
| | 00110 7 times per electrode 00111 8 times per electrode 01000 9 times per electrode 01001 10 times per electrode 01010 11 times per electrode 01011 12 times per electrode 01100 13 times per electrode 01101 14 times per electrode 01110 15 times per electrode 01111 16 times per electrode 10000 17 times per electrode 10001 18 times per electrode 10010 19 times per electrode 10011 20 times per electrode 10100 21 times per electrode 10101 22 times per electrode 10110 23 times per electrode 10111 24 times per electrode 11000 25 times per electrode 11001 26 times per electrode 11010 27 times per electrode 11011 28 times per electrode 11100 29 times per electrode 11101 30 times per electrode 11110 31 times per electrode 11111 32 times per electrode |
| 7 TSIEN | Touch Sensing Input Module Enable This bit enables TSI module. 0 TSI module disabled. 1 TSI module enabled. |
| 6 TSIIEN | Touch Sensing Input Interrupt Enable This bit enables TSI module interrupt request to CPU when the scan completes. The interrupt will wake MCU from low power mode if this interrupt is enabled. 0 TSI interrupt is disabled. 1 TSI interrupt is enabled. |
| 5 STPE | TSI STOP Enable This bit enables TSI module function in low power modes (stop, VLPS, LLS and VLLS{3,2,1}). 0 TSI is disabled when MCU goes into low power mode. 1 Allows TSI to continue running in all low power modes. |
| 4 STM | Scan Trigger Mode This bit specifies the trigger mode. User is allowed to change this bit when TSI is not working in progress. |

Table continues on the next page...

TSIx_GENCS field descriptions (continued)

| Field | Description |
|---------------|--|
| | 0 Software trigger scan. 1 Hardware trigger scan. |
| 3 SCNIP | Scan In Progress Status This read-only bit indicates if scan is in progress. This bit will get asserted after the analog bias circuit is stable after a trigger and it changes automatically by the TSI. 0 No scan in progress. 1 Scan in progress. |
| 2 EOSF | End of Scan Flag This flag is set when all active electrodes are finished scanning after a scan trigger. Write "1" , when this flag is set, to clear it. 0 Scan not complete. 1 Scan complete. |
| 1 CURSW | CURSW This bit specifies if the current sources of electrode oscillator and reference oscillator are swapped. 0 The current source pair are not swapped. 1 The current source pair are swapped. |
| 0 Reserved | This field is reserved. This read-only field is reserved and always has the value 0. |

42.3.2 TSI DATA Register (TSIx_DATA)

Address: 4004_5000h base + 4h offset = 4004_5004h

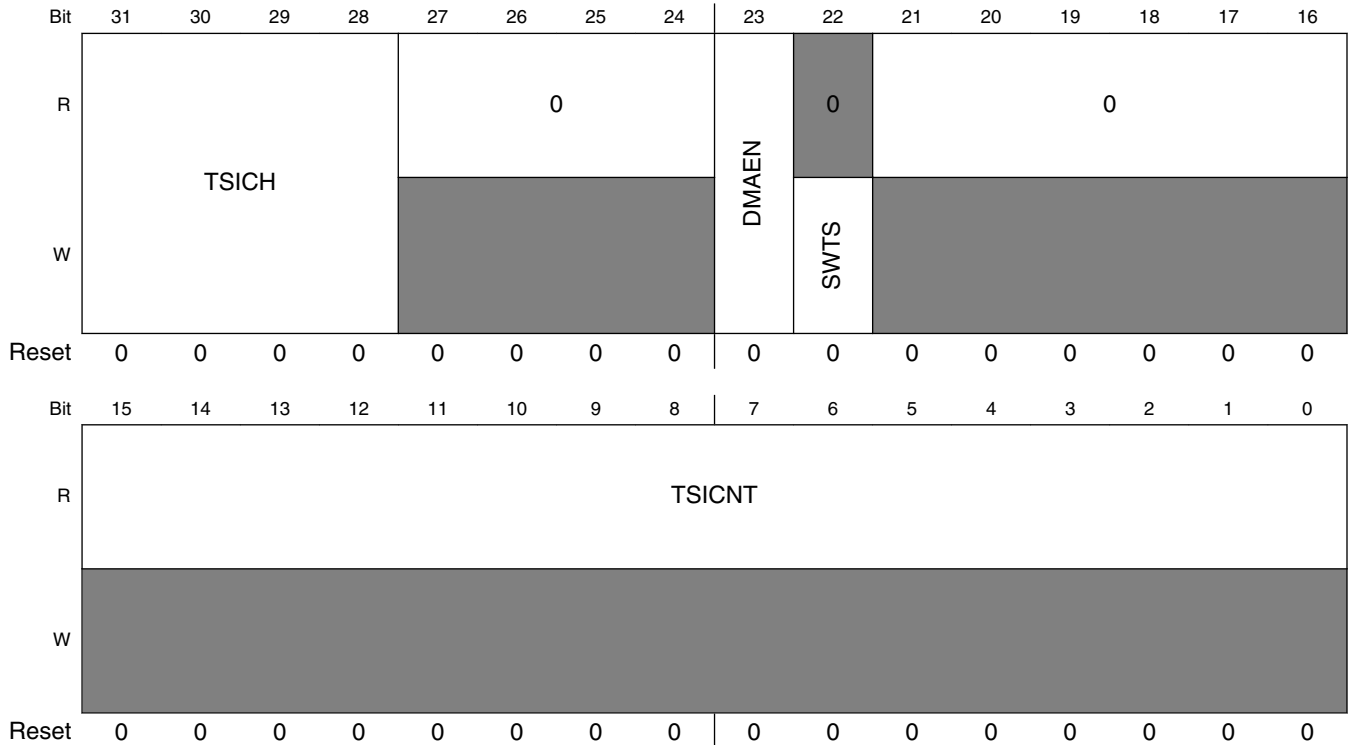

TSIx_DATA field descriptions

| Field | Description |
|----------------|--|
| 31-28 TSICH | <p>TSICH</p> <p>These bits specify current channel to be measured. In hardware trigger mode (TSI_GENCS[STM] = 1), the scan will not start until the hardware trigger occurs. In software trigger mode (TSI_GENCS[STM] = 0), the scan starts immediately when TSI_DATA[SWTS] bit is written by 1.</p> <p>0000 Channel 0. 0001 Channel 1. 0010 Channel 2. 0011 Channel 3. 0100 Channel 4. 0101 Channel 5. 0110 Channel 6. 0111 Channel 7. 1000 Channel 8. 1001 Channel 9. 1010 Channel 10. 1011 Channel 11. 1100 Channel 12. 1101 Channel 13.</p> |

Table continues on the next page...

TSIx_DATA field descriptions (continued)

| Field | Description |
|-------------------|--|
| | 1110 Channel 14. 1111 Channel 15. |
| 27–24 Reserved | This field is reserved. This read-only field is reserved and always has the value 0. |
| 23 DMAEN | DMA Transfer Enabled This bit is used together with the TSI interrupt enable bits(TSIIE, ESOR) to generate a DMA transfer request instead of an interrupt. 0 Interrupt is selected when the interrupt enable bit is set and the corresponding TSI events assert. 1 DMA transfer request is selected when the interrupt enable bit is set and the corresponding TSI events assert. |
| 22 SWTS | Software Trigger Start This write-only bit is a software start trigger. When STM bit is clear, write "1" to this bit will start a scan. The electrode channel to be scanned is determined by TSI_DATA[TSICH] bits. 0 No effect. 1 Start a scan to determine which channel is specified by TSI_DATA[TSICH]. |
| 21–16 Reserved | This field is reserved. This read-only field is reserved and always has the value 0. |
| TSICNT | TSI Conversion Counter Value These read-only bits record the accumulated scan counter value ticked by the reference oscillator. |

42.3.3 TSI Threshold Register (TSIx_TSHD)

Address: 4004_5000h base + 8h offset = 4004_5008h

| | | | | | | | | | | | | | | | | | | | | | | | | | | | | | | | | |
|-------|--------|----|----|----|----|----|----|----|----|----|----|----|----|----|----|----|--------|----|----|----|----|----|---|---|---|---|---|---|---|---|---|---|
| Bit | 31 | 30 | 29 | 28 | 27 | 26 | 25 | 24 | 23 | 22 | 21 | 20 | 19 | 18 | 17 | 16 | 15 | 14 | 13 | 12 | 11 | 10 | 9 | 8 | 7 | 6 | 5 | 4 | 3 | 2 | 1 | 0 |
| R | | | | | | | | | | | | | | | | | | | | | | | | | | | | | | | | |
| W | THRESH | | | | | | | | | | | | | | | | THRESL | | | | | | | | | | | | | | | |
| Reset | 0 | 0 | 0 | 0 | 0 | 0 | 0 | 0 | 0 | 0 | 0 | 0 | 0 | 0 | 0 | 0 | 0 | 0 | 0 | 0 | 0 | 0 | 0 | 0 | 0 | 0 | 0 | 0 | 0 | 0 | 0 | 0 |

TSIx_TSHD field descriptions

| Field | Description |
|-----------------|---|
| 31–16 THRESH | TSI Wakeup Channel High-threshold This half-word specifies the high threshold of the wakeup channel. |
| THRESL | TSI Wakeup Channel Low-threshold This half-word specifies the low threshold of the wakeup channel. |

42.4 Functional description

42.4.1 Capacitance measurement

The electrode pin capacitance measurement uses a dual oscillator approach. The frequency of the TSI electrode oscillator depends on the external electrode capacitance and the TSI module configuration. After going to a configurable prescaler, the TSI electrode oscillator signal goes to the input of the module counter. The time for the module counter to reach its module value is measured using the TSI reference oscillator. The measured electrode capacitance is directly proportional to the time.

42.4.1.1 TSI electrode oscillator

The TSI electrode oscillator circuit is illustrated in the following figure. A configurable constant current source is used to charge and discharge the external electrode capacitance. A buffer hysteresis defines the oscillator delta voltage. The delta voltage defines the margin of high and low voltage which are the reference input of the comparator in different time.

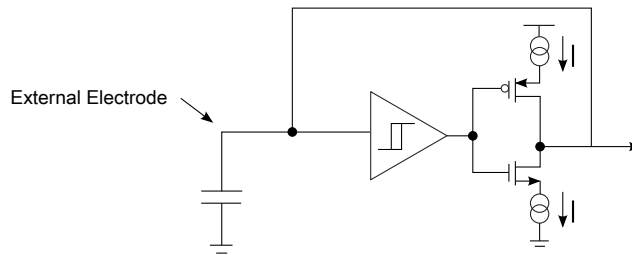

Figure 42-2. TSI electrode oscillator circuit

The current source applied to the pad capacitance is controlled by the GENCS[EXTCHRG]. The hysteresis delta voltage is defined in the module electrical specifications present in the device Data Sheet. The figure below shows the voltage amplitude waveform of the electrode capacitance charging and discharging with a programmable current.

Functional description

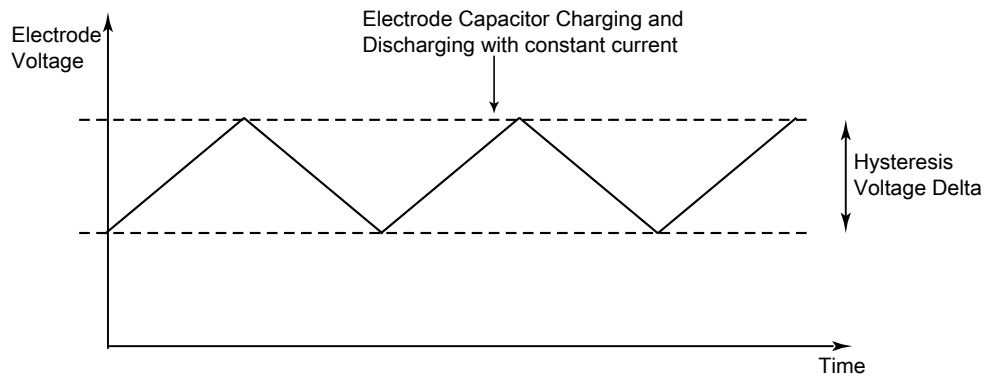

Figure 42-3. TSI electrode oscillator chart

The oscillator frequency is give by the following equation

$$F_{elec} = \frac{I}{2 * C_{elec} * \Delta V}$$

Equation 4. TSI electrode oscillator frequency

Where:

I: constant current

C_{elec} : electrode capacitance

ΔV : Hysteresis delta voltage

So by this equation, for example, an electrode with $C_{elec} = 20$ pF, with a current source of $I = 16$ μ A and $\Delta V = 600$ mV have the following oscillation frequency:

$$F_{elec} = \frac{16 \mu A}{2 * 20 pF * 600 mV} = 0.67 MHz$$

Equation 5. TSI electrode oscillator frequency

The current source is used to accommodate the TSI electrode oscillator frequency with different electrode capacitance sizes.

42.4.1.2 Electrode oscillator and counter module control

The TSI oscillator frequency signal goes through a prescaler defined by the GENCS[PS] and then enters in a modulus counter. GENCS[NSCN] defines the maximum count value of the modulus counter.

The pin capacitance sampling time is given by the time the module counter takes to go from 0 to its maximum value, defined by NSCN. The electrode sample time is expressed by the following equation:

$$T_{cap_samp} = \frac{PS * NSCN}{F_{elec}}$$

Using Equation 1

$$T_{cap_samp} = \frac{2 * PS * NSCN * C_{elec} * \Delta V}{I}$$

Equation 6. Electrode sampling time

Where:

PS: prescaler value

NSCN: module counter maximum value

I: constant current

C_{elec} : electrode capacitance

ΔV : Hysteresis delta voltage

By this equation we have that an electrode with $C = 20$ pF, with a current source of $I = 16$ μ A and $\Delta V = 600$ mV, $PS = 2$ and $NSCN = 16$ have the following sampling time:

$$T_{cap_samp} = \frac{2 * 2 * 16 * 20pF * 600mV}{16\mu A} = 48\mu s$$

42.4.1.3 TSI reference oscillator

The TSI reference oscillator has the same topology of the TSI electrode oscillator. The TSI reference oscillator instead of using an external capacitor for the electrode oscillator has an internal reference capacitor.

The TSI reference oscillator has an independent programmable current source controlled by GENCS[REFCHRG].

The reference oscillator frequency is given by the following equation:

$$F_{ref_osc} = \frac{I_{ref}}{2 * C_{ref} * \Delta V}$$

Equation 7. TSI reference oscillator frequency

Where:

Functional description

C_{ref} : Internal reference capacitor

I_{ref} : Reference oscillator current source

ΔV : Hysteresis delta voltage

Considering $C_{ref} = 1.0 \text{ pF}$, $I_{ref} = 12 \text{ }\mu\text{A}$ and $\Delta V = 600 \text{ mV}$, follows

$$F_{ref_osc} = \frac{12\mu A}{2 * 1.0pF * 600mV} = 10.0MHz$$

42.4.2 TSI measurement result

The capacitance measurement result is defined by the number of TSI reference oscillator periods during the sample time and is stored in the TSICHnCNT register.

$$TSICHnCNT = T_{cap_samp} * F_{ref_osc}$$

Using Equation 2 and Equation 1 follows:

$$TSICHnCNT = \frac{I_{ref} * PS * NSCN}{C_{ref} * I_{elec}} * C_{elec}$$

Equation 8. Capacitance result value

In the example where $F_{ref_osc} = 10.0 \text{ MHz}$ and $T_{cap_samp} = 48 \text{ }\mu\text{s}$, $TSICHnCNT = 480$

42.4.3 Enable TSI module

The TSI module can be fully functional in run, wait and low power modes. The TSI_GENCS[TSIEN] bit must be set to enable the TSI module in run and wait mode. When TSI_GENCS[STPE] bit is set, it allows the TSI module to work in low power mode.

42.4.4 Software and hardware trigger

The TSI module allows a software or hardware trigger to start a scan. When a software trigger is applied (TSI_GENCS[STM] bit clear), the TSI_GENCS[SWTS] bit must be written "1" to start the scan electrode channel that is identified by TSI_DATA[TSICH]. When a hardware trigger is applied (TSI_GENCS[STM] bit set), the TSI will not start scanning until the hardware trigger arrives. The hardware trigger is different depending on the MCU configuration. Generally, it could be an event that RTC overflows. See chip configuration section for details.

42.4.5 Scan times

The TSI provides multi-scan function. The number of scans is indicated by TSI_GENCS[NSCN] that allow the scan number from 1 to 32. When TSI_GENCS[NSCN] is set to 0 (only once), the single scan is engaged. The 16-bit counter accumulates all scan results until the NSCN time scan completes, and users can read TSI_DATA[TSICNT] to get this accumulation. When DMA transfer is enabled, the counter values can also be read out by DMA engine.

42.4.6 Clock setting

TSI is built with dual oscillator architecture. In normal sensing application, the reference oscillator clock is the only clock source for operations. The reference clock is used to measure the electrode oscillator by ticking a 16-bit counter. The reference oscillator frequency depends on the current source setting. Please refer to the [Current source](#) for more details.

The output of electrode oscillator has several prescalers up to 128 indicated by TSI_GENCS[PS]. This allows a flexible counter configuration for different electrode oscillator frequency.

42.4.7 Reference voltage

The TSI module offers a internal reference voltage for both electrode oscillator and reference oscillator. The internal reference voltage can work in low power modes even when the MCU regulator is partially powered down, which is ideally for low-power touch detection.

The charge and discharge difference voltage is configurable upon the setting of TSI_GENCS[DVOLT]. The following table shows the all the delta voltage configurations.

NOTE

This table doesn't apply to noise mode, see noise mode sections for its configuration.

Table 42-3. Delta voltage configuration

| DVOLT | V_p (V) | V_m (V) | ΔV (V) |
|-------|-----------|-----------|----------------|
| 00 | 1.328 | 0.302 | 1.026 |

Table continues on the next page...

Table 42-3. Delta voltage configuration (continued)

| DVOLT | V _p (V) | V _m (V) | ΔV (V) |
|-------|--------------------|--------------------|--------|
| 01 | 1.111 | 0.519 | 0.592 |
| 10 | 0.986 | 0.644 | 0.342 |
| 11 | 0.914 | 0.716 | 0.198 |

42.4.8 Current source

The TSI module supports eight different current source power to increment from 500 nA to 64 μA. TSI_GENCS[EXTCHRG] determines the current of electrode oscillator that charges and discharges external electrodes. The TSI_GENCS[REFCHRG] determines the current of reference oscillator on which the internal reference clock depends. The lower current source takes more time for charge and discharge, which is useful to detect high-accuracy change. The higher current source takes less time, which can be used to charge a big electrode by less power consumption.

TSI_GENCS[CURSW] allows the current source to swap, so that the reference oscillator and electrode oscillator use the opposite current sources. When TSI_GENCS[CURSW] is set and the current sources are swapped, TSI_GENCS[EXTCHRG] and TSI_GENCS[REFCHRG] still control the corresponding current sources, that is, TSI_GENCS[EXTCHRG] controls the reference oscillator current and TSI_GENCS[REFCHRG] controls the electrode oscillator current.

42.4.9 End of scan

As a scan starts, [SCNIP] bit is set to indicate scan is in progress. When the scan completes, the [EOSF] bit is set. Before clearing the [EOSF] bit, the value in TSI_DATA[TSICNT] must be read. If the TSI_GENCS[TSIEN] and TSI_GENCS[ESOR] are set and TSI_GENCS[DMAEN] is not set, an interrupt is submitted to CPU for post-processing immediately. The interrupt is also optional to wake MCU to execute ISR if it is in low power mode. When DMA function is enabled by setting TSI_GENCS[TSIEN] and TSI_GENCS[ESOR], as soon as scan completes, a DMA transfer request is asserted to DMA controller for data movement, generally, DMA engine will fetch TSI conversion result from TSI_DATA register, store it to other memory space and then refresh the TSI scan channel index (TSI_DATA[TSICH]) for next loop. When DMA transfer is done, TSI_GENCS[EOSF] is cleared automatically.

42.4.10 Out-of-range interrupt

If enabled, TSI will scan the electrode specified by TSI_DATA[TSICH] as soon as the trigger arrives. The TSI_GENCS[OUTRGF] flag generates a TSI interrupt request if the TSI_GENCS[TSIIE] bit is set and GENCS[ESOR] bit is cleared. With this configuration, after the end-of-electrode scan, the electrode capacitance will be converted and stored to the result register TSI_DATA[TSICNT], the out-of-range interrupt is only requested if there is a considerable capacitance change defined by the TSI_TSHD. For instance, if in low power mode the electrode capacitance does not vary, the out-of-range interrupt does not interrupt the CPU. This interrupt will not happen in noise detection mode. It is worthy to note that when the counter value reaches 0xFFFF is treated as an extreme case the out-of-range will not happen. Also in noise detection mode, the out-of-range will not assert either.

42.4.11 Wake up MCU from low power modes

In low power modes, once enabled by TSI_GENCS[STPE] and TSI_GENCS[TSIIE], TSI can bring MCU out of its low power modes(STOP, VLPS, VLLS,etc) by either end of scan or out of range interrupt, that is, if TSI_GENCS[ESOR] is set, end of scan interrupt is selected and otherwise, out of range is selected.

42.4.12 DMA function support

Transmit by DMA is supported only when TSI_DATA[DMAEN] is set. A DMA transfer request is asserted when all the flags based on TSI_GENCS[ESOR] settings and TSI_GENCS[TSIIE] are set. Then the on-chip DMA controller detects this request and transfers data between memory space and TSI register space. After the data transfer, DMA DONE is asserted to clear TSI_GENCS[EOSF] automatically. This function is normally used by DMA controller to get the conversion result from TSI_DATA[TSICNT] upon a end-of-scan event and then refresh the channel index(TSI_DATA[TSICH]) for next trigger.

42.4.13 Noise detection mode

The noise detection mode is used to detect power of noise. In this mode the thresholds are incremented internally by TSI until the point that there is no noise voltage trespassing the threshold.

Functional description

The noise detection mode change the circuit configuration as shown in the following figure. With this configuration, it is possible to detect touch with high levels of EMC noise present. To enter this mode, set GENCS[MODE] field to 1100b.

In noise detection mode the reference oscillator has the same configuration except the output goes to Counter2 and this counter will have its maximum count set by NSCNx2^(PS). This means this oscillator will setup the noise detection mode sense duration as shown in [Figure 42-4](#).

The blocks of external oscillator is changed and instead of an oscillator the circuit implements an RF amplitude detection. The threshold for this amplitude detection is set by DVOLT register bits. Be noted There is no oscillation on external pad (just if it is caused by external noise) in this mode.

Also the external voltage is biased by vmid voltage with a Rs series resistance.

The vmid voltage is defined as $V(vmid) = (V(vp) + V(vm))/2$.

The Rs value is defined by GENCS[EXTCHRG] register bits. See [Figure 42-5](#) for more information on noise mode TSI circuit.

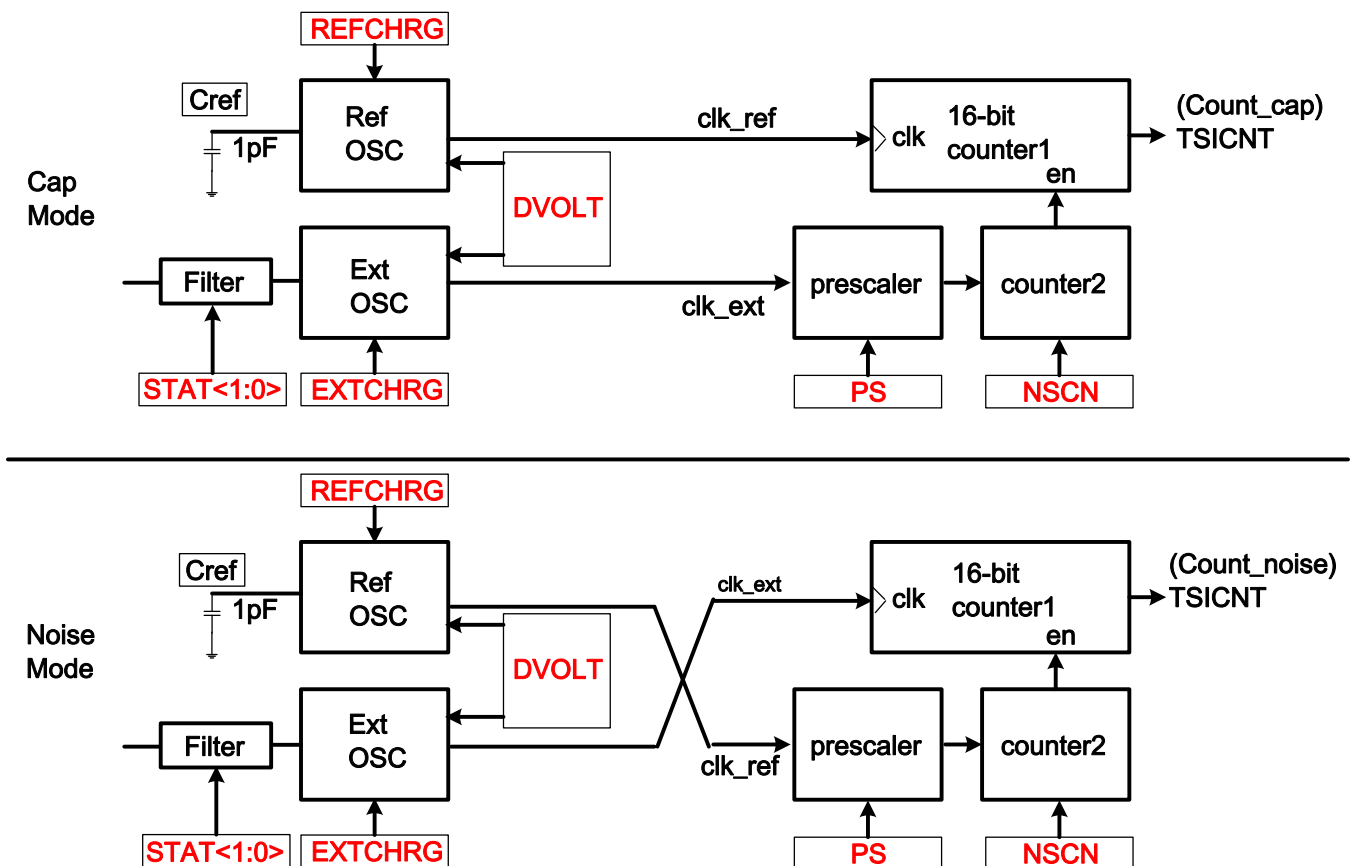

Figure 42-4. TSI noise detection mode block diagram

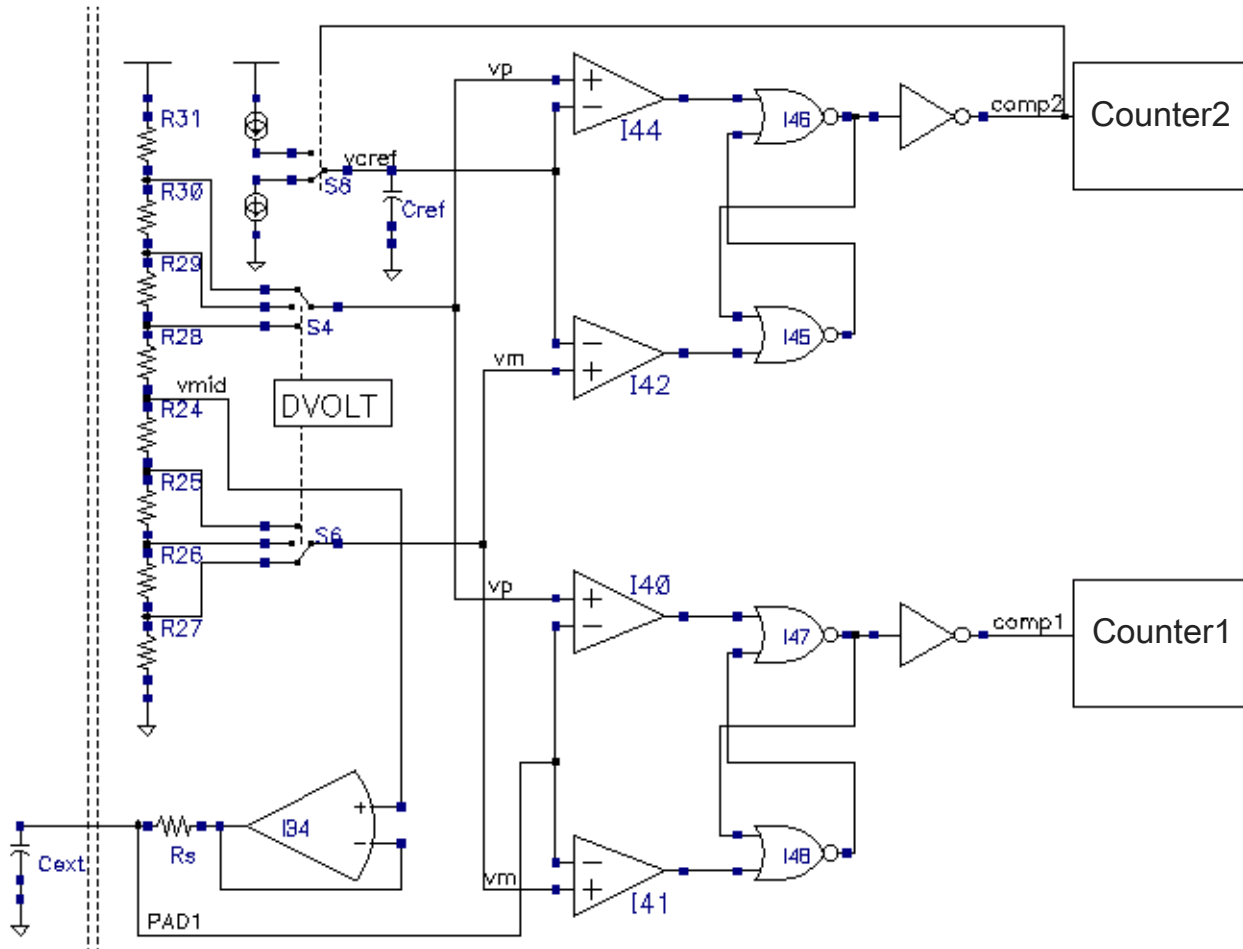

Figure 42-5. TSI circuit in noise detection mode

The table below shows all DVOLT values both in Bits and in V, all Rs values both in EXTCHRG Bits and in k Ω in order. The values indicated by valid black points can be used. The valid Rs/Dvoltage values are: 184K/0.29V, 77K/0.29V, 77K/0.43V, 32K/0.43V, 32K/0.73V, 14K/0.73V, 14K/1.03V, 5K/1.03V

To determine the noise level, the TSI noise detection algorithm shall be performed by scanning this table following the arrow direction starting at maximum Rs and minimum DVOLT.

Functional description

| Rs (Bits) (kΩ) DVOLT (Bits) (V) | | 111 | 110 | 101 | 100 | 011 |
|---|------|-------|-------|-------|-------|-----|
| | | 5.5 | 14 | 32 | 77 | 184 |
| 11 | 0.29 | | | | ● ← ● | |
| 10 | 0.43 | | | ● ← ● | ● ↓ | |
| 01 | 0.73 | | ● ← ● | ● ↓ | | |
| 00 | 1.03 | ● ← ● | ● ↓ | | | |

The TSI noise detection algorithm shall be done by application software (assume software poll method is used to check TSI scan status) as described below, note the values in below steps are just used to illustrate the algorithm flow, the actual value should be consistent with the valid combinations as shown in the table above.

1. Enable TSI by setting GENCS[TSIEN] and select a channel by writing a channel number to GENCS[TSICH] just as does for normal function mode;
2. Enable noise detection mode by writing 11b to GENCS[MODE] (MODE bit 3 and 2 with 11);
3. Initialize the noise RF amplitude and noise detection mode sense duration (T) as below:
 - a. Initialize Rs to the max value by writing 011b to GENCS[EXTCHRG] and GENCS[DVOLT] to the minimum value by writing 11b to GENCS[DVOLT];
 - b. Set up GENCS[REFCHRG], GENCS[PS] and GENCS[NSCN] bits to set the noise detection mode sense duration (T). $T = (2 \times (2^{PS}) \times NSCN \times Cref \times \Delta V) / Iref$.

NOTE

NOTE: This time needs to be enough to detect the number of WINDOW bits for the minimum noise frequency. The minimum value of T (Tmin) is calculated as below: $Tmin = (WINDOW+1)/F_{noise_min}$; Where F_{noise_min} is the minimum noise frequency (0.15 MHz) and WINDOW is 2. This results in $Tmin = 20 \mu s$. Also this algorithm needs to be consistent with the valid Rs/Dvold combinations in above table.

4. Start TSI scan with software trigger or hardware trigger just as does for normal function mode
5. Wait until TSI scan is complete (GENCS[EOSF] = 1);
6. Read TSI counter value in TSICNT and then clear GENCS[EOSF] flag;

7. Check whether the TSI counter value is within the given counter window (WINDOW, can be 2 or 3 or 5): If the TSI counter value $<$ WINDOW (i.e., the noise level is detected), go to step 12; Otherwise continue with the next step (meaning the noise level is too large);
8. If ($R_s =$ minimum value) (i.e., GENCS[EXTCHRG] = 000b, noise level is the largest at given DVOLT), go to step 10; otherwise continue with the next step;
9. Reduce R_s value by incrementing GENCS[EXTCHRG] by 1 and then go to step 4; (This action detects the next high level of noise)
10. If (DVOLT = maximum value) (i.e., GENCS[DVOLT] = 00b), this means noise is too large to detect, go to END; otherwise continue with the next step;
11. Increase DVOLT to the next level by decrementing GENCS[DVOLT] by 1 and set R_s to the max value, then go to step 4; (It means noise level is higher, so need find high DVOLT)
12. Reduce R_s value by incrementing GENCS[EXTCHRG] by 1 if ($R_s >$ minimum value) (i.e., GENCS[EXTCHRG] $<$ 111b), and then go to END (Now a matching DVOLT corresponding to the noise level is found)
13. Reduce DVOLT by incrementing GENCS[DVOLT] by 1 if ($R_s =$ maximum value) (i.e., GENCS[EXTCHRG] = 011b); (Now a matching DVOLT corresponding to the noise level is found)
14. END:

NOTE

The END condition of above algorithm can be one of

- TSI counter value within the WINDOW and $R_s \geq$ minimum value
- TSI counter value out of the WINDOW and $R_s =$ minimum value and DVOLT = maximum value

At the end of the above steps, the correct matching DVOLT value and the electrode oscillator charge and discharge current value for the current noise level is found. That is, the correct GENCS[DVOLT] value and GENCS[EXTCHRG] value are found for the current noise level. And now users can proceed with normal capacitive sense procedure by keeping both GENCS[DVOLT] and GENCS[EXTCHRG] untouched, that is, users just need switch to normal capacitive sense mode by clearing GENCS[STAT_STUP[3:2]] bits and start TSI scan.

For typical applications, the noise detection/sense algorithm shall be performed first followed by normal capacitive sense for a given channel and then alternate between noise sense and capacitive sense as shown in [Figure 42-6](#).

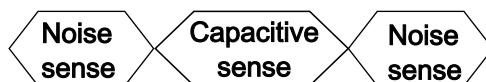

Figure 42-6. Noise detection/sense algorithm of typical application

The following flow chart shows how to detect touch with noise sense and normal capacitive sense.

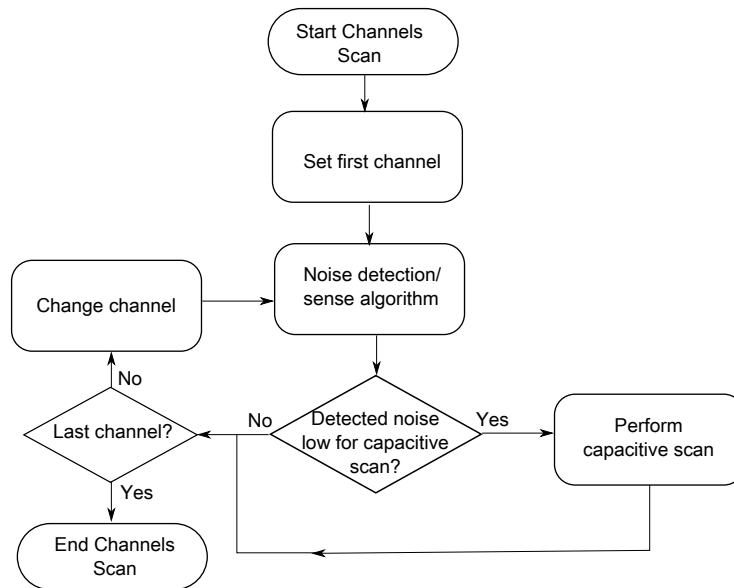

Figure 42-7. Detection of touch with noise sense and normal capacitive sense flow chart

One example of noise detection mode is shown in the following figure. In this figure the TSI is working in capacitive mode until 28 μs (T1) when it is changed to noise detection mode. In noise detection mode the selected pad is biased with 0.815V and all AC waveform in this pad is caused by a noise source external to the MCU.

It is possible to observe in the following figure that, in noise detection mode, the clkref output has the peak detection and the number of detected peaks can be counted or used by digital block. The clkext output has the internal oscillator output and can be used to set the maximum noise detection time window.

The waveform of the following figure shows two operations during noise detection mode. Again, this waveform is captured from NXP internal design simulation data, the actual useful points for noise detection should be consisted with the table provided above.

- The $V(\text{vp})$ and $V(\text{vm})$ thresholds are changed in 34.4 μs (T2).
- The R_s series resistance value is changed between 184 $\text{k}\Omega$ ($\text{GENCS}[\text{EXTCHRG}] = 011\text{b}$), 77 $\text{k}\Omega$ ($\text{GENCS}[\text{EXTCHRG}] = 100$) and 32 $\text{k}\Omega$ ($\text{GENCS}[\text{EXTCHRG}] = 101$). Because of this R_s change the amplitude of noise waveform change also.

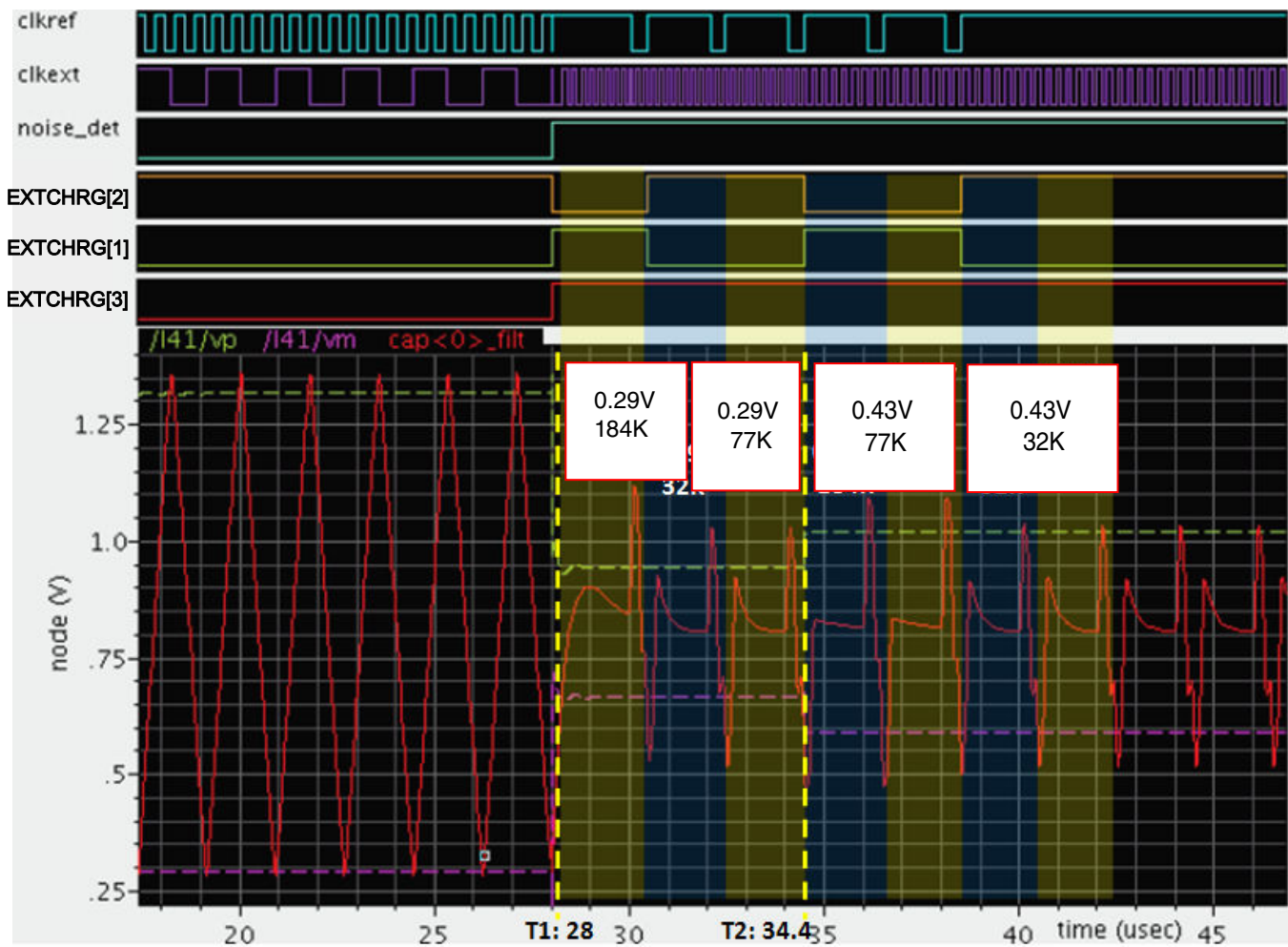

Figure 42-8. TSI noise detection mode waveform

42.4.13.1 Automatic noise mode

This mode is set by $\text{MODE}[3:2] = 11$ (noise mode 3). In this mode, the thresholds are incremented internally by the module until the point that there is no noise voltage trespassing the threshold.

The following diagram shows how it is done. The threshold comparator output goes to a counter and as the DVOLT control bits are increased the DVOLT thresholds are increased as well. The four bits are counted until 1111 (=15) and the counter is stop with this maximum value.

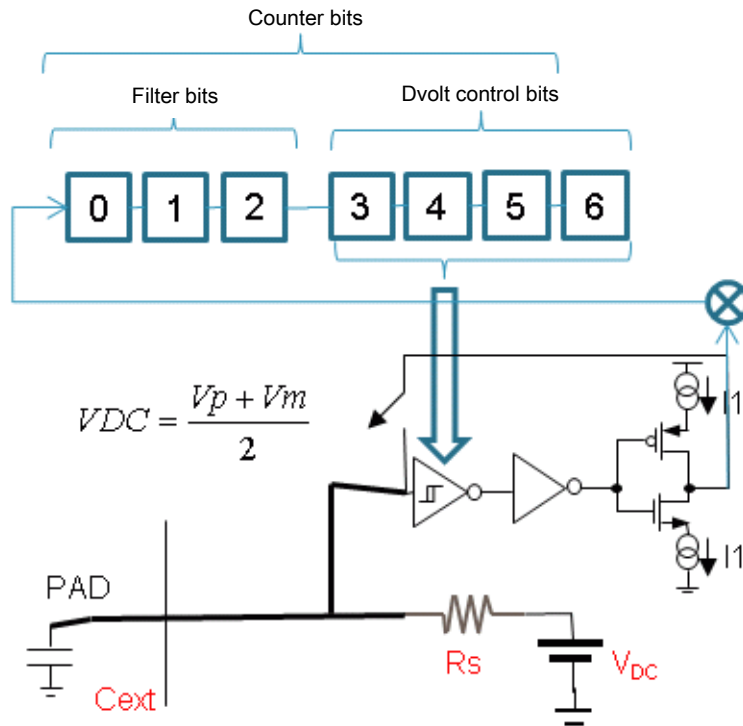

Figure 42-9. Block diagram automatic noise threshold operation

The signals that have different behavior in this noise mode (wrt capacitive mode) are shown in the following table.

Table 42-4. Signal properties in automatic noise operation mode

| Name | Function | I/O type | Power Up/Reset state |
|--------------|---|----------|----------------------|
| MODE[3:2] | 11—Noise mode operation with frequency limitation and automatic threshold counter. | I | 00 |
| EXTCHRG[2:1] | In this operation mode, these bits select the number of filter bits. 00—3 filter bits 01—2 filter bits 10—1 filter bit 11—no filter bit | I | 00 |
| EXTCHRG[0] | In this operation mode, this bit selects the series resistance. 0—uses $R_s=32\text{ k}\Omega$ 1—uses $R_s=187\text{ k}\Omega$ Independent of this bit selection, the threshold 15 is done with $R_s = 5.5\text{ k}\Omega$ | I | 0 |

Table continues on the next page...

Table 42-4. Signal properties in automatic noise operation mode (continued)

| Name | Function | I/O type | Power Up/Reset state |
|------------|--|----------|----------------------|
| DVOLT[1:0] | Selects voltage rails of the internal oscillator | I | 00 |
| MODE[3:0] | DVOLT counter bits output. This field keeps 0000b if MODE[3:2] is not 11 after entering automatic noise mode. | O | 0000 |

42.4.13.2 Single threshold noise modes

These modes are reset by MODE[3:2]=01 and 10.

In this mode, the thresholds are set by user via register bits as described in the following table.

During this mode the internal oscillator rails are set to the maximum (equivalent to DVOLT[1:0]=00).

Table 42-5. Signal properties in single noise modes (1,2)

| Name | Function | I/O type | Power up / reset |
|-----------------------------|---|----------|------------------|
| MODE[3:2] | 01 or 10- Single threshold noise mode operation. | I | 00 |
| DVOLT[1:0], EXTCHRG[2:1] | In this operation mode these 4 bits are used select the noise threshold. These combinations are the maximum possible combinations, however, in real application, only the valid combinations in the above table should be used. 0000 - DVpm = 0.038 V, Vp = 0.834 V, Vm = 0.796 V 0001 - DVpm = 0.050 V, Vp = 0.830 V, Vm = 0.790 V 0010 - DVpm = 0.066 V, Vp = 0.848 V, Vm = 0.782 V 0011 - DVpm = 0.087 V, Vp = 0.858 V, Vm = 0.772 V 0100 - DVpm = 0.114 V, Vp = 0.872 V, Vm = 0.758 V 0101 - DVpm = 0.150 V, Vp = 0.890 V, Vm = 0.740 V 0110 - DVpm = 0.197 V, Vp = 0.914 V, Vm = 0.716 V 0111 - DVpm = 0.260 V, Vp = 0.945 V, Vm = 0.685 V 1000 - DVpm = 0.342 V, Vp = 0.986 V, Vm = 0.644 V 1001 - DVpm = 0.450 V, Vp = 1.040 V, Vm = 0.590 V 1010 - DVpm = 0.592 V, Vp = 1.111 V, Vm = 0.519 V 1011 - DVpm = 0.780 V, Vp = 1.205 V, Vm = 0.425 V 1100 - DVpm = 1.026 V, Vp = 1.328 V, Vm = 0.302 V 1101 - DVpm = 1.350 V, Vp = 1.490 V, Vm = 0.140 V | I | XXXX |

Table continues on the next page...

Table 42-5. Signal properties in single noise modes (1,2) (continued)

| Name | Function | I/O type | Power up / reset |
|------------|---|----------|------------------|
| | 1110 - DVpm = 1.630 V, Vp = 1.630 V, Vm = 0 V 1111 - DVpm = 1.630 V, Vp = 1.630 V, Vm = 0 V | | |
| EXTCHRG[0] | In this operation mode this bits selects the series resistance. 0 - uses Rs = 32 kΩ. 1- uses Rs = 187 kΩ. Independent of this bit selection the threshold 15 is done with Rs = 5.5 kΩ. | I | XX |

Chapter 43

LP Trusted Cryptography (LTC)

43.1 LP Trusted Cryptography Block Diagram

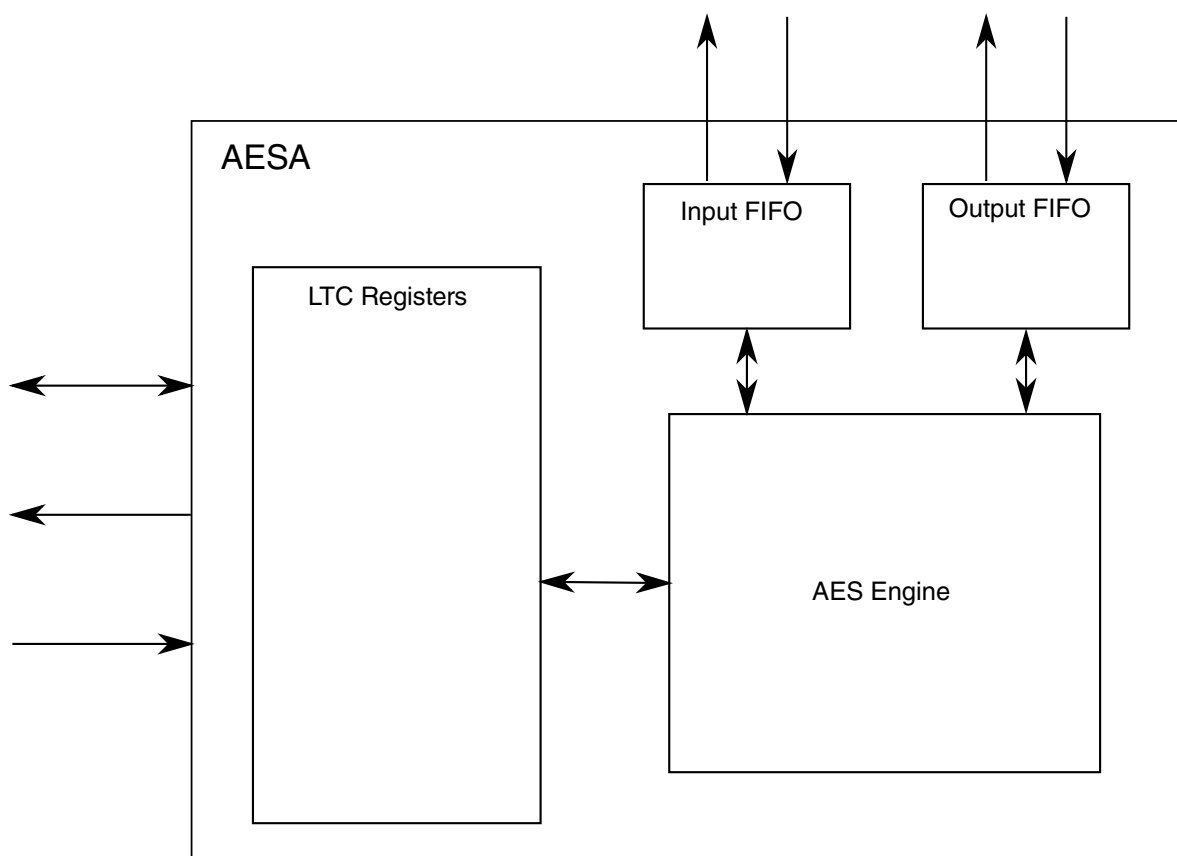

Figure 43-1. LTC Block Diagram

43.2 Feature summary

LTC includes the following features:

- Cryptographic authentication
 - Message authentication codes (MAC)
 - AES-CMAC
 - AES-XCBC-MAC
 - Auto padding
 - ICV checking
- Authenticated encryption algorithms
 - AES-CCM (counter with CBC-MAC)
 - AES-GCM (Galois counter mode)
- Symmetric key block ciphers
 - AES (128-bit keys)
 - Cipher modes
 - ECB, CBC, CTR for AES
- Secure Scan

43.3 AES accelerator (AESA) functionality

The advanced encryption standard accelerator (AESA) module is a hardware co-processor capable of accelerating the advanced encryption standard (AES) cryptographic algorithm.

43.3.1 Differences between the AES encrypt and decrypt keys

The decrypt form of the key is different from the encrypt form of the key, because AES successively modifies the cryptographic key during the steps of the cryptographic operation. The decryption operation yields the correct result only if the modified form of the key (the decrypt key) is used at the beginning of the decryption operation. Unless told otherwise (via the DK bit in the Mode Register), AES assumes that a key loaded from memory is the encrypt key, that is, the form appropriate for encryption. If a decryption operation is specified and $DK = 0$, AES first goes through the steps required to derive the decrypt key from the encrypt key, and then performs the decryption operation. If a decryption operation is specified and $DK = 1$, the steps required to derive the decrypt key are skipped and the decryption operation is performed immediately, significantly improving performance for small data blocks.

Note that the difference between the encrypt key and the decrypt key must be taken into account when sharing keys between jobs. When an AES decryption job loads a key from memory, it is probably an encrypt key, so the DK bit in the Mode Register should be set to 0 so that AES derives the decrypt key from the encrypt key before beginning the decryption operation. But when a subsequent AES decryption job shares the key from a

previous decryption job, the key that is shared is a decrypt key. In that case, the DK bit should be set to 1, which tells AES to skip the key derivation steps. If DK were set to 0 in this case, the decrypt key would be modified as if it were an encrypt key, and consequently, the wrong key value would be used in the decryption operation.

43.3.2 AESA modes of operation

The following modes are supported by AESA:

- Electronic codebook (ECB)
- Cipher block chaining (CBC)
- Counter (CTR)
- XTS tweakable block cipher
- Extended cipher block chaining message authentication code (XCBC-MAC)
- Cipher-based MAC (CMAC)
- CTR and CBC-MAC (CCM)
- Galois/Counter mode (GCM)
- Combined CBC and XCBC (CBCXCBC)
- Combined CTR and XCBC (CTRXCBC)
- Combined CBC and CMAC (CBC-CMAC)
- Combined CTR and CMAC (CTR-CMAC)

AES modes can be classified into these categories:

- Confidentiality (ECB, CBC, CTR, XTS)
- Authenticated Confidentiality (CCM, CCM*, GCM, CBCXCBC, CTRXCBC)
- Authentication (XCBC-MAC, CMAC)

CBC Mode can also be viewed as an authentication mode when used to encrypt data, because it provides CBC-MAC in the context registers.

43.3.3 AESA use of registers

Note the following regarding the AESA's use of registers:

- For all modes, if AES is selected and the mode code written to the Mode Register does not correspond to any of the implemented AES modes, the illegal-mode error is generated.
- If ICV-only(Integrity Check Value, Final MAC) jobs are created (no data to be processed, only ICV to be checked) in modes that support ICV check, the AS mode field should be reset.

43.3.4 AES ECB mode

The electronic codebook (ECB) mode is a confidentiality mode that features, for a given key, the assignment of a fixed, ciphertext block to each plaintext block, analogous to the assignment of code words in a codebook. In ECB encryption, the forward cipher function is applied directly and independently to each block of the plaintext. The resulting sequence of output blocks is the ciphertext. In ECB decryption, the inverse cipher function is applied directly and independently to each block of the ciphertext. The resulting sequence of output blocks is the plaintext.

43.3.4.1 AES ECB mode use of the Mode Register

AES ECB mode uses the Mode Register as follows:

- The Encrypt (ENC) field should be 1 for ECB encryption and 0 for ECB decryption.
- The Algorithm State (AS) field is not used in ECB mode.
- The Additional Algorithm Information (AAI) field must be set with value 20h that activates ECB mode. Setting the MSB in the AAI field (interpreted as the Decrypt Key or DK bit for AES operations) specifies that the key loaded to the Key Register is the decryption form of the key, rather than the encryption form of the key. If DK = 0, when a decryption operation is requested AES processes the content of the Key Register to yield the decryption form of the key. If DK = 1, AES skips this processing. The illegal-mode error is generated if DK = 1 and ENC=1.
- The Algorithm (ALG) field is used to activate AESA by setting it to 10h.

43.3.4.2 AES ECB mode use of the Context Register

ECB does not use Context Registers.

43.3.4.3 AES ECB Mode use of the Data Size Register

The length of the message to be processed in bytes must be written to the Data Size register. If this value is not divisible by 16, the Data Size error is generated.

43.3.4.4 AES ECB Mode use of the Key Register

ECB keys must be written to the Key Register and can have only 16 bytes.

43.3.4.5 AES ECB Mode use of the Key Size Register

The number of bytes in the ECB key must be written to the Key Size register. 16 bytes is the only key size supported for this mode.

43.3.5 AES CBC mode

The CBC mode is described in this table.

Table 43-1. AES CBC, OFB, CFB128 modes

| Name | Abbreviation | Function |
|----------------------------|--------------|--|
| Cipher-block chaining mode | CBC | Confidentiality mode whose encryption process features the combining ("chaining") of the plaintext blocks with the previous ciphertext blocks. The CBC mode requires an IV (Initialization Vector) to combine with the first plaintext block NOTE: CBC mode uses both forward and inverse AES cipher. OFB and CFB use only forward AES cipher. |

43.3.5.1 AES CBC mode use of the Mode Register

The AES CBC mode use the Mode Register as follows:

- The Encrypt (ENC) field should be 1 for encryption and 0 for decryption
- The ICV/TEST bit is not used in these modes.
- The Algorithm State (AS) field is used only in CBC mode to prevent IV update in the context for the last data block when set to "Finalize" (2h).
- The Additional Algorithm Information (AAI) field must be set with value 10h that activates CBC mode. The Decrypt Key [DK] (AAI field MSB) bit specifies that the key loaded to the Key Register is the decrypt key. The illegal mode error is generated if DK=1 and ENC=1.
- The Algorithm (ALG) field is used to activate AESA by setting it to 10h.

43.3.5.2 AES CBC mode use of the Context Register

The AES CBC mode use the Context Register as follows:

- CBC use the Context Registers to provide IV, which is updated with every processed block of a message. When a message is split into chunks and processed in multiple

sessions, the IV must be saved and later restored for the next chunk to be processed correctly. At the end of CBC processing, IV is also the MAC of the message.

- If the AS field of the Mode Register is set to "Finalize" (2h) in the CBC mode, the last IV update is not written to the context. This enables CBC encryption to effectively perform ECB encryption transformation of a single-block message located in the context in place of IV, and with an all-zero block provided as input data through the FIFO without overwriting the context.

Table 43-2. Context usage in CBC mode

| Context Word | Definition |
|--------------|-------------|
| 0 | IV [127:96] |
| 1 | IV [95:64] |
| 2 | IV [63:32] |
| 3 | IV [31:0] |

43.3.5.3 AES CBC mode use of the Data Size Register

The AES CBC mode use the Data Size Register as follows:

- The byte length of the message to be processed must be written to the Data Size Register.
- The first write to this register initiates processing. It can also be written during processing in which case the value written is accumulated to the current state of the register.
- After the Data Size Register is written for the last time, its value must be divisible by 16 in CBC mode, otherwise the data-size error is generated.

43.3.5.4 AES CBC mode use of the Key Register

The AES CBC mode use the Key Register as follows:

- A CBC key must be written to the Key Register.
- Keys must be 16 bytes.

43.3.5.5 AES CBC mode use of the Key Size Register

The AES CBC mode use the Key Size Register as follows:

- The number of bytes in a key must be written to the Key Size register.
- 16 bytes is the only key size supported for this mode.

43.3.6 AES CTR mode

The counter (CTR) mode is a confidentiality mode that features the application of the forward cipher to a set of input blocks, called counters, to produce a sequence of output blocks that are exclusive-ORed with the plaintext to produce the ciphertext, and vice versa. Note that the counter value must be unique for each data block that is encrypted with the same key. uses a 128-bit counter to ensure that the counter value will not overflow and wrap around.

NOTE

It is the user's responsibility to ensure that the same key value is not used again following a reset.

43.3.6.1 AES CTR mode use of the Mode Register

The AES CTR mode uses the Mode Register as follows:

- The Additional Algorithm Information (AAI) field should be set to 00h to activate CTR mode. If the Decrypt Key [DK] (AAI field MSB) bit is set, the illegal-mode error is generated, because CTR uses only forward AES cipher requiring encryption rather than decryption keys.
- The Algorithm State (AS) field when set to "Finalize" (2h) prevents counter update in the context for the last data block.
- The Algorithm (ALG) field is used to activate AESA by setting it to 10h.

43.3.6.2 AES CTR mode use of the Context Register

The AES CTR mode uses the Context Register as follows:

- CTR uses context words 4,5,6 and 7 to provide initial counter value (CTR0). This value is incremented with every processed block of a message. When a message is split into chunks and processed in multiple sessions, the CTR_i field of context has to be saved and later restored for the next chunk to be processed correctly.
- If the AS field of the Mode Register is set to Finalize (2h) in the CTR mode, the last counter update is not written to the context. This enables CTR encryption to effectively perform ECB encryption transformation of a single-block message

located in the context words 4,5,6 and 7 in place of CTR0 and with all-zero block provided as input data through the FIFO without overwriting the context.

Table 43-3. Context usage in CTR mode

| Context Word | Initial-input definition | Context-switching definition |
|--------------|--------------------------|------------------------------|
| 0 | - | - |
| 1 | - | - |
| 2 | - | - |
| 3 | - | - |
| 4 | CTR0 [127:96] | CTRi [127:96] |
| 5 | CTR0 [95:64] | CTRi [95:64] |
| 6 | CTR0 [63:32] | CTRi [63:32] |
| 7 | CTR0 [31:0] | CTRi [31:0] |

43.3.6.3 AES CTR mode use of the Data Size Register

The byte-length of the message to be processed must be written to the Data Size register. CTR decrements the value in this register with every processed block.

43.3.6.4 AES CTR mode use of the Key Register

- CTR key must be written to the Key Register.
- The Key Register only supports 16 byte keys.

43.3.6.5 AES CTR mode use of the Key Size Register

The number of bytes in a key must be written to the Key Size register by the time that MODE and DATA SIZE have been written. 16 bytes is the only key size supported for this mode.

43.3.7 AES XCBC-MAC and CMAC modes

The AES XCBC-MAC and CMAC modes are described together because of their similarities. They are extensions of the AES CBC mode that produces a key-dependent, one-way hash (or message authentication code (MAC)) in a secure fashion across messages of varying lengths. They also provide data-integrity and data-origin authentication regarding the original message source.

43.3.7.1 AES XCBC-MAC and CMAC modes use of the Mode Register

The AES XCBC-MAC and CMAC modes use the Mode Register as follows:

- The Encrypt (ENC) bit is ignored.
- The ICV bit must be set for computed MAC to be compared with the received MAC. The received MAC must be written to the Input Data FIFO after message data and the FIFO data type must be set to ICV. If this bit is not set, XCBC-MAC and CMAC do not expect received ICV to be supplied after message data.
- The Algorithm State (AS) field is defined for XCBC-MAC as shown in this table.

Table 43-4. Mode Register[AS] operation selections in AES XCBC-MAC

| Operation | Description |
|---------------------|---|
| INITIALIZE | Message is processed in multiple sessions and the current session is the first one. During initialization, derived keys K3 and K2 that are XOR-ed with the last message block are computed and stored in the context to be used in the last processing session. The derived key K1 used as an AES key is computed and written back to the Key Register over the original key |
| INITIALIZE/FINALIZE | Message is processed in a single XCBC session and the final MAC is computed |
| UPDATE | Message is processed in multiple sessions and the current session is neither the first nor the last. Derived keys K2 and K3 are provided in the context and the derived key K1 is provided in the Key Register. If decryption is requested, and data size is not written or is set to 0, and ICV bit is 1 - AS = UPDATE means that Check ICV (CICV) job is requested. The CICV-only job does not process any data, it just pops received ICV/MAC from the Input Data FIFO, and compares it to the computed MAC that is restored with the rest of the context from the previous session. |
| FINALIZE | Message is processed in multiple sessions and the current session is the last one. Derived keys K2 and K3 are provided in the context and the derived key K1 is provided in the Key Register. The final MAC is computed |

- The Algorithm State (AS) field is defined for CMAC as shown in this table.

Table 43-5. Mode Register[AS] operation selections in CMAC

| Operation | Function |
|---------------------|--|
| INITIALIZE | Message is processed in multiple sessions and the current session is the first one. During initialization, the constant $L = E(K, 0)$ is computed as encrypted block of zeros using key K and stored in the context to be used in the last processing session for derivation of keys K1 and K2. One of these keys will be XOR-ed with the last message block. |
| INITIALIZE/FINALIZE | Message is processed in a single session and the final MAC is computed |
| UPDATE | Message is processed in multiple sessions and the current session is neither the first nor the last. The constant L used for key derivation is provided in the context. If decryption is requested, and data size is not written or is set to 0, and ICV bit is 1 - AS = UPDATE means that Check ICV (CICV) job is requested. The CICV-only job does not process any data, it just pops received ICV/MAC from the Input Data FIFO, and compares it to the computed MAC that is restored with the rest of the context from the previous session |
| FINALIZE | Message is processed in multiple sessions and the current session is the last one. The constant L used for key derivation is provided in the context. The final MAC is computed |

- If the AS field is not set to either "Initialize/Finalize" or "Finalize" and the ICV bit is set to 1, the illegal-mode error is generated, except for CICV-only jobs.
- The Additional Algorithm Information (AAI) field must be set to 70h for XCBC and 60h for CMAC to be activated. Setting the DK bit (AAI field MSB) will cause the Illegal Mode error.
- The Algorithm (ALG) field is used to activate AESA by setting it to 10h.

43.3.7.2 AES XCBC-MAC and CMAC Modes use of the Context Register

The AES XCBC-MAC and CMAC modes use the Context Register as follows:

- No data needs to be provided in the context when starting a new XCBC or CMAC session.
- The computed MAC and the derived keys K2 and K3 are written back to the context by XCBC.
- The computed MAC and the constant L = E(K,0), computed as encrypted block of zeros using key K, are written back to the context by CMAC.
- When a message is split into chunks and processed in multiple sessions, these values need to be saved before context switch and restored before the next chunk of a message is to be processed. At the end of message processing the first 2 words of the context contain the MAC value.

Table 43-6. Context usage in XCBC-MAC and CMAC modes

| Mode | Context word | Context-switching definition | Final-result definition |
|----------|--------------|------------------------------|-------------------------|
| XCBC-MAC | 0 | MAC[127:96] | MAC[127:96] |
| | 1 | MAC[95:64] | MAC[95:64] |
| | 2 | MAC[63:32] | MAC[63:32] |
| | 3 | MAC[31:0] | MAC[31:0] |
| | 4 | K3[127:96] | - |
| | 5 | K3[95:64] | - |
| | 6 | K3[63:32] | - |
| | 7 | K3[31:0] | - |
| | 8 | K2[127:96] | - |
| | 9 | K2[95:64] | - |
| | 10 | K2[63:32] | - |
| | 11 | K2[31:0] | - |
| CMAC | 0 | MAC[127:96] | MAC[127:96] |
| | 1 | MAC[95:64] | MAC[95:64] |
| | 2 | MAC[63:32] | MAC[63:32] |
| | 3 | MAC[31:0] | MAC[31:0] |

Table continues on the next page...

Table 43-6. Context usage in XCBC-MAC and CMAC modes (continued)

| Mode | Context word | Context-switching definition | Final-result definition |
|------|--------------|------------------------------|-------------------------|
| | 4 | L[127:96] | - |
| | 5 | L[95:64] | - |
| | 6 | L[63:32] | - |
| | 7 | L[31:0] | - |

43.3.7.3 AES XCBC-MAC and CMAC modes use of the ICV Size Register

The AES XCBC-MAC and CMAC modes use the ICV Size Register as follows:

- This ICV register is used to provide received ICV/MAC byte-size when it is other than 16 bytes.
- The computed ICV/MAC written to the context in the XCBC mode is always 16 bytes.
- In CMAC mode, this register determines also the computed MAC size-the remaining bytes are cleared.
- Supported values for ICV size are 4 to 16 bytes. If this register is 0, the size of ICV is 16 bytes.

43.3.7.4 AES XCBC-MAC and CMAC modes use of the Data Size Register

The AES XCBC-MAC and CMAC modes use the Data Size Register as follows:

- The byte-length of the message to be processed must be written to the Data Size register.
- XCBC-MAC and CMAC decrement the value in this register with every processed block.

43.3.7.5 AES XCBC-MAC and CMAC modes use of the Key Register

The AES XCBC-MAC and CMAC modes use the Key Register as follows:

- The key must be written to this register.
- For XCBC-MAC, if the AS mode field is set to either "Initialize" or "Initialize/Finalize", it is the original XCBC key (K) that must be written here. Otherwise, the

derived key (K1) must be restored to this register. CMAC only uses original key K as an AES key.

43.3.7.6 AES XCBC-MAC and CMAC modes use of the Key Size Register

The AES XCBC-MAC and CMAC modes use the Key Size Register as follows:

- The total number of key bytes must be written to the Key Size register.
- 16 bytes is the only key size supported for this mode.

43.3.7.7 ICV checking in AES XCBC-MAC and CMAC modes

Automatic ICV checking is enabled by setting the ICV bit of the Mode Register to 1. When ICV is set to 1, the AS mode field must be set to either "Finalize" or "Initialize/Finalize"; otherwise the illegal-mode error is generated, except for CICV-only (Check-ICV-only) jobs.

The received ICV must be provided on the FIFO after the message data. The FIFO data type must be set to ICV when it is put on the FIFO. The size of the received and computed ICV is provided in the ICV Size register.

If the ICV check detects a mismatch between the decrypted received ICV and the computed ICV, the ICV error is generated.

43.3.8 AESA CCM and CCM* modes

CCM and CCM* consists of two related processes: generation encryption and decryption verification, which combine two cryptographic primitives: counter mode encryption (CTR) and cipher-block chaining based authentication (CBC-MAC). Only the forward cipher function of the block cipher algorithm is used within these primitives. Note that the counter value must be unique for each data block that is encrypted with the same key. AES uses a 128-bit counter to ensure that the counter value does not overflow and wrap around.

NOTE

It is the user's responsibility to ensure that the same key value is not used again following a reset.

43.3.8.1 Generation encryption

A cipher-block chaining is applied to the payload, the associated data (AAD), and the nonce to generate a message authentication code (MAC); then counter mode encryption is applied to the MAC and the payload to transform them into an unreadable form, called the ciphertext. Thus, CCM generation encryption expands the size of the payload by the size of the MAC.

43.3.8.2 Decryption verification

Counter-mode decryption is applied to the purported ciphertext to recover the MAC and the corresponding payload; then cipher block chaining is applied to the payload, the received associated data, and the received nonce to verify the correctness of the MAC.

43.3.8.3 AES CCM and CCM* mode use of the Mode Register

The AES CCM and CCM* mode uses the Mode Register as follows:

- The Encrypt (ENC) bit must be set to 1 for encryption and 0 for decryption.
- The ICV bit must be set for CCM and CCM* to compare computed MAC with the received MAC when decryption is requested.
- The received MAC must be written to the input-data FIFO after message data and the FIFO data type must be set to ICV.
- Setting the ICV bit causes the received MAC to be decrypted and compared with the computed MAC.
- The number of MSBs to be compared is defined by the MAC size in the CCM and CCM* IV (B_0) as described in the CCM specification.
- If the AS field is set to FINALIZE, but $ICV = 0$, AESA does not expect received ICV to be put on the input-data FIFO. In that case, MAC is computed and truncated to the specified size for decryption.
- For encryption, the computed MAC is encrypted and truncated to size. The illegal-mode error is generated if $ICV = 1$ and $ENC = 1$.
- If $ICV = 1$ and the decrypted received MAC do not match computed MAC, the ICV error is generated.
- The Algorithm State (AS) field is defined for CCM and CCM* as follows:

Table 43-7. Mode Register[AS] operation selections in AES CCM and CCM*

| Operation | Description |
|---------------------|---|
| INITIALIZE | Message is processed in multiple sessions and the current session is the first one. During initialization, the initial counter CTR0 is encrypted in the CTR mode and the B0 is processed with the CBC-MAC mode. The resulting values are stored in the context. Also, the size of MAC is decoded from B0 and written to the context. This AS setting must be used whenever the first part (or whole) AAD is being processed |
| INITIALIZE/FINALIZE | Message is processed in a single CCM or CCM* session and the final MAC is computed and encrypted. The initial counter CTR0 and B0 must be provided in the context |
| UPDATE | Message is processed in multiple sessions and the current session is neither the first nor the last. All context data is restored from the previous session and the key is written to the Key Register. If decryption is requested, and data size is not written or is set to 0, and ICV bit is 1 - AS=UPDATE means that a CICV-only job is requested. The CICV-only job does not process any data, it just pops received ICV/MAC from the Input Data FIFO, decrypts it and compares it to the computed MAC that is restored with the rest of the context from the previous session |
| FINALIZE | Message is processed in multiple sessions and the current session is the last one. All context data is restored from the previous session and the key is written to the Key Register. The final MAC is computed and encrypted |

- Whenever AS is set to Initialize or Initialize/Finalize, context registers must be zero.
- If the AS field is not set to either Initialize/Finalize or Finalize and the ICV bit is set to 1, the illegal-mode error is generated. This does not apply in case when only ICV check is requested as described for AS = UPDATE.
- The Additional Algorithm Information (AAI) field must be set to 80h for both CCM and CCM* to be activated. The C2K bit is used to select a key register. If C2K = 0, CCM and CCM* uses the key in the Key Register. Setting the DK bit causes the illegal-mode error.
- The Algorithm (ALG) field is used to activate AESA by setting it to 10h.

43.3.8.4 AES CCM and CCM* modes use of the Context Register

The AES CCM and CCM* mode uses the Context Register as follows:

- B0 and the initial counter CTR0 must be provided in the context before the first chunk of the message is to be processed. During initialization, the initial counter CTR0 is encrypted in the CTR mode and B0 (which functions like a CBC-MAC IV in CCM and CCM*) is processed with the CBC-MAC mode. The resulting values are stored in the context. Also, the size of MAC is decoded from B0 and written to context word 13.
- If there is AAD, the first block of it defines its size, and that value is decoded and written to context word 12. All of the context data must be restored before the next chunk of the message is to be processed in multi-session processing.
- For CCM and CCM* encryption, the ICV (encrypted final MAC) is written to context words 8-11. For CCM and CCM* decryption, the ICV (received MAC),

which is always encrypted, is decrypted to words 8-11. The final computed MAC is written (in clear) to context words 0-3.

Table 43-8. Context usage in CCM and CCM* mode encryption

| Context Word | Initial-input definition | Intermediate definition | Final-output definition |
|--------------|--------------------------|---|-------------------------|
| 0 | B0[127:96] | - | MAC[127:96] |
| 1 | B0[95:64] | - | MAC[95:64] |
| 2 | B0[63:32] | - | MAC[63:32] |
| 3 | B0[31:0] | - | MAC[31:0] |
| 4 | CTR0[127:96] | CTR[127:96] | - |
| 5 | CTR0[95:64] | CTR[95:64] | - |
| 6 | CTR0[63:32] | CTR[63:32] | - |
| 7 | CTR0[31:0] | CTR[31:0] | - |
| 8 | - | E(CTR0)[127:96] ¹ | E(MAC)[127:96] |
| 9 | - | E(CTR0)[95:64] ¹ | E(MAC)[95:64] |
| 10 | - | E(CTR0)[63:32] ¹ | E(MAC)[63:32] |
| 11 | - | E(CTR0)[31:0] ¹ | E(MAC)[31:0] |
| 12 | - | AAD size; see Table 43-10 | - |
| 13 | - | MAC size; see Table 43-11 | - |

1. E(x) means encrypted x

Table 43-9. Context usage in CCM and CCM* modes decryption

| Context Word | Initial-input definition | Context-switching Definition | Final-result definition |
|--------------|--------------------------|---|--------------------------------|
| 0 | B0[127:96] | - | MAC[127:96] |
| 1 | B0[95:64] | - | MAC[95:64] |
| 2 | B0[63:32] | - | MAC[63:32] |
| 3 | B0[31:0] | - | MAC[31:0] |
| 4 | CTR0[127:96] | CTR[127:96] | - |
| 5 | CTR0[95:64] | CTR[95:64] | - |
| 6 | CTR0[63:32] | CTR[63:32] | - |
| 7 | CTR0[31:0] | CTR[31:0] | - |
| 8 | - | E(CTR0)[127:96] | Decrypted Received MAC[127:96] |
| 9 | - | E(CTR0)[95:64] | Decrypted Received MAC[95:64] |
| 10 | - | E(CTR0)[63:32] | Decrypted Received MAC[63:32] |
| 11 | - | E(CTR0)[31:0] ¹ | Decrypted Received MAC[31:0] |
| 12 | - | AAD size; see Table 43-10 | - |
| 13 | - | MAC size; see Table 43-11 | - |

Table 43-10. Format of Context Word 12 for AES-CCM and AES-CCM* mode

| Bit 31 | Bits 30-16 | Bits 15-0 |
|-------------------|------------|-----------|
| AAD Presence Flag | 0 | AAD Size |

Table 43-11. Format of Context Word 13 for AES-CCM and AES-CCM* mode

| Bits 31-3 | Bits 2-0 |
|-----------|------------------|
| 0 | Encoded MAC Size |

43.3.8.5 AES CCM and CCM* mode use of the Data Size Register

The AES CCM and CCM* mode uses the Data Size Register as follows:

- The byte-length of the message to be processed must be written to the Data Size register.
- CCM and CCM* decrements the value in this register with every processed block.
- The content of the Data Size register must be divisible by 16 if the AS mode field is set to either "Update" or "Initialize". Otherwise, the data-size error is generated. In other words, message splitting can be done only on a 16-byte boundary.

43.3.8.6 AES CCM and CCM* mode use of the Key Register

CCM and CCM* key must be written to this register; it is always an encryption key.

43.3.8.7 AES CCM and CCM* mode use of the Key Size Register

The AES CCM and CCM* mode uses the Key Size Register as follows:

- The total number of key bytes must be written to the Key Size register.
- 16 bytes is the only key size supported for this mode.

43.3.8.8 AES CCM and CCM* mode use of the ICV check

The AES CCM and CCM* mode uses ICV checking as follows:

- Automatic ICV checking is enabled by setting the ICV bit of the Mode Register to 1. When ICV is set to 1, the AS mode field must be set to either "Finalize" or

"Initialize/Finalize"-otherwise the illegal-mode error is generated, unless data size is 0 indicating ICV check is only requested. Also, if ICV = 1, the ENC bit must be 0.

- The received ICV(MAC) must be provided on the input data FIFO after the message data. In CCM and CCM*, received ICV(MAC) is always encrypted. The FIFO data type must be set to ICV when it is put on the FIFO. The size of the received and computed ICV(MAC) is for CCM and CCM* encoded in the B0.
- If the ICV check detects mismatch between the decrypted received ICV(MAC) and the computed ICV(MAC), the ICV error is generated.

43.4 LTC Register Descriptions

All reads of undefined and write-only addresses always return zero. Writes to undefined and read-only addresses are ignored. LTC will never generate a transfer error on the register bus. Although many of the LTC registers hold more than 32 bits, the register addresses shown in the Memory Map below represent how these registers are accessed over the register bus as 32-bit words.

NOTE

The reset value of some registers differs between different versions of LTC. To ensure driver compatibility across different versions of LTC, when updating fields within registers, the registers should first be read, the required fields updated, and then the register should be written. This will avoid inadvertently changing the settings of other fields in the same register.

43.4.1 LTC Memory Map

| Offset | Register | Width (In bits) | Access | Reset value |
|--------|---|--------------------|--------|-------------|
| 0h | LTC Mode (LTC0_MD) | 32 | RW | 00000000h |
| 8h | LTC Key Size (LTC0_KS) | 32 | WO | 00000010h |
| 10h | LTC Data Size (LTC0_DS) | 32 | RW | 00000000h |
| 18h | LTC ICV Size (LTC0_ICVS) | 32 | RW | 00000000h |
| 30h | LTC Command (LTC0_COM) | 32 | WO | 00000000h |
| 34h | LTC Control (LTC0_CTL) | 32 | RW | 00000000h |
| 40h | LTC Clear Written (LTC0_CW) | 32 | WO | 00000000h |

Table continues on the next page...

LTC Register Descriptions

| Offset | Register | Width (In bits) | Access | Reset value |
|-------------|--|--------------------|--------|-------------|
| 48h | LTC Status (LTC0_STA) | 32 | W1C | 00000000h |
| 4Ch | LTC Error Status (LTC0_ESTA) | 32 | RO | 00000000h |
| 58h | LTC AAD Size (LTC0_AADSZ) | 32 | RW | 00000000h |
| 100h - 134h | LTC Context (LTC0_CTX_0 - LTC0_CTX_13) | 32 | RW | 00000000h |
| 200h - 20Ch | LTC Keys (LTC0_KEY_0 - LTC0_KEY_3) | 32 | RW | 00000000h |
| 4F0h | LTC Version ID (LTC0_VID1) | 32 | RO | 00340100h |
| 4F4h | LTC Version ID 2 (LTC0_VID2) | 32 | RO | 00000101h |
| 4F8h | LTC CHA Version ID (LTC0_CHAVID) | 32 | RO | 00000050h |
| 7C0h | LTC FIFO Status (LTC0_FIFOSTA) | 32 | RO | 00000000h |
| 7E0h | LTC Input Data FIFO (LTC0_IFIFO) | 32 | WO | 00000000h |
| 7F0h | LTC Output Data FIFO (LTC0_OFIFO) | 32 | RO | 00000000h |

43.4.2 LTC Mode (LTC0_MD)

43.4.2.1 Address

| Register | Offset |
|----------|--------|
| LTC0_MD | 0h |

43.4.2.2 Function

The Mode Register is used to tell the cryptographic engines which operation is being requested. The interpretation of this register will be unique for each CHA.

This section defines the format of the Mode Register when used with non-public-key algorithms and non-RNG operations.

43.4.2.3 Diagram

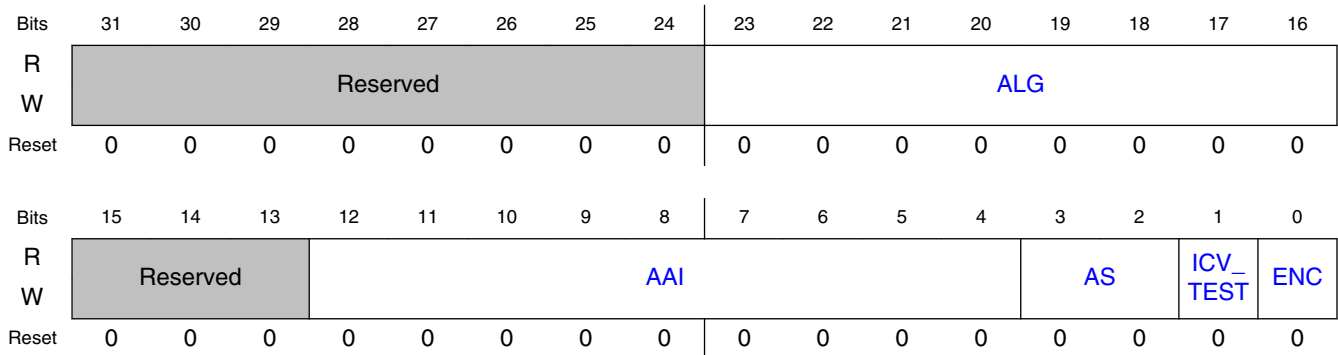

43.4.2.4 Fields

| Field | Function | | | | | | | | | | | | | | | | | | | | | | | | | | | | | | | | | | | | | | | | |
|---|--|---|----------------|--|--|-------------------|----------------|------|----------------|-----|-----------------------------|-----|-----------|-----|-----|-----|----------|-----|-----|-----|----------|-----|----------|-----|----------|-----|----------|-----|----------|-----|----------|-----|----------|-----|------|-----|----------|-----|----------|--|--|
| 31-24 — | Reserved. Must be 0. | | | | | | | | | | | | | | | | | | | | | | | | | | | | | | | | | | | | | | | | |
| 23-16 ALG | Algorithm. This field specifies which algorithm is being selected. 00010000b - AES | | | | | | | | | | | | | | | | | | | | | | | | | | | | | | | | | | | | | | | | |
| 15-13 — | Reserved. Must be 0. | | | | | | | | | | | | | | | | | | | | | | | | | | | | | | | | | | | | | | | | |
| 12-4 AAI | <p>Additional Algorithm information. This field contains additional mode information that is associated with the algorithm that is being executed. See also the section describing the appropriate CHA.</p> <p>NOTE: Some algorithms do not require additional algorithm information and in those cases this field should be all 0s.</p> <p>Table 43-12. AAI Interpretation for AES Modes</p> <table border="1"> <thead> <tr> <th colspan="4">[For AES the MSB of AAI is the DK (Decrypt Key) bit.]</th> </tr> <tr> <th>Code¹</th> <th>Interpretation</th> <th>Code</th> <th>Interpretation</th> </tr> </thead> <tbody> <tr> <td>00h</td> <td>CTR (mod 2¹²⁸)</td> <td>80h</td> <td>CCM, CCM*</td> </tr> <tr> <td>10h</td> <td>CBC</td> <td>90h</td> <td>Reserved</td> </tr> <tr> <td>20h</td> <td>ECB</td> <td>A0h</td> <td>Reserved</td> </tr> <tr> <td>30h</td> <td>Reserved</td> <td>B0h</td> <td>Reserved</td> </tr> <tr> <td>40h</td> <td>Reserved</td> <td>C0h</td> <td>Reserved</td> </tr> <tr> <td>50h</td> <td>Reserved</td> <td>D0h</td> <td>Reserved</td> </tr> <tr> <td>60h</td> <td>CMAC</td> <td>E0h</td> <td>Reserved</td> </tr> <tr> <td>70h</td> <td>XCBC-MAC</td> <td></td> <td></td> </tr> </tbody> </table> <p>Setting the DK bit (i.e. ORing 100h with any AES code above) causes Key Register to be loaded with the AES Dcrypt key, rather than the AES Encrypt key.</p> | [For AES the MSB of AAI is the DK (Decrypt Key) bit.] | | | | Code ¹ | Interpretation | Code | Interpretation | 00h | CTR (mod 2 ¹²⁸) | 80h | CCM, CCM* | 10h | CBC | 90h | Reserved | 20h | ECB | A0h | Reserved | 30h | Reserved | B0h | Reserved | 40h | Reserved | C0h | Reserved | 50h | Reserved | D0h | Reserved | 60h | CMAC | E0h | Reserved | 70h | XCBC-MAC | | |
| [For AES the MSB of AAI is the DK (Decrypt Key) bit.] | | | | | | | | | | | | | | | | | | | | | | | | | | | | | | | | | | | | | | | | | |
| Code ¹ | Interpretation | Code | Interpretation | | | | | | | | | | | | | | | | | | | | | | | | | | | | | | | | | | | | | | |
| 00h | CTR (mod 2 ¹²⁸) | 80h | CCM, CCM* | | | | | | | | | | | | | | | | | | | | | | | | | | | | | | | | | | | | | | |
| 10h | CBC | 90h | Reserved | | | | | | | | | | | | | | | | | | | | | | | | | | | | | | | | | | | | | | |
| 20h | ECB | A0h | Reserved | | | | | | | | | | | | | | | | | | | | | | | | | | | | | | | | | | | | | | |
| 30h | Reserved | B0h | Reserved | | | | | | | | | | | | | | | | | | | | | | | | | | | | | | | | | | | | | | |
| 40h | Reserved | C0h | Reserved | | | | | | | | | | | | | | | | | | | | | | | | | | | | | | | | | | | | | | |
| 50h | Reserved | D0h | Reserved | | | | | | | | | | | | | | | | | | | | | | | | | | | | | | | | | | | | | | |
| 60h | CMAC | E0h | Reserved | | | | | | | | | | | | | | | | | | | | | | | | | | | | | | | | | | | | | | |
| 70h | XCBC-MAC | | | | | | | | | | | | | | | | | | | | | | | | | | | | | | | | | | | | | | | | |

Table continues on the next page...

LTC Register Descriptions

| Field | Function |
|---------------|---|
| | 1. The codes are mutually exclusive (i.e. they cannot be ORed with each other). |
| 3-2 AS | Algorithm State. This field defines the state of the algorithm that is being executed. This may not be used by every algorithm. 00b - Update 01b - Initialize 10b - Finalize 11b - Initialize/Finalize |
| 1 ICV_TEST | ICV Checking / Test AES fault detection. For algorithms other than AES ECB mode: ICV Checking This bit selects whether the current algorithm should compare the known ICV versus the calculated ICV. This bit will be ignored by algorithms that do not support ICV checking. 0 - Don't compare 1 - Compare For AES ECB mode: Test AES fault detection In AES ECB mode, this bit activates fault detection testing by injecting bit level errors into AES core logic as defined in the first 128 bits of the context. 0 - Don't inject bit errors 1 - Inject bit errors |
| 0 ENC | Encrypt/Decrypt. This bit selects encryption or decryption. 0b - Decrypt. 1b - Encrypt. |

1. The codes are mutually exclusive (i.e. they cannot be ORed with each other).

43.4.3 LTC Key Size (LTC0_KS)

43.4.3.1 Address

| Register | Offset |
|----------|--------|
| LTC0_KS | 8h |

43.4.3.2 Function

The Key Size Register is used to tell the crypto engine(AES) the size of the key that was loaded into the Key Register. The Key Size Register must be written after the key is written into the Key Register. Writing to the Key Size Register will prevent the user from

modifying the Key Register. Only 16 byte keys are supported so this register will always read 16 bytes. This register is still required to be written to indicate to the AES engine that the key was loaded.

43.4.3.3 Diagram

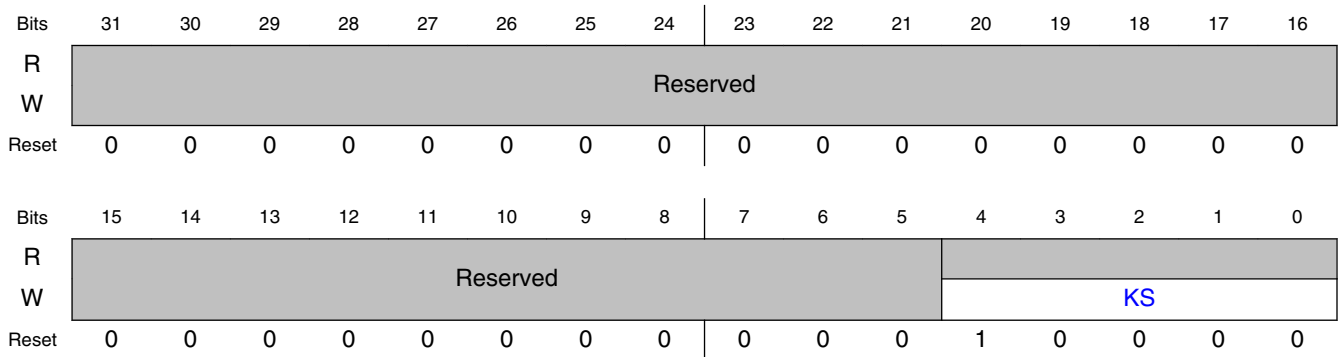

43.4.3.4 Fields

| Field | Function |
|-----------|---|
| 31-5 — | Reserved. |
| 4-0 KS | Key Size. This is the size of a Key measured in bytes |

43.4.4 LTC Data Size (LTC0_DS)

43.4.4.1 Address

| Register | Offset |
|----------|--------|
| LTC0_DS | 10h |

43.4.4.2 Function

The Data Size Register is used to tell the AES the amount of data that will be loaded into the Input Data FIFO. This register should only be written to once during a single operation. Note that writing to the [LTC AAD Size \(LTC0_AADSZ\)](#), will cause this register to also update. The Data Size Register is additive and each write to the register will be added to the current value in the register. That is, if the DS field currently has the value 16, writing 2 to the least-significant half of the Data Size register (i.e. the DS field) will result in a value of 18 in the DS field. Note that AES decrements this register, so reading the register may return a value less than sum of the values that were written into it. This register is cleared whenever a key is decrypted or encrypted.

43.4.4.3 Diagram

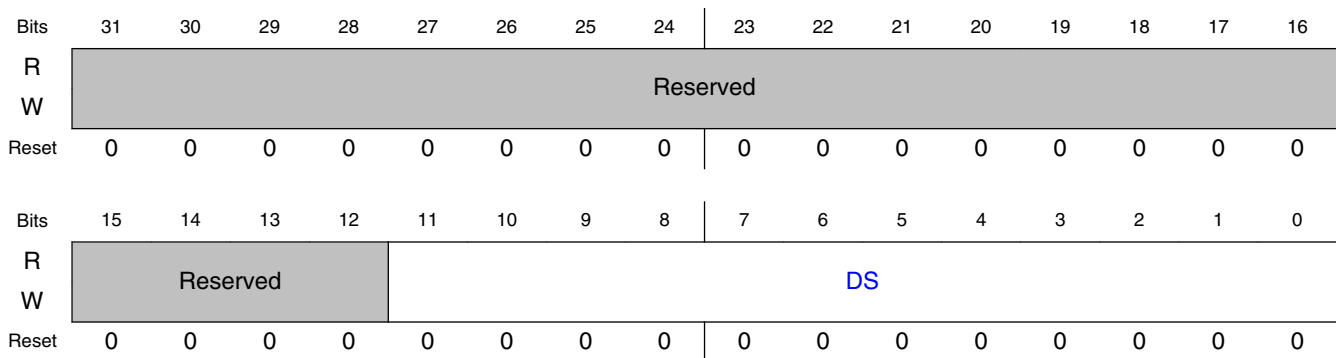

43.4.4.4 Fields

| Field | Function |
|------------|--|
| 31-12 — | Reserved. |
| 11-0 DS | Data Size. This is the number of whole bytes of data that will be consumed by the CHA. Note that writing the AAD Size Register will result in this register also being written to. |

43.4.5 LTC ICV Size (LTC0_ICVS)

43.4.5.1 Address

| Register | Offset |
|-----------|--------|
| LTC0_ICVS | 18h |

43.4.5.2 Function

The ICV Size Register indicates how much of the last block of ICV is valid when performing AES integrity check modes (e.g. AES-CMAC, AES-XCBC-MAC). This register must be written prior to the corresponding word of data being consumed by AES. In practical terms, this means the register must be written prior to the corresponding data being written to the Input Data FIFO.

43.4.5.3 Diagram

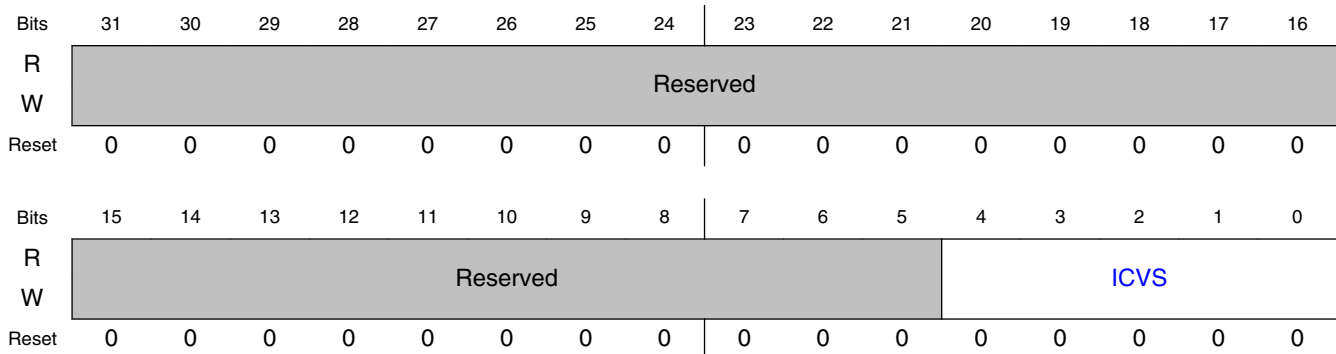

43.4.5.4 Fields

| Field | Function |
|-------------|---------------------|
| 31-5 — | Reserved. |
| 4-0 ICVS | ICV Size, in Bytes. |

43.4.6 LTC Command (LTC0_COM)

43.4.6.1 Address

| Register | Offset |
|----------|--------|
| LTC0_COM | 30h |

43.4.6.2 Function

The LTC Command Register is used to send control signals to the Crypto Engines.

43.4.6.3 Diagram

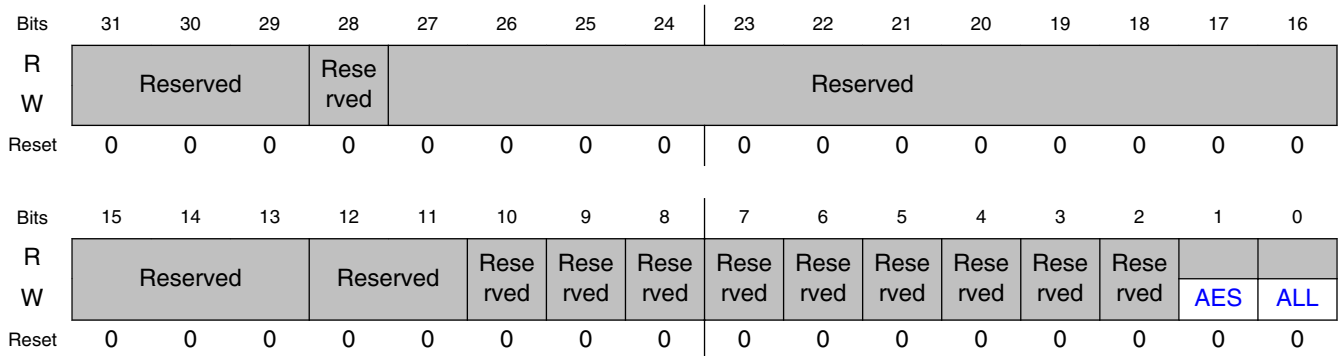

43.4.6.4 Fields

| Field | Function |
|------------|--|
| 31-29 — | Reserved. To preserve software compatibility with other versions of LTC, 0 should be written to all reserved bits. |
| 28 — | Reserved. |
| 27-13 — | Reserved. |
| 12-11 — | Reserved |
| 10 | Reserved |

Table continues on the next page...

| Field | Function |
|----------|---|
| — | |
| 9 — | Reserved |
| 8 — | Reserved |
| 7 — | Reserved |
| 6 — | Reserved |
| 5 — | Reserved |
| 4 — | Reserved |
| 3 — | Reserved. |
| 2 — | Reserved |
| 1 AES | Reset AESA. Writing a 1 to this bit resets the AES Accelerator core engine. 0b - Do Not Reset 1b - Reset AES Accelerator |
| 0 ALL | Reset All Internal Logic. Writing to this bit will reset all accelerator engines and as well as all the internal registers. 0b - Do Not Reset 1b - Reset all CHAs in use by this CCB. |

43.4.7 LTC Control (LTC0_CTL)

43.4.7.1 Address

| Register | Offset |
|----------|--------|
| LTC0_CTL | 34h |

43.4.7.2 Function

This register is used for some of the internal controls of the LTC block.

43.4.7.3 Diagram

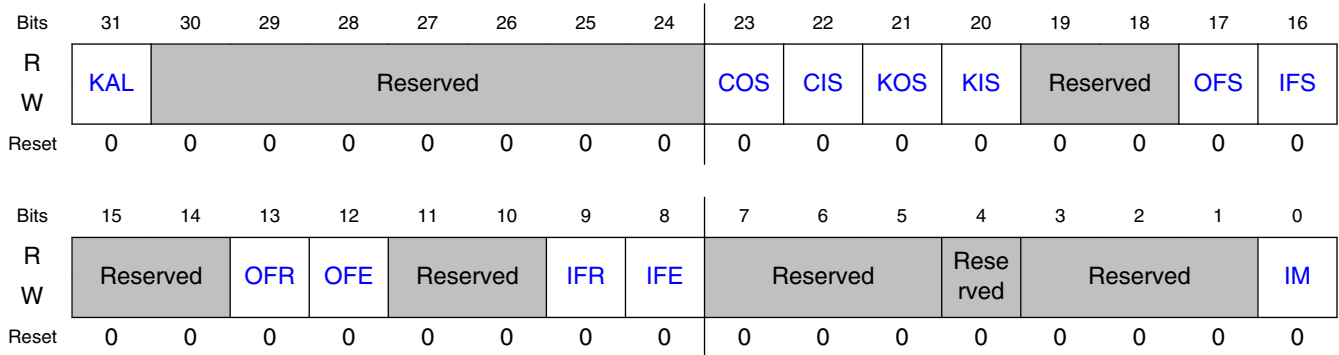

43.4.7.4 Fields

| Field | Function |
|------------|--|
| 31 KAL | Key Register Access Lock. Read access to the key register is blocked. Any reads of the key register will only return zero. Once this bit is set, it can only be cleared by hard reset. 0b - Key Register is readable. 1b - Key Register is not readable. |
| 30-24 — | Reserved. |
| 23 COS | Context Register Output Byte Swap. Byte swap all data that is read from the context register. Data is byte swapped only within a single word. 0b - Do Not Byte Swap Data. 1b - Byte Swap Data. |
| 22 CIS | Context Register Input Byte Swap. Byte swap all data that is written to the context register. Data is byte swapped only within a single word. 0b - Do Not Byte Swap Data. 1b - Byte Swap Data. |
| 21 KOS | Key Register Output Byte Swap. Byte swap all data that is read from the key register. Data is byte swapped only within a single word. 0b - Do Not Byte Swap Data. 1b - Byte Swap Data. |
| 20 KIS | Key Register Input Byte Swap. Byte swap all data that is written to the key register. Data is byte swapped only within a single word. 0b - Do Not Byte Swap Data. 1b - Byte Swap Data. |
| 19-18 — | Reserved. |
| 17 OFS | Output FIFO Byte Swap. Byte swap all data that is read from the Onput FIFO. 0b - Do Not Byte Swap Data. |

Table continues on the next page...

| Field | Function |
|------------|---|
| | 1b - Byte Swap Data. |
| 16 IFS | Input FIFO Byte Swap. Byte swap all data that is written to the Input FIFO. 0b - Do Not Byte Swap Data. 1b - Byte Swap Data. |
| 15-14 — | Reserved. |
| 13 OFR | Output FIFO DMA Request Size. The DMA request logic will only request data if the OUTPUT FIFO has enough data to satisfy the request. 0b - DMA request size is 1 entry. 1b - DMA request size is 4 entries. |
| 12 OFE | Output FIFO DMA Enable. 0b - DMA Request and Done signals disabled for the Output FIFO. 1b - DMA Request and Done signals enabled for the Output FIFO. |
| 11-10 — | Reserved. |
| 9 IFR | Input FIFO DMA Request Size. The DMA request logic will only request data if the INPUT FIFO has enough space for the request size. 0b - DMA request size is 1 entry. 1b - DMA request size is 4 entries. |
| 8 IFE | Input FIFO DMA Enable. 0b - DMA Request and Done signals disabled for the Input FIFO. 1b - DMA Request and Done signals enabled for the Input FIFO. |
| 7-5 — | Reserved. |
| 4 — | Reserved. |
| 3-1 — | Reserved. |
| 0 IM | Interrupt Mask. Once this bit is set, it can only be cleared by hard reset. 0b - Interrupt not masked. 1b - Interrupt masked |

43.4.8 LTC Clear Written (LTC0_CW)

43.4.8.1 Address

| Register | Offset |
|----------|--------|
| LTC0_CW | 40h |

43.4.8.2 Function

The Clear Written Register is used to clear many of the internal registers. All fields of this register are self-clearing.

43.4.8.3 Diagram

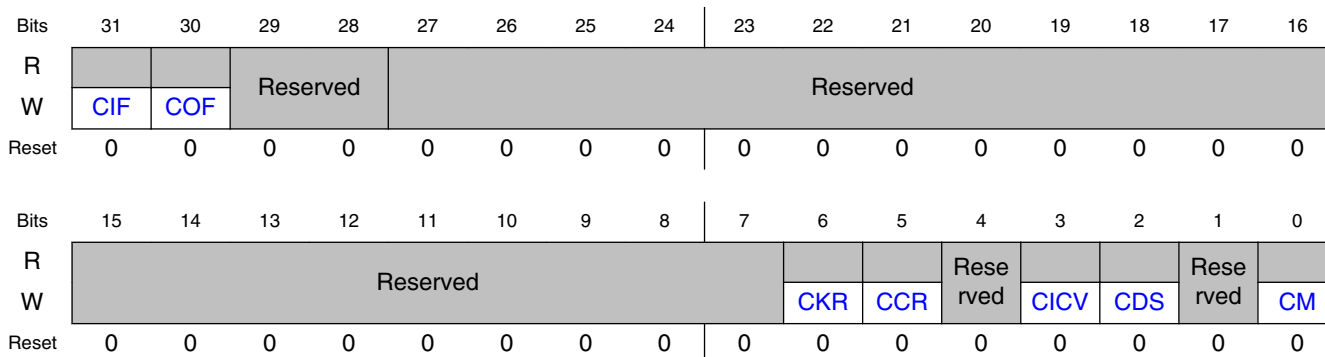

43.4.8.4 Fields

| Field | Function |
|------------|--|
| 31 CIF | Clear Input FIFO. Writing a 1 to this bit causes the Input Data FIFO. |
| 30 COF | Clear Output FIFO. Writing a 1 to this bit causes the Output FIFO to be cleared. |
| 29-28 — | Reserved. |
| 27-16 — | Reserved. |
| 15-7 — | Reserved. |
| 6 CKR | Clear the Key Register. Writing a one to this bit causes the Key and Key Size Registers to be cleared. |
| 5 CCR | Clear the Context Register. Writing a one to this bit causes the Context Register to be cleared. |
| 4 — | Reserved. |
| 3 | Clear the ICV Size Register. Writing a one to this bit causes the ICV Size Register to be cleared. |

Table continues on the next page...

| Field | Function |
|----------|--|
| CICV | |
| 2 CDS | Clear the Data Size Register. Writing a one to this bit causes the Data Size Register to be cleared. This clears AAD Size as well. |
| 1 — | Reserved. |
| 0 CM | Clear the Mode Register. Writing a one to this bit causes the Mode Register to be cleared. |

43.4.9 LTC Status (LTC0_STA)

43.4.9.1 Address

| Register | Offset |
|----------|--------|
| LTC0_STA | 48h |

43.4.9.2 Function

The LTC Status Register shows the status of the internal Crypto engine and its internal registers.

43.4.9.3 Diagram

| | | | | | | | | | | | | | | | | | |
|-------|----------|----------|----|----------|----------|----------|----------|----------|----------|----------|----------|----------|----------|----------|----------|-----|----------|
| Bits | 31 | 30 | 29 | 28 | 27 | 26 | 25 | 24 | 23 | 22 | 21 | 20 | 19 | 18 | 17 | 16 | |
| R | Reserved | Reserved | | | Reserved | | | Reserved | Reserved | | | EI | Reserved | | | DI | |
| W | Reserved | Reserved | | | Reserved | | | Reserved | Reserved | | | | Reserved | | | w1c | |
| Reset | 0 | 0 | 0 | 0 | 0 | 0 | 0 | 0 | 0 | 0 | 0 | 0 | 0 | 0 | 0 | 0 | |
| Bits | 15 | 14 | 13 | 12 | 11 | 10 | 9 | 8 | 7 | 6 | 5 | 4 | 3 | 2 | 1 | 0 | |
| R | Reserved | | | Reserved | Reserved | Reserved | Reserved | Reserved | Reserved | Reserved | Reserved | Reserved | Reserved | Reserved | Reserved | AB | Reserved |
| W | Reserved | | | Reserved | Reserved | Reserved | Reserved | Reserved | Reserved | Reserved | Reserved | Reserved | Reserved | Reserved | Reserved | | Reserved |
| Reset | 0 | 0 | 0 | 0 | 0 | 0 | 0 | 0 | 0 | 0 | 0 | 0 | 0 | 0 | 0 | 0 | 0 |

43.4.9.4 Fields

| Field | Function | |
|------------|--|--------------------------|
| 31 — | Reserved. | |
| 30-28 — | Reserved. | |
| 27-25 — | Reserved. | |
| 24 — | Reserved. | |
| 23-21 — | Reserved. | |
| 20 EI | Error Interrupt. The Error Interrupt has been asserted. This error can only be cleared by resetting LTC. 0b - Not Error. 1b - Error Interrupt. | |
| 19-17 — | Reserved. | |
| 16 DI | Done Interrupt. The Done Interrupt has been asserted. | |
| | Value | Read |
| | 0 | No Done Interrupt |
| | 1 | Done Interrupt asserted |
| | | Write |
| | | No change |
| | | Clear the Done Interrupt |
| 15-13 — | Reserved. | |
| 12-11 — | Reserved | |
| 10 — | Reserved | |
| 9 — | Reserved | |
| 8 — | Reserved | |
| 7 — | Reserved | |
| 6 — | Reserved | |
| 5 | Reserved | |

Table continues on the next page...

| Field | Function |
|---------|---|
| — | |
| 4 — | Reserved |
| 3 — | Reserved. |
| 2 — | Reserved |
| 1 AB | AESA Busy. This bit indicates that the AES Accelerator is busy. The CHA can either be busy processing data or resetting. 0b - AESA Idle 1b - AESA Busy. |
| 0 — | Reserved. |

43.4.10 LTC Error Status (LTC0_ESTA)

43.4.10.1 Address

| Register | Offset |
|-----------|--------|
| LTC0_ESTA | 4Ch |

43.4.10.2 Function

The LTC Error Register shows the status of the internal Crypto Engine and its internal registers.

43.4.10.3 Diagram

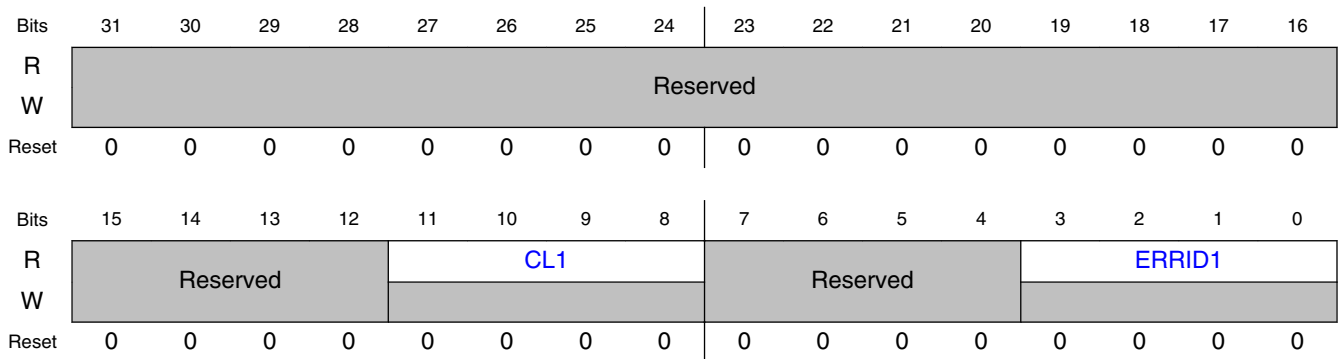

43.4.10.4 Fields

| Field | Function |
|---------------|--|
| 31-12 — | Reserved. |
| 11-8 CL1 | algorithms. The algorithms field indicates which algorithm is asserting an error. Others reserved 0000b - LTC General Error 0001b - AES |
| 7-4 — | Reserved |
| 3-0 ERRID1 | Error ID 1. These bits indicate the type of error that was found while processing the Descriptor. The Algorithm that is associated with the error can be found in the CL1 field. Others reserved. 0001b - Mode Error 0010b - Data Size Error 0011b - Key Size Error 0110b - Data Arrived out of Sequence Error 1010b - ICV Check Failed 1011b - Internal Hardware Failure 1100b - CCM AAD Size Error (either 1. AAD flag in B0 =1 and no AAD type provided, 2. AAD flag in B0 = 0 and AAD provided, or 3. AAD flag in B0 =1 and not enough AAD provided - expecting more based on AAD size.) 1111b - Invalid Crypto Engine Selected |

43.4.11 LTC AAD Size (LTC0_AADSZ)

43.4.11.1 Address

| Register | Offset |
|------------|--------|
| LTC0_AADSZ | 58h |

43.4.11.2 Function

The AAD Size Register is used by AESA to determine how much of the last block of AAD is valid. The write to this register should be the entire size of the AAD as it is also added directly to the Data Size Register. The size added to the Data Size Register is the AAD size rounded up to the next 16 byte boundary. For instance a size of 20 bytes written to the AAD size register will cause 32 bytes to be added to the Data Size Register. The size stored in the AADSZ field represents the number of bytes valid in the final block of AAD. However the entire size of AAD should be written to the [LTC AAD Size \(LTC0_AADSZ\)](#) Register address location. When authentication only is being done then the AL bit needs to be written to tell the AES engine that this is the last of the data.

43.4.11.3 Diagram

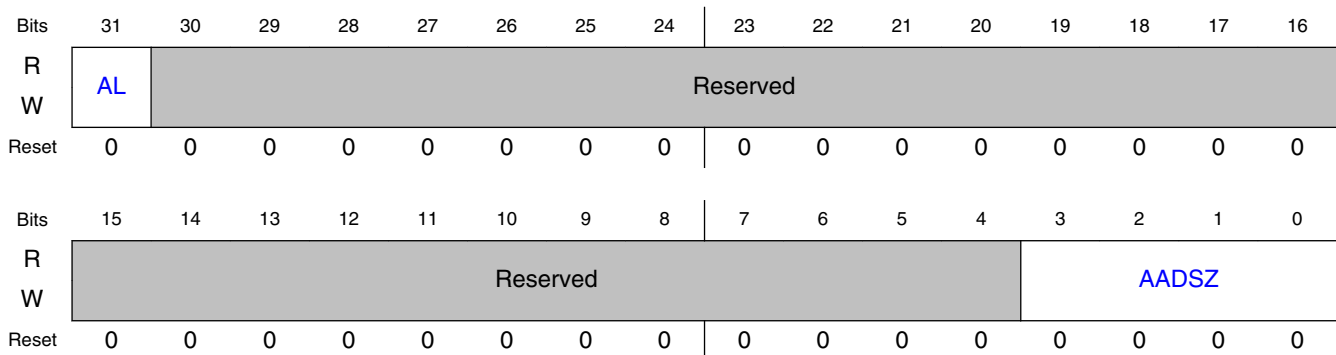

43.4.11.4 Fields

| Field | Function |
|-----------|--|
| 31 AL | AAD Last. Only AAD data will be written into the Input FIFO. |
| 30-4 — | Reserved. |

Table continues on the next page...

LTC Register Descriptions

| Field | Function |
|--------------|----------------------------|
| 3-0 AADSZ | AAD size in Bytes, mod 16. |

43.4.12 LTC Context (LTC0_CTX_a)

43.4.12.1 Address

For a = 0 to 13:

| Register | Offset |
|------------|-----------------|
| LTC0_CTX_a | 100h + (a × 4h) |

43.4.12.2 Function

The Context Register holds the context for the internal crypto engine. This register is 448 bits in length. The IP bus write to the Context Register is accessible only as full-word reads or writes to fourteen 32-bit registers. The MSB is located at offset 0100h with respect to the register page.

The bit assignments of this register are dependent on the algorithm, and in some cases the mode of that algorithm. See the appropriate section for the Context Register format used for that algorithm:

- AES ECB: Section [AES ECB mode use of the Context Register](#)
- AES CBC: Section [AES CBC mode use of the Context Register](#)
- AES CTR: Section [AES CTR mode use of the Context Register](#)
- AES CCM: Section [AES CCM mode use of the Context Register](#)

43.4.12.3 Diagram

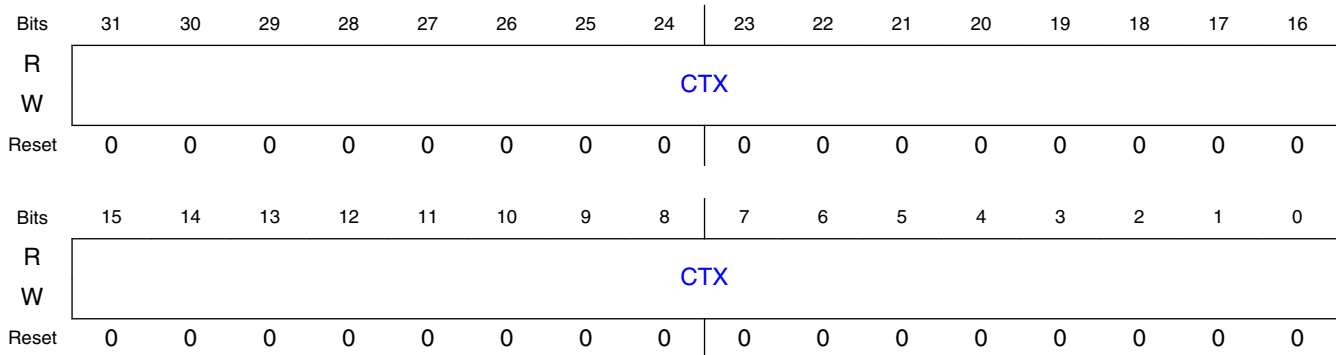

43.4.12.4 Fields

| Field | Function |
|-------|----------|
| 31-0 | CTX |
| CTX | |

43.4.13 LTC Keys (LTC0_KEY_a)

43.4.13.1 Address

| Register | Offset |
|------------|--------|
| LTC0_KEY_0 | 200h |
| LTC0_KEY_1 | 204h |
| LTC0_KEY_2 | 208h |
| LTC0_KEY_3 | 20Ch |

43.4.13.2 Function

The Key Register normally holds the left-aligned key for the internal crypto engine. The MSB is in offset 200h. The Key Register is 128 bits in length. The IP bus write to the Context Register is accessible only as full-word reads or writes to four 32-bit registers.

LTC Register Descriptions

Before the value in the Key Register can be used in a cryptographic operation, the size of the key must be written into the Key Size Register. Once the Key Size Register has been written, the Key Register cannot be written again until the Key Size Register has been cleared.

43.4.13.3 Diagram

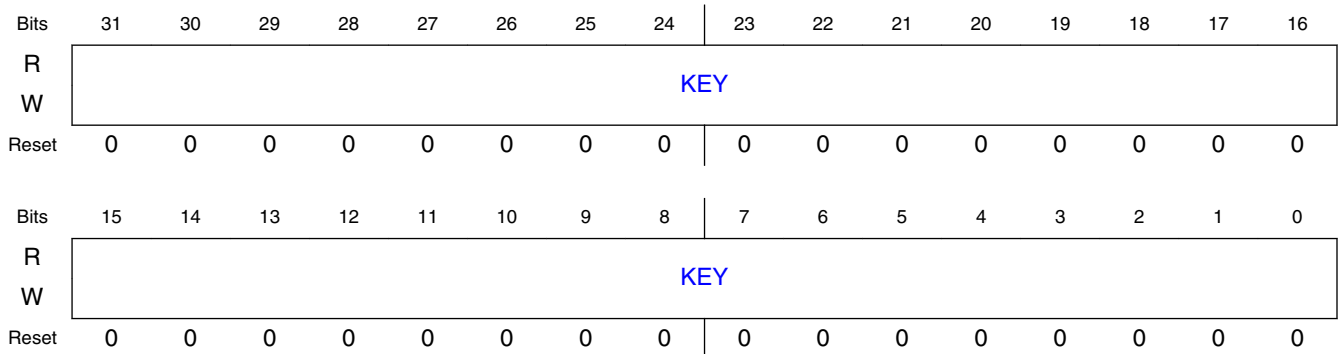

43.4.13.4 Fields

| Field | Function |
|-------|----------|
| 31-0 | KEY |
| KEY | |

43.4.14 LTC Version ID (LTC0_VID1)

43.4.14.1 Address

| Register | Offset |
|-----------|--------|
| LTC0_VID1 | 4F0h |

43.4.14.2 Function

This register contains the ID for LTC and major and minor revision numbers.

43.4.14.3 Diagram

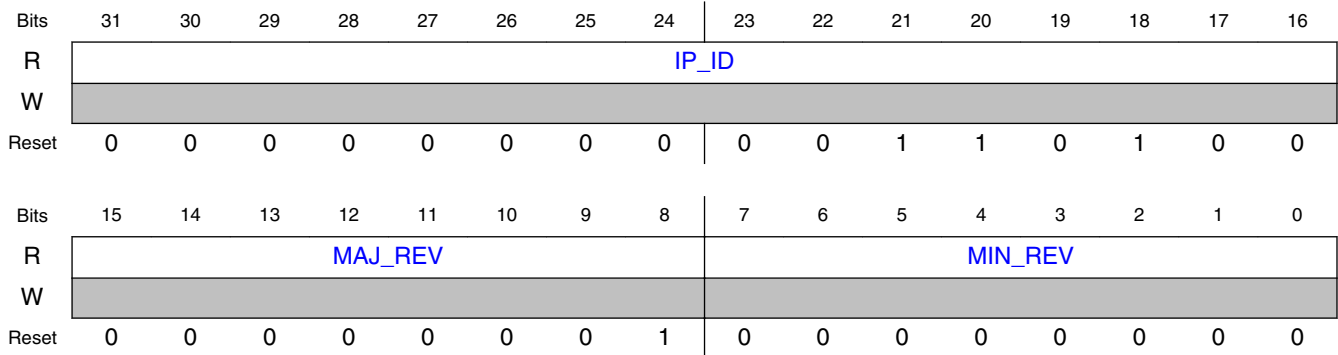

43.4.14.4 Fields

| Field | Function |
|-----------------|------------------------|
| 31-16 IP_ID | ID(0x0034). |
| 15-8 MAJ_REV | Major revision number. |
| 7-0 MIN_REV | Minor revision number. |

43.4.15 LTC Version ID 2 (LTC0_VID2)

43.4.15.1 Address

| Register | Offset |
|-----------|--------|
| LTC0_VID2 | 4F4h |

43.4.15.2 Function

This register contains the architectural era and eco revision numbers.

43.4.15.3 Diagram

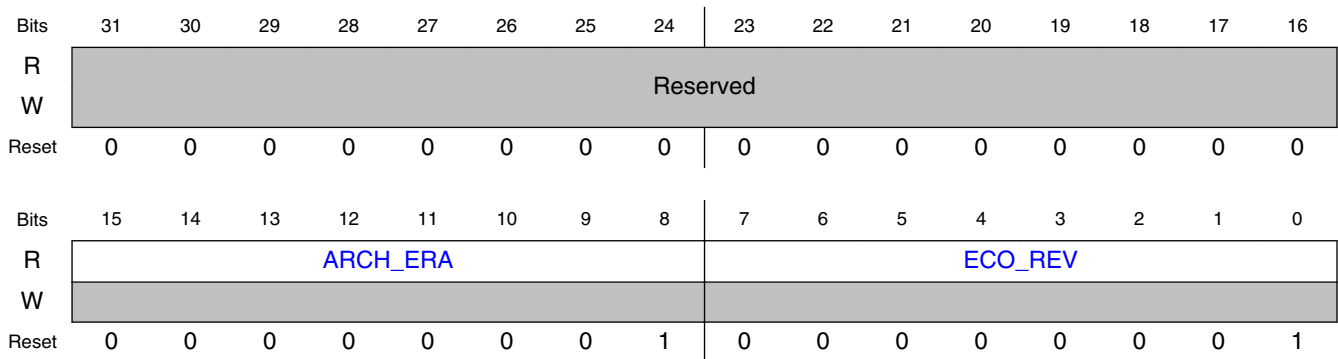

43.4.15.4 Fields

| Field | Function |
|------------------|----------------------|
| 31-16 — | Reserved |
| 15-8 ARCH_ERA | Architectural ERA. |
| 7-0 ECO_REV | ECO revision number. |

43.4.16 LTC CHA Version ID (LTC0_CHAVID)

43.4.16.1 Address

| Register | Offset |
|-------------|--------|
| LTC0_CHAVID | 4F8h |

43.4.16.2 Function

This register contains the Version ID and Revision Number for the CHAs contained within LTC.

43.4.16.3 Diagram

| | | | | | | | | | | | | | | | | |
|-------|----------|----|----|----|----|----|----|----|----------|----|----|----|----------|----|----|----|
| Bits | 31 | 30 | 29 | 28 | 27 | 26 | 25 | 24 | 23 | 22 | 21 | 20 | 19 | 18 | 17 | 16 |
| R | Reserved | | | | | | | | Reserved | | | | | | | |
| W | Reserved | | | | | | | | Reserved | | | | | | | |
| Reset | 0 | 0 | 0 | 0 | 0 | 0 | 0 | 0 | 0 | 0 | 0 | 0 | 0 | 0 | 0 | 0 |
| Bits | 15 | 14 | 13 | 12 | 11 | 10 | 9 | 8 | 7 | 6 | 5 | 4 | 3 | 2 | 1 | 0 |
| R | Reserved | | | | | | | | AESVID | | | | AESREV | | | |
| W | Reserved | | | | | | | | Reserved | | | | Reserved | | | |
| Reset | 0 | 0 | 0 | 0 | 0 | 0 | 0 | 0 | 0 | 1 | 0 | 1 | 0 | 0 | 0 | 0 |

43.4.16.4 Fields

| Field | Function |
|---------------|---------------------|
| 31-24 — | Reserved |
| 23-16 — | Reserved |
| 15-8 — | Reserved |
| 7-4 AESVID | AES Version ID |
| 3-0 AESREV | AES Revision Number |

43.4.17 LTC FIFO Status (LTC0_FIFOSTA)

43.4.17.1 Address

| Register | Offset |
|--------------|--------|
| LTC0_FIFOSTA | 7C0h |

43.4.17.2 Function

The LTC FIFO Status shows the current levels of the Input and Output FIFO.

43.4.17.3 Diagram

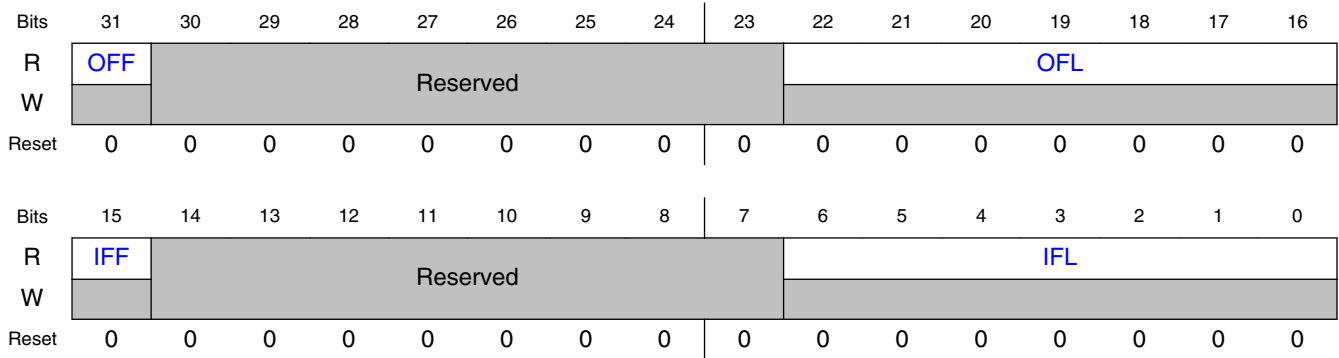

43.4.17.4 Fields

| Field | Function |
|--------------|--|
| 31 OFF | Output FIFO Full. The Output FIFO is full and should not be written to. |
| 30-23 — | Reserved |
| 22-16 OFL | Output FIFO Level. These bits indicate the current number of entries in the Output FIFO. |
| 15 IFF | Input FIFO Full. The Input FIFO is full and should not be written to. |
| 14-7 — | Reserved |
| 6-0 IFL | Input FIFO Level. These bits indicate the current number of entries in the Input FIFO. |

43.4.18 LTC Input Data FIFO (LTC0_IFIFO)

43.4.18.1 Address

| Register | Offset |
|------------|--------|
| LTC0_IFIFO | 7E0h |

43.4.18.2 Function

Data to be processed by the various crypto engines is first pushed into the Input Data FIFO. The Input Data FIFO supports byte enables, allowing one to four bytes to be written to the IFIFO from the IP bus. The IFIFO is four entries deep, and each entry is four bytes. Care must be used to not overflow the Input Data FIFO. Reads from this address will always return 0x0.

43.4.18.3 Diagram

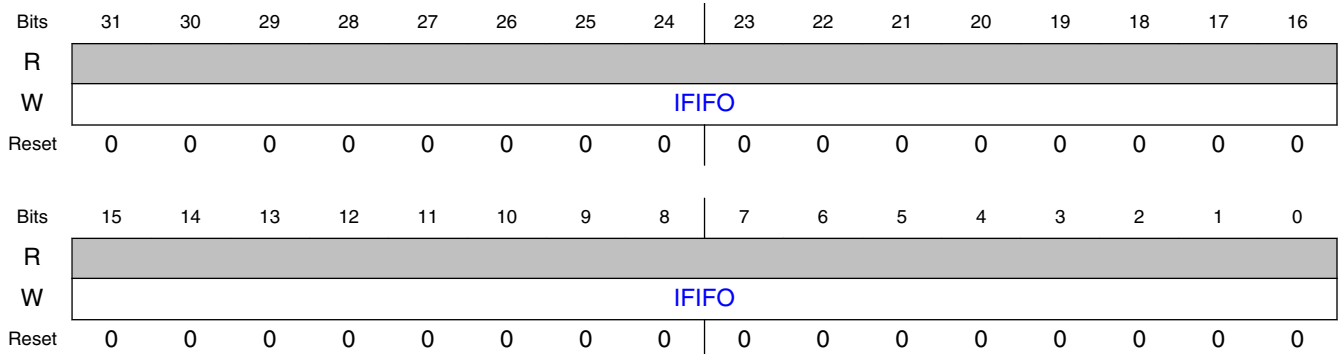

43.4.18.4 Fields

| Field | Function |
|-------|----------|
| 31-0 | IFIFO |
| IFIFO | |

43.4.19 LTC Output Data FIFO (LTC0_OFIFO)

43.4.19.1 Address

| Register | Offset |
|------------|--------|
| LTC0_OFIFO | 7F0h |

43.4.19.2 Function

Data that is output from the AES is pushed into the Output Data FIFO. The OFIFO is four entries deep, and each entry is four bytes. During normal operation, the AES will never overflow the Output Data FIFO. Writes to this register are ignored.

43.4.19.3 Diagram

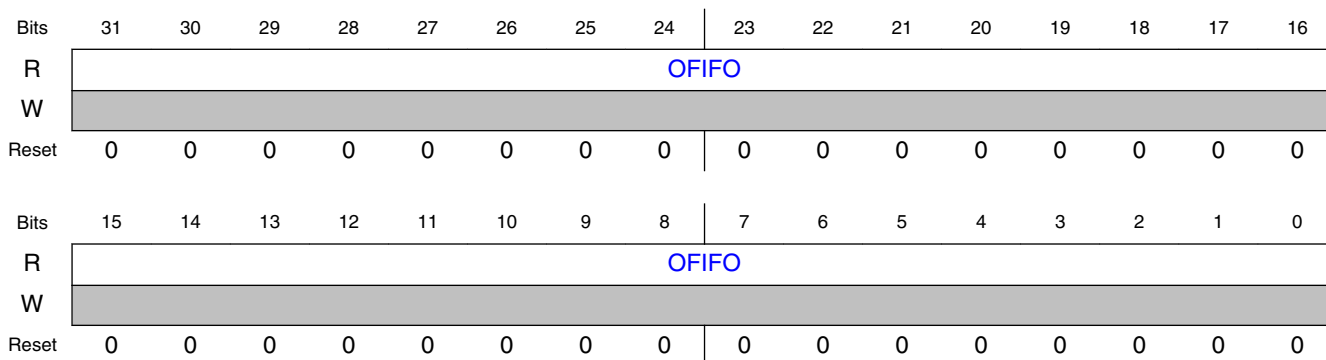

43.4.19.4 Fields

| Field | Function |
|---------------|-------------|
| 31-0 OFIFO | Output FIFO |

Chapter 44

True Random Number Generator (TRNG)

44.1 Standalone True Random Number Generator (SA-TRNG).

The Standalone True Random Number Generator (SA-TRNG) is a hardware accelerator module that generates a 512-bit entropy as needed by an entropy-consuming module or by other post-processing functions. A typical entropy consumer is a pseudo random-number generator (PRNG) that can be implemented to achieve both true randomness and cryptographic-strength random numbers using the TRNG output as its entropy seed. The PRNG is not part of this module.

The entropy generated by a TRNG is intended for direct use by functions that generate secret keys, per-message secrets, random challenges, and other similar quantities used in cryptographic algorithms. In each of these cases, it is important that a random number be difficult to guess or predict. It is important that a random number is at least as difficult to predict as it is difficult to break the cryptographic algorithm with which it is being used. This stringent requirement is particularly difficult to fulfill if the entropy source from a TRNG contains bias and/or correlation. To increase the trustworthiness/quality of the generated random data, PRNGs are often used to post process the output of a TRNG.

This document describes only the TRNG design functionality and usage.

Note that before entropy can be obtained from the TRNG, it must be initialized and instantiated in a particular mode by setting the appropriate TRNG registers.

The TRNG contains the following sub modules: IP Slave bus (SkyBlue bus) interface, the TRNG Core and the free running oscillator (OSC).

44.1.1 Standalone True Random Number Generator Block Diagram

The following figure is a top-level diagram of the True Random Number Generator.

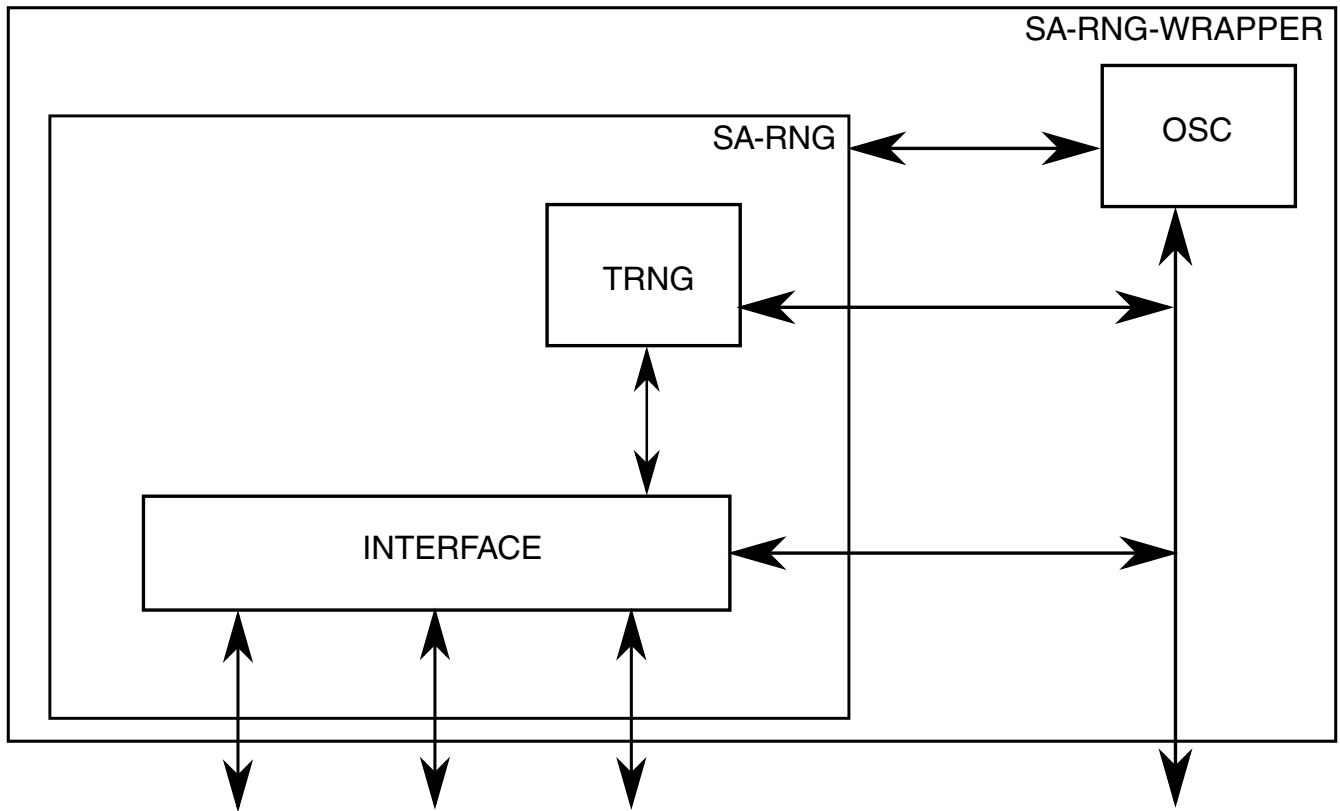

Figure 44-1. SA TRNG Block Diagram

44.1.2 TRNG Functional Description.

The TRNG consists of several functional sub-modules. Its overall functionality can be easily described from the top level in terms of generating entropy for seed generation. The functionality of each sub-module is briefly described in the following subsections.

TRNG is based on collecting bits from a random noise source. This random noise source is a ring oscillator that is sensitive to random noise (temperature variations, voltage variations, cross-talk and other random noise) within the device in which the TRNG is used. This noise causes various small changes in the period of the oscillator. Therefore, if the count of the ring oscillator clock cycles is sampled after a known period of time, this count will vary each time the sample is taken. By using the variance in this count over a large number of samples, random bits can be derived.

The TRNG comprises two entropy sources, each of which provides a single bit of output. Concatenated together, these 2 output bits are expected to provide 1 bit of entropy every 100 clock cycles. In addition to generating entropy, the TRNG also performs several statistical tests on its output.

44.1.3 SA-TRNG hardware functional description.

SA-TRNG functionality consists of several major subcomponents. This table describes these subcomponents.

Table 44-1. SA-TRNG subcomponents.

| Description | Cross-reference(s) |
|--|--|
| Interfaces | |
| Register interface <ul style="list-style-type: none"> Used for access to configuration, control, status and debugging registers | Register interface (IP Slave bus) |
| True Random Number Generator (TRNG) | Standalone True Random Number Generator (SA-TRNG). |

44.1.3.1 Software Use Cases for the Stand Alone TRNG.

There are four things that a user (programmer/integrator) will want to do with a TRNG.

- Initialization.

Set up the parameters to proper values, and start generation of the first block of entropy. This is done once.

- Read entropy from the TRNG, and start generation of the next block of entropy.

This is done many times and is the normal flow of operation.

- Run a self-test on the TRNG, to assure proper continued operation.

This involves taking TRNG off-line, setting some self-test parameters, running TRNG, and then reading the statistical test registers, to see that they are within proper operation values. This may not be needed, as TRNG has built-in self-test.

- Off-line determination and checking of TRNG parameter values.

This is done in development in order to determine the proper initialization and self-test parameters. The TRNG is taken off-line. Test parameter values are written and entropy generation is started. If the statistical tests indicate poor operation (i.e., failing statistical tests), the `entropy_delay` value should be increased and entropy generation should be re-started. Every case is a variation of setting TRNG parameter values, starting or re-starting entropy generation and reading out the entropy. This process requires pausing or stopping and re-starting the TRNG.

The TRNG is designed to operate as a slave module on the standard IP Slave Bus. By understanding the TRNG register descriptions in "TRNG Register Descriptions" section below, the TRNG module can be controlled via the IP slave bus. In order to write to most TRNG registers, the MCTL register must be initialized in programming mode as described in the "TRNG Register Descriptions" section. At Power On Reset (POR), the TRNG resets to programming mode. And the it will not generate entropy until it is out of programming mode (in run mode) and access to Entropy Registers have been enabled.

Here is an example program flow of using the TRNG.

- After POR the TRNG will be reset into programming mode with the OK to stop bit set ($MCTL[TSTOP_OK]=1$). The TRNG must be put into Run Mode for Entropy Generation to begin ($MCTL[PRGM]=0$). Additionally, in order to have access to the Entropy registers and other critical TRNG registers, the TRNG access bit must be set ($MCTL[TRNG_ACC]=1$). Using the default self test limits that exist after bootup, the entropy valid bit can be polled until asserted ($MCTL[ENT_VAL]=1$). Alternatively, if using the interrupt, and the interrupts are enabled via the INT_MASK register and the ipi_rng_int_b is asserted when $MCTL[ENT_VAL]=1$.
- After the polling completes, the 512-bit entropy generated by the TRNG can be read. The values can be read in any order from entropy register 0 to register 15 (ENT0 to ENT 15). After reading ENT 15, the old entropy value is reset and a new entropy value is generated.

NOTE

Reading ENT 15 always resets the entropy, so should always be read last.

- You can poll again for the new entropy value or you can use the Interrupt Status Register to handle reading the entropy values when the entropy valid interrupt is triggered.
- The interrupt can be masked or cleared as needed. See the Interrupt Status Register description.
- To change the self-test limits, the seed counters, how fast the entropy is generated, and how entropy is sampled, see the register description section. In particular, see the the TRNG Frequency Count Minimum Limit Register (FRQMIN), the seed control register (SCML), the statistical run length registers, and other parameter registers.
- Once in Run Mode, the entropy is re-generated automatically after ENT 15 is read. To stop the TRNG or access to TRNG registers at any point while in running mode, you can always set $MCTL[TRNG_ACC]=0$. Setting the TRNG back to programming mode ($MCTL[PRGM]=1$) also achieves the purpose of stopping entropy generation.

44.1.3.2 Register interface (IP Slave bus)

The TRNG's register interface (32-bit IP bus) is used to read and write registers within TRNG for the following purposes:

Table 44-2. Summary of register interface uses

| Purpose | For more information, see |
|--|--|
| During chip initialization time | |
| To configure TRNG including initialization of the <ul style="list-style-type: none"> • Registers • TRNG Register Interface | |
| During hardware and software debugging | |
| Read status registers | <ul style="list-style-type: none"> • RNG TRNG Status Register • For all registers, see the TRNG Register Descriptions" appendix. |

NOTE

Accesses to registers must use full-word (32-bit) reads or writes.

44.1.3.3 TRNG0 Register Descriptions

All accesses of undefined addresses always return zero and assert IPS transfer error. Writes to undefined and read-only addresses are ignored. Undefined addresses are those undocumented, protected or reserved addresses within and outside the range of the addresses defined in the memory map below. Although many of the TRNG0 registers hold more than 32 bits, the register addresses shown in the Memory Map below represent how these registers are accessed over the register bus as 32-bit words.

The format and fields in each TRNG0 register are defined below. Some of the register format figures apply to several different registers. In such cases a different register name will be associated with each of the register offset addresses that appear at the top of the register format figure. Although these registers share the same format, they are independent registers. In addition, many registers can be accessed at multiple addresses. In these cases there will be a single register name and the list of addresses at which that register is accessible will be indicated as aliases. Unless noted in the individual register descriptions, registers are reset only at Power-On Reset (POR).

44.1.3.3.1 TRNG0 Memory Map

| Offset | Register | Width (In bits) | Access | Reset value |
|-----------|---|--------------------|--------|------------------------|
| 0h | TRNG0 Miscellaneous Control (TRNG0_MCTL) | 32 | RW | 00012001h |
| 4h | TRNG0 Statistical Check Miscellaneous (TRNG0_SCMISC) | 32 | RW | 0001001Fh ¹ |
| 8h | TRNG0 Poker Range (TRNG0_PKRRNG) | 32 | RW | 000009A3h |
| Ch | TRNG0 Poker Maximum Limit (TRNG0_PKRMAX) | 32 | RW | 00006920h |
| Ch | TRNG0 Poker Square Calculation Result (TRNG0_PKRSQ) | 32 | RO | 00000000h |
| 10h | TRNG0 Seed Control (TRNG0_SDCTL) | 32 | RW | 0C8009C4h |
| 14h | TRNG0 Sparse Bit Limit (TRNG0_SBLIM) | 32 | RW | 0000003Fh |
| 14h | TRNG0 Total Samples (TRNG0_TOTSAM) | 32 | RO | 00000000h |
| 18h | TRNG0 Frequency Count Minimum Limit (TRNG0_FRQMIN) | 32 | RW | 00000640h |
| 1Ch | TRNG0 Frequency Count Maximum Limit (TRNG0_FRQMAX) | 32 | RW | 00006400h |
| 1Ch | TRNG0 Frequency Count (TRNG0_FRQCNT) | 32 | RO | 00000000h |
| 20h | TRNG0 Statistical Check Monobit Count (TRNG0_SCMC) | 32 | RO | 00000000h |
| 20h | TRNG0 Statistical Check Monobit Limit (TRNG0_SCML) | 32 | RW | 010C0568h |
| 24h | TRNG0 Statistical Check Run Length 1 Limit (TRNG0_SCR1L) | 32 | RW | 00B20195h |
| 24h | TRNG0 Statistical Check Run Length 1 Count (TRNG0_SCR1C) | 32 | RO | 00000000h |
| 28h | TRNG0 Statistical Check Run Length 2 Limit (TRNG0_SCR2L) | 32 | RW | 007A00DCh |
| 28h | TRNG0 Statistical Check Run Length 2 Count (TRNG0_SCR2C) | 32 | RO | 00000000h |
| 2Ch | TRNG0 Statistical Check Run Length 3 Count (TRNG0_SCR3C) | 32 | RO | 00000000h |
| 2Ch | TRNG0 Statistical Check Run Length 3 Limit (TRNG0_SCR3L) | 32 | RW | 0058007Dh |
| 30h | TRNG0 Statistical Check Run Length 4 Count (TRNG0_SCR4C) | 32 | RO | 00000000h |
| 30h | TRNG0 Statistical Check Run Length 4 Limit (TRNG0_SCR4L) | 32 | RW | 0040004Bh |
| 34h | TRNG0 Statistical Check Run Length 5 Limit (TRNG0_SCR5L) | 32 | RW | 002E002Fh |
| 34h | TRNG0 Statistical Check Run Length 5 Count (TRNG0_SCR5C) | 32 | RO | 00000000h |
| 38h | TRNG0 Statistical Check Run Length 6+ Limit (TRNG0_SCR6PL) | 32 | RW | 002E002Fh |
| 38h | TRNG0 Statistical Check Run Length 6+ Count (TRNG0_SCR6PC) | 32 | RO | 00000000h |
| 3Ch | TRNG0 Status (TRNG0_STATUS) | 32 | RO | 00000000h |
| 40h - 7Ch | TRNG0 Entropy Read (TRNG0_ENT0 - TRNG0_ENT15) | 32 | RO | 00000000h |
| 80h | TRNG0 Statistical Check Poker Count 1 and 0 (TRNG0_PKRCNT10) | 32 | RO | 00000000h |
| 84h | TRNG0 Statistical Check Poker Count 3 and 2 (TRNG0_PKRCNT32) | 32 | RO | 00000000h |
| 88h | TRNG0 Statistical Check Poker Count 5 and 4 (TRNG0_PKRCNT54) | 32 | RO | 00000000h |
| 8Ch | TRNG0 Statistical Check Poker Count 7 and 6 (TRNG0_PKRCNT76) | 32 | RO | 00000000h |
| 90h | TRNG0 Statistical Check Poker Count 9 and 8 (TRNG0_PKRCNT98) | 32 | RO | 00000000h |
| 94h | TRNG0 Statistical Check Poker Count B and A (TRNG0_PKRCNT BA) | 32 | RO | 00000000h |
| 98h | TRNG0 Statistical Check Poker Count D and C (TRNG0_PKRCNT DC) | 32 | RO | 00000000h |
| 9Ch | TRNG0 Statistical Check Poker Count F and E (TRNG0_PKRCNT FE) | 32 | RO | 00000000h |
| B0h | TRNG0 Security Configuration (TRNG0_SEC_CFG) | 32 | RW | 00000000h |

Table continues on the next page...

| Offset | Register | Width (In bits) | Access | Reset value |
|--------|---|--------------------|--------|-------------|
| B4h | TRNG0 Interrupt Control (TRNG0_INT_CTRL) | 32 | RW | FFFFFFFFh |
| B8h | TRNG0 Mask (TRNG0_INT_MASK) | 32 | RW | 00000000h |
| BCh | TRNG0 Interrupt Status (TRNG0_INT_STATUS) | 32 | RW | 00000000h |
| F0h | TRNG0 Version ID (MS) (TRNG0_VID1) | 32 | RO | 00300100h |
| F4h | TRNG0 Version ID (LS) (TRNG0_VID2) | 32 | RO | 00000000h |

- Reset occurs at POR, and when TRNG0_MCTL[RST_DEF] is written to 1.

44.1.3.3.2 TRNG0 Miscellaneous Control (TRNG0_MCTL)

44.1.3.3.2.1 Address

| Register | Offset |
|------------|--------|
| TRNG0_MCTL | 0h |

44.1.3.3.2.2 Function

This register is intended to be used for programming, configuring and testing the RNG. It is the main register to read/write, in order to enable Entropy generation, to stop entropy generation and to block access to entropy registers. This is done via the special TRNG_ACC and PRGM bits below.

The TRNG0 Miscellaneous Control Register is a read/write register used to control the RNG's True Random Number Generator (TRNG) access, operation and test.

NOTE

Note that in many cases two RNG registers share the same address, and a particular register at the shared address is selected based upon the value in the PRGM field of the TRNG0_MCTL register.

Standalone True Random Number Generator (SA-TRNG).

44.1.3.3.2.3 Diagram

| | | | | | | | | | | | | | | | | |
|-------|----------|----|--------------|-----|-------------|-------------|-------------|--------------|--------------|-------------|------------------|------------|---------|----|-------------------|----------|
| Bits | 31 | 30 | 29 | 28 | 27 | 26 | 25 | 24 | 23 | 22 | 21 | 20 | 19 | 18 | 17 | 16 |
| R | Reserved | | | | | | | | | | | | | | | PRG M |
| W | Reserved | | | | | | | | | | | | | | | M |
| Reset | 0 | 0 | 0 | 0 | 0 | 0 | 0 | 0 | 0 | 0 | 0 | 0 | 0 | 0 | 0 | 1 |
| Bits | 15 | 14 | 13 | 12 | 11 | 10 | 9 | 8 | 7 | 6 | 5 | 4 | 3 | 2 | 1 | 0 |
| R | Reserved | | TSTO P_OK | ERR | TST_ OUT | ENT_ VAL | FCT_ VAL | FCT_ FAIL | FOR_ SCLK | | TRN G_ ACC | UNU SED | OSC_DIV | | SAMP_ MOD E | |
| W | Reserved | | | w1c | | | | | | RST_ DEF | | | | | | |
| Reset | 0 | 0 | 1 | 0 | 0 | 0 | 0 | 0 | 0 | 0 | 0 | 0 | 0 | 0 | 0 | 1 |

44.1.3.3.2.4 Fields

| Field | Function |
|----------------|--|
| 31-17 — | Reserved. |
| 16 PRGM | Programming Mode Select. When this bit is 1, the TRNG is in Program Mode, otherwise it is in Run Mode. No Entropy value will be generated while the TRNG is in Program Mode. Note that different RNG registers are accessible at the same address depending on whether PRGM is set to 1 or 0. This is noted in the RNG register descriptions. |
| 15-14 — | Reserved. |
| 13 TSTOP_OK | TRNG_OK_TO_STOP. Software should check that this bit is a 1 before transitioning TRNG0 to low power mode (TRNG0 clock stopped). TRNG0 turns on the TRNG free-running ring oscillator whenever new entropy is being generated and turns off the ring oscillator when entropy generation is complete. If the TRNG0 clock is stopped while the TRNG ring oscillator is running, the oscillator will continue running even though the TRNG0 clock is stopped. TSTOP_OK is asserted when the TRNG ring oscillator is not running, and therefore it is ok to stop the TRNG0 clock. |
| 12 ERR | Read: Error status. 1 = error detected. 0 = no error. Write: Write 1 to clear errors. Writing 0 has no effect. |
| 11 TST_OUT | Read only: Test point inside ring oscillator. |
| 10 ENT_VAL | Read only: Entropy Valid. Will assert only if TRNG ACC bit is set, and then after an entropy value is generated. Will be cleared at most one (1) bus clock cycle after reading the TRNG0_ENT15 register. (TRNG0_ENT0 through TRNG0_ENT14 should be read before reading TRNG0_ENT15). |
| 9 FCT_VAL | Read only: Frequency Count Valid. Indicates that a valid frequency count may be read from TRNG0_FRQCNT. |
| 8 FCT_FAIL | Read only: Frequency Count Fail. The frequency counter has detected a failure. This may be due to improper programming of the TRNG0_FRQMAX and/or TRNG0_FRQMIN registers, or a hardware failure in the ring oscillator. This error may be cleared by writing a 1 to the ERR bit. |

Table continues on the next page...

| Field | Function |
|------------------|--|
| 7 FOR_SCLK | Force System Clock. If set, the system clock is used to operate the TRNG, instead of the ring oscillator. This is for test use only, and indeterminate results may occur. This bit is writable only if PRGM bit is 1, or PRGM bit is being written to 1 simultaneously to writing this bit. This bit is cleared by writing the RST_DEF bit to 1. |
| 6 RST_DEF | Reset Defaults. Writing a 1 to this bit clears various TRNG registers, and bits within registers, to their default state. This bit is writable only if PRGM bit is 1, or PRGM bit is being written to 1 simultaneously to writing this bit. Reading this bit always produces a 0. |
| 5 TRNG_ACC | TRNG Access Mode. If this bit is set to 1, the TRNG will generate an Entropy value that can be read via the TRNG0_ENT0-TRNG0_ENT15 registers. The Entropy value may be read once the ENT VAL bit is asserted. Also see TRNG0_ENTa register descriptions (For a = 0 to 15). |
| 4 UNUSED | This bit is unused but write-able. Must be left as zero. |
| 3-2 OSC_DIV | Oscillator Divide. Determines the amount of dividing done to the ring oscillator before it is used by the TRNG. This field is writable only if PRGM bit is 1, or PRGM bit is being written to 1 simultaneously to writing this field. This field is cleared to the default POR value by writing the RST_DEF bit to 1. 00 - use ring oscillator with no divide 01 - use ring oscillator divided-by-2 10 - use ring oscillator divided-by-4 11 - use ring oscillator divided-by-8 |
| 1-0 SAMP_MODE | Sample Mode. Determines the method of sampling the ring oscillator while generating the Entropy value: This field is writable only if PRGM bit is 1, or PRGM bit is being written to 1 simultaneously with writing this field. This field is cleared to the POR default value by writing the RST_DEF bit to 1. 00 - use Von Neumann data into both Entropy shifter and Statistical Checker 01 - use raw data into both Entropy shifter and Statistical Checker 10 - use Von Neumann data into Entropy shifter. Use raw data into Statistical Checker 11 - undefined/reserved. |

44.1.3.3.3 TRNG0 Statistical Check Miscellaneous (TRNG0_SCMISC)

44.1.3.3.3.1 Address

| Register | Offset |
|--------------|--------|
| TRNG0_SCMISC | 4h |

44.1.3.3.3.2 Function

The TRNG0 Statistical Check Miscellaneous Register contains the Long Run Maximum Limit value and the Retry Count value. This register is accessible only when the TRNG0_MCTL[PRGM] bit is 1, otherwise this register will read zeroes, and cannot be written.

44.1.3.3.3 Diagram

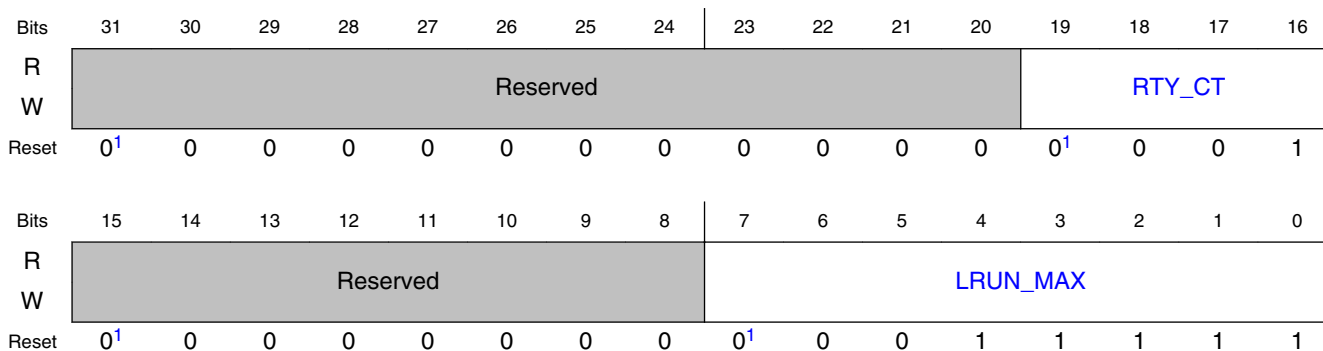

1. Reset occurs at POR, and when TRNG0_MCTL[RST_DEF] is written to 1.

44.1.3.3.4 Fields

| Field | Function |
|-----------------|--|
| 31-20 — | Reserved. |
| 19-16 RTY_CT | RETRY COUNT. If a statistical check fails during the TRNG Entropy Generation, the RTY_CT value indicates the number of times a retry should occur before generating an error. This field is writable only if TRNG0_MCTL[PRGM] bit is 1. This field will read zeroes if TRNG0_MCTL[PRGM] = 0. This field is cleared to the default POR value by writing the TRNG0_MCTL[RST_DEF] bit to 1. |
| 15-8 — | Reserved. |
| 7-0 LRUN_MAX | LONG RUN MAX LIMIT. This value is the largest allowable number of consecutive samples of all 1, or all 0, that is allowed during the Entropy generation. This field is writable only if TRNG0_MCTL[PRGM] bit is 1. This field will read zeroes if TRNG0_MCTL[PRGM] = 0. This field is cleared to the POR reset value by writing the TRNG0_MCTL[RST_DEF] bit to 1. |

44.1.3.3.4 TRNG0 Poker Range (TRNG0_PKRRNG)

44.1.3.3.4.1 Address

| Register | Offset |
|--------------|--------|
| TRNG0_PKRRNG | 8h |

44.1.3.3.4.2 Function

The TRNG0 Poker Range Register defines the difference between the TRNG Poker Maximum Limit and the minimum limit. These limits are used during the TRNG Statistical Check Poker Test.

44.1.3.3.4.3 Diagram

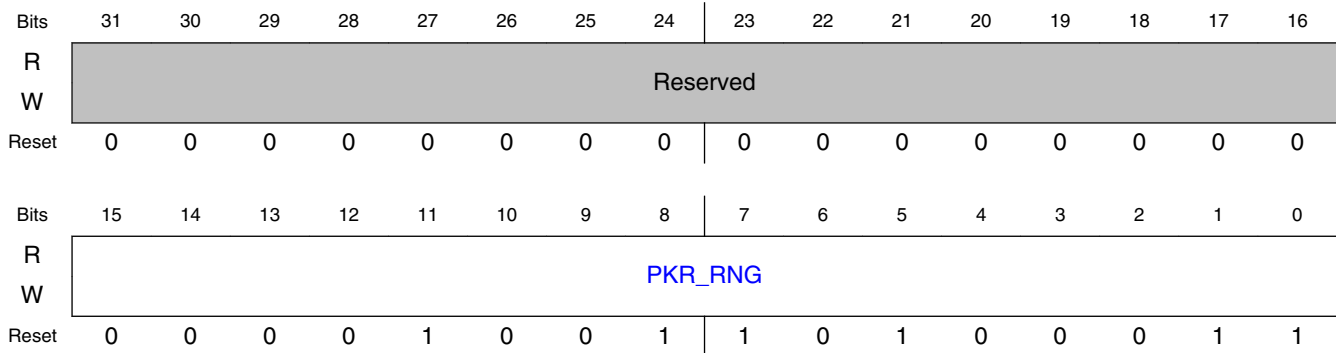

44.1.3.3.4.4 Fields

| Field | Function |
|-----------------|--|
| 31-16 — | Reserved. Always 0. |
| 15-0 PKR_RNG | Poker Range. During the TRNG Statistical Checks, a "Poker Test" is run which requires a maximum and minimum limit. The maximum is programmed in the PKRMAX[PKR_MAX] register, and the minimum is derived by subtracting the PKR_RNG value from the programmed maximum value. This field is writable only if TRNG0_MCTL[PRGM] bit is 1. This field will read zeroes if TRNG0_MCTL[PRGM] = 0. This field is cleared to the default POR value by writing the TRNG0_MCTL[RST_DEF] bit to 1. Note that the minimum allowable Poker result is PKR_MAX - PKR_RNG + 1. |

44.1.3.3.5 TRNG0 Poker Maximum Limit (TRNG0_PKRMAX)

44.1.3.3.5.1 Address

| Register | Offset | Description |
|--------------|--------|---|
| TRNG0_PKRMAX | Ch | Accessible at this address when TRNG0_MCTL[PRGM] = 1] |

44.1.3.3.5.2 Function

The TRNG0 Poker Maximum Limit Register defines Maximum Limit allowable during the TRNG Statistical Check Poker Test. Note that this offset (0x0C) is used as TRNG0_PKRMAX only if TRNG0_MCTL[PRGM] is 1. If TRNG0_MCTL[PRGM] is 0, this offset is used as the TRNG0_PKRSQ readback register.

44.1.3.3.5.3 Diagram

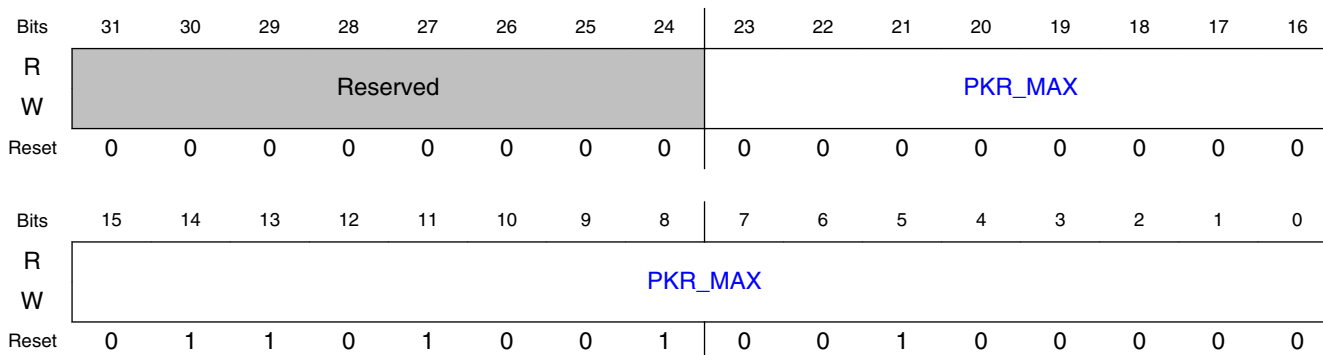

44.1.3.3.5.4 Fields

| Field | Function |
|-----------------|---|
| 31-24 — | |
| 23-0 PKR_MAX | Poker Maximum Limit. During the TRNG Statistical Checks, a "Poker Test" is run which requires a maximum and minimum limit. The maximum allowable result is programmed in the TRNG0_PKRMAX[PKR_MAX] register. This field is writable only if TRNG0_MCTL[PRGM] bit is 1. This register is cleared to the default POR value by writing the TRNG0_MCTL[RST_DEF] bit to 1. Note that the TRNG0_PKRMAX and TRNG0_PKRRNG registers combined are used to define the minimum allowable Poker result, which is PKR_MAX - PKR_RNG + 1. Note that if TRNG0_MCTL[PRGM] bit is 0, this register address is used to read the Poker Test Square Calculation result in register TRNG0_PKRSQ, as defined in the following section. |

44.1.3.3.6 TRNG0 Poker Square Calculation Result (TRNG0_PKRSQ)

44.1.3.3.6.1 Address

| Register | Offset | Description |
|-------------|--------|--|
| TRNG0_PKRSQ | Ch | Accessible at this address when TRNG0_MCTL[PRGM] = 0 |

44.1.3.3.6.2 Function

The TRNG0 Poker Square Calculation Result Register is a read-only register used to read the result of the TRNG Statistical Check Poker Test's Square Calculation. This test starts with the TRNG0_PKRMAX value and decreases towards a final result, which is read here. For the Poker Test to pass, this final result must be less than the programmed TRNG0_PKRRNG value. Note that this offset (0x0C) is used as TRNG0_PKRMAX if TRNG0_MCTL[PRGM] is 1. If TRNG0_MCTL[PRGM] is 0, this offset is used as TRNG0_PKRSQ readback register, as described here.

44.1.3.3.6.3 Diagram

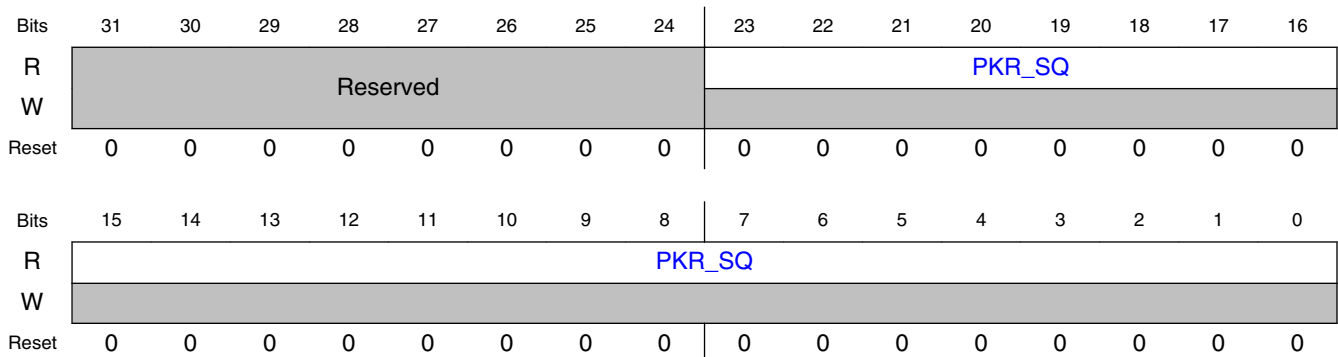

44.1.3.3.6.4 Fields

| Field | Function |
|----------------|--|
| 31-24 — | |
| 23-0 PKR_SQ | Poker Square Calculation Result. During the TRNG Statistical Checks, a "Poker Test" is run which starts with the value TRNG0_PKRMAX[PKR_MAX]. This value decreases according to a "sum of squares" algorithm, and must remain greater than zero, but less than the TRNG0_PKRRNG[PKR_RNG] limit. The resulting value may be read through this register, if TRNG0_MCTL[PRGM] bit is 0. Note that if TRNG0_MCTL[PRGM] bit is 1, this register address is used to access the Poker Test Maximum Limit in register TRNG0_PKRMAX, as defined in the previous section. |

44.1.3.3.7 TRNG0 Seed Control (TRNG0_SDCTL)

44.1.3.3.7.1 Address

| Register | Offset |
|-------------|--------|
| TRNG0_SDCTL | 10h |

44.1.3.3.7.2 Function

The TRNG0 Seed Control Register contains two fields. One field defines the length (in system clocks) of each Entropy sample (ENT_DLY), and the other field indicates the number of samples that will taken during each TRNG Entropy generation (SAMP_SIZE).

44.1.3.3.7.3 Diagram

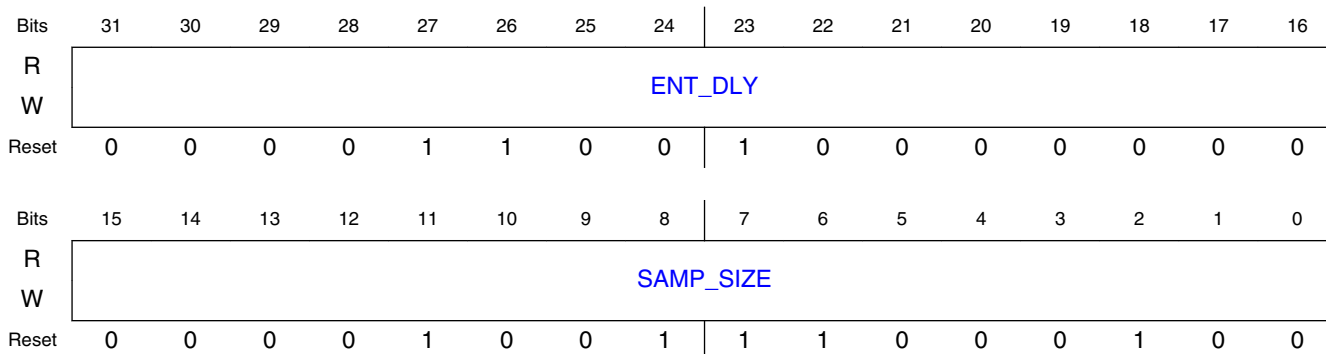

44.1.3.3.7.4 Fields

| Field | Function |
|-------------------|---|
| 31-16 ENT_DLY | Entropy Delay. Defines the length (in system clocks) of each Entropy sample taken. This field is writable only if TRNG0_MCTL[PRGM] bit is 1. This field will read zeroes if TRNG0_MCTL[PRGM] = 0. This field is cleared to its reset value at POR. |
| 15-0 SAMP_SIZE | Sample Size. Defines the total number of Entropy samples that will be taken during Entropy generation. This field is writable only if TRNG0_MCTL[PRGM] bit is 1. This field will read zeroes if TRNG0_MCTL[PRGM] = 0. This field is cleared to the default POR value by writing the TRNG0_MCTL[RST_DEF] bit to 1. |

44.1.3.3.8 TRNG0 Sparse Bit Limit (TRNG0_SBLIM)

44.1.3.3.8.1 Address

| Register | Offset | Description |
|-------------|--------|---|
| TRNG0_SBLIM | 14h | Accessible at this address when TRNG0_MCTL[PRGM] = 1] |

44.1.3.3.8.2 Function

The TRNG0 Sparse Bit Limit Register is used when Von Neumann sampling is selected during Entropy Generation. It defines the maximum number of consecutive Von Neumann samples which may be discarded before an error is generated. Note that this address (0x14) is used as TRNG0_SBLIM only if TRNG0_MCTL[PRGM] is 1. If TRNG0_MCTL[PRGM] is 0, this address is used as TRNG0_TOTSAM readback register.

44.1.3.3.8.3 Diagram

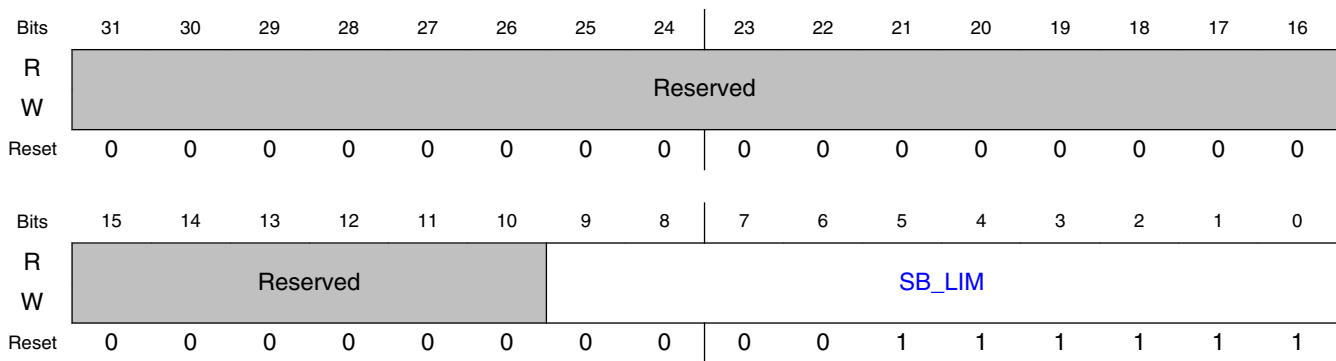

44.1.3.3.8.4 Fields

| Field | Function |
|---------------|---|
| 31-10 — | Reserved. Always 0. |
| 9-0 SB_LIM | Sparse Bit Limit. During Von Neumann sampling (if enabled by TRNG0_MCTL[SAMP_MODE], samples are discarded if two consecutive raw samples are both 0 or both 1. If this discarding occurs for a long period of time, it indicates that there is insufficient Entropy. The Sparse Bit Limit defines the maximum number of consecutive samples that may be discarded before an error is generated. This field is writable only if TRNG0_MCTL[PRGM] bit is 1. This register is cleared to the default POR value by writing the TRNG0_MCTL[RST_DEF] bit to 1. Note that if TRNG0_MCTL[PRGM] bit is 0, this register address is used to read the Total Samples count in register TRNG0_TOTSAM, as defined in the following section. |

44.1.3.3.9 TRNG0 Total Samples (TRNG0_TOTSAM)

44.1.3.3.9.1 Address

| Register | Offset | Description |
|--------------|--------|---|
| TRNG0_TOTSAM | 14h | Accessible at this address when TRNG0_MCTL[PRGM] = 0] |

44.1.3.3.9.2 Function

The TRNG0 Total Samples Register is a read-only register used to read the total number of samples taken during Entropy generation. It is used to give an indication of how often a sample is actually used during Von Neumann sampling. Note that this offset (0x14) is used as TRNG0_SBLIM if TRNG0_MCTL[PRGM] is 1. If TRNG0_MCTL[PRGM] is 0, this offset is used as TRNG0_TOTSAM readback register, as described here.

44.1.3.3.9.3 Diagram

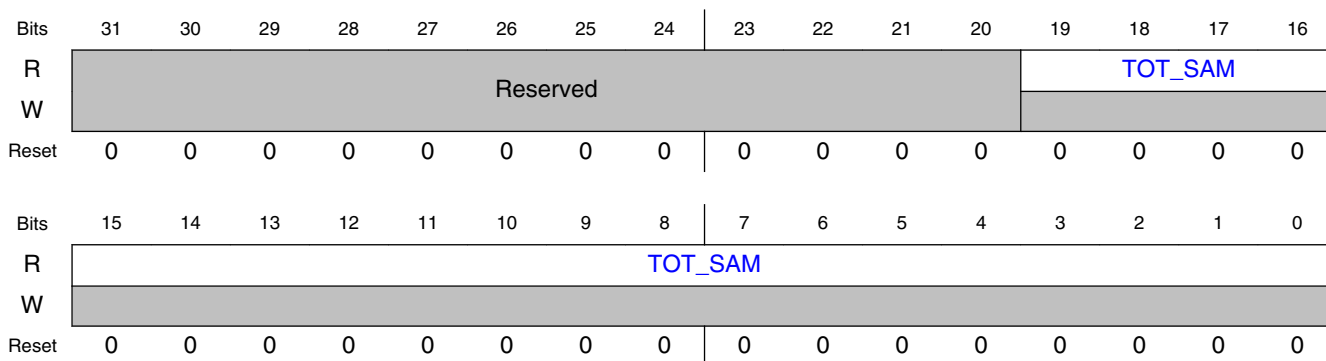

44.1.3.3.9.4 Fields

| Field | Function |
|-----------------|--|
| 31-20 — | Reserved. Always 0. |
| 19-0 TOT_SAM | Total Samples. During Entropy generation, the total number of raw samples is counted. This count is useful in determining how often a sample is used during Von Neumann sampling. The count may be read through this register, if TRNG0_MCTL[PRGM] bit is 0. Note that if TRNG0_MCTL[PRGM] bit is 1, this register address is used to access the Sparse Bit Limit in register TRNG0_SBLIM, as defined in the previous section. |

44.1.3.3.10 TRNG0 Frequency Count Minimum Limit (TRNG0_FRQMIN)

44.1.3.3.10.1 Address

| Register | Offset |
|--------------|--------|
| TRNG0_FRQMIN | 18h |

44.1.3.3.10.2 Function

The TRNG0 Frequency Count Minimum Limit Register defines the minimum allowable count taken by the Entropy sample counter during each Entropy sample. During any sample period, if the count is less than this programmed minimum, a Frequency Count Fail is flagged in TRNG0_MCTL[FCT_FAIL] and an error is generated.

44.1.3.3.10.3 Diagram

| | | | | | | | | | | | | | | | | |
|-------|----------|----|----|----|----|----|----|----|---------|----|----|----|----|----|----|----|
| Bits | 31 | 30 | 29 | 28 | 27 | 26 | 25 | 24 | 23 | 22 | 21 | 20 | 19 | 18 | 17 | 16 |
| R | Reserved | | | | | | | | FRQ_MIN | | | | | | | |
| W | Reserved | | | | | | | | FRQ_MIN | | | | | | | |
| Reset | 0 | 0 | 0 | 0 | 0 | 0 | 0 | 0 | 0 | 0 | 0 | 0 | 0 | 0 | 0 | 0 |
| Bits | 15 | 14 | 13 | 12 | 11 | 10 | 9 | 8 | 7 | 6 | 5 | 4 | 3 | 2 | 1 | 0 |
| R | FRQ_MIN | | | | | | | | | | | | | | | |
| W | FRQ_MIN | | | | | | | | | | | | | | | |
| Reset | 0 | 0 | 0 | 0 | 0 | 1 | 1 | 0 | 0 | 1 | 0 | 0 | 0 | 0 | 0 | 0 |

44.1.3.3.10.4 Fields

| Field | Function |
|-----------------|--|
| 31-22 — | Reserved. Always 0. |
| 21-0 FRQ_MIN | Frequency Count Minimum Limit. Defines the minimum allowable count taken during each entropy sample. This field is writable only if TRNG0_MCTL[PRGM] bit is 1. This field will read zeroes if TRNG0_MCTL[PRGM] = 0. This field is cleared to its reset value at POR. |

44.1.3.3.11 TRNG0 Frequency Count (TRNG0_FRQCNT)

44.1.3.3.11.1 Address

| Register | Offset | Description |
|--------------|--------|--|
| TRNG0_FRQCNT | 1Ch | Accessible at this address when TRNG0_MCTL[PRGM] = 0 |

44.1.3.3.11.2 Function

The TRNG0 Frequency Count Register is a read-only register used to read the frequency counter within the TRNG entropy generator. It will read all zeroes unless TRNG0_MCTL[TRNG_ACC] = 1. Note that this offset (0x1C) is used as TRNG0_FRQMAX if TRNG0_MCTL[PRGM] is 1. If TRNG0_MCTL[PRGM] is 0, this offset is used as TRNG0_FRQCNT readback register, as described here.

44.1.3.3.11.3 Diagram

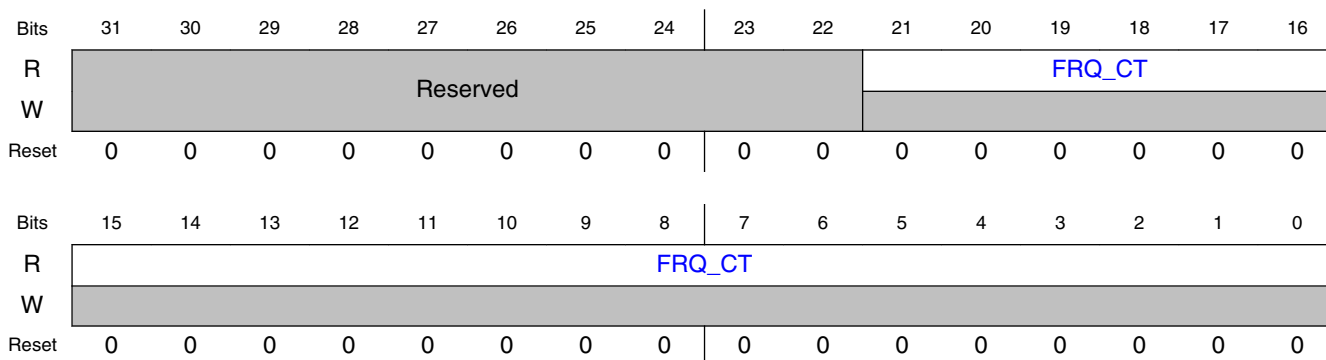

44.1.3.3.11.4 Fields

| Field | Function |
|----------------|---|
| 31-22 — | Reserved. Always 0. |
| 21-0 FRQ_CT | Frequency Count. If TRNG0_MCTL[TRNG_ACC] = 1, reads a sample frequency count taken during entropy generation. Requires TRNG0_MCTL[PRGM] = 0. Note that if TRNG0_MCTL[PRGM] bit is 1, this register address is used to access the Poker Test Maximum Limit in register TRNG0_PKRMAX, as defined in the previous section. |

44.1.3.3.12 TRNG0 Frequency Count Maximum Limit (TRNG0_FRQMAX)

44.1.3.3.12.1 Address

| Register | Offset | Description |
|--------------|--------|---|
| TRNG0_FRQMAX | 1Ch | Accessible at this address when TRNG0_MCTL[PRGM] = 1] |

44.1.3.3.12.2 Function

The TRNG0 Frequency Count Maximum Limit Register defines the maximum allowable count taken by the Entropy sample counter during each Entropy sample. During any sample period, if the count is greater than this programmed maximum, a Frequency Count Fail is flagged in TRNG0_MCTL[FCT_FAIL] and an error is generated. Note that this address (001C) is used as TRNG0_FRQMAX only if TRNG0_MCTL[PRGM] is 1. If TRNG0_MCTL[PRGM] is 0, this address is used as TRNG0_FRQCNT readback register.

44.1.3.3.12.3 Diagram

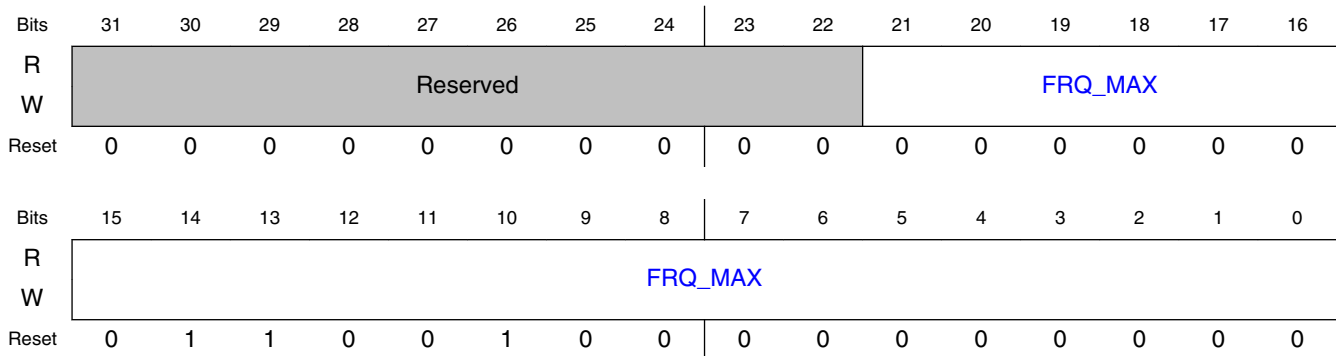

44.1.3.3.12.4 Fields

| Field | Function |
|-----------------|---|
| 31-22 — | Reserved. Always 0. |
| 21-0 FRQ_MAX | Frequency Counter Maximum Limit. Defines the maximum allowable count taken during each entropy sample. This field is writable only if TRNG0_MCTL[PRGM] bit is 1. This field is cleared to its reset value at POR. Note that if TRNG0_MCTL[PRGM] bit is 0, this register address is used to read the Frequency Count result in register TRNG0_FRQCNT, as defined in the following section. |

44.1.3.3.13 TRNG0 Statistical Check Monobit Count (TRNG0_SCMC)

44.1.3.3.13.1 Address

| Register | Offset | Description |
|------------|--------|---|
| TRNG0_SCMC | 20h | Accessible at this address when TRNG0_MCTL[PRGM] = 0] |

44.1.3.3.13.2 Function

The TRNG0 Statistical Check Monobit Count Register is a read-only register used to read the final monobit count after entropy generation. This counter starts with the value in TRNG0_SCML[MONO_MAX], and is decremented each time a one is sampled. Note that this offset (0x20) is used as TRNG0_SCML if TRNG0_MCTL[PRGM] is 1. If TRNG0_MCTL[PRGM] is 0, this offset is used as TRNG0_SCMC readback register, as described here.

44.1.3.3.13.3 Diagram

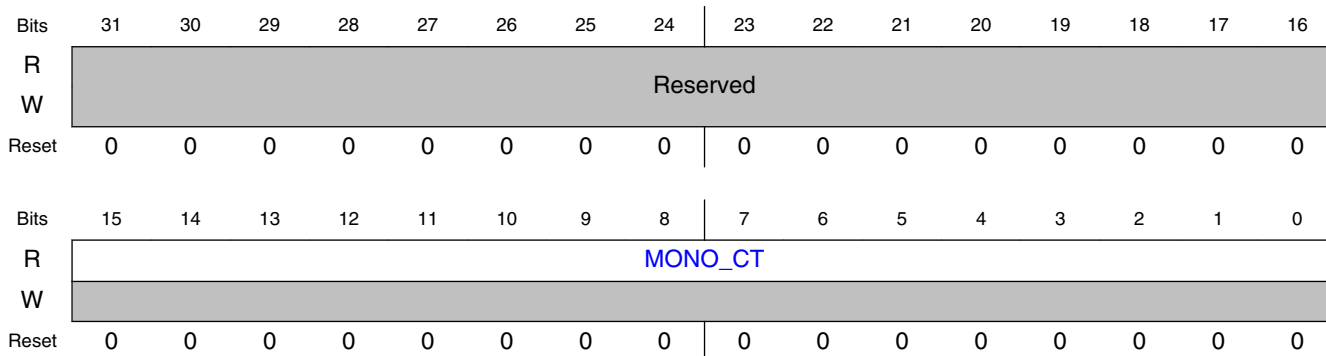

44.1.3.3.13.4 Fields

| Field | Function |
|-----------------|---|
| 31-16 — | Reserved. Always 0. |
| 15-0 MONO_CT | Monobit Count. Reads the final Monobit count after entropy generation. Requires TRNG0_MCTL[PRGM] = 0. Note that if TRNG0_MCTL[PRGM] bit is 1, this register address is used to access the Statistical Check Monobit Limit in register TRNG0_SCML, as defined in the previous section. |

44.1.3.3.14 TRNG0 Statistical Check Monobit Limit (TRNG0_SCML)

44.1.3.3.14.1 Address

| Register | Offset | Description |
|------------|--------|---|
| TRNG0_SCML | 20h | Accessible at this address when TRNG0_MCTL[PRGM] = 1] |

44.1.3.3.14.2 Function

The TRNG0 Statistical Check Monobit Limit Register defines the allowable maximum and minimum number of ones/zero detected during entropy generation. To pass the test, the number of ones/zeroes generated must be less than the programmed maximum value, and the number of ones/zeroes generated must be greater than (maximum - range). If this test fails, the Retry Counter in TRNG0_SCMISC will be decremented, and a retry will occur if the Retry Count has not reached zero. If the Retry Count has reached zero, an error will be generated. Note that this offset (0x20) is used as TRNG0_SCML only if TRNG0_MCTL[PRGM] is 1. If TRNG0_MCTL[PRGM] is 0, this offset is used as TRNG0_SCMC readback register.

44.1.3.3.14.3 Diagram

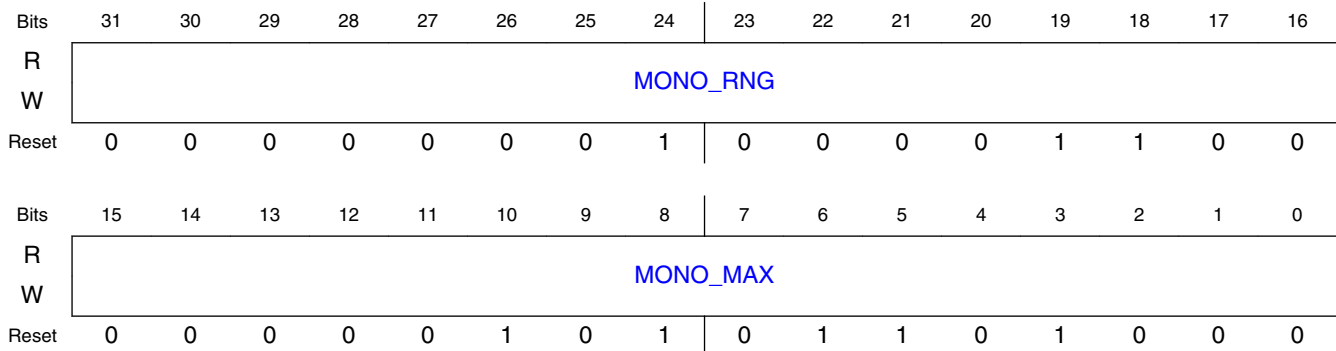

44.1.3.3.14.4 Fields

| Field | Function |
|-------------------|--|
| 31-16 MONO_RNG | Monobit Range. The number of ones/zeroes detected during entropy generation must be greater than MONO_MAX - MONO_RNG, else a retry or error will occur. This register is cleared to the default POR value by writing the TRNG0_MCTL[RST_DEF] bit to 1. |

Table continues on the next page...

Standalone True Random Number Generator (SA-TRNG).

| Field | Function |
|------------------|--|
| 15-0 MONO_MAX | Monobit Maximum Limit. Defines the maximum allowable count taken during entropy generation. The number of ones/zeros detected during entropy generation must be less than MONO_MAX, else a retry or error will occur. This register is cleared to the default POR value by writing the TRNG0_MCTL[RST_DEF] bit to 1. |

44.1.3.3.15 TRNG0 Statistical Check Run Length 1 Count (TRNG0_SCR1C)

44.1.3.3.15.1 Address

| Register | Offset | Description |
|-------------|--------|---|
| TRNG0_SCR1C | 24h | Accessible at this address when TRNG0_MCTL[PRGM] = 0] |

44.1.3.3.15.2 Function

The TRNG0 Statistical Check Run Length 1 Counters Register is a read-only register used to read the final Run Length 1 counts after entropy generation. These counters start with the value in TRNG0_SCRxC1L[RUN1_MAX]. The R1_1_CT decrements each time a single one is sampled (preceded by a zero and followed by a zero). The R1_0_CT decrements each time a single zero is sampled (preceded by a one and followed by a one). Note that this offset (0x24) is used as TRNG0_SCRxC1L if TRNG0_MCTL[PRGM] is 1. If TRNG0_MCTL[PRGM] is 0, this offset is used as TRNG0_SCRxC1C readback register, as described here.

44.1.3.3.15.3 Diagram

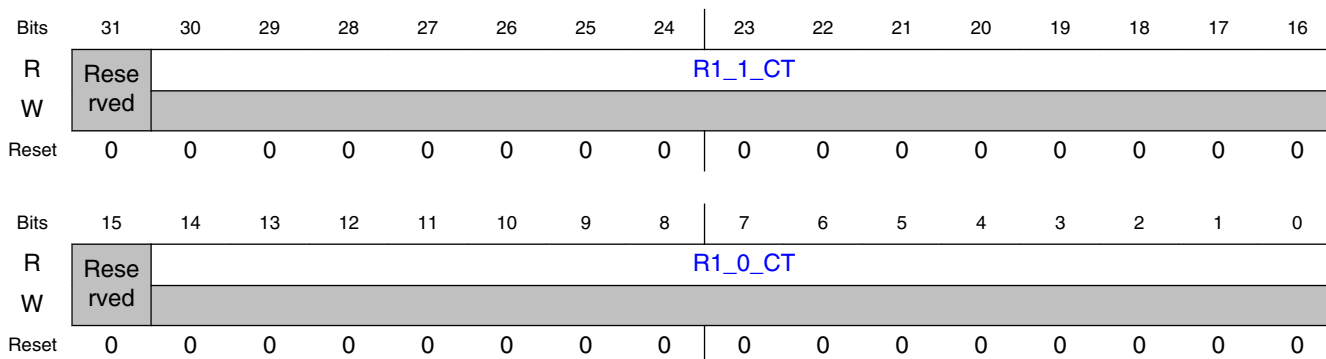

44.1.3.3.15.4 Fields

| Field | Function |
|------------------|---|
| 31 — | Reserved. Always 0. |
| 30-16 R1_1_CT | Runs of One, Length 1 Count. Reads the final Runs of Ones, length 1 count after entropy generation. Requires TRNG0_MCTL[PRGM] = 0. |
| 15 — | Reserved. Always 0. |
| 14-0 R1_0_CT | Runs of Zero, Length 1 Count. Reads the final Runs of Zeroes, length 1 count after entropy generation. Requires TRNG0_MCTL[PRGM] = 0. |

44.1.3.3.16 TRNG0 Statistical Check Run Length 1 Limit (TRNG0_SCR1L)

44.1.3.3.16.1 Address

| Register | Offset | Description |
|-------------|--------|---|
| TRNG0_SCR1L | 24h | Accessible at this address when TRNG0_MCTL[PRGM] = 1] |

44.1.3.3.16.2 Function

The TRNG0 Statistical Check Run Length 1 Limit Register defines the allowable maximum and minimum number of runs of length 1 detected during entropy generation. To pass the test, the number of runs of length 1 (for samples of both 0 and 1) must be less than the programmed maximum value, and the number of runs of length 1 must be greater than (maximum - range). If this test fails, the Retry Counter in TRNG0_SCMISC will be decremented, and a retry will occur if the Retry Count has not reached zero. If the Retry Count has reached zero, an error will be generated. Note that this address (0x24) is used as TRNG0_SCRxC1L only if TRNG0_MCTL[PRGM] is 1. If TRNG0_MCTL[PRGM] is 0, this address is used as TRNG0_SCRxC1C readback register.

Standalone True Random Number Generator (SA-TRNG).

44.1.3.3.16.3 Diagram

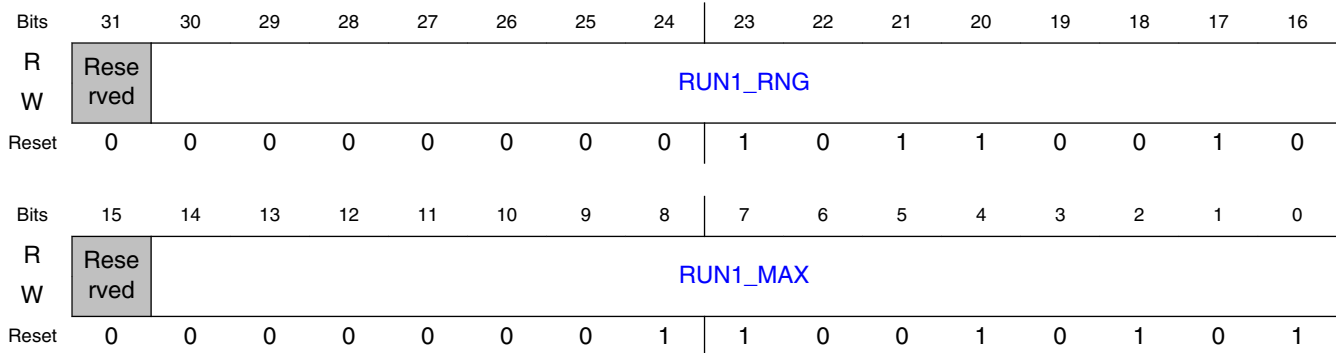

44.1.3.3.16.4 Fields

| Field | Function |
|-------------------|--|
| 31 — | Reserved. Always 0. |
| 30-16 RUN1_RNG | Run Length 1 Range. The number of runs of length 1 (for both 0 and 1) detected during entropy generation must be greater than RUN1_MAX - RUN1_RNG, else a retry or error will occur. This register is cleared to the default POR value by writing the TRNG0_MCTL[RST_DEF] bit to 1. |
| 15 — | Reserved. Always 0. |
| 14-0 RUN1_MAX | Run Length 1 Maximum Limit. Defines the maximum allowable runs of length 1 (for both 0 and 1) detected during entropy generation. The number of runs of length 1 detected during entropy generation must be less than RUN1_MAX, else a retry or error will occur. This register is cleared to the default POR value by writing the TRNG0_MCTL[RST_DEF] bit to 1. |

44.1.3.3.17 TRNG0 Statistical Check Run Length 2 Count (TRNG0_SCR2C)

44.1.3.3.17.1 Address

| Register | Offset | Description |
|-------------|--------|---|
| TRNG0_SCR2C | 28h | Accessible at this address when TRNG0_MCTL[PRGM] = 0] |

44.1.3.3.17.2 Function

The TRNG0 Statistical Check Run Length 2 Counters Register is a read-only register used to read the final Run Length 2 counts after entropy generation. These counters start with the value in TRNG0_SCRxC2L[RUN2_MAX]. The R2_1_CT decrements each time two consecutive ones are sampled (preceded by a zero and followed by a zero). The

R2_0_CT decrements each time two consecutive zeroes are sampled (preceded by a one and followed by a one). Note that this offset (0x28) is used as TRNG0_SCRxC2L if TRNG0_MCTL[PRGM] is 1. If TRNG0_MCTL[PRGM] is 0, this offset is used as TRNG0_SCRxC2C readback register, as described here.

44.1.3.3.17.3 Diagram

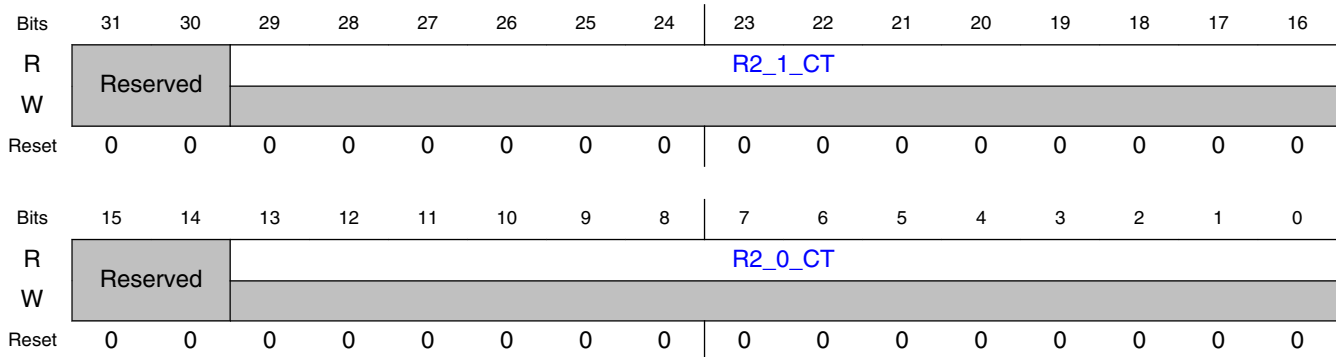

44.1.3.3.17.4 Fields

| Field | Function |
|------------------|---|
| 31-30 — | Reserved. Always 0. |
| 29-16 R2_1_CT | Runs of One, Length 2 Count. Reads the final Runs of Ones, length 2 count after entropy generation. Requires TRNG0_MCTL[PRGM] = 0. |
| 15-14 — | Reserved. Always 0. |
| 13-0 R2_0_CT | Runs of Zero, Length 2 Count. Reads the final Runs of Zeroes, length 2 count after entropy generation. Requires TRNG0_MCTL[PRGM] = 0. |

44.1.3.3.18 TRNG0 Statistical Check Run Length 2 Limit (TRNG0_SCR2L)

44.1.3.3.18.1 Address

| Register | Offset | Description |
|-------------|--------|---|
| TRNG0_SCR2L | 28h | Accessible at this address when TRNG0_MCTL[PRGM] = 1] |

44.1.3.3.18.2 Function

The TRNG0 Statistical Check Run Length 2 Limit Register defines the allowable maximum and minimum number of runs of length 2 detected during entropy generation. To pass the test, the number of runs of length 2 (for samples of both 0 and 1) must be less than the programmed maximum value, and the number of runs of length 2 must be greater than (maximum - range). If this test fails, the Retry Counter in TRNG0_SCMISC will be decremented, and a retry will occur if the Retry Count has not reached zero. If the Retry Count has reached zero, an error will be generated. Note that this address (0x28) is used as TRNG0_SCRxC2L only if TRNG0_MCTL[PRGM] is 1. If TRNG0_MCTL[PRGM] is 0, this address is used as TRNG0_SCRxC2C readback register.

44.1.3.3.18.3 Diagram

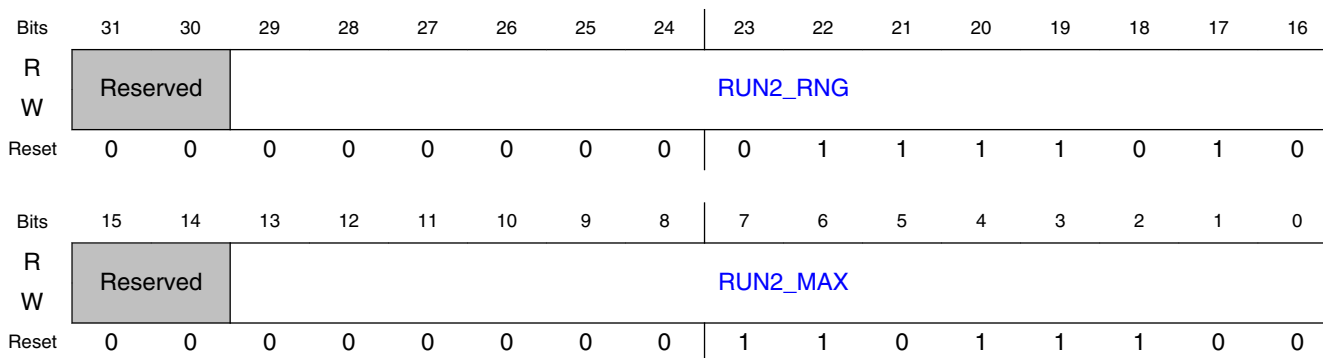

44.1.3.3.18.4 Fields

| Field | Function |
|-------------------|--|
| 31-30 — | Reserved. Always 0. |
| 29-16 RUN2_RNG | Run Length 2 Range. The number of runs of length 2 (for both 0 and 1) detected during entropy generation must be greater than RUN2_MAX - RUN2_RNG, else a retry or error will occur. This register is cleared to the default POR value by writing the TRNG0_MCTL[RST_DEF] bit to 1. |
| 15-14 — | Reserved. Always 0. |
| 13-0 RUN2_MAX | Run Length 2 Maximum Limit. Defines the maximum allowable runs of length 2 (for both 0 and 1) detected during entropy generation. The number of runs of length 2 detected during entropy generation must be less than RUN2_MAX, else a retry or error will occur. This register is cleared to the default POR value by writing the TRNG0_MCTL[RST_DEF] bit to 1. |

44.1.3.3.19 TRNG0 Statistical Check Run Length 3 Count (TRNG0_SCR3C)

44.1.3.3.19.1 Address

| Register | Offset | Description |
|-------------|--------|---|
| TRNG0_SCR3C | 2Ch | Accessible at this address when TRNG0_MCTL[PRGM] = 0] |

44.1.3.3.19.2 Function

The TRNG0 Statistical Check Run Length 3 Counters Register is a read-only register used to read the final Run Length 3 counts after entropy generation. These counters start with the value in TRNG0_SCRxC3L[RUN3_MAX]. The R3_1_CT decrements each time three consecutive ones are sampled (preceded by a zero and followed by a zero). The R3_0_CT decrements each time three consecutive zeroes are sampled (preceded by a one and followed by a one). Note that this offset (0x2C) is used as TRNG0_SCRxC3L if TRNG0_MCTL[PRGM] is 1. If TRNG0_MCTL[PRGM] is 0, this offset is used as TRNG0_SCRxC3C readback register, as described here.

44.1.3.3.19.3 Diagram

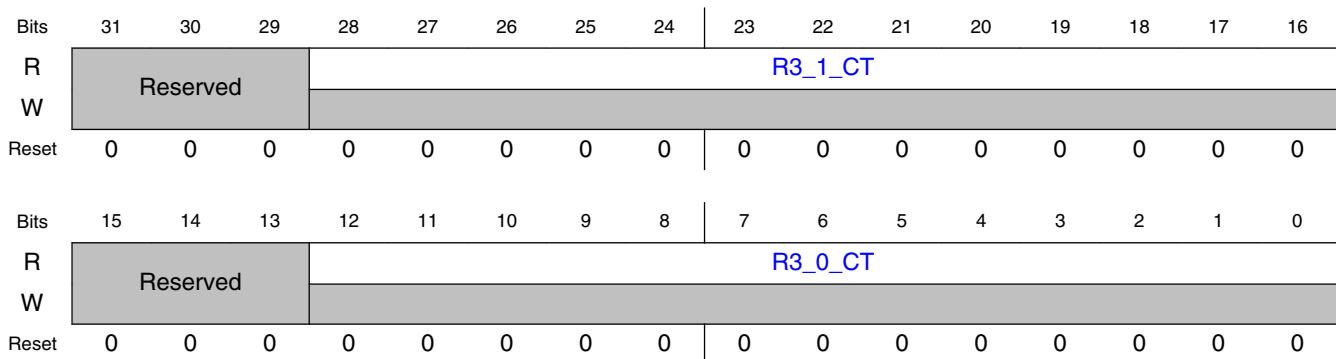

44.1.3.3.19.4 Fields

| Field | Function |
|------------------|---|
| 31-29 — | Reserved. Always 0. |
| 28-16 R3_1_CT | Runs of Ones, Length 3 Count. Reads the final Runs of Ones, length 3 count after entropy generation. Requires TRNG0_MCTL[PRGM] = 0. |
| 15-13 | Reserved. Always 0. |

Table continues on the next page...

Standalone True Random Number Generator (SA-TRNG).

| Field | Function |
|-----------------|---|
| — | |
| 12-0 R3_0_CT | Runs of Zeroes, Length 3 Count. Reads the final Runs of Zeroes, length 3 count after entropy generation. Requires TRNG0_MCTL[PRGM] = 0. |

44.1.3.3.20 TRNG0 Statistical Check Run Length 3 Limit (TRNG0_SCR3L)

44.1.3.3.20.1 Address

| Register | Offset | Description |
|-------------|--------|---|
| TRNG0_SCR3L | 2Ch | Accessible at this address when TRNG0_MCTL[PRGM] = 1] |

44.1.3.3.20.2 Function

The TRNG0 Statistical Check Run Length 3 Limit Register defines the allowable maximum and minimum number of runs of length 3 detected during entropy generation. To pass the test, the number of runs of length 3 (for samples of both 0 and 1) must be less than the programmed maximum value, and the number of runs of length 3 must be greater than (maximum - range). If this test fails, the Retry Counter in TRNG0_SCMISC will be decremented, and a retry will occur if the Retry Count has not reached zero. If the Retry Count has reached zero, an error will be generated. Note that this address (0x2C) is used as TRNG0_SCRxC3L only if TRNG0_MCTL[PRGM] is 1. If TRNG0_MCTL[PRGM] is 0, this address is used as TRNG0_SCRxC3C readback register.

44.1.3.3.20.3 Diagram

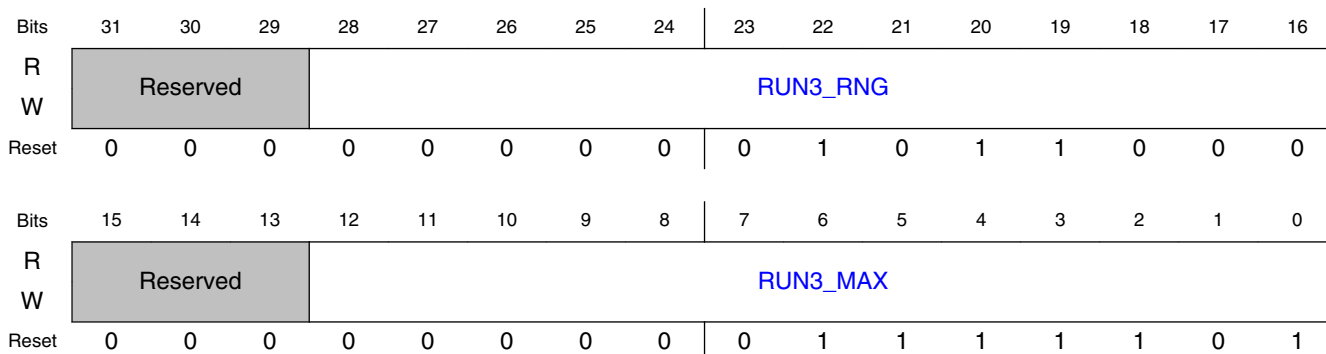

44.1.3.3.20.4 Fields

| Field | Function |
|-------------------|--|
| 31-29 — | Reserved. Always 0. |
| 28-16 RUN3_RNG | Run Length 3 Range. The number of runs of length 3 (for both 0 and 1) detected during entropy generation must be greater than RUN3_MAX - RUN3_RNG, else a retry or error will occur. This register is cleared to the default POR value by writing the TRNG0_MCTL[RST_DEF] bit to 1. |
| 15-13 — | Reserved. Always 0. |
| 12-0 RUN3_MAX | Run Length 3 Maximum Limit. Defines the maximum allowable runs of length 3 (for both 0 and 1) detected during entropy generation. The number of runs of length 3 detected during entropy generation must be less than RUN3_MAX, else a retry or error will occur. This register is cleared to the default POR value by writing the TRNG0_MCTL[RST_DEF] bit to 1. |

44.1.3.3.21 TRNG0 Statistical Check Run Length 4 Count (TRNG0_SCR4C)

44.1.3.3.21.1 Address

| Register | Offset | Description |
|-------------|--------|---|
| TRNG0_SCR4C | 30h | Accessible at this address when TRNG0_MCTL[PRGM] = 0] |

44.1.3.3.21.2 Function

The TRNG0 Statistical Check Run Length 4 Counters Register is a read-only register used to read the final Run Length 4 counts after entropy generation. These counters start with the value in TRNG0_SCRxC4L[RUN4_MAX]. The R4_1_CT decrements each time four consecutive ones are sampled (preceded by a zero and followed by a zero). The R4_0_CT decrements each time four consecutive zeroes are sampled (preceded by a one and followed by a one). Note that this offset (0x30) is used as TRNG0_SCRxC4L if TRNG0_MCTL[PRGM] is 1. If TRNG0_MCTL[PRGM] is 0, this offset is used as TRNG0_SCRxC4C readback register, as described here.

Standalone True Random Number Generator (SA-TRNG).

44.1.3.3.21.3 Diagram

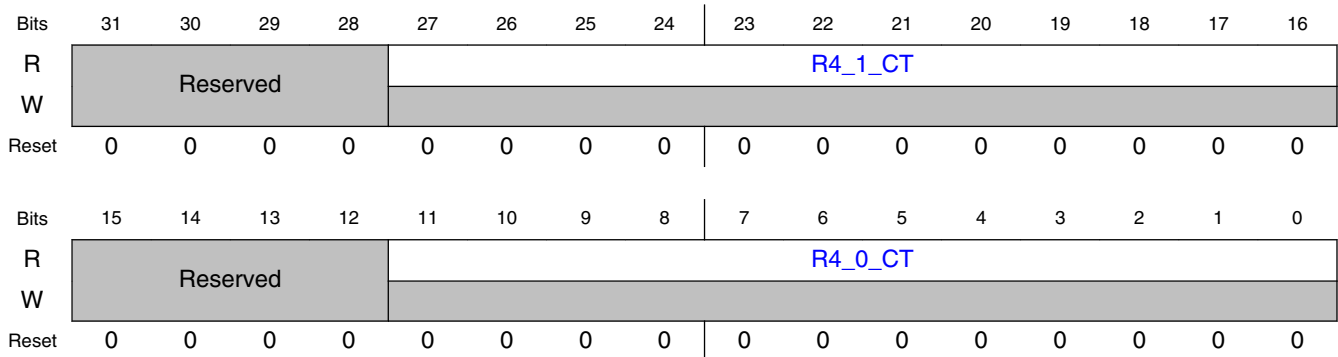

44.1.3.3.21.4 Fields

| Field | Function |
|------------------|---|
| 31-28 — | Reserved. Always 0. |
| 27-16 R4_1_CT | Runs of One, Length 4 Count. Reads the final Runs of Ones, length 4 count after entropy generation. Requires TRNG0_MCTL[PRGM] = 0. |
| 15-12 — | Reserved. Always 0. |
| 11-0 R4_0_CT | Runs of Zero, Length 4 Count. Reads the final Runs of Ones, length 4 count after entropy generation. Requires TRNG0_MCTL[PRGM] = 0. |

44.1.3.3.22 TRNG0 Statistical Check Run Length 4 Limit (TRNG0_SCR4L)

44.1.3.3.22.1 Address

| Register | Offset | Description |
|-------------|--------|---|
| TRNG0_SCR4L | 30h | Accessible at this address when TRNG0_MCTL[PRGM] = 1] |

44.1.3.3.22.2 Function

The TRNG0 Statistical Check Run Length 4 Limit Register defines the allowable maximum and minimum number of runs of length 4 detected during entropy generation. To pass the test, the number of runs of length 4 (for samples of both 0 and 1) must be less than the programmed maximum value, and the number of runs of length 4 must be greater than (maximum - range). If this test fails, the Retry Counter in TRNG0_SCMISC

will be decremented, and a retry will occur if the Retry Count has not reached zero. If the Retry Count has reached zero, an error will be generated. Note that this address (0x30) is used as TRNG0_SCRxC4L only if TRNG0_MCTL[PRGM] is 1. If TRNG0_MCTL[PRGM] is 0, this address is used as TRNG0_SCRxC4C readback register.

44.1.3.3.22.3 Diagram

| | | | | | | | | | | | | | | | | |
|-------|----------|----|----|----|----------|----|----|----|----|----|----|----|----|----|----|----|
| Bits | 31 | 30 | 29 | 28 | 27 | 26 | 25 | 24 | 23 | 22 | 21 | 20 | 19 | 18 | 17 | 16 |
| R | Reserved | | | | RUN4_RNG | | | | | | | | | | | |
| W | Reserved | | | | RUN4_RNG | | | | | | | | | | | |
| Reset | 0 | 0 | 0 | 0 | 0 | 0 | 0 | 0 | 0 | 1 | 0 | 0 | 0 | 0 | 0 | 0 |
| Bits | 15 | 14 | 13 | 12 | 11 | 10 | 9 | 8 | 7 | 6 | 5 | 4 | 3 | 2 | 1 | 0 |
| R | Reserved | | | | RUN4_MAX | | | | | | | | | | | |
| W | Reserved | | | | RUN4_MAX | | | | | | | | | | | |
| Reset | 0 | 0 | 0 | 0 | 0 | 0 | 0 | 0 | 0 | 1 | 0 | 0 | 1 | 0 | 1 | 1 |

44.1.3.3.22.4 Fields

| Field | Function |
|-------------------|--|
| 31-28 — | Reserved. Always 0. |
| 27-16 RUN4_RNG | Run Length 4 Range. The number of runs of length 4 (for both 0 and 1) detected during entropy generation must be greater than RUN4_MAX - RUN4_RNG, else a retry or error will occur. This register is cleared to the default POR value by writing the TRNG0_MCTL[RST_DEF] bit to 1. |
| 15-12 — | Reserved. Always 0. |
| 11-0 RUN4_MAX | Run Length 4 Maximum Limit. Defines the maximum allowable runs of length 4 (for both 0 and 1) detected during entropy generation. The number of runs of length 4 detected during entropy generation must be less than RUN4_MAX, else a retry or error will occur. This register is cleared to the default POR value by writing the TRNG0_MCTL[RST_DEF] bit to 1. |

44.1.3.3.23 TRNG0 Statistical Check Run Length 5 Count (TRNG0_SCR5C)

44.1.3.3.23.1 Address

| Register | Offset | Description |
|-------------|--------|---|
| TRNG0_SCR5C | 34h | Accessible at this address when TRNG0_MCTL[PRGM] = 0] |

44.1.3.3.23.2 Function

The TRNG0 Statistical Check Run Length 5 Counters Register is a read-only register used to read the final Run Length 5 counts after entropy generation. These counters start with the value in TRNG0_SCRxC5L[RUN5_MAX]. The R5_1_CT decrements each time five consecutive ones are sampled (preceded by a zero and followed by a zero). The R5_0_CT decrements each time five consecutive zeroes are sampled (preceded by a one and followed by a one). Note that this offset (0x34) is used as TRNG0_SCRxC5L if TRNG0_MCTL[PRGM] is 1. If TRNG0_MCTL[PRGM] is 0, this offset is used as TRNG0_SCRxC5C readback register, as described here.

44.1.3.3.23.3 Diagram

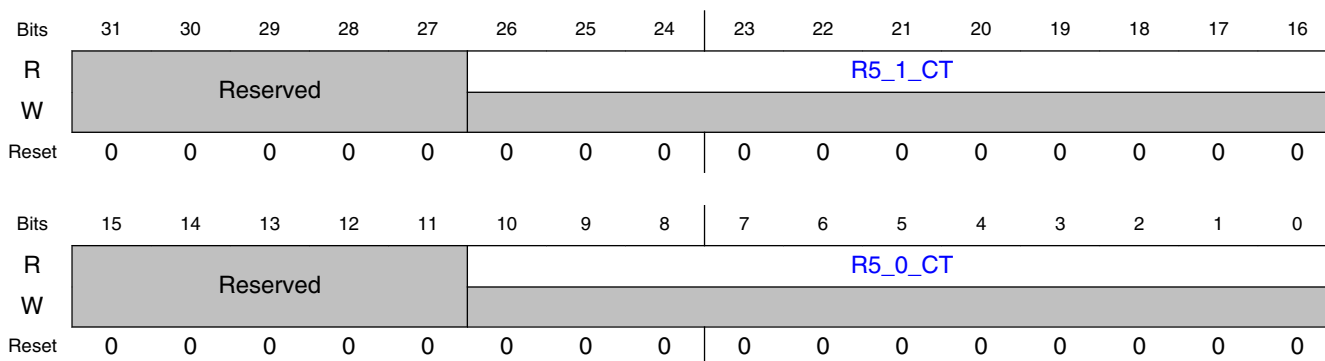

44.1.3.3.23.4 Fields

| Field | Function |
|------------------|---|
| 31-27 — | Reserved. Always 0. |
| 26-16 R5_1_CT | Runs of One, Length 5 Count. Reads the final Runs of Ones, length 5 count after entropy generation. Requires TRNG0_MCTL[PRGM] = 0. |
| 15-11 — | Reserved. Always 0. |
| 10-0 R5_0_CT | Runs of Zero, Length 5 Count. Reads the final Runs of Ones, length 5 count after entropy generation. Requires TRNG0_MCTL[PRGM] = 0. |

44.1.3.3.24 TRNG0 Statistical Check Run Length 5 Limit (TRNG0_SCR5L)

44.1.3.3.24.1 Address

| Register | Offset | Description |
|-------------|--------|---|
| TRNG0_SCR5L | 34h | Accessible at this address when TRNG0_MCTL[PRGM] = 1] |

44.1.3.3.24.2 Function

The TRNG0 Statistical Check Run Length 5 Limit Register defines the allowable maximum and minimum number of runs of length 5 detected during entropy generation. To pass the test, the number of runs of length 5 (for samples of both 0 and 1) must be less than the programmed maximum value, and the number of runs of length 5 must be greater than (maximum - range). If this test fails, the Retry Counter in TRNG0_SCMISC will be decremented, and a retry will occur if the Retry Count has not reached zero. If the Retry Count has reached zero, an error will be generated. Note that this address (0x34) is used as TRNG0_SCRxC5L only if TRNG0_MCTL[PRGM] is 1. If TRNG0_MCTL[PRGM] is 0, this address is used as TRNG0_SCRxC5C readback register.

44.1.3.3.24.3 Diagram

| | | | | | | | | | | | | | | | | |
|-------|----------|----|----|----|----|----|----|----|----------|----|----|----|----|----|----|----|
| Bits | 31 | 30 | 29 | 28 | 27 | 26 | 25 | 24 | 23 | 22 | 21 | 20 | 19 | 18 | 17 | 16 |
| R | Reserved | | | | | | | | RUN5_RNG | | | | | | | |
| W | Reserved | | | | | | | | RUN5_RNG | | | | | | | |
| Reset | 0 | 0 | 0 | 0 | 0 | 0 | 0 | 0 | 0 | 0 | 1 | 0 | 1 | 1 | 1 | 0 |
| Bits | 15 | 14 | 13 | 12 | 11 | 10 | 9 | 8 | 7 | 6 | 5 | 4 | 3 | 2 | 1 | 0 |
| R | Reserved | | | | | | | | RUN5_MAX | | | | | | | |
| W | Reserved | | | | | | | | RUN5_MAX | | | | | | | |
| Reset | 0 | 0 | 0 | 0 | 0 | 0 | 0 | 0 | 0 | 0 | 1 | 0 | 1 | 1 | 1 | 1 |

44.1.3.3.24.4 Fields

| Field | Function |
|-------------------|---|
| 31-27 — | Reserved. Always 0. |
| 26-16 RUN5_RNG | Run Length 5 Range. The number of runs of length 5 (for both 0 and 1) detected during entropy generation must be greater than RUN5_MAX - RUN5_RNG, else a retry or error will occur. This register is cleared to the default POR value by writing the TRNG0_MCTL[RST_DEF] bit to 1. |
| 15-11 | Reserved. Always 0. |

Table continues on the next page...

Standalone True Random Number Generator (SA-TRNG).

| Field | Function |
|------------------|--|
| — | |
| 10-0 RUN5_MAX | Run Length 5 Maximum Limit. Defines the maximum allowable runs of length 5 (for both 0 and 1) detected during entropy generation. The number of runs of length 5 detected during entropy generation must be less than RUN5_MAX, else a retry or error will occur. This register is cleared to the default POR value by writing the TRNG0_MCTL[RST_DEF] bit to 1. |

44.1.3.3.25 TRNG0 Statistical Check Run Length 6+ Count (TRNG0_SCR6PC)

44.1.3.3.25.1 Address

| Register | Offset | Description |
|--------------|--------|---|
| TRNG0_SCR6PC | 38h | Accessible at this address when TRNG0_MCTL[PRGM] = 0] |

44.1.3.3.25.2 Function

The TRNG0 Statistical Check Run Length 6+ Counters Register is a read-only register used to read the final Run Length 6+ counts after entropy generation. These counters start with the value in TRNG0_SCRxC6PL[RUN6P_MAX]. The R6P_1_CT decrements each time six or more consecutive ones are sampled (preceded by a zero and followed by a zero). The R6P_0_CT decrements each time six or more consecutive zeroes are sampled (preceded by a one and followed by a one). Note that this offset (0x38) is used as TRNG0_SCRxC6PL if TRNG0_MCTL[PRGM] is 1. If TRNG0_MCTL[PRGM] is 0, this offset is used as TRNG0_SCRxC6PC readback register, as described here.

44.1.3.3.25.3 Diagram

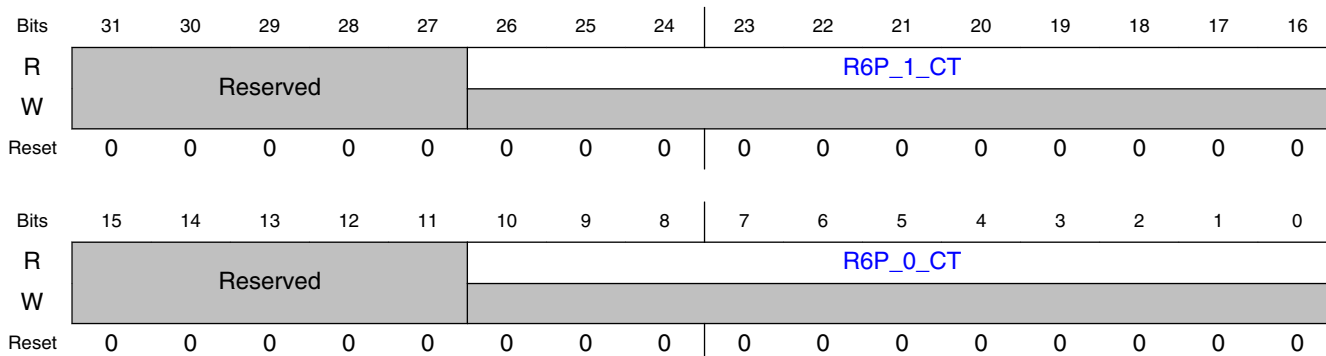

44.1.3.3.25.4 Fields

| Field | Function |
|-------------------|---|
| 31-27 — | Reserved. Always 0. |
| 26-16 R6P_1_CT | Runs of One, Length 6+ Count. Reads the final Runs of Ones, length 6+ count after entropy generation. Requires TRNG0_MCTL[PRGM] = 0. |
| 15-11 — | Reserved. Always 0. |
| 10-0 R6P_0_CT | Runs of Zero, Length 6+ Count. Reads the final Runs of Ones, length 6+ count after entropy generation. Requires TRNG0_MCTL[PRGM] = 0. |

44.1.3.3.26 TRNG0 Statistical Check Run Length 6+ Limit (TRNG0_SCR6PL)

44.1.3.3.26.1 Address

| Register | Offset | Description |
|--------------|--------|---|
| TRNG0_SCR6PL | 38h | Accessible at this address when TRNG0_MCTL[PRGM] = 1] |

44.1.3.3.26.2 Function

The TRNG0 Statistical Check Run Length 6+ Limit Register defines the allowable maximum and minimum number of runs of length 6 or more detected during entropy generation. To pass the test, the number of runs of length 6 or more (for samples of both 0 and 1) must be less than the programmed maximum value, and the number of runs of length 6 or more must be greater than (maximum - range). If this test fails, the Retry Counter in TRNG0_SCMISC will be decremented, and a retry will occur if the Retry Count has not reached zero. If the Retry Count has reached zero, an error will be generated. Note that this offset (0x38) is used as TRNG0_SCRxC6PL only if TRNG0_MCTL[PRGM] is 1. If TRNG0_MCTL[PRGM] is 0, this offset is used as TRNG0_SCRxC6PC readback register.

Standalone True Random Number Generator (SA-TRNG).

44.1.3.3.26.3 Diagram

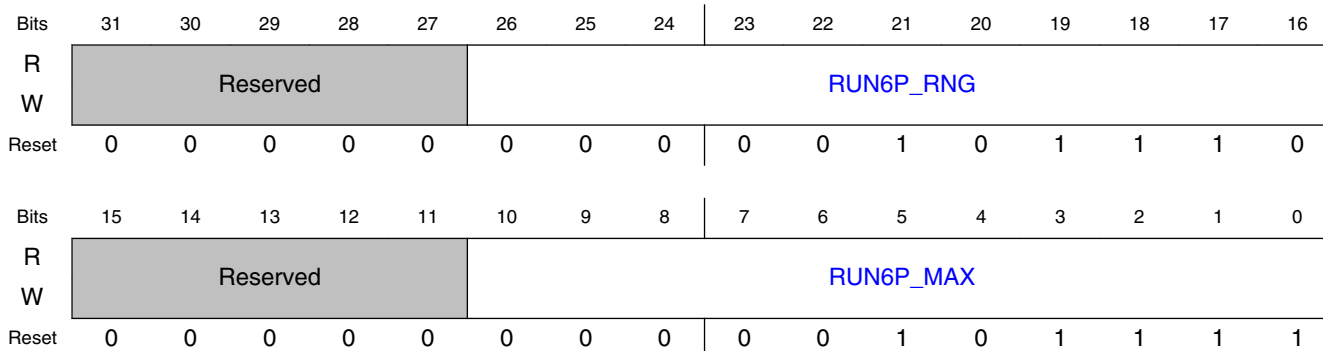

44.1.3.3.26.4 Fields

| Field | Function |
|--------------------|--|
| 31-27 — | Reserved. Always 0. |
| 26-16 RUN6P_RNG | Run Length 6+ Range. The number of runs of length 6 or more (for both 0 and 1) detected during entropy generation must be greater than RUN6P_MAX - RUN6P_RNG, else a retry or error will occur. This register is cleared to the default POR value by writing the TRNG0_MCTL[RST_DEF] bit to 1. |
| 15-11 — | Reserved. Always 0. |
| 10-0 RUN6P_MAX | Run Length 6+ Maximum Limit. Defines the maximum allowable runs of length 6 or more (for both 0 and 1) detected during entropy generation. The number of runs of length 6 or more detected during entropy generation must be less than RUN6P_MAX, else a retry or error will occur. This register is cleared to the default POR value by writing the TRNG0_MCTL[RST_DEF] bit to 1. |

44.1.3.3.27 TRNG0 Status (TRNG0_STATUS)

44.1.3.3.27.1 Address

| Register | Offset |
|--------------|--------|
| TRNG0_STATUS | 3Ch |

44.1.3.3.27.2 Function

Various statistical tests are run as a normal part of the TRNG's entropy generation process. The least-significant 16 bits of the TRNG0_STATUS register reflect the result of each of these tests. The status of these bits will be valid when the TRNG has finished its entropy generation process. Software can determine when this occurs by polling the ENT_VAL bit in the TRNG0 Miscellaneous Control Register.

Note that there is a very small probability that a statistical test will fail even though the TRNG is operating properly. If this happens the TRNG will automatically retry the entire entropy generation process, including running all the statistical tests. The value in RETRY_CT is decremented each time an entropy generation retry occurs. If a statistical check fails when the retry count is nonzero, a retry is initiated. But if a statistical check fails when the retry count is zero, an error is generated by the RNG. By default RETRY_CT is initialized to 1, but software can increase the retry count by writing to the RTY_CT field in the TRNG0_SCMISC register.

All 0s will be returned if this register address is read while the RNG is in Program Mode (see PRGM field in TRNG0_MCTL register. If this register is read while the RNG is in Run Mode the value returned will be formatted as follows.

44.1.3.3.27.3 Diagram

| | | | | | | | | | | | | | | | | |
|-------|----------|-----|------|------|-------------|-------------|------------|------------|------------|------------|------------|------------|------------|------------|------------|------------|
| Bits | 31 | 30 | 29 | 28 | 27 | 26 | 25 | 24 | 23 | 22 | 21 | 20 | 19 | 18 | 17 | 16 |
| R | Reserved | | | | | | | | | | | | RETRY_CT | | | |
| W | Reserved | | | | | | | | | | | | Reserved | | | |
| Reset | 0 | 0 | 0 | 0 | 0 | 0 | 0 | 0 | 0 | 0 | 0 | 0 | 0 | 0 | 0 | 0 |
| Bits | 15 | 14 | 13 | 12 | 11 | 10 | 9 | 8 | 7 | 6 | 5 | 4 | 3 | 2 | 1 | 0 |
| R | TFMB | TFP | TFLR | TFSB | TF6P BR1 | TF6P BR0 | TF5B R1 | TF5B R0 | TF4B R1 | TF4B R0 | TF3B R1 | TF3B R0 | TF2B R1 | TF2B R0 | TF1B R1 | TF1B R0 |
| W | Reserved | | | | | | | | | | | | | | | |
| Reset | 0 | 0 | 0 | 0 | 0 | 0 | 0 | 0 | 0 | 0 | 0 | 0 | 0 | 0 | 0 | 0 |

44.1.3.3.27.4 Fields

| Field | Function |
|-------------------|---|
| 31-20 — | Reserved. Always 0. |
| 19-16 RETRY_CT | RETRY COUNT. This represents the current number of entropy generation retries left before a statistical text failure will cause the RNG to generate an error condition. |
| 15 | Test Fail, Mono Bit. If TFMB=1, the Mono Bit Test has failed. |

Table continues on the next page...

Standalone True Random Number Generator (SA-TRNG).

| Field | Function |
|---------------|--|
| TFMB | |
| 14 TFP | Test Fail, Poker. If TFP=1, the Poker Test has failed. |
| 13 TFLR | Test Fail, Long Run. If TFLR=1, the Long Run Test has failed. |
| 12 TFSB | Test Fail, Sparse Bit. If TFSB=1, the Sparse Bit Test has failed. |
| 11 TF6PBR1 | Test Fail, 6 Plus Bit Run, Sampling 1s. If TF6PBR1=1, the 6 Plus Bit Run, Sampling 1s Test has failed. |
| 10 TF6PBR0 | Test Fail, 6 Plus Bit Run, Sampling 0s. If TF6PBR0=1, the 6 Plus Bit Run, Sampling 0s Test has failed. |
| 9 TF5BR1 | Test Fail, 5-Bit Run, Sampling 1s. If TF5BR1=1, the 5-Bit Run, Sampling 1s Test has failed. |
| 8 TF5BR0 | Test Fail, 5-Bit Run, Sampling 0s. If TF5BR0=1, the 5-Bit Run, Sampling 0s Test has failed. |
| 7 TF4BR1 | Test Fail, 4-Bit Run, Sampling 1s. If TF4BR1=1, the 4-Bit Run, Sampling 1s Test has failed. |
| 6 TF4BR0 | Test Fail, 4-Bit Run, Sampling 0s. If TF4BR0=1, the 4-Bit Run, Sampling 0s Test has failed. |
| 5 TF3BR1 | Test Fail, 3-Bit Run, Sampling 1s. If TF3BR1=1, the 3-Bit Run, Sampling 1s Test has failed. |
| 4 TF3BR0 | Test Fail, 3-Bit Run, Sampling 0s. If TF3BR0=1, the 3-Bit Run, Sampling 0s Test has failed. |
| 3 TF2BR1 | Test Fail, 2-Bit Run, Sampling 1s. If TF2BR1=1, the 2-Bit Run, Sampling 1s Test has failed. |
| 2 TF2BR0 | Test Fail, 2-Bit Run, Sampling 0s. If TF2BR0=1, the 2-Bit Run, Sampling 0s Test has failed. |
| 1 TF1BR1 | Test Fail, 1-Bit Run, Sampling 1s. If TF1BR1=1, the 1-Bit Run, Sampling 1s Test has failed. |
| 0 TF1BR0 | Test Fail, 1-Bit Run, Sampling 0s. If TF1BR0=1, the 1-Bit Run, Sampling 0s Test has failed. |

44.1.3.3.28 TRNG0 Entropy Read (TRNG0_ENTa)

44.1.3.3.28.1 Address

For a = 0 to 15:

| Register | Offset | Description |
|------------|----------------|-------------|
| TRNG0_ENTa | 40h + (a × 4h) | Word a |

44.1.3.3.28.2 Function

The RNG TRNG can be programmed to generate an entropy value that is readable via the SkyBlue bus. To do this, set the TRNG0_MCTL[TRNG_ACC] bit to 1. Once the entropy value has been generated, the TRNG0_MCTL[ENT_VAL] bit will be set to 1. At this point, TRNG0_ENT0 through TRNG0_ENT15 may be read to retrieve the 512-bit entropy value. Note that once TRNG0_ENT15 is read, the entropy value will be cleared and a new value will begin generation, so it is important that TRNG0_ENT15 be read last. These registers are readable only when TRNG0_MCTL[PRGM] = 0 (Run Mode), TRNG0_MCTL[TRNG_ACC] = 1 (TRNG access mode) and TRNG0_MCTL[ENT_VAL] = 1. After at most one (1) bus clock cycle of reading a valid TRNG0_ENT15 register value, reading any TRNG0_ENT0 through TRNG0_ENT15 register would return zeroes.

44.1.3.3.28.3 Diagram

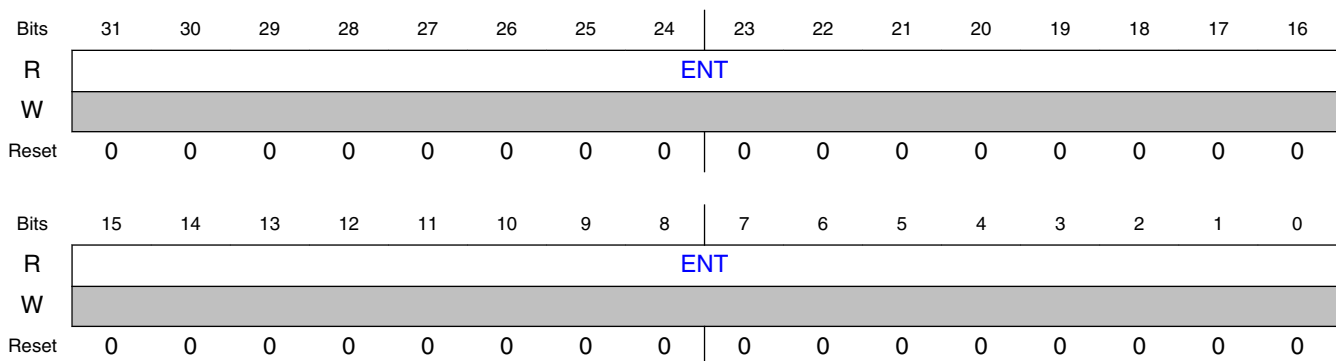

44.1.3.3.28.4 Fields

| Field | Function |
|-------------|---|
| 31-0 ENT | Entropy Value. Will be non-zero only if TRNG0_MCTL[PRGM] = 0 (Run Mode) and TRNG0_MCTL[ENT_VAL] = 1 (Entropy Valid). The most significant bits of the entropy are read from the lowest offset, and the least significant bits are read from the highest offset. Note that reading the highest offset also clears the entire entropy value, and starts a new entropy generation. |

44.1.3.3.29 TRNG0 Statistical Check Poker Count 1 and 0 (TRNG0_PKRCNT10)

44.1.3.3.29.1 Address

| Register | Offset |
|----------------|--------|
| TRNG0_PKRCNT10 | 80h |

44.1.3.3.29.2 Function

The TRNG0 Statistical Check Poker Count 1 and 0 Register is a read-only register used to read the final Poker test counts of 1h and 0h patterns. The Poker 0h Count increments each time a nibble of sample data is found to be 0h. The Poker 1h Count increments each time a nibble of sample data is found to be 1h. Note that this register is readable only if TRNG0_MCTL[PRGM] is 0, otherwise zeroes will be read.

44.1.3.3.29.3 Diagram

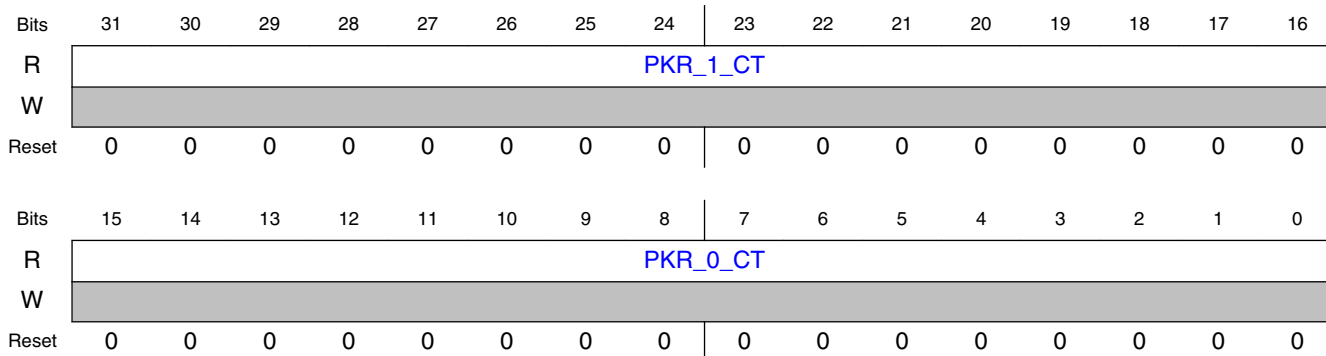

44.1.3.3.29.4 Fields

| Field | Function |
|-------------------|--|
| 31-16 PKR_1_CT | Poker 1h Count. Total number of nibbles of sample data which were found to be 1h. Requires TRNG0_MCTL[PRGM] = 0. |
| 15-0 PKR_0_CT | Poker 0h Count. Total number of nibbles of sample data which were found to be 0h. Requires TRNG0_MCTL[PRGM] = 0. |

44.1.3.3.30 TRNG0 Statistical Check Poker Count 3 and 2 (TRNG0_PKRCNT32)

44.1.3.3.30.1 Address

| Register | Offset |
|----------------|--------|
| TRNG0_PKRCNT32 | 84h |

44.1.3.3.30.2 Function

The TRNG0 Statistical Check Poker Count 3 and 2 Register is a read-only register used to read the final Poker test counts of 3h and 2h patterns. The Poker 2h Count increments each time a nibble of sample data is found to be 2h. The Poker 3h Count increments each time a nibble of sample data is found to be 3h. Note that this register is readable only if TRNG0_MCTL[PRGM] is 0, otherwise zeroes will be read.

44.1.3.3.30.3 Diagram

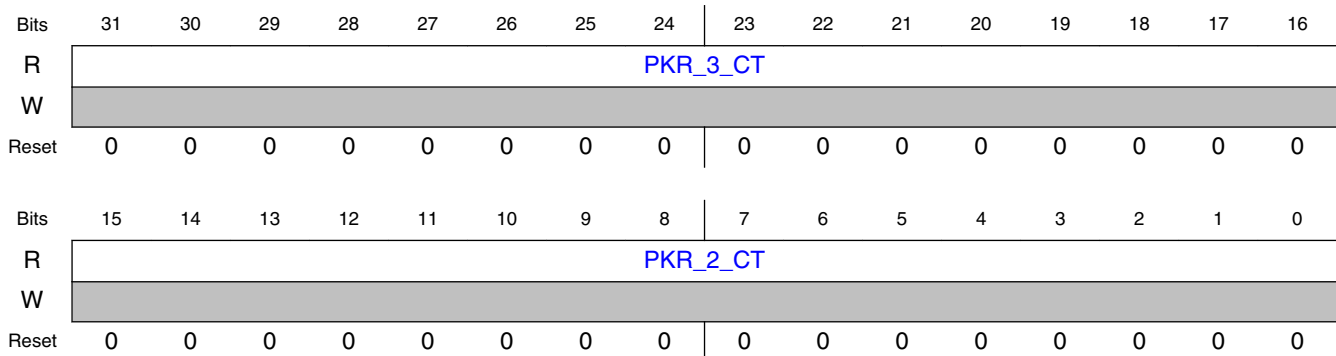

44.1.3.3.30.4 Fields

| Field | Function |
|-------------------|--|
| 31-16 PKR_3_CT | Poker 3h Count. Total number of nibbles of sample data which were found to be 3h. Requires TRNG0_MCTL[PRGM] = 0. |
| 15-0 PKR_2_CT | Poker 2h Count. Total number of nibbles of sample data which were found to be 2h. Requires TRNG0_MCTL[PRGM] = 0. |

44.1.3.3.31 TRNG0 Statistical Check Poker Count 5 and 4 (TRNG0_PKRCNT54)

44.1.3.3.31.1 Address

| Register | Offset |
|----------------|--------|
| TRNG0_PKRCNT54 | 88h |

44.1.3.3.31.2 Function

The TRNG0 Statistical Check Poker Count 5 and 4 Register is a read-only register used to read the final Poker test counts of 5h and 4h patterns. The Poker 4h Count increments each time a nibble of sample data is found to be 4h. The Poker 5h Count increments each time a nibble of sample data is found to be 5h. Note that this register is readable only if TRNG0_MCTL[PRGM] is 0, otherwise zeroes will be read.

44.1.3.3.31.3 Diagram

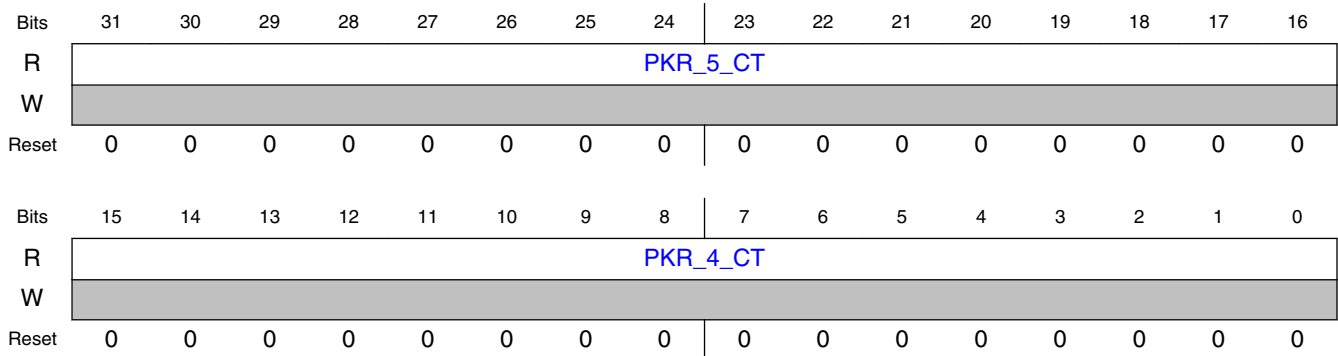

44.1.3.3.31.4 Fields

| Field | Function |
|-------------------|--|
| 31-16 PKR_5_CT | Poker 5h Count. Total number of nibbles of sample data which were found to be 5h. Requires TRNG0_MCTL[PRGM] = 0. |
| 15-0 PKR_4_CT | Poker 4h Count. Total number of nibbles of sample data which were found to be 4h. Requires TRNG0_MCTL[PRGM] = 0. |

44.1.3.3.32 TRNG0 Statistical Check Poker Count 7 and 6 (TRNG0_PKRCNT76)

44.1.3.3.32.1 Address

| Register | Offset |
|----------------|--------|
| TRNG0_PKRCNT76 | 8Ch |

44.1.3.3.32.2 Function

The TRNG0 Statistical Check Poker Count 7 and 6 Register is a read-only register used to read the final Poker test counts of 7h and 6h patterns. The Poker 6h Count increments each time a nibble of sample data is found to be 6h. The Poker 7h Count increments each time a nibble of sample data is found to be 7h. Note that this register is readable only if TRNG0_MCTL[PRGM] is 0, otherwise zeroes will be read.

44.1.3.3.32.3 Diagram

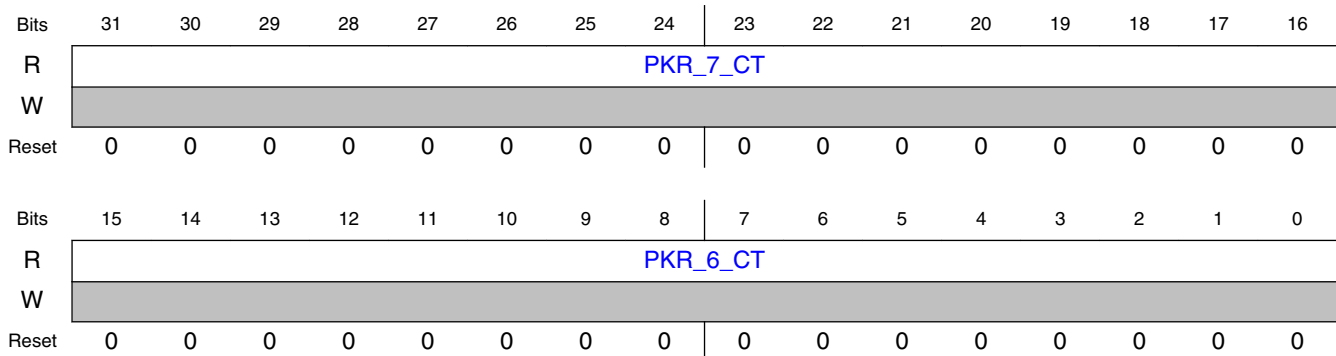

44.1.3.3.32.4 Fields

| Field | Function |
|-------------------|--|
| 31-16 PKR_7_CT | Poker 7h Count. Total number of nibbles of sample data which were found to be 7h. Requires TRNG0_MCTL[PRGM] = 0. |
| 15-0 PKR_6_CT | Poker 6h Count. Total number of nibbles of sample data which were found to be 6h. Requires TRNG0_MCTL[PRGM] = 0. |

44.1.3.3.33 TRNG0 Statistical Check Poker Count 9 and 8 (TRNG0_PKRCNT98)

44.1.3.3.33.1 Address

| Register | Offset |
|----------------|--------|
| TRNG0_PKRCNT98 | 90h |

44.1.3.3.33.2 Function

The TRNG0 Statistical Check Poker Count 9 and 8 Register is a read-only register used to read the final Poker test counts of 9h and 8h patterns. The Poker 8h Count increments each time a nibble of sample data is found to be 8h. The Poker 9h Count increments each time a nibble of sample data is found to be 9h. Note that this register is readable only if TRNG0_MCTL[PRGM] is 0, otherwise zeroes will be read.

44.1.3.3.33.3 Diagram

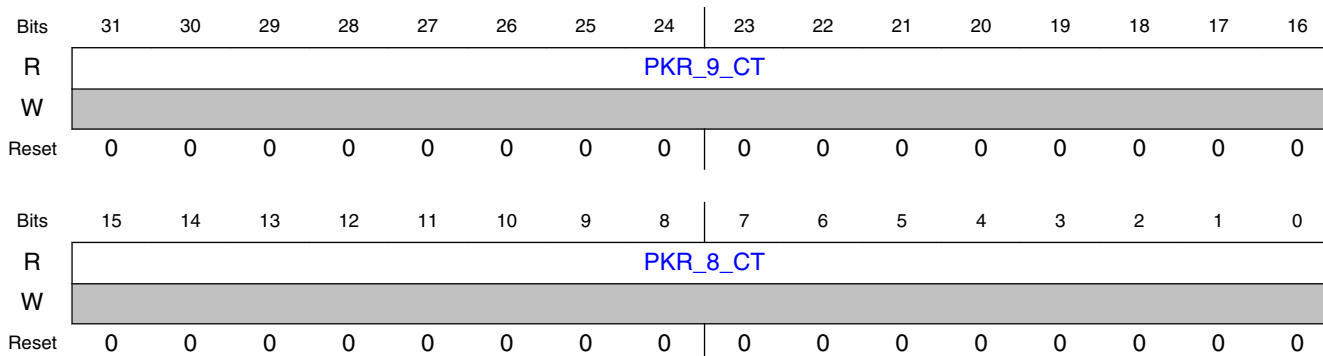

44.1.3.3.33.4 Fields

| Field | Function |
|-------------------|--|
| 31-16 PKR_9_CT | Poker 9h Count. Total number of nibbles of sample data which were found to be 9h. Requires TRNG0_MCTL[PRGM] = 0. |
| 15-0 PKR_8_CT | Poker 8h Count. Total number of nibbles of sample data which were found to be 8h. Requires TRNG0_MCTL[PRGM] = 0. |

44.1.3.3.34 TRNG0 Statistical Check Poker Count B and A (TRNG0_PKRCNTBA)

44.1.3.3.34.1 Address

| Register | Offset |
|----------------|--------|
| TRNG0_PKRCNTBA | 94h |

44.1.3.3.34.2 Function

The TRNG0 Statistical Check Poker Count B and A Register is a read-only register used to read the final Poker test counts of Bh and Ah patterns. The Poker Ah Count increments each time a nibble of sample data is found to be Ah. The Poker Bh Count increments each time a nibble of sample data is found to be Bh. Note that this register is readable only if TRNG0_MCTL[PRGM] is 0, otherwise zeroes will be read.

44.1.3.3.34.3 Diagram

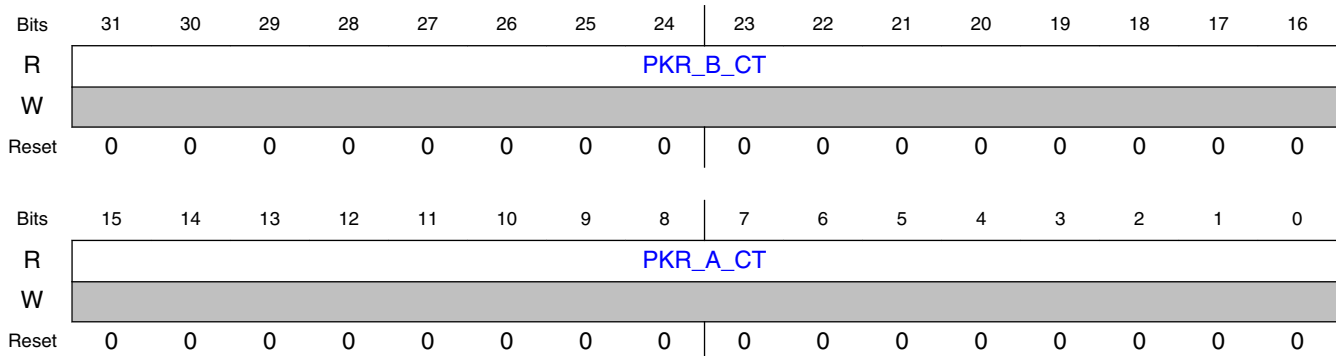

44.1.3.3.34.4 Fields

| Field | Function |
|-------------------|--|
| 31-16 PKR_B_CT | Poker Bh Count. Total number of nibbles of sample data which were found to be Bh. Requires TRNG0_MCTL[PRGM] = 0. |
| 15-0 PKR_A_CT | Poker Ah Count. Total number of nibbles of sample data which were found to be Ah. Requires TRNG0_MCTL[PRGM] = 0. |

44.1.3.3.35 TRNG0 Statistical Check Poker Count D and C (TRNG0_PKRCNTDC)

44.1.3.3.35.1 Address

| Register | Offset |
|----------------|--------|
| TRNG0_PKRCNTDC | 98h |

44.1.3.3.35.2 Function

The TRNG0 Statistical Check Poker Count D and C Register is a read-only register used to read the final Poker test counts of Dh and Ch patterns. The Poker Ch Count increments each time a nibble of sample data is found to be Ch. The Poker Dh Count increments each time a nibble of sample data is found to be Dh. Note that this register is readable only if TRNG0_MCTL[PRGM] is 0, otherwise zeroes will be read.

44.1.3.3.35.3 Diagram

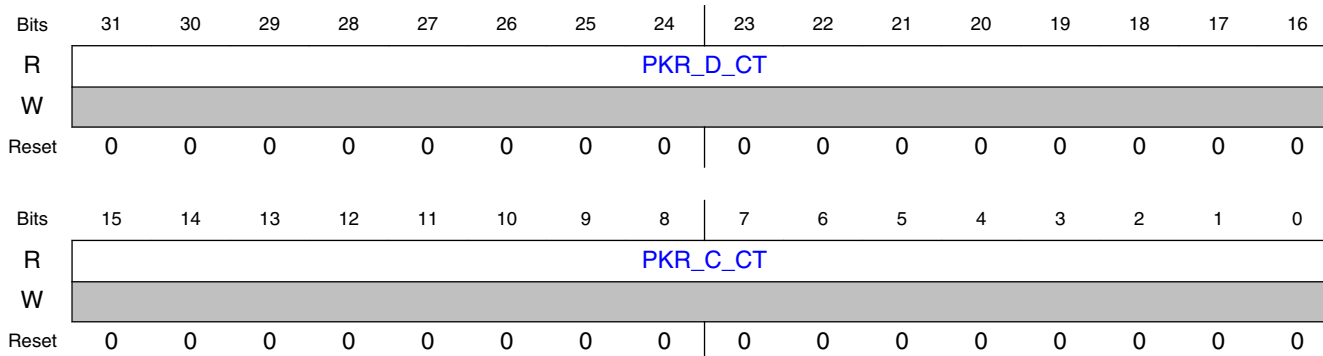

44.1.3.3.35.4 Fields

| Field | Function |
|-------------------|--|
| 31-16 PKR_D_CT | Poker Dh Count. Total number of nibbles of sample data which were found to be Dh. Requires TRNG0_MCTL[PRGM] = 0. |
| 15-0 PKR_C_CT | Poker Ch Count. Total number of nibbles of sample data which were found to be Ch. Requires TRNG0_MCTL[PRGM] = 0. |

44.1.3.3.36 TRNG0 Statistical Check Poker Count F and E (TRNG0_PKRCNTFE)

44.1.3.3.36.1 Address

| Register | Offset |
|----------------|--------|
| TRNG0_PKRCNTFE | 9Ch |

44.1.3.3.36.2 Function

The TRNG0 Statistical Check Poker Count F and E Register is a read-only register used to read the final Poker test counts of Fh and Eh patterns. The Poker Eh Count increments each time a nibble of sample data is found to be Eh. The Poker Fh Count increments each time a nibble of sample data is found to be Fh. Note that this register is readable only if TRNG0_MCTL[PRGM] is 0, otherwise zeroes will be read.

44.1.3.3.36.3 Diagram

| | | | | | | | | | | | | | | | | | |
|-------|----------|----|----|----|----|----|----|----|--|----|----|----|----|----|----|----|----|
| Bits | 31 | 30 | 29 | 28 | 27 | 26 | 25 | 24 | | 23 | 22 | 21 | 20 | 19 | 18 | 17 | 16 |
| R | PKR_F_CT | | | | | | | | | | | | | | | | |
| W | | | | | | | | | | | | | | | | | |
| Reset | 0 | 0 | 0 | 0 | 0 | 0 | 0 | 0 | | 0 | 0 | 0 | 0 | 0 | 0 | 0 | 0 |
| Bits | 15 | 14 | 13 | 12 | 11 | 10 | 9 | 8 | | 7 | 6 | 5 | 4 | 3 | 2 | 1 | 0 |
| R | PKR_E_CT | | | | | | | | | | | | | | | | |
| W | | | | | | | | | | | | | | | | | |
| Reset | 0 | 0 | 0 | 0 | 0 | 0 | 0 | 0 | | 0 | 0 | 0 | 0 | 0 | 0 | 0 | 0 |

44.1.3.3.36.4 Fields

| Field | Function |
|-------------------|--|
| 31-16 PKR_F_CT | Poker Fh Count. Total number of nibbles of sample data which were found to be Fh. Requires TRNG0_MCTL[PRGM] = 0. |
| 15-0 PKR_E_CT | Poker Eh Count. Total number of nibbles of sample data which were found to be Eh. Requires TRNG0_MCTL[PRGM] = 0. |

44.1.3.3.37 TRNG0 Security Configuration (TRNG0_SEC_CFG)

44.1.3.3.37.1 Address

| Register | Offset |
|---------------|--------|
| TRNG0_SEC_CFG | B0h |

44.1.3.3.37.2 Function

The TRNG0 Security Configuration Register is a read/write register used to control the test mode, programmability and state modes of the TRNG0. Many bits are place holders for this version. More configurability will be added here. Clears on asynchronous reset. For TRNG0 releases before 2014/July/01, offsets 0xA0 to 0xAC used to be 0xB0 to 0xBC respectively. So, update newer tests that use these registers, if hard coded.

44.1.3.3.37.3 Diagram

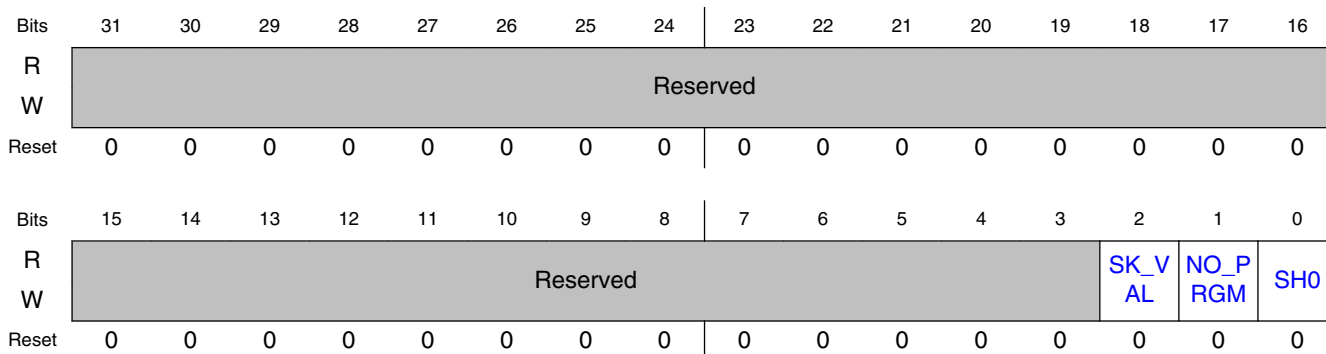

44.1.3.3.37.4 Fields

| Field | Function |
|--------------|--|
| 31-3 — | Reserved. |
| 2 SK_VAL | Reserved. DRNG-specific, not applicable to this version. 0 - See DRNG version. 1 - See DRNG version. |
| 1 NO_PRGM | If set, the TRNG registers cannot be programmed. That is, regardless of the TRNG access mode in the TRNG0 Miscellaneous Control Register. 0 - Programmability of registers controlled only by the TRNG0 Miscellaneous Control Register's access mode bit. 1 - Overrides TRNG0 Miscellaneous Control Register access mode and prevents TRNG register programming. |
| 0 SH0 | Reserved. DRNG specific, not applicable to this version. 0 - See DRNG version. 1 - See DRNG version. |

44.1.3.3.38 TRNG0 Interrupt Control (TRNG0_INT_CTRL)

44.1.3.3.38.1 Address

| Register | Offset |
|----------------|--------|
| TRNG0_INT_CTRL | B4h |

44.1.3.3.38.2 Function

The TRNG0 Interrupt Control Register is a read/write register used to control the status for the (currently) three important interrupts that are generated by the TRNG. See TRNG0_INT_STATUS register description above. Each interrupt can be cleared by de-asserting the corresponding bit in the TRNG0_INT_CTRL register. Only a new interrupt will reassert the corresponding bit in the status register. Even if the interrupt is cleared or masked, interrupt status information can be read from the TRNG0_MCTL register.

44.1.3.3.38.3 Diagram

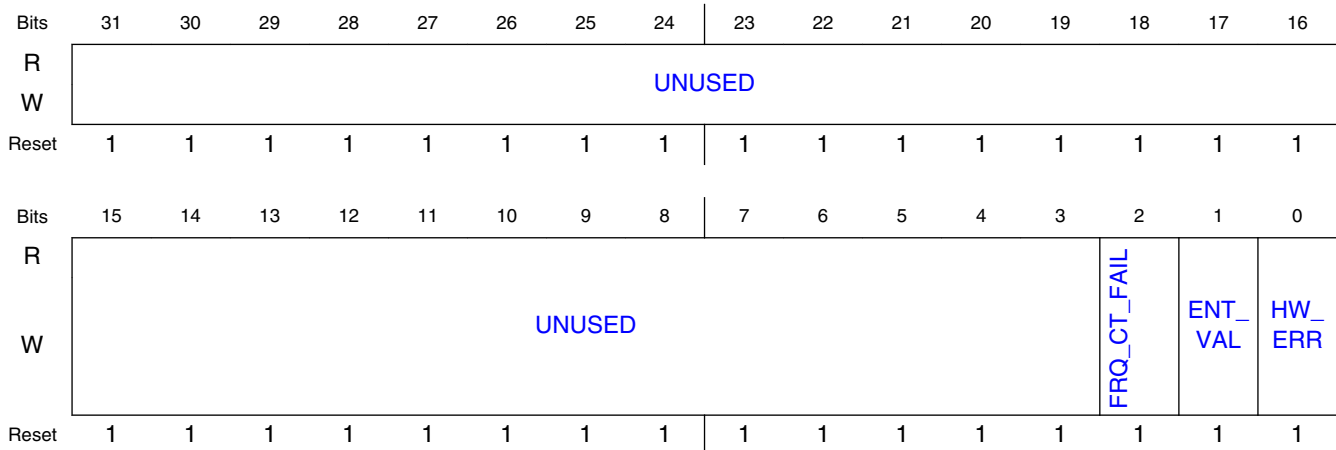

44.1.3.3.38.4 Fields

| Field | Function |
|------------------|--|
| 31-3 UNUSED | Reserved but writeable. |
| 2 FRQ_CT_FAIL | Same behavior as bit 0 above. 0 - Same behavior as bit 0 above. |

Table continues on the next page...

Standalone True Random Number Generator (SA-TRNG).

| Field | Function |
|--------------|---|
| | 1 - Same behavior as bit 0 above. |
| 1 ENT_VAL | Same behavior as bit 0 above. 0 - Same behavior as bit 0 above. 1 - Same behavior as bit 0 above. |
| 0 HW_ERR | Bit position that can be cleared if corresponding bit of TRNG0_INT_STATUS has been asserted. 0 - Corresponding bit of TRNG0_INT_STATUS cleared. 1 - Corresponding bit of TRNG0_INT_STATUS active. |

44.1.3.3.39 TRNG0 Mask (TRNG0_INT_MASK)

44.1.3.3.39.1 Address

| Register | Offset |
|----------------|--------|
| TRNG0_INT_MASK | B8h |

44.1.3.3.39.2 Function

The TRNG0 Interrupt Mask Register is a read/write register used to disable/mask the status reporting of the (currently) three important interrupts that are generated by the TRNG. See TRNG0_INT_STATUS register description above. Each interrupt can be masked/disabled by de-asserting the corresponding bit in the TRNG0_INT_MASK register. Only setting this bit high will re-enable the interrupt in the status register. Even if the interrupt is cleared or masked, interrupt status information can be read from the TRNG0_MCTL register.

44.1.3.3.39.3 Diagram

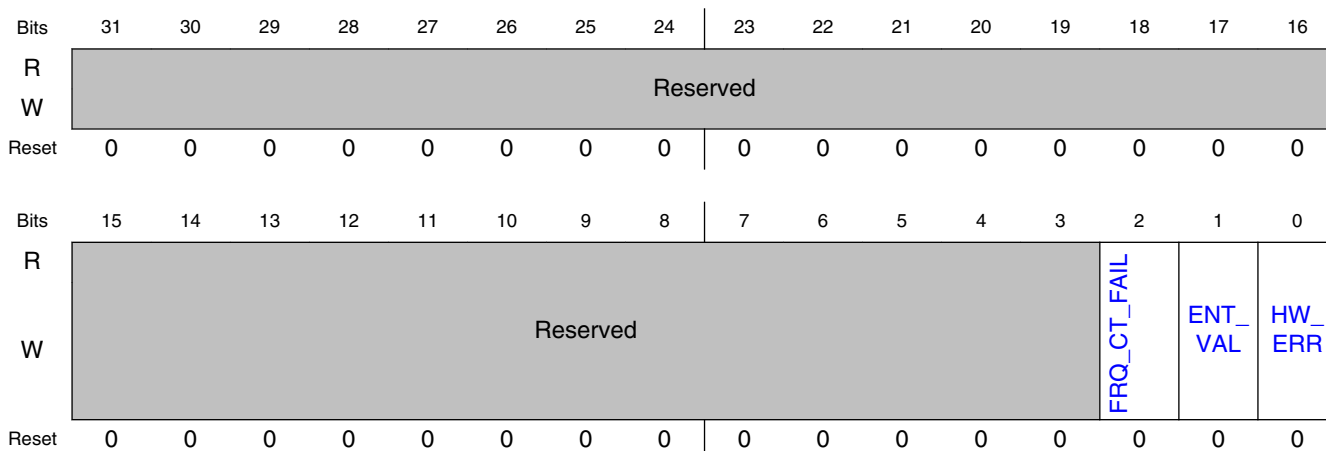

44.1.3.3.39.4 Fields

| Field | Function |
|------------------|--|
| 31-3 — | Reserved. |
| 2 FRQ_CT_FAIL | Same behavior as bit 0 above. 0 - Same behavior as bit 0 above. 1 - Same behavior as bit 0 above. |
| 1 ENT_VAL | Same behavior as bit 0 above. 0 - Same behavior as bit 0 above. 1 - Same behavior as bit 0 above. |
| 0 HW_ERR | Bit position that can be cleared if corresponding bit of TRNG0_INT_STATUS has been asserted. 0 - Corresponding interrupt of TRNG0_INT_STATUS is masked. 1 - Corresponding bit of TRNG0_INT_STATUS is active. |

44.1.3.3.40 TRNG0 Interrupt Status (TRNG0_INT_STATUS)

44.1.3.3.40.1 Address

| Register | Offset |
|------------------|--------|
| TRNG0_INT_STATUS | BCh |

44.1.3.3.40.2 Function

The TRNG0 Interrupt Status Register is a read register used to control and provide status for the (currently) three important interrupts that are generated by the TRNG. The `ipi_rng_int_b` interrupt signals that TRNG0 has either generated a Frequency Count Fail, Entropy Valid or Error Interrupt. The cause of the interrupt can be decoded by checking the least significant bits of the TRNG0_INT_STATUS register. Each interrupt can be temporarily cleared by de-asserting the corresponding bit in the TRNG0_INT_CTRL register. To mask the interrupts, clear the corresponding bits in the TRNG0_INT_MASK register. The description of each of the 3 interrupts is defined in the Block Guide under the TRNG0_MCTL register description. Even if the interrupt is cleared or masked, interrupt status information can be read from the TRNG0_MCTL register.

Standalone True Random Number Generator (SA-TRNG).

44.1.3.3.40.3 Diagram

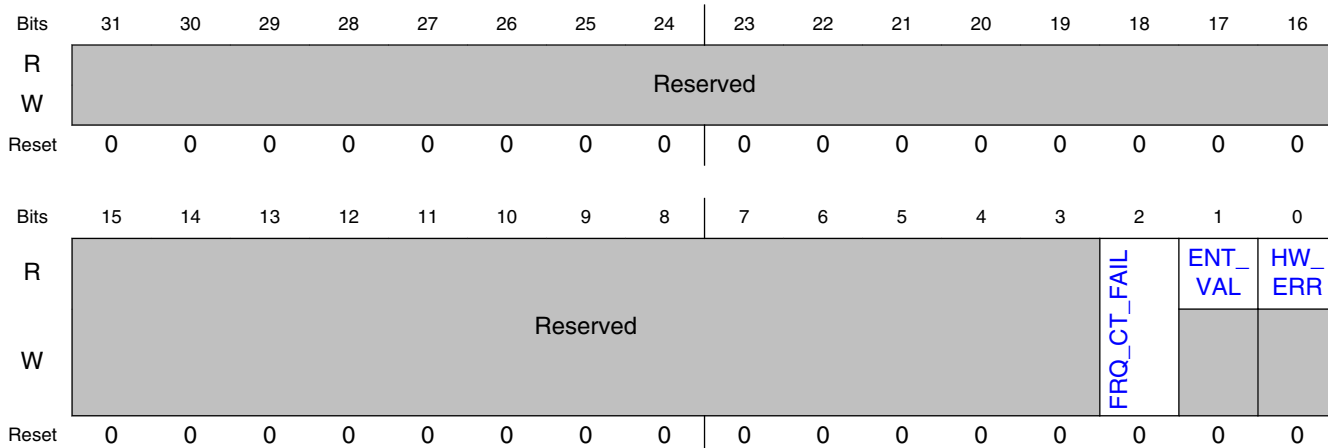

44.1.3.3.40.4 Fields

| Field | Function |
|------------------|--|
| 31-3 — | Reserved. |
| 2 FRQ_CT_FAIL | Read only: Frequency Count Fail. The frequency counter has detected a failure. This may be due to improper programming of the TRNG0_FRQMAX and/or TRNG0_FRQMIN registers, or a hardware failure in the ring oscillator. 0 - No hardware nor self test frequency errors. 1 - The frequency counter has detected a failure. |
| 1 ENT_VAL | Read only: Entropy Valid. Will assert only if TRNG ACC bit is set, and then after an entropy value is generated. Will be cleared when TRNG0_ENT15 is read. (TRNG0_ENT0 through TRNG0_ENT14 should be read before reading TRNG0_ENT15). 0 - Busy generation entropy. Any value read is invalid. 1 - TRNG can be stopped and entropy is valid if read. |
| 0 HW_ERR | Read: Error status. 1 = error detected. 0 = no error. Any HW error in the TRNG will trigger this interrupt. 0 - no error 1 - error detected. |

44.1.3.3.41 TRNG0 Version ID (MS) (TRNG0_VID1)

44.1.3.3.41.1 Address

| Register | Offset |
|------------|--------|
| TRNG0_VID1 | F0h |

44.1.3.3.41.2 Function

The TRNG0 Version ID Register is a read only register used to identify the version of the TRNG in use. This register as well as TRNG0_VID2 should both be read to verify the expected version.

44.1.3.3.41.3 Diagram

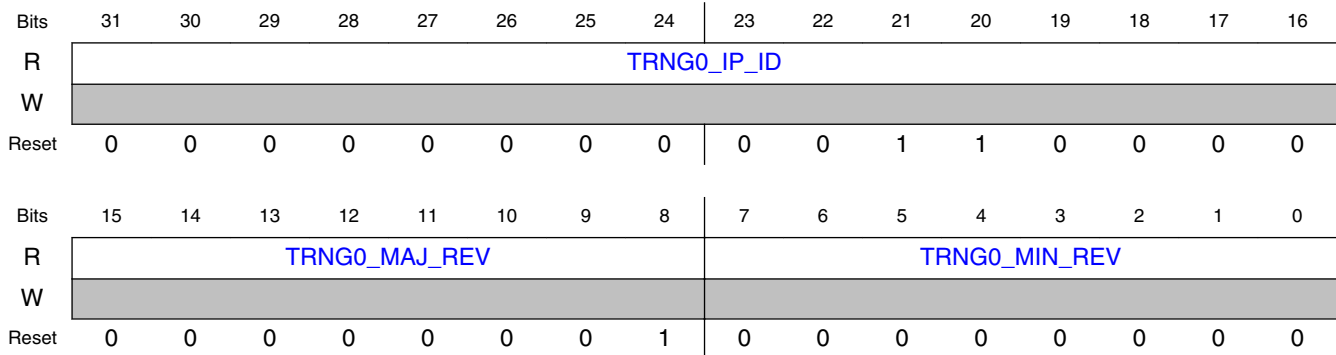

44.1.3.3.41.4 Fields

| Field | Function |
|-----------------------|--|
| 31-16 TRNG0_IP_ID | Shows the Freescale IP ID. 000000000110000 - ID for TRNG. |
| 15-8 TRNG0_MAJ_REV | Shows the Freescale IP's Major revision of the TRNG. 00000001 - Major revision number for TRNG. |
| 7-0 TRNG0_MIN_REV | Shows the Freescale IP's Minor revision of the TRNG. 00000000 - Minor revision number for TRNG. |

44.1.3.3.42 TRNG0 Version ID (LS) (TRNG0_VID2)

44.1.3.3.42.1 Address

| Register | Offset |
|------------|--------|
| TRNG0_VID2 | F4h |

44.1.3.3.42.2 Function

The TRNG0 Version ID Register LSB is a read only register used to identify the architecture of the TRNG in use. This register as well as TRNG0_VID1 should both be read to verify the expected version.

44.1.3.3.42.3 Diagram

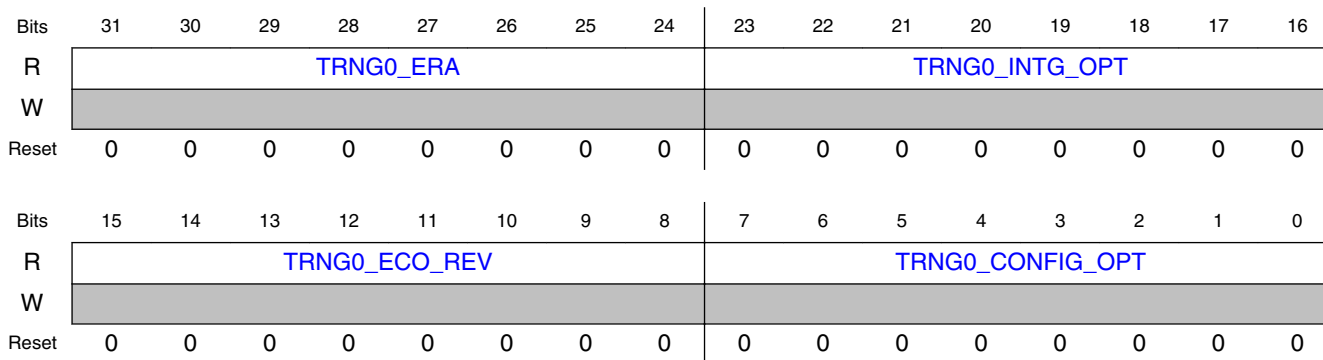

44.1.3.3.42.4 Fields

| Field | Function |
|-------------------------|--|
| 31-24 TRNG0_ERA | Shows the Freescale compile options for the TRNG. 00000000 - COMPILE_OPT for TRNG. |
| 23-16 TRNG0_INTG_OPT | Shows the Freescale integration options for the TRNG. 00000000 - INTG_OPT for TRNG. |
| 15-8 TRNG0_ECO_REV | Shows the Freescale IP's ECO revision of the TRNG. 00000000 - TRNG_ECO_REV for TRNG. |
| 7-0 TRNG0_CONFIG_OPT | Shows the Freescale IP's Configuration options for the TRNG. 00000000 - TRNG_CONFIG_OPT for TRNG. |

44.1.4 Another TRNG usage example.

The TRNG can be used by a post processing pseudo-random number generator function. For example, TRNG can be used to seed a hardware or software based implementation of a DRBG defined by SP800-90.

Chapter 45

2.4 GHz Multi-Protocol Radio

45.1 Introduction

This document describes the 2nd generation 2.4 GHz Multi-Protocol Radio capable of supporting the modes described below in the 2.4 GHz ISM band.

- IEEE Std. 802.15.1 v4.2 Bluetooth Low Energy (BLE) single-mode device operation
- IEEE Std. 802.15.4j-2012 in Medical Body Area Network (MBAN) frequency bands spanning from 2360 MHz to 2400 MHz
- Generic FSK at 1Mbps, 500Kbps, or 250Kbps
- Concurrent 802.15.4 and BLE operation

The Radio is comprised of a Constant-Envelope Transmitter and a Quadrature Zero-IF Receiver.

The Radio block diagram is provided for illustration of the internal organization of the radio.

2.4GHZ RADIO HIERARCHY DIAGRAM

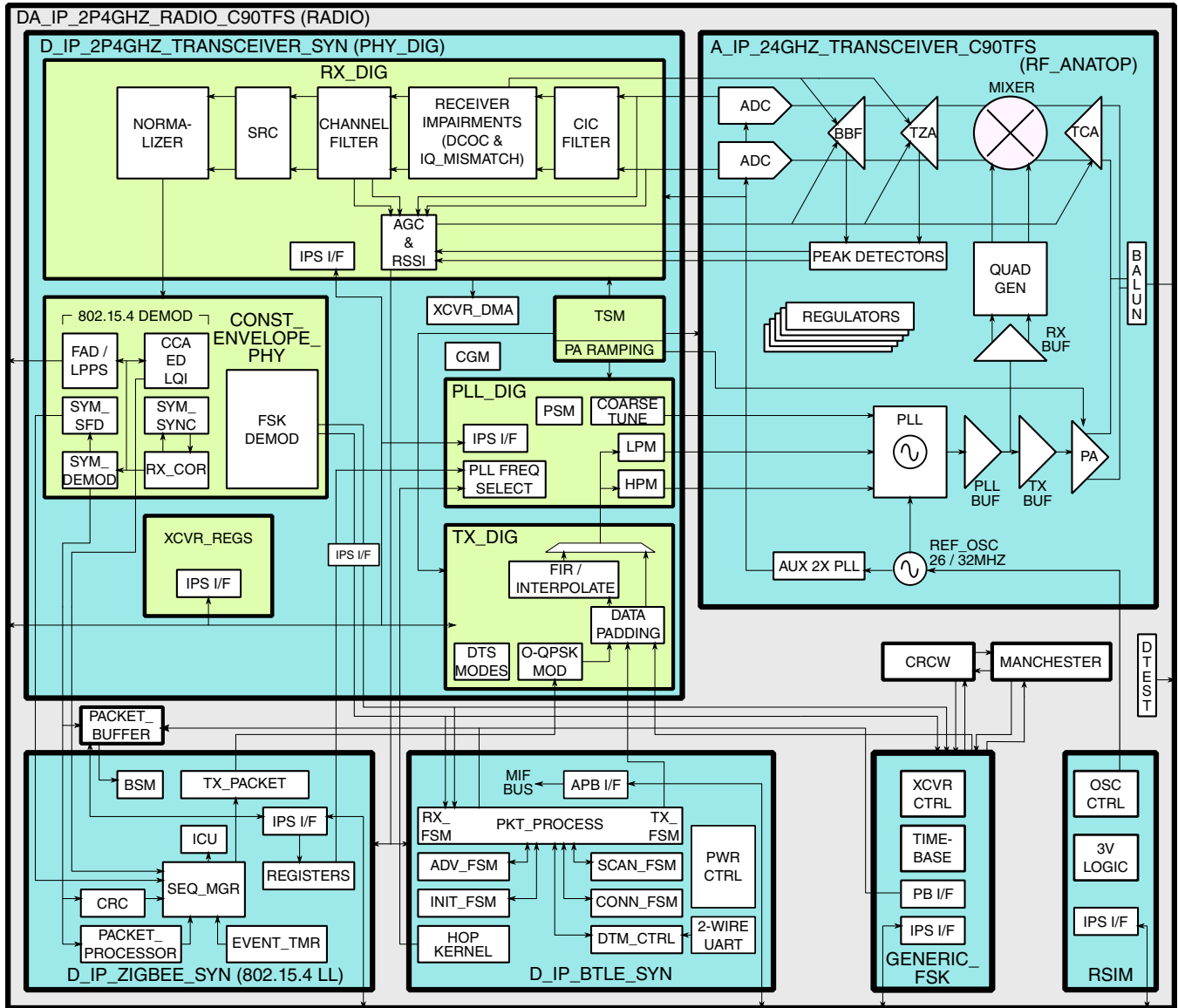

Figure 45-1. Radio Block diagram

45.2 Radio Register Overview

NOTE

This chapter is a duplicate copy of all the radio registers.

45.2.1 RSIM Memory Map and Register Definition

The RSIM memory map and description of registers are included in the following register section.

45.2.1.1 RSIM Register Descriptions

45.2.1.1.1 RSIM Memory Map

Base address: 40059000h

| Offset | Register | Width (In bits) | Access | Reset value |
|-----------|--|--------------------|--------|-------------|
| 40059000h | Radio System Control (CONTROL) | 32 | RW | 00C00002h |
| 40059004h | Radio Active Early Warning (ACTIVE_DELAY) | 32 | RW | 00000000h |
| 40059008h | Radio MAC Address (MAC_MSB) | 32 | RO | 00000000h |
| 4005900Ch | Radio MAC Address (MAC_LSB) | 32 | RO | 00000000h |
| 40059100h | Deep Sleep Timer (DSM_TIMER) | 32 | RO | 00000000h |
| 40059104h | Deep Sleep Timer Control (DSM_CONTROL) | 32 | RW | 00000000h |
| 40059108h | Deep Sleep Wakeup Time Offset (DSM_OSC_OFFSET) | 32 | RW | 00000000h |
| 40059114h | 802.15.4 Link Layer Sleep Time (ZIG_SLEEP) | 32 | RW | 00000000h |
| 40059118h | 802.15.4 Link Layer Wake Time (ZIG_WAKE) | 32 | RW | 00000000h |
| 4005911Ch | Generic FSK Link Layer Sleep Time (GEN_SLEEP) | 32 | RW | 00000000h |
| 40059120h | Generic FSK Link Layer Wake Time (GEN_WAKE) | 32 | RW | 00000000h |
| 40059124h | Radio Oscillator Control (RF_OSC_CTRL) | 32 | RW | A0203806h |
| 40059128h | Radio Analog Test Registers (ANA_TEST) | 32 | RW | 0000_0000h |
| 4005912Ch | Radio Analog Trim Registers (ANA_TRIM) | 32 | RW | 784B0000h |

45.2.1.1.2 Radio System Control (CONTROL)

45.2.1.1.2.1 Offset

| Register | Offset |
|----------|-----------|
| CONTROL | 40059000h |

45.2.1.1.2.2 Diagram

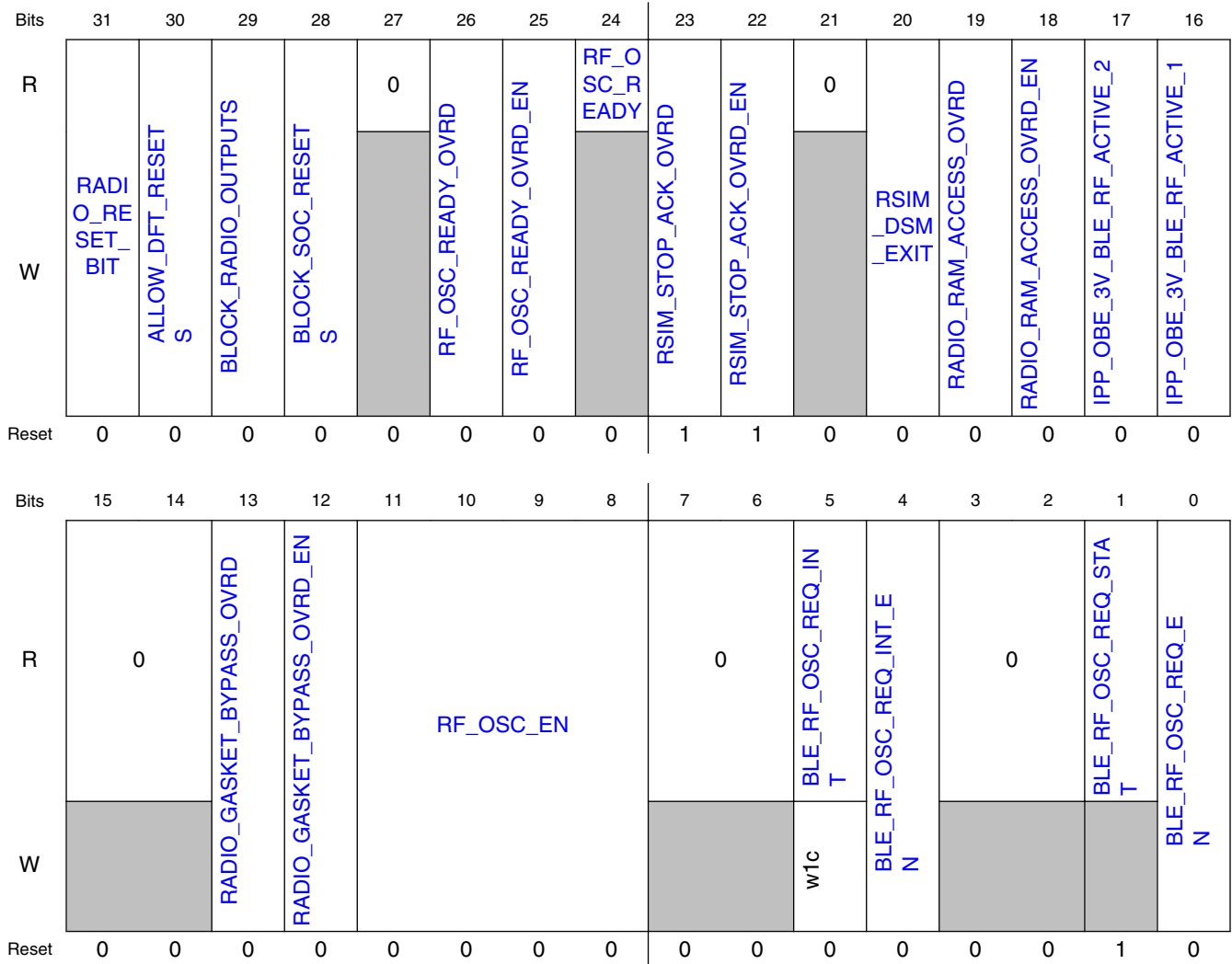

45.2.1.1.2.3 Fields

| Field | Function |
|---------------------------|---|
| 31 RADIO_RESET_BIT | Software Reset for the Radio This bit resets on POR only. When the Radio Resets are Blocked, setting this bit will reset all the radio logic until this bit is cleared. Note that due to internal Radio Reset Exit synchronizing logic there must be a second access to an RSIM register to clear this software reset, so please write this bit to 0 twice when clearing it. |
| 30 ALLOW_DFT_RESETS | Allow the DFT Reset Pin to Reset the Radio The Radio provides a port that can be connected to a test mode pin in order to provide a method of resetting the Radio independently from SoC resets. This bit enables that DFT functionality. |
| 29 BLOCK_RADIO_OUTPUTS | Block Radio Outputs |

Table continues on the next page...

| Field | Function |
|----------------------------------|--|
| | This bit resets on POR only. This bit is intended to allow the SoC to perform concurrent testing of various SoC logic while the Radio is operating independently. Any Radio output signals that go to the SoC will be blocked so as to not affect the SoC testing when this bit is set. |
| 28 BLOCK_SOC_RESETS | Block SoC Resets of the Radio This bit resets on POR only. This bit is intended to allow the SoC to perform concurrent testing of various SoC logic while the Radio is operating independently. Any SoC resets will be blocked and the Radio will not be affected by them when this bit is set. |
| 27 — | Reserved |
| 26 RF_OSC_READY_OVRD | RF Ref Osc Ready Override This bit directly controls the Radio RF Ref Osc Ready signal when the RF Ref Osc Ready Override is enabled. All Radio and SoC signals that are derived from the RF Ref Osc Ready signal can be overridden using this bit. |
| 25 RF_OSC_READY_OVRD_EN | RF Ref Osc Ready Override Enable This bit enables the RF Ref Osc Ready Override bit. |
| 24 RF_OSC_READY | RF Ref Osc Ready The RF Reference Oscillator has an internal counter that gates off the RF Ref Osc clock until the selected count is reached. This bit shows the status of the RF Ref Osc ready signal that comes from that counter. The RF Ref Osc Ready signal can be overridden using the RF_OSC_READY_OVRD bit. |
| 23 RSIM_STOP_ACK_OVRD | Stop Acknowledge Override This bit controls the Stop Acknowledge signal to the SoC Core Platform in Override mode. |
| 22 RSIM_STOP_ACK_OVRD_EN | Stop Acknowledge Override Enable This bit enables an override of the Stop Acknowledge signal. If not overwritten, Radio Stop Acknowledge is nominally based on the Deep Sleep Mode state of the Radio Link Layers and whether the Radio OSC is enabled by any means. |
| 21 — | Reserved |
| 20 RSIM_DSM_EXIT | BLE Force Deep Sleep Mode Exit This bit forces the BLE link layer to wakeup from Deep Sleep Mode. |
| 19 RADIO_RAM_ACCESS_OVRD | Radio RAM Access Override The Radio has two internal RAM blocks that are allowed to go into a low power state when they are not being used by a link layer. If this bit is set, then the RAMs are kept in an active power state to allow software to access them. |
| 18 RADIO_RAM_ACCESS_OVRD_EN | Radio RAM Access Override Enable This bit enables the Radio RAM Access Override bit. |
| 17 IPP_OBE_3V_BLE_RF_ACTIVE_2 | IPP_OBE_3V_BLE_RF_ACTIVE_2 This bit enables the Output Driver (OBE) on the SoC port 2 that provides the BLE RF Active signal as a pad interface option. |
| 16 | IPP_OBE_3V_BLE_RF_ACTIVE_1 |

Table continues on the next page...

Radio Register Overview

| Field | Function |
|--|---|
| IPP_OBE_3V_BLE_RF_ACTIVE_1 | This bit enables the Output Driver (OBE) on the SoC port 1 that provides the BLE RF Active signal as a pad interface option. |
| 15-14 — | Reserved |
| 13 RADIO_GASKE_T_BYPASS_OVERRIDE | Radio Gasket Bypass Override This bit directly controls the SoC platform asynchronous gasket bypass signal when the Gasket Bypass Override is enabled. The default behavior of the SoC Asynchronous Gasket is Not Bypassed, which means the Radio registers are accessed using the RF Ref Osc clock. The Radio sends the RF Ref Osc to the asynchronous gasket which then uses that clock for SoC register accesses of the Radio registers. This requires the RF Ref Osc to be Enabled and Ready. If the RF Ref Osc is not Enabled and Ready, then the IPS Gasket can be overridden to be in Bypass Mode, which forces the use of the SoC IPG clock as the register access clock. If the RF Ref Osc Is Enabled and Ready, then the IPS Gasket can be overridden to be in Bypass Mode, but this is an ILLEGAL ACCESS if the Radio is operational, DO NOT write Radio registers with the Asynchronous Gasket Bypassed when the Radio is Operating. Test mode access is allowed but glitches may occur. The intent of Bypass Mode is to allow software to configure the Radio before the RF Ref Osc is Enabled and Ready. Note that the BLE Link Layer registers can only be accessed when the RF Ref Osc is Enabled and Ready. |
| 12 RADIO_GASKE_T_BYPASS_OVERRIDE_ENABLE | Radio Gasket Bypass Override Enable The SoC platform has an asynchronous gasket that allows register access for the Radio registers in all SoC clocking modes. This bit allows software to directly control the SoC platform asynchronous gasket bypass signal. |
| 11-8 RF_OSC_EN | RF Ref Osc Enable Select The RF Reference Oscillator can be enabled by a Radio link layer, by an internal SoC clock mode, by an External Pin request, or by these bits. If these bits are all cleared, 0000, then the RF Ref Osc will be controlled by the SoC, by an external pin request, or by a link layer. If any of these bits are set then the RF Ref Osc will be on in the SoC power modes as shown below. Note that the enables are additive; each bit adds another low power mode. 0000b - RF Ref Osc will be controlled by the SoC, external pin, or a link layer 0001b - RF Ref Osc on in Run/Wait 0011b - RF Ref Osc on in Stop 0111b - RF Ref Osc on in VLPR/VLPW 1111b - RF Ref Osc on in VLPS |
| 7-6 — | Reserved |
| 5 BLE_RF_OSC_REQ_INT | BLE Ref Osc (Sysclk) Request Interrupt Flag This bit is an interrupt flag that is set when the enabled version of the BLE Ref Osc (Sysclk) Request is asserted high. This interrupt flag is cleared by writing a 1 to it. |
| 4 BLE_RF_OSC_REQ_INT_EN | BLE Ref Osc (Sysclk) Request Interrupt Enable This bit enables an interrupt request when the enabled version of the BLE Ref Osc (Sysclk) Request is asserted high. |
| 3-2 — | Reserved |
| 1 BLE_RF_OSC_REQ_STAT | BLE Ref Osc (Sysclk) Request Status This bit indicates the current status of the BLE link layer request to turn on the RF Ref Oscillator (Sysclk Req). |
| 0 | BLE Ref Osc (Sysclk) Request Enable |

| Field | Function |
|-------------------|---|
| BLE_RF_OSC_REQ_EN | <p>This bit resets on POR only.</p> <p>If this bit is cleared (the default state), then all BLE link layer requests to turn on the RF Ref Oscillator (Sysclk Req) will be blocked and ignored.</p> <p>In BLE protocols the BLE link layer will always restart when exiting reset by first Requesting the RF Ref Osc (Sysclk Req), this bit blocks that behavior until software configures the Radio and enables the requests.</p> |

45.2.1.1.3 Radio Active Early Warning (ACTIVE_DELAY)

45.2.1.1.3.1 Offset

| Register | Offset |
|--------------|-----------|
| ACTIVE_DELAY | 40059004h |

45.2.1.1.3.2 Function

The RSIM BLE Active Delay register provides control bits to adjust the delay of the BLE Active signal that is presented to the SoC Flash System.

45.2.1.1.3.3 Diagram

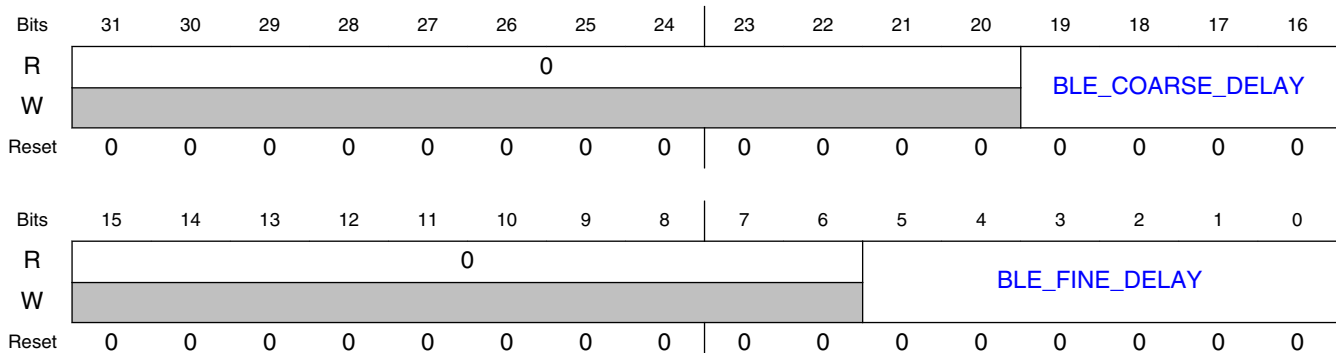

45.2.1.1.3.4 Fields

| Field | Function |
|-------|-------------------------|
| 31-20 | Reserved |
| — | |
| 19-16 | BLE Active Coarse Delay |

Table continues on the next page...

Radio Register Overview

| Field | Function |
|-----------------------|--|
| BLE_COARSE_DELAY | The SoC Flash is presented with a BLE Active early warning signal to allow the Flash to complete any program or erase activities prior to a Radio communication event. This warning signal is delayed from the BLE Active signal provided by the BLE link layer. The timing of the Flash delay is calculated as follows: BLE Active link layer delay - (BLE Active Flash Fine Delay x 32 kHz clock period x 4) - (BLE Active Flash Coarse Delay x 32 kHz clock period x 64) |
| 15-6 — | Reserved |
| 5-0 BLE_FINE_DELAY | BLE Active Fine Delay The SoC Flash is presented with a BLE Active early warning signal to allow the Flash to complete any program or erase activities prior to a Radio communication event. This warning signal is delayed from the BLE Active signal provided by the BLE link layer. The amount of the delay from the BLE link layer is calculated as follows: BLE Active link layer delay - (BLE Active Flash Fine Delay x 32 kHz clock period x 4) - (BLE Active Flash Coarse Delay x 32 kHz clock period x 64) |

45.2.1.1.4 Radio MAC Address (MAC_MSB)

45.2.1.1.4.1 Offset

| Register | Offset |
|----------|-----------|
| MAC_MSB | 40059008h |

45.2.1.1.4.2 Function

The Radio MAC Address registers provide a unique ID that is stored in the Flash during factory test.

45.2.1.1.4.3 Diagram

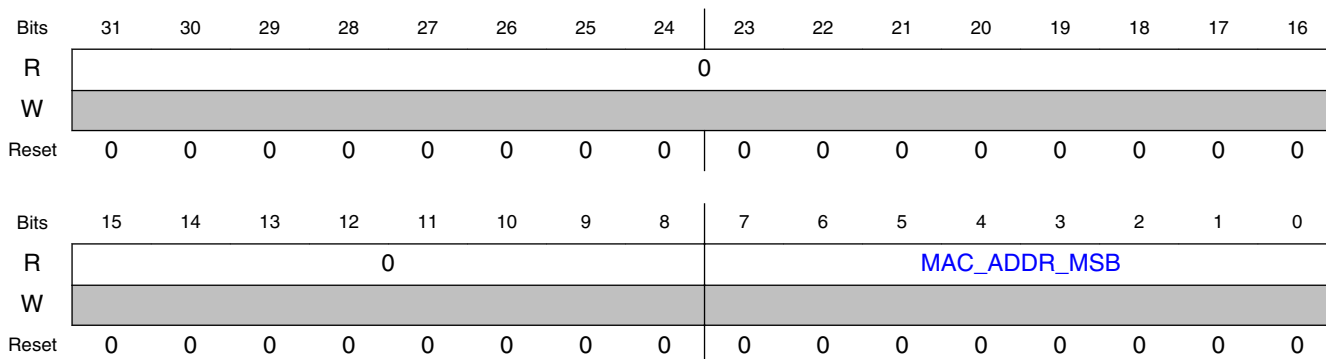

45.2.1.1.4.4 Fields

| Field | Function |
|---------------------|---|
| 31-8 Reserved | Reserved |
| 7-0 MAC_ADDR_MSB | Radio MAC Address MSB The Radio MAC Address is loaded from the Flash IFR during the SoC Power on Reset sequence. The MAC Address is a unique ID that is stored in the Flash during factory test. |

45.2.1.1.5 Radio MAC Address (MAC_LSB)

45.2.1.1.5.1 Offset

| Register | Offset |
|----------|-----------|
| MAC_LSB | 4005900Ch |

45.2.1.1.5.2 Function

The Radio MAC Address registers provide a unique ID that is stored in the Flash during factory test

45.2.1.1.5.3 Diagram

| | | | | | | | | | | | | | | | | |
|-------|--------------|----|----|----|----|----|----|----|----|----|----|----|----|----|----|----|
| Bits | 31 | 30 | 29 | 28 | 27 | 26 | 25 | 24 | 23 | 22 | 21 | 20 | 19 | 18 | 17 | 16 |
| R | MAC_ADDR_LSB | | | | | | | | | | | | | | | |
| W | | | | | | | | | | | | | | | | |
| Reset | 0 | 0 | 0 | 0 | 0 | 0 | 0 | 0 | 0 | 0 | 0 | 0 | 0 | 0 | 0 | 0 |
| Bits | 15 | 14 | 13 | 12 | 11 | 10 | 9 | 8 | 7 | 6 | 5 | 4 | 3 | 2 | 1 | 0 |
| R | MAC_ADDR_LSB | | | | | | | | | | | | | | | |
| W | | | | | | | | | | | | | | | | |
| Reset | 0 | 0 | 0 | 0 | 0 | 0 | 0 | 0 | 0 | 0 | 0 | 0 | 0 | 0 | 0 | 0 |

45.2.1.1.5.4 Fields

| Field | Function |
|----------------------|---|
| 31-0 MAC_ADDR_LSB | Radio MAC Address LSB The Radio MAC Address is loaded from the Flash IFR during the SoC Power on Reset sequence. The MAC Address is a unique ID that is stored in the Flash during factory test. |

45.2.1.1.6 Deep Sleep Timer (DSM_TIMER)

45.2.1.1.6.1 Offset

| Register | Offset |
|-----------|-----------|
| DSM_TIMER | 40059100h |

45.2.1.1.6.2 Diagram

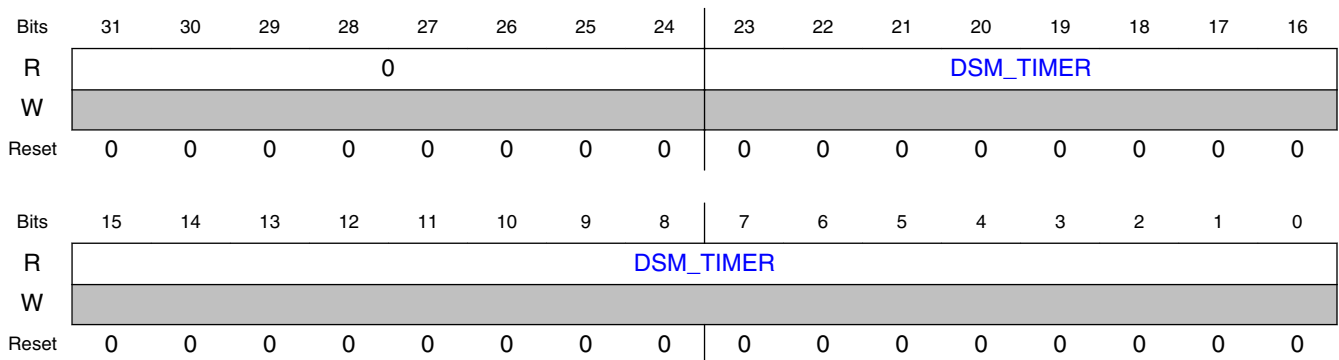

45.2.1.1.6.3 Fields

| Field | Function |
|-------------------|--|
| 31-24 — | Reserved |
| 23-0 DSM_TIMER | Deep Sleep Mode Timer This read only register shows the value of the Deep Sleep Timer. The timer counts clock cycles of the 32 kHz SoC oscillator whenever the DSM_TIMER_EN bit is set. The timer is reset to zero whenever the DSM_TIMER_CLR bit is set. |

45.2.1.1.7 Deep Sleep Timer Control (DSM_CONTROL)

45.2.1.1.7.1 Offset

| Register | Offset |
|-------------|-----------|
| DSM_CONTROL | 40059104h |

45.2.1.1.7.2 Diagram

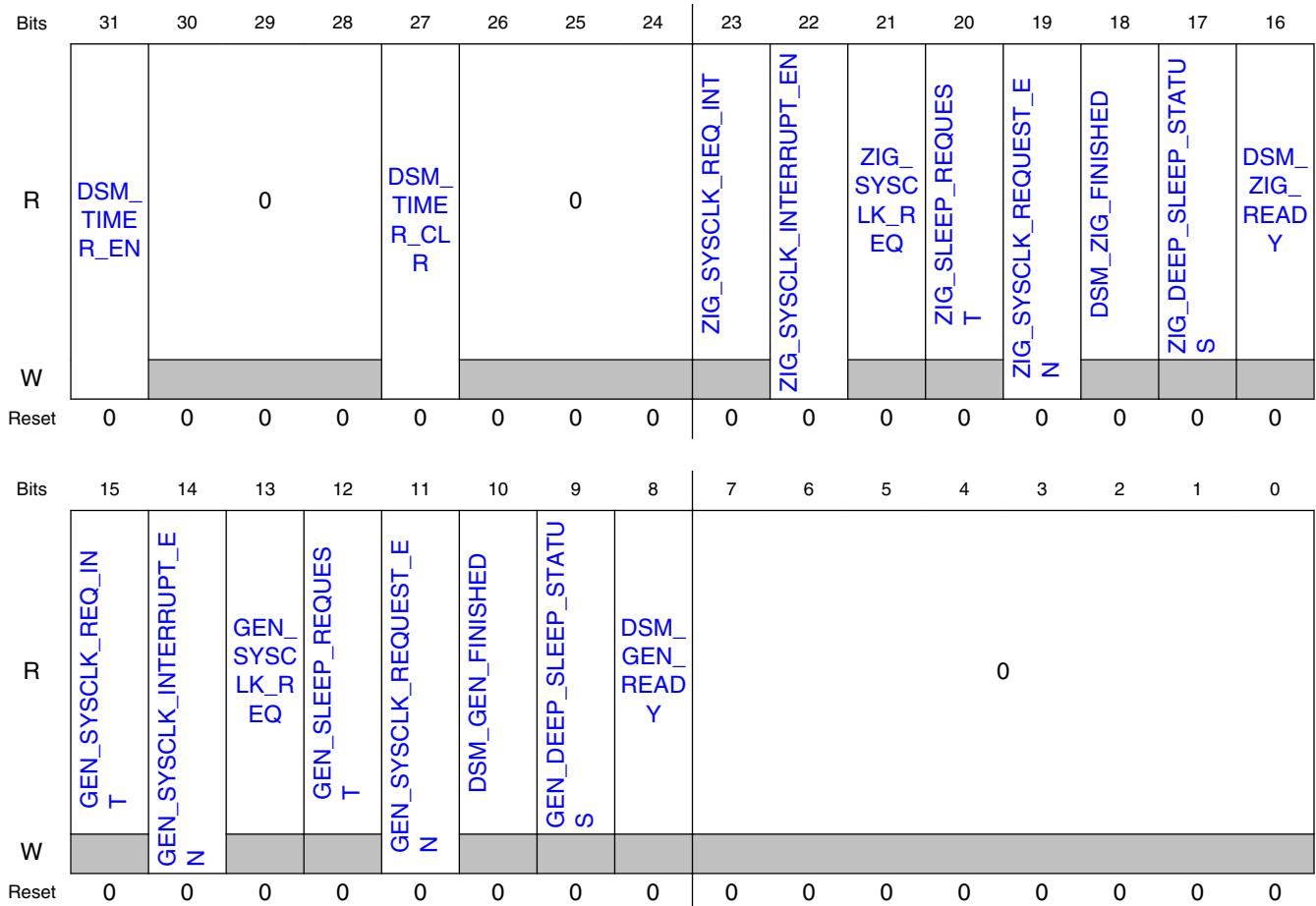

45.2.1.1.7.3 Fields

| Field | Function |
|---------------------|--|
| 31 DSM_TIMER_EN | Deep Sleep Mode Timer Enable Whenever this bit is set the Deep Sleep Mode Timer counts clock cycles of the 32 kHz SoC oscillator. |
| 30-28 — | Reserved |
| 27 DSM_TIMER_CLR | Deep Sleep Mode Timer Clear Whenever this bit is set the Deep Sleep Mode Timer is reset to zero. |
| 26-24 — | Reserved |
| 23 | Interrupt Flag from an 802.15.4 Link Layer RF OSC Request |

Table continues on the next page...

Radio Register Overview

| Field | Function |
|-------------------------|---|
| ZIG_SYSCLK_REQ_INT | If the ZIG_SYSCLK_INTERRUPT_EN bit is set, then this flag indicates that an 802.15.4 RF OSC Request has occurred. The flag will persist until this bit is written with a 1 to clear it. |
| 22 | 802.15.4 Link Layer RF OSC Request Interrupt Enable |
| ZIG_SYSCLK_INTERRUPT_EN | If this bit is set, then a change from a 0 to a 1 on ZIG_SYSCLK_REQ will generate an interrupt which can be used by the SoC. |
| 21 | 802.15.4 Link Layer RF OSC Request Status |
| ZIG_SYSCLK_REQ | This bit shows the status of the 802.15.4 Link Layer Request for the RF OSC to be turned on. If the ZIG_SYSCLK_REQUEST_EN bit is set, then this signal is used by the RSIM to turn on the RF OSC if the RF OSC is not already turned on by another request source. |
| 20 | 802.15.4 Link Layer Deep Sleep Requested |
| ZIG_SLEEP_REQUEST | From the 802.15.4 Sleep Enable register. This enables a match of ZIG_SLEEP[23:0] to SLEEP_TMR[23:0]; when the match occurs Deep Sleep Mode is entered. |
| 19 | Enable 802.15.4 Link Layer to Request RF OSC |
| ZIG_SYSCLK_REQUEST_EN | This bit allows the 802.15.4 Link Layer to request turning on the RF OSC. |
| 18 | 802.15.4 Deep Sleep Time Finished |
| DSM_ZIG_FINISHED | This register is for debug purposes. This is the SLEEP_FINISHED state in the Deep Sleep Module State Machine, the state machine holds here until the Link Layer de-asserts the sleep_request. |
| 17 | 802.15.4 Link Layer Deep Sleep Mode Status |
| ZIG_DEEP_SLEEP_STATUS | This is the signal from the Deep Sleep Module State Machine telling the Link Layer to enter and exit Deep Sleep Mode. If this bit is set then the Link Layer is in Deep Sleep Mode. |
| 16 | 802.15.4 Ready for Deep Sleep Mode |
| DSM_ZIG_READY | This register is for debug purposes. This is the SLEEP_READY state in the Deep Sleep Module State Machine, the state machine holds here until the sleep time is reached on the 32 kHz clock counter (Deep Sleep Timer). |
| 15 | Interrupt Flag from an Generic FSK Link Layer RF OSC Request |
| GEN_SYSCLK_REQ_INT | If the GEN_SYSCLK_INTERRUPT_EN bit is set, then this flag indicates that an Generic FSK RF OSC Request has occurred. The flag will persist until this bit is written with a 1 to clear it. |
| 14 | Generic FSK Link Layer RF OSC Request Interrupt Enable |
| GEN_SYSCLK_INTERRUPT_EN | If this bit is set, then a change from a 0 to a 1 on GEN_SYSCLK_REQ will generate an interrupt which can be used by the SoC. |
| 13 | Generic FSK Link Layer RF OSC Request Status |
| GEN_SYSCLK_REQ | This bit shows the status of the Generic FSK Link Layer Request for the RF OSC to be turned on. If the GEN_SYSCLK_REQUEST_EN bit is set, then this signal is used by the RSIM to turn on the RF OSC if the RF OSC is not already turned on by another request source. |
| 12 | Generic FSK Link Layer Deep Sleep Requested |
| GEN_SLEEP_REQUEST | From the Generic FSK Sleep Enable register. This enables a match of GEN_SLEEP[23:0] to SLEEP_TMR[23:0]; when the match occurs Deep Sleep Mode is entered. |
| 11 | Enable Generic FSK Link Layer to Request RF OSC |
| GEN_SYSCLK_REQUEST_EN | This bit allows the Generic FSK Link Layer to request turning on the RF OSC. |
| 10 | Generic FSK Deep Sleep Time Finished |
| DSM_GEN_FINISHED | This register is for debug purposes. This is the SLEEP_FINISHED state in the Deep Sleep Module State Machine, the state machine holds here until the Link Layer de-asserts the sleep_request. |

Table continues on the next page...

| Field | Function |
|--------------------------------|--|
| 9 GEN_DEEP_SL EEP_STATUS | Generic FSK Link Layer Deep Sleep Mode Status This is the signal from the Deep Sleep Module State Machine telling the Link Layer to enter and exit Deep Sleep Mode. If this bit is set then the Link Layer is in Deep Sleep Mode. |
| 8 DSM_GEN_RE ADY | Generic FSK Ready for Deep Sleep Mode This register is for debug purposes. This is the SLEEP_READY state in the Deep Sleep Module State Machine, the state machine holds here until the sleep time is reached on the 32 kHz clock counter (Deep Sleep Timer). |
| 7-0 — | Reserved |

45.2.1.1.8 Deep Sleep Wakeup Time Offset (DSM_OSC_OFFSET)

45.2.1.1.8.1 Offset

| Register | Offset |
|----------------|-----------|
| DSM_OSC_OFFSET | 40059108h |

45.2.1.1.8.2 Diagram

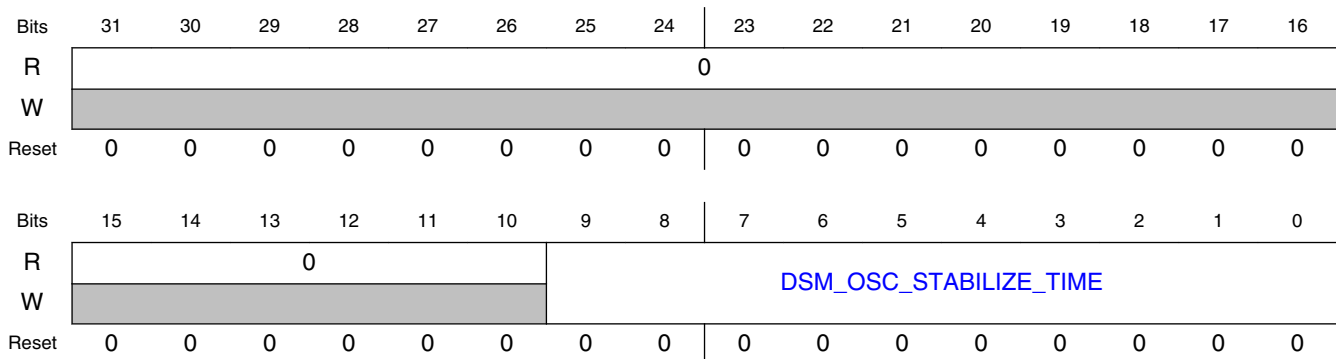

45.2.1.1.8.3 Fields

| Field | Function |
|-----------------------------------|--|
| 31-10 Reserved | Reserved |
| 9-0 DSM_OSC_STA BILIZE_TIME | Deep Sleep Wakeup RF OSC Stabilize Time This register should be programmed by software with the time needed for the RF OSC to stabilize to its specified accuracy after it is enabled. This time is represented by the number of clock cycles of the 32 |

Radio Register Overview

| Field | Function |
|-------|---|
| | kHz SoC oscillator that should be counted before the link layer is allowed to exit Deep Sleep Mode on a wakeup event. This time offset will be used by the Deep Sleep State Machine to first turn on the RF OSC, then wait for it stabilize, and finally wakeup the link layer. |

45.2.1.1.9 802.15.4 Link Layer Sleep Time (ZIG_SLEEP)

45.2.1.1.9.1 Offset

| Register | Offset |
|-----------|-----------|
| ZIG_SLEEP | 40059114h |

45.2.1.1.9.2 Diagram

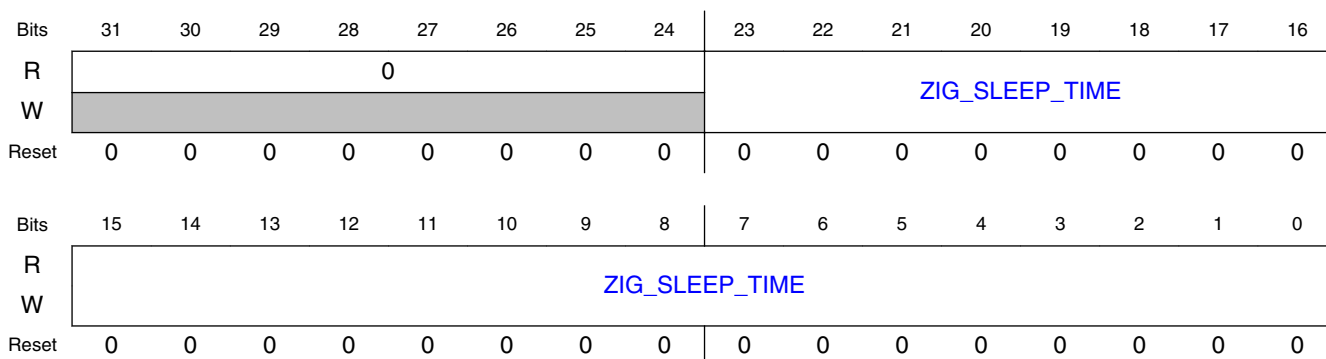

45.2.1.1.9.3 Fields

| Field | Function |
|------------------------|---|
| 31-24 — | Reserved |
| 23-0 ZIG_SLEEP_TIME | 802.15.4 Link Layer Sleep Time Software determines the future time at which it would like to enter Deep Sleep Mode by reading the DSM_TIMER, computing the number of 32 kHz clock cycles remaining until the desired DSM start-time, and writing that value into this register. The value programmed into this register should be no fewer than 4 clocks greater (in the future) than the current time as read from DSM_TIMER. |

45.2.1.1.10 802.15.4 Link Layer Wake Time (ZIG_WAKE)

45.2.1.1.10.1 Offset

| Register | Offset |
|----------|-----------|
| ZIG_WAKE | 40059118h |

45.2.1.1.10.2 Diagram

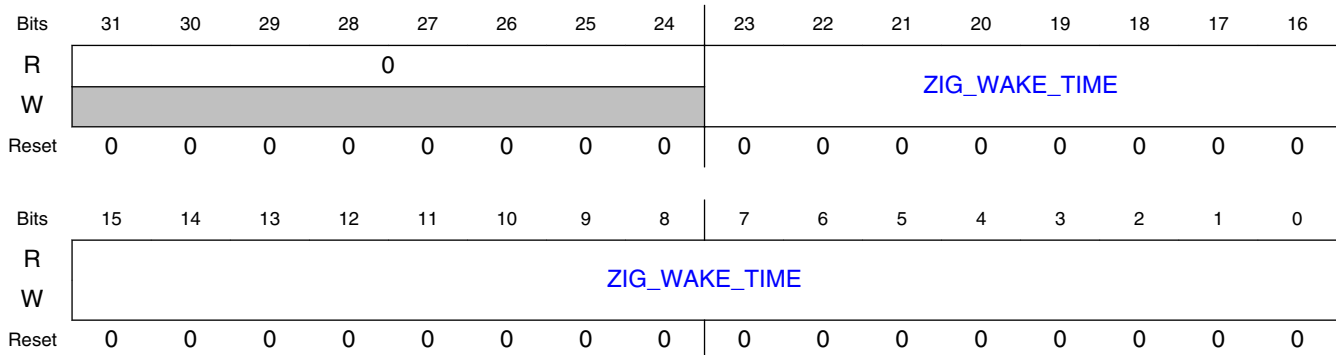

45.2.1.1.10.3 Fields

| Field | Function |
|-----------------------|---|
| 31-24 — | Reserved |
| 23-0 ZIG_WAKE_TIME | 802.15.4 Link Layer Wake Time Software determines the future time at which it would like to exit Deep Sleep Mode by reading the DSM_TIMER, computing the number of 32 kHz clock cycles remaining until the desired DSM exit time, and writing that value into this register. |

45.2.1.1.11 Generic FSK Link Layer Sleep Time (GEN_SLEEP)

45.2.1.1.11.1 Offset

| Register | Offset |
|-----------|-----------|
| GEN_SLEEP | 4005911Ch |

45.2.1.1.11.2 Diagram

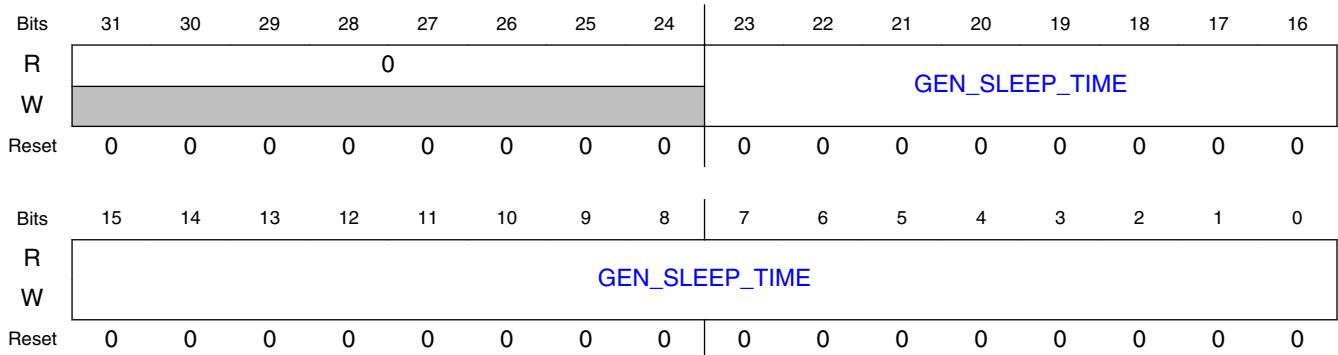

45.2.1.1.11.3 Fields

| Field | Function |
|------------------------|--|
| 31-24 — | Reserved |
| 23-0 GEN_SLEEP_TIME | Generic FSK Link Layer Sleep Time Software determines the future time at which it would like to enter Deep Sleep Mode by reading the DSM_TIMER, computing the number of 32 kHz clock cycles remaining until the desired DSM start-time, and writing that value into this register. The value programmed into this register should be no fewer than 4 clocks greater (in the future) than the current time as read from DSM_TIMER. |

45.2.1.1.12 Generic FSK Link Layer Wake Time (GEN_WAKE)

45.2.1.1.12.1 Offset

| Register | Offset |
|----------|-----------|
| GEN_WAKE | 40059120h |

45.2.1.1.12.2 Diagram

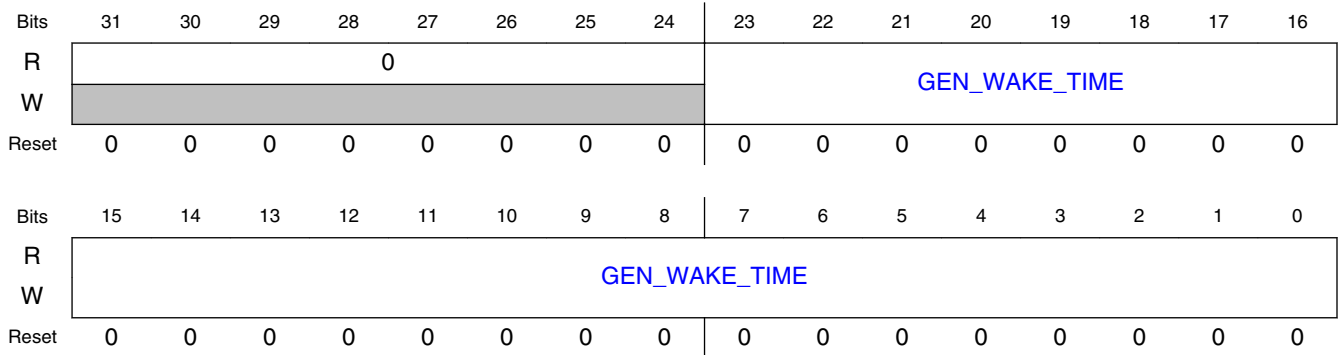

45.2.1.1.12.3 Fields

| Field | Function |
|-----------------------|--|
| 31-24 — | Reserved |
| 23-0 GEN_WAKE_TIME | Generic FSK Link Layer Wake Time Software determines the future time at which it would like to exit Deep Sleep Mode by reading the DSM_TIMER, computing the number of 32 kHz clock cycles remaining until the desired DSM exit time, and writing that value into this register. |

45.2.1.1.13 Radio Oscillator Control (RF_OSC_CTRL)

45.2.1.1.13.1 Offset

| Register | Offset |
|-------------|-----------|
| RF_OSC_CTRL | 40059124h |

45.2.1.1.13.2 Diagram

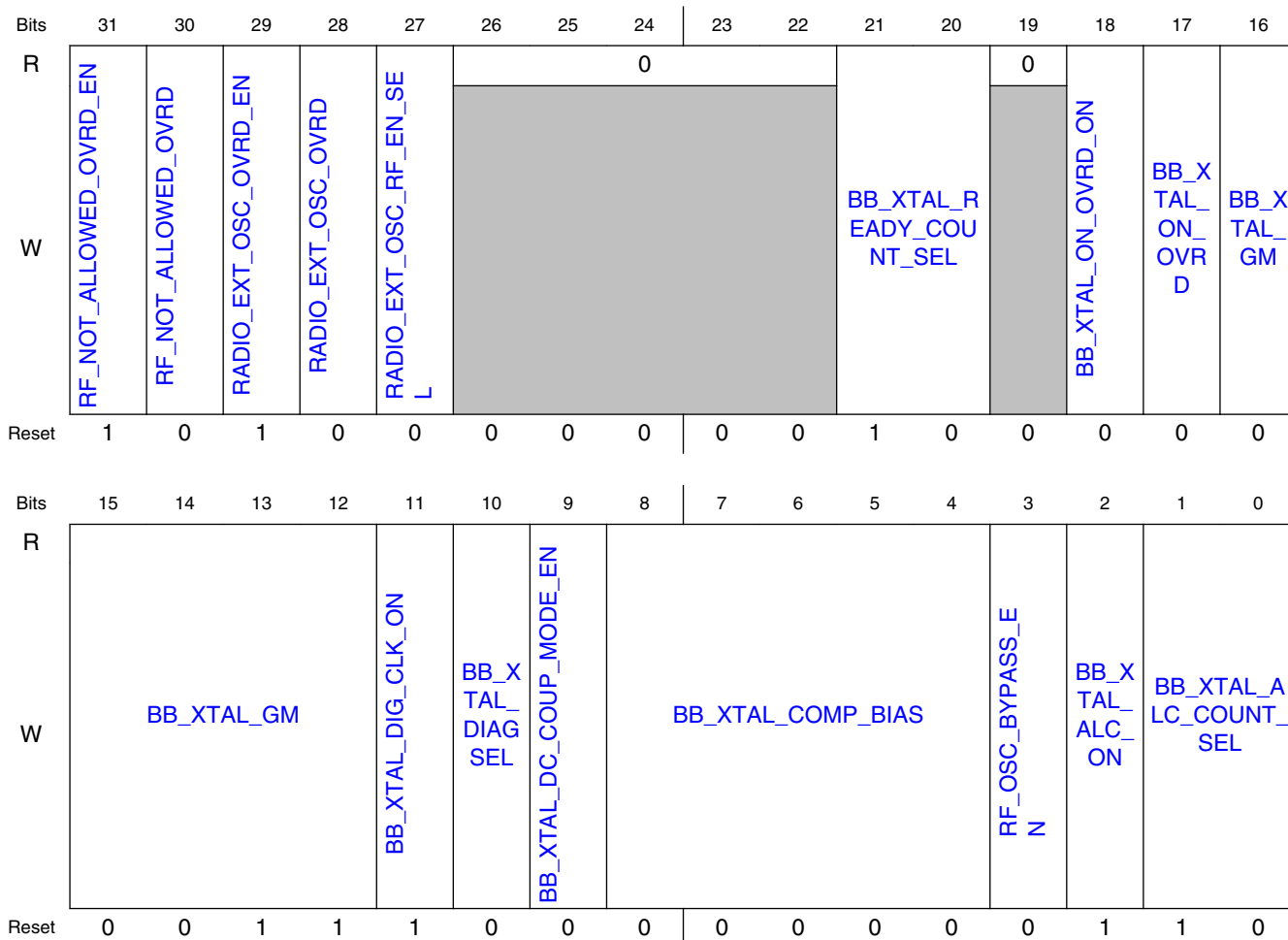

45.2.1.1.13.3 Fields

| Field | Function |
|------------------------------|--|
| 31 RF_NOT_ALLOWED_OVRD_EN | RF Not Allowed Override Enable This bit enables the RF Not Allowed Override bit. |
| 30 RF_NOT_ALLOWED_OVRD | RF Not Allowed Override The Radio has a pin which may be controlled by an external pad in the SoC in such a way as to allow an external device, such as another radio, to force this Radio to abort the current Radio Operation. This is intended to prevent two radios from interfering with each other. If the RF_NOT_ALLOWED_OVRD_EN bit is set, then this bit controls that RF Abort functionality. |
| 29 RADIO_EXT_OSC_OVRD_EN | Radio External Request for RF OSC Override Enable This bit enables the Radio External RF OSC Override bit. When RADIO_EXT_OSC_OVRD_EN=1, an external request through XTAL_OUT_EN pin will be ignored. |
| 28 | Radio External Request for RF OSC Override |

Table continues on the next page...

| Field | Function |
|---------------------------------|---|
| RADIO_EXT_O SC_OVRD | The Radio has two pins which may be controlled by external pads in the SoC in such a way as to allow an external device, such as another radio, to enable this Radio's RF Oscillator and provide the RF OSC clock to the external device using an external SoC pad. If the RADIO_EXT_OSC_OVRD_EN bit is set, then this bit controls that External RF OSC Request functionality. |
| 27 | Radio External Request for RF OSC Select |
| RADIO_EXT_O SC_RF_EN_SE L | The Radio has two pins which may be controlled by external pads in the SoC in such a way as to allow an external device, such as another radio, to enable this Radio's RF Oscillator. This bit selects which of the two pins has control of that external request. On KW41/KW31Z/KW21Z RADIO_EXT_OSC_RF_EN_SEL=0 maps to PTB0, RADIO_EXT_OSC_RF_EN_SEL=1 maps to PTC6. |
| 26-22 — | Reserved |
| 21-20 | rmap_bb_xtal_ready_count_sel_hv[1:0] |
| BB_XTAL_REA DY_COUNT_SE L | Program counter for xtal ready signal Sets up count value for XO startup time. 00 --> 1024 counts (32us @ 32MHz) 01 --> 2048 (64us @ 32MHz) 10 --> 4096 (128us @ 32MHz) 11 --> 8192 (256us @ 32MHz) |
| 19 — | Reserved |
| 18 | rmap_bb_xtal_on_ovrd_on_hv |
| BB_XTAL_ON_ OVRD_ON | Enable override XO enable bit Enable selector: 0 --> rfctrl_bb_xtal_on_hv is asserted 1 --> rfctrl_bb_xtal_on_ovrd_hv is asserted |
| 17 | rmap_bb_xtal_on_ovrd_hv |
| BB_XTAL_ON_ OVRD | Override XO enable |
| 16-12 | rmap_bb_xtal_gm_hv[4:0] |
| BB_XTAL_GM | Amplifier current bumps, bit [4] not used. Current values assume ALC is off Amplifier current bumps. bit [4] not used. Current values assume ALC is off 0 --> Min setting: 8 current sources on (TT27:60uA) ... 15 --> Max setting: 128 current sources on (TT27:960uA) |
| 11 | rmap_bb_xtal_dig_clk_on_hv |
| BB_XTAL_DIG_ CLK_ON | Enable digital clk output |
| 10 | rmap_bb_xtal_diagsel_hv |
| BB_XTAL_DIAG SEL | Enable diagnostics for XO block |
| 9 | rmap_bb_xtal_dc_coup_mode_en_hv |

Table continues on the next page...

Radio Register Overview

| Field | Function |
|------------------------------|--|
| BB_XTAL_DC_COUP_MODE_EN | This bit enables the external dc coupled mode. This bit powers down the XO amplifier to enable DC coupled input. |
| 8-4 BB_XTAL_COM_P_BIAS | rmap_bb_xtal_comp_bias_hv[4:0] Not used. Spare for now. But future functionality is planned. |
| 3 RF_OSC_BYPASS_EN | RF Ref Osc Bypass Enable This bit engages the RF Ref Osc analog bypass circuit if the RF Ref Osc is enabled. When the RF Ref Osc is in bypass mode it passes the RF EXTAL clock as the RF Ref Osc clock. Note that the RF Ref Osc Ready signal functions normally in RF OSC Bypass mode, unless overridden with the RF_OSC_READY_OVRD_EN bit. |
| 2 BB_XTAL_ALC_ON | rmap_bb_xtal_alc_on_hv Enable ALC |
| 1-0 BB_XTAL_ALC_COUNT_SEL | rmap_bb_xtal_alc_count_sel_hv[1:0] Program counter for alc ready signal Sets up count value for fastcharge to turn off: 00 --> 2048 (64us @ 32MHz) 01 --> 4096 (128us @ 32MHz) 10 --> 8192 (256us @ 32MHz) 11 --> 16384 (512us @ 32MHz) |

45.2.1.1.14 Radio Analog Test Registers (ANA_TEST)

45.2.1.1.14.1 Offset

| Register | Offset |
|----------|-----------|
| ANA_TEST | 40059128h |

45.2.1.1.14.2 Diagram

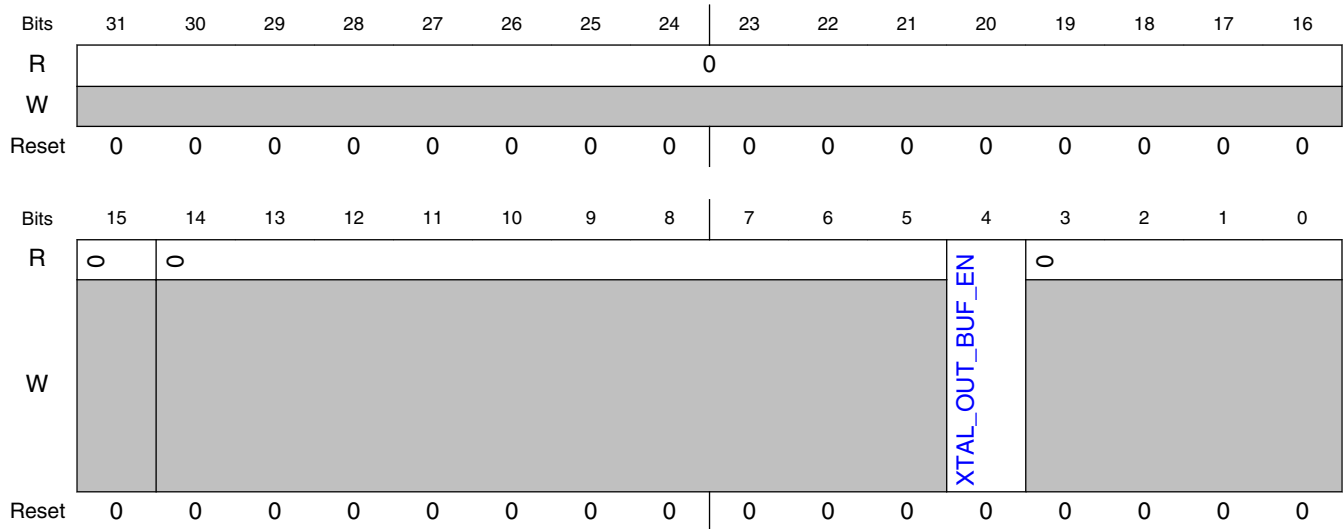

45.2.1.1.14.3 Fields

| Field | Function |
|----------------------|---|
| 31-15 — | Reserved |
| 14-5 — | Reserved. |
| 4 XTAL_OUT_BUF_EN | rmap_bb_xtal_test_en_hv The RF Analog Oscillator XTAL_OUT buffer for the XTAL_OUT SoC Pin is enabled when this bit is set. |
| 3-0 — | Reserved. |

45.2.1.1.15 Radio Analog Trim Registers (ANA_TRIM)

45.2.1.1.15.1 Offset

| Register | Offset |
|----------|-----------|
| ANA_TRIM | 4005912Ch |

45.2.1.1.15.2 Diagram

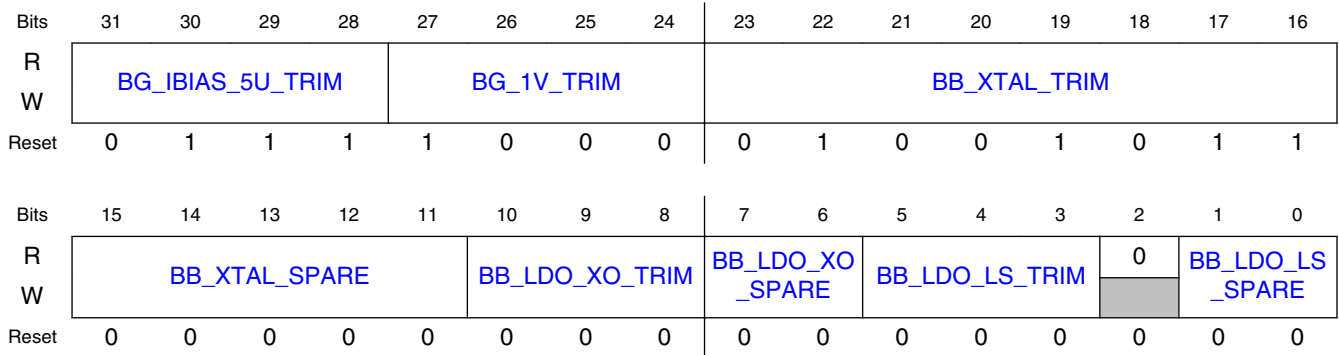

45.2.1.1.15.3 Fields

| Field | Function |
|---------------------------|--|
| 31-28 BG_IBIAS_5U_TRIM | rmap_bg_ibias_5u_trim_hv[3:0] 5uA current trim bits. Default setting is 0111 Trim bits for VBG output current 0 -->3.55uA, 1 -->3.73uA, 2 -->4.04uA, 3 -->4.22uA, 4-->4.39uA, 5 -->4.57uA, 6 -->4.89uA, 7(Default) -->5.06uA , 8 -->5.23uA, 9 -->5.41uA, 10 --> 5.72uA, 11 --> 5.9uA, 12 --> 6.07uA, 13 --> 6.25uA, 14 --> 6.56uA, 15 --> 6.74uA |
| 27-24 BG_1V_TRIM | rmap_bg_1v_trim_hv[3:0] Trim bits for VBG output voltage Trim bits for VBG output voltage 0 -->954.14mV, 1 -->959.26mV, 2 -->964.38mV, |

Table continues on the next page...

| Field | Function |
|------------------------|---|
| | 3 -->969.5mV, 4-->974.6mV, 5 -->979.7mV, 6 -->984.8mV, 7 -->989.9mV, 8 (Default) -->995mV, 9 -->1V, 10 --> 1.005V, 11 --> 1.01V, 12 --> 1.015V, 13 --> 1.02V, 14 --> 1.025V, 15 --> 1.031V |
| 23-16 BB_XTAL_TRIM | rmap_bb_xtal_trim_hv[7:0] Bump XO load capacitor Load capacitor bumps. bit [7] not used. 0 --> Min C1: 5.7pF. Min C2: 7.1pF ... 127 --> Max C1: 22.6pF. Max C2: 28.2pF |
| 15-11 BB_XTAL_SPARE | rmap_bb_xtal_spare_hv[4:0] Bit 4: Force XTAL ready high Bit 4: Force XTAL ready high ; 0 --> Default functionality ; 1--> Force XTAL ready high Bit 3:0 are used for XO Output Driver Bit 3: XO output polarity invert bit; 0 --> No polarity inversion; 1 --> Polarity inverted Bit 2: Enable AuxPLL output instead of XO; 0 --> XO out; 1 --> AuxPLL out |
| 10-8 BB_LDO_XO_TRIM | rmap_bb_ldo_xo_trim_hv[2:0] Trim settings for LDO. Trim settings for LDO. 0 --> 1.20 V (Default) 1 --> 1.25 V 2 --> 1.28 V 3 --> 1.33 V 4 --> 1.40 V 5 --> 1.44 V 6 --> 1.50 V 7 --> 1.66 V |
| 7-6 BB_LDO_XO_SPARE | rmap_bb_ldo_xo_spare_hv[1:0] Spare bits for LDO, not used so far. |

Table continues on the next page...

Radio Register Overview

| Field | Function |
|------------------------|---|
| 5-3 BB_LDO_LS_TRIM | rmap_bb_ldo_ls_trim_hv[2:0] Trim settings for LDO. Trim settings for LDO. 0 --> 1.20 V (Default) 1 --> 1.25 V 2 --> 1.28 V 3 --> 1.33 V 4 --> 1.40 V 5 --> 1.44 V 6 --> 1.50 V 7 --> 1.66 V |
| 2 — | Reserved |
| 1-0 BB_LDO_LS_SPARE | rmap_bb_ldo_ls_spare_hv[1:0] Spare bits. Not used so far. |

45.2.2 Transceiver Memory Map and Register Definition

The transceiver memory map and description of registers are included in the following register section.

45.2.2.1 XCVR_TX_DIG Register Descriptions

45.2.2.1.1 XCVR_TX_DIG_ADDR Memory Map

Base address: 4005C200h

| Offset | Register | Width (In bits) | Access | Reset value |
|-----------|---|--------------------|--------|-------------|
| 4005C200h | TX Digital Control (CTRL) | 32 | RW | 00000140h |
| 4005C204h | TX Data Padding (DATA_PADDING) | 32 | RW | 7FFF55AAh |
| 4005C208h | TX GFSK Modulator Control (GFSK_CTRL) | 32 | RW | 03014000h |
| 4005C20Ch | TX GFSK Filter Coefficients 2 (GFSK_COEFF2) | 32 | RW | C0630401h |
| 4005C210h | TX GFSK Filter Coefficients 1 (GFSK_COEFF1) | 32 | RW | BB29960Dh |

Table continues on the next page...

| Offset | Register | Width (In bits) | Access | Reset value |
|-----------|---|--------------------|--------|-------------|
| 4005C214h | TX FSK Modulation Levels (FSK_SCALE) | 32 | RW | 08001800h |
| 4005C218h | TX DFT Modulation Pattern (DFT_PATTERN) | 32 | RW | 00000000h |

45.2.2.1.2 TX Digital Control (CTRL)

45.2.2.1.2.1 Address

| Register | Offset |
|----------|-----------|
| CTRL | 4005C200h |

45.2.2.1.2.2 Diagram

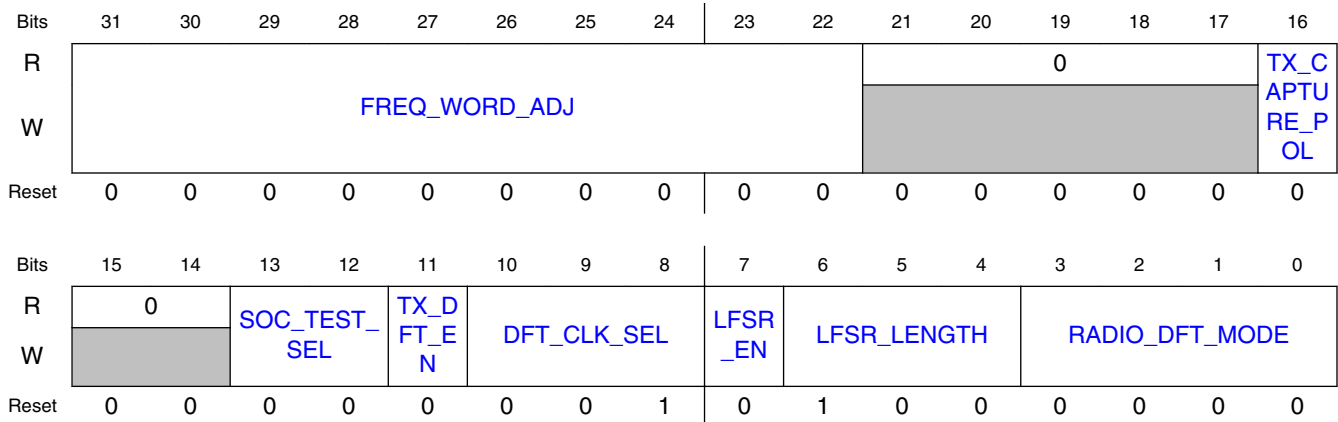

45.2.2.1.2.3 Fields

| Field | Function |
|------------------------|--|
| 31-22 FREQ_WORD_ADJ | <p>Frequency Word Adjustment</p> <p>This register is a signed 9 bit number that is added to the TX Digital output before it is presented to the PLL as the baseband frequency word. This allows the baseband frequency word to be adjusted, or skewed, by a range of -512 to +511.</p> <p>This frequency adjustment is applied to the final modulation word from any source (GFSK, FSK, DFT) and there is no protection from a math overflow. So the baseband frequency word range of -4096 to 4095 must be considered when adding this frequency word adjustment.</p> |
| 21-17 — | Reserved |
| 16 | Polarity of the Input Data for the Transmitter |

Table continues on the next page...

Radio Register Overview

| Field | Function |
|---------------------------|---|
| TX_CAPTURE_POL | If this bit is set, the TX data presented to the Transmitter will be inverted before it is processed. |
| 15-14 — | Reserved |
| 13-12 SOC_TEST_SE L | Radio Clock Selector for SoC RF Clock Tests This register selects the Radio clock source for the SoC Clock Tests Frequency Measurement. 00b - No Clock Selected 01b - PLL Sigma Delta Clock, divided by 2 10b - Auxiliary PLL Clock, divided by 2 11b - RF Ref Osc clock, divided by 2 |
| 11 TX_DFT_EN | DFT Modulation Enable If the Radio is in a DFT Pattern Register mode, then this bit is used to turn on and off the modulation that is shifted out from the pattern register. |
| 10-8 DFT_CLK_SEL | DFT Clock Selection This register selects the frequency of the DFT clock that is used to shift out the DFT Modulation Pattern in DFT Pattern Register modes, and the same frequency is also used to clock the LFSR and generate the pseudo-random modulation in DFT LFSR modes. 000b - 62.5 kHz 001b - 125 kHz 010b - 250 kHz 011b - 500 kHz 100b - 1 MHz 101b - 2 MHz 110b - 4 MHz 111b - RF OSC Clock |
| 7 LFSR_EN | LFSR Enable If the Radio is in a DFT LFSR mode, then this bit is used to turn on and off the LFSR that is used to generate the modulation. Note that the LFSR is clocked at the DFT Clock frequency. |
| 6-4 LFSR_LENGTH | LFSR Length This register selects the length of the DFT LFSR and the associated LFSR Tap Mask. The Mask is in the form of [MSB...LSB] 000b - LFSR 9, tap mask 100010000 001b - LFSR 10, tap mask 1001000000 010b - LFSR 11, tap mask 11101000000 011b - LFSR 13, tap mask 1101100000000 100b - LFSR 15, tap mask 111010000000000 101b - LFSR 17, tap mask 11110000000000000 110b - Reserved 111b - Reserved |
| 3-0 RADIO_DFT_M ODE | Radio DFT Modes This register selects the Radio DFT mode as described below. In addition to setting the Radio DFT mode, the DFT LFSR needs to be configured, and the Radio Protocol needs to be chosen. For LFSR modes the LFSR_EN needs to be set to turn on the LFSR. 0000b - Normal Radio Operation, DFT not engaged. |

| Field | Function |
|-------|--|
| | 0001b - Carrier Frequency Only |
| | 0010b - Pattern Register GFSK |
| | 0011b - LFSR GFSK |
| | 0100b - Pattern Register FSK |
| | 0101b - LFSR FSK |
| | 0110b - Pattern Register O-QPSK |
| | 0111b - LFSR O-QPSK |
| | 1000b - LFSR 802.15.4 Symbols |
| | 1001b - PLL Modulation from RAM |
| | 1010b - PLL Coarse Tune BIST |
| | 1011b - PLL Frequency Synthesizer BIST |
| | 1100b - High Port DAC BIST |
| | 1101b - VCO Frequency Meter |
| | 1110b - Reserved |
| | 1111b - Reserved |

45.2.2.1.3 TX Data Padding (DATA_PADDING)

45.2.2.1.3.1 Address

| Register | Offset |
|--------------|-----------|
| DATA_PADDING | 4005C204h |

45.2.2.1.3.2 Diagram

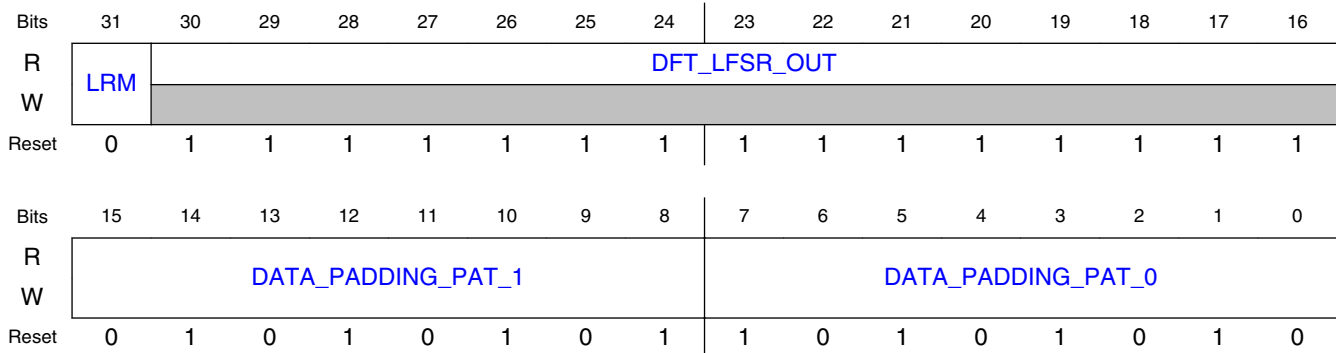

45.2.2.1.3.3 Fields

| Field | Function |
|-------|-----------------|
| 31 | LFSR Reset Mask |
| LRM | |

Table continues on the next page...

Radio Register Overview

| Field | Function |
|------------------------------|--|
| | When this bit is set the DFT LFSR will not be reset when LFSR_EN is cleared and will instead continue to repeat its sequence as defined by the DFT_LFSR_LEN bits when LFSR_EN is next set. When this bit is cleared the DFT LFSR will reset every time LFSR_EN is cleared. |
| 30-16 DFT_LFSR_OUT | LFSR Output This register can be read to observe the current value of the DFT LFSR, only bits [14:0] are available. |
| 15-8 DATA_PADDING_G_PAT_1 | Data Padding Pattern 1 These bits are used for Data Padding when the first bit of the Preamble is 1; the LSB is the first bit shifted out as padding. |
| 7-0 DATA_PADDING_G_PAT_0 | Data Padding Pattern 0 These bits are used for Data Padding when the first bit of the Preamble is 0; the LSB is the first bit shifted out as padding. |

45.2.2.1.4 TX GFSK Modulator Control (GFSK_CTRL)

45.2.2.1.4.1 Address

| Register | Offset |
|-----------|-----------|
| GFSK_CTRL | 4005C208h |

45.2.2.1.4.2 Diagram

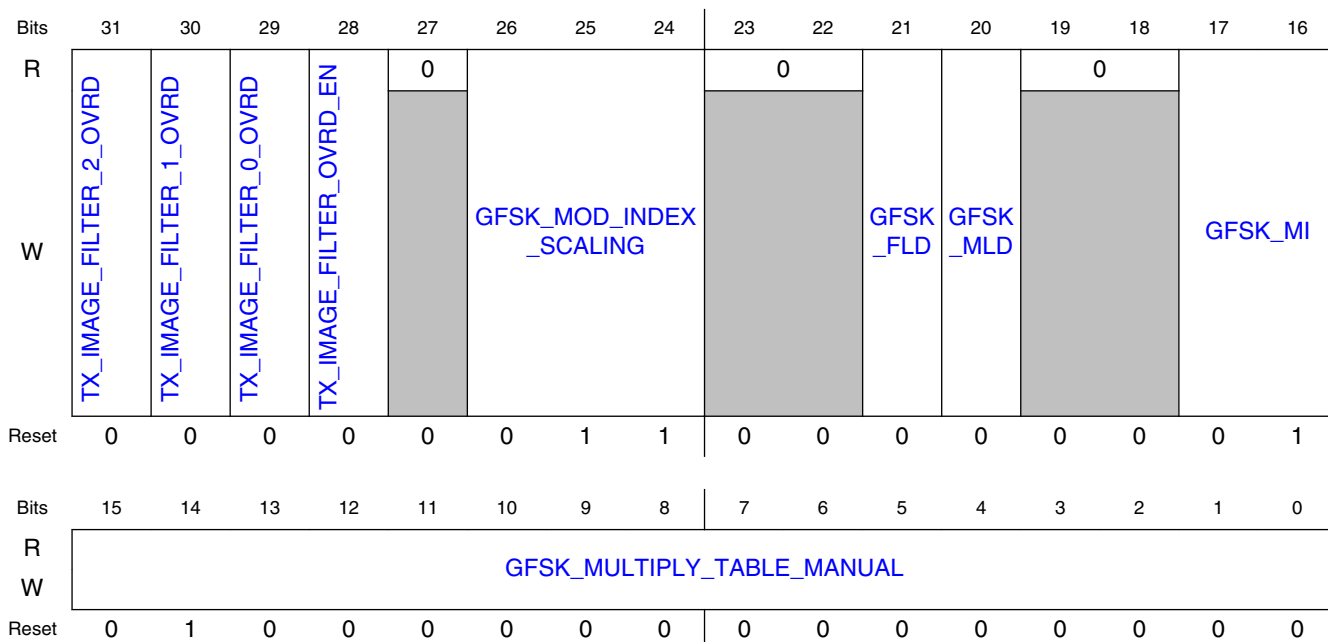

45.2.2.1.4.3 Fields

| Field | Function |
|---------------------------------|--|
| 31 TX_IMAGE_FILTER_2_OVRD | TX Image Filter 2 Override Control If the TX_IMAGE_FILTER_OVRD_EN bit is set, then this bit turns on and off the Transmit Image Filter 2 |
| 30 TX_IMAGE_FILTER_1_OVRD | TX Image Filter 1 Override Control If the TX_IMAGE_FILTER_OVRD_EN bit is set, then this bit turns on and off the Transmit Image Filter 1 |
| 29 TX_IMAGE_FILTER_0_OVRD | TX Image Filter 0 Override Control If the TX_IMAGE_FILTER_OVRD_EN bit is set, then this bit turns on and off the Transmit Image Filter 0 |
| 28 TX_IMAGE_FILTER_OVRD_EN | TX Image Filter Override Enable This bit enables the TX Image Filter Override Control bits. |
| 27 — | Reserved |
| 26-24 GFSK_MOD_INDEX_SCALING | GFSK Modulation Index Scaling Factor This register selects the amount to scale the Transmitter Modulation Word in GFSK Protocols. Transmit modulation scaling adds the capability to scale the GFSK modulated output up or down by a factor of 1/32, 1/16 or 1/8. This is equivalent to having some additional programmability of the modulation index. 000b - 1 001b - 1 + 1/32 010b - 1 + 1/16 011b - 1 + 1/8 100b - 1 - 1/32 101b - 1 - 1/16 110b - 1 - 1/8 111b - Reserved |
| 23-22 — | Reserved |
| 21 GFSK_FLD | Disable GFSK Filter Lookup Table If this bit is set, the internal GFSK filter coefficients that are normally derived from a lookup table based on the reference clock frequency, are disabled, and the coefficients are instead derived from the GFSK_FILTER_COEFF_MANUAL1 and GFSK_FILTER_COEFF_MANUAL2 registers. |
| 20 GFSK_MLD | Disable GFSK Multiply Lookup Table If this bit is set, the GFSK Multiply Lookup table is disabled and GFSK_MULTIPLY_TABLE_MANUAL is used instead. |
| 19-18 — | Reserved |
| 17-16 GFSK_MI | GFSK Modulation Index This register selects the GFSK Modulation Index which, together with the GFSK Symbol Rate, determines the Peak Modulation frequency. The formula used for the Peak Modulation is { Symbol Rate / (2 x 1/Modulation Index) } 00b - 0.32 |

Table continues on the next page...

Radio Register Overview

| Field | Function |
|------------------------------------|--|
| | 01b - 0.50 10b - 0.70 11b - 1.00 |
| 15-0 GFSK_MULTIPLY_TABLE_MANUAL | Manual GFSK Multiply Lookup Table Value The GFSK Modulator Multiplier uses a lookup table to select the multiplicand representing the { Frequency Deviation divided by the Low Port Sigma Delta LSB resolution in Hz } for the Modulation requested based on the Modulation Index, the Symbol Rate, and the Reference Clock Frequency. The lookup table value is overridden by this register if GFSK_MLD is set, and these bits should then contain a number that represents { FDev/SD_LSB integer[11:0] + FDev/SD_LSB fraction[3:0] } |

45.2.2.1.5 TX GFSK Filter Coefficients 2 (GFSK_COEFF2)

45.2.2.1.5.1 Address

| Register | Offset |
|-------------|-----------|
| GFSK_COEFF2 | 4005C20Ch |

45.2.2.1.5.2 Function

The two registers TX_GFSK_COEFF1 and TX_GFSK_COEFF2 form a 64-bit little endian register that is memory mapped internally as shown to override the GFSK Filter Coefficients.

In 64-bit they combine as {TX_GFSK_COEFF2[31:0],TX_GFSK_COEFF1[31:0]}

The resulting 64-bit value is the GFSK Manual Filter Coefficient [63:0]

45.2.2.1.5.3 Diagram

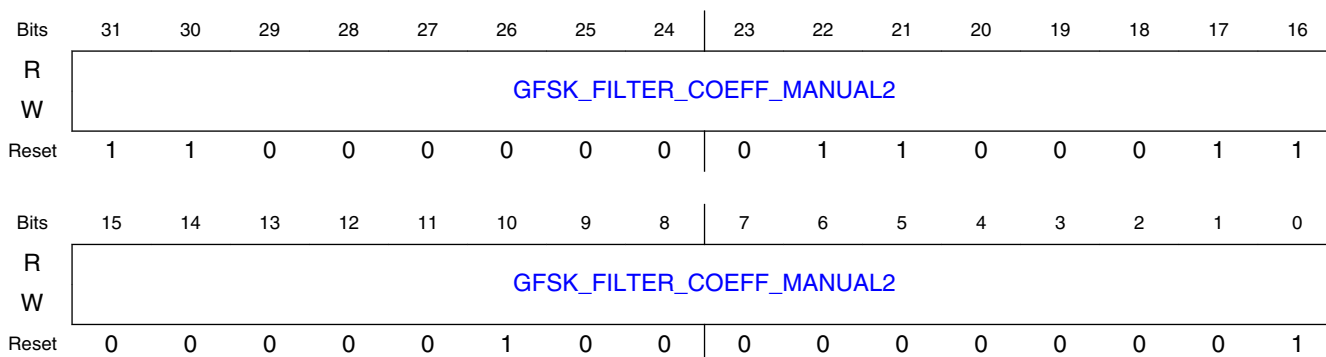

45.2.2.1.5.4 Fields

| Field | Function | | | | | | | | | | |
|------------------------------------|---|------|---------------------|---------|-----------------------|---------|-----------------------|---------|-----------------------|---------|-----------------------|
| 31-0 GFSK_FILTER_COEFF_MANU_AL2 | GFSK Manual Filter Coefficients[63:32] If GFSK_FLD is set, the GFSK Filter Coefficients are overridden using the bits as described below, and since the filter is symmetrical each coefficient is used twice. | | | | | | | | | | |
| | <table border="1"> <thead> <tr> <th>Bits</th> <th>Filter Coefficients</th> </tr> </thead> <tbody> <tr> <td>[36:32]</td> <td>Filter coeff 0 and 15</td> </tr> <tr> <td>[45:40]</td> <td>Filter coeff 1 and 14</td> </tr> <tr> <td>[55:48]</td> <td>Filter coeff 4 and 11</td> </tr> <tr> <td>[63:56]</td> <td>Filter coeff 5 and 10</td> </tr> </tbody> </table> | Bits | Filter Coefficients | [36:32] | Filter coeff 0 and 15 | [45:40] | Filter coeff 1 and 14 | [55:48] | Filter coeff 4 and 11 | [63:56] | Filter coeff 5 and 10 |
| Bits | Filter Coefficients | | | | | | | | | | |
| [36:32] | Filter coeff 0 and 15 | | | | | | | | | | |
| [45:40] | Filter coeff 1 and 14 | | | | | | | | | | |
| [55:48] | Filter coeff 4 and 11 | | | | | | | | | | |
| [63:56] | Filter coeff 5 and 10 | | | | | | | | | | |

45.2.2.1.6 TX GFSK Filter Coefficients 1 (GFSK_COEFF1)

45.2.2.1.6.1 Address

| Register | Offset |
|-------------|-----------|
| GFSK_COEFF1 | 4005C210h |

45.2.2.1.6.2 Function

The two registers TX_GFSK_COEFF1 and TX_GFSK_COEFF2 form a 64-bit little endian register that is memory mapped internally as shown to override the GFSK Filter Coefficients.

In 64-bit they combine as {TX_GFSK_COEFF2[31:0],TX_GFSK_COEFF1[31:0]}

The resulting 64-bit value is the GFSK Manual Filter Coefficient [63:0]

45.2.2.1.6.3 Diagram

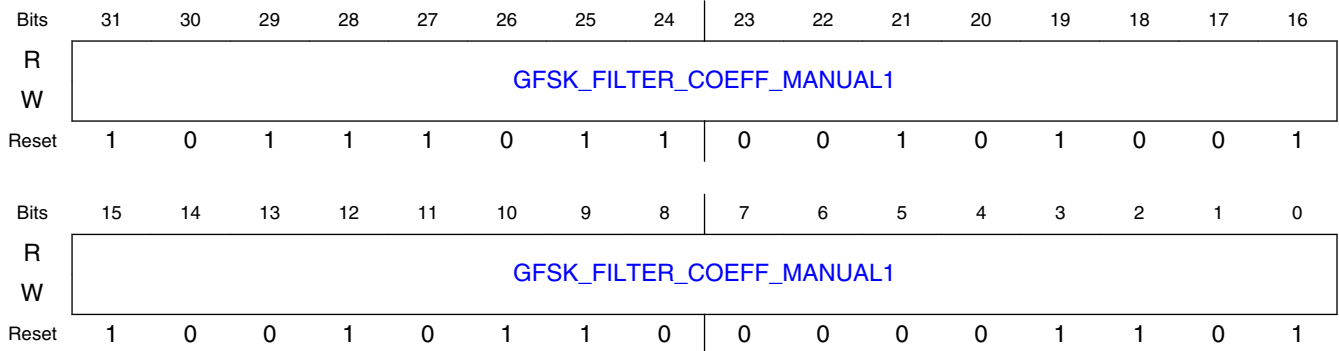

45.2.2.1.6.4 Fields

| Field | Function | | | | | | | | | | |
|---------------------------|--|------|-------------------------|-------|-----------------------|--------|----------------------|---------|-----------------------|---------|----------------------|
| 31-0 | GFSK Manual Filter Coefficient [31:0] | | | | | | | | | | |
| GFSK_FILTER_COEFF_MANUAL1 | If GFSK_FLD is set, the GFSK Filter Coefficients are overridden using the bits as described below, and since the filter is symmetrical each coefficient is used twice. | | | | | | | | | | |
| | <table border="1"> <thead> <tr> <th>Bits</th> <th>000 Filter Coefficients</th> </tr> </thead> <tbody> <tr> <td>[6:0]</td> <td>Filter coeff 2 and 13</td> </tr> <tr> <td>[15:7]</td> <td>Filter coeff 6 and 9</td> </tr> <tr> <td>[22:16]</td> <td>Filter coeff 3 and 12</td> </tr> <tr> <td>[31:23]</td> <td>Filter coeff 7 and 8</td> </tr> </tbody> </table> | Bits | 000 Filter Coefficients | [6:0] | Filter coeff 2 and 13 | [15:7] | Filter coeff 6 and 9 | [22:16] | Filter coeff 3 and 12 | [31:23] | Filter coeff 7 and 8 |
| Bits | 000 Filter Coefficients | | | | | | | | | | |
| [6:0] | Filter coeff 2 and 13 | | | | | | | | | | |
| [15:7] | Filter coeff 6 and 9 | | | | | | | | | | |
| [22:16] | Filter coeff 3 and 12 | | | | | | | | | | |
| [31:23] | Filter coeff 7 and 8 | | | | | | | | | | |

45.2.2.1.7 TX FSK Modulation Levels (FSK_SCALE)

45.2.2.1.7.1 Address

| Register | Offset |
|-----------|-----------|
| FSK_SCALE | 4005C214h |

45.2.2.1.7.2 Diagram

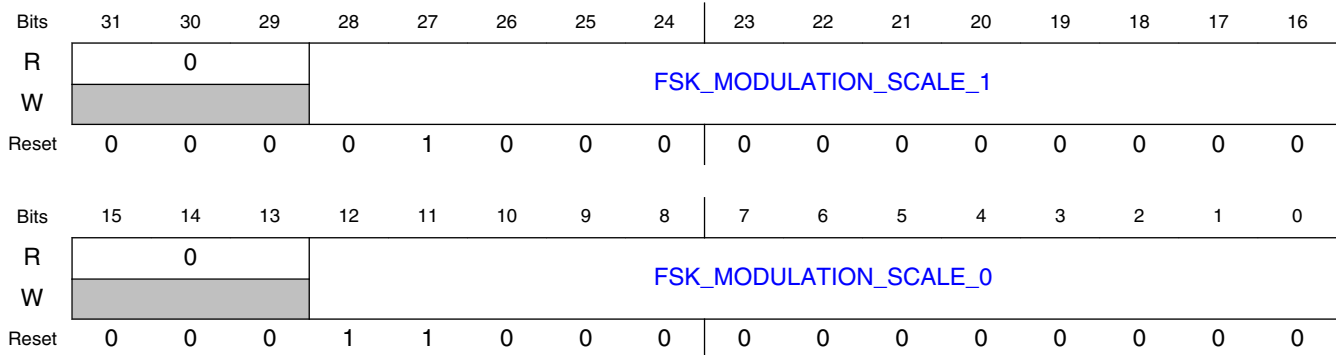

45.2.2.1.7.3 Fields

| Field | Function |
|---------------------------------|--|
| 31-29 — | Reserved |
| 28-16 FSK_MODULATION_SCALE_1 | FSK Modulation Scale for a data 1 This register is used to provide the modulation level for a data 1 in 802.15.4 Protocols. The signed 12 bit value that is represented by this register is presented to the PLL as the Baseband Frequency Word. The frequency result for this Modulation Scale will be the value of this register times the PLL Low Port Modulator Frequency Resolution; a typical value for the Frequency Resolution is 244.14 Hz. The range of signed values that this register supports is -4096 to 4095 |
| 15-13 — | Reserved |
| 12-0 FSK_MODULATION_SCALE_0 | FSK Modulation Scale for a data 0 This register is used to provide the modulation level for a data 0 in 802.15.4 Protocols. The signed 12 bit value that is represented by this register is presented to the PLL as the Baseband Frequency Word. The frequency result for this Modulation Scale will be the value of this register times the PLL Low Port Modulator Frequency Resolution; a typical value for the Frequency Resolution is 244.14 Hz. The range of signed values that this register supports is -4096 to 4095 |

45.2.2.1.8 TX DFT Modulation Pattern (DFT_PATTERN)

45.2.2.1.8.1 Address

| Register | Offset |
|-------------|-----------|
| DFT_PATTERN | 4005C218h |

45.2.2.1.8.2 Diagram

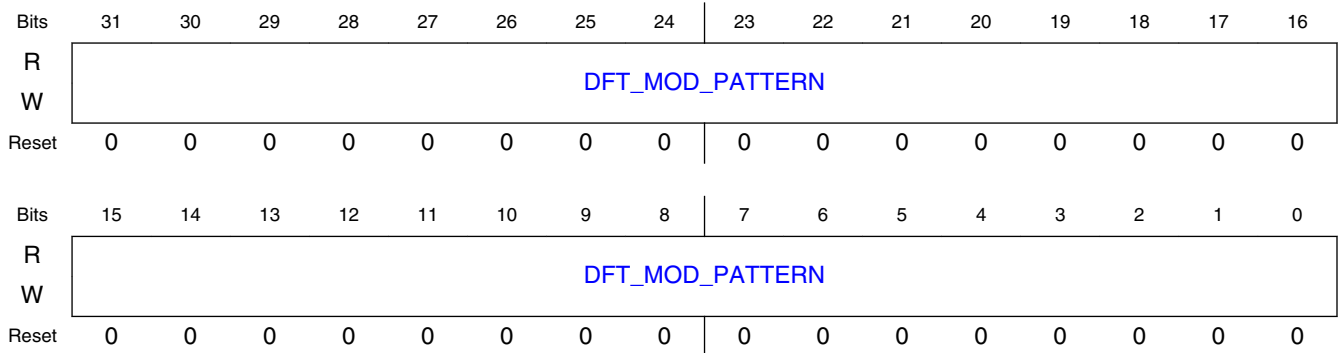

45.2.2.1.8.3 Fields

| Field | Function |
|-----------------|--|
| 31-0 | DFT Modulation Pattern |
| DFT_MOD_PATTERN | In TX DFT Pattern Register modes, if TX_DFT_EN is set, the bits in this register will be shifted out as the DFT Modulation Data in a repeating loop starting with bit [0]. |

45.2.2.2 XCVR_PLL_DIG Register Descriptions

45.2.2.2.1 XCVR_PLL_DIG_ADDR Memory Map

Base address: 4005C224h

| Offset | Register | Width (In bits) | Access | Reset value |
|-----------|--|-----------------|--------|-------------|
| 4005C224h | PLL HPM Analog Bump Control (HPM_BUMP) | 32 | RW | 00001010h |
| 4005C228h | PLL Modulation Control (MOD_CTRL) | 32 | RW | 00000000h |
| 4005C22Ch | PLL Channel Mapping (CHAN_MAP) | 32 | RW | 00000200h |
| 4005C230h | PLL Lock Detect Control (LOCK_DETECT) | 32 | RW | 00606800h |
| 4005C234h | PLL High Port Modulator Control (HPM_CTRL) | 32 | RW | 90840000h |
| 4005C244h | PLL High Port Sigma Delta Results (HPM_SDM_RES) | 32 | RW | 01000000h |
| 4005C248h | PLL Low Port Modulator Control (LPM_CTRL) | 32 | RW | 08080000h |
| 4005C24Ch | PLL Low Port Sigma Delta Control 1 (LPM_SDM_CTRL1) | 32 | RW | 00260026h |
| 4005C250h | PLL Low Port Sigma Delta Control 2 (LPM_SDM_CTRL2) | 32 | RW | 02000000h |
| 4005C254h | PLL Low Port Sigma Delta Control 3 (LPM_SDM_CTRL3) | 32 | RW | 04000000h |
| 4005C258h | PLL Low Port Sigma Delta Result 1 (LPM_SDM_RES1) | 32 | RO | 0E200000h |

Table continues on the next page...

| Offset | Register | Width (In bits) | Access | Reset value |
|-----------|--|--------------------|--------|-------------|
| 4005C25Ch | PLL Low Port Sigma Delta Result 2 (LPM_SDM_RES2) | 32 | RO | 04000000h |
| 4005C260h | PLL Delay Matching (DELAY_MATCH) | 32 | RW | 00000204h |
| 4005C264h | PLL Coarse Tune Control (CTUNE_CTRL) | 32 | RW | 00000000h |
| 4005C278h | PLL Coarse Tune Results (CTUNE_RES) | 32 | RO | 09620040h |

45.2.2.2.2 PLL HPM Analog Bump Control (HPM_BUMP)

45.2.2.2.2.1 Address

| Register | Offset |
|----------|-----------|
| HPM_BUMP | 4005C224h |

45.2.2.2.2.2 Diagram

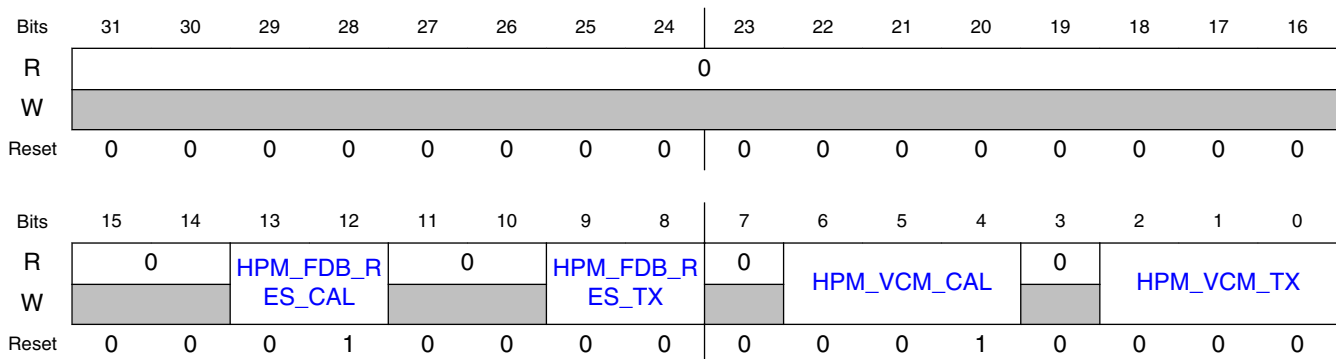

45.2.2.2.2.3 Fields

| Field | Function |
|------------------------------|---|
| 31-14 Reserved | Reserved |
| 13-12 HPM_FDB_RES _CAL | <p>rfctrl_tx_dac_bump_fdb_res[1:0] during Calibration</p> <p>This is the value applied to the rfctrl_tx_dac_bump_fdb_res[1:0] port during High Port Calibration.</p> <p>This register sets the HPM DAC feedback resistor to increase the modulation gain during calibration.</p> <p>00b - 29 kohms 01b - 58 kohms(gain of 2) 10b - 13 kohms 11b - 23.7 kohms</p> |

Table continues on the next page...

Radio Register Overview

| Field | Function |
|---------------------------|---|
| 11-10 — | Reserved |
| 9-8 HPM_FDB_RES _TX | <p>rfctrl_tx_dac_bump_fdb_res[1:0] during Transmission</p> <p>This is the value applied to the rfctrl_tx_dac_bump_fdb_res[1:0] port during Radio Transmissions.</p> <p>This register sets the HPM DAC feedback resistor during transmissions.</p> <p>00b - 29 kohms 01b - 58 kohms(gain of 2) 10b - 13 kohms 11b - 23.7 kohms</p> |
| 7 — | Reserved |
| 6-4 HPM_VCM_CA L | <p>rfctrl_tx_dac_bump_vcm[2:0] during Calibration</p> <p>This is the value applied to the rfctrl_tx_dac_bump_vcm[2:0] port during High Port Calibration.</p> <p>This register sets the HPM DAC Op-Amp reference voltage during calibration.</p> <p>000b - 432 mV 001b - 328 mV 010b - 456 mV 011b - 473 mV 100b - 488 mV 101b - 408 mV 110b - 392 mV 111b - 376 mV</p> |
| 3 — | Reserved |
| 2-0 HPM_VCM_TX | <p>rfctrl_tx_dac_bump_vcm[2:0] during Transmission</p> <p>This is the value applied to the rfctrl_tx_dac_bump_vcm[2:0] port during Radio Transmissions.</p> <p>This register sets the HPM DAC Op-Amp reference voltage during transmissions.</p> <p>000b - 432 mV 001b - 328 mV 010b - 456 mV 011b - 473 mV 100b - 488 mV 101b - 408 mV 110b - 392 mV 111b - 376 mV</p> |

45.2.2.2.3 PLL Modulation Control (MOD_CTRL)

45.2.2.2.3.1 Address

| Register | Offset |
|----------|-----------|
| MOD_CTRL | 4005C228h |

45.2.2.2.3.2 Diagram

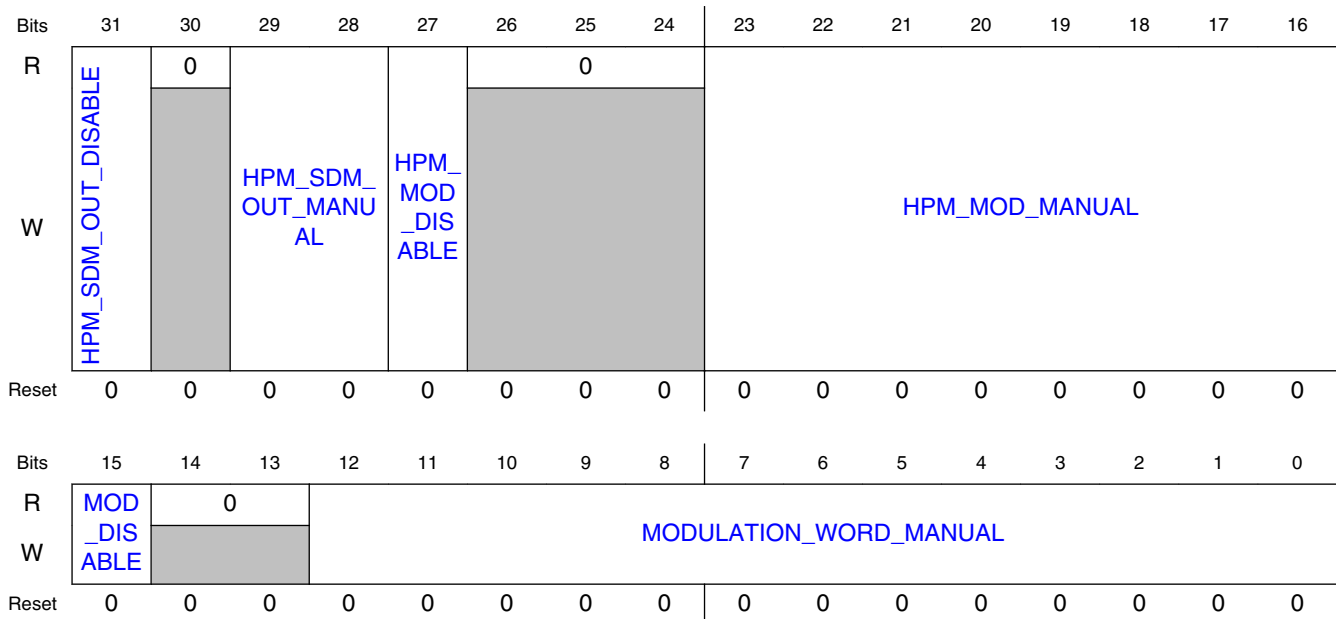

45.2.2.2.3.3 Fields

| Field | Function |
|-----------------------------|--|
| 31 HPM_SDM_OUT_DISABLE | Disable HPM SDM out If this bit is set, the High Port Sigma Delta Modulator output is disabled, and the High Port Fractional value applied to the VCO comes from the HPM_SDM_OUT_MANUAL register. |
| 30 — | Reserved |
| 29-28 HPM_SDM_OUT_MANUAL | Manual HPM SDM out If HPM_SDM_OUT_DISABLE is set, this register is the Fractional value that is applied to the VCO High Port. |
| 27 HPM_MOD_DISABLE | Disable HPM Modulation If this bit is set, the High Port Modulation is disabled, and the High Port Modulation value applied to the VCO comes from the HPM_MOD_MANUAL register. |
| 26-24 — | Reserved |
| 23-16 HPM_MOD_MANUAL | Manual HPM Modulation If HPM_MOD_DISABLE is set, this register is the modulation value that is applied to the VCO High Port. |
| 15 MOD_DISABLE | Disable Modulation Word If this bit is set, any modulation from the TX Digital is disabled and the source of the Baseband Frequency Word is the MODULATION_WORD_MANUAL register. |
| 14-13 | Reserved |

Table continues on the next page...

Radio Register Overview

| Field | Function |
|---------------------------------|---|
| — | |
| 12-0 MODULATION_ WORD_MANUAL | Manual Modulation Word If MOD_DISABLE is set, the signed 12 bit value that is represented by this register is the Baseband Frequency Word. |

45.2.2.2.4 PLL Channel Mapping (CHAN_MAP)

45.2.2.2.4.1 Address

| Register | Offset |
|----------|-----------|
| CHAN_MAP | 4005C22Ch |

45.2.2.2.4.2 Diagram

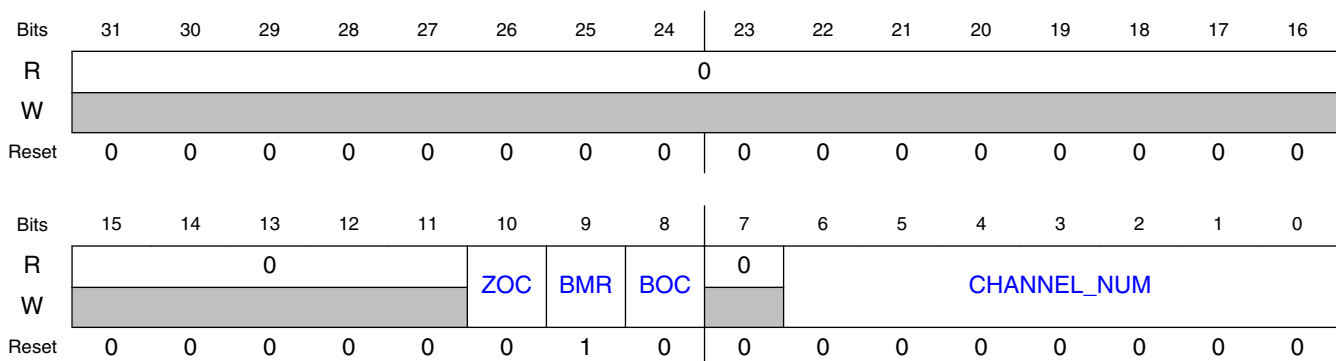

45.2.2.2.4.3 Fields

| Field | Function |
|-------------------|--|
| 31-11 Reserved | Reserved |
| 10 ZOC | 802.15.4 Channel Number Override This bit controls the source of the 802.15.4 channel selection. 0b - 802.15.4 channel number comes from the 802.15.4 Link Layer. 1b - 802.15.4 channel number comes from the CHANNEL_NUM register (802.15.4 protocols 4 and 5) |
| 9 BMR | BLE MBAN Channel Remap This bit controls the mapping of BLE channel 39 in Radio Protocol 2, BLE overlap MBAN mode. 0b - BLE channel 39 is mapped to BLE channel 39, 2.480 GHz |

Table continues on the next page...

| Field | Function | | | | | | | | | | | | | | | | | | | | | | | | | | | | | | | | | | | | | | | | | | | | | | | | | | | | | | | | | | | | | | | | | | | | | | | | | | | | | | | | | | | | | | | | | | | | | | | | | | | | | | | | | | | | | | | | | | | | | | | | | | | | | | | | | | | | | | | | | | | | | | | | | | | | | | | | | | | | | | | | | | | | | | | | | | | | | | | | | | | | | | | | | | | | | | | | | | | | | | | | | | | | | | | | | | | | | | | | | | | | | | | | | | | | | | |
|---|---|---|-------|------------------|-------|----------|-------|----------------|-------|--|--|-----|--|------|--|------------------|--|----------|--|----------------|--|---|--|---|--|---|--|---|--|---|--|------|-----|------|-----|------|-----|------|-----|------|-----|---|-------|---|-------|---|-------|----|-------|---|-------|---|-------|---|-------|---|-------|----|-------|---|-------|---|-------|---|-------|---|-------|----|-------|---|-------|---|-------|---|-------|---|-------|----|-------|---|-------|---|-------|---|-------|---|-------|----|-------|---|-------|---|-------|---|-------|---|-------|----|-------|---|-------|---|-------|---|-------|---|-------|----|-------|---|-------|---|-------|---|-------|---|-------|----|-------|---|-------|---|-------|---|-------|---|-------|----|-------|---|-------|---|-------|---|-------|---|-------|----|-------|---|-------|----|-------|----|-------|----|-------|----|-------|----|-------|----|-------|----|-------|----|-------|----|-------|----|-------|----|-------|----|-------|----|-------|----|-------|----|-------|----|-------|----|-------|----|-------|----|-------|----|-------|----|-------|----|-------|----|-------|----|-------|----|-------|----|-------|----|-------|----|-------|----|-------|--|--|----|-------|----|-------|----|-------|--|--|--|--|----|-------|----|-------|----|-------|--|--|--|--|----|-------|----|-------|----|-------|--|--|--|--|
| | 1b - BLE channel 39 is mapped to MBAN channel 39, 2.399 GHz | | | | | | | | | | | | | | | | | | | | | | | | | | | | | | | | | | | | | | | | | | | | | | | | | | | | | | | | | | | | | | | | | | | | | | | | | | | | | | | | | | | | | | | | | | | | | | | | | | | | | | | | | | | | | | | | | | | | | | | | | | | | | | | | | | | | | | | | | | | | | | | | | | | | | | | | | | | | | | | | | | | | | | | | | | | | | | | | | | | | | | | | | | | | | | | | | | | | | | | | | | | | | | | | | | | | | | | | | | | | | | | | | | | | | | |
| 8 BOC | BLE Channel Number Override This bit controls the source of the BLE channel selection. 0b - BLE channel number comes from the BLE Link Layer 1b - BLE channel number comes from the CHANNEL_NUM register (BLE protocols 0 and 2) | | | | | | | | | | | | | | | | | | | | | | | | | | | | | | | | | | | | | | | | | | | | | | | | | | | | | | | | | | | | | | | | | | | | | | | | | | | | | | | | | | | | | | | | | | | | | | | | | | | | | | | | | | | | | | | | | | | | | | | | | | | | | | | | | | | | | | | | | | | | | | | | | | | | | | | | | | | | | | | | | | | | | | | | | | | | | | | | | | | | | | | | | | | | | | | | | | | | | | | | | | | | | | | | | | | | | | | | | | | | | | | | | | | | | | |
| 7 — | Reserved | | | | | | | | | | | | | | | | | | | | | | | | | | | | | | | | | | | | | | | | | | | | | | | | | | | | | | | | | | | | | | | | | | | | | | | | | | | | | | | | | | | | | | | | | | | | | | | | | | | | | | | | | | | | | | | | | | | | | | | | | | | | | | | | | | | | | | | | | | | | | | | | | | | | | | | | | | | | | | | | | | | | | | | | | | | | | | | | | | | | | | | | | | | | | | | | | | | | | | | | | | | | | | | | | | | | | | | | | | | | | | | | | | | | | | |
| 6-0 CHANNEL_NUM | <p>Protocol specific Channel Number for PLL Frequency Mapping</p> <p>When this register is active, it can be used to directly select a Protocol specific Channel Number, which is mapped internally to the correct Radio Carrier Frequency for PLL tuning. The internal mapping is detailed in the table below.</p> <p>This register is active when BOC or ZOC are set along with their corresponding Radio Protocols, and this register is also active in protocols 1, 6 and 7.</p> <p>The Radio Channel Frequency can also be selected by setting the SDM_MAP_DISABLE bit in the PLL_LPM_SDM_CTRL1 register along with the LPM_INTG, LPM_NUM, and LPM_DENOM registers to get a frequency that equals ((Reference Clock Frequency x 2) x (LPM_INTG + (LPM_NUM / LPM_DENOM))</p> <p>This table shows the internal mapping by Protocol of the Channel Numbers to the Radio Carrier Frequency (MHz).</p> <table border="1" style="width: 100%; border-collapse: collapse; text-align: center;"> <thead> <tr> <th colspan="10">Radio Protocols Supported, Channel Frequency in MHz</th> </tr> <tr> <th colspan="2">BLE</th> <th colspan="2">MBAN</th> <th colspan="2">BLE Overlap MBAN</th> <th colspan="2">802.15.4</th> <th colspan="2">802.15.4j MBAN</th> </tr> <tr> <th colspan="2">0</th> <th colspan="2">1</th> <th colspan="2">2</th> <th colspan="2">3</th> <th colspan="2">4</th> </tr> <tr> <th>Chan</th> <th>MHz</th> <th>Chan</th> <th>MHz</th> <th>Chan</th> <th>MHz</th> <th>Chan</th> <th>MHz</th> <th>Chan</th> <th>MHz</th> </tr> </thead> <tbody> <tr><td>0</td><td>2,402</td><td>0</td><td>2,360</td><td>0</td><td>2,402</td><td>11</td><td>2,405</td><td>0</td><td>2,363</td></tr> <tr><td>1</td><td>2,404</td><td>1</td><td>2,361</td><td>1</td><td>2,404</td><td>12</td><td>2,410</td><td>1</td><td>2,368</td></tr> <tr><td>2</td><td>2,406</td><td>2</td><td>2,362</td><td>2</td><td>2,406</td><td>13</td><td>2,415</td><td>2</td><td>2,373</td></tr> <tr><td>3</td><td>2,408</td><td>3</td><td>2,363</td><td>3</td><td>2,408</td><td>14</td><td>2,420</td><td>3</td><td>2,378</td></tr> <tr><td>4</td><td>2,410</td><td>4</td><td>2,364</td><td>4</td><td>2,410</td><td>15</td><td>2,425</td><td>4</td><td>2,383</td></tr> <tr><td>5</td><td>2,412</td><td>5</td><td>2,365</td><td>5</td><td>2,412</td><td>16</td><td>2,430</td><td>5</td><td>2,388</td></tr> <tr><td>6</td><td>2,414</td><td>6</td><td>2,366</td><td>6</td><td>2,414</td><td>17</td><td>2,435</td><td>6</td><td>2,393</td></tr> <tr><td>7</td><td>2,416</td><td>7</td><td>2,367</td><td>7</td><td>2,416</td><td>18</td><td>2,440</td><td>7</td><td>2,367</td></tr> <tr><td>8</td><td>2,418</td><td>8</td><td>2,368</td><td>8</td><td>2,418</td><td>19</td><td>2,445</td><td>8</td><td>2,372</td></tr> <tr><td>9</td><td>2,420</td><td>9</td><td>2,369</td><td>9</td><td>2,420</td><td>20</td><td>2,450</td><td>9</td><td>2,377</td></tr> <tr><td>10</td><td>2,422</td><td>10</td><td>2,370</td><td>10</td><td>2,422</td><td>21</td><td>2,455</td><td>10</td><td>2,382</td></tr> <tr><td>11</td><td>2,424</td><td>11</td><td>2,371</td><td>11</td><td>2,424</td><td>22</td><td>2,460</td><td>11</td><td>2,387</td></tr> <tr><td>12</td><td>2,426</td><td>12</td><td>2,372</td><td>12</td><td>2,426</td><td>23</td><td>2,465</td><td>12</td><td>2,392</td></tr> <tr><td>13</td><td>2,428</td><td>13</td><td>2,373</td><td>13</td><td>2,428</td><td>24</td><td>2,470</td><td>13</td><td>2,397</td></tr> <tr><td>14</td><td>2,430</td><td>14</td><td>2,374</td><td>14</td><td>2,430</td><td>25</td><td>2,475</td><td>14</td><td>2,395</td></tr> <tr><td>15</td><td>2,432</td><td>15</td><td>2,375</td><td>15</td><td>2,432</td><td>26</td><td>2,480</td><td></td><td></td></tr> <tr><td>16</td><td>2,434</td><td>16</td><td>2,376</td><td>16</td><td>2,434</td><td></td><td></td><td></td><td></td></tr> <tr><td>17</td><td>2,436</td><td>17</td><td>2,377</td><td>17</td><td>2,436</td><td></td><td></td><td></td><td></td></tr> <tr><td>18</td><td>2,438</td><td>18</td><td>2,378</td><td>18</td><td>2,438</td><td></td><td></td><td></td><td></td></tr> </tbody> </table> | Radio Protocols Supported, Channel Frequency in MHz | | | | | | | | | | BLE | | MBAN | | BLE Overlap MBAN | | 802.15.4 | | 802.15.4j MBAN | | 0 | | 1 | | 2 | | 3 | | 4 | | Chan | MHz | Chan | MHz | Chan | MHz | Chan | MHz | Chan | MHz | 0 | 2,402 | 0 | 2,360 | 0 | 2,402 | 11 | 2,405 | 0 | 2,363 | 1 | 2,404 | 1 | 2,361 | 1 | 2,404 | 12 | 2,410 | 1 | 2,368 | 2 | 2,406 | 2 | 2,362 | 2 | 2,406 | 13 | 2,415 | 2 | 2,373 | 3 | 2,408 | 3 | 2,363 | 3 | 2,408 | 14 | 2,420 | 3 | 2,378 | 4 | 2,410 | 4 | 2,364 | 4 | 2,410 | 15 | 2,425 | 4 | 2,383 | 5 | 2,412 | 5 | 2,365 | 5 | 2,412 | 16 | 2,430 | 5 | 2,388 | 6 | 2,414 | 6 | 2,366 | 6 | 2,414 | 17 | 2,435 | 6 | 2,393 | 7 | 2,416 | 7 | 2,367 | 7 | 2,416 | 18 | 2,440 | 7 | 2,367 | 8 | 2,418 | 8 | 2,368 | 8 | 2,418 | 19 | 2,445 | 8 | 2,372 | 9 | 2,420 | 9 | 2,369 | 9 | 2,420 | 20 | 2,450 | 9 | 2,377 | 10 | 2,422 | 10 | 2,370 | 10 | 2,422 | 21 | 2,455 | 10 | 2,382 | 11 | 2,424 | 11 | 2,371 | 11 | 2,424 | 22 | 2,460 | 11 | 2,387 | 12 | 2,426 | 12 | 2,372 | 12 | 2,426 | 23 | 2,465 | 12 | 2,392 | 13 | 2,428 | 13 | 2,373 | 13 | 2,428 | 24 | 2,470 | 13 | 2,397 | 14 | 2,430 | 14 | 2,374 | 14 | 2,430 | 25 | 2,475 | 14 | 2,395 | 15 | 2,432 | 15 | 2,375 | 15 | 2,432 | 26 | 2,480 | | | 16 | 2,434 | 16 | 2,376 | 16 | 2,434 | | | | | 17 | 2,436 | 17 | 2,377 | 17 | 2,436 | | | | | 18 | 2,438 | 18 | 2,378 | 18 | 2,438 | | | | |
| Radio Protocols Supported, Channel Frequency in MHz | | | | | | | | | | | | | | | | | | | | | | | | | | | | | | | | | | | | | | | | | | | | | | | | | | | | | | | | | | | | | | | | | | | | | | | | | | | | | | | | | | | | | | | | | | | | | | | | | | | | | | | | | | | | | | | | | | | | | | | | | | | | | | | | | | | | | | | | | | | | | | | | | | | | | | | | | | | | | | | | | | | | | | | | | | | | | | | | | | | | | | | | | | | | | | | | | | | | | | | | | | | | | | | | | | | | | | | | | | | | | | | | | | | | | | | |
| BLE | | MBAN | | BLE Overlap MBAN | | 802.15.4 | | 802.15.4j MBAN | | | | | | | | | | | | | | | | | | | | | | | | | | | | | | | | | | | | | | | | | | | | | | | | | | | | | | | | | | | | | | | | | | | | | | | | | | | | | | | | | | | | | | | | | | | | | | | | | | | | | | | | | | | | | | | | | | | | | | | | | | | | | | | | | | | | | | | | | | | | | | | | | | | | | | | | | | | | | | | | | | | | | | | | | | | | | | | | | | | | | | | | | | | | | | | | | | | | | | | | | | | | | | | | | | | | | | | | | | | | | | | |
| 0 | | 1 | | 2 | | 3 | | 4 | | | | | | | | | | | | | | | | | | | | | | | | | | | | | | | | | | | | | | | | | | | | | | | | | | | | | | | | | | | | | | | | | | | | | | | | | | | | | | | | | | | | | | | | | | | | | | | | | | | | | | | | | | | | | | | | | | | | | | | | | | | | | | | | | | | | | | | | | | | | | | | | | | | | | | | | | | | | | | | | | | | | | | | | | | | | | | | | | | | | | | | | | | | | | | | | | | | | | | | | | | | | | | | | | | | | | | | | | | | | | | | |
| Chan | MHz | Chan | MHz | Chan | MHz | Chan | MHz | Chan | MHz | | | | | | | | | | | | | | | | | | | | | | | | | | | | | | | | | | | | | | | | | | | | | | | | | | | | | | | | | | | | | | | | | | | | | | | | | | | | | | | | | | | | | | | | | | | | | | | | | | | | | | | | | | | | | | | | | | | | | | | | | | | | | | | | | | | | | | | | | | | | | | | | | | | | | | | | | | | | | | | | | | | | | | | | | | | | | | | | | | | | | | | | | | | | | | | | | | | | | | | | | | | | | | | | | | | | | | | | | | | | | | |
| 0 | 2,402 | 0 | 2,360 | 0 | 2,402 | 11 | 2,405 | 0 | 2,363 | | | | | | | | | | | | | | | | | | | | | | | | | | | | | | | | | | | | | | | | | | | | | | | | | | | | | | | | | | | | | | | | | | | | | | | | | | | | | | | | | | | | | | | | | | | | | | | | | | | | | | | | | | | | | | | | | | | | | | | | | | | | | | | | | | | | | | | | | | | | | | | | | | | | | | | | | | | | | | | | | | | | | | | | | | | | | | | | | | | | | | | | | | | | | | | | | | | | | | | | | | | | | | | | | | | | | | | | | | | | | | |
| 1 | 2,404 | 1 | 2,361 | 1 | 2,404 | 12 | 2,410 | 1 | 2,368 | | | | | | | | | | | | | | | | | | | | | | | | | | | | | | | | | | | | | | | | | | | | | | | | | | | | | | | | | | | | | | | | | | | | | | | | | | | | | | | | | | | | | | | | | | | | | | | | | | | | | | | | | | | | | | | | | | | | | | | | | | | | | | | | | | | | | | | | | | | | | | | | | | | | | | | | | | | | | | | | | | | | | | | | | | | | | | | | | | | | | | | | | | | | | | | | | | | | | | | | | | | | | | | | | | | | | | | | | | | | | | |
| 2 | 2,406 | 2 | 2,362 | 2 | 2,406 | 13 | 2,415 | 2 | 2,373 | | | | | | | | | | | | | | | | | | | | | | | | | | | | | | | | | | | | | | | | | | | | | | | | | | | | | | | | | | | | | | | | | | | | | | | | | | | | | | | | | | | | | | | | | | | | | | | | | | | | | | | | | | | | | | | | | | | | | | | | | | | | | | | | | | | | | | | | | | | | | | | | | | | | | | | | | | | | | | | | | | | | | | | | | | | | | | | | | | | | | | | | | | | | | | | | | | | | | | | | | | | | | | | | | | | | | | | | | | | | | | |
| 3 | 2,408 | 3 | 2,363 | 3 | 2,408 | 14 | 2,420 | 3 | 2,378 | | | | | | | | | | | | | | | | | | | | | | | | | | | | | | | | | | | | | | | | | | | | | | | | | | | | | | | | | | | | | | | | | | | | | | | | | | | | | | | | | | | | | | | | | | | | | | | | | | | | | | | | | | | | | | | | | | | | | | | | | | | | | | | | | | | | | | | | | | | | | | | | | | | | | | | | | | | | | | | | | | | | | | | | | | | | | | | | | | | | | | | | | | | | | | | | | | | | | | | | | | | | | | | | | | | | | | | | | | | | | | |
| 4 | 2,410 | 4 | 2,364 | 4 | 2,410 | 15 | 2,425 | 4 | 2,383 | | | | | | | | | | | | | | | | | | | | | | | | | | | | | | | | | | | | | | | | | | | | | | | | | | | | | | | | | | | | | | | | | | | | | | | | | | | | | | | | | | | | | | | | | | | | | | | | | | | | | | | | | | | | | | | | | | | | | | | | | | | | | | | | | | | | | | | | | | | | | | | | | | | | | | | | | | | | | | | | | | | | | | | | | | | | | | | | | | | | | | | | | | | | | | | | | | | | | | | | | | | | | | | | | | | | | | | | | | | | | | |
| 5 | 2,412 | 5 | 2,365 | 5 | 2,412 | 16 | 2,430 | 5 | 2,388 | | | | | | | | | | | | | | | | | | | | | | | | | | | | | | | | | | | | | | | | | | | | | | | | | | | | | | | | | | | | | | | | | | | | | | | | | | | | | | | | | | | | | | | | | | | | | | | | | | | | | | | | | | | | | | | | | | | | | | | | | | | | | | | | | | | | | | | | | | | | | | | | | | | | | | | | | | | | | | | | | | | | | | | | | | | | | | | | | | | | | | | | | | | | | | | | | | | | | | | | | | | | | | | | | | | | | | | | | | | | | | |
| 6 | 2,414 | 6 | 2,366 | 6 | 2,414 | 17 | 2,435 | 6 | 2,393 | | | | | | | | | | | | | | | | | | | | | | | | | | | | | | | | | | | | | | | | | | | | | | | | | | | | | | | | | | | | | | | | | | | | | | | | | | | | | | | | | | | | | | | | | | | | | | | | | | | | | | | | | | | | | | | | | | | | | | | | | | | | | | | | | | | | | | | | | | | | | | | | | | | | | | | | | | | | | | | | | | | | | | | | | | | | | | | | | | | | | | | | | | | | | | | | | | | | | | | | | | | | | | | | | | | | | | | | | | | | | | |
| 7 | 2,416 | 7 | 2,367 | 7 | 2,416 | 18 | 2,440 | 7 | 2,367 | | | | | | | | | | | | | | | | | | | | | | | | | | | | | | | | | | | | | | | | | | | | | | | | | | | | | | | | | | | | | | | | | | | | | | | | | | | | | | | | | | | | | | | | | | | | | | | | | | | | | | | | | | | | | | | | | | | | | | | | | | | | | | | | | | | | | | | | | | | | | | | | | | | | | | | | | | | | | | | | | | | | | | | | | | | | | | | | | | | | | | | | | | | | | | | | | | | | | | | | | | | | | | | | | | | | | | | | | | | | | | |
| 8 | 2,418 | 8 | 2,368 | 8 | 2,418 | 19 | 2,445 | 8 | 2,372 | | | | | | | | | | | | | | | | | | | | | | | | | | | | | | | | | | | | | | | | | | | | | | | | | | | | | | | | | | | | | | | | | | | | | | | | | | | | | | | | | | | | | | | | | | | | | | | | | | | | | | | | | | | | | | | | | | | | | | | | | | | | | | | | | | | | | | | | | | | | | | | | | | | | | | | | | | | | | | | | | | | | | | | | | | | | | | | | | | | | | | | | | | | | | | | | | | | | | | | | | | | | | | | | | | | | | | | | | | | | | | |
| 9 | 2,420 | 9 | 2,369 | 9 | 2,420 | 20 | 2,450 | 9 | 2,377 | | | | | | | | | | | | | | | | | | | | | | | | | | | | | | | | | | | | | | | | | | | | | | | | | | | | | | | | | | | | | | | | | | | | | | | | | | | | | | | | | | | | | | | | | | | | | | | | | | | | | | | | | | | | | | | | | | | | | | | | | | | | | | | | | | | | | | | | | | | | | | | | | | | | | | | | | | | | | | | | | | | | | | | | | | | | | | | | | | | | | | | | | | | | | | | | | | | | | | | | | | | | | | | | | | | | | | | | | | | | | | |
| 10 | 2,422 | 10 | 2,370 | 10 | 2,422 | 21 | 2,455 | 10 | 2,382 | | | | | | | | | | | | | | | | | | | | | | | | | | | | | | | | | | | | | | | | | | | | | | | | | | | | | | | | | | | | | | | | | | | | | | | | | | | | | | | | | | | | | | | | | | | | | | | | | | | | | | | | | | | | | | | | | | | | | | | | | | | | | | | | | | | | | | | | | | | | | | | | | | | | | | | | | | | | | | | | | | | | | | | | | | | | | | | | | | | | | | | | | | | | | | | | | | | | | | | | | | | | | | | | | | | | | | | | | | | | | | |
| 11 | 2,424 | 11 | 2,371 | 11 | 2,424 | 22 | 2,460 | 11 | 2,387 | | | | | | | | | | | | | | | | | | | | | | | | | | | | | | | | | | | | | | | | | | | | | | | | | | | | | | | | | | | | | | | | | | | | | | | | | | | | | | | | | | | | | | | | | | | | | | | | | | | | | | | | | | | | | | | | | | | | | | | | | | | | | | | | | | | | | | | | | | | | | | | | | | | | | | | | | | | | | | | | | | | | | | | | | | | | | | | | | | | | | | | | | | | | | | | | | | | | | | | | | | | | | | | | | | | | | | | | | | | | | | |
| 12 | 2,426 | 12 | 2,372 | 12 | 2,426 | 23 | 2,465 | 12 | 2,392 | | | | | | | | | | | | | | | | | | | | | | | | | | | | | | | | | | | | | | | | | | | | | | | | | | | | | | | | | | | | | | | | | | | | | | | | | | | | | | | | | | | | | | | | | | | | | | | | | | | | | | | | | | | | | | | | | | | | | | | | | | | | | | | | | | | | | | | | | | | | | | | | | | | | | | | | | | | | | | | | | | | | | | | | | | | | | | | | | | | | | | | | | | | | | | | | | | | | | | | | | | | | | | | | | | | | | | | | | | | | | | |
| 13 | 2,428 | 13 | 2,373 | 13 | 2,428 | 24 | 2,470 | 13 | 2,397 | | | | | | | | | | | | | | | | | | | | | | | | | | | | | | | | | | | | | | | | | | | | | | | | | | | | | | | | | | | | | | | | | | | | | | | | | | | | | | | | | | | | | | | | | | | | | | | | | | | | | | | | | | | | | | | | | | | | | | | | | | | | | | | | | | | | | | | | | | | | | | | | | | | | | | | | | | | | | | | | | | | | | | | | | | | | | | | | | | | | | | | | | | | | | | | | | | | | | | | | | | | | | | | | | | | | | | | | | | | | | | |
| 14 | 2,430 | 14 | 2,374 | 14 | 2,430 | 25 | 2,475 | 14 | 2,395 | | | | | | | | | | | | | | | | | | | | | | | | | | | | | | | | | | | | | | | | | | | | | | | | | | | | | | | | | | | | | | | | | | | | | | | | | | | | | | | | | | | | | | | | | | | | | | | | | | | | | | | | | | | | | | | | | | | | | | | | | | | | | | | | | | | | | | | | | | | | | | | | | | | | | | | | | | | | | | | | | | | | | | | | | | | | | | | | | | | | | | | | | | | | | | | | | | | | | | | | | | | | | | | | | | | | | | | | | | | | | | |
| 15 | 2,432 | 15 | 2,375 | 15 | 2,432 | 26 | 2,480 | | | | | | | | | | | | | | | | | | | | | | | | | | | | | | | | | | | | | | | | | | | | | | | | | | | | | | | | | | | | | | | | | | | | | | | | | | | | | | | | | | | | | | | | | | | | | | | | | | | | | | | | | | | | | | | | | | | | | | | | | | | | | | | | | | | | | | | | | | | | | | | | | | | | | | | | | | | | | | | | | | | | | | | | | | | | | | | | | | | | | | | | | | | | | | | | | | | | | | | | | | | | | | | | | | | | | | | | | | | | | | | | |
| 16 | 2,434 | 16 | 2,376 | 16 | 2,434 | | | | | | | | | | | | | | | | | | | | | | | | | | | | | | | | | | | | | | | | | | | | | | | | | | | | | | | | | | | | | | | | | | | | | | | | | | | | | | | | | | | | | | | | | | | | | | | | | | | | | | | | | | | | | | | | | | | | | | | | | | | | | | | | | | | | | | | | | | | | | | | | | | | | | | | | | | | | | | | | | | | | | | | | | | | | | | | | | | | | | | | | | | | | | | | | | | | | | | | | | | | | | | | | | | | | | | | | | | | | | | | | | | |
| 17 | 2,436 | 17 | 2,377 | 17 | 2,436 | | | | | | | | | | | | | | | | | | | | | | | | | | | | | | | | | | | | | | | | | | | | | | | | | | | | | | | | | | | | | | | | | | | | | | | | | | | | | | | | | | | | | | | | | | | | | | | | | | | | | | | | | | | | | | | | | | | | | | | | | | | | | | | | | | | | | | | | | | | | | | | | | | | | | | | | | | | | | | | | | | | | | | | | | | | | | | | | | | | | | | | | | | | | | | | | | | | | | | | | | | | | | | | | | | | | | | | | | | | | | | | | | | |
| 18 | 2,438 | 18 | 2,378 | 18 | 2,438 | | | | | | | | | | | | | | | | | | | | | | | | | | | | | | | | | | | | | | | | | | | | | | | | | | | | | | | | | | | | | | | | | | | | | | | | | | | | | | | | | | | | | | | | | | | | | | | | | | | | | | | | | | | | | | | | | | | | | | | | | | | | | | | | | | | | | | | | | | | | | | | | | | | | | | | | | | | | | | | | | | | | | | | | | | | | | | | | | | | | | | | | | | | | | | | | | | | | | | | | | | | | | | | | | | | | | | | | | | | | | | | | | | |

Radio Register Overview

| Field | Function | | | | | | | | | |
|-------|----------|-------|----|-------|-----|-------|--|--|--|--|
| | 19 | 2,440 | 19 | 2,379 | 19 | 2,440 | | | | |
| | 20 | 2,442 | 20 | 2,380 | 20 | 2,442 | | | | |
| | 21 | 2,444 | 21 | 2,381 | 21 | 2,444 | | | | |
| | 22 | 2,446 | 22 | 2,382 | 22 | 2,446 | | | | |
| | 23 | 2,448 | 23 | 2,383 | 23 | 2,448 | | | | |
| | 24 | 2,450 | 24 | 2,384 | 24 | 2,450 | | | | |
| | 25 | 2,452 | 25 | 2,385 | 25 | 2,452 | | | | |
| | 26 | 2,454 | 26 | 2,386 | 26 | 2,454 | | | | |
| | 27 | 2,456 | 27 | 2,387 | 27 | 2,456 | | | | |
| | 28 | 2,458 | 28 | 2,388 | 28 | 2,458 | | | | |
| | 29 | 2,460 | 29 | 2,389 | 29 | 2,460 | | | | |
| | 30 | 2,462 | 30 | 2,390 | 30 | 2,390 | | | | |
| | 31 | 2,464 | 31 | 2,391 | 31 | 2,391 | | | | |
| | 32 | 2,466 | 32 | 2,392 | 32 | 2,392 | | | | |
| | 33 | 2,468 | 33 | 2,393 | 33 | 2,393 | | | | |
| | 34 | 2,470 | 34 | 2,394 | 34 | 2,394 | | | | |
| | 35 | 2,472 | 35 | 2,395 | 35 | 2,395 | | | | |
| | 36 | 2,474 | 36 | 2,396 | 36 | 2,396 | | | | |
| | 37 | 2,476 | 37 | 2,397 | 37 | 2,397 | | | | |
| | 38 | 2,478 | 38 | 2,398 | 38 | 2,398 | | | | |
| | 39 | 2,480 | 39 | 2,399 | 39* | 2,480 | | | | |

* The BLE MBAN Channel Remap bit, BMR, controls the frequency mapping in this case.

| Radio Protocols Supported, Channel Frequency in MHz | | | | | |
|---|-------|---------|-------|---------|-------|
| DFT, Generic | | | | | |
| 6,7,8,9 | | | | | |
| Channel | MHz | Channel | MHz | Channel | MHz |
| 0 | 2,360 | 43 | 2,403 | 86 | 2,446 |
| 1 | 2,361 | 44 | 2,404 | 87 | 2,447 |
| 2 | 2,362 | 45 | 2,405 | 88 | 2,448 |
| 3 | 2,363 | 46 | 2,406 | 89 | 2,449 |
| 4 | 2,364 | 47 | 2,407 | 90 | 2,450 |
| 5 | 2,365 | 48 | 2,408 | 91 | 2,451 |
| 6 | 2,366 | 49 | 2,409 | 92 | 2,452 |
| 7 | 2,367 | 50 | 2,410 | 93 | 2,453 |
| 8 | 2,368 | 51 | 2,411 | 94 | 2,454 |
| 9 | 2,369 | 52 | 2,412 | 95 | 2,455 |
| 10 | 2,370 | 53 | 2,413 | 96 | 2,456 |
| 11 | 2,371 | 54 | 2,414 | 97 | 2,457 |

| Field | Function | | | | | |
|-------|----------|-------|----|-------|-----|-------|
| | 12 | 2,372 | 55 | 2,415 | 98 | 2,458 |
| | 13 | 2,373 | 56 | 2,416 | 99 | 2,459 |
| | 14 | 2,374 | 57 | 2,417 | 100 | 2,460 |
| | 15 | 2,375 | 58 | 2,418 | 101 | 2,461 |
| | 16 | 2,376 | 59 | 2,419 | 102 | 2,462 |
| | 17 | 2,377 | 60 | 2,420 | 103 | 2,463 |
| | 18 | 2,378 | 61 | 2,421 | 104 | 2,464 |
| | 19 | 2,379 | 62 | 2,422 | 105 | 2,465 |
| | 20 | 2,380 | 63 | 2,423 | 106 | 2,466 |
| | 21 | 2,381 | 64 | 2,424 | 107 | 2,467 |
| | 22 | 2,382 | 65 | 2,425 | 108 | 2,468 |
| | 23 | 2,383 | 66 | 2,426 | 109 | 2,469 |
| | 24 | 2,384 | 67 | 2,427 | 110 | 2,470 |
| | 25 | 2,385 | 68 | 2,428 | 111 | 2,471 |
| | 26 | 2,386 | 69 | 2,429 | 112 | 2,472 |
| | 27 | 2,387 | 70 | 2,430 | 113 | 2,473 |
| | 28 | 2,388 | 71 | 2,431 | 114 | 2,474 |
| | 29 | 2,389 | 72 | 2,432 | 115 | 2,475 |
| | 30 | 2,390 | 73 | 2,433 | 116 | 2,476 |
| | 31 | 2,391 | 74 | 2,434 | 117 | 2,477 |
| | 32 | 2,392 | 75 | 2,435 | 118 | 2,478 |
| | 33 | 2,393 | 76 | 2,436 | 119 | 2,479 |
| | 34 | 2,394 | 77 | 2,437 | 120 | 2,480 |
| | 35 | 2,395 | 78 | 2,438 | 121 | 2,481 |
| | 36 | 2,396 | 79 | 2,439 | 122 | 2,482 |
| | 37 | 2,397 | 80 | 2,440 | 123 | 2,483 |
| | 38 | 2,398 | 81 | 2,441 | 124 | 2,484 |
| | 39 | 2,399 | 82 | 2,442 | 125 | 2,485 |
| | 40 | 2,400 | 83 | 2,443 | 126 | 2,486 |
| | 41 | 2,401 | 84 | 2,444 | 127 | 2,487 |
| | 42 | 2,402 | 85 | 2,445 | | |

45.2.2.2.5 PLL Lock Detect Control (LOCK_DETECT)

45.2.2.2.5.1 Address

| Register | Offset |
|-------------|-----------|
| LOCK_DETECT | 4005C230h |

45.2.2.2.5.2 Diagram

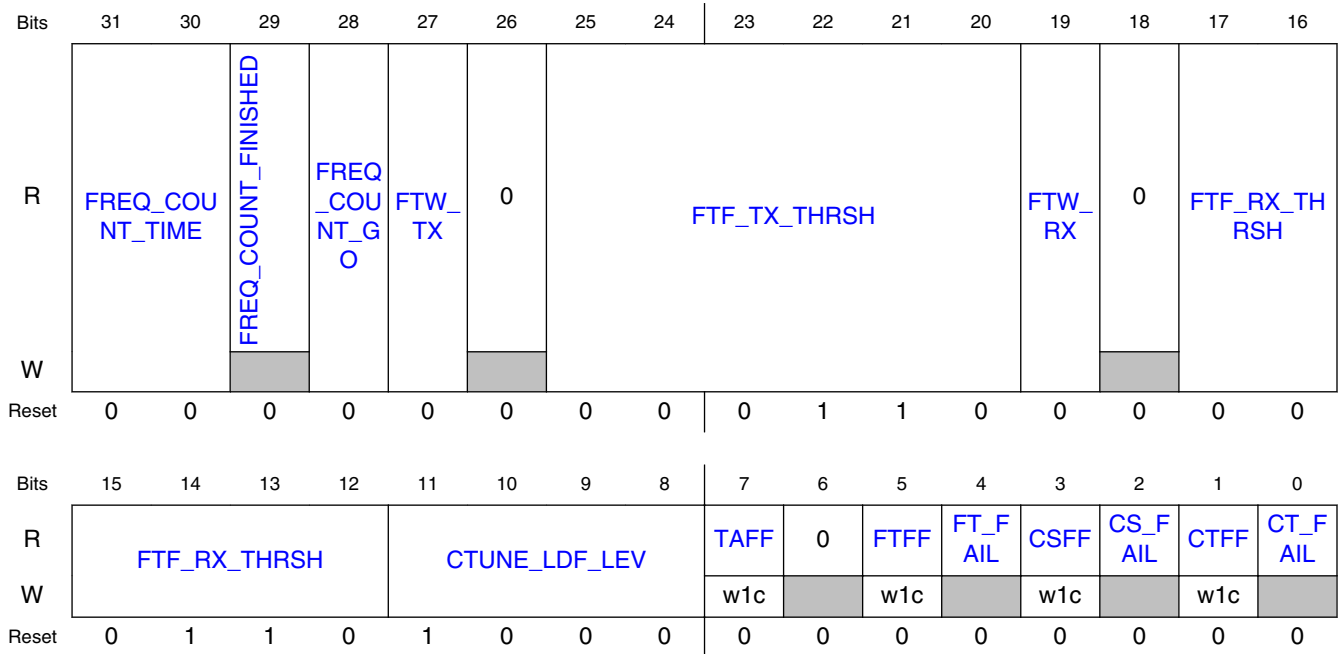

45.2.2.2.5.3 Fields

| Field | Function |
|---------------------------|---|
| 31-30 FREQ_COUNT_TIME | Frequency Meter Count Time This is the length of time that the Frequency Meter will count VCO clocks. 00b - 10 us 01b - 25 us 10b - 50 us 11b - 100 us |
| 29 FREQ_COUNT_FINISHED | Frequency Meter has finished the Count Time This bit is set when the FREQ_COUNT_TIME value is reached, it is cleared when FREQ_COUNT_GO is cleared. |
| 28 FREQ_COUNT_GO | Start the Frequency Meter The Frequency Meter starts when this bit is set and runs until the FREQ_COUNT_TIME value is reached. The bit should not be cleared until after the counting is finished. After the Counting Time finishes, the FREQ_COUNT_FINISHED bit will read as a one. Then the measured frequency can be calculated by reading the frequency counts in the DFT_FREQ_COUNTER register (in the XCVR_ANALOG register space) and dividing by the FREQ_COUNT_TIME. Note that the counting is done at the VCO frequency which is 2X the Carrier Frequency |
| 27 FTW_TX | TX Frequency Target Window time select In Radio Transmit Mode, this bit selects the length of time to count for the estimation of PLL lock frequency, which is compared with the Frequency Target Window, set by FTF_TX. 0b - 4 us |

Table continues on the next page...

| Field | Function |
|---------------------------|---|
| | 1b - 8 us |
| 26 — | Reserved |
| 25-20 FTF_TX_THRS H | TX Frequency Target Fail Threshold In Radio Transmit Mode, the FT_FAIL and FTFF bits will be set after the Frequency Target Count completes if the absolute value of the count difference from the frequency target count is greater than this register value. |
| 19 FTW_RX | RX Frequency Target Window time select In Radio Receive Mode, this bit selects the length of time to count for the estimation of PLL lock frequency, which is compared with the Frequency Target Window, set by FTF_RX. 0b - 4 us 1b - 8 us |
| 18 — | Reserved |
| 17-12 FTF_RX_THRS H | RX Frequency Target Fail Threshold In Radio Receive Mode, the FT_FAIL and FTFF bits will be set after the Frequency Target Count completes if the absolute value of the count difference from the frequency target count is greater than this register value. |
| 11-8 CTUNE_LDF_L EV | CTUNE Lock Detect Fail Level The CT_FAIL and CTFF bits will be set after Coarse Tune Calibration completes if the absolute value of the Coarse Tune best count difference (CTUNE_BEST_DIFF in the PLL_CTUNE_RESULTS register) is greater than this register value. |
| 7 TAFF | TSM Abort Failure Flag This bit is set if the TSM Sequence Aborts, and this bit is cleared by writing a 1 to it. |
| 6 — | Reserved |
| 5 FTFF | Frequency Target Failure Flag This bit is set when FT_FAIL is first set, and this bit is cleared by writing a 1 to it. |
| 4 FT_FAIL | Real time status of Frequency Target Failure If the Frequency Target Count has completed and the count was out of the range selected by FTW_TX or FTW_RX, then this bit will be set. |
| 3 CSFF | Cycle Slip Failure Flag, held until cleared This bit is set when CS_FAIL is first set, and this bit is cleared by writing a 1 to it. |
| 2 CS_FAIL | Real time status of Cycle Slip circuit This bit shows the real-time status of the Cycle Slip State Machine Interrupt which is configured using the control bits in the PLL_HPM_CAL1 and PLL_HPM_CAL2 registers. |
| 1 CTFF | CTUNE Failure Flag, held until cleared This bit is set when CT_FAIL is first set, and this bit is cleared by writing a 1 to it. |
| 0 CT_FAIL | Real time status of Coarse Tune Fail signal If the Coarse Tune Calibration has completed and the best count difference is out of the range selected by CTUNE_LDF_LEV, then this bit will be set. |

45.2.2.2.6 PLL High Port Modulator Control (HPM_CTRL)

45.2.2.2.6.1 Address

| Register | Offset |
|----------|-----------|
| HPM_CTRL | 4005C234h |

45.2.2.2.6.2 Diagram

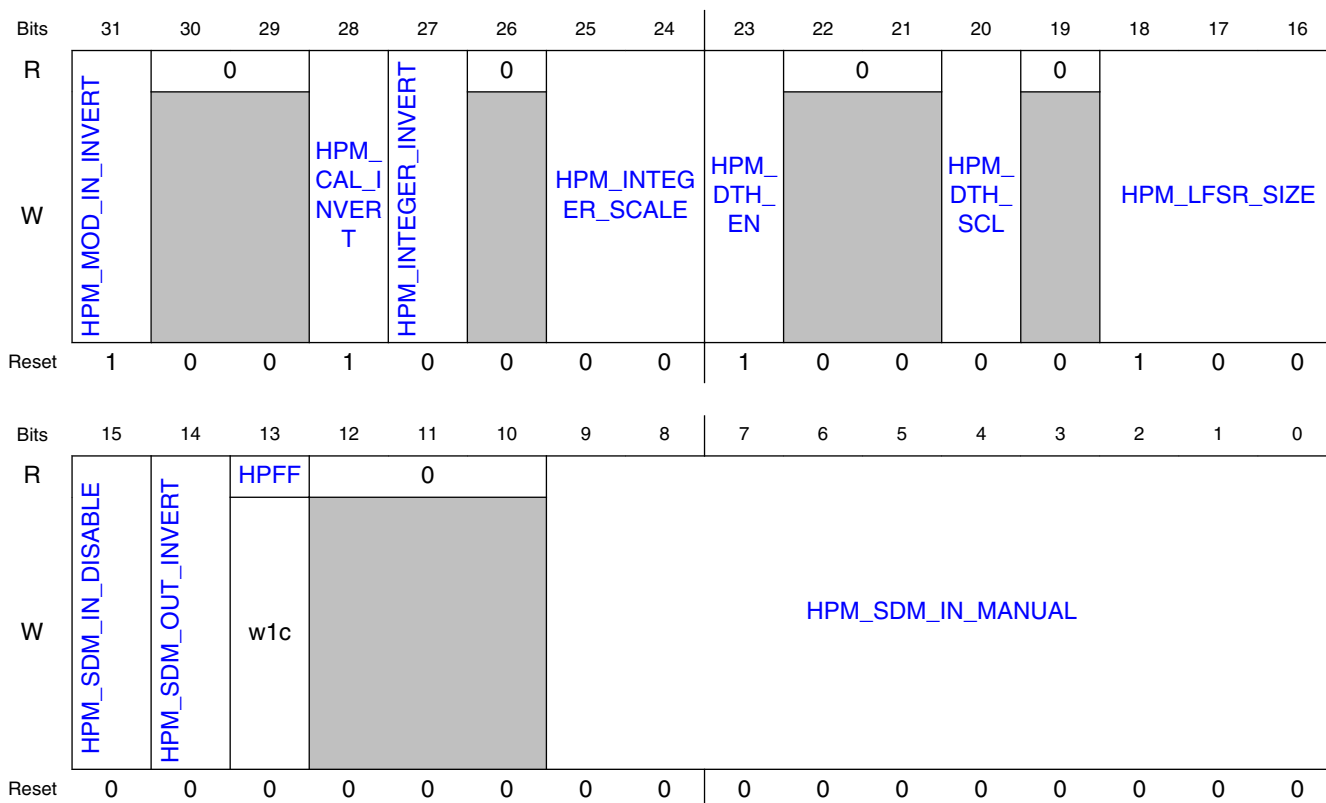

45.2.2.2.6.3 Fields

| Field | Function |
|-------------------|---|
| 31 | Invert High Port Modulation |
| HPM_MOD_IN_INVERT | If this bit is set then the High Port Modulation Word is inverted before it is multiplied and split into Integer and Fractional values. |
| 30-29 | Reserved |
| — | |
| 28 | Invert High Port Modulator Calibration |

Table continues on the next page...

| Field | Function |
|-----------------------|--|
| HPM_CAL_INVERT | If this bit is set then the order of the High Port Calibration is reversed in order to get a positive count difference between the Maximum and Minimum settings of the HPM DAC. |
| 27 | Invert High Port Modulation Integer |
| HPM_INTEGER_INVERT | If this bit is set then the High Port Modulation Integer value, after the multiply and split into Integer and Fractional values, will be inverted before it is applied to the VCO High Port DAC Array. |
| 26 | Reserved |
| — | |
| 25-24 | High Port Modulation Integer Scale |
| HPM_INTEGER_SCALE | This register controls the scaling of the High Port Modulation Integer Value applied to the VCO High Port DAC Array. 00b - No Scaling 01b - Multiply by 2 10b - Divide by 2 11b - Reserved |
| 23 | Dither Enable for HPM LFSR |
| HPM_DTH_EN | If this bit is set, the High Port Fraction will be Dithered by the High Port LFSR before it is applied to the High Port SDM. |
| 22-21 | Reserved |
| — | |
| 20 | HPM Dither Scale |
| HPM_DTH_SCL | If this bit is set, the LFSR dithering of the High Port Fraction will be multiplied by 2. |
| 19 | Reserved |
| — | |
| 18-16 | HPM LFSR Length |
| HPM_LFSR_SIZE | This register selects the length of the HPM LFSR and the associated LFSR Tap Mask 000b - LFSR 9, tap mask 100010000 001b - LFSR 10, tap mask 1001000000 010b - LFSR 11, tap mask 11101000000 011b - LFSR 13, tap mask 1101100000000 100b - LFSR 15, tap mask 111010000000000 101b - LFSR 17, tap mask 1111000000000000 110b - Reserved 111b - Reserved |
| 15 | Disable HPM SDM Input |
| HPM_SDM_IN_DISABLE | If this bit is set, the Fractional portion of the High Port Modulation to the High Port SDM is disabled, and the High Port SDM input comes from the HPM_SDM_IN_MANUAL register. |
| 14 | Invert HPM SDM Output |
| HPM_SDM_OUTPUT_INVERT | If this bit is set the High Port SDM result will be Inverted before it is applied to the VCO High Port DAC Array. |
| 13 | HPM SDM Invalid Flag |
| HPFF | This bit is set if the High Port Sigma Delta Modulator output is invalid due to an error in the fraction applied, and this bit is cleared by writing a 1 to it. |
| 12-10 | Reserved |
| — | |
| 9-0 | Manual High Port SDM Fractional value |

Radio Register Overview

| Field | Function |
|-------------------|---|
| HPM_SDM_IN_MANUAL | If HPM_SDM_IN_DISABLE is set, this register is the value that is applied as the Fractional value to the input of the High Port SDM. |

45.2.2.2.7 PLL High Port Sigma Delta Results (HPM_SDM_RES)

45.2.2.2.7.1 Address

| Register | Offset |
|-------------|-----------|
| HPM_SDM_RES | 4005C244h |

45.2.2.2.7.2 Diagram

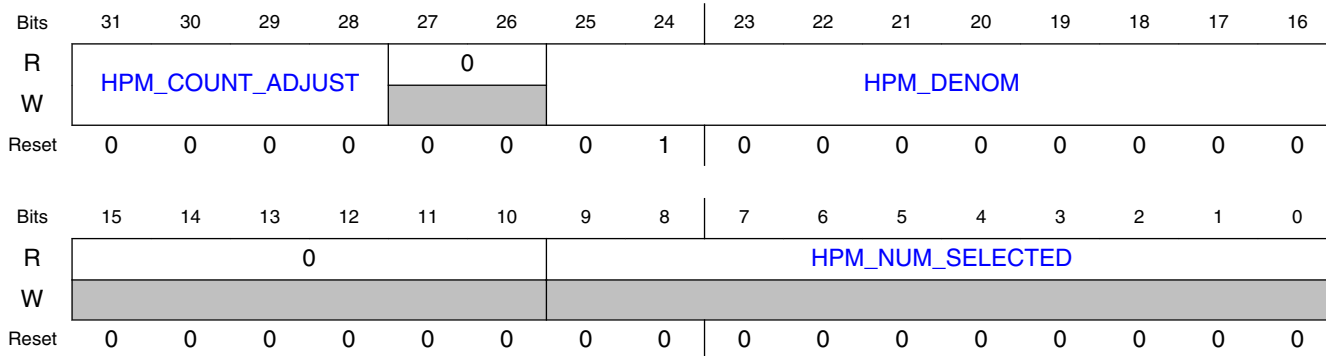

45.2.2.2.7.3 Fields

| Field | Function |
|------------------|---|
| 31-28 | HPM_COUNT_ADJUST |
| HPM_COUNT_ADJUST | This register represents a signed three bit value that is used to adjust the High Port Calibration Frequency Count Difference. The range of adjustment is -8 to +7, applied to the difference between Count 1 and Count 2. |
| 27-26 | Reserved |
| — | |
| 25-16 | High Port Modulator SDM Denominator |
| HPM_DENOM | This is the denominator that is currently being applied to the High Port Sigma Delta Modulator, for valid Sigma Delta operation the resulting fraction NUM/DENOM must be in the range -0.6 to +0.6 |
| 15-10 | Reserved |
| — | |
| 9-0 | High Port Modulator SDM Numerator |

| Field | Function |
|------------------|--|
| HPM_NUM_SELECTED | This is the numerator that is currently being applied to the High Port Sigma Delta Modulator, for valid Sigma Delta operation the resulting fraction NUM/DENOM must be in the range -0.6 to +0.6 |

45.2.2.2.8 PLL Low Port Modulator Control (LPM_CTRL)

45.2.2.2.8.1 Address

| Register | Offset |
|----------|-----------|
| LPM_CTRL | 4005C248h |

45.2.2.2.8.2 Diagram

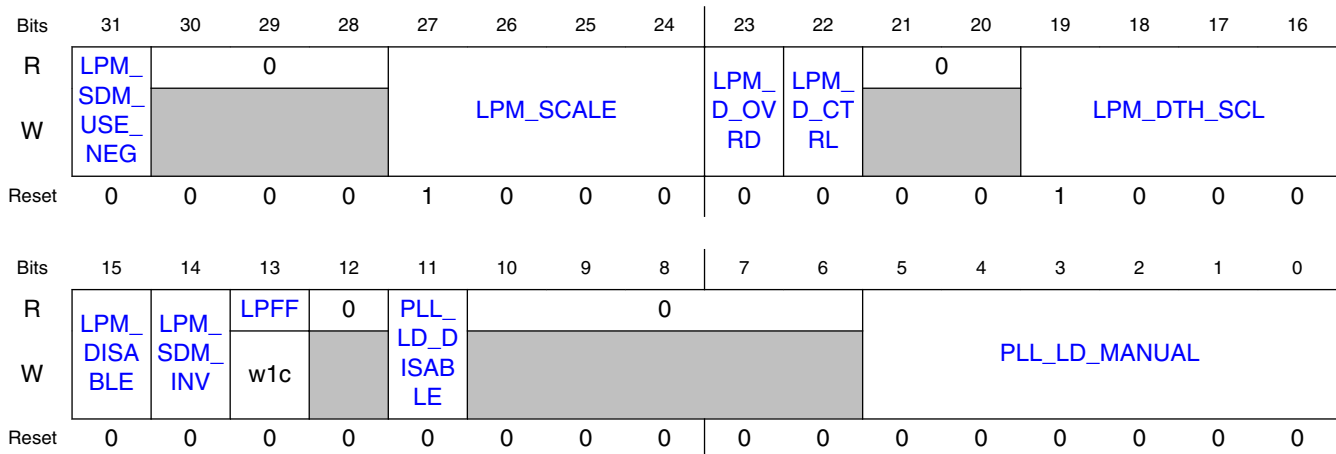

45.2.2.2.8.3 Fields

| Field | Function |
|--------------------|---|
| 31 | Use the Negedge of the Sigma Delta clock |
| LPM_SDM_USE_NEG | If this bit is set then the negative edge of the Sigma Delta clock is used to launch the Low Port Modulation word to the VCO Loop Divider. |
| 30-28 — | Reserved |
| 27-24 LPM_SCALE | LPM Scale Factor This register controls the scaling of the Baseband Frequency Word and is used to match the Modulation Frequency Deviation required to the Low Port Sigma Delta Modulator LSB size in Hz. 0000b - No Scaling 0001b - Multiply by 2 |

Table continues on the next page...

Radio Register Overview

| Field | Function |
|----------------------|---|
| | 0010b - Multiply by 4 0011b - Multiply by 8 0100b - Multiply by 16 0101b - Multiply by 32 0110b - Multiply by 64 0111b - Multiply by 128 1000b - Multiply by 256 1001b - Multiply by 512 1010b - Multiply by 1024 1011b - Multiply by 2048 1100b - Reserved 1101b - Reserved 1110b - Reserved 1111b - Reserved |
| 23 LPM_D_OVRD | LPM Dither Override Mode Select When this bit is set, the Scaled Baseband Frequency Word applied to the Low Port Sigma Delta Modulator will be dithered if LPM_D_CTRL is set, and not dithered if LPM_D_CTRL is cleared. If this bit is cleared, then the LPM Numerator will be dithered in Radio Receive mode, and also in Radio Transmit mode when the LPM Numerator approaches an Integer value in order to preserve the validity of the Sigma Delta Modulator output. |
| 22 LPM_D_CTRL | LPM Dither Control in Override Mode If LPM_D_OVRD is set, this bit turns LPM Dithering on and off. |
| 21-20 — | Reserved |
| 19-16 LPM_DTH_SCL | LPM Dither Scale This register controls the scale of the Dithering added to the Scaled Baseband Frequency Word before it is applied to the Low Port Sigma Delta Modulator as the LPM Numerator. The unit for the ranges shown below is the LP SDM LSB in Hz. 0000b - Reserved 0001b - Reserved 0010b - Reserved 0011b - Reserved 0100b - Reserved 0101b - -128 to 96 0110b - -256 to 192 0111b - -512 to 384 1000b - -1024 to 768 1001b - -2048 to 1536 1010b - -4096 to 3072 1011b - -8192 to 6144 1100b - Reserved 1101b - Reserved 1110b - Reserved 1111b - Reserved |
| 15 LPM_DISABLE | Disable LPM SDM This bit controls the Modulation of the Low Port Sigma Delta. If this bit is set, the Low Port Sigma Delta Modulator will be active and control the PLL to maintain a steady frequency based on the current Integer, Numerator, and Denominator values that are being applied. No Modulation or Dithering will be added to the steady frequency result. |

Table continues on the next page...

| Field | Function |
|----------------------|---|
| 14 LPM_SDM_INV | Invert LPM SDM If this bit is set the Scaled Baseband Frequency Word, including any Dithering, will be Inverted before it is applied to the Low Port Sigma Delta Modulator. |
| 13 LPFF | LPM SDM Invalid Flag This bit is set if the Low Port Sigma Delta Modulator output is invalid due to an error in the fraction applied, and this bit is cleared by writing a 1 to it. |
| 12 — | Reserved |
| 11 PLL_LD_DISABLE | Disable PLL Loop Divider If this bit is set, the Low Port Sigma Delta Modulator output is disabled, and the PLL Loop Divider value applied to the PLL comes from the PLL_LD_MANUAL register. |
| 10-6 — | Reserved |
| 5-0 PLL_LD_MANUAL | Manual PLL Loop Divider value If PLL_LD_DISABLE is set, this register is the value that is applied to the PLL Loop Divider. |

45.2.2.2.9 PLL Low Port Sigma Delta Control 1 (LPM_SDM_CTRL1)

45.2.2.2.9.1 Address

| Register | Offset |
|---------------|-----------|
| LPM_SDM_CTRL1 | 4005C24Ch |

45.2.2.2.9.2 Diagram

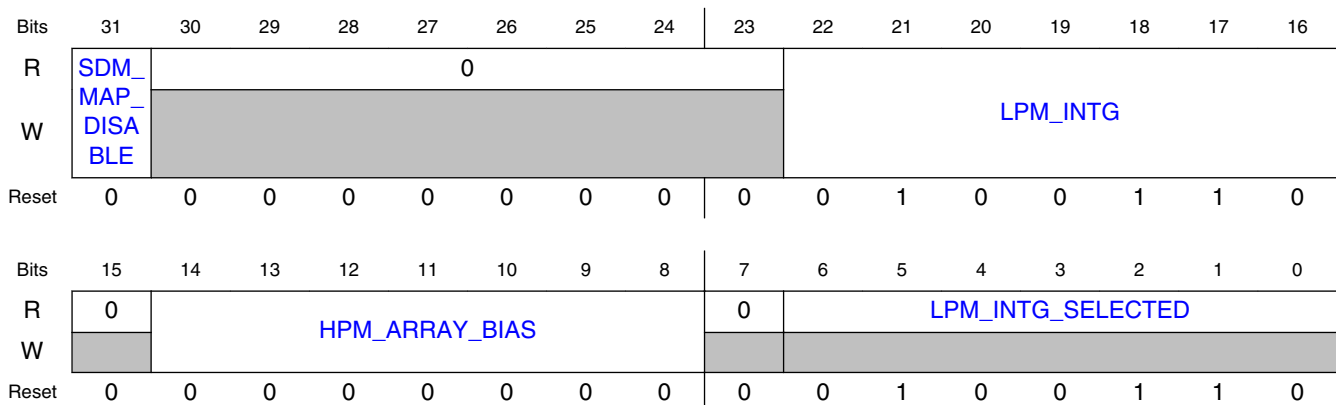

45.2.2.2.9.3 Fields

| Field | Function |
|--------------------------|--|
| 31 SDM_MAP_DISABLE | Disable SDM Mapping If this bit is set, the Low Port Sigma Delta Modulator internal frequency mapping based on Protocol specific channel numbers is disabled, and the Radio Channel Frequency is selected by setting the LPM_INTG, LPM_NUM, and LPM_DENOM registers to get a frequency that equals : $((\text{Reference Clock Frequency} \times 2) \times (\text{LPM_INTG} + (\text{LPM_NUM} / \text{LPM_DENOM})))$ |
| 30-23 — | Reserved |
| 22-16 LPM_INTG | Manual Low Port Modulation Integer Value If SDM_MAP_DISABLE is set, this register is the value that is applied to the Low Port Sigma Delta Modulator for the Integer, the nominal range is 36 to 39 in decimal. |
| 15 — | Reserved |
| 14-8 HPM_ARRAY_BIAS | Bias value for High Port DAC Array Midpoint The value of this register represents a signed six bit value that can be used to adjust the midpoint of the High Port Modulator DAC. The range of adjustment is -64 to +63, and the adjustment is made to the High Port Modulation Word before the multiply, and before the split into Integer and Fractional values. The range of adjustment in Hz is approximately +/- 62.5 kHz |
| 7 — | Reserved |
| 6-0 LPM_INTG_SELECTED | Low Port Modulation Integer Value Selected This shows the Integer value that is currently being applied to the Low Port Sigma Delta Modulator. |

45.2.2.2.10 PLL Low Port Sigma Delta Control 2 (LPM_SDM_CTRL2)

45.2.2.2.10.1 Address

| Register | Offset |
|---------------|-----------|
| LPM_SDM_CTRL2 | 4005C250h |

45.2.2.2.10.2 Diagram

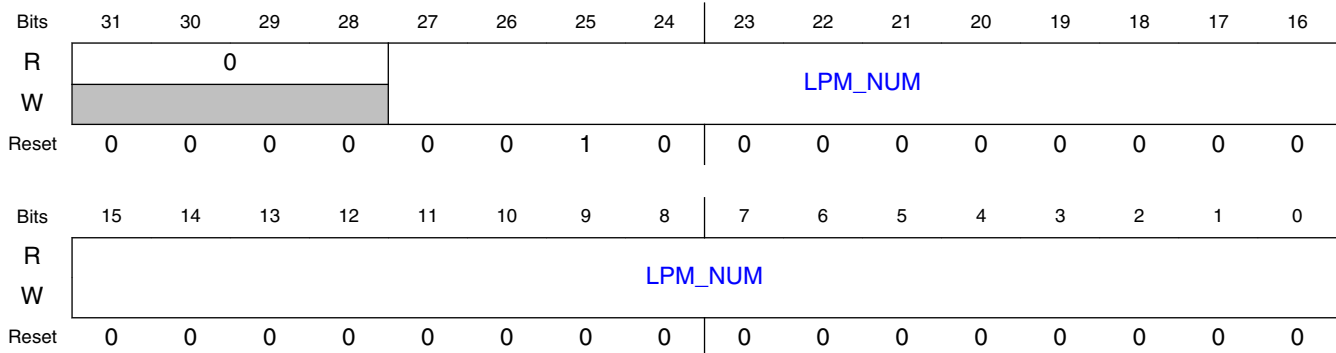

45.2.2.2.10.3 Fields

| Field | Function |
|-----------------|--|
| 31-28 — | Reserved |
| 27-0 LPM_NUM | Low Port Modulation Numerator If SDM_MAP_DISABLE is set, this register is the signed 27 bit value that is applied to the Low Port Sigma Delta Modulator for the Numerator. For valid Sigma Delta operation the resulting fraction NUM/DENOM must be in the range -0.6 to +0.6 |

45.2.2.2.11 PLL Low Port Sigma Delta Control 3 (LPM_SDM_CTRL3)

45.2.2.2.11.1 Address

| Register | Offset |
|---------------|-----------|
| LPM_SDM_CTRL3 | 4005C254h |

45.2.2.2.11.2 Diagram

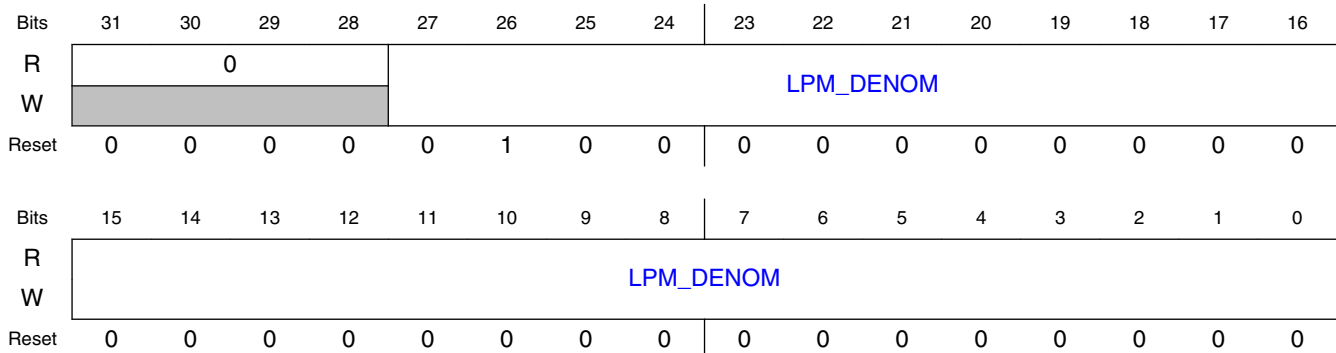

45.2.2.2.11.3 Fields

| Field | Function |
|-------------------|--|
| 31-28 — | Reserved |
| 27-0 LPM_DENOM | Low Port Modulation Denominator If SDM_MAP_DISABLE is set, this register is the signed 27 bit value that is applied to the Low Port Sigma Delta Modulator for the Denominator. For valid Sigma Delta operation the resulting fraction NUM/DENOM must be in the range -0.6 to +0.6 |

45.2.2.2.12 PLL Low Port Sigma Delta Result 1 (LPM_SDM_RES1)

45.2.2.2.12.1 Address

| Register | Offset |
|--------------|-----------|
| LPM_SDM_RES1 | 4005C258h |

45.2.2.2.12.2 Diagram

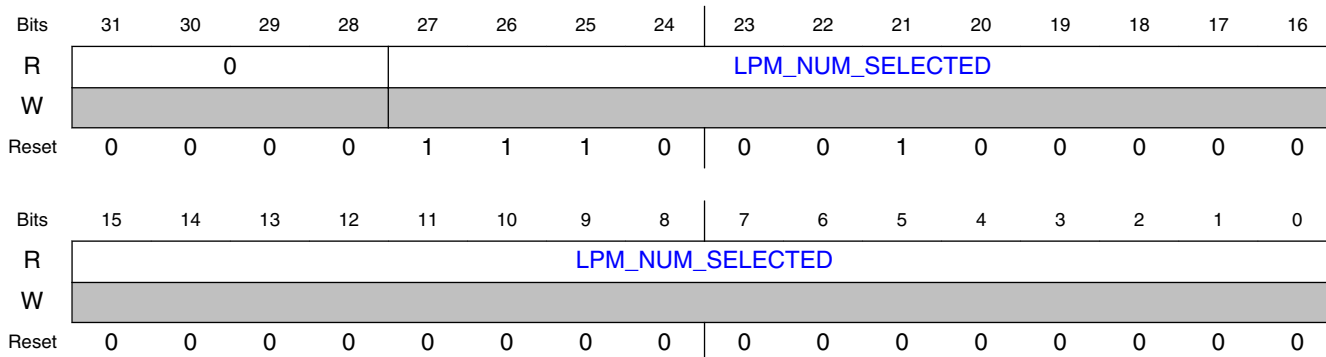

45.2.2.2.12.3 Fields

| Field | Function |
|--------------------------|--|
| 31-28 — | Reserved |
| 27-0 LPM_NUM_SELECTED | Low Port Modulation Numerator Applied This is the value that is currently being applied to the Low Port Sigma Delta Modulator, for valid Sigma Delta operation the resulting fraction NUM/DENOM must be in the range -0.6 to +0.6 |

45.2.2.2.13 PLL Low Port Sigma Delta Result 2 (LPM_SDM_RES2)

45.2.2.2.13.1 Address

| Register | Offset |
|--------------|-----------|
| LPM_SDM_RES2 | 4005C25Ch |

45.2.2.2.13.2 Diagram

| | | | | | | | | | | | | | | | | |
|-------|--------------------|----|----|----|--------------------|----|----|----|----|----|----|----|----|----|----|----|
| Bits | 31 | 30 | 29 | 28 | 27 | 26 | 25 | 24 | 23 | 22 | 21 | 20 | 19 | 18 | 17 | 16 |
| R | 0 | | | | LPM_DENOM_SELECTED | | | | | | | | | | | |
| W | [Shaded] | | | | | | | | | | | | | | | |
| Reset | 0 | 0 | 0 | 0 | 0 | 1 | 0 | 0 | 0 | 0 | 0 | 0 | 0 | 0 | 0 | 0 |
| Bits | 15 | 14 | 13 | 12 | 11 | 10 | 9 | 8 | 7 | 6 | 5 | 4 | 3 | 2 | 1 | 0 |
| R | LPM_DENOM_SELECTED | | | | | | | | | | | | | | | |
| W | [Shaded] | | | | | | | | | | | | | | | |
| Reset | 0 | 0 | 0 | 0 | 0 | 0 | 0 | 0 | 0 | 0 | 0 | 0 | 0 | 0 | 0 | 0 |

45.2.2.2.13.3 Fields

| Field | Function |
|----------------------------|---|
| 31-28 — | Reserved |
| 27-0 LPM_DENOM_SELECTED | Low Port Modulation Denominator Selected This is the value that is currently being applied to the Low Port Sigma Delta Modulator, for valid Sigma Delta operation the resulting fraction NUM/DENOM must be in the range -0.6 to +0.6 |

45.2.2.2.14 PLL Delay Matching (DELAY_MATCH)

45.2.2.2.14.1 Address

| Register | Offset |
|-------------|-----------|
| DELAY_MATCH | 4005C260h |

45.2.2.2.14.2 Diagram

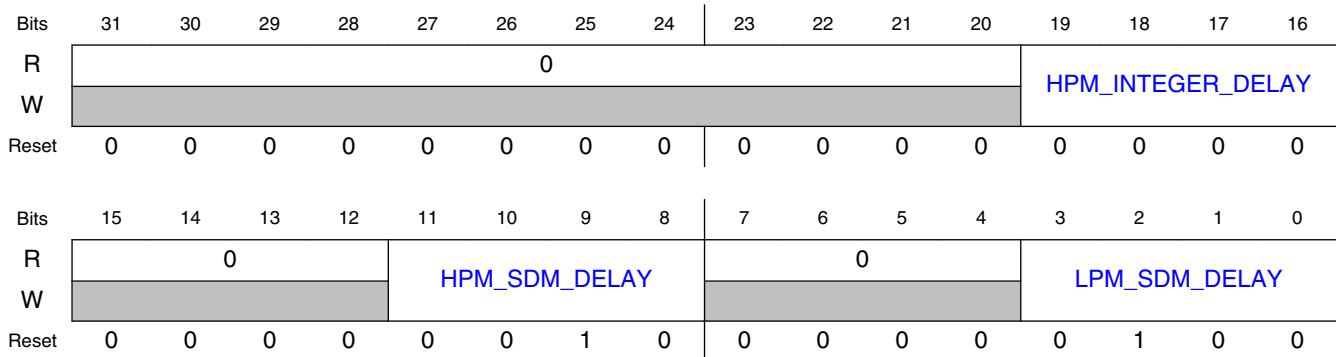

45.2.2.2.14.3 Fields

| Field | Function |
|----------------------------|--|
| 31-20 — | Reserved |
| 19-16 HPM_INTEGER_DELAY | High Port Integer Delay Matching This register selects the number of clock cycles of the PLL Sigma Delta Clock divided by 2 to delay the High Port Integer modulation of the VCO High Port DAC Array. |
| 15-12 — | Reserved |
| 11-8 HPM_SDM_DELAY | High Port SDM Delay Matching This register selects the number of clock cycles of the PLL Sigma Delta Clock divided by 2 to delay the High Port Sigma Delta modulation of the VCO High Port Fraction. Note that the High Port SDM is clocked by the PLL Sigma Delta Clock but the modulation is based on a divide by 2 version of this same clock. |
| 7-4 — | Reserved |
| 3-0 LPM_SDM_DELAY | Low Port SDM Delay Matching This register selects the number of clock cycles of the PLL Sigma Delta Clock to delay the Low Port Sigma Delta modulation of the PLL Loop Divider. |

45.2.2.2.15 PLL Coarse Tune Control (CTUNE_CTRL)

45.2.2.2.15.1 Address

| Register | Offset |
|------------|-----------|
| CTUNE_CTRL | 4005C264h |

45.2.2.2.15.2 Diagram

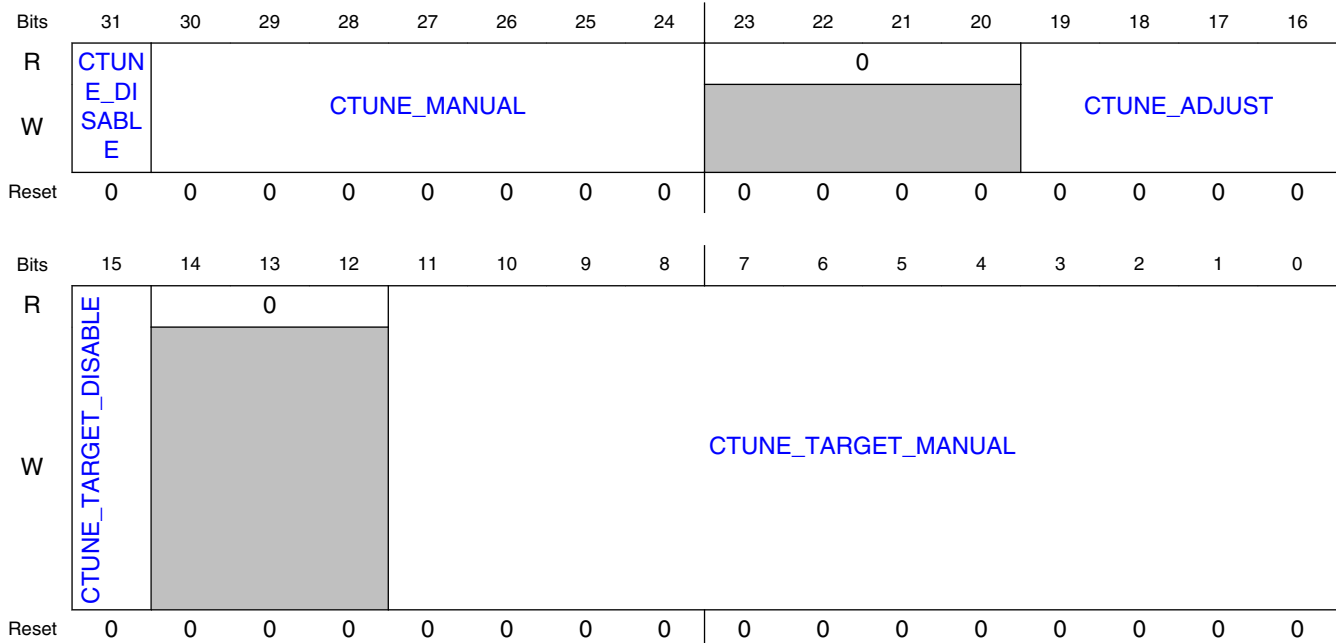

45.2.2.2.15.3 Fields

| Field | Function |
|-----------------------------|--|
| 31 CTUNE_DISABLE | Coarse Tune Disable If this bit is set, the Coarse Tune Setting applied to the VCO comes from the CTUNE_MANUAL register. |
| 30-24 CTUNE_MANUAL | Manual Coarse Tune Setting If CTUNE_DISABLE is set, this register is the value that is applied to the VCO as the Coarse Tune Setting. |
| 23-20 — | Reserved |
| 19-16 CTUNE_ADJUST | Coarse Tune Count Adjustment This register is a signed three bit value that adjusts the PLL Frequency Meter count used in the Coarse Tune Calibration. The range of adjustment is -8 to +7, and the adjustment is only made to the PLL Frequency count used by the Coarse Tune Calibration sequence. |
| 15 CTUNE_TARGET_DISABLE | Disable Coarse Tune Target If this bit is set, the Frequency Target presented to the Coarse Tune Calibrator comes from the CTUNE_TARGET_MANUAL register. |
| 14-12 — | Reserved |
| 11-0 CTUNE_TARGET_MANUAL | Manual Coarse Tune Target If CTUNE_TD is set, this register is the value that is presented to the Coarse Tune Calibrator as the Frequency Target in MHz. The nominal range of this target is from 2360 to 2487 in decimal. |

45.2.2.2.16 PLL Coarse Tune Results (CTUNE_RES)

45.2.2.2.16.1 Address

| Register | Offset |
|-----------|-----------|
| CTUNE_RES | 4005C278h |

45.2.2.2.16.2 Diagram

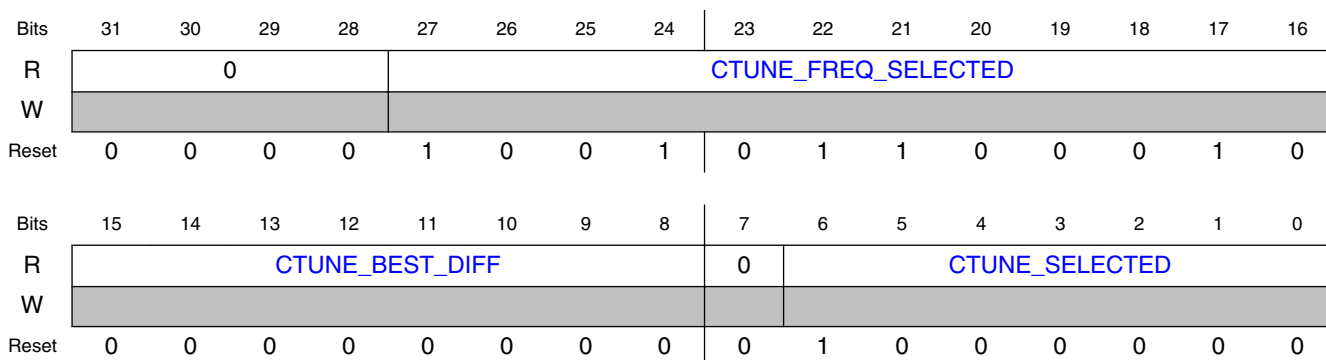

45.2.2.2.16.3 Fields

| Field | Function |
|------------------------------|---|
| 31-28 — | Reserved |
| 27-16 CTUNE_FREQ_SELECTED | Coarse Tune Frequency Selected This is the Frequency Target in MHz that is currently being presented to the Coarse Tune Calibrator. |
| 15-8 CTUNE_BEST_DIFF | Coarse Tune Absolute Best Difference This is the absolute value of the best difference found during Coarse Tune between the targeted frequency count and the actual frequency count. |
| 7 — | Reserved |
| 6-0 CTUNE_SELECTED | Coarse Tune Setting to VCO This is the current VCO Coarse Tune setting, it is the result of the Coarse Tune Calibration, unless overridden using CTUNE_DISABLE. |

45.2.2.3 XCVR_RX_DIG Register Descriptions

45.2.2.3.1 XCVR_RX_DIG_ADDR Memory Map

Base address: 4005C000h

| Offset | Register | Width (In bits) | Access | Reset value |
|-----------|--|--------------------|--------|-------------|
| 4005C000h | RX Digital Control (RX_DIG_CTRL) | 32 | RW | 00000000h |
| 4005C004h | AGC Control 0 (AGC_CTRL_0) | 32 | RW | 00000000h |
| 4005C008h | AGC Control 1 (AGC_CTRL_1) | 32 | RW | 00000000h |
| 4005C00Ch | AGC Control 2 (AGC_CTRL_2) | 32 | RW | 00A69000h |
| 4005C010h | AGC Control 3 (AGC_CTRL_3) | 32 | RW | 00000000h |
| 4005C014h | AGC Status (AGC_STAT) | 32 | RO | 00000000h |
| 4005C018h | RSSI Control 0 (RSSI_CTRL_0) | 32 | RW | 00300000h |
| 4005C01Ch | RSSI Control 1 (RSSI_CTRL_1) | 32 | RO | 00000000h |
| 4005C024h | DCOC Control 0 (DCOC_CTRL_0) | 32 | RW | 00000000h |
| 4005C028h | DCOC Control 1 (DCOC_CTRL_1) | 32 | RW | 00000000h |
| 4005C02Ch | DCOC DAC Initialization (DCOC_DAC_INIT) | 32 | RW | 80802020h |
| 4005C030h | DCOC Digital Correction Manual Override (DCOC_DIG_MAN) | 32 | RW | 00000000h |
| 4005C034h | DCOC Calibration Gain (DCOC_CAL_GAIN) | 32 | RW | 00000000h |
| 4005C038h | DCOC Status (DCOC_STAT) | 32 | RO | 80802020h |
| 4005C03Ch | DCOC DC Estimate (DCOC_DC_EST) | 32 | RO | 00000000h |
| 4005C040h | DCOC Calibration Reciprocals (DCOC_CAL_RCP) | 32 | RW | 00000000h |
| 4005C048h | IQMC Control (IQMC_CTRL) | 32 | RW | 04008000h |
| 4005C04Ch | IQMC Calibration (IQMC_CAL) | 32 | RW | 00000400h |
| 4005C050h | LNA_GAIN Step Values 3..0 (LNA_GAIN_VAL_3_0) | 32 | RW | 3809321Dh |
| 4005C054h | LNA_GAIN Step Values 7..4 (LNA_GAIN_VAL_7_4) | 32 | RW | 8B745D4Fh |
| 4005C058h | LNA_GAIN Step Values 8 (LNA_GAIN_VAL_8) | 32 | RW | 0000B6A1h |
| 4005C05Ch | BBA Resistor Tune Values 7..0 (BBA_RES_TUNE_VAL_7_0) | 32 | RW | 00000000h |
| 4005C060h | BBA Resistor Tune Values 10..8 (BBA_RES_TUNE_VAL_10_8) | 32 | RW | 00000000h |
| 4005C064h | LNA Linear Gain Values 2..0 (LNA_GAIN_LIN_VAL_2_0) | 32 | RW | 00000000h |
| 4005C068h | LNA Linear Gain Values 5..3 (LNA_GAIN_LIN_VAL_5_3) | 32 | RW | 00000000h |
| 4005C06Ch | LNA Linear Gain Values 8..6 (LNA_GAIN_LIN_VAL_8_6) | 32 | RW | 00000000h |
| 4005C070h | LNA Linear Gain Values 9 (LNA_GAIN_LIN_VAL_9) | 32 | RW | 00000000h |
| 4005C074h | BBA Resistor Tune Values 3..0 (BBA_RES_TUNE_LIN_VAL_3_0) | 32 | RW | 00000000h |
| 4005C078h | BBA Resistor Tune Values 7..4 (BBA_RES_TUNE_LIN_VAL_7_4) | 32 | RW | 00000000h |
| 4005C07Ch | BBA Resistor Tune Values 10..8 (BBA_RES_TUNE_LIN_VAL_10_8) | 32 | RW | 00000000h |
| 4005C080h | AGC Gain Tables Step 03..00 (AGC_GAIN_TBL_03_00) | 32 | RW | 00000000h |
| 4005C084h | AGC Gain Tables Step 07..04 (AGC_GAIN_TBL_07_04) | 32 | RW | 00000000h |
| 4005C088h | AGC Gain Tables Step 11..08 (AGC_GAIN_TBL_11_08) | 32 | RW | 00000000h |

Table continues on the next page...

Radio Register Overview

| Offset | Register | Width (In bits) | Access | Reset value |
|--------------------------|--|--------------------|--------|-------------|
| 4005C08Ch | AGC Gain Tables Step 15..12 (AGC_GAIN_TBL_15_12) | 32 | RW | 00000000h |
| 4005C090h | AGC Gain Tables Step 19..16 (AGC_GAIN_TBL_19_16) | 32 | RW | 00000000h |
| 4005C094h | AGC Gain Tables Step 23..20 (AGC_GAIN_TBL_23_20) | 32 | RW | 00000000h |
| 4005C098h | AGC Gain Tables Step 26..24 (AGC_GAIN_TBL_26_24) | 32 | RW | 00000000h |
| 4005C0A0h - 4005C108h | DCOC Offset (DCOC_OFFSET_0 - DCOC_OFFSET_26) | 32 | RW | 00000000h |
| 4005C10Ch | DCOC BBA DAC Step (DCOC_BBA_STEP) | 32 | RW | 00000000h |
| 4005C110h | DCOC TZA DAC Step 0 (DCOC_TZA_STEP_0) | 32 | RW | 00000000h |
| 4005C114h | DCOC TZA DAC Step 1 (DCOC_TZA_STEP_1) | 32 | RW | 00000000h |
| 4005C118h | DCOC TZA DAC Step 2 (DCOC_TZA_STEP_2) | 32 | RW | 00000000h |
| 4005C11Ch | DCOC TZA DAC Step 3 (DCOC_TZA_STEP_3) | 32 | RW | 00000000h |
| 4005C120h | DCOC TZA DAC Step 4 (DCOC_TZA_STEP_4) | 32 | RW | 00000000h |
| 4005C124h | DCOC TZA DAC Step 5 (DCOC_TZA_STEP_5) | 32 | RW | 00000000h |
| 4005C128h | DCOC TZA DAC Step 6 (DCOC_TZA_STEP_6) | 32 | RW | 00000000h |
| 4005C12Ch | DCOC TZA DAC Step 7 (DCOC_TZA_STEP_7) | 32 | RW | 00000000h |
| 4005C130h | DCOC TZA DAC Step 8 (DCOC_TZA_STEP_8) | 32 | RW | 00000000h |
| 4005C134h | DCOC TZA DAC Step 9 (DCOC_TZA_STEP_9) | 32 | RW | 00000000h |
| 4005C138h | DCOC TZA DAC Step 10 (DCOC_TZA_STEP_10) | 32 | RW | 00000000h |
| 4005C168h | DCOC Calibration Alpha (DCOC_CAL_ALPHA) | 32 | RO | 00000000h |
| 4005C16Ch | DCOC Calibration Beta Q (DCOC_CAL_BETA_Q) | 32 | RO | 00000000h |
| 4005C170h | DCOC Calibration Beta I (DCOC_CAL_BETA_I) | 32 | RO | 00000000h |
| 4005C174h | DCOC Calibration Gamma (DCOC_CAL_GAMMA) | 32 | RO | 00000000h |
| 4005C178h | DCOC Calibration IIR (DCOC_CAL_IIR) | 32 | RW | 00000000h |
| 4005C180h - 4005C188h | DCOC Calibration Result (DCOC_CAL1 - DCOC_CAL3) | 32 | RO | 00000000h |
| 4005C190h | RX_DIG CCA ED LQI Control Register 0 (CCA_ED_LQI_CTRL_0) | 32 | RW | 00000000h |
| 4005C194h | RX_DIG CCA ED LQI Control Register 1 (CCA_ED_LQI_CTRL_1) | 32 | RW | 00000000h |
| 4005C198h | RX_DIG CCA ED LQI Status Register 0 (CCA_ED_LQI_STAT_0) | 32 | RO | 00000000h |
| 4005C1A0h | Receive Channel Filter Coefficient 0 (RX_CHF_COEF_0) | 32 | RW | 00000000h |
| 4005C1A4h | Receive Channel Filter Coefficient 1 (RX_CHF_COEF_1) | 32 | RW | 00000000h |
| 4005C1A8h | Receive Channel Filter Coefficient 2 (RX_CHF_COEF_2) | 32 | RW | 00000000h |
| 4005C1ACh | Receive Channel Filter Coefficient 3 (RX_CHF_COEF_3) | 32 | RW | 00000000h |
| 4005C1B0h | Receive Channel Filter Coefficient 4 (RX_CHF_COEF_4) | 32 | RW | 00000000h |
| 4005C1B4h | Receive Channel Filter Coefficient 5 (RX_CHF_COEF_5) | 32 | RW | 00000000h |
| 4005C1B8h | Receive Channel Filter Coefficient 6 (RX_CHF_COEF_6) | 32 | RW | 00000000h |
| 4005C1BCh | Receive Channel Filter Coefficient 7 (RX_CHF_COEF_7) | 32 | RW | 00000000h |
| 4005C1C0h | Receive Channel Filter Coefficient 8 (RX_CHF_COEF_8) | 32 | RW | 00000000h |
| 4005C1C4h | Receive Channel Filter Coefficient 9 (RX_CHF_COEF_9) | 32 | RW | 00000000h |
| 4005C1C8h | Receive Channel Filter Coefficient 10 (RX_CHF_COEF_10) | 32 | RW | 00000000h |
| 4005C1CCh | Receive Channel Filter Coefficient 11 (RX_CHF_COEF_11) | 32 | RW | 00000000h |

Table continues on the next page...

| Offset | Register | Width (In bits) | Access | Reset value |
|-----------|--|--------------------|--------|-------------|
| 4005C1D0h | AGC Manual AGC Index (AGC_MAN_AGC_IDX) | 32 | RW | 00000000h |
| 4005C1D4h | DC Residual Control (DC_RESID_CTRL) | 32 | RW | 00000000h |
| 4005C1D8h | DC Residual Estimate (DC_RESID_EST) | 32 | RO | 00000000h |
| 4005C1DCh | RX RC Calibration Control0 (RX_RCCAL_CTRL0) | 32 | RW | 00000000h |
| 4005C1E0h | RX RC Calibration Control1 (RX_RCCAL_CTRL1) | 32 | RW | 00000000h |
| 4005C1E4h | RX RC Calibration Status (RX_RCCAL_STAT) | 32 | RO | 02104210h |
| 4005C1E8h | Aux PLL Frequency Calibration Control (AUXPLL_FCAL_CTRL) | 32 | RW | 00400000h |
| 4005C1ECh | Aux PLL Frequency Calibration Count 6 (AUXPLL_FCAL_CNT6) | 32 | RO | 00000000h |
| 4005C1F0h | Aux PLL Frequency Calibration Count 5 and 4 (AUXPLL_FCAL_CNT5_4) | 32 | RO | 00000000h |
| 4005C1F4h | Aux PLL Frequency Calibration Count 3 and 2 (AUXPLL_FCAL_CNT3_2) | 32 | RO | 00000000h |
| 4005C1F8h | Aux PLL Frequency Calibration Count 1 and 0 (AUXPLL_FCAL_CNT1_0) | 32 | RO | 00000000h |

45.2.2.3.2 RX Digital Control (RX_DIG_CTRL)

45.2.2.3.2.1 Offset

| Register | Offset |
|-------------|-----------|
| RX_DIG_CTRL | 4005C000h |

45.2.2.3.2 Diagram

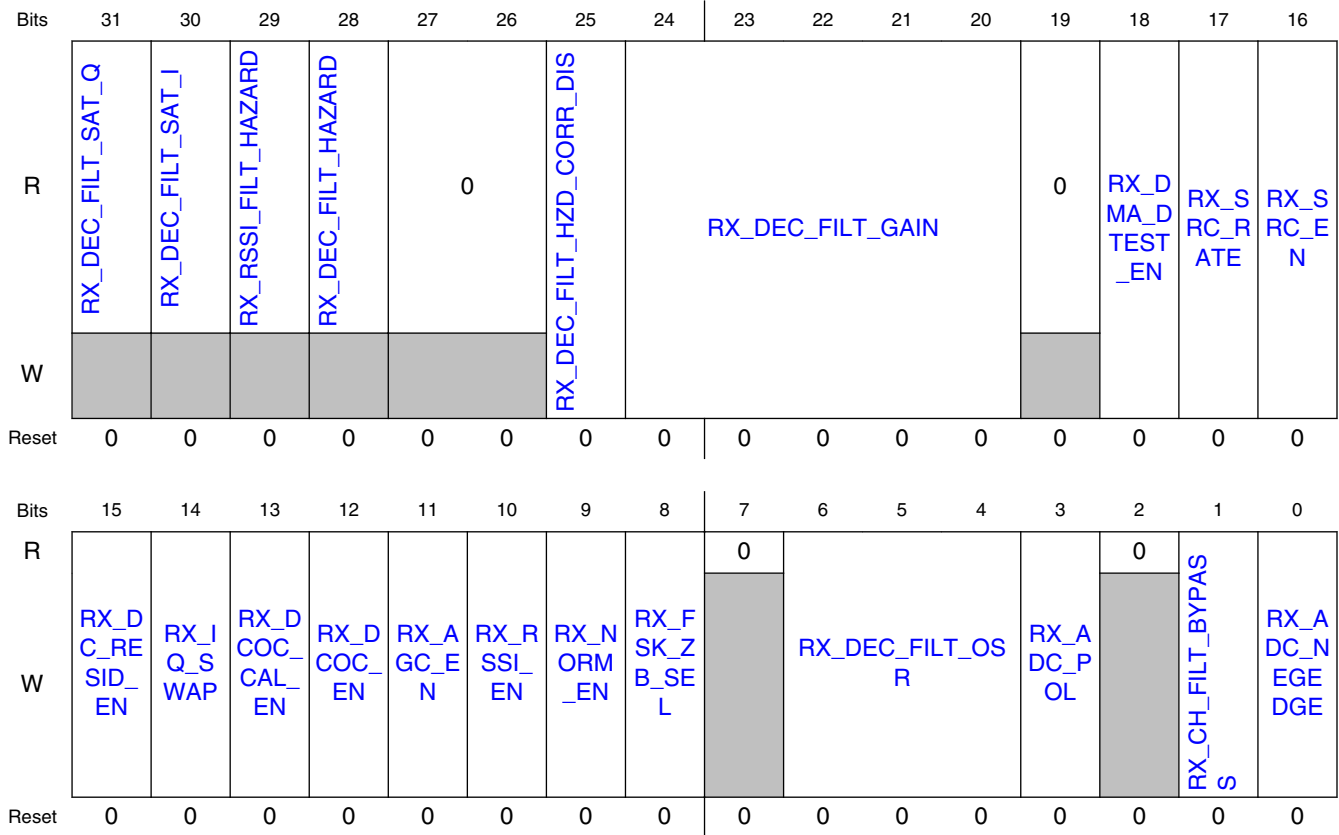

45.2.2.3.3 Fields

| Field | Function |
|-----------------------------|--|
| 31 RX_DEC_FILTER_SAT_Q | Decimator output, saturation detected for Q channel This bit will be set if a saturation condition is detected in the decimator filter Q channel. This bit is cleared by tsm_rx_dcoc_init and rx_init. 0b - A saturation condition has not occurred. 1b - A saturation condition has occurred. |
| 30 RX_DEC_FILTER_SAT_I | Decimator output, saturation detected for I channel This bit will be set if a saturation condition is detected in the decimator filter I channel. This bit is cleared by tsm_rx_dcoc_init and rx_init. 0b - A saturation condition has not occurred. 1b - A saturation condition has occurred. |
| 29 RX_RSSI_FILTER_HAZARD | Decimator output for RSSI, hazard condition detected This bit will be set if a hazard condition is detected in either the I or Q decimator filter related to the wideband RSSI measurement. This does not indicate that a data corruption has occurred, only that the conditions associated with data corruption were detected. This bit is cleared by rx_init. 0b - A hazard condition has not been detected 1b - A hazard condition has been detected |
| 28 | Decimator output, hazard condition detected |

Table continues on the next page...

| Field | Function |
|--------------------------------|---|
| RX_DEC_FILT_HAZARD | This bit will be set if a hazard condition is detected in either the I or Q decimator filter. This does not indicate that a data corruption has occurred, only that the conditions associated with data corruption were detected. This bit is cleared by rx_init. 0b - A hazard condition has not been detected 1b - A hazard condition has been detected |
| 27-26 — | Reserved. |
| 25 RX_DEC_FILT_HZD_CORR_DIS | Decimator filter hazard correction disable This bit should be set for normal operation. |
| 24-20 RX_DEC_FILT_GAIN | Decimation Filter Fractional Gain Defines the fractional gain which is applied at the decimator output. The format is u0.5. The gain applied is $1 + \text{RX_DEC_FILT_GAIN}/32$, so e.g. if RX_DEC_FILT_GAIN is 5'b10110=5'd22, the gain is $1 + 22/32 = 1.6875$. The nominal gain through the ADC is 2048codes/1.7V; the combined gain through the ADC and decimator would therefore be $2048\text{codes}/1.7\text{e}3\text{mV} * 1.6875 = 2.03\text{codes}/\text{mV}$ for the example RX_DEC_FILT_GAIN=5'b10110. |
| 19 — | Reserved. |
| 18 RX_DMA_DTTEST_EN | RX DMA and DTEST enable This bit should be set to ensure that all of the rx_dig outputs related to DMA or DTEST are enabled. In mission mode this bit is intended to be cleared to reduce switching power. |
| 17 RX_SRC_RATE | RX Sample Rate Converter Rate Selections 0b - SRC is configured for a First Order Hold rate of 8/13. 1b - SRC is configured for a Zero Order Hold rate of 12/13. |
| 16 RX_SRC_EN | RX Sample Rate Converter Enable 0b - SRC is disabled. 1b - SRC is enabled. |
| 15 RX_DC_RESID_EN | DC Residual Enable Enables DC Residual block 0b - DC Residual block is disabled. 1b - DC Residual block is enabled. |
| 14 RX_IQ_SWAP | RX IQ Swap Enable swap of I/Q channels (does not affect ADC raw mode). 0b - IQ swap is disabled. 1b - IQ swap is enabled. |
| 13 RX_DCOC_CAL_EN | DCOC Calibration Enable Enable DCOC warm-up calibration in receiver. 0b - DCOC calibration is disabled. 1b - DCOC calibration is enabled. |
| 12 RX_DCOC_EN | DCOC Enable Enables DCO calculation and application of corrections. 0b - DCOC is disabled. 1b - DCOC is enabled. |
| 11 RX_AGC_EN | AGC Global Enable Does NOT affect user gains (user gain programming has priority). 0b - AGC is disabled. |

Table continues on the next page...

Radio Register Overview

| Field | Function |
|------------------------|---|
| | 1b - AGC is enabled. |
| 10 RX_RSSI_EN | RSSI Measurement Enable 0b - RSSI measurement is disabled. 1b - RSSI measurement is enabled. |
| 9 RX_NORM_EN | Normalizer Enable 0b - Normalizer is disabled. 1b - Normalizer is enabled. |
| 8 RX_FSK_ZB_SEL | FSK / 802.15.4 demodulator select Select between FSK and 802.15.4 demodulator. This is used in the RSSI and AGC to select trigger source input signals. 0b - FSK demodulator. 1b - 802.15.4 demodulator. |
| 7 — | Reserved. |
| 6-4 RX_DEC_FILT_OSR | Decimation Filter Oversampling NOTE: All undocumented values are Reserved. 000b - OSR 4 001b - OSR 8 010b - OSR 16 100b - OSR 32 011b - OSR 6 101b - OSR 12 110b - OSR 24 |
| 3 RX_ADC_POL | Receive ADC Polarity Selects polarity of the ADC data 0b - ADC output of 1'b0 maps to -1, 1'b1 maps to +1 (default) 1b - ADC output of 1'b0 maps to +1, 1'b1 maps to -1 |
| 2 — | Reserved. |
| 1 RX_CH_FILT_BYPASS | Receive Channel Filter Bypass Selects whether to disable and bypass channel filter. 0b - Channel filter is enabled. 1b - Disable and bypass channel filter. |
| 0 RX_ADC_NEGEDGE | Receive ADC Negative Edge Selection Selects which edge of the clock the ADC data is registered. 0b - Register ADC data on positive edge of clock 1b - Register ADC data on negative edge of clock |

45.2.2.3.3 AGC Control 0 (AGC_CTRL_0)

45.2.2.3.3.1 Offset

| Register | Offset |
|------------|-----------|
| AGC_CTRL_0 | 4005C004h |

45.2.2.3.3.2 Diagram

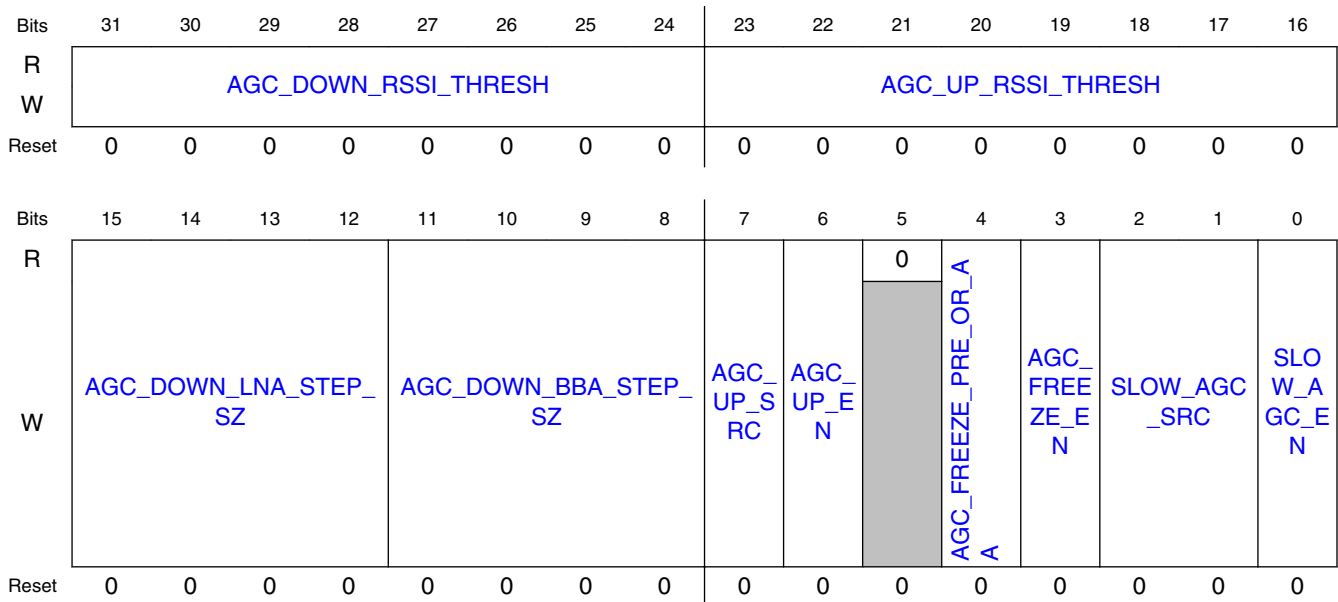

45.2.2.3.3.3 Fields

| Field | Function |
|-------------------------------|---|
| 31-24 AGC_DOWN_RSSI_THRESH | AGC DOWN RSSI Threshold ADC RSSI threshold to take downward step (AGC slow). If the ADC RSSI measurement is higher than this threshold, a downward gain step can be taken. The ADC RSSI is measured directly from the ADC input and does not have any adjustment applied for gain settings, etc. In other words, it is a measurement of how saturated the digital bus is, similar to a dBFS measurement. |
| 23-16 AGC_UP_RSSI_THRESH | AGC UP RSSI Threshold ADC RSSI threshold to take upward step (AGC slow). If the ADC RSSI measurement is below this threshold, an upward gain step can be taken. The ADC RSSI is measured directly from the ADC input and does not have any adjustment applied for gain settings, etc. In other words, it is a measurement of how saturated the digital bus is, similar to a dBFS measurement. |
| 15-12 AGC_DOWN_LNA_STEP_SZ | AGC_DOWN_LNA_STEP_SZ Number of table steps for downward step (LNA) in AGC fast. |
| 11-8 AGC_DOWN_BBA_STEP_SZ | AGC_DOWN_BBA_STEP_SZ Number of table steps for downward step (BBA) in AGC fast. |
| 7 AGC_UP_SRC | AGC Up Source Criterion to use for upward AGC steps in SLOW state. For pdet_lo, a timing window is observed for no assertions of the LO peak detectors and then an upward step is made. If RSSI is selected, the current RSSI measurement is compared with the UP threshold to determine if an upward step is due. 0b - PDET LO 1b - RSSI |

Table continues on the next page...

Radio Register Overview

| Field | Function |
|-------------------------------|--|
| 6 AGC_UP_EN | AGC Up Enable Allow AGC to take upward steps in the gain table in slow mode. |
| 5 — | Reserved. |
| 4 AGC_FREEZE_ PRE_OR_AA | AGC Freeze Source Selection Select trigger source for entering freeze AGC (HOLD state). 0b - Access Address match (for active protocol) 1b - Preamble Detect (for active protocol) |
| 3 AGC_FREEZE_ EN | AGC Freeze Enable Allow AGC to freeze (ie enter HOLD state). AGC can still go to hold mode if timer expires (same as fast expire) from slow mode. |
| 2-1 SLOW_AGC_S RC | Slow AGC Source Selection Select trigger source for entering slow AGC. For address match and preamble detect, the trigger is generated by the PHY. If the Fast AGC expire timer is selected, when the timer expires, the AGC state machine will transition into SLOW. 00b - Access Address match (for active protocol) 01b - Preamble Detect (for active protocol) 10b - Fast AGC expire timer 11b - Reserved |
| 0 SLOW_AGC_E N | Slow AGC Enable Allow AGC to enter into slow mode. |

45.2.2.3.4 AGC Control 1 (AGC_CTRL_1)

45.2.2.3.4.1 Offset

| Register | Offset |
|------------|-----------|
| AGC_CTRL_1 | 4005C008h |

45.2.2.3.4.2 Diagram

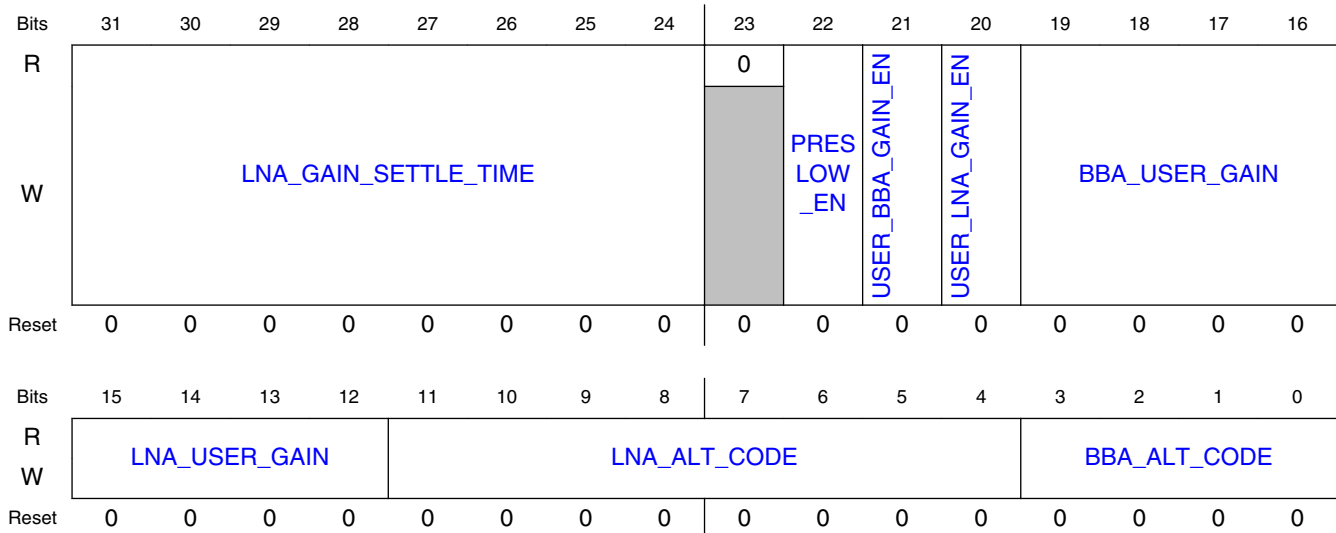

45.2.2.3.4.3 Fields

| Field | Function |
|-------------------------------|---|
| 31-24 LNA_GAIN_SETTLE_TIME | LNA_GAIN_SETTLE_TIME At LNA gain change, number of clocks to assert TZA peak detector reset (for automatic control). Should be programmed greater than zero. |
| 23 — | Reserved. |
| 22 PRESLOW_EN | Pre-slow Enable Enable the pre-slow state where signal headroom is checked before entering SLOW. 0b - Pre-slow is disabled. 1b - Pre-slow is enabled. |
| 21 USER_BBA_GAIN_EN | User BBA Gain Enable Enable user defined BBA gain (no AGC). |
| 20 USER_LNA_GAIN_EN | User LNA Gain Enable Enable user defined LNA gain (no AGC). |
| 19-16 BBA_USER_GAIN_IN | BBA_USER_GAIN User defined BBA gain index if user_bba_gain_en = 1 |
| 15-12 LNA_USER_GAIN_IN | LNA_USER_GAIN User defined LNA gain index if user_lna_gain_en = 1. |
| 11-4 LNA_ALT_CODE | LNA_ALT_CODE Alternate LNA gain code selected when lna_gain_xx=F |

Table continues on the next page...

Radio Register Overview

| Field | Function |
|--------------------------|--|
| 3-0 BBA_ALT_CODE E | BBA_ALT_CODE Alternate BBA gain code selected when bba_gain_xx=0xF. |

45.2.2.3.5 AGC Control 2 (AGC_CTRL_2)

45.2.2.3.5.1 Offset

| Register | Offset |
|------------|-----------|
| AGC_CTRL_2 | 4005C00Ch |

45.2.2.3.5.2 Diagram

| | | | | | | | | | | | | | | | | |
|-------|-----------------|-----------------|-----------------|----------------------|----|----|----|----|-----------------|----|----|-----------------|--------------|-----------------|--------------|----|
| Bits | 31 | 30 | 29 | 28 | 27 | 26 | 25 | 24 | 23 | 22 | 21 | 20 | 19 | 18 | 17 | 16 |
| R | LNA_HG_ON_OVR | LNA_LG_ON_OVR | AGC_FAST_EXPIRE | | | | | | TZA_PDET_SEL_HI | | | TZA_PDET_SEL_LO | | BBA_PDET_SEL_HI | | |
| W | | | | | | | | | | | | | | | | |
| Reset | 0 | 0 | 0 | 0 | 0 | 0 | 0 | 0 | 1 | 0 | 1 | 0 | 0 | 1 | 1 | 0 |
| Bits | 15 | 14 | 13 | 12 | 11 | 10 | 9 | 8 | 7 | 6 | 5 | 4 | 3 | 2 | 1 | 0 |
| R | BBA_PDET_SEL_HI | BBA_PDET_SEL_LO | | BBA_GAIN_SETTLE_TIME | | | | | | | | 0 | MAN_PDET_RST | TZA_PDET_RST | BBA_PDET_RST | |
| W | | | | | | | | | | | | | | | | |
| Reset | 1 | 0 | 0 | 1 | 0 | 0 | 0 | 0 | 0 | 0 | 0 | 0 | 0 | 0 | 0 | 0 |

45.2.2.3.5.3 Fields

| Field | Function |
|--------------------------|--|
| 31 LNA_HG_ON_OVR | LNA_HG_ON override If set, the lna high gain "on" signal is always asserted. Otherwise, this signal is asserted automatically based on the LNA_GAIN code. |
| 30 LNA_LG_ON_OVR | LNA_LG_ON override If set, the lna low gain "on" signal is always asserted. Otherwise, this signal is asserted automatically based on the LNA_GAIN code. |
| 29-24 AGC_FAST_EXPIRE | AGC Fast Expire Expire time (uS) for fast AGC (1-63uS). |

Table continues on the next page...

| Field | Function |
|----------------------------------|---|
| 23-21 TZA_PDET_SE L_HI | TZA PDET Threshold High TZA peak detect HI threshold. 000b - 0.60V 001b - 0.63V 010b - 0.66V 011b - 0.69V 100b - 0.72V 101b - 0.75V 110b - 0.78V 111b - 0.81V |
| 20-18 TZA_PDET_SE L_LO | TZA PDET Threshold Low TZA peak detect LO threshold. 000b - 0.600V 001b - 0.615V 010b - 0.630V 011b - 0.645V 100b - 0.660V 101b - 0.675V 110b - 0.690V 111b - 0.705V |
| 17-15 BBA_PDET_SE L_HI | BBA PDET Threshold High BBA peak detect HI threshold. 000b - 0.600V 001b - 0.795V 010b - 0.900V 011b - 0.945V 100b - 1.005V 101b - 1.050V 110b - 1.095V 111b - 1.155V |
| 14-12 BBA_PDET_SE L_LO | BBA PDET Threshold Low BBA peak detect LO threshold. 000b - 0.600V 001b - 0.615V 010b - 0.630V 011b - 0.645V 100b - 0.660V 101b - 0.675V 110b - 0.690V 111b - 0.705V |
| 11-4 BBA_GAIN_SE TTLE_TIME | BBA Gain Settle Time Number of clocks to assert BBA peak detector reset (for automatic control). Should be programmed greater than zero. |
| 3 — | Reserved. |
| 2 MAN_PDET_RST | MAN PDET Reset 0b - The peak detector reset signals are controlled automatically by the AGC. 1b - The BBA_PDET_RST and TZA_PDET_RST are used to manually control the peak detector reset signals. |
| 1 | TZA PDET Reset TZA peak detector reset, manual control. |

Table continues on the next page...

Radio Register Overview

| Field | Function |
|--------------|--|
| TZA_PDET_RST | |
| 0 | BBA PDET Reset |
| BBA_PDET_RST | BBA peak detector reset, manual control. |

45.2.2.3.6 AGC Control 3 (AGC_CTRL_3)

45.2.2.3.6.1 Offset

| Register | Offset |
|------------|-----------|
| AGC_CTRL_3 | 4005C010h |

45.2.2.3.6.2 Diagram

| | | | | | | | | | | | | | | | | |
|-------|-------------------|----|----|-------------------|-----------------|----|----|----|-------------------|----|----|----|----|----|----|----|
| Bits | 31 | 30 | 29 | 28 | 27 | 26 | 25 | 24 | 23 | 22 | 21 | 20 | 19 | 18 | 17 | 16 |
| R | AGC_UP_STEP_SZ | | | | AGC_H2S_STEP_SZ | | | | AGC_RSSI_DELT_H2S | | | | | | | |
| W | | | | | | | | | | | | | | | | |
| Reset | 0 | 0 | 0 | 0 | 0 | 0 | 0 | 0 | 0 | 0 | 0 | 0 | 0 | 0 | 0 | 0 |
| Bits | 15 | 14 | 13 | 12 | 11 | 10 | 9 | 8 | 7 | 6 | 5 | 4 | 3 | 2 | 1 | 0 |
| R | AGC_PDET_LO_DELAY | | | AGC_UNFREEZE_TIME | | | | | | | | | | | | |
| W | | | | | | | | | | | | | | | | |
| Reset | 0 | 0 | 0 | 0 | 0 | 0 | 0 | 0 | 0 | 0 | 0 | 0 | 0 | 0 | 0 | 0 |

45.2.2.3.6.3 Fields

| Field | Function |
|-------------------|---|
| 31-28 | AGC Up Step Size |
| AGC_UP_STEP_SZ | Number of AGC gain table steps for upward step |
| 27-23 | AGC_H2S_STEP_SZ |
| AGC_H2S_STEP_SZ | AGC gain table step size for hold to slow jump. |
| 22-16 | AGC_RSSI_DELT_H2S |
| AGC_RSSI_DELT_H2S | RSSI delta that causes hold to slow transition. This delta is observed from a previous RSSI measurement to a current measurement. |
| 15-13 | AGC Peak Detect Low Delay |

Table continues on the next page...

| Field | Function |
|-------------------|---|
| AGC_PDET_LO_DLY | Time (uS) to wait for pdet low to assert (1-7uS). |
| 12-0 | AGC Unfreeze Time |
| AGC_UNFREEZE_TIME | Time (uS) for AGC to unfreeze (1-8191uS) from HOLD and re-enter SLOW state. |

45.2.2.3.7 AGC Status (AGC_STAT)

45.2.2.3.7.1 Offset

| Register | Offset |
|----------|-----------|
| AGC_STAT | 4005C014h |

45.2.2.3.7.2 Diagram

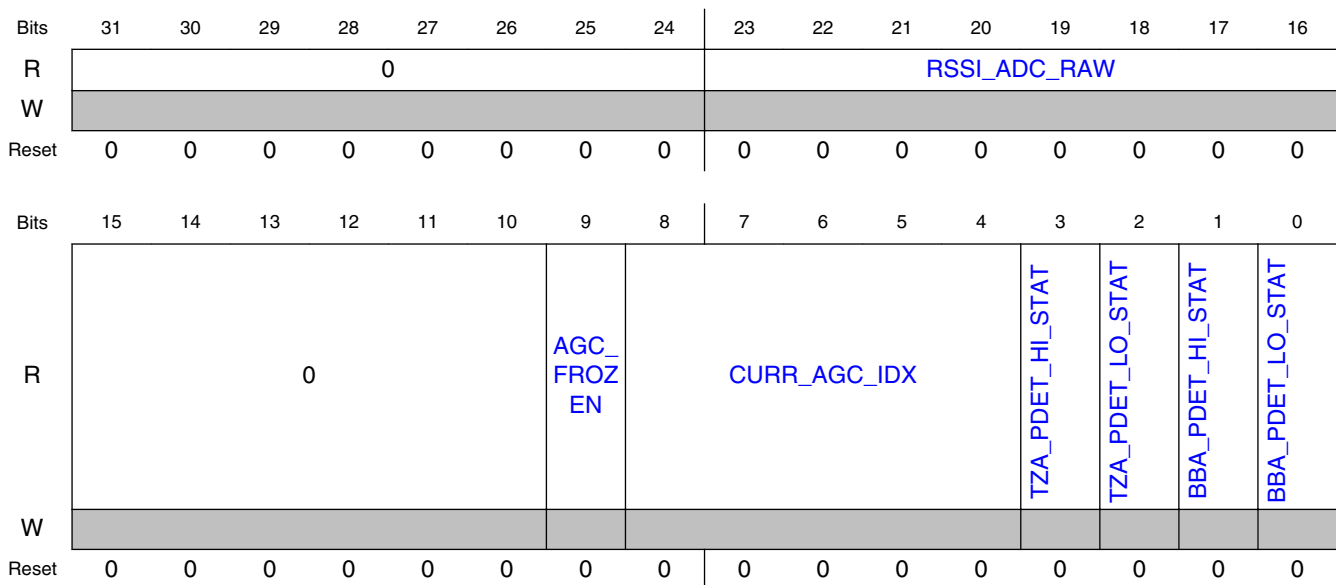

45.2.2.3.7.3 Fields

| Field | Function |
|-------|----------------------|
| 31-24 | Reserved. |
| — | |
| 23-16 | ADC RAW RSSI Reading |

Table continues on the next page...

Radio Register Overview

| Field | Function |
|---------------------------|--|
| RSSI_ADC_RA W | Reading of ADC rssi (before adjustments) |
| 15-10 — | Reserved. |
| 9 AGC_FROZEN | AGC Frozen Status Status of AGC freeze. 0b - AGC is not frozen. 1b - AGC is frozen. |
| 8-4 CURR_AGC_ID X | Current AGC Gain Index Current AGC gain table index |
| 3 TZA_PDET_HI_ STAT | TZA Peak Detector High Status Status of TZA peak detector HI flag (1=set) |
| 2 TZA_PDET_LO _STAT | TZA Peak Detector Low Status Status of TZA peak detector LO flag (1=set) |
| 1 BBA_PDET_HI_ STAT | BBA Peak Detector High Status Status of BBA peak detector HI flag (1=set) |
| 0 BBA_PDET_LO _STAT | BBA Peak Detector Low Status Status of BBA peak detector LO flag (1=set) |

45.2.2.3.8 RSSI Control 0 (RSSI_CTRL_0)

45.2.2.3.8.1 Offset

| Register | Offset |
|-------------|-----------|
| RSSI_CTRL_0 | 4005C018h |

45.2.2.3.8.2 Diagram

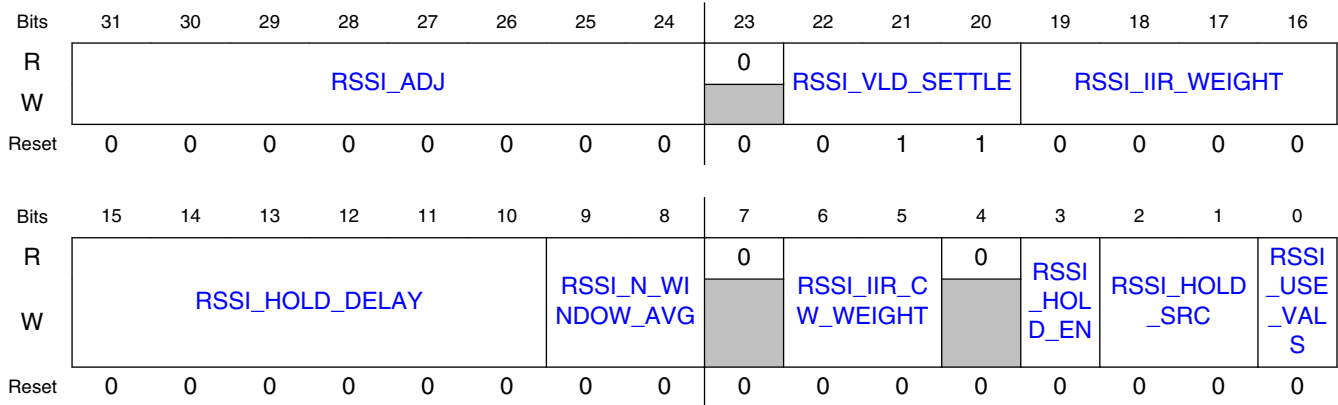

45.2.2.3.8.3 Fields

| Field | Function |
|--------------------------|--|
| 31-24 RSSI_ADJ | RSSI Adjustment RSSI calculation adjustment (8-bit signed 1/4 dB). |
| 23 — | Reserved. |
| 22-20 RSSI_VLD_SETTLE | RSSI Valid Settle Sets number of us (times 8) that RSSI will be considered invalid after certain events. |
| 19-16 RSSI_IIR_WEIGHT | RSSI IIR Weighting IIR filter weight for RSSI filtering. NOTE: All undocumented values are Reserved. 0000b - Bypass 0001b - 1/2 0010b - 1/4 0011b - 1/8 0100b - 1/16 0101b - 1/32 |
| 15-10 RSSI_HOLD_DELAY | RSSI Hold Delay Sets number of us (times 8) that RSSI will run after a hold event before the value is frozen. |
| 9-8 RSSI_N_WINDOW_AVG | RSSI N Window Average Selects Averaging window length for RSSI. 00b - No averaging 01b - Averaging window length is 2 samples 10b - Averaging window length is 4 samples 11b - Averaging window length is 8 samples |
| 7 — | Reserved. |
| 6-5 | RSSI IIR CW Weighting |

Table continues on the next page...

Radio Register Overview

| Field | Function |
|----------------------|--|
| RSSI_IIR_CW_WEIGHT | IIR filter weight for RSSI filtering of a CW input. 00b - Bypass 01b - 1/8 10b - 1/16 11b - 1/32 |
| 4 — | Reserved. |
| 3 RSSI_HOLD_EN | RSSI Hold Enable Enable RSSI to freeze after hold criterion met. RSSI will still be briefly held when a gain change occurs. |
| 2-1 RSSI_HOLD_SRC | RSSI Hold Source Selection Select trigger source for freezing RSSI measurement. 00b - Access Address match 01b - Preamble Detect 10b - Reserved 11b - 802.15.4 LQI done (1=freeze, 0=run AGC) |
| 0 RSSI_USE_VALS | RSSI Values Selection Enable use of LNA and BBA gain values programmed in registers for calculation. |

45.2.2.3.9 RSSI Control 1 (RSSI_CTRL_1)

45.2.2.3.9.1 Offset

| Register | Offset |
|-------------|-----------|
| RSSI_CTRL_1 | 4005C01Ch |

45.2.2.3.9.2 Diagram

| | | | | | | | | | | | | | | | | |
|-------|----------|----|----|----|----|----|----|----|----|----|----|----|----|----|----|----|
| Bits | 31 | 30 | 29 | 28 | 27 | 26 | 25 | 24 | 23 | 22 | 21 | 20 | 19 | 18 | 17 | 16 |
| R | RSSI_OUT | | | | | | | | 0 | | | | | | | |
| W | [Shaded] | | | | | | | | | | | | | | | |
| Reset | 0 | 0 | 0 | 0 | 0 | 0 | 0 | 0 | 0 | 0 | 0 | 0 | 0 | 0 | 0 | 0 |
| Bits | 15 | 14 | 13 | 12 | 11 | 10 | 9 | 8 | 7 | 6 | 5 | 4 | 3 | 2 | 1 | 0 |
| R | 0 | | | | | | | | | | | | | | | |
| W | [Shaded] | | | | | | | | | | | | | | | |
| Reset | 0 | 0 | 0 | 0 | 0 | 0 | 0 | 0 | 0 | 0 | 0 | 0 | 0 | 0 | 0 | 0 |

45.2.2.3.9.3 Fields

| Field | Function |
|-------------------|---|
| 31-24 RSSI_OUT | RSSI Reading RSSI output (8-bit signed). |
| 23-0 Reserved | Reserved. |

45.2.2.3.10 DCOC Control 0 (DCOC_CTRL_0)

45.2.2.3.10.1 Offset

| Register | Offset |
|-------------|-----------|
| DCOC_CTRL_0 | 4005C024h |

45.2.2.3.10.2 Diagram

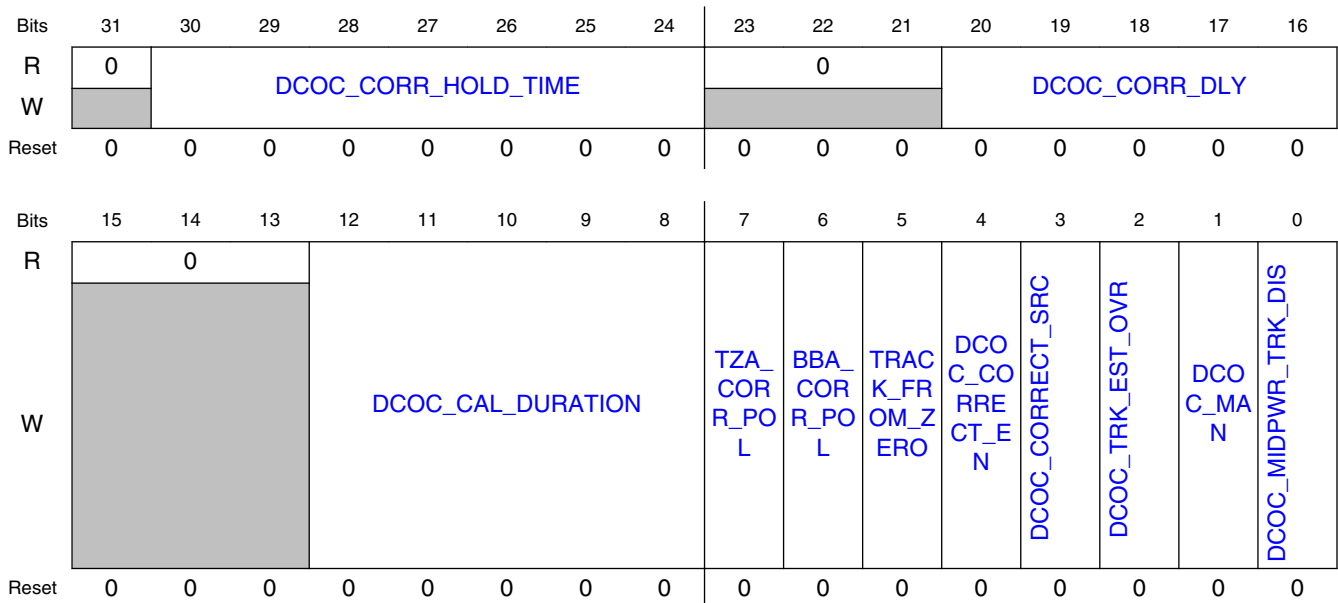

45.2.2.3.10.3 Fields

| Field | Function |
|---------|-----------|
| 31 — | Reserved. |

Table continues on the next page...

Radio Register Overview

| Field | Function |
|------------------------------|---|
| 30-24 DCOC_CORR_HOLD_TIME | DCOC Correction Hold Time Delay from last gain change to freezing the DC correction. 000000b - Reserved 0000001-1111110b - For a 32MHz reference clock, this is the delay in microseconds; for other reference clock frequencies, the delay is scaled accordingly. 1111111b - The DC correction is not frozen. |
| 23-21 — | Reserved. |
| 20-16 DCOC_CORR_DLY | DCOC Correction Delay Wait time between corrections. 00000b - Reserved 00001-11111b - For a 32MHz reference clock, this is the wait time in microseconds; for other reference clock frequencies, the delay is scaled accordingly. |
| 15-13 — | Reserved. |
| 12-8 DCOC_CAL_DURATION | DCOC Calibration Duration 00000b - Reserved 00001-11111b - For a 32MHz reference clock, this is the calibration duration in microseconds; for other reference clock frequencies, the delay is scaled accordingly. |
| 7 TZA_CORR_POL | TZA Correction Polarity Selects polarity of TZA corrections. 0b - Normal polarity. 1b - Negative polarity. This should be set if the ADC output is inverted, or if the TZA DACs were implemented with negative polarity. |
| 6 BBA_CORR_POL | BBA Correction Polarity Selects polarity of BBA corrections. 0b - Normal polarity. 1b - Negative polarity. This should be set if the ADC output is inverted, or if the BBA DACs were implemented with negative polarity. |
| 5 TRACK_FROM_ZERO | Track from Zero Selects whether the tracking estimator resets its DC estimate on every AGC gain change to zero or uses the current I/Q sample. 0b - Track from current I/Q sample. 1b - Track from zero. |
| 4 DCOC_CORRECT_EN | DCOC Correction Enable 0b - Correction disabled. The DCOC will not correct the DC offset. 1b - Correction enabled. The DCOC will use the TZA and BBA DACs, and apply digital corrections (if DCOC_CORRECT_SRC=1) to correct the DC offset. |
| 3 DCOC_CORRECT_SRC | DCOC Corrector Source If not set, the corrector uses only the DCOC calibration table to apply corrections to the DCOC DACs. 0b - If correction is enabled, the DCOC will use only the DCOC calibration table to correct the DC offset. 1b - If correction is enabled, the DCOC will use the DCOC calibration table and then the tracking estimator to correct the DC offset. |
| 2 DCOC_TRK_EST_OVR | Override for the DCOC tracking estimator 0b - The tracking estimator is enabled only as needed by the corrector 1b - The tracking estimator remains enabled whenever the DCOC is active |
| 1 | DCOC Manual Override |

Table continues on the next page...

| Field | Function |
|-------------------------|---|
| DCOC_MAN | If the manual override bit is set, it forces the DCOC to use the DAC and digital correction values from registers DCOC_DAC_INIT and DCOC_DIG_MAN, respectively. |
| 0 | DCOC Mid Power Tracking Disable |
| DCOC_MIDPW R_TRK_DIS | Disables tracking correction at mid power levels, as indicated by the TZA and BBA lo peak detectors. This is implemented by resetting the counters associated with DCOC_CORR_DLY and DCOC_CORR_HOLD_TIME, so if the lo peak detectors do not continue to assert, tracking corrections would resume operation. The tracking estimator is not disabled and the counter associated with DCOC_TRK_EST_GS_CNT is not reset when this condition occurs. 0b - Tracking corrections are enabled as determined by DCOC_CORRECT_SRC and DCOC_TRK_MIN_AGC_IDX. 1b - Tracking corrections are disabled when either the TZA or BBA lo peak detector asserts. |

45.2.2.3.11 DCOC Control 1 (DCOC_CTRL_1)

45.2.2.3.11.1 Offset

| Register | Offset |
|-------------|-----------|
| DCOC_CTRL_1 | 4005C028h |

45.2.2.3.11.2 Diagram

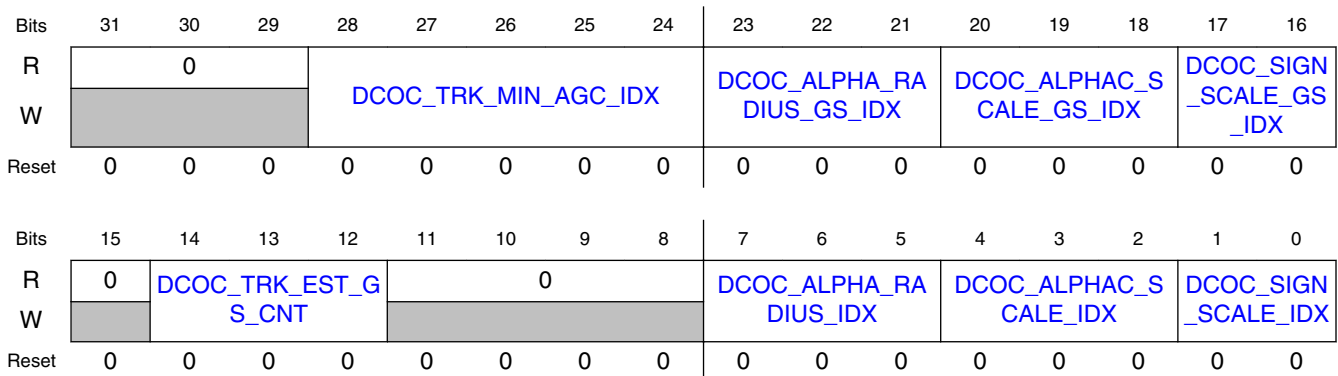

45.2.2.3.11.3 Fields

| Field | Function |
|-------|---------------------------------------|
| 31-29 | Reserved. |
| — | |
| 28-24 | DCOC Tracking Minimum AGC Table Index |

Table continues on the next page...

Radio Register Overview

| Field | Function |
|------------------------------------|---|
| DCOC_TRK_MIN_AGC_IDX | Specifies the minimum AGC table index value at which tracking is enabled. E.g., if this is 5'd0, then tracking is enabled for all AGC gain table indexes (assuming DCOC_CORRECT_SRC is set) if this is 5'd20, then tracking is enabled for AGC gain table indexes 20-26 (assuming DCOC_CORRECT_SRC is set). |
| 23-21 DCOC_ALPHA_RADIUS_GS_IDX | Alpha-R Scaling for Gearshift DCOC Alpha-R Scaling for Gearshift. Radius stepsize used in the DCOC tracking estimator after the gearshift counter has expired. Used when DCOC_CORRECT_SRC=1. 000b - 1 001b - 1/2 010b - 1/4 011b - 1/8 100b - 1/16 101b - 1/32 110b - 1/64 111b - Reserved |
| 20-18 DCOC_ALPHA_C_SCALE_GS_IDX | DCOC Alpha-C Scaling for Gearshift DCOC Alpha-C Scaling for Gearshift. I/Q center stepsize used in the DCOC tracking estimator after the gearshift counter has expired. Used when DCOC_CORRECT_SRC=1. 000b - 1/2 001b - 1/4 010b - 1/8 011b - 1/16 100b - 1/32 101b - 1/64 110b - Reserved 111b - Reserved |
| 17-16 DCOC_SIGN_SCALE_GS_IDX | DCOC Sign Scaling for Gearshift DCOC Sign Scaling for Gearshift. Sign()-based scaling factor used in the DCOC tracking estimator after the gearshift counter has expired. Used when DCOC_CORRECT_SRC=1. 00b - 1/8 01b - 1/16 10b - 1/32 11b - 1/64 |
| 15 — | Reserved. |
| 14-12 DCOC_TRK_EST_GS_CNT | DCOC Tracking Estimator Gearshift Count Specifies the number of corrections (periods of DCOC_CORR_DLY) before the tracking estimator switches from using the set of parameters {DCOC_ALPHA_RADIUS_IDX, DCOC_ALPHAC_SCALE_IDX, DCOC_SIGN_SCALE_IDX} to the set of gearshift parameters {DCOC_ALPHA_RADIUS_GS_IDX, DCOC_ALPHAC_SCALE_GS_IDX, DCOC_SIGN_SCALE_GS_IDX}. If the value is 0, the set of gearshift parameters are not used. |
| 11-8 — | Reserved. |
| 7-5 DCOC_ALPHA_RADIUS_IDX | Alpha-R Scaling DCOC Alpha-R Scaling. Radius stepsize used in the DCOC tracking estimator. Used when DCOC_CORRECT_SRC=1. 000b - 1 001b - 1/2 010b - 1/4 011b - 1/8 100b - 1/16 |

Table continues on the next page...

| Field | Function |
|-------------------------------|---|
| | 101b - 1/32 110b - 1/64 111b - Reserved |
| 4-2 DCOC_ALPHA_C_SCALE_IDX | DCOC Alpha-C Scaling DCOC Alpha-C Scaling. I/Q center stepsize used in the DCOC tracking estimator. Used when DCOC_CORRECT_SRC=1. 000b - 1/2 001b - 1/4 010b - 1/8 011b - 1/16 100b - 1/32 101b - 1/64 110b - Reserved 111b - Reserved |
| 1-0 DCOC_SIGN_SCALE_IDX | DCOC Sign Scaling DCOC Sign Scaling. Sign()-based scaling factor used in the DCOC tracking estimator. Used when DCOC_CORRECT_SRC=1. 00b - 1/8 01b - 1/16 10b - 1/32 11b - 1/64 |

45.2.2.3.12 DCOC DAC Initialization (DCOC_DAC_INIT)

45.2.2.3.12.1 Offset

| Register | Offset |
|---------------|-----------|
| DCOC_DAC_INIT | 4005C02Ch |

45.2.2.3.12.2 Diagram

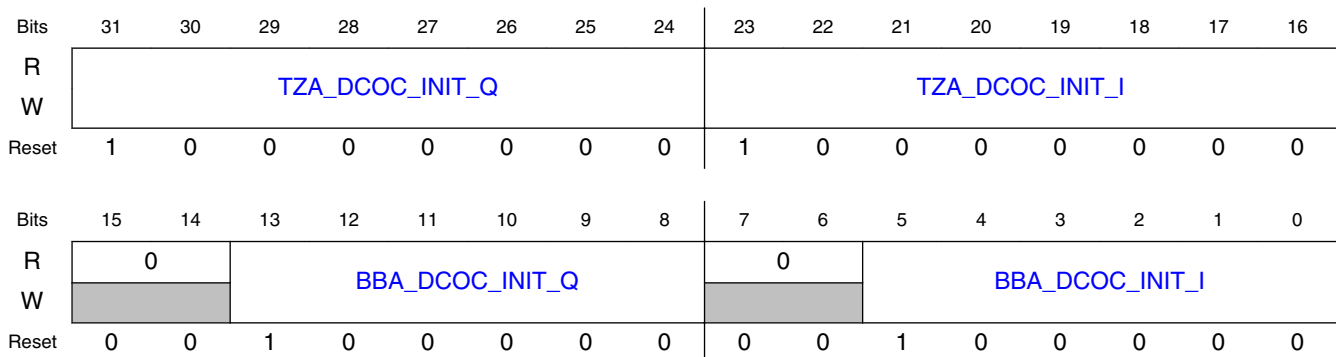

45.2.2.3.12.3 Fields

| Field | Function |
|------------------------------|--|
| 31-24 TZA_DCOC_INI T_Q | DCOC TZA Init Q Value used for DCOC TZA Q channel DAC during calibration and for manual override. |
| 23-16 TZA_DCOC_INI T_I | DCOC TZA Init I Value used for DCOC TZA I channel DAC during calibration and for manual override. |
| 15-14 — | Reserved. |
| 13-8 BBA_DCOC_INI T_Q | DCOC BBA Init Q Value used for DCOC BBA Q channel DAC during calibration and for manual override. |
| 7-6 — | Reserved. |
| 5-0 BBA_DCOC_INI T_I | DCOC BBA Init I Value used for DCOC BBA I channel DAC during calibration and for manual override. |

45.2.2.3.13 DCOC Digital Correction Manual Override (DCOC_DIG_MAN)

45.2.2.3.13.1 Offset

| Register | Offset |
|--------------|-----------|
| DCOC_DIG_MAN | 4005C030h |

45.2.2.3.13.2 Diagram

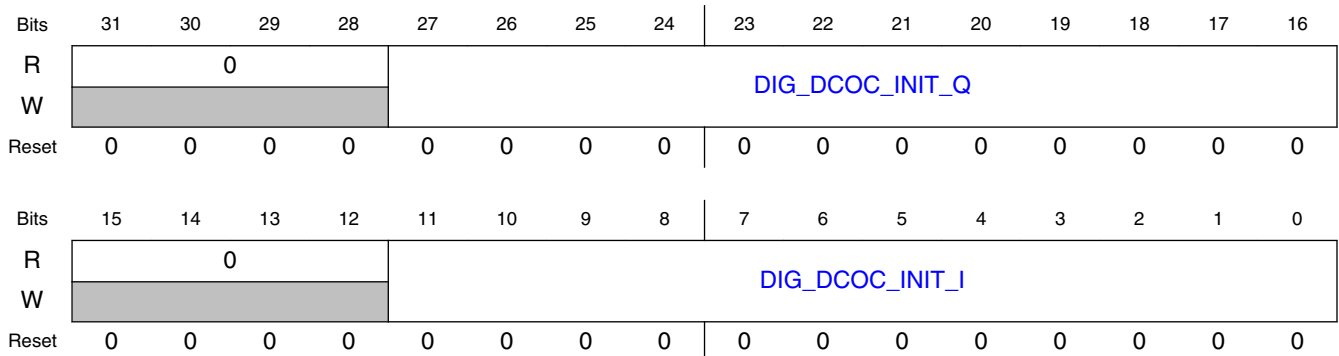

45.2.2.3.13.3 Fields

| Field | Function |
|------------------------------|--|
| 31-28 — | Reserved. |
| 27-16 DIG_DCOC_INI T_Q | DCOC DIG Init Q Manual override for DCOC DIG Q channel correction. Value to be subtracted from downsampled Q channel. Used when DCOC_MAN=1. |
| 15-12 — | Reserved. |
| 11-0 DIG_DCOC_INI T_I | DCOC DIG Init I Manual override for DCOC DIG I channel correction. Value to be subtracted from downsampled I channel. Used when DCOC_MAN=1. |

45.2.2.3.14 DCOC Calibration Gain (DCOC_CAL_GAIN)

45.2.2.3.14.1 Offset

| Register | Offset |
|---------------|-----------|
| DCOC_CAL_GAIN | 4005C034h |

45.2.2.3.14.2 Diagram

| | | | | | | | | | | | | | | | | |
|-------|--------------------|----|----|----|--------------------|----|----|----|--------------------|----|----|----|--------------------|----|----|----|
| Bits | 31 | 30 | 29 | 28 | 27 | 26 | 25 | 24 | 23 | 22 | 21 | 20 | 19 | 18 | 17 | 16 |
| R | DCOC_LNA_CAL_GAIN3 | | | | DCOC_BBA_CAL_GAIN3 | | | | DCOC_LNA_CAL_GAIN2 | | | | DCOC_BBA_CAL_GAIN2 | | | |
| W | | | | | | | | | | | | | | | | |
| Reset | 0 | 0 | 0 | 0 | 0 | 0 | 0 | 0 | 0 | 0 | 0 | 0 | 0 | 0 | 0 | 0 |
| Bits | 15 | 14 | 13 | 12 | 11 | 10 | 9 | 8 | 7 | 6 | 5 | 4 | 3 | 2 | 1 | 0 |
| R | DCOC_LNA_CAL_GAIN1 | | | | DCOC_BBA_CAL_GAIN1 | | | | 0 | | | | | | | |
| W | | | | | | | | | | | | | | | | |
| Reset | 0 | 0 | 0 | 0 | 0 | 0 | 0 | 0 | 0 | 0 | 0 | 0 | 0 | 0 | 0 | 0 |

45.2.2.3.14.3 Fields

| Field | Function |
|-------|--|
| 31-28 | DCOC LNA Calibration Gain 3 The LNA gain index used for the 3rd DCOC calibration point. Used when RX_DCOC_CAL_EN=1. |

Table continues on the next page...

Radio Register Overview

| Field | Function |
|--------------------|---|
| DCOC_LNA_CAL_GAIN3 | |
| 27-24 | DCOC BBA Calibration Gain 3 |
| DCOC_BBA_CAL_GAIN3 | The BBA gain index used for the 3rd DCOC calibration point. Used when RX_DCOC_CAL_EN=1. |
| 23-20 | DCOC LNA Calibration Gain 2 |
| DCOC_LNA_CAL_GAIN2 | The LNA gain index used for the 2nd DCOC calibration point. Used when RX_DCOC_CAL_EN=1. |
| 19-16 | DCOC BBA Calibration Gain 2 |
| DCOC_BBA_CAL_GAIN2 | The BBA gain index used for the 2nd DCOC calibration point. Used when RX_DCOC_CAL_EN=1. |
| 15-12 | DCOC LNA Calibration Gain 1 |
| DCOC_LNA_CAL_GAIN1 | The LNA gain index used for the 1st DCOC calibration point. Used when RX_DCOC_CAL_EN=1. |
| 11-8 | DCOC BBA Calibration Gain 1 |
| DCOC_BBA_CAL_GAIN1 | The BBA gain index used for the 1st DCOC calibration point. Used when RX_DCOC_CAL_EN=1. |
| 7-0 | Reserved. |
| — | |

45.2.2.3.15 DCOC Status (DCOC_STAT)

45.2.2.3.15.1 Offset

| Register | Offset |
|-----------|-----------|
| DCOC_STAT | 4005C038h |

45.2.2.3.15.2 Diagram

| | | | | | | | | | | | | | | | | |
|-------|--------------|------------|----|----|----|----|----|----|------------|------------|----|----|----|----|----|----|
| Bits | 31 | 30 | 29 | 28 | 27 | 26 | 25 | 24 | 23 | 22 | 21 | 20 | 19 | 18 | 17 | 16 |
| R | TZA_DCOC_Q | | | | | | | | TZA_DCOC_I | | | | | | | |
| W | [Greyed out] | | | | | | | | | | | | | | | |
| Reset | 1 | 0 | 0 | 0 | 0 | 0 | 0 | 0 | 1 | 0 | 0 | 0 | 0 | 0 | 0 | 0 |
| Bits | 15 | 14 | 13 | 12 | 11 | 10 | 9 | 8 | 7 | 6 | 5 | 4 | 3 | 2 | 1 | 0 |
| R | 0 | BBA_DCOC_Q | | | | | | | 0 | BBA_DCOC_I | | | | | | |
| W | [Greyed out] | | | | | | | | | | | | | | | |
| Reset | 0 | 0 | 1 | 0 | 0 | 0 | 0 | 0 | 0 | 0 | 1 | 0 | 0 | 0 | 0 | 0 |

45.2.2.3.15.3 Fields

| Field | Function |
|---------------------|--|
| 31-24 TZA_DCOC_Q | DCOC TZA DAC Q Current TZA DAC setting for Q channel. Note that the TZA DACs have a bias of 0x80; 0x0 represents the most negative DC offset, 0x80 represents a DC offset of 0, and 0xFF represents the most positive DC offset. This is provided for debug and characterization purposes only. |
| 23-16 TZA_DCOC_I | DCOC TZA DAC I Current TZA DAC setting for I channel. Note that the TZA DACs have a bias of 0x80; 0x0 represents the most negative DC offset, 0x80 represents a DC offset of 0, and 0xFF represents the most positive DC offset. This is provided for debug and characterization purposes only. |
| 15-14 — | Reserved. |
| 13-8 BBA_DCOC_Q | DCOC BBA DAC Q Current BBA DAC setting for Q channel. Note that the BBA DACs have a bias of 0x20; 0x0 represents the most negative DC offset, 0x20 represents a DC offset of 0, and 0x3F represents the most positive DC offset. This is provided for debug and characterization purposes only. |
| 7-6 — | Reserved. |
| 5-0 BBA_DCOC_I | DCOC BBA DAC I Current BBA DAC setting for I channel. Note that the BBA DACs have a bias of 0x20; 0x0 represents the most negative DC offset, 0x20 represents a DC offset of 0, and 0x3F represents the most positive DC offset. This is provided for debug and characterization purposes only. |

45.2.2.3.16 DCOC DC Estimate (DCOC_DC_EST)

45.2.2.3.16.1 Offset

| Register | Offset |
|-------------|-----------|
| DCOC_DC_EST | 4005C03Ch |

45.2.2.3.16.2 Diagram

| | | | | | | | | | | | | | | | | |
|-------|----|----|----|----|----|----|----|----|----------|----|----|----|----|----|----|----|
| Bits | 31 | 30 | 29 | 28 | 27 | 26 | 25 | 24 | 23 | 22 | 21 | 20 | 19 | 18 | 17 | 16 |
| R | 0 | | | | | | | | DC_EST_Q | | | | | | | |
| W | — | | | | | | | | | | | | | | | |
| Reset | 0 | 0 | 0 | 0 | 0 | 0 | 0 | 0 | 0 | 0 | 0 | 0 | 0 | 0 | 0 | 0 |
| Bits | 15 | 14 | 13 | 12 | 11 | 10 | 9 | 8 | 7 | 6 | 5 | 4 | 3 | 2 | 1 | 0 |
| R | 0 | | | | | | | | DC_EST_I | | | | | | | |
| W | — | | | | | | | | | | | | | | | |
| Reset | 0 | 0 | 0 | 0 | 0 | 0 | 0 | 0 | 0 | 0 | 0 | 0 | 0 | 0 | 0 | 0 |

45.2.2.3.16.3 Fields

| Field | Function |
|-------------------|--|
| 31-28 — | Reserved. |
| 27-16 DC_EST_Q | DCOC DC Estimate Q Reflects the current DCOC DC tracking estimate for Q channel. Format s11. Used when DCOC_CORRECT_SRC=1. This is provided for debug and characterization purposes only. |
| 15-12 — | Reserved. |
| 11-0 DC_EST_I | DCOC DC Estimate I Reflects the current DCOC DC tracking estimate for I channel. Format s11. Used when DCOC_CORRECT_SRC=1. This is provided for debug and characterization purposes only. |

45.2.2.3.17 DCOC Calibration Reciprocals (DCOC_CAL_RCP)

45.2.2.3.17.1 Offset

| Register | Offset |
|--------------|-----------|
| DCOC_CAL_RCP | 4005C040h |

45.2.2.3.17.2 Diagram

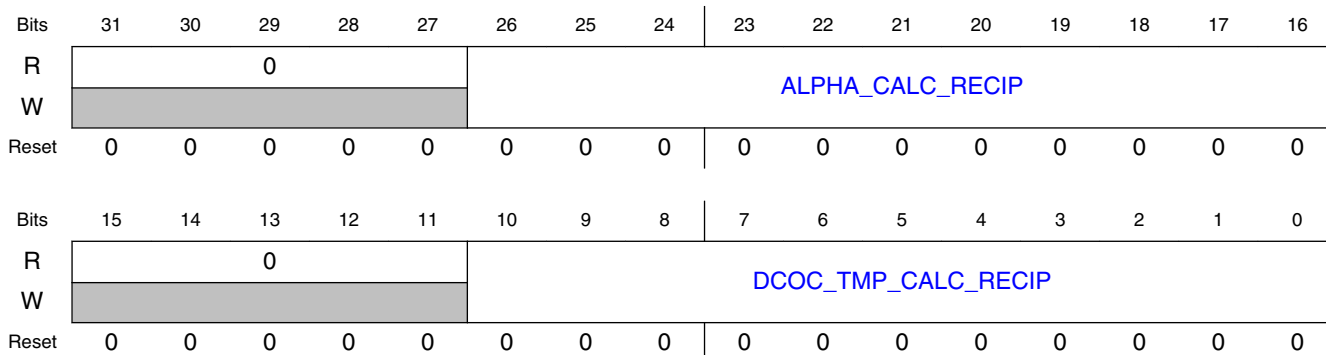

45.2.2.3.17.3 Fields

| Field | Function |
|-------|-----------|
| 31-27 | Reserved. |

Table continues on the next page...

| Field | Function |
|---------------------------------|---|
| — | |
| 26-16 ALPHA_CALC_ RECIP | Alpha Calculation Reciprocal DCOC Alpha calculation reciprocal (format: u.11). This is used in DCOC calibration calculation of the alpha DC component. It is defined as: $1.0/((G_{L_HI} - G_{L_LO}) * G_{B_LO})$ This is stored as with 11 fractional bits, so program the value $\text{round}([1.0/((G_{L_HI} - G_{L_LO}) * G_{B_LO})] * 2^{11})$. |
| 15-11 — | Reserved. |
| 10-0 DCOC_TMP_C ALC_RECIP | DCOC Calculation Reciprocal DCOC_tmp calculation reciprocal (format: u1.10). This is used in DCDC calibration calculation. It is defined as $1.0/(G_{B_HI} - G_{B_LO})$ This is stored with 10 fractional bits, so program the value $\text{round}([1.0/(G_{B_HI} - G_{B_LO})] * 2^{10})$. |

45.2.2.3.18 IQMC Control (IQMC_CTRL)

45.2.2.3.18.1 Offset

| Register | Offset |
|-----------|-----------|
| IQMC_CTRL | 4005C048h |

45.2.2.3.18.2 Function

IQMC Control register. This register can only be accessed when the radio oscillator clock is active.

45.2.2.3.18.3 Diagram

| | | | | | | | | | | | | | | | | | |
|-------|---------------|----|----|----|----|------------------|----|----|----------|----|----|----|----|----|----|----|-------------|
| Bits | 31 | 30 | 29 | 28 | 27 | 26 | 25 | 24 | 23 | 22 | 21 | 20 | 19 | 18 | 17 | 16 | |
| R | 0 | | | | | IQMC_DC_GAIN_ADJ | | | | | | | | | | | |
| W | [Shaded] | | | | | [Shaded] | | | | | | | | | | | |
| Reset | 0 | 0 | 0 | 0 | 0 | 1 | 0 | 0 | 0 | 0 | 0 | 0 | 0 | 0 | 0 | 0 | |
| Bits | 15 | 14 | 13 | 12 | 11 | 10 | 9 | 8 | 7 | 6 | 5 | 4 | 3 | 2 | 1 | 0 | |
| R | IQMC_NUM_ITER | | | | | | | | 0 | | | | | | | | IQMC_CAL_EN |
| W | [Shaded] | | | | | | | | [Shaded] | | | | | | | | [Shaded] |
| Reset | 1 | 0 | 0 | 0 | 0 | 0 | 0 | 0 | 0 | 0 | 0 | 0 | 0 | 0 | 0 | 0 | |

45.2.2.3.18.4 Fields

| Field | Function |
|---------------------------|---|
| 31-27 — | Reserved. |
| 26-16 IQMC_DC_GAIN_ADJ | IQ Mismatch Correction DC Gain Coeff I/Q mismatch correction DC gain coefficient. This gain value is used only during DCOC calibration. It is not calculated during the IQMC calibration sequence, so it must be written by software. The format is u1.10; the reset value of 0x400 corresponds to a DC gain coefficient of 1.0. |
| 15-8 IQMC_NUM_ITER | IQ Mismatch Cal Num Iter Number of iterations for IQ Mismatch Calibration. |
| 7-1 — | Reserved. |
| 0 IQMC_CAL_EN | IQ Mismatch Cal Enable Enables IQ mismatch calibration. This bit is self-clearing; it will clear automatically at the end of the calibration sequence. |

45.2.2.3.19 IQMC Calibration (IQMC_CAL)

45.2.2.3.19.1 Offset

| Register | Offset |
|----------|-----------|
| IQMC_CAL | 4005C04Ch |

45.2.2.3.19.2 Function

IQMC Calibration register. This register can only be accessed when the radio oscillator clock is active.

45.2.2.3.19.3 Diagram

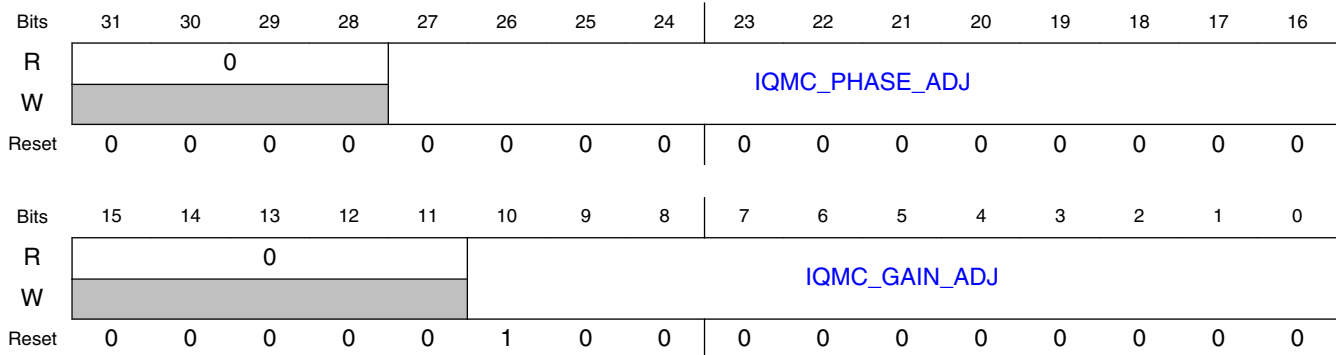

45.2.2.3.19.4 Fields

| Field | Function |
|-------------------------|--|
| 31-28 — | Reserved. |
| 27-16 IQMC_PHASE_ADJ | IQ Mismatch Correction Phase Coeff I/Q mismatch correction phase coefficient. This value is updated automatically at the end of the IQMC calibration sequence. It can also be written by software. The format is signed, with the maximum positive value 0x7ff corresponding to a phase coefficient of 0.25, and the maximum negative value 0x800 corresponding to -0.25. The reset value of 0x000 corresponds to a phase coefficient of 0. |
| 15-11 — | Reserved. |
| 10-0 IQMC_GAIN_ADJ | IQ Mismatch Correction Gain Coeff I/Q mismatch correction gain coefficient. This value is updated automatically at the end of the IQMC calibration sequence. It can also be written by software. The format is u1.10. The reset value of 0x400 corresponds to a gain coefficient of 1.0. |

45.2.2.3.20 LNA_GAIN Step Values 3..0 (LNA_GAIN_VAL_3_0)

45.2.2.3.20.1 Offset

| Register | Offset |
|------------------|-----------|
| LNA_GAIN_VAL_3_0 | 4005C050h |

45.2.2.3.20.2 Diagram

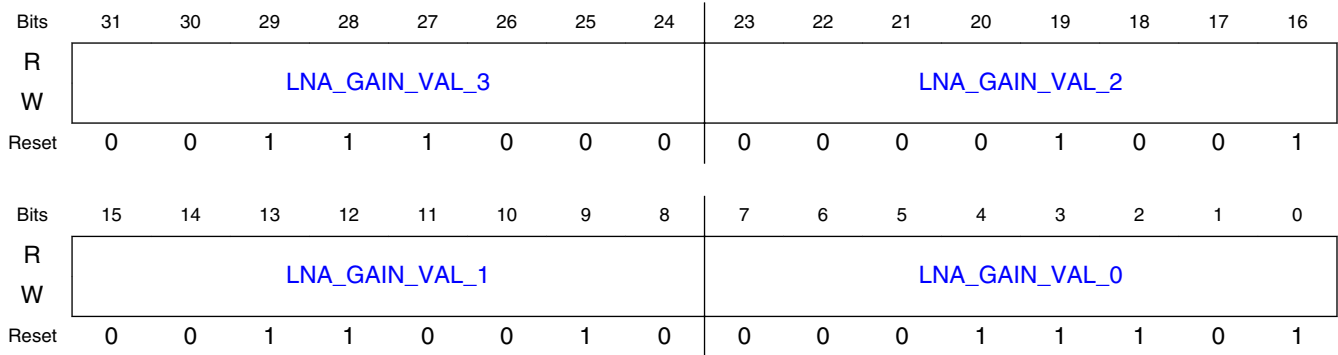

45.2.2.3.20.3 Fields

| Field | Function |
|-------------------------|---|
| 31-24 LNA_GAIN_VAL_3 | LNA_GAIN step 3 Gain for LNA gain Step 3, used in RSSI calculation. Unsigned, 4*(measured_gain_dB). |
| 23-16 LNA_GAIN_VAL_2 | LNA_GAIN step 2 Gain for LNA gain Step 2, used in RSSI calculation. Unsigned, 4*(measured_gain_dB). |
| 15-8 LNA_GAIN_VAL_1 | LNA_GAIN step 1 Gain for LNA gain Step 1, used in RSSI calculation. Unsigned, 4*(measured_gain_dB+16). |
| 7-0 LNA_GAIN_VAL_0 | LNA_GAIN step 0 Gain for LNA gain Step 0, used in RSSI calculation. Unsigned, 4*(measured_gain_dB+16). |

45.2.2.3.21 LNA_GAIN Step Values 7..4 (LNA_GAIN_VAL_7_4)

45.2.2.3.21.1 Offset

| Register | Offset |
|------------------|-----------|
| LNA_GAIN_VAL_7_4 | 4005C054h |

45.2.2.3.21.2 Diagram

| | | | | | | | | | | | | | | | | |
|-------|----------------|----|----|----|----|----|----|----|----------------|----|----|----|----|----|----|----|
| Bits | 31 | 30 | 29 | 28 | 27 | 26 | 25 | 24 | 23 | 22 | 21 | 20 | 19 | 18 | 17 | 16 |
| R | LNA_GAIN_VAL_7 | | | | | | | | LNA_GAIN_VAL_6 | | | | | | | |
| W | LNA_GAIN_VAL_7 | | | | | | | | LNA_GAIN_VAL_6 | | | | | | | |
| Reset | 1 | 0 | 0 | 0 | 1 | 0 | 1 | 1 | 0 | 1 | 1 | 1 | 0 | 1 | 0 | 0 |
| Bits | 15 | 14 | 13 | 12 | 11 | 10 | 9 | 8 | 7 | 6 | 5 | 4 | 3 | 2 | 1 | 0 |
| R | LNA_GAIN_VAL_5 | | | | | | | | LNA_GAIN_VAL_4 | | | | | | | |
| W | LNA_GAIN_VAL_5 | | | | | | | | LNA_GAIN_VAL_4 | | | | | | | |
| Reset | 0 | 1 | 0 | 1 | 1 | 1 | 0 | 1 | 0 | 1 | 0 | 0 | 1 | 1 | 1 | 1 |

45.2.2.3.21.3 Fields

| Field | Function |
|-------------------------|--|
| 31-24 LNA_GAIN_VAL_7 | LNA_GAIN step 7 Gain for LNA gain Step 7, used in RSSI calculation. Unsigned, 4*(measured_gain_dB). |
| 23-16 LNA_GAIN_VAL_6 | LNA_GAIN step 6 Gain for LNA gain Step 6, used in RSSI calculation. Unsigned, 4*(measured_gain_dB). |
| 15-8 LNA_GAIN_VAL_5 | LNA_GAIN step 5 Gain for LNA gain Step 5, used in RSSI calculation. Unsigned, 4*(measured_gain_dB). |
| 7-0 LNA_GAIN_VAL_4 | LNA_GAIN step 4 Gain for LNA gain Step 4, used in RSSI calculation. Unsigned, 4*(measured_gain_dB). |

45.2.2.3.22 LNA_GAIN Step Values 8 (LNA_GAIN_VAL_8)

45.2.2.3.22.1 Offset

| Register | Offset |
|----------------|-----------|
| LNA_GAIN_VAL_8 | 4005C058h |

Radio Register Overview

45.2.2.3.22.2 Diagram

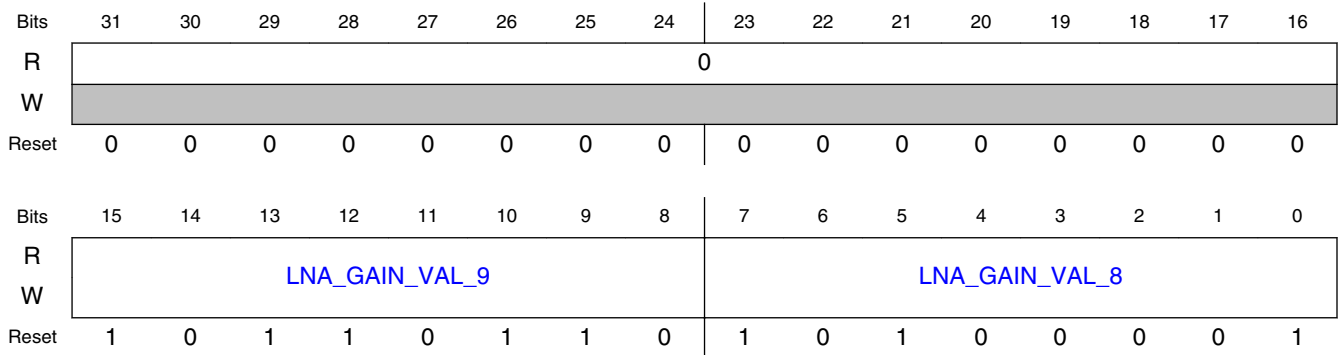

45.2.2.3.22.3 Fields

| Field | Function |
|------------------------|--|
| 31-16 — | Reserved. |
| 15-8 LNA_GAIN_VAL_9 | LNA_GAIN step 9 Gain for LNA gain Step 9, used in RSSI calculation. Unsigned, 4*(measured_gain_dB). |
| 7-0 LNA_GAIN_VAL_8 | LNA_GAIN step 8 Gain for LNA gain Step 8, used in RSSI calculation. Unsigned, 4*(measured_gain_dB). |

45.2.2.3.23 BBA Resistor Tune Values 7..0 (BBA_RES_TUNE_VAL_7_0)

45.2.2.3.23.1 Offset

| Register | Offset |
|----------------------|-----------|
| BBA_RES_TUNE_VAL_7_0 | 4005C05Ch |

45.2.2.3.23.2 Diagram

| | | | | | | | | | | | | | | | | |
|-------|--------------------|----|----|----|--------------------|----|----|----|--------------------|----|----|----|--------------------|----|----|----|
| Bits | 31 | 30 | 29 | 28 | 27 | 26 | 25 | 24 | 23 | 22 | 21 | 20 | 19 | 18 | 17 | 16 |
| R | BBA_RES_TUNE_VAL_7 | | | | BBA_RES_TUNE_VAL_6 | | | | BBA_RES_TUNE_VAL_5 | | | | BBA_RES_TUNE_VAL_4 | | | |
| W | | | | | | | | | | | | | | | | |
| Reset | 0 | 0 | 0 | 0 | 0 | 0 | 0 | 0 | 0 | 0 | 0 | 0 | 0 | 0 | 0 | 0 |
| Bits | 15 | 14 | 13 | 12 | 11 | 10 | 9 | 8 | 7 | 6 | 5 | 4 | 3 | 2 | 1 | 0 |
| R | BBA_RES_TUNE_VAL_3 | | | | BBA_RES_TUNE_VAL_2 | | | | BBA_RES_TUNE_VAL_1 | | | | BBA_RES_TUNE_VAL_0 | | | |
| W | | | | | | | | | | | | | | | | |
| Reset | 0 | 0 | 0 | 0 | 0 | 0 | 0 | 0 | 0 | 0 | 0 | 0 | 0 | 0 | 0 | 0 |

45.2.2.3.23.3 Fields

| Field | Function |
|---------------------------------|--|
| 31-28 BBA_RES_TUN E_VAL_7 | BBA Resistor Tune Step 7 Gain offset for BBA gain Step 7, used in RSSI calculation. Signed, $2*(\text{measured_gain_dB} - \text{spec_gain_dB})$. |
| 27-24 BBA_RES_TUN E_VAL_6 | BBA Resistor Tune Step 6 Gain offset for BBA gain Step 6, used in RSSI calculation. Signed, $2*(\text{measured_gain_dB} - \text{spec_gain_dB})$. |
| 23-20 BBA_RES_TUN E_VAL_5 | BBA Resistor Tune Step 5 Gain offset for BBA gain Step 5, used in RSSI calculation. Signed, $2*(\text{measured_gain_dB} - \text{spec_gain_dB})$. |
| 19-16 BBA_RES_TUN E_VAL_4 | BBA Resistor Tune Step 4 Gain offset for BBA gain Step 4, used in RSSI calculation. Signed, $2*(\text{measured_gain_dB} - \text{spec_gain_dB})$. |
| 15-12 BBA_RES_TUN E_VAL_3 | BBA Resistor Tune Step 3 Gain offset for BBA gain Step 3, used in RSSI calculation. Signed, $2*(\text{measured_gain_dB} - \text{spec_gain_dB})$. |
| 11-8 BBA_RES_TUN E_VAL_2 | BBA Resistor Tune Step 2 Gain offset for BBA gain Step 2, used in RSSI calculation. Signed, $2*(\text{measured_gain_dB} - \text{spec_gain_dB})$. |
| 7-4 BBA_RES_TUN E_VAL_1 | BBA Resistor Tune Step 1 Gain offset for BBA gain Step 1, used in RSSI calculation. Signed, $2*(\text{measured_gain_dB} - \text{spec_gain_dB})$. |
| 3-0 BBA_RES_TUN E_VAL_0 | BBA Resistor Tune Step 0 Gain offset for BBA gain Step 0, used in RSSI calculation. Signed, $2*(\text{measured_gain_dB} - \text{spec_gain_dB})$. |

45.2.2.3.24 BBA Resistor Tune Values 10..8 (BBA_RES_TUNE_VAL_10_8)

45.2.2.3.24.1 Offset

| Register | Offset |
|-----------------------|-----------|
| BBA_RES_TUNE_VAL_10_8 | 4005C060h |

45.2.2.3.24.2 Diagram

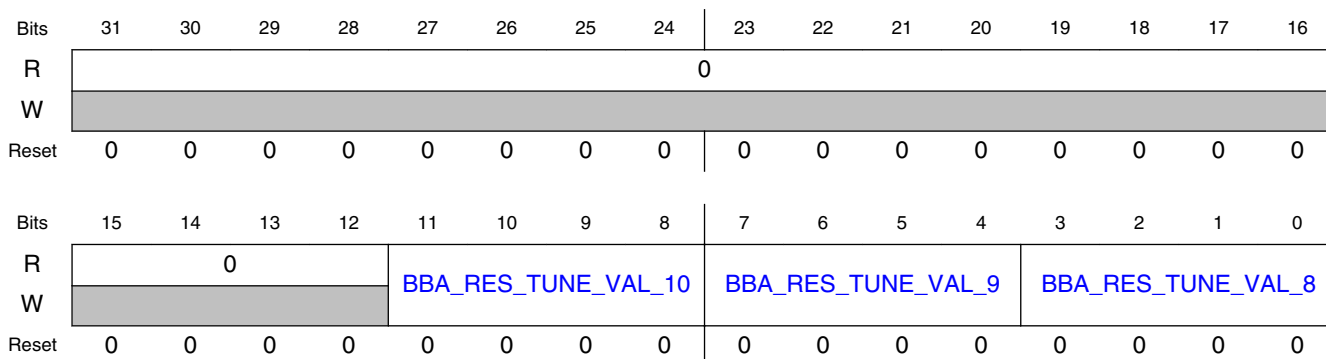

45.2.2.3.24.3 Fields

| Field | Function |
|---------------------------------|---|
| 31-12 Reserved | Reserved. |
| 11-8 BBA_RES_TUN E_VAL_10 | BBA Resistor Tune Step 10 Gain offset for BBA gain Step 10, used in RSSI calculation. Signed, 2*(measured_gain_dB - spec_gain_dB). |
| 7-4 BBA_RES_TUN E_VAL_9 | BBA Resistor Tune Step 9 Gain offset for BBA gain Step 9, used in RSSI calculation. Signed, 2*(measured_gain_dB - spec_gain_dB). |
| 3-0 BBA_RES_TUN E_VAL_8 | BBA Resistor Tune Step 8 Gain offset for BBA gain Step 8, used in RSSI calculation. Signed, 2*(measured_gain_dB - spec_gain_dB). |

45.2.2.3.25 LNA Linear Gain Values 2..0 (LNA_GAIN_LIN_VAL_2_0)

45.2.2.3.25.1 Offset

| Register | Offset |
|----------------------|-----------|
| LNA_GAIN_LIN_VAL_2_0 | 4005C064h |

45.2.2.3.25.2 Diagram



45.2.2.3.25.3 Fields

| Field | Function |
|-----------------------------|--|
| 31-30 — | Reserved. |
| 29-20 LNA_GAIN_LIN_VAL_2 | LNA Linear Gain Step 2 LNA linear gain value for index 2, e.g. nominal value is $10^{(2.2/20)}$. Stored with 2 fractional bits, e.g. $\text{round}([10^{(2.2/20)}] * 2^2) = 5\text{decimal}$. Format (8.2). |
| 19-10 LNA_GAIN_LIN_VAL_1 | LNA Linear Gain Step 1 LNA linear gain value for index 1, e.g. nominal value is $10^{(-3.5/20)}$. Stored with 2 fractional bits, e.g. $\text{round}([10^{(-3.5/20)}] * 2^2) = 3\text{decimal}$. Format (8.2). |
| 9-0 LNA_GAIN_LIN_VAL_0 | LNA Linear Gain Step 0 LNA linear gain value for index 0, e.g. nominal value is $10^{(-8.6/20)}$. Stored with 2 fractional bits, e.g. $\text{round}([10^{(-8.6/20)}] * 2^2) = 1\text{decimal}$. Format (8.2). |

45.2.2.3.26 LNA Linear Gain Values 5..3 (LNA_GAIN_LIN_VAL_5_3)

45.2.2.3.26.1 Offset

| Register | Offset |
|----------------------|-----------|
| LNA_GAIN_LIN_VAL_5_3 | 4005C068h |

45.2.2.3.26.2 Diagram

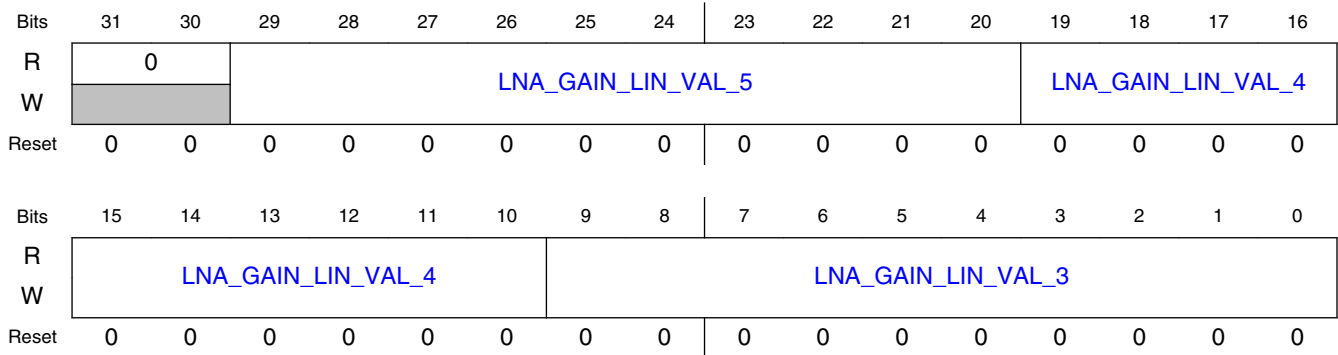

45.2.2.3.26.3 Fields

| Field | Function |
|-----------------------------|--|
| 31-30 — | Reserved. |
| 29-20 LNA_GAIN_LIN_VAL_5 | LNA Linear Gain Step 5 LNA linear gain value for index 5, e.g. nominal value is $10^{(22.7/20)}$. Stored with 2 fractional bits, e.g. $\text{round}([10^{(22.7/20)}] * 2^2) = 55$ decimal. Format (8.2). |
| 19-10 LNA_GAIN_LIN_VAL_4 | LNA Linear Gain Step 4 LNA linear gain value for index 4, e.g. nominal value is $10^{(19.8/20)}$. Stored with 2 fractional bits, e.g. $\text{round}([10^{(19.8/20)}] * 2^2) = 39$ decimal. Format (8.2). |
| 9-0 LNA_GAIN_LIN_VAL_3 | LNA Linear Gain Step 3 LNA linear gain value for index 3, e.g. nominal value is $10^{(13.9/20)}$. Stored with 2 fractional bits, e.g. $\text{round}([10^{(13.9/20)}] * 2^2) = 20$ decimal. Format (8.2). |

45.2.2.3.27 LNA Linear Gain Values 8..6 (LNA_GAIN_LIN_VAL_8_6)

45.2.2.3.27.1 Offset

| Register | Offset |
|----------------------|-----------|
| LNA_GAIN_LIN_VAL_8_6 | 4005C06Ch |

45.2.2.3.27.2 Diagram

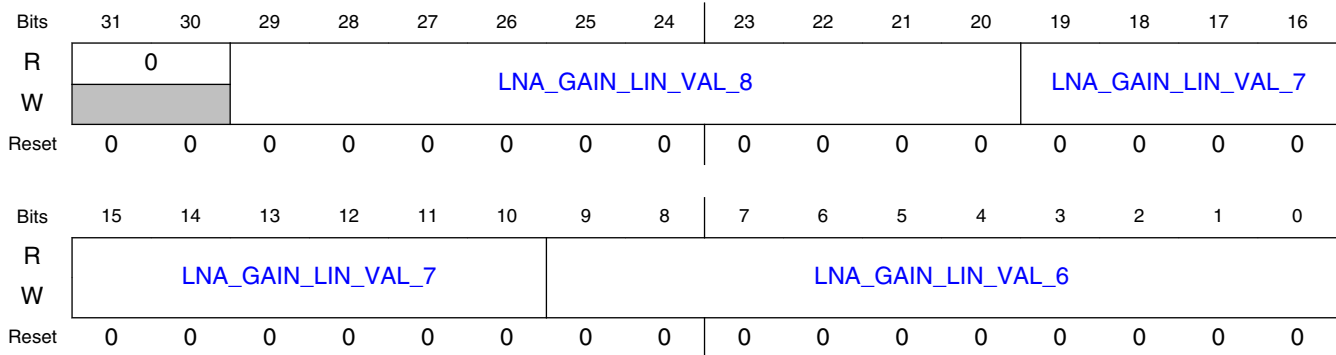

45.2.2.3.27.3 Fields

| Field | Function |
|-----------------------------|---|
| 31-30 — | Reserved. |
| 29-20 LNA_GAIN_LIN_VAL_8 | LNA Linear Gain Step 8 LNA linear gain value for index 8, e.g. nominal value is $10^{(39.9/20)}$. Stored with 2 fractional bits, e.g. $\text{round}([10^{(39.9/20)}] * 2^2) = 396$ decimal. Format (8.2). |
| 19-10 LNA_GAIN_LIN_VAL_7 | LNA Linear Gain Step 7 LNA linear gain value for index 7, e.g. nominal value is $10^{(34.4/20)}$. Stored with 2 fractional bits, e.g. $\text{round}([10^{(34.4/20)}] * 2^2) = 210$ decimal. Format (8.2). |
| 9-0 LNA_GAIN_LIN_VAL_6 | LNA Linear Gain Step 6 LNA linear gain value for index 6, e.g. nominal value is $10^{(28.6/20)}$. Stored with 2 fractional bits, e.g. $\text{round}([10^{(28.6/20)}] * 2^2) = 108$ decimal. Format (8.2). |

45.2.2.3.28 LNA Linear Gain Values 9 (LNA_GAIN_LIN_VAL_9)

45.2.2.3.28.1 Offset

| Register | Offset |
|--------------------|-----------|
| LNA_GAIN_LIN_VAL_9 | 4005C070h |

Radio Register Overview

45.2.2.3.28.2 Diagram

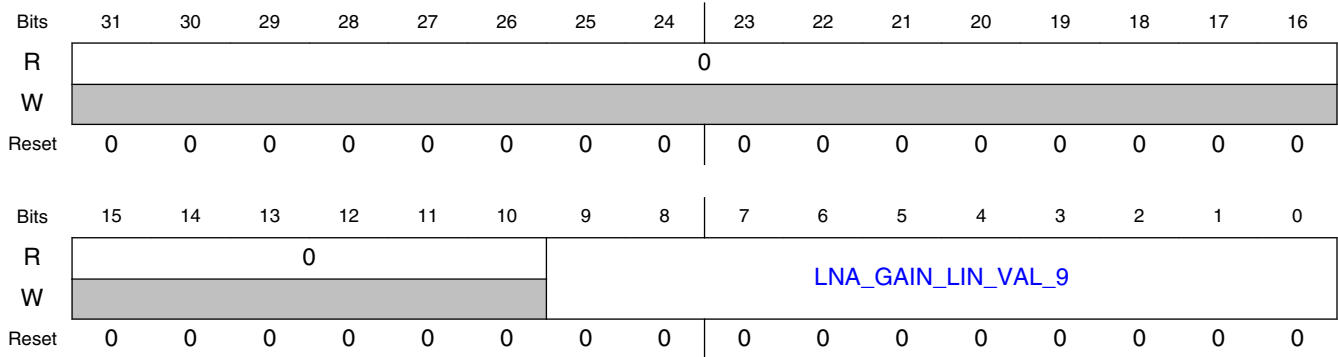

45.2.2.3.28.3 Fields

| Field | Function |
|---------------------------|---|
| 31-10 Reserved | Reserved. |
| 9-0 LNA_GAIN_LIN_VAL_9 | LNA Linear Gain Step 9 LNA linear gain value for index 9, e.g. nominal value is $10^{(45.4/20)}$. Stored with 2 fractional bits, e.g. $\text{round}([10^{(45.4/20)}] * 2^2) = 744$ decimal. Format (8.2). |

45.2.2.3.29 BBA Resistor Tune Values 3..0 (BBA_RES_TUNE_LIN_VAL_3_0)

45.2.2.3.29.1 Offset

| Register | Offset |
|--------------------------|-----------|
| BBA_RES_TUNE_LIN_VAL_3_0 | 4005C074h |

45.2.2.3.29.2 Diagram

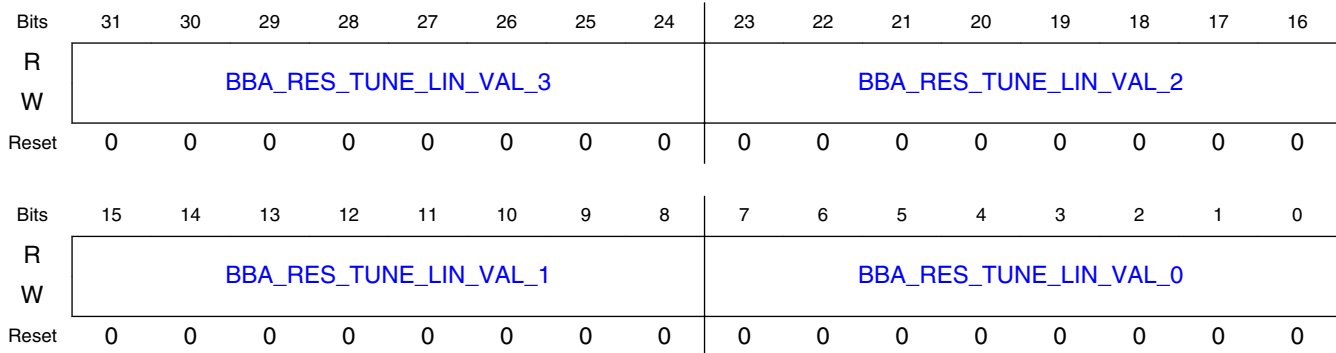

45.2.2.3.29.3 Fields

| Field | Function |
|-------------------------------------|---|
| 31-24 BBA_RES_TUN E_LIN_VAL_3 | BBA Resistor Tune Linear Gain Step 3 BBA linear gain value for index 3 (format: u5.3). Nominal value is $10^{(9/20)}$. Stored with 3 fractional bits, e.g. $\text{round}([10^{(9/20)}] * 2^3) = 23\text{decimal}$ |
| 23-16 BBA_RES_TUN E_LIN_VAL_2 | BBA Resistor Tune Linear Gain Step 2 BBA linear gain value for index 2 (format: u5.3). Nominal value is $10^{(6/20)}$. Stored with 3 fractional bits, e.g. $\text{round}([10^{(6/20)}] * 2^3) = 16\text{decimal}$ |
| 15-8 BBA_RES_TUN E_LIN_VAL_1 | BBA Resistor Tune Linear Gain Step 1 BBA linear gain value for index 1 (format: u5.3). Nominal value is $10^{(3/20)}$. Stored with 3 fractional bits, e.g. $\text{round}([10^{(3/20)}] * 2^3) = 11\text{decimal}$ |
| 7-0 BBA_RES_TUN E_LIN_VAL_0 | BBA Resistor Tune Linear Gain Step 0 BBA linear gain value for index 0 (format: u5.3). Nominal value is $10^{(0/20)}$. Stored with 3 fractional bits, e.g. $\text{round}([10^{(0/20)}] * 2^3) = 8\text{decimal}$ |

45.2.2.3.30 BBA Resistor Tune Values 7..4 (BBA_RES_TUNE_LIN_VAL_7_4)

45.2.2.3.30.1 Offset

| Register | Offset |
|--------------------------|-----------|
| BBA_RES_TUNE_LIN_VAL_7_4 | 4005C078h |

45.2.2.3.30.2 Diagram

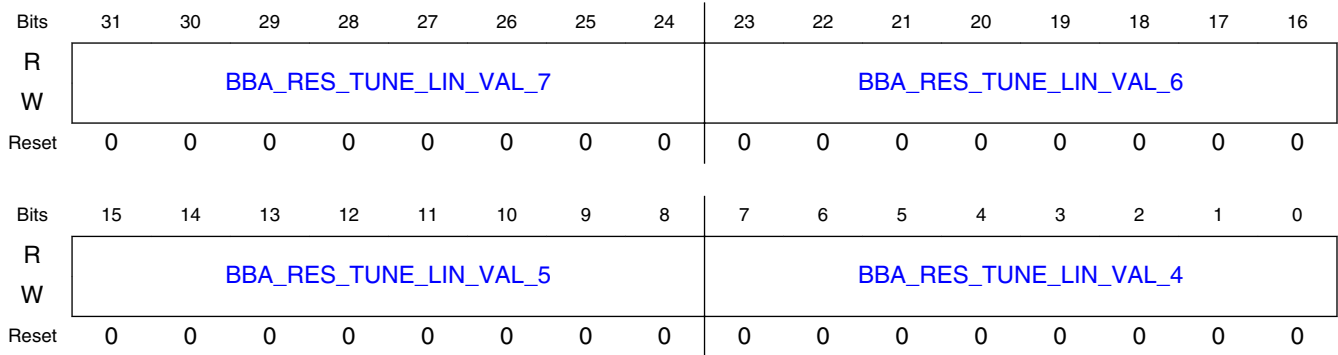

45.2.2.3.30.3 Fields

| Field | Function |
|-------------------------------------|---|
| 31-24 BBA_RES_TUN E_LIN_VAL_7 | BBA Resistor Tune Linear Gain Step 7 BBA linear gain value for index 7 (format: u6.2). Nominal value is $10^{(21/20)}$. Stored with 2 fractional bits, e.g. $\text{round}([10^{(21/20)}] * 2^2) = 45$ decimal |
| 23-16 BBA_RES_TUN E_LIN_VAL_6 | BBA Resistor Tune Linear Gain Step 6 BBA linear gain value for index 6 (format: u5.3). Nominal value is $10^{(18/20)}$. Stored with 3 fractional bits, e.g. $\text{round}([10^{(18/20)}] * 2^3) = 64$ decimal |
| 15-8 BBA_RES_TUN E_LIN_VAL_5 | BBA Resistor Tune Linear Gain Step 5 BBA linear gain value for index 5 (format: u5.3). Nominal value is $10^{(15/20)}$. Stored with 3 fractional bits, e.g. $\text{round}([10^{(15/20)}] * 2^3) = 45$ decimal |
| 7-0 BBA_RES_TUN E_LIN_VAL_4 | BBA Resistor Tune Linear Gain Step 4 BBA linear gain value for index 4 (format: u5.3). Nominal value is $10^{(12/20)}$. Stored with 3 fractional bits, e.g. $\text{round}([10^{(12/20)}] * 2^3) = 32$ decimal |

45.2.2.3.31 BBA Resistor Tune Values 10..8 (BBA_RES_TUNE_LIN_VAL_10_8)

45.2.2.3.31.1 Offset

| Register | Offset |
|---------------------------|-----------|
| BBA_RES_TUNE_LIN_VAL_10_8 | 4005C07Ch |

45.2.2.3.31.2 Diagram

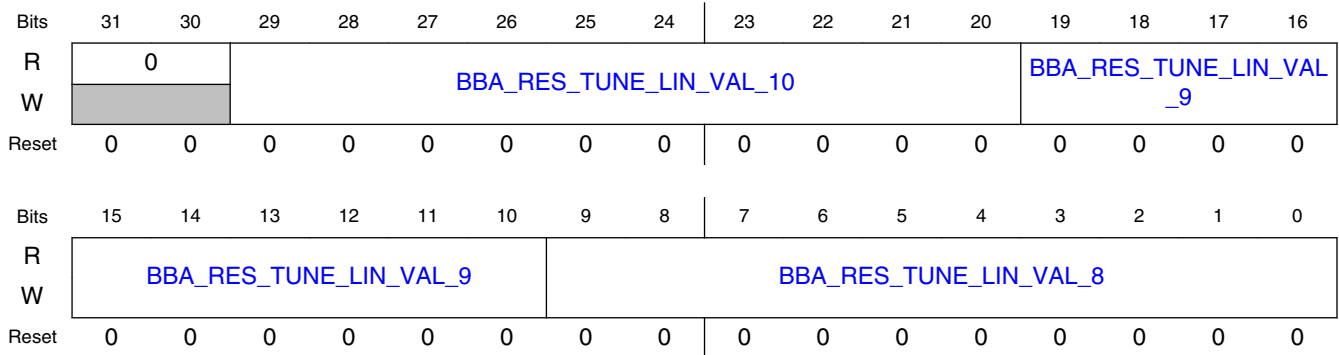

45.2.2.3.31.3 Fields

| Field | Function |
|----------------------------------|--|
| 31-30 — | Reserved. |
| 29-20 BBA_RES_TUNE_LIN_VAL_10 | BBA Resistor Tune Linear Gain Step 10 BBA linear gain value for index 10 (format: u7.3). Nominal value is $10^{(30/20)}$. Stored with 3 fractional bits, e.g. $\text{round}([10^{(30/20)}] * 2^3) = 253$ decimal |
| 19-10 BBA_RES_TUNE_LIN_VAL_9 | BBA Resistor Tune Linear Gain Step 9 BBA linear gain value for index 9 (format: u7.3). Nominal value is $10^{(27/20)}$. Stored with 3 fractional bits, e.g. $\text{round}([10^{(27/20)}] * 2^3) = 179$ decimal |
| 9-0 BBA_RES_TUNE_LIN_VAL_8 | BBA Resistor Tune Linear Gain Step 8 BBA linear gain value for index 8 (format: u7.3). Nominal value is $10^{(24/20)}$. Stored with 3 fractional bits, e.g. $\text{round}([10^{(24/20)}] * 2^3) = 127$ decimal |

45.2.2.3.32 AGC Gain Tables Step 03..00 (AGC_GAIN_TBL_03_00)

45.2.2.3.32.1 Offset

| Register | Offset |
|--------------------|-----------|
| AGC_GAIN_TBL_03_00 | 4005C080h |

45.2.2.3.32.2 Diagram

| | | | | | | | | | | | | | | | | |
|-------|-------------|----|----|----|-------------|----|----|----|-------------|----|----|----|-------------|----|----|----|
| Bits | 31 | 30 | 29 | 28 | 27 | 26 | 25 | 24 | 23 | 22 | 21 | 20 | 19 | 18 | 17 | 16 |
| R | LNA_GAIN_03 | | | | BBA_GAIN_03 | | | | LNA_GAIN_02 | | | | BBA_GAIN_02 | | | |
| W | | | | | | | | | | | | | | | | |
| Reset | 0 | 0 | 0 | 0 | 0 | 0 | 0 | 0 | 0 | 0 | 0 | 0 | 0 | 0 | 0 | 0 |
| Bits | 15 | 14 | 13 | 12 | 11 | 10 | 9 | 8 | 7 | 6 | 5 | 4 | 3 | 2 | 1 | 0 |
| R | LNA_GAIN_01 | | | | BBA_GAIN_01 | | | | LNA_GAIN_00 | | | | BBA_GAIN_00 | | | |
| W | | | | | | | | | | | | | | | | |
| Reset | 0 | 0 | 0 | 0 | 0 | 0 | 0 | 0 | 0 | 0 | 0 | 0 | 0 | 0 | 0 | 0 |

45.2.2.3.32.3 Fields

| Field | Function |
|----------------------|--|
| 31-28 LNA_GAIN_03 | LNA Gain 03 LNA GAIN. See Table 45-17 for the mapping of LNA gain indexes to gain values. |
| 27-24 BBA_GAIN_03 | BBA Gain 03 BBA GAIN 0=0 dB, 1=3 dB, 2=6 dB ... A=30 dB. |
| 23-20 LNA_GAIN_02 | LNA Gain 02 LNA GAIN. See Table 45-17 for the mapping of LNA gain indexes to gain values. |
| 19-16 BBA_GAIN_02 | BBA Gain 02 BBA GAIN 0=0 dB, 1=3 dB, 2=6 dB ... A=30 dB. |
| 15-12 LNA_GAIN_01 | LNA Gain 01 LNA GAIN. See Table 45-17 for the mapping of LNA gain indexes to gain values. |
| 11-8 BBA_GAIN_01 | BBA Gain 01 BBA GAIN 0=0 dB, 1=3 dB, 2=6 dB ... A=30 dB. |
| 7-4 LNA_GAIN_00 | LNA Gain 00 LNA GAIN. See Table 45-17 for the mapping of LNA gain indexes to gain values. |
| 3-0 BBA_GAIN_00 | BBA Gain 00 BBA GAIN. |

45.2.2.3.33 AGC Gain Tables Step 07..04 (AGC_GAIN_TBL_07_04)

45.2.2.3.33.1 Offset

| Register | Offset |
|--------------------|-----------|
| AGC_GAIN_TBL_07_04 | 4005C084h |

45.2.2.3.33.2 Diagram

| | | | | | | | | | | | | | | | | |
|-------|-------------|----|----|----|-------------|----|----|----|-------------|----|----|----|-------------|----|----|----|
| Bits | 31 | 30 | 29 | 28 | 27 | 26 | 25 | 24 | 23 | 22 | 21 | 20 | 19 | 18 | 17 | 16 |
| R | LNA_GAIN_07 | | | | BBA_GAIN_07 | | | | LNA_GAIN_06 | | | | BBA_GAIN_06 | | | |
| W | LNA_GAIN_07 | | | | BBA_GAIN_07 | | | | LNA_GAIN_06 | | | | BBA_GAIN_06 | | | |
| Reset | 0 | 0 | 0 | 0 | 0 | 0 | 0 | 0 | 0 | 0 | 0 | 0 | 0 | 0 | 0 | 0 |
| Bits | 15 | 14 | 13 | 12 | 11 | 10 | 9 | 8 | 7 | 6 | 5 | 4 | 3 | 2 | 1 | 0 |
| R | LNA_GAIN_05 | | | | BBA_GAIN_05 | | | | LNA_GAIN_04 | | | | BBA_GAIN_04 | | | |
| W | LNA_GAIN_05 | | | | BBA_GAIN_05 | | | | LNA_GAIN_04 | | | | BBA_GAIN_04 | | | |
| Reset | 0 | 0 | 0 | 0 | 0 | 0 | 0 | 0 | 0 | 0 | 0 | 0 | 0 | 0 | 0 | 0 |

45.2.2.3.33.3 Fields

| Field | Function |
|----------------------|--|
| 31-28 LNA_GAIN_07 | LNA Gain 07 LNA GAIN. See Table 45-17 for the mapping of LNA gain indexes to gain values. |
| 27-24 BBA_GAIN_07 | BBA Gain 07 BBA GAIN 0=0 dB, 1=3 dB, 2=6 dB ... A=30 dB. |
| 23-20 LNA_GAIN_06 | LNA Gain 06 LNA GAIN. See Table 45-17 for the mapping of LNA gain indexes to gain values. |
| 19-16 BBA_GAIN_06 | BBA Gain 06 BBA GAIN 0=0 dB, 1=3 dB, 2=6 dB ... A=30 dB. |
| 15-12 LNA_GAIN_05 | LNA Gain 05 LNA GAIN. See Table 45-17 for the mapping of LNA gain indexes to gain values. |
| 11-8 BBA_GAIN_05 | BBA Gain 05 BBA GAIN 0=0 dB, 1=3 dB, 2=6 dB ... A=30 dB. |
| 7-4 LNA_GAIN_04 | LNA Gain 04 LNA GAIN. See Table 45-17 for the mapping of LNA gain indexes to gain values. |
| 3-0 BBA_GAIN_04 | BBA Gain 04 BBA GAIN 0=0 dB, 1=3 dB, 2=6 dB ... A=30 dB. |

45.2.2.3.34 AGC Gain Tables Step 11..08 (AGC_GAIN_TBL_11_08)

45.2.2.3.34.1 Offset

| Register | Offset |
|--------------------|-----------|
| AGC_GAIN_TBL_11_08 | 4005C088h |

45.2.2.3.34.2 Diagram

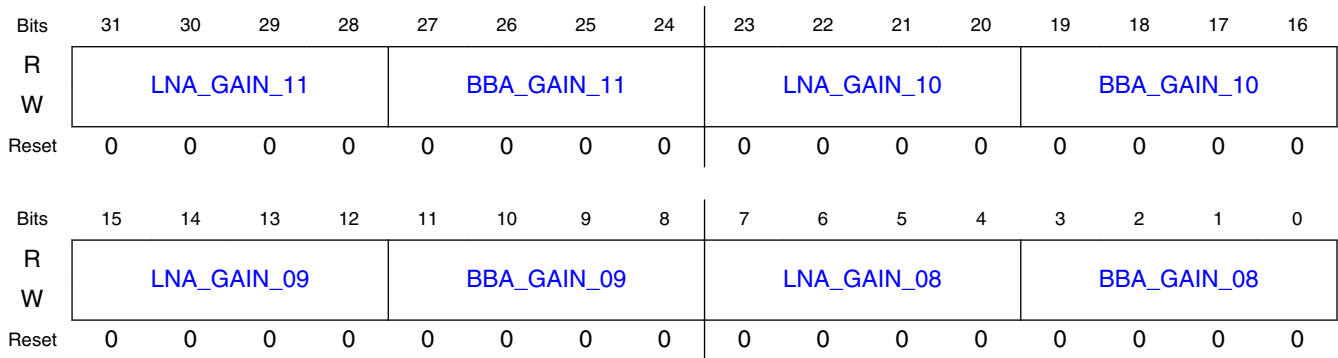

45.2.2.3.34.3 Fields

| Field | Function |
|----------------------|--|
| 31-28 LNA_GAIN_11 | LNA Gain 11 LNA GAIN. See Table 45-17 for the mapping of LNA gain indexes to gain values. |
| 27-24 BBA_GAIN_11 | BBA Gain 11 BBA GAIN 0=0 dB, 1=3 dB, 2=6 dB ... A=30 dB. |
| 23-20 LNA_GAIN_10 | LNA Gain 10 LNA GAIN. See Table 45-17 for the mapping of LNA gain indexes to gain values. |
| 19-16 BBA_GAIN_10 | BBA Gain 10 BBA GAIN 0=0 dB, 1=3 dB, 2=6 dB ... A=30 dB. |
| 15-12 LNA_GAIN_09 | LNA Gain 09 LNA GAIN. See Table 45-17 for the mapping of LNA gain indexes to gain values. |
| 11-8 BBA_GAIN_09 | BBA Gain 09 BBA GAIN 0=0 dB, 1=3 dB, 2=6 dB ... A=30 dB. |
| 7-4 LNA_GAIN_08 | LNA Gain 08 LNA GAIN. See Table 45-17 for the mapping of LNA gain indexes to gain values. |
| 3-0 BBA_GAIN_08 | BBA Gain 08 BBA GAIN 0=0 dB, 1=3 dB, 2=6 dB ... A=30 dB. |

45.2.2.3.35 AGC Gain Tables Step 15..12 (AGC_GAIN_TBL_15_12)

45.2.2.3.35.1 Offset

| Register | Offset |
|--------------------|-----------|
| AGC_GAIN_TBL_15_12 | 4005C08Ch |

45.2.2.3.35.2 Diagram

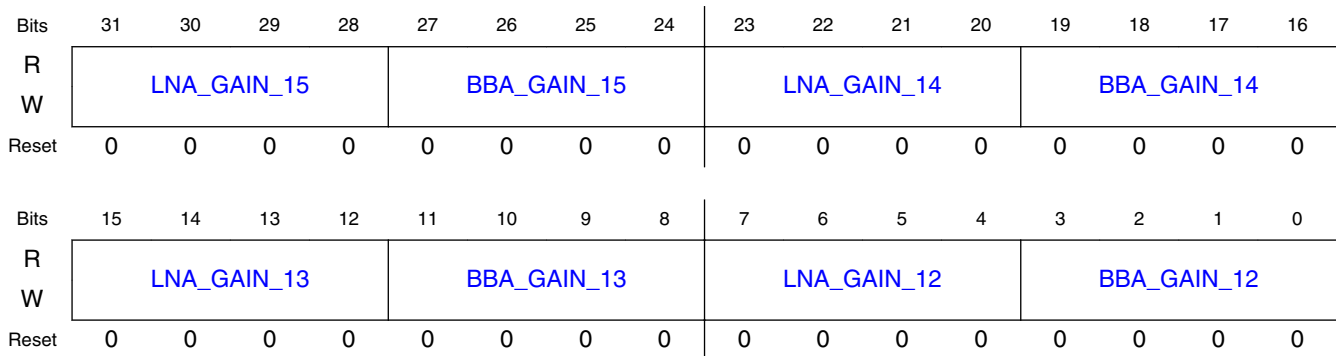

45.2.2.3.35.3 Fields

| Field | Function |
|----------------------|--|
| 31-28 LNA_GAIN_15 | LNA Gain 15 LNA GAIN. See Table 45-17 for the mapping of LNA gain indexes to gain values. |
| 27-24 BBA_GAIN_15 | BBA Gain 15 BBA GAIN 0=0 dB, 1=3 dB, 2=6 dB ... A=30 dB. |
| 23-20 LNA_GAIN_14 | LNA Gain 14 LNA GAIN. See Table 45-17 for the mapping of LNA gain indexes to gain values. |
| 19-16 BBA_GAIN_14 | BBA Gain 14 BBA GAIN 0=0 dB, 1=3 dB, 2=6 dB ... A=30 dB. |
| 15-12 LNA_GAIN_13 | LNA Gain 13 LNA GAIN. See Table 45-17 for the mapping of LNA gain indexes to gain values. |
| 11-8 BBA_GAIN_13 | BBA Gain 13 BBA GAIN 0=0 dB, 1=3 dB, 2=6 dB ... A=30 dB. |
| 7-4 LNA_GAIN_12 | LNA Gain 12 LNA GAIN. See Table 45-17 for the mapping of LNA gain indexes to gain values. |
| 3-0 BBA_GAIN_12 | BBA Gain 12 BBA GAIN 0=0 dB, 1=3 dB, 2=6 dB ... A=30 dB. |

45.2.2.3.36 AGC Gain Tables Step 19..16 (AGC_GAIN_TBL_19_16)

45.2.2.3.36.1 Offset

| Register | Offset |
|--------------------|-----------|
| AGC_GAIN_TBL_19_16 | 4005C090h |

45.2.2.3.36.2 Diagram

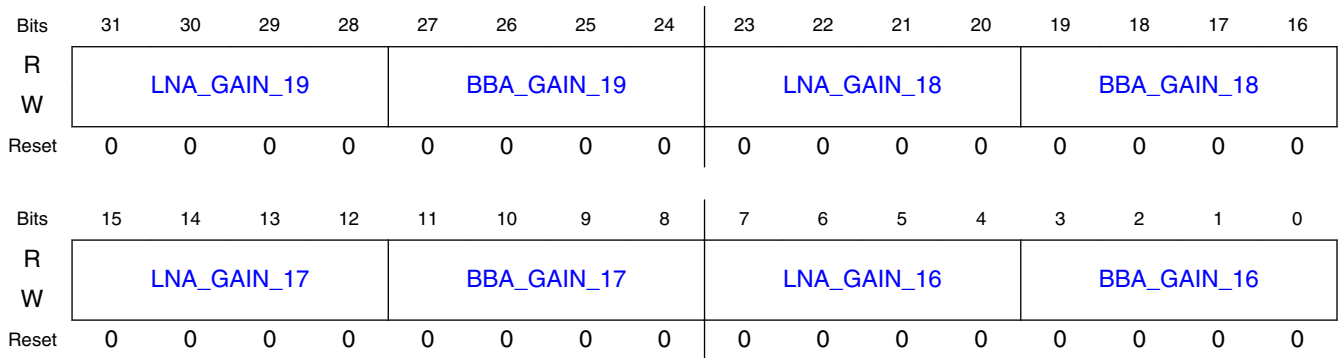

45.2.2.3.36.3 Fields

| Field | Function |
|----------------------|--|
| 31-28 LNA_GAIN_19 | LNA Gain 19 LNA GAIN. See Table 45-17 for the mapping of LNA gain indexes to gain values. |
| 27-24 BBA_GAIN_19 | BBA Gain 193 BBA GAIN 0=0 dB, 1=3 dB, 2=6 dB ... A=30 dB. |
| 23-20 LNA_GAIN_18 | LNA Gain 18 LNA GAIN. See Table 45-17 for the mapping of LNA gain indexes to gain values. |
| 19-16 BBA_GAIN_18 | BBA Gain 18 BBA GAIN 0=0 dB, 1=3 dB, 2=6 dB ... A=30 dB. |
| 15-12 LNA_GAIN_17 | LNA Gain 17 LNA GAIN. See Table 45-17 for the mapping of LNA gain indexes to gain values. |
| 11-8 BBA_GAIN_17 | BBA Gain 17 BBA GAIN 0=0 dB, 1=3 dB, 2=6 dB ... A=30 dB. |
| 7-4 LNA_GAIN_16 | LNA Gain 16 LNA GAIN. See Table 45-17 for the mapping of LNA gain indexes to gain values. |
| 3-0 BBA_GAIN_16 | BBA Gain 16 BBA GAIN 0=0 dB, 1=3 dB, 2=6 dB ... A=30 dB. |

45.2.2.3.37 AGC Gain Tables Step 23..20 (AGC_GAIN_TBL_23_20)

45.2.2.3.37.1 Offset

| Register | Offset |
|--------------------|-----------|
| AGC_GAIN_TBL_23_20 | 4005C094h |

45.2.2.3.37.2 Diagram

| | | | | | | | | | | | | | | | | |
|-------|-------------|----|----|----|-------------|----|----|----|-------------|----|----|----|-------------|----|----|----|
| Bits | 31 | 30 | 29 | 28 | 27 | 26 | 25 | 24 | 23 | 22 | 21 | 20 | 19 | 18 | 17 | 16 |
| R | LNA_GAIN_23 | | | | BBA_GAIN_23 | | | | LNA_GAIN_22 | | | | BBA_GAIN_22 | | | |
| W | LNA_GAIN_23 | | | | BBA_GAIN_23 | | | | LNA_GAIN_22 | | | | BBA_GAIN_22 | | | |
| Reset | 0 | 0 | 0 | 0 | 0 | 0 | 0 | 0 | 0 | 0 | 0 | 0 | 0 | 0 | 0 | 0 |
| Bits | 15 | 14 | 13 | 12 | 11 | 10 | 9 | 8 | 7 | 6 | 5 | 4 | 3 | 2 | 1 | 0 |
| R | LNA_GAIN_21 | | | | BBA_GAIN_21 | | | | LNA_GAIN_20 | | | | BBA_GAIN_20 | | | |
| W | LNA_GAIN_21 | | | | BBA_GAIN_21 | | | | LNA_GAIN_20 | | | | BBA_GAIN_20 | | | |
| Reset | 0 | 0 | 0 | 0 | 0 | 0 | 0 | 0 | 0 | 0 | 0 | 0 | 0 | 0 | 0 | 0 |

45.2.2.3.37.3 Fields

| Field | Function |
|----------------------|--|
| 31-28 LNA_GAIN_23 | LNA Gain 23 LNA GAIN. See Table 45-17 for the mapping of LNA gain indexes to gain values. |
| 27-24 BBA_GAIN_23 | BBA Gain 23 BBA GAIN 0=0 dB, 1=3 dB, 2=6 dB ... A=30 dB. |
| 23-20 LNA_GAIN_22 | LNA Gain 22 LNA GAIN. See Table 45-17 for the mapping of LNA gain indexes to gain values. |
| 19-16 BBA_GAIN_22 | BBA Gain 22 BBA GAIN 0=0 dB, 1=3 dB, 2=6 dB ... A=30 dB. |
| 15-12 LNA_GAIN_21 | LNA Gain 21 LNA GAIN. See Table 45-17 for the mapping of LNA gain indexes to gain values. |
| 11-8 BBA_GAIN_21 | BBA Gain 21 BBA GAIN 0=0 dB, 1=3 dB, 2=6 dB ... A=30 dB. |
| 7-4 LNA_GAIN_20 | LNA Gain 20 LNA GAIN. See Table 45-17 for the mapping of LNA gain indexes to gain values. |
| 3-0 BBA_GAIN_20 | BBA Gain 20 BBA GAIN 0=0 dB, 1=3 dB, 2=6 dB ... A=30 dB. |

45.2.2.3.38 AGC Gain Tables Step 26..24 (AGC_GAIN_TBL_26_24)

45.2.2.3.38.1 Offset

| Register | Offset |
|--------------------|-----------|
| AGC_GAIN_TBL_26_24 | 4005C098h |

45.2.2.3.38.2 Diagram

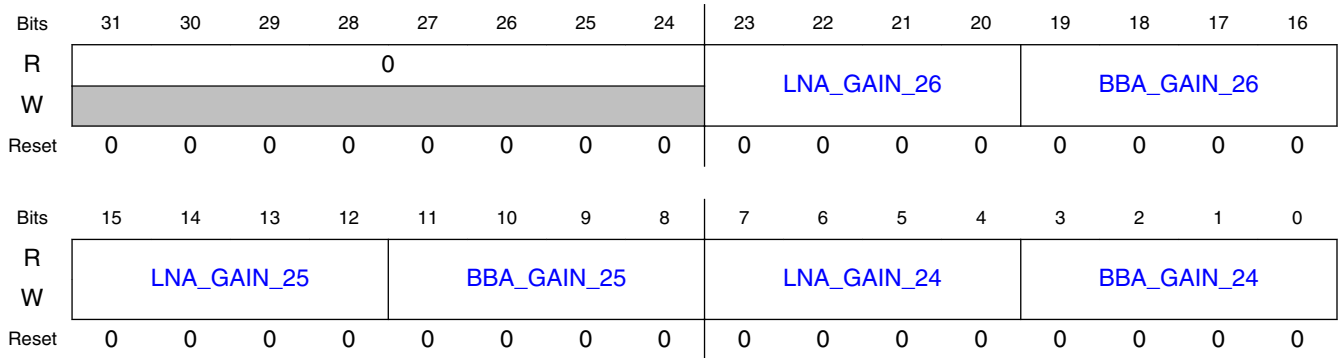

45.2.2.3.38.3 Fields

| Field | Function |
|----------------------|--|
| 31-24 — | Reserved. |
| 23-20 LNA_GAIN_26 | LNA Gain 26 LNA GAIN. See Table 45-17 for the mapping of LNA gain indexes to gain values. |
| 19-16 BBA_GAIN_26 | BBA Gain 26 BBA GAIN 0=0 dB, 1=3 dB, 2=6 dB ... A=30 dB. |
| 15-12 LNA_GAIN_25 | LNA Gain 25 LNA GAIN. See Table 45-17 for the mapping of LNA gain indexes to gain values. |
| 11-8 BBA_GAIN_25 | BBA Gain 25 BBA GAIN 0=0 dB, 1=3 dB, 2=6 dB ... A=30 dB. |
| 7-4 LNA_GAIN_24 | LNA Gain 24 LNA GAIN. See Table 45-17 for the mapping of LNA gain indexes to gain values. |
| 3-0 BBA_GAIN_24 | BBA Gain 24 BBA GAIN 0=0 dB, 1=3 dB, 2=6 dB ... A=30 dB. |

45.2.2.3.39 DCOC Offset (DCOC_OFFSET_a)

45.2.2.3.39.1 Offset

For a = 0 to 26:

| Register | Offset |
|---------------|----------------------|
| DCOC_OFFSET_a | 4005C0A0h + (a × 4h) |

45.2.2.3.39.2 Function

DCOC Offset Registers. These registers can only be accessed when the radio oscillator clock is active.

45.2.2.3.39.3 Diagram

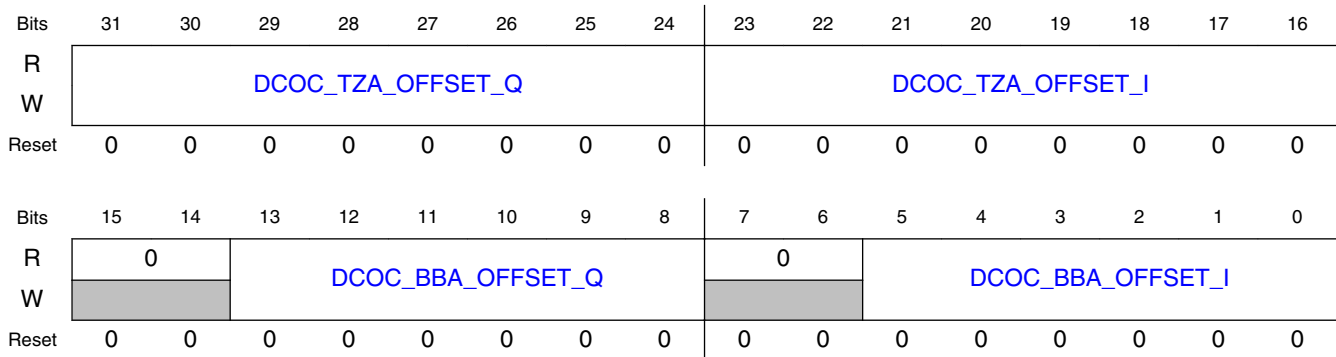

45.2.2.3.39.4 Fields

| Field | Function |
|--------------------------------|---|
| 31-24 DCOC_TZA_OF FSET_Q | DCOC TZA Q-channel offset DCOC TZA Q-channel offset. When RX_DCOC_CAL_EN=1, this table is generated by the DCOC during calibration. When RX_DCOC_CAL_EN=0, this table may optionally be written by software. |
| 23-16 DCOC_TZA_OF FSET_I | DCOC TZA I-channel offset DCOC TZA I-channel offset. When RX_DCOC_CAL_EN=1, this table is generated by the DCOC during calibration. When RX_DCOC_CAL_EN=0, this table may optionally be written by software. |
| 15-14 — | Reserved. |
| 13-8 DCOC_BBA_OF FSET_Q | DCOC BBA Q-channel offset DCOC BBA Q-channel offset. When RX_DCOC_CAL_EN=1, this table is generated by the DCOC during calibration. When RX_DCOC_CAL_EN=0, this table may optionally be written by software. |
| 7-6 — | Reserved. |
| 5-0 DCOC_BBA_OF FSET_I | DCOC BBA I-channel offset DCOC BBA I-channel offset. When RX_DCOC_CAL_EN=1, this table is generated by the DCOC during calibration. When RX_DCOC_CAL_EN=0, this table may optionally be written by software. |

45.2.2.3.40 DCOC BBA DAC Step (DCOC_BBA_STEP)

45.2.2.3.40.1 Offset

| Register | Offset |
|---------------|-----------|
| DCOC_BBA_STEP | 4005C10Ch |

45.2.2.3.40.2 Diagram

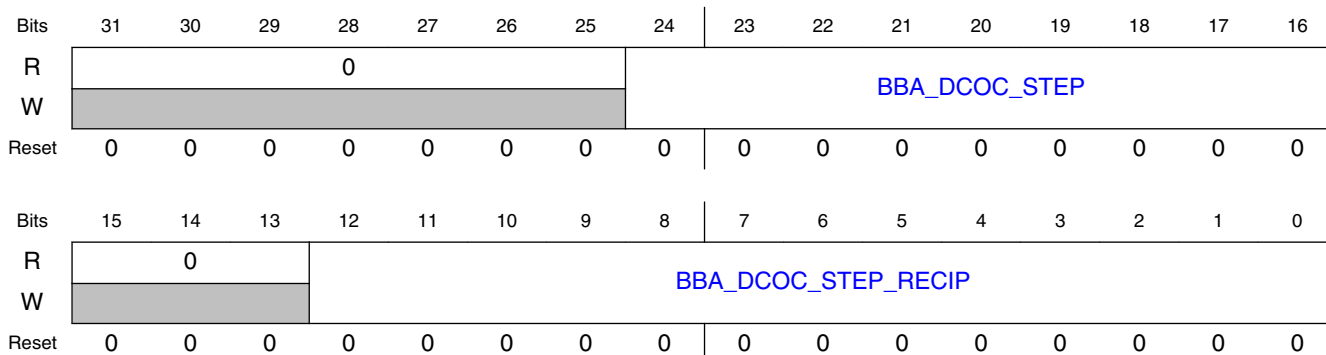

45.2.2.3.40.3 Fields

| Field | Function |
|-----------------------------|---|
| 31-25 — | Reserved. |
| 24-16 BBA_DCOC_STEP | DCOC BBA Step Size DCOC BBA Step Size (format: u6.3). This is the BBA DAC resolution in mV ($1.2e3/32*63.44/120 = 19.83mV$) times the ADC/decimator gain. This value is stored in the register with 3 fractional bits. |
| 15-13 — | Reserved. |
| 12-0 BBA_DCOC_STEP_RECIP | DCOC BBA Reciprocal of Step Size DCOC BBA Reciprocal of Step Size (format: u.[00]13). This the reciprocal of the BBA DCOC STEP value. This value is stored as a 15 bit fraction (though only 13 bits are programmed). |

45.2.2.3.41 DCOC TZA DAC Step 0 (DCOC_TZA_STEP_0)

45.2.2.3.41.1 Offset

| Register | Offset |
|-----------------|-----------|
| DCOC_TZA_STEP_0 | 4005C110h |

45.2.2.3.41.2 Diagram

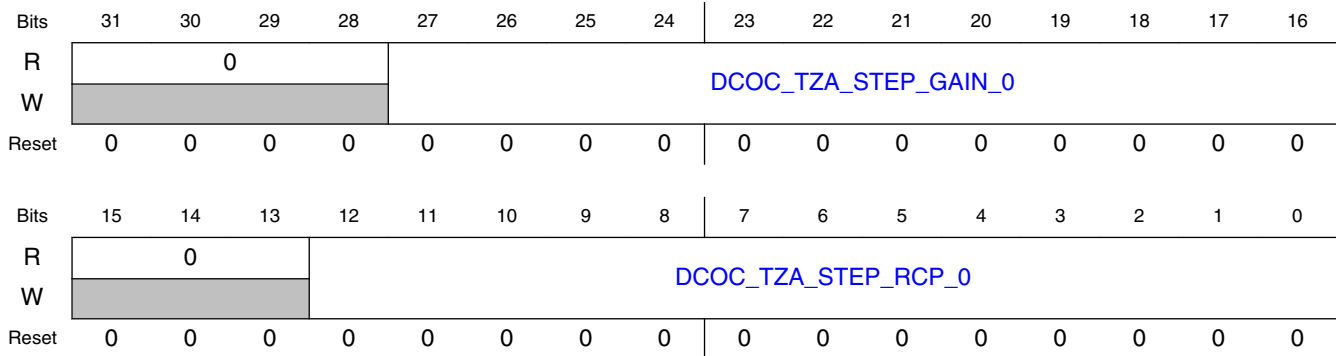

45.2.2.3.41.3 Fields

| Field | Function |
|-------------------------------|---|
| 31-28 — | Reserved. |
| 27-16 DCOC_TZA_STEP_GAIN_0 | DCOC_TZA_STEP_GAIN_0 DCOC TZA Step Size 0 with gain (format u9.3). This is the TZA DAC resolution in mV ($1.2e3/128*22.9/34 = 6.31mV$) times the ADC/decimator gain times BBA gain for BBA index 0. This value is stored in the register with 3 fractional bits. |
| 15-13 — | Reserved. |
| 12-0 DCOC_TZA_STEP_RCP_0 | DCOC_TZA_STEP_RCP_0 DCOC TZA Reciprocal of Step Size 0, (format: u.[00]13). This is the reciprocal of the DCOC_TZA_STEP_GAIN_0. The value is stored as a 15bit fractional value (though only 13 bits are programmed). |

45.2.2.3.42 DCOC TZA DAC Step 1 (DCOC_TZA_STEP_1)

45.2.2.3.42.1 Offset

| Register | Offset |
|-----------------|-----------|
| DCOC_TZA_STEP_1 | 4005C114h |

45.2.2.3.42.2 Diagram

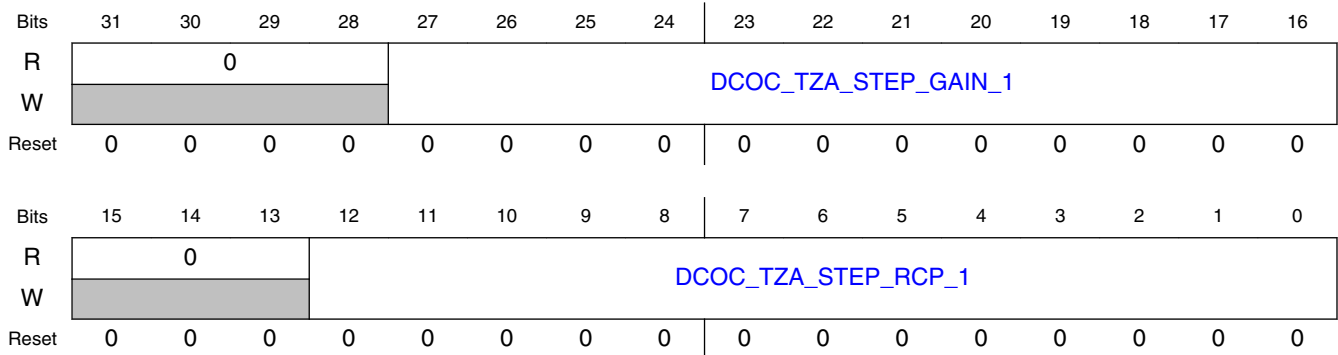

45.2.2.3.42.3 Fields

| Field | Function |
|-------------------------------|---|
| 31-28 — | Reserved. |
| 27-16 DCOC_TZA_STEP_GAIN_1 | DCOC_TZA_STEP_GAIN_1 DCOC TZA Step Size 1 with gain (format u9.3). This is the TZA DAC resolution in mV ($1.2e3/128*22.9/34 = 6.31mV$) times the ADC/decimator gain times BBA gain for BBA index 1. This value is stored in the register with 3 fractional bits. |
| 15-13 — | Reserved. |
| 12-0 DCOC_TZA_STEP_RCP_1 | DCOC_TZA_STEP_RCP_1 DCOC TZA Reciprocal of Step Size 1, (format: u.[00]13). This is the reciprocal of the DCOC_TZA_STEP_GAIN_1. The value is stored as a 15bit fractional value (though only 13 bits are programmed). |

45.2.2.3.43 DCOC TZA DAC Step 2 (DCOC_TZA_STEP_2)

45.2.2.3.43.1 Offset

| Register | Offset |
|-----------------|-----------|
| DCOC_TZA_STEP_2 | 4005C118h |

45.2.2.3.43.2 Diagram

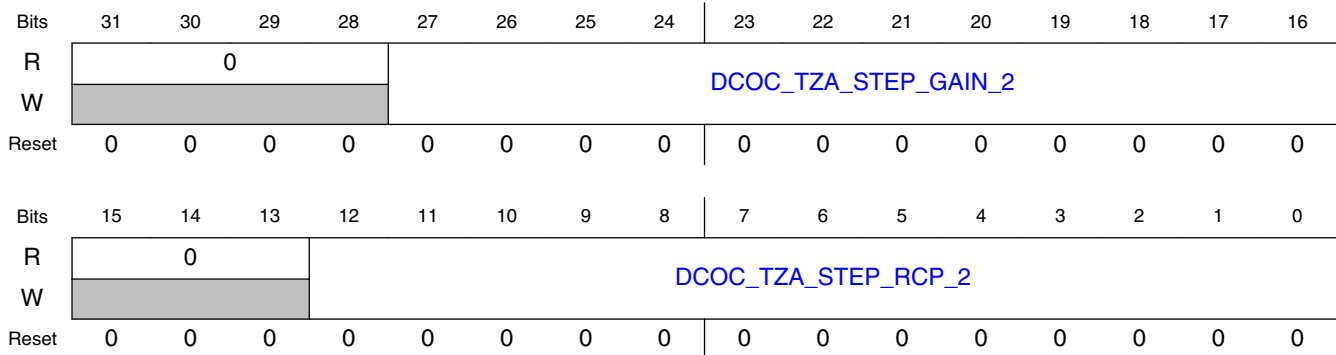

45.2.2.3.43.3 Fields

| Field | Function |
|-------------------------------|---|
| 31-28 — | Reserved. |
| 27-16 DCOC_TZA_STEP_GAIN_2 | DCOC TZA Step Size 2 with gain (format u9.3). This is the TZA DAC resolution in mV ($1.2e3/128*22.9/34 = 6.31mV$) times the ADC/decimator gain times BBA gain for BBA index 2. This value is stored in the register with 3 fractional bits. |
| 15-13 — | Reserved. |
| 12-0 DCOC_TZA_STEP_RCP_2 | DCOC TZA Reciprocal of Step Size 2, (format: u.[00]13). This is the reciprocal of the DCOC_TZA_STEP_GAIN_2. The value is stored as a 15bit fractional value (though only 13 bits are programmed). |

45.2.2.3.44 DCOC TZA DAC Step 3 (DCOC_TZA_STEP_3)

45.2.2.3.44.1 Offset

| Register | Offset |
|-----------------|-----------|
| DCOC_TZA_STEP_3 | 4005C11Ch |

45.2.2.3.44.2 Diagram

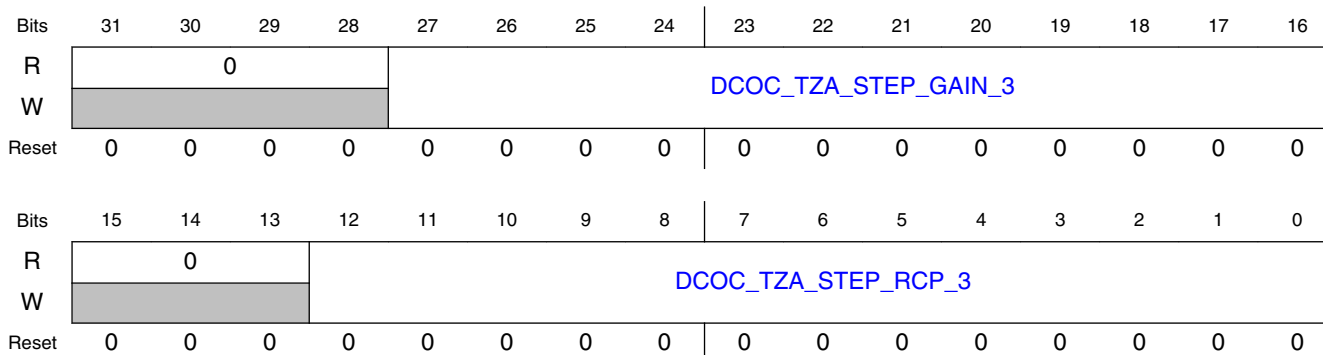

45.2.2.3.44.3 Fields

| Field | Function |
|-------------------------------|---|
| 31-28 — | Reserved. |
| 27-16 DCOC_TZA_STEP_GAIN_3 | DCOC_TZA_STEP_GAIN_3 DCOC TZA Step Size 3 with gain (format u9.3). This is the TZA DAC resolution in mV ($1.2e3/128*22.9/34 = 6.31mV$) times the ADC/decimator gain times BBA gain for BBA index 3. This value is stored in the register with 3 fractional bits. |
| 15-13 — | Reserved. |
| 12-0 DCOC_TZA_STEP_RCP_3 | DCOC_TZA_STEP_RCP_3 DCOC TZA Reciprocal of Step Size 3, (format: u.[00]13). This is the reciprocal of the DCOC_TZA_STEP_GAIN_3. The value is stored as a 15bit fractional value (though only 13 bits are programmed). |

45.2.2.3.45 DCOC TZA DAC Step 4 (DCOC_TZA_STEP_4)

45.2.2.3.45.1 Offset

| Register | Offset |
|-----------------|-----------|
| DCOC_TZA_STEP_4 | 4005C120h |

45.2.2.3.45.2 Diagram

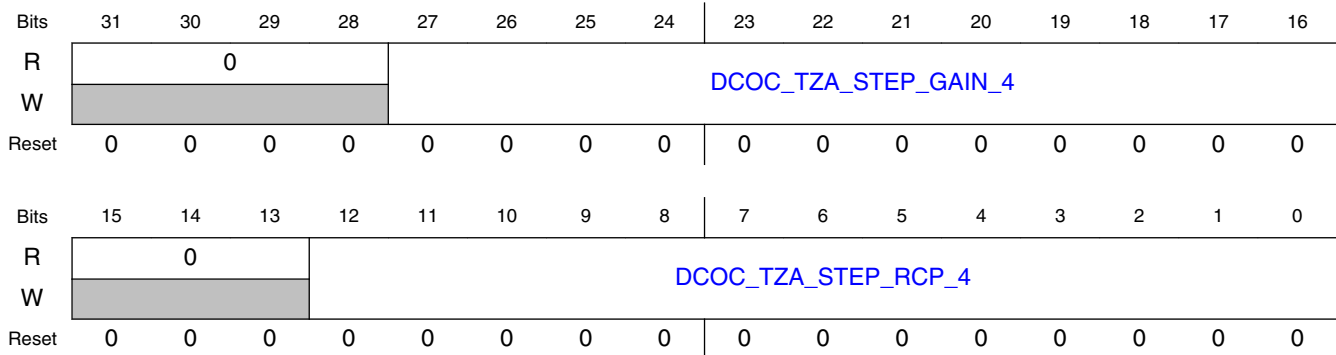

45.2.2.3.45.3 Fields

| Field | Function |
|-------------------------------|--|
| 31-28 — | Reserved. |
| 27-16 DCOC_TZA_STEP_GAIN_4 | DCOC_TZA_STEP_GAIN_4 DCOC TZA Step Size 4 with gain (format u9.3). This is the TZA DAC resolution in mV ($1.2e3/128*22.9/34 = 6.31\text{mV}$) times the ADC/decimator gain times BBA gain for BBA index 4. This value is stored in the register with 3 fractional bits. |
| 15-13 — | Reserved. |
| 12-0 DCOC_TZA_STEP_RCP_4 | DCOC_TZA_STEP_RCP_4 DCOC TZA Reciprocal of Step Size 4, (format: u.[00]13). This is the reciprocal of the DCOC_TZA_STEP_GAIN_4. The value is stored as a 15bit fractional value (though only 13 bits are programmed). |

45.2.2.3.46 DCOC TZA DAC Step 5 (DCOC_TZA_STEP_5)

45.2.2.3.46.1 Offset

| Register | Offset |
|-----------------|-----------|
| DCOC_TZA_STEP_5 | 4005C124h |

45.2.2.3.46.2 Diagram

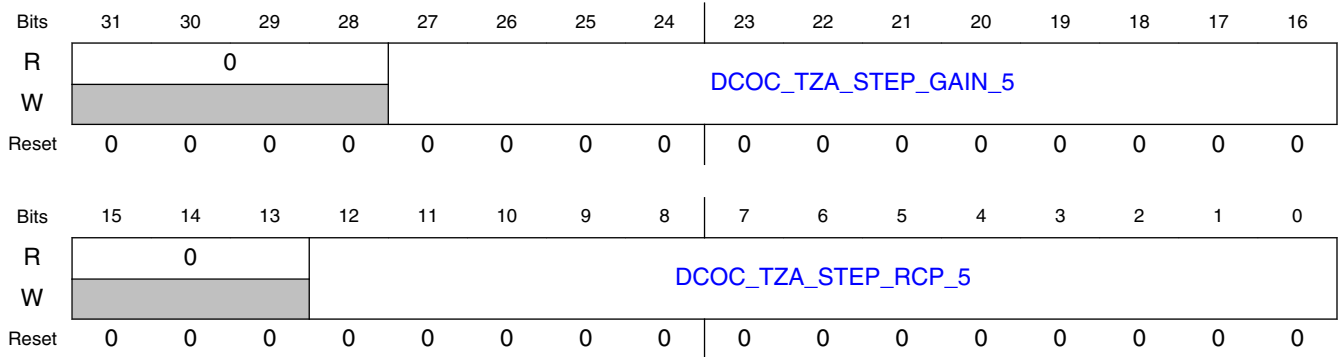

45.2.2.3.46.3 Fields

| Field | Function |
|-------------------------------|---|
| 31-28 — | Reserved. |
| 27-16 DCOC_TZA_STEP_GAIN_5 | DCOC_TZA_STEP_GAIN_5 DCOC TZA Step Size 5 with gain (format u9.3). This is the TZA DAC resolution in mV ($1.2e3/128*22.9/34 = 6.31mV$) times the ADC/decimator gain times BBA gain for BBA index 5. This value is stored in the register with 3 fractional bits. |
| 15-13 — | Reserved. |
| 12-0 DCOC_TZA_STEP_RCP_5 | DCOC_TZA_STEP_RCP_5 DCOC TZA Reciprocal of Step Size 5, (format: u.[00]13). This is the reciprocal of the DCOC_TZA_STEP_GAIN_5. The value is stored as a 15bit fractional value (though only 13 bits are programmed). |

45.2.2.3.47 DCOC TZA DAC Step 6 (DCOC_TZA_STEP_6)

45.2.2.3.47.1 Offset

| Register | Offset |
|-----------------|-----------|
| DCOC_TZA_STEP_6 | 4005C128h |

45.2.2.3.47.2 Diagram

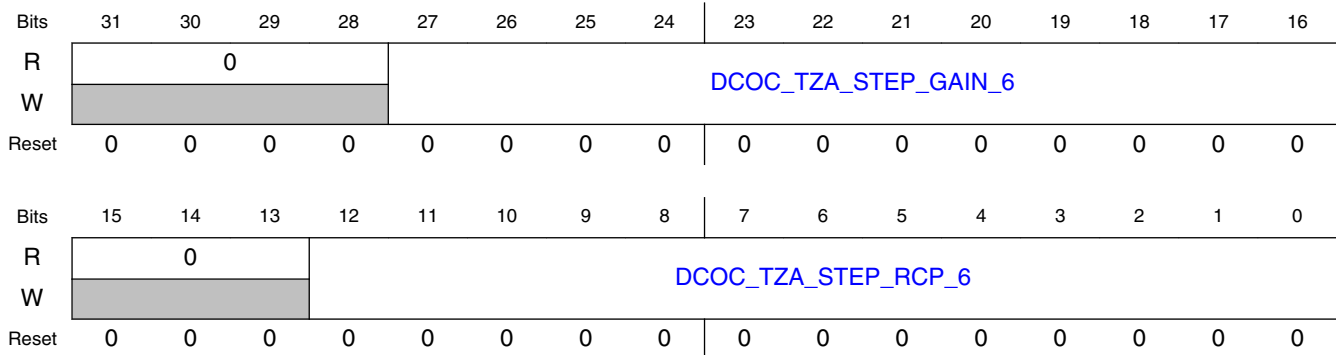

45.2.2.3.47.3 Fields

| Field | Function |
|-------------------------------|---|
| 31-28 — | Reserved. |
| 27-16 DCOC_TZA_STEP_GAIN_6 | DCOC_TZA_STEP_GAIN_6 DCOC TZA Step Size 6 with gain (format u9.3). This is the TZA DAC resolution in mV ($1.2e3/128*22.9/34 = 6.31mV$) times the ADC/decimator gain times BBA gain for BBA index 6. This value is stored in the register with 3 fractional bits. |
| 15-13 — | Reserved. |
| 12-0 DCOC_TZA_STEP_RCP_6 | DCOC_TZA_STEP_RCP_6 DCOC TZA Reciprocal of Step Size 6, (format: u.[00]13). This is the reciprocal of the DCOC_TZA_STEP_GAIN_6. The value is stored as a 15bit fractional value (though only 13 bits are programmed). |

45.2.2.3.48 DCOC TZA DAC Step 7 (DCOC_TZA_STEP_7)

45.2.2.3.48.1 Offset

| Register | Offset |
|-----------------|-----------|
| DCOC_TZA_STEP_7 | 4005C12Ch |

45.2.2.3.48.2 Diagram

| | | | | | | | | | | | | | | | | | |
|-------|----|----|----|----------------------|----|----|----|----|----|----|----|----|----|----|----|----|---|
| Bits | 31 | 30 | 29 | 28 | 27 | 26 | 25 | 24 | 23 | 22 | 21 | 20 | 19 | 18 | 17 | 16 | |
| R | 0 | | | DCOC_TZA_STEP_GAIN_7 | | | | | | | | | | | | | |
| W | 0 | | | DCOC_TZA_STEP_GAIN_7 | | | | | | | | | | | | | |
| Reset | 0 | 0 | 0 | 0 | 0 | 0 | 0 | 0 | 0 | 0 | 0 | 0 | 0 | 0 | 0 | 0 | 0 |
| Bits | 15 | 14 | 13 | 12 | 11 | 10 | 9 | 8 | 7 | 6 | 5 | 4 | 3 | 2 | 1 | 0 | |
| R | 0 | | | DCOC_TZA_STEP_RCP_7 | | | | | | | | | | | | | |
| W | 0 | | | DCOC_TZA_STEP_RCP_7 | | | | | | | | | | | | | |
| Reset | 0 | 0 | 0 | 0 | 0 | 0 | 0 | 0 | 0 | 0 | 0 | 0 | 0 | 0 | 0 | 0 | |

45.2.2.3.48.3 Fields

| Field | Function |
|-------------------------------|--|
| 31-29 — | Reserved. |
| 28-16 DCOC_TZA_STEP_GAIN_7 | DCOC_TZA_STEP_GAIN_7 DCOC TZA Step Size 7 with gain (format u10.3). This is the TZA DAC resolution in mV ($1.2e3/128*22.9/34 = 6.31mV$) times the ADC/decimator gain times BBA gain for BBA index 7. This value is stored in the register with 3 fractional bits. |
| 15-13 — | Reserved. |
| 12-0 DCOC_TZA_STEP_RCP_7 | DCOC_TZA_STEP_RCP_7 DCOC TZA Reciprocal of Step Size 7, (format: u.[00]13). This the reciprocal of the DCOC_TZA_STEP_GAIN_7. The value is stored as a 15bit fractional value (though only 13 bits are programmed). |

45.2.2.3.49 DCOC TZA DAC Step 5 (DCOC_TZA_STEP_8)

45.2.2.3.49.1 Offset

| Register | Offset |
|-----------------|-----------|
| DCOC_TZA_STEP_8 | 4005C130h |

45.2.2.3.49.2 Diagram

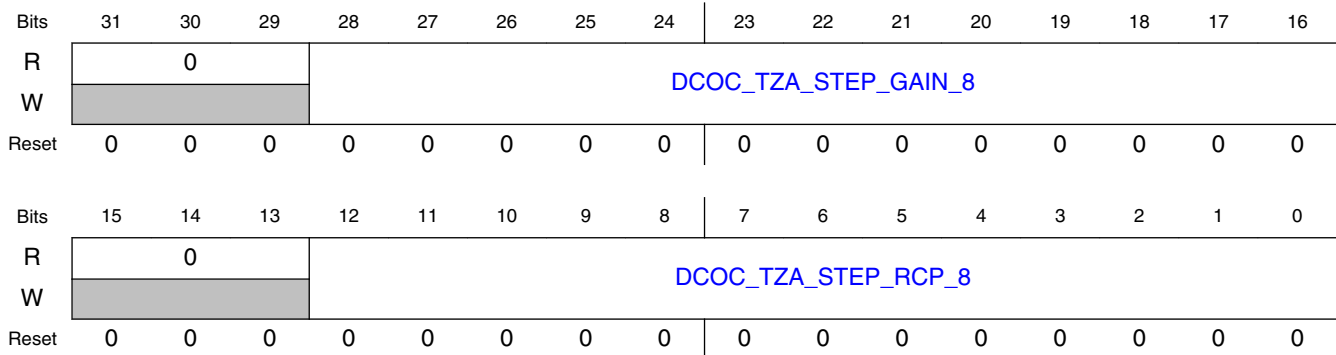

45.2.2.3.49.3 Fields

| Field | Function |
|-------------------------------|---|
| 31-29 — | Reserved. |
| 28-16 DCOC_TZA_STEP_GAIN_8 | DCOC_TZA_STEP_GAIN_8 DCOC TZA Step Size 8 with gain (format u10.3). This is the TZA DAC resolution in mV ($1.2e3/128*22.9/34 = 6.31\text{mV}$) times the ADC/decimator gain times BBA gain for BBA index 8. This value is stored in the register with 3 fractional bits. |
| 15-13 — | Reserved. |
| 12-0 DCOC_TZA_STEP_RCP_8 | DCOC_TZA_STEP_RCP_8 DCOC TZA Reciprocal of Step Size 8, (format: u.[00]13). This the reciprocal of the DCOC_TZA_STEP_GAIN_8. The value is stored as a 15bit fractional value (though only 13 bits are programmed). |

45.2.2.3.50 DCOC TZA DAC Step 9 (DCOC_TZA_STEP_9)

45.2.2.3.50.1 Offset

| Register | Offset |
|-----------------|-----------|
| DCOC_TZA_STEP_9 | 4005C134h |

45.2.2.3.50.2 Diagram

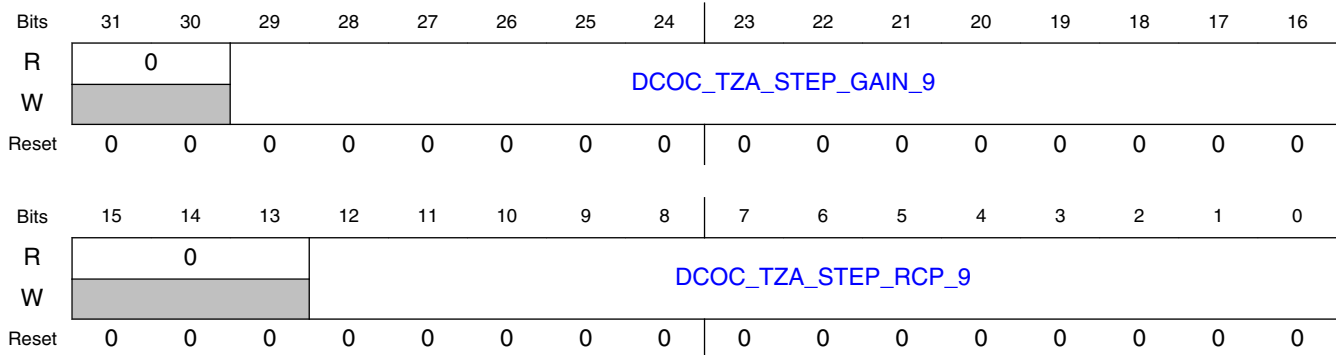

45.2.2.3.50.3 Fields

| Field | Function |
|-------------------------------|--|
| 31-30 — | Reserved. |
| 29-16 DCOC_TZA_STEP_GAIN_9 | DCOC_TZA_STEP_GAIN_9 DCOC TZA Step Size 9 with gain (format u11.3). This is the TZA DAC resolution in mV ($1.2e3/128*22.9/34 = 6.31mV$) times the ADC/decimator gain times BBA gain for BBA index 9. This value is stored in the register with 3 fractional bits. |
| 15-13 — | Reserved. |
| 12-0 DCOC_TZA_STEP_RCP_9 | DCOC_TZA_STEP_RCP_9 DCOC TZA Reciprocal of Step Size 9, (format: u.[00]13). This the reciprocal of the DCOC_TZA_STEP_GAIN_9. The value is stored as a 15bit fractional value (though only 13 bits are programmed). |

45.2.2.3.51 DCOC TZA DAC Step 10 (DCOC_TZA_STEP_10)

45.2.2.3.51.1 Offset

| Register | Offset |
|------------------|-----------|
| DCOC_TZA_STEP_10 | 4005C138h |

45.2.2.3.51.2 Diagram

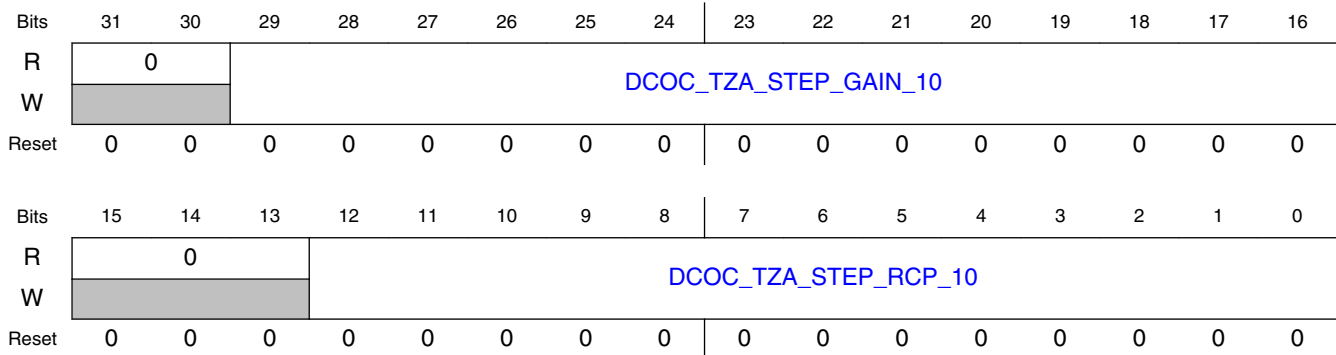

45.2.2.3.51.3 Fields

| Field | Function |
|--------------------------------|---|
| 31-30 — | Reserved. |
| 29-16 DCOC_TZA_STEP_GAIN_10 | DCOC_TZA_STEP_GAIN_10 DCOC TZA Step Size 10 with gain (format u11.3). This is the TZA DAC resolution in mV ($1.2e3/128*22.9/34 = 6.31mV$) times the ADC/decimator gain times BBA gain for BBA index 10. This value is stored in the register with 3 fractional bits. |
| 15-13 — | Reserved. |
| 12-0 DCOC_TZA_STEP_RCP_10 | DCOC_TZA_STEP_RCP_10 DCOC TZA Reciprocal of Step Size 10, (format: u.[00]13). This is the reciprocal of the DCOC_TZA_STEP_GAIN_10. The value is stored as a 15bit fractional value (though only 13 bits are programmed). |

45.2.2.3.52 DCOC Calibration Alpha (DCOC_CAL_ALPHA)

45.2.2.3.52.1 Offset

| Register | Offset |
|----------------|-----------|
| DCOC_CAL_ALPHA | 4005C168h |

45.2.2.3.52.2 Diagram

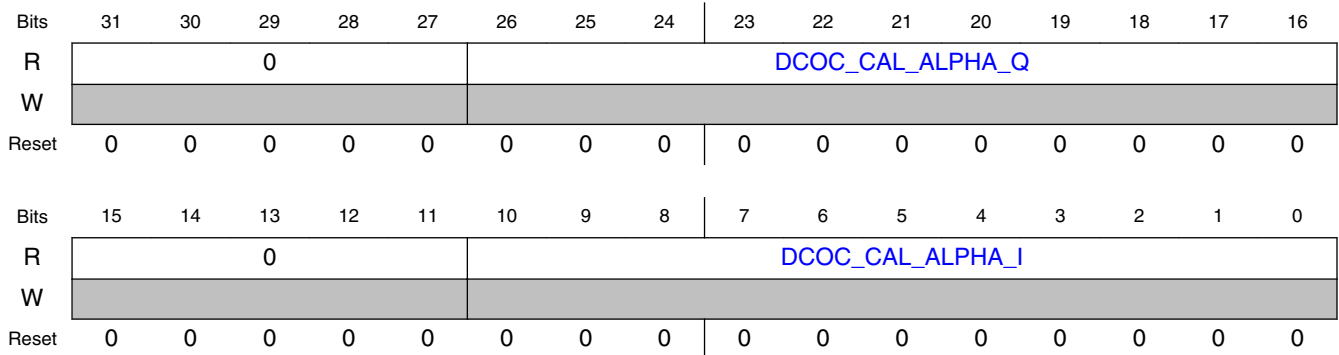

45.2.2.3.52.3 Fields

| Field | Function |
|---------------------------|--|
| 31-27 — | Reserved. |
| 26-16 DCOC_CAL_ALPHA_Q | DCOC_CAL_ALPHA_Q DCOC Calibration Q-channel ALPHA. This read-only value represents the Q channel estimate of the ALPHA DC component calculated in DCOC calibration. Format s4.6. This is provided for debug/characterization purposes. |
| 15-11 — | Reserved. |
| 10-0 DCOC_CAL_ALPHA_I | DCOC Calibration I-channel ALPHA constant DCOC Calibration I-channel ALPHA. This read-only value represents the I channel estimate of the ALPHA DC component calculated in DCOC calibration. Format s4.6. This is provided for debug/characterization purposes. |

45.2.2.3.53 DCOC Calibration Beta Q (DCOC_CAL_BETA_Q)

45.2.2.3.53.1 Offset

| Register | Offset |
|-----------------|-----------|
| DCOC_CAL_BETA_Q | 4005C16Ch |

45.2.2.3.53.2 Diagram

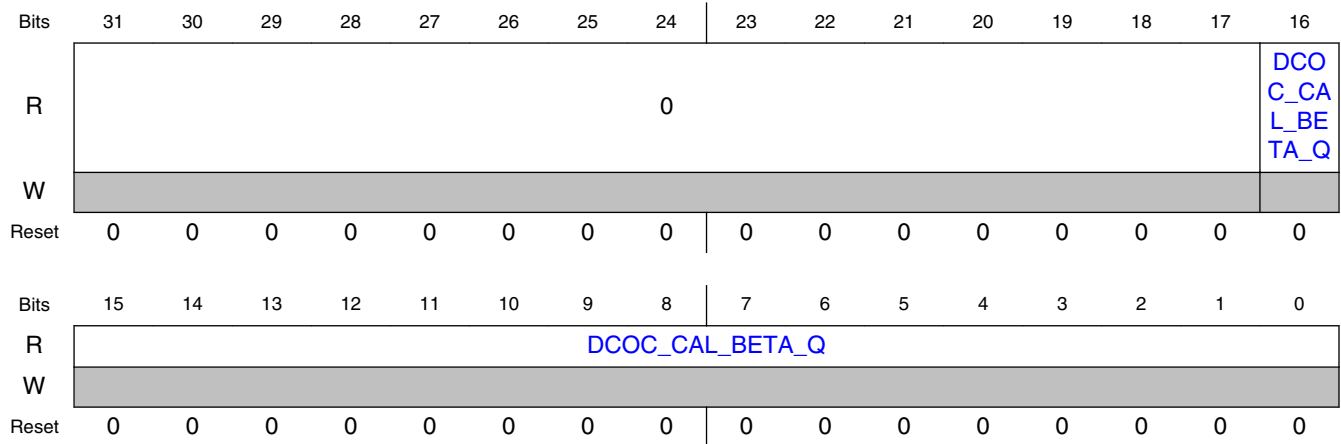

45.2.2.3.53.3 Fields

| Field | Function |
|--|---|
| 31-17 — | Reserved. |
| 16-0 DCOC_CAL_BETA_Q DCOC_CAL_BETA_Q TA_Q | DCOC_CAL_BETA_Q DCOC Calibration Q-channel BETA. This read-only value represents the Q channel estimate of the BETA DC component calculated in DCOC calibration. Format s11.5. This is provided for debug/characterization purposes. |

45.2.2.3.54 DCOC Calibration Beta I (DCOC_CAL_BETA_I)

45.2.2.3.54.1 Offset

| Register | Offset |
|-----------------|-----------|
| DCOC_CAL_BETA_I | 4005C170h |

45.2.2.3.54.2 Diagram

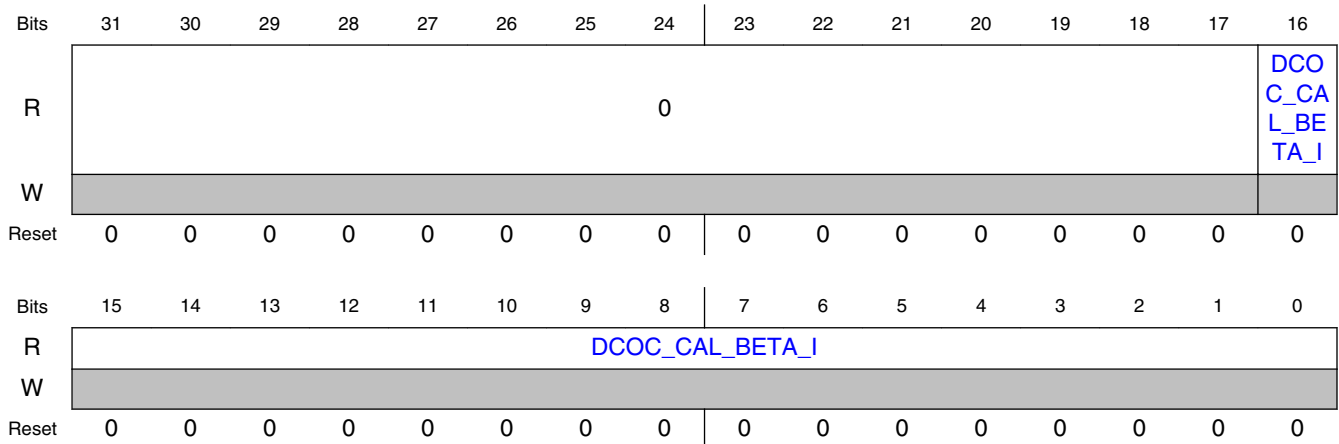

45.2.2.3.54.3 Fields

| Field | Function |
|-------------------------|---|
| 31-17 — | Reserved. |
| 16-0 DCOC_CAL_BETA_I | DCOC_CAL_BETA_I DCOC Calibration I-channel BETA. This read-only value represents the I channel estimate of the BETA DC component calculated in DCOC calibration. Format s11.5. This is provided for debug/characterization purposes. |

45.2.2.3.55 DCOC Calibration Gamma (DCOC_CAL_GAMMA)

45.2.2.3.55.1 Offset

| Register | Offset |
|----------------|-----------|
| DCOC_CAL_GAMMA | 4005C174h |

45.2.2.3.55.2 Diagram

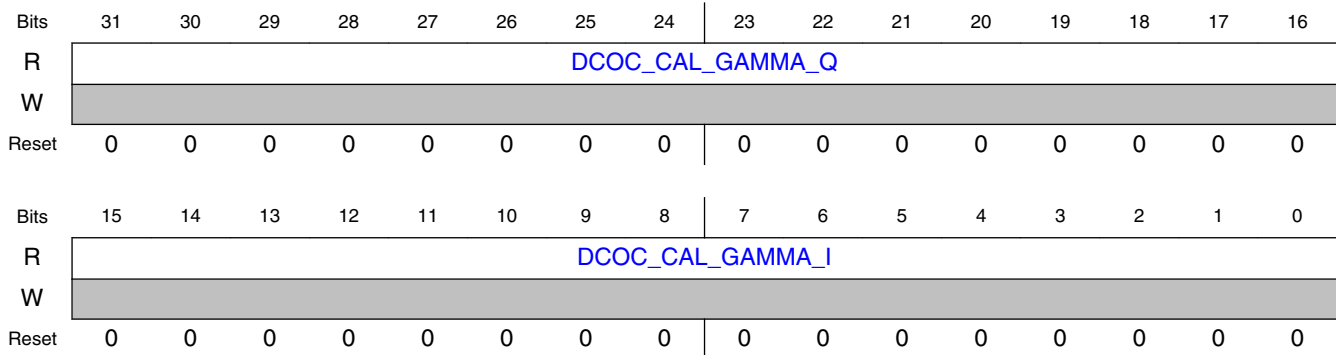

45.2.2.3.55.3 Fields

| Field | Function |
|---------------------------|--|
| 31-16 DCOC_CAL_GAMMA_Q | DCOC_CAL_GAMMA_Q DCOC Calibration Q-channel GAMMA. This read-only value represents the Q channel estimate of the GAMMA DC component calculated in DCOC calibration. Format s11.4. This is provided for debug/characterization purposes. |
| 15-0 DCOC_CAL_GAMMA_I | DCOC_CAL_GAMMA_I DCOC Calibration I-channel GAMMA. This read-only value represents the I channel estimate of the GAMMA DC component calculated in DCOC calibration. Format s11.4. This is provided for debug/characterization purposes. |

45.2.2.3.56 DCOC Calibration IIR (DCOC_CAL_IIR)

45.2.2.3.56.1 Offset

| Register | Offset |
|--------------|-----------|
| DCOC_CAL_IIR | 4005C178h |

45.2.2.3.56.2 Diagram

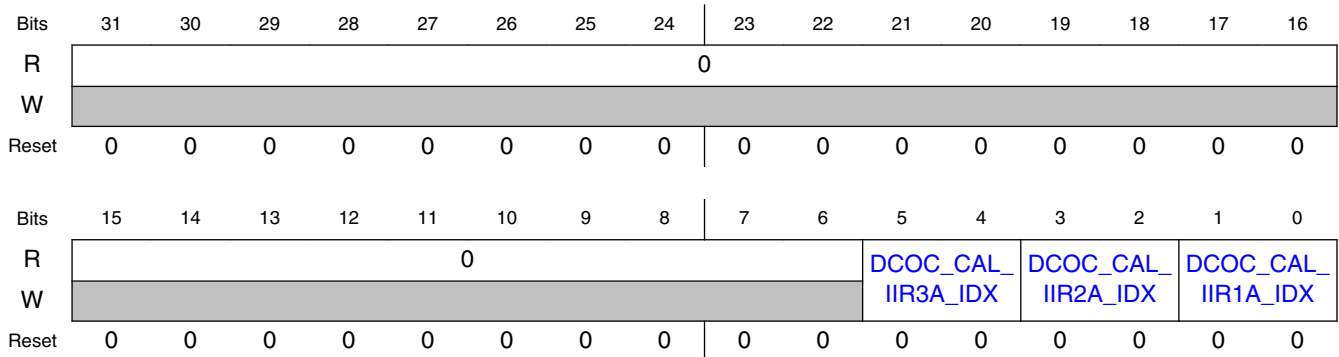

45.2.2.3.56.3 Fields

| Field | Function |
|---------------------------|---|
| 31-6 Reserved | Reserved. |
| 5-4 DCOC_CAL_IIR3A_IDX | DCOC Calibration IIR 3A Index DCOC Calibration IIR 3A Index. Defines the filter coefficient use for the 3rd IIR filter in the DCOC calibration DC estimator. 00b - 1/4 01b - 1/8 10b - 1/16 11b - 1/32 |
| 3-2 DCOC_CAL_IIR2A_IDX | DCOC Calibration IIR 2A Index DCOC Calibration IIR 2A Index. Defines the filter coefficient use for the 2nd IIR filter in the DCOC calibration DC estimator. 00b - 1/1 01b - 1/4 10b - 1/8 11b - 1/16 |
| 1-0 DCOC_CAL_IIR1A_IDX | DCOC Calibration IIR 1A Index DCOC Calibration IIR 1A Index. Defines the filter coefficient use for the 1st IIR filter in the DCOC calibration DC estimator. 00b - 1/1 01b - 1/4 10b - 1/8 11b - 1/16 |

45.2.2.3.57 DCOC Calibration Result (DCOC_CALa)

45.2.2.3.57.1 Offset

| Register | Offset |
|-----------|-----------|
| DCOC_CAL1 | 4005C180h |
| DCOC_CAL2 | 4005C184h |
| DCOC_CAL3 | 4005C188h |

45.2.2.3.57.2 Function

Result of one of the calibration iterations.

45.2.2.3.57.3 Diagram

| | | | | | | | | | | | | | | | | |
|-------|----------|----|----|----|----|----|----|----|----------------|----|----|----|----|----|----|----|
| Bits | 31 | 30 | 29 | 28 | 27 | 26 | 25 | 24 | 23 | 22 | 21 | 20 | 19 | 18 | 17 | 16 |
| R | 0 | | | | | | | | DCOC_CAL_RES_Q | | | | | | | |
| W | [Shaded] | | | | | | | | | | | | | | | |
| Reset | 0 | 0 | 0 | 0 | 0 | 0 | 0 | 0 | 0 | 0 | 0 | 0 | 0 | 0 | 0 | 0 |
| Bits | 15 | 14 | 13 | 12 | 11 | 10 | 9 | 8 | 7 | 6 | 5 | 4 | 3 | 2 | 1 | 0 |
| R | 0 | | | | | | | | DCOC_CAL_RES_I | | | | | | | |
| W | [Shaded] | | | | | | | | | | | | | | | |
| Reset | 0 | 0 | 0 | 0 | 0 | 0 | 0 | 0 | 0 | 0 | 0 | 0 | 0 | 0 | 0 | 0 |

45.2.2.3.57.4 Fields

| Field | Function |
|-----------------------------|--|
| 31-28 — | Reserved. |
| 27-16 DCOC_CAL_RE S_Q | DCOC Calibration Result - Q Channel Q channel DCOC calibration result. This value represents the DCOC's Q channel DC estimate for the nth calibration gain setting. Format s11. This is provided for debug/chacterization purposes. |
| 15-12 — | Reserved. |
| 11-0 DCOC_CAL_RE S_I | DCOC Calibration Result - I Channel I channel DCOC calibration result. This value represents the DCOC's I channel DC estimate for the nth calibration gain setting. Format s11. This is provided for debug/chacterization purposes. |

45.2.2.3.58 RX_DIG CCA ED LQI Control Register 0 (CCA_ED_LQI_CTRL_0)

45.2.2.3.58.1 Offset

| Register | Offset |
|-------------------|-----------|
| CCA_ED_LQI_CTRL_0 | 4005C190h |

45.2.2.3.58.2 Diagram

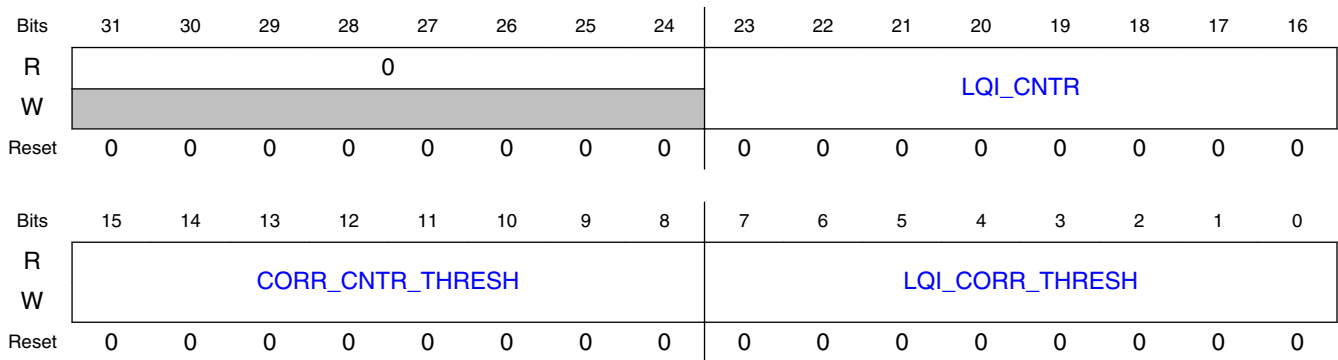

45.2.2.3.58.3 Fields

| Field | Function |
|------------------------------|--|
| 31-24 — | Reserved. |
| 23-16 LQI_CNTR | LQI Counter Duration of LQI in uS. |
| 15-8 CORR_CNTR_T HRESH | Correlation Count Threshold Threshold used to compare the counted correlation magnitudes exceeding LQI_CORR_THRESH. |
| 7-0 LQI_CORR_TH RESH | LQI Correlation Threshold Threshold used to compare correlation magnitude values from the PHY |

45.2.2.3.59 RX_DIG CCA ED LQI Control Register 1 (CCA_ED_LQI_CTRL_1)

45.2.2.3.59.1 Offset

| Register | Offset |
|-------------------|-----------|
| CCA_ED_LQI_CTRL_1 | 4005C194h |

45.2.2.3.59.2 Diagram

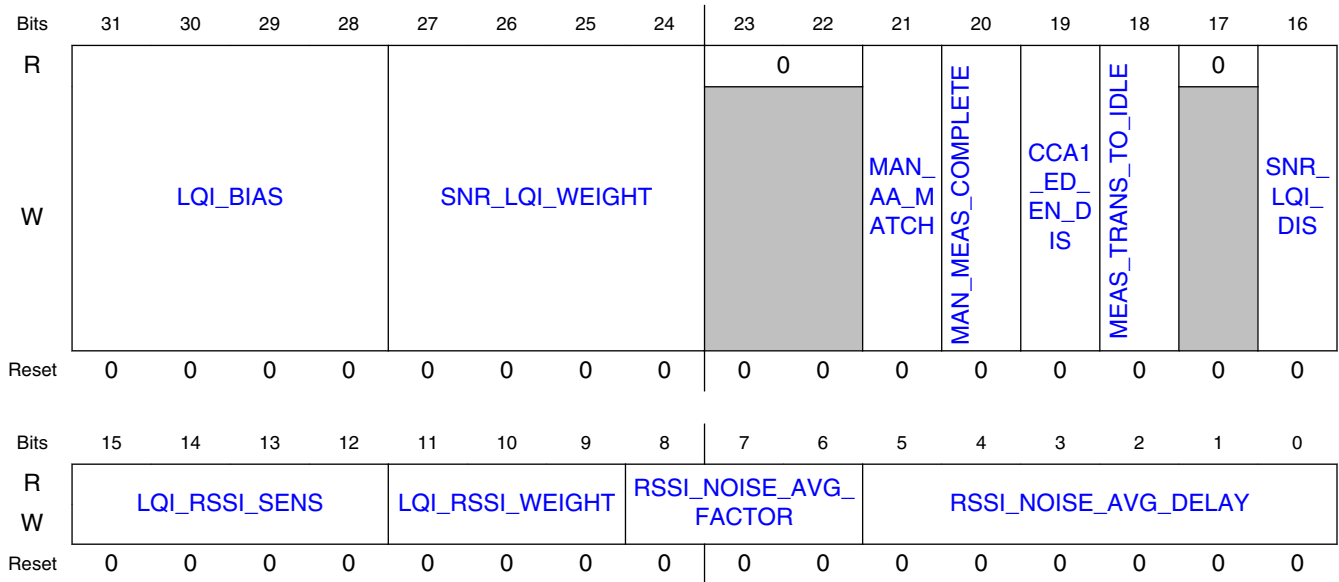

45.2.2.3.59.3 Fields

| Field | Function |
|-------------------------|--|
| 31-28 LQI_BIAS | LQI Bias. Bias used for LQI calculation. Applied bias = $-36 + 2 * LQI_BIAS$. |
| 27-24 SNR_LQI_WEIGHT | SNR LQI Weight SNR weight used for LQI calculation 0000b - 0.0 0001b - 1.0 0010b - 1.125 0011b - 1.25 0100b - 1.375 0101b - 1.5 0110b - 1.625 0111b - 1.75 1000b - 1.875 1001b - 2.0 1010b - 2.125 1011b - 2.25 1100b - 2.375 1101b - 2.5 |

Table continues on the next page...

Radio Register Overview

| Field | Function |
|----------------------------------|---|
| | 1110b - 2.625 1111b - 2.75 |
| 23-22 — | Reserved. |
| 21 MAN_AA_MAT CH | Manual AA Match When set, this causes an AA match condition. Intended to be used only for debug. 0b - Normal operation 1b - Manually asserts the AA match signal for the RX_DIG CCA/ED/LQI and AGC blocks. Intended to be used only for debug. |
| 20 MAN_MEAS_C COMPLETE | Manual measurement complete 0b - Normal operation 1b - Manually asserts the measurement complete signal for the RX_DIG CCA/ED/LQI blocks. Intended to be used only for debug. |
| 19 CCA1_ED_EN_ DIS | CCA1_ED_EN Disable 0b - Normal operation 1b - CCA1_ED_EN input is disabled |
| 18 MEAS_TRANS_ TO_IDLE | Measurement Transition to IDLE Establishes the state machine transition following an LQI or CCA1/ED measurement 0b - Module transitions to RSSI state 1b - Module transitions to IDLE state |
| 17 — | Reserved. |
| 16 SNR_LQI_DIS | SNR LQI Disable 0b - Normal operation. 1b - The RX_DIG CCA/ED/LQI block ignores the AA match input which starts an LQI measurement. |
| 15-12 LQI_RSSI_SEN S | LQI RSSI Sensitivity Unsigned integer used for calculation of LQI sensitivity. Sensitivity = -103 + LQI_RSSI_SENS. |
| 11-9 LQI_RSSI_WEI GHT | LQI RSSI Weight RSSI weight used for LQI calculation 000b - 2.0 001b - 2.125 010b - 2.25 011b - 2.375 100b - 2.5 101b - 2.625 110b - 2.75 111b - 2.875 |
| 8-6 RSSI_NOISE_A VG_FACTOR | RSSI Noise Averaging Factor Factor used for RSSI and SNR averaging. 000b - 1 001b - 64 010b - 70 011b - 128 100b - 139 101b - 256 110b - 277 111b - 512 |

Table continues on the next page...

| Field | Function |
|---------------------------------|---|
| 5-0 RSSI_NOISE_A VG_DELAY | RSSI Noise Averaging Delay Programmable delay used to delay the enable of averagers "RSSI Averager" and "Noise Averager" after a cca1_ed_trig assertion (in wideband mode) or after a aa_sfd_matched assertion (in narrowband mode). The delay is expressed in ticks of frequenc F_s/N , where F_s is the ADC decimator output sampling frequency in wideband mode or the base-band sampling frequency in the narrowband mode. |

45.2.2.3.60 RX_DIG CCA ED LQI Status Register 0 (CCA_ED_LQI_STAT_0)

45.2.2.3.60.1 Offset

| Register | Offset |
|-------------------|-----------|
| CCA_ED_LQI_STAT_0 | 4005C198h |

45.2.2.3.60.2 Diagram

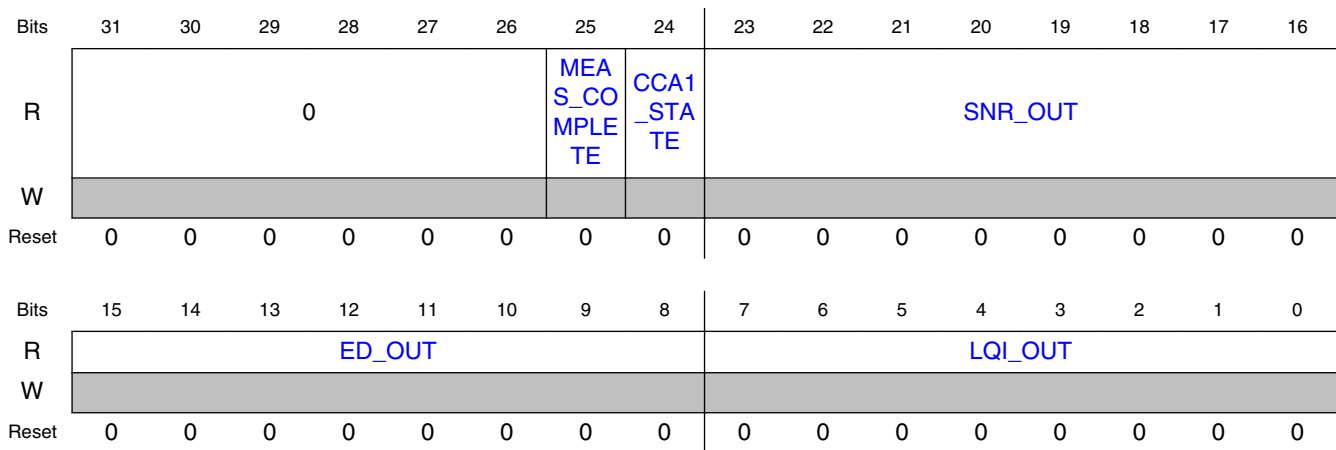

45.2.2.3.60.3 Fields

| Field | Function |
|-------------------------|--|
| 31-26 — | Reserved. |
| 25 MEAS_COMPL ETE | Measurement Complete Set upon measurement complete |
| 24 CCA1_STATE | CCA1 State Reflects the state of CCA1 channel state |

Table continues on the next page...

Radio Register Overview

| Field | Function |
|------------------|---|
| 23-16 SNR_OUT | SNR output Reflects the SNR measurement value. |
| 15-8 ED_OUT | ED output Reflects the Energy Detect (DC) measurement value. |
| 7-0 LQI_OUT | LQI output Reflects the LQI measurement value. |

45.2.2.3.61 Receive Channel Filter Coefficient 0 (RX_CHF_COEF_0)

45.2.2.3.61.1 Offset

| Register | Offset |
|---------------|-----------|
| RX_CHF_COEF_0 | 4005C1A0h |

45.2.2.3.61.2 Diagram

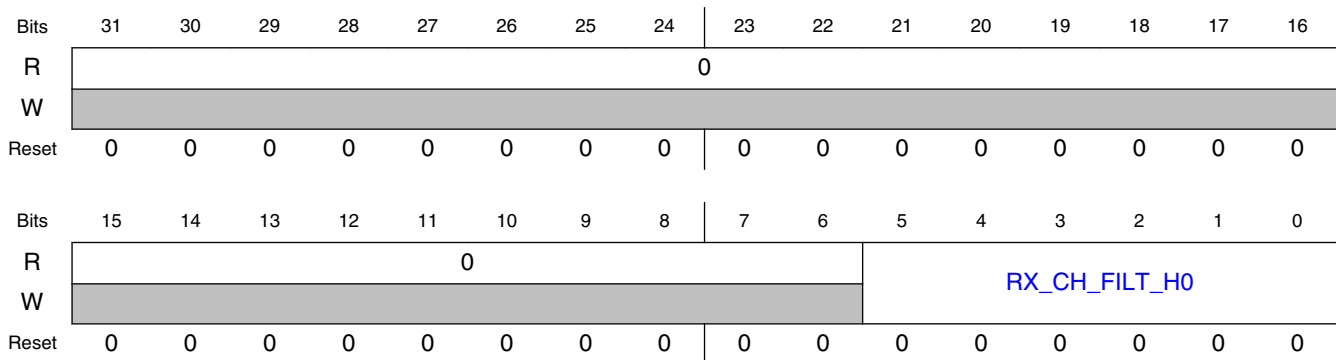

45.2.2.3.61.3 Fields

| Field | Function |
|----------------------|---|
| 31-6 Reserved | Reserved. |
| 5-0 RX_CH_FILT_H0 | RX Channel Filter Coefficient 0 RX Channel Filter Coefficient 0, 6-bit signed fractional |

45.2.2.3.62 Receive Channel Filter Coefficient 1 (RX_CHF_COEF_1)

45.2.2.3.62.1 Offset

| Register | Offset |
|---------------|-----------|
| RX_CHF_COEF_1 | 4005C1A4h |

45.2.2.3.62.2 Diagram

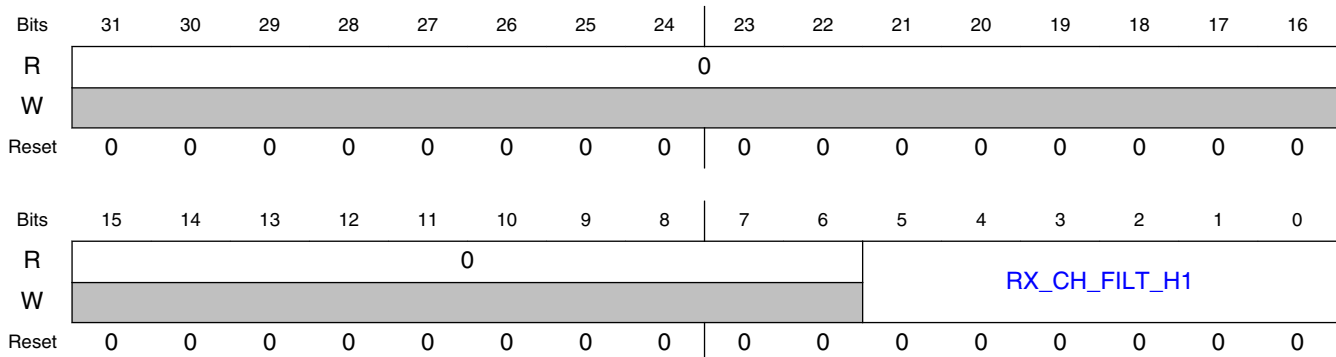

45.2.2.3.62.3 Fields

| Field | Function |
|----------------------|---|
| 31-6 Reserved | Reserved. |
| 5-0 RX_CH_FILT_H1 | RX Channel Filter Coefficient 1 RX Channel Filter Coefficient 1, 6-bit signed fractional |

45.2.2.3.63 Receive Channel Filter Coefficient 2 (RX_CHF_COEF_2)

45.2.2.3.63.1 Offset

| Register | Offset |
|---------------|-----------|
| RX_CHF_COEF_2 | 4005C1A8h |

45.2.2.3.63.2 Diagram

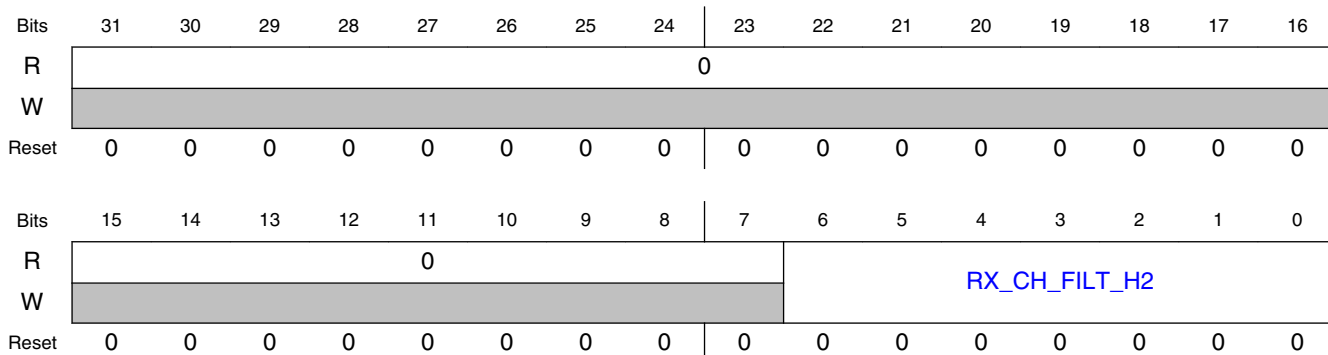

45.2.2.3.63.3 Fields

| Field | Function |
|----------------------|---|
| 31-7 Reserved | Reserved. |
| 6-0 RX_CH_FILT_H2 | RX Channel Filter Coefficient 2 RX Channel Filter Coefficient 2, 7-bit signed fractional |

45.2.2.3.64 Receive Channel Filter Coefficient 3 (RX_CHF_COEF_3)

45.2.2.3.64.1 Offset

| Register | Offset |
|---------------|-----------|
| RX_CHF_COEF_3 | 4005C1ACh |

45.2.2.3.64.2 Diagram

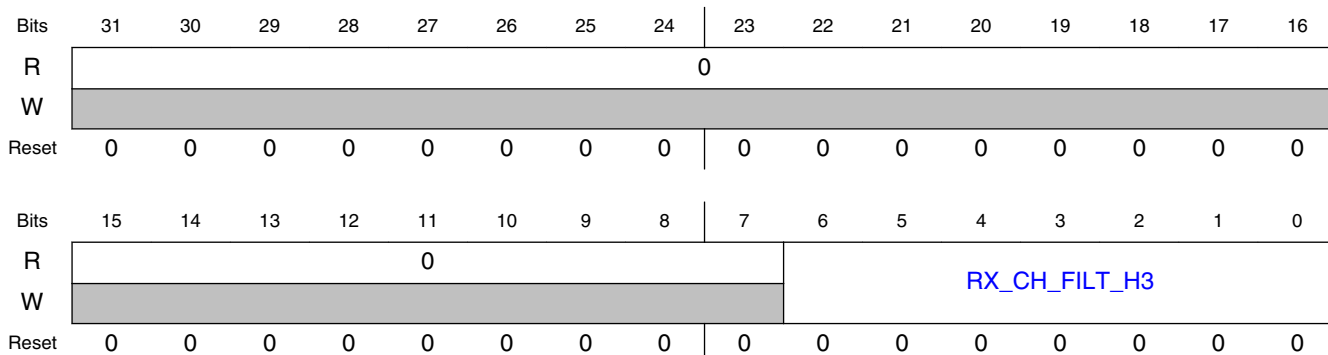

45.2.2.3.64.3 Fields

| Field | Function |
|--------------------------|---|
| 31-7 Reserved | Reserved. |
| 6-0 RX_CH_FILT_H 3 | RX Channel Filter Coefficient 3 RX Channel Filter Coefficient 3, 7-bit signed fractional |

45.2.2.3.65 Receive Channel Filter Coefficient 4 (RX_CHF_COEF_4)

45.2.2.3.65.1 Offset

| Register | Offset |
|---------------|-----------|
| RX_CHF_COEF_4 | 4005C1B0h |

45.2.2.3.65.2 Diagram

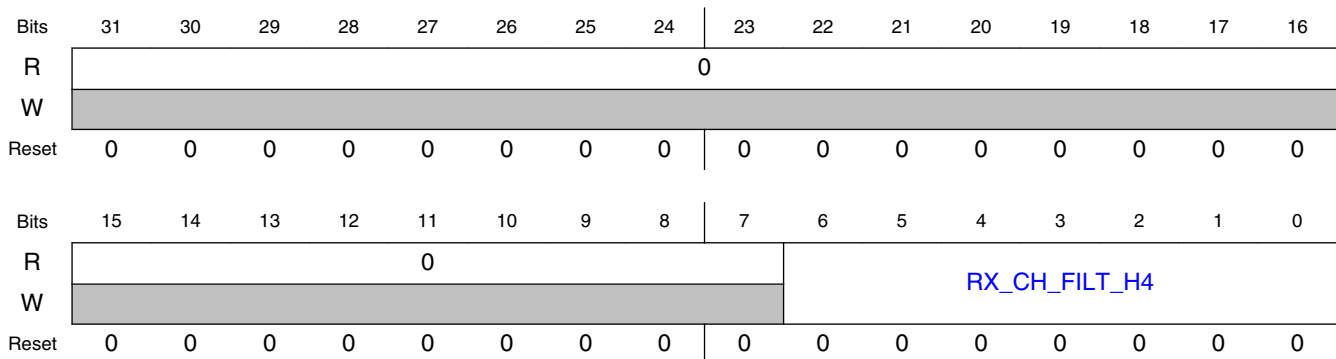

45.2.2.3.65.3 Fields

| Field | Function |
|--------------------------|---|
| 31-7 Reserved | Reserved. |
| 6-0 RX_CH_FILT_H 4 | RX Channel Filter Coefficient 4 RX Channel Filter Coefficient 4, 7-bit signed fractional |

45.2.2.3.66 Receive Channel Filter Coefficient 5 (RX_CHF_COEF_5)

45.2.2.3.66.1 Offset

| Register | Offset |
|---------------|-----------|
| RX_CHF_COEF_5 | 4005C1B4h |

45.2.2.3.66.2 Diagram

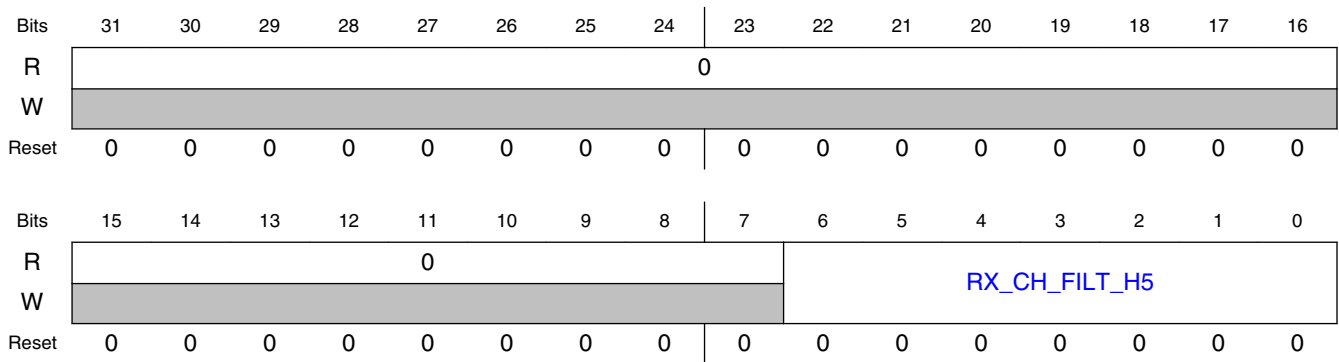

45.2.2.3.66.3 Fields

| Field | Function |
|----------------------|---|
| 31-7 Reserved | Reserved. |
| 6-0 RX_CH_FILT_H5 | RX Channel Filter Coefficient 5 RX Channel Filter Coefficient 5, 7-bit signed fractional |

45.2.2.3.67 Receive Channel Filter Coefficient 6 (RX_CHF_COEF_6)

45.2.2.3.67.1 Offset

| Register | Offset |
|---------------|-----------|
| RX_CHF_COEF_6 | 4005C1B8h |

45.2.2.3.67.2 Diagram

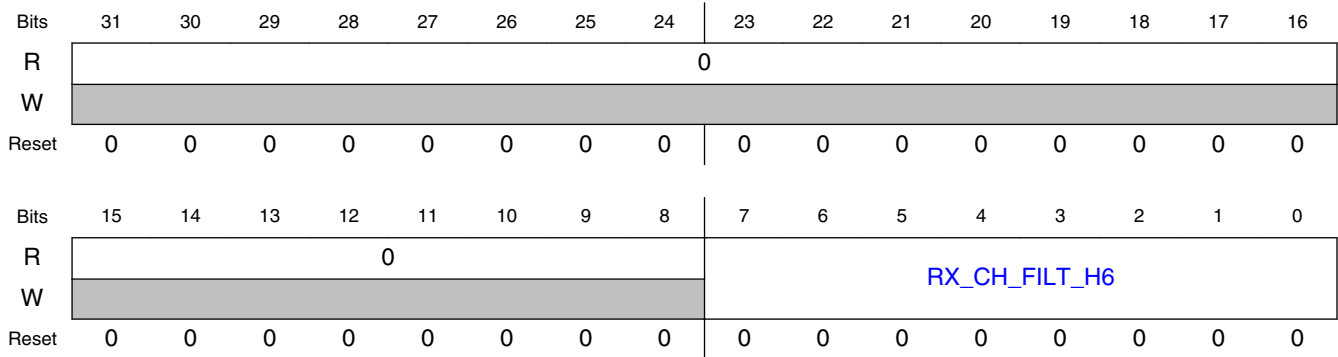

45.2.2.3.67.3 Fields

| Field | Function |
|----------------------|---|
| 31-8 Reserved | Reserved. |
| 7-0 RX_CH_FILT_H6 | RX Channel Filter Coefficient 6 RX Channel Filter Coefficient 6, 8-bit signed fractional |

45.2.2.3.68 Receive Channel Filter Coefficient 7 (RX_CHF_COEF_7)

45.2.2.3.68.1 Offset

| Register | Offset |
|---------------|-----------|
| RX_CHF_COEF_7 | 4005C1BCh |

45.2.2.3.68.2 Diagram

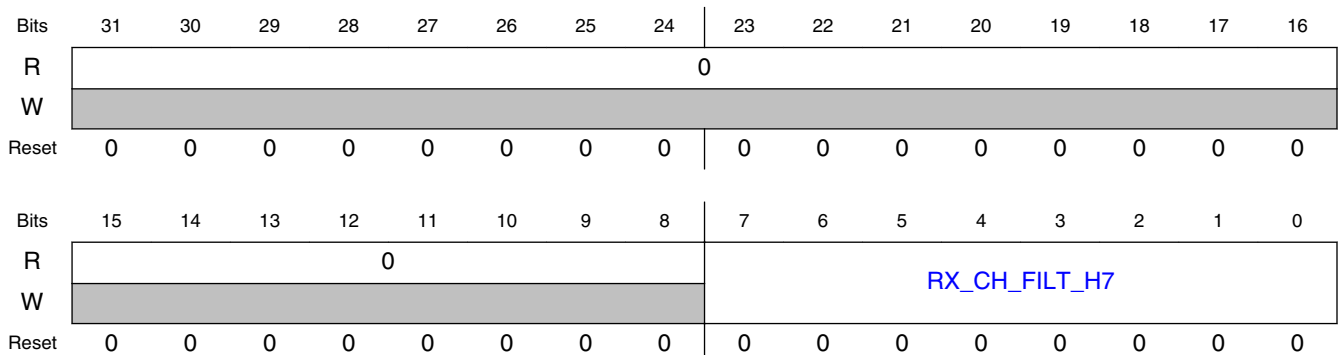

45.2.2.3.68.3 Fields

| Field | Function |
|--------------------------|---|
| 31-8 Reserved | Reserved. |
| 7-0 RX_CH_FILT_H 7 | RX Channel Filter Coefficient 7 RX Channel Filter Coefficient 7, 8-bit signed fractional |

45.2.2.3.69 Receive Channel Filter Coefficient 8 (RX_CHF_COEF_8)

45.2.2.3.69.1 Offset

| Register | Offset |
|---------------|-----------|
| RX_CHF_COEF_8 | 4005C1C0h |

45.2.2.3.69.2 Diagram

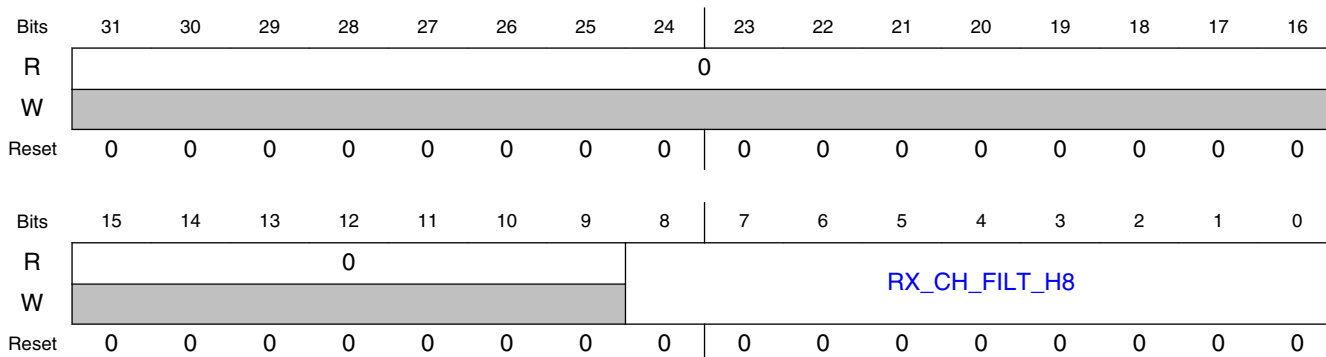

45.2.2.3.69.3 Fields

| Field | Function |
|--------------------------|---|
| 31-9 Reserved | Reserved. |
| 8-0 RX_CH_FILT_H 8 | RX Channel Filter Coefficient 8 RX Channel Filter Coefficient 8, 9-bit signed fractional |

45.2.2.3.70 Receive Channel Filter Coefficient 9 (RX_CHF_COEF_9)

45.2.2.3.70.1 Offset

| Register | Offset |
|---------------|-----------|
| RX_CHF_COEF_9 | 4005C1C4h |

45.2.2.3.70.2 Diagram

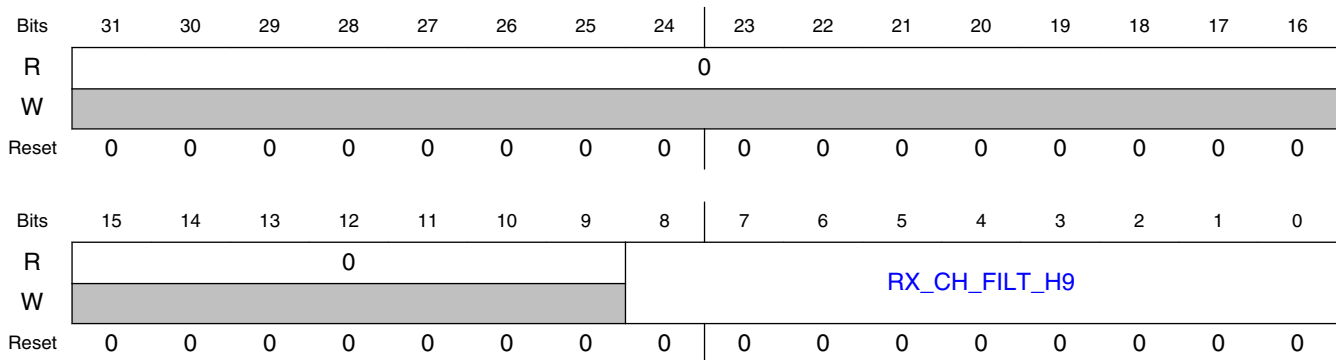

45.2.2.3.70.3 Fields

| Field | Function |
|--------------------------|---|
| 31-9 Reserved | Reserved. |
| 8-0 RX_CH_FILT_H 9 | RX Channel Filter Coefficient 9 RX Channel Filter Coefficient 9, 9-bit signed fractional |

45.2.2.3.71 Receive Channel Filter Coefficient 10 (RX_CHF_COEF_10)

45.2.2.3.71.1 Offset

| Register | Offset |
|----------------|-----------|
| RX_CHF_COEF_10 | 4005C1C8h |

45.2.2.3.71.2 Diagram

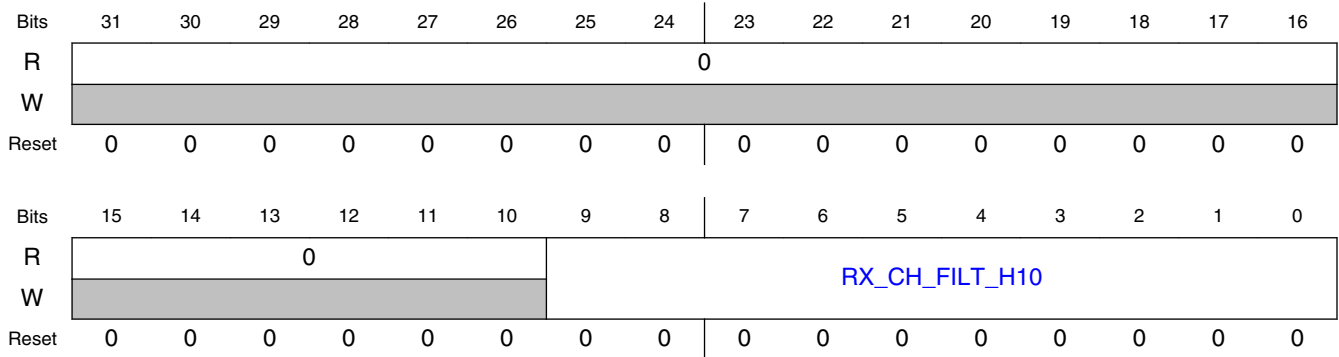

45.2.2.3.71.3 Fields

| Field | Function |
|-----------------------|--|
| 31-10 Reserved | Reserved. |
| 9-0 RX_CH_FILT_H10 | RX Channel Filter Coefficient 10 RX Channel Filter Coefficient 10, 10-bit signed fractional |

45.2.2.3.72 Receive Channel Filter Coefficient 11 (RX_CHF_COEF_11)

45.2.2.3.72.1 Offset

| Register | Offset |
|----------------|-----------|
| RX_CHF_COEF_11 | 4005C1CCh |

45.2.2.3.72.2 Diagram

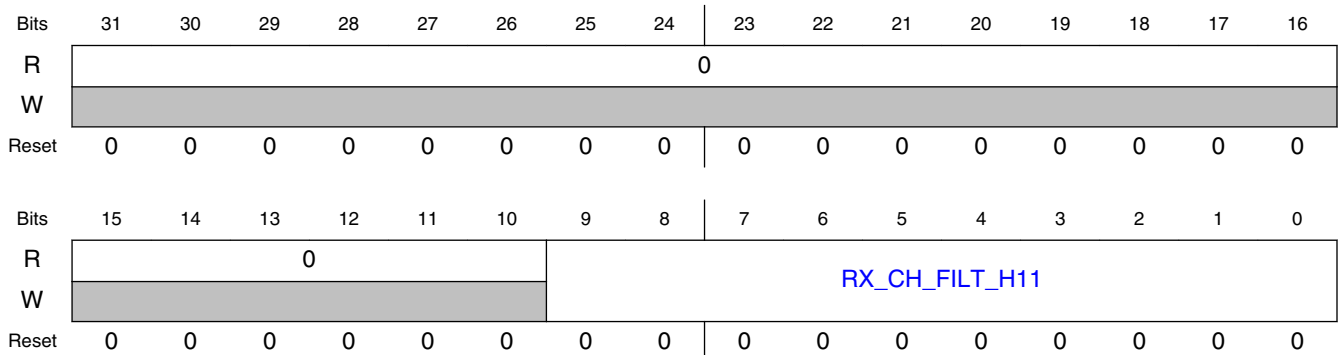

45.2.2.3.72.3 Fields

| Field | Function |
|---------------------------|--|
| 31-10 Reserved | Reserved. |
| 9-0 RX_CH_FILT_H 11 | RX Channel Filter Coefficient 11 RX Channel Filter Coefficient 11, 10-bit signed fractional |

45.2.2.3.73 AGC Manual AGC Index (AGC_MAN_AGC_IDX)

45.2.2.3.73.1 Offset

| Register | Offset |
|-----------------|-----------|
| AGC_MAN_AGC_IDX | 4005C1D0h |

45.2.2.3.73.2 Diagram

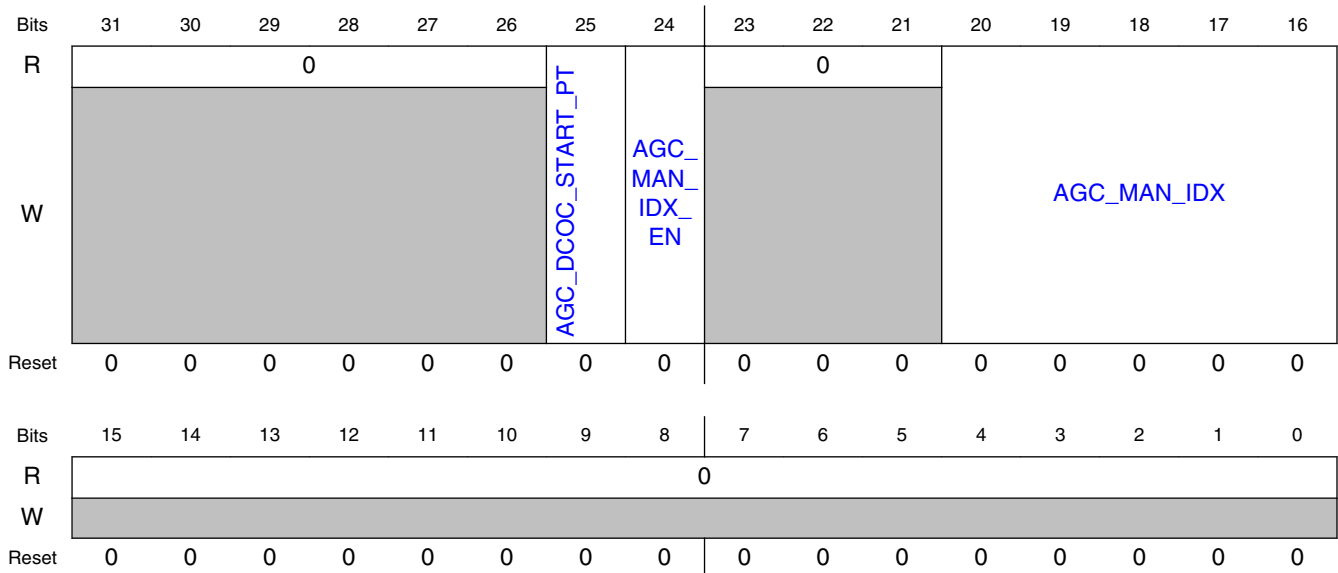

45.2.2.3.73.3 Fields

| Field | Function |
|-------------------------|--|
| 31-26 — | Reserved. |
| 25 AGC_DCOC_START_PT | AGC DCOC Start Point When set, the starting value for the AGC gain table index after DCOC calibration will be AGC_MAN_IDX instead of index 26. |
| 24 AGC_MAN_IDX_EN | AGC Manual Index Enable When set, the AGC gain table index is overridden using AGC_MAN_IDX. |
| 23-21 — | Reserved. |
| 20-16 AGC_MAN_IDX | AGC Manual Index AGC gain table index override value (when AGC_MAN_IDX_EN is set), or AGC gain table index starting point after DCOC calibration (when AGC_DCOC_START_PT is set). |
| 15-0 — | Reserved. |

45.2.2.3.74 DC Residual Control (DC_RESID_CTRL)**45.2.2.3.74.1 Offset**

| Register | Offset |
|---------------|-----------|
| DC_RESID_CTRL | 4005C1D4h |

45.2.2.3.74.2 Diagram

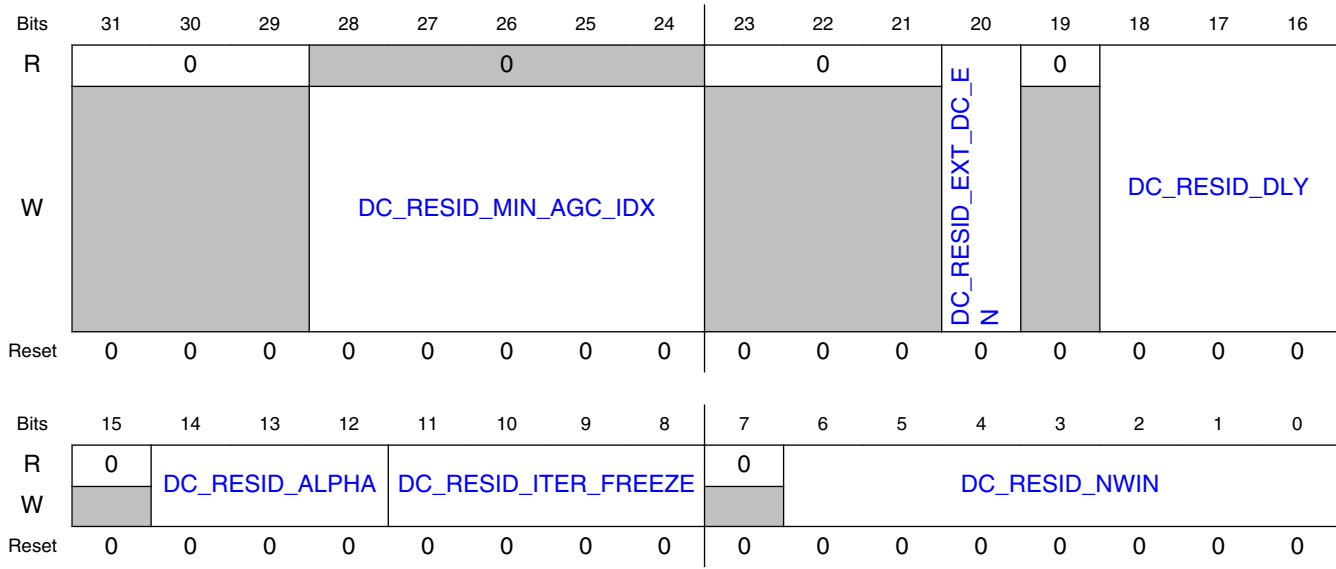

45.2.2.3.74.3 Fields

| Field | Function |
|-------------------------------|--|
| 31-29 — | Reserved. |
| 28-24 DC_RESID_MIN_AGC_IDX | DC Residual Minimum AGC Table Index Specifies the minimum AGC table index value at which DC residual can be enabled. E.g., if this is 5'd0, then the DC residual is enabled for all AGC gain table indexes (assuming RX_DC_RESID_EN is set) if this is 5'd20, then tracking is enabled for AGC gain table indexes 20-26 (assuming RX_DC_RESID_EN is set). |
| 23-21 — | Reserved. |
| 20 DC_RESID_EXT_DC_EN | DC Residual External DC Enable 0b - External DC disable. The DC Residual activates at a delay specified by DC_RESID_DLY after an AGC gain change pulse. The DC Residual is initialized with a DC offset of 0. 1b - External DC enable. The DC residual activates after the DCOC's tracking hold timer expires. The DC Residual is initialized with the DC estimate from the DCOC tracking estimator. |
| 19 — | Reserved. |
| 18-16 DC_RESID_DLY | DC Residual Delay The delay from activation of the DC residual block to the time when it starts processing. For a 32MHz reference clock, the delay in microseconds matches the value programmed. For other clock frequencies, the delay is scaled based on the clock period. Supported values: 0-7. This delay is only used when EXT_DC_EN=0. |
| 15 — | Reserved. |
| 14-12 | DC Residual Alpha |

Table continues on the next page...

Radio Register Overview

| Field | Function |
|----------------------|---|
| DC_RESID_ALPHA | The Alpha parameter controls the rate at which the DC estimate is updated. The update factor is $2^{-(\text{Alpha})}$. |
| 11-8 | DC Residual Iteration Freeze |
| DC_RESID_ITER_FREEZE | Number of windows of DC_RESID_NWIN samples before the DC is frozen. Supported values: 1-8 |
| 7 — | Reserved. |
| 6-0 | DC Residual NWIN |
| DC_RESID_NWIN | Number of samples in a window. |

45.2.2.3.75 DC Residual Estimate (DC_RESID_EST)

45.2.2.3.75.1 Offset

| Register | Offset |
|--------------|-----------|
| DC_RESID_EST | 4005C1D8h |

45.2.2.3.75.2 Diagram

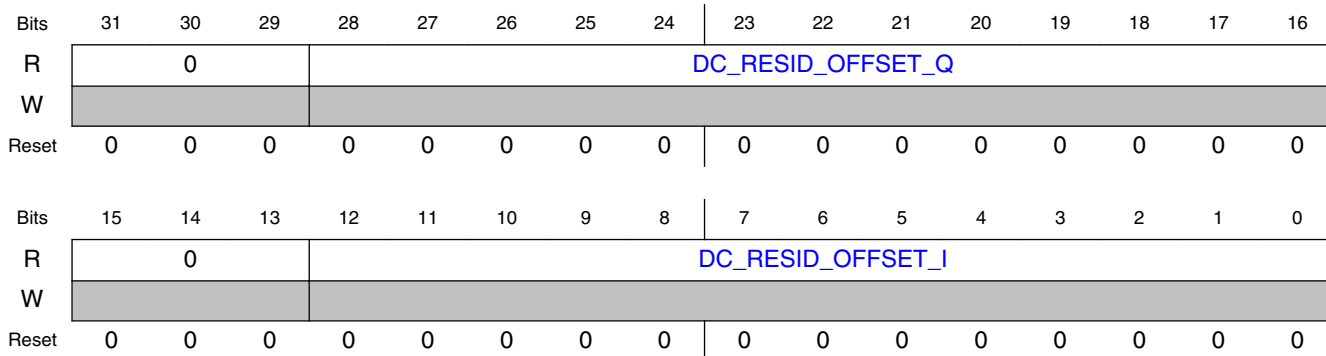

45.2.2.3.75.3 Fields

| Field | Function |
|------------|----------------------|
| 31-29 — | Reserved. |
| 28-16 | DC Residual Offset Q |

Table continues on the next page...

| Field | Function |
|-------------------------------|---|
| DC_RESID_OF FSET_Q | Reflects the current DC residual offset estimate for Q channel. Format is s11.1. This is provided for debug and characterization purposes only. |
| 15-13 — | Reserved. |
| 12-0 DC_RESID_OF FSET_I | DC Residual Offset I Reflects the current DC residual offset estimate for I channel. Format is s11.1. This is provided for debug and characterization purposes only. |

45.2.2.3.76 RX RC Calibration Control0 (RX_RCCAL_CTRL0)

45.2.2.3.76.1 Offset

| Register | Offset |
|----------------|-----------|
| RX_RCCAL_CTRL0 | 4005C1DCh |

45.2.2.3.76.2 Diagram

| | | | | | | | | | | | | | | | | |
|-------|------|----|----------|----|----|-------|-------|------------------|----|----|----|------------------|----|----|----|----|
| Bits | 31 | 30 | 29 | 28 | 27 | 26 | 25 | 24 | 23 | 22 | 21 | 20 | 19 | 18 | 17 | 16 |
| R | 0 | | | | | | TZA_ | TZA_RCCAL_MANUAL | | | | TZA_RCCAL_OFFSET | | | | |
| W | — | | | | | | RCC | — | | | | — | | | | |
| | — | | | | | | AL_DI | — | | | | — | | | | |
| | — | | | | | | S | — | | | | — | | | | |
| Reset | 0 | 0 | 0 | 0 | 0 | 0 | 0 | 0 | 0 | 0 | 0 | 0 | 0 | 0 | 0 | 0 |
| Bits | 15 | 14 | 13 | 12 | 11 | 10 | 9 | 8 | 7 | 6 | 5 | 4 | 3 | 2 | 1 | 0 |
| R | RCC | 0 | RCCAL_SM | | 0 | | BBA_ | BBA_RCCAL_MANUAL | | | | BBA_RCCAL_OFFSET | | | | |
| W | AL_C | — | P_DLY | | — | | RCC | — | | | | — | | | | |
| | OMP | — | | — | | AL_DI | — | | | | — | | | | | |
| | _INV | — | | — | | S | — | | | | — | | | | | |
| Reset | 0 | 0 | 0 | 0 | 0 | 0 | 0 | 0 | 0 | 0 | 0 | 0 | 0 | 0 | 0 | 0 |

45.2.2.3.76.3 Fields

| Field | Function |
|-------------------------|---|
| 31-26 — | Reserved. |
| 25 TZA_RCCAL_DI S | TZA RC Calibration Disable 0b - TZA RC Calibration is enabled 1b - TZA RC Calibration is disabled |

Table continues on the next page...

Radio Register Overview

| Field | Function |
|-------------------------------|---|
| 24-20 TZA_RCCAL_M ANUAL | TZA RC Calibration manual value If TZA_RCCAL_DIS bit is set, this value is used for the TZA calibration. |
| 19-16 TZA_RCCAL_O FFSET | TZA RC Calibration value offset Offset added to the RC Calibration code to determine the calibration value used for the TZA. Format is s3. |
| 15 RCCAL_COMP _INV | RC Calibration comp_out Invert 0b - The comp_out signal polarity is NOT inverted 1b - The comp_out signal polarity is inverted |
| 14 — | Reserved. |
| 13-12 RCCAL_SMP_D LY | RC Calibration Sample Delay 00b - The comp_out signal is sampled 0 clk cycle after sample signal is deasserted 01b - The comp_out signal is sampled 1 clk cycle after sample signal is deasserted 10b - The comp_out signal is sampled 2 clk cycle after sample signal is deasserted 11b - The comp_out signal is sampled 3 clk cycle after sample signal is deasserted |
| 11-10 — | Reserved. |
| 9 BBA_RCCAL_D IS | BBA RC Calibration Disable 0b - BBA RC Calibration is enabled 1b - BBA RC Calibration is disabled |
| 8-4 BBA_RCCAL_M ANUAL | BBA RC Calibration manual value If BBA_RCCAL_DIS bit is set, this value is used for the BBA calibration. |
| 3-0 BBA_RCCAL_O FFSET | BBA RC Calibration value offset Offset added to the RC Calibration code to determine the calibration value used for the BBA. Format is s3. |

45.2.2.3.77 RX RC Calibration Control1 (RX_RCCAL_CTRL1)

45.2.2.3.77.1 Offset

| Register | Offset |
|----------------|-----------|
| RX_RCCAL_CTRL1 | 4005C1E0h |

45.2.2.3.77.2 Diagram

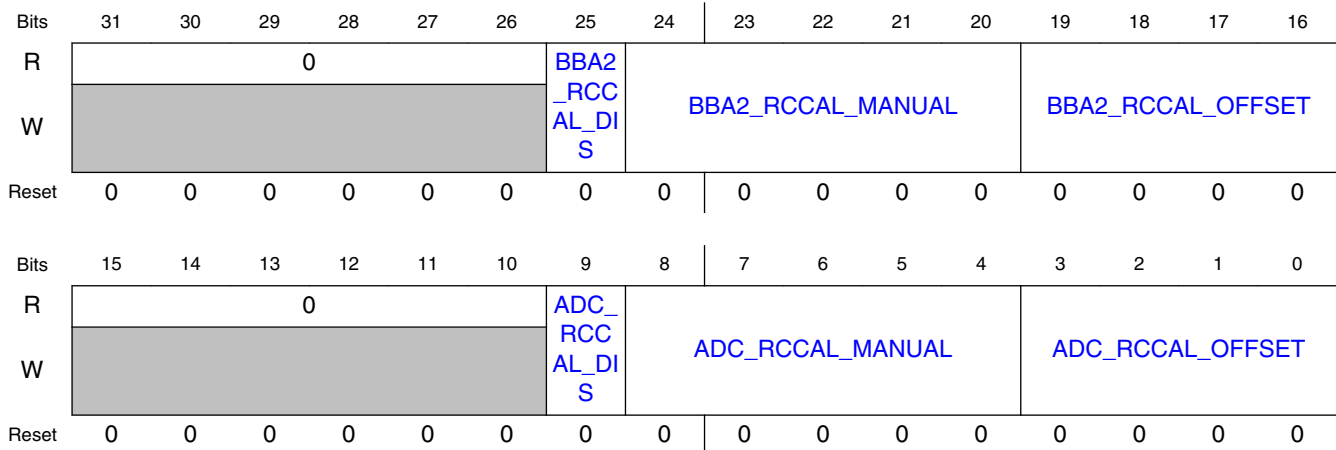

45.2.2.3.77.3 Fields

| Field | Function |
|----------------------------|---|
| 31-26 — | Reserved. |
| 25 BBA2_RCCAL_DIS | BBA2 RC Calibration Disable 0b - BBA2 RC Calibration is enabled 1b - BBA2 RC Calibration is disabled |
| 24-20 BBA2_RCCAL_MANUAL | BBA2 RC Calibration manual value If BBA2_RCCAL_DIS bit is set, this value is used for the BBA2 calibration. |
| 19-16 BBA2_RCCAL_OFFSET | BBA2 RC Calibration value offset Offset added to the RC Calibration code to determine the calibration value used for the BBA2. Format is s3. |
| 15-10 — | Reserved. |
| 9 ADC_RCCAL_DIS | ADC RC Calibration Disable 0b - ADC RC Calibration is enabled 1b - ADC RC Calibration is disabled |
| 8-4 ADC_RCCAL_MANUAL | ADC RC Calibration manual value If ADC_RCCAL_DIS bit is set, this value is used for the ADC calibration. |
| 3-0 ADC_RCCAL_OFFSET | ADC RC Calibration value offset Offset added to the RC Calibration code to determine the calibration value used for the ADC. Format is s3. |

45.2.2.3.78 RX RC Calibration Status (RX_RCCAL_STAT)

45.2.2.3.78.1 Offset

| Register | Offset |
|---------------|-----------|
| RX_RCCAL_STAT | 4005C1E4h |

45.2.2.3.78.2 Diagram

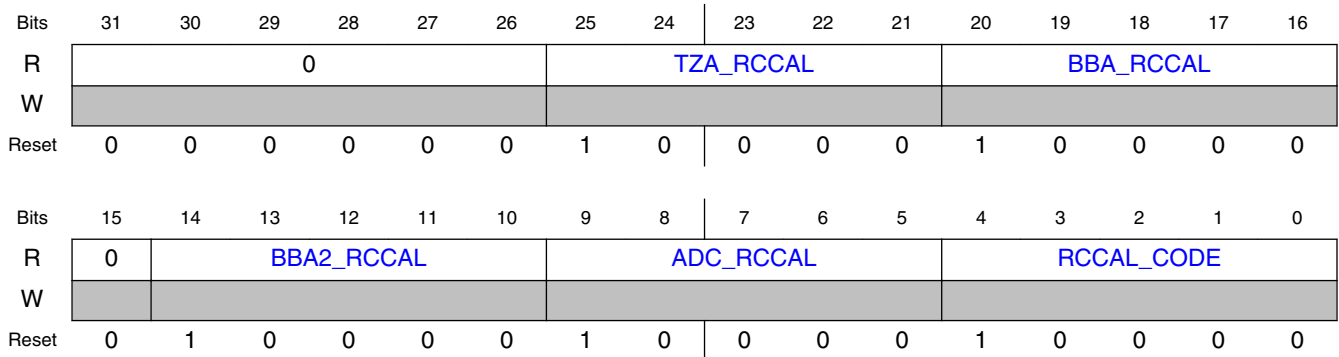

45.2.2.3.78.3 Fields

| Field | Function |
|---------------------|---|
| 31-26 — | Reserved. |
| 25-21 TZA_RCCAL | TZA RC Calibration The RC Calibration value used for TZA |
| 20-16 BBA_RCCAL | BBA RC Calibration The RC Calibration value used for BBA |
| 15 — | Reserved. |
| 14-10 BBA2_RCCAL | BBA2 RC Calibration The RC Calibration value used for BBA2 |
| 9-5 ADC_RCCAL | ADC RC Calibration The RC Calibration value used for ADC |
| 4-0 RCCAL_CODE | RC Calibration code The RC Calibration code currently applied to the calibration circuit |

45.2.2.3.79 Aux PLL Frequency Calibration Control (AUXPLL_FCAL_CTRL)

45.2.2.3.79.1 Offset

| Register | Offset |
|------------------|-----------|
| AUXPLL_FCAL_CTRL | 4005C1E8h |

45.2.2.3.79.2 Diagram

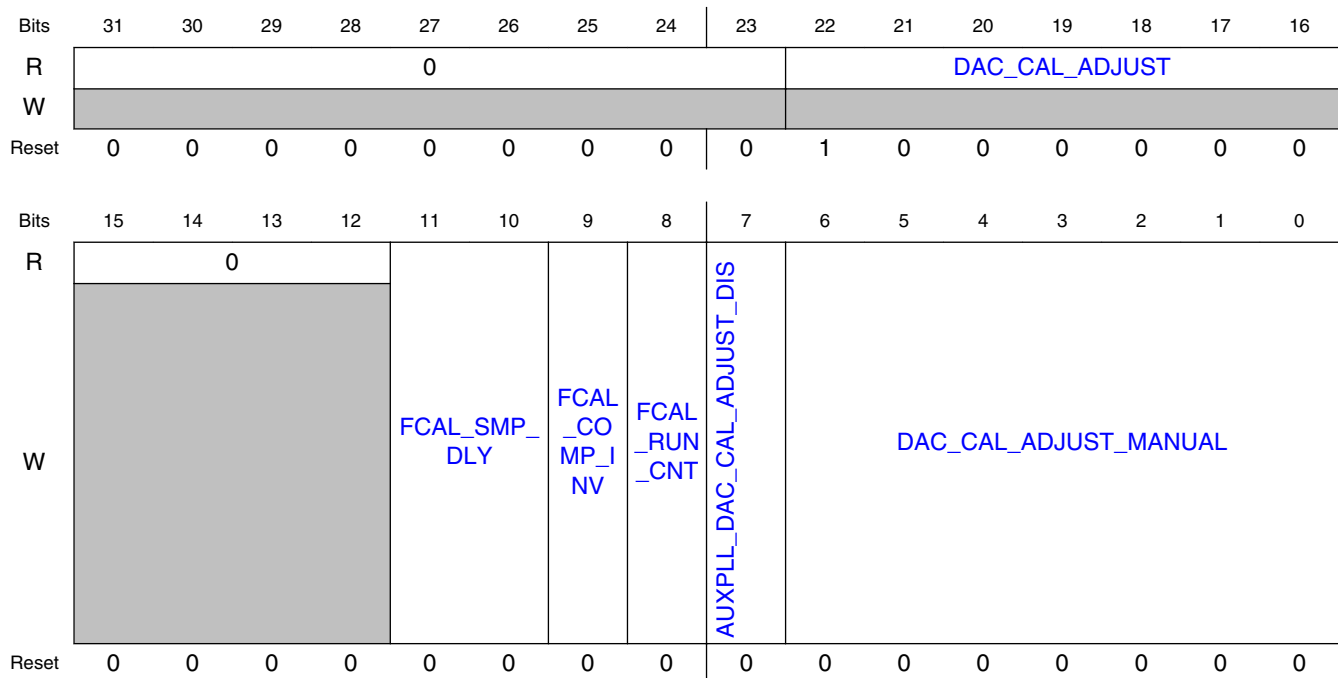

45.2.2.3.79.3 Fields

| Field | Function |
|-------------------------|---|
| 31-23 — | Reserved. |
| 22-16 DAC_CAL_ADJUST | Aux PLL DAC Calibration Adjust value The DAC calibration adjust value applied to the calibration circuit. |
| 15-12 — | Reserved. |
| 11-10 | Aux PLL Frequency Calibration Sample Delay 00b - The count signal is sampled 1 clk cycle after fcal_run signal is deasserted |

Table continues on the next page...

Radio Register Overview

| Field | Function |
|---------------------------|---|
| FCAL_SMP_DLY | 01b - The count signal is sampled 2 clk cycle after fcal_run signal is deasserted 10b - The count signal is sampled 3 clk cycle after fcal_run signal is deasserted 11b - The count signal is sampled 4 clk cycle after fcal_run signal is deasserted |
| FCAL_COMP_INV | Aux PLL Frequency Calibration Comparison Invert 0b - (Default) The comparison associated with the count is not inverted. 1b - The comparison associated with the count is inverted |
| FCAL_RUN_CNT | Aux PLL Frequency Calibration Run Count 0b - Run count is 256 clock cycles 1b - Run count is 512 clock cycles |
| AUXPLL_DAC_CAL_ADJUST_DIS | Aux PLL Frequency Calibration Disable 0b - Calibration is enabled 1b - Calibration is disabled |
| DAC_CAL_ADJUST_MANUAL | Aux PLL Frequency DAC Calibration Adjust Manual value If AUXPLL_DAC_CAL_ADJUST_DIS bit is set, this DAC calibration adjust value is applied to the calibration circuit. |

45.2.2.3.80 Aux PLL Frequency Calibration Count 6 (AUXPLL_FCAL_CNT6)

45.2.2.3.80.1 Offset

| Register | Offset |
|------------------|-----------|
| AUXPLL_FCAL_CNT6 | 4005C1ECh |

45.2.2.3.80.2 Diagram

| | | | | | | | | | | | | | | | | |
|-------|----------|----|----|----|----|----|----|----|---------------|----|----|----|----|----|----|----|
| Bits | 31 | 30 | 29 | 28 | 27 | 26 | 25 | 24 | 23 | 22 | 21 | 20 | 19 | 18 | 17 | 16 |
| R | 0 | | | | | | | | FCAL_BESTDIFF | | | | | | | |
| W | [Shaded] | | | | | | | | | | | | | | | |
| Reset | 0 | 0 | 0 | 0 | 0 | 0 | 0 | 0 | 0 | 0 | 0 | 0 | 0 | 0 | 0 | 0 |
| Bits | 15 | 14 | 13 | 12 | 11 | 10 | 9 | 8 | 7 | 6 | 5 | 4 | 3 | 2 | 1 | 0 |
| R | 0 | | | | | | | | FCAL_COUNT_6 | | | | | | | |
| W | [Shaded] | | | | | | | | | | | | | | | |
| Reset | 0 | 0 | 0 | 0 | 0 | 0 | 0 | 0 | 0 | 0 | 0 | 0 | 0 | 0 | 0 | 0 |

45.2.2.3.80.3 Fields

| Field | Function |
|----------------------------|---|
| 31-26 — | Reserved. |
| 25-16 FCAL_BESTDIF F | Aux PLL Frequency Calibration Best Difference The smallest absolute difference between the count value output by the calibration circuit and the expected count value found during the calibration sequence. |
| 15-10 — | Reserved. |
| 9-0 FCAL_COUNT_ 6 | Aux PLL Frequency Calibration Count 6 The count value output by the calibration circuit for calibration phase 6. |

45.2.2.3.81 Aux PLL Frequency Calibration Count 5 and 4 (AUXPLL_FCAL_CNT5_4)

45.2.2.3.81.1 Offset

| Register | Offset |
|--------------------|-----------|
| AUXPLL_FCAL_CNT5_4 | 4005C1F0h |

45.2.2.3.81.2 Diagram

| | | | | | | | | | | | | | | | | |
|-------|----------|----|----|----|----|----|----|----|--------------|----|----|----|----|----|----|----|
| Bits | 31 | 30 | 29 | 28 | 27 | 26 | 25 | 24 | 23 | 22 | 21 | 20 | 19 | 18 | 17 | 16 |
| R | 0 | | | | | | | | FCAL_COUNT_5 | | | | | | | |
| W | [Shaded] | | | | | | | | | | | | | | | |
| Reset | 0 | 0 | 0 | 0 | 0 | 0 | 0 | 0 | 0 | 0 | 0 | 0 | 0 | 0 | 0 | 0 |
| Bits | 15 | 14 | 13 | 12 | 11 | 10 | 9 | 8 | 7 | 6 | 5 | 4 | 3 | 2 | 1 | 0 |
| R | 0 | | | | | | | | FCAL_COUNT_4 | | | | | | | |
| W | [Shaded] | | | | | | | | | | | | | | | |
| Reset | 0 | 0 | 0 | 0 | 0 | 0 | 0 | 0 | 0 | 0 | 0 | 0 | 0 | 0 | 0 | 0 |

45.2.2.3.81.3 Fields

| Field | Function |
|-------|-----------|
| 31-26 | Reserved. |

Table continues on the next page...

Radio Register Overview

| Field | Function |
|-----------------------|---|
| — | |
| 25-16 FCAL_COUNT_5 | Aux PLL Frequency Calibration Count 5 The count value output by the calibration circuit for calibration phase 5. |
| 15-10 — | Reserved. |
| 9-0 FCAL_COUNT_4 | Aux PLL Frequency Calibration Count 4 The count value output by the calibration circuit for calibration phase 4. |

45.2.2.3.82 Aux PLL Frequency Calibration Count 3 and 2 (AUXPLL_FCAL_CNT3_2)

45.2.2.3.82.1 Offset

| Register | Offset |
|--------------------|-----------|
| AUXPLL_FCAL_CNT3_2 | 4005C1F4h |

45.2.2.3.82.2 Diagram

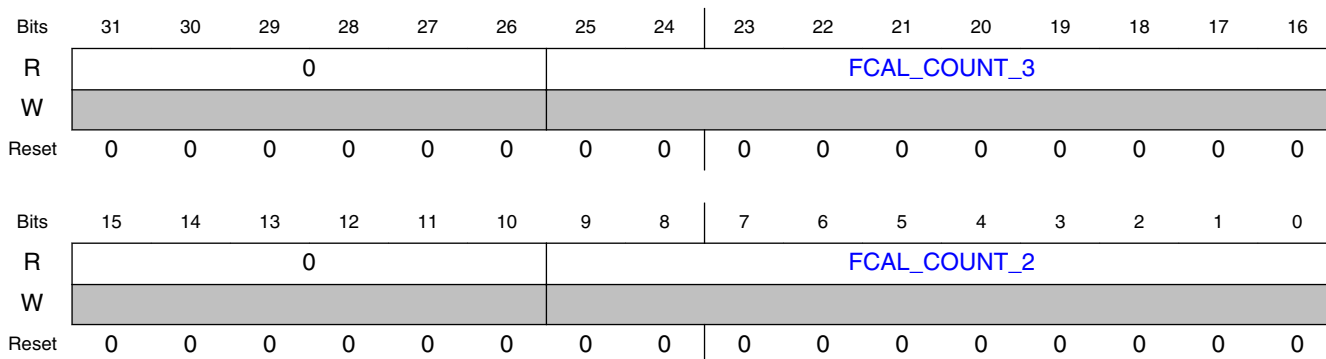

45.2.2.3.82.3 Fields

| Field | Function |
|------------|---|
| 31-26 — | Reserved. |
| 25-16 | Aux PLL Frequency Calibration Count 3 The count value output by the calibration circuit for calibration phase 3. |

Table continues on the next page...

| Field | Function |
|---------------------|---|
| FCAL_COUNT_3 | |
| 15-10 — | Reserved. |
| 9-0 FCAL_COUNT_2 | Aux PLL Frequency Calibration Count 2 The count value output by the calibration circuit for calibration phase 2. |

45.2.2.3.83 Aux PLL Frequency Calibration Count 1 and 0 (AUXPLL_FCAL_CNT1_0)

45.2.2.3.83.1 Offset

| Register | Offset |
|--------------------|-----------|
| AUXPLL_FCAL_CNT1_0 | 4005C1F8h |

45.2.2.3.83.2 Diagram

| | | | | | | | | | | | | | | | | |
|-------|----|----|----|----|----|----|----|----|--------------|----|----|----|----|----|----|----|
| Bits | 31 | 30 | 29 | 28 | 27 | 26 | 25 | 24 | 23 | 22 | 21 | 20 | 19 | 18 | 17 | 16 |
| R | 0 | | | | | | | | FCAL_COUNT_1 | | | | | | | |
| W | — | | | | | | | | | | | | | | | |
| Reset | 0 | 0 | 0 | 0 | 0 | 0 | 0 | 0 | 0 | 0 | 0 | 0 | 0 | 0 | 0 | 0 |
| Bits | 15 | 14 | 13 | 12 | 11 | 10 | 9 | 8 | 7 | 6 | 5 | 4 | 3 | 2 | 1 | 0 |
| R | 0 | | | | | | | | FCAL_COUNT_0 | | | | | | | |
| W | — | | | | | | | | | | | | | | | |
| Reset | 0 | 0 | 0 | 0 | 0 | 0 | 0 | 0 | 0 | 0 | 0 | 0 | 0 | 0 | 0 | 0 |

45.2.2.3.83.3 Fields

| Field | Function |
|-----------------------|---|
| 31-26 — | Reserved. |
| 25-16 FCAL_COUNT_1 | Frequency Calibration Count 1 The count value output by the calibration circuit for calibration phase 1. |
| 15-10 | Reserved. |

Table continues on the next page...

Radio Register Overview

| Field | Function |
|---------------------|---|
| — | |
| 9-0 FCAL_COUNT_0 | Frequency Calibration Count 0 The count value output by the calibration circuit for calibration phase 0. |

45.2.2.4 XCVR_TSM Register Descriptions

45.2.2.4.1 XCVR_TSM_ADDR Memory Map

Base address: 4005C2C0h

| Offset | Register | Width (In bits) | Access | Reset value |
|-----------|---|--------------------|--------|-------------|
| 4005C2C0h | TRANSCEIVER SEQUENCE MANAGER CONTROL (CTRL) | 32 | RW | FF004000h |
| 4005C2C4h | TSM END OF SEQUENCE (END_OF_SEQ) | 32 | RW | 67666A63h |
| 4005C2C8h | TSM OVERRIDE REGISTER 0 (OVRD0) | 32 | RW | 00000000h |
| 4005C2CCh | TSM OVERRIDE REGISTER 1 (OVRD1) | 32 | RW | 00000000h |
| 4005C2D0h | TSM OVERRIDE REGISTER 2 (OVRD2) | 32 | RW | 00000000h |
| 4005C2D4h | TSM OVERRIDE REGISTER 3 (OVRD3) | 32 | RW | 00000000h |
| 4005C2D8h | PA POWER (PA_POWER) | 32 | RW | 00000000h |
| 4005C2DCh | PA RAMP TABLE 0 (PA_RAMP_TBL0) | 32 | RW | 10080402h |
| 4005C2E0h | PA RAMP TABLE 1 (PA_RAMP_TBL1) | 32 | RW | 3A342A1Ch |
| 4005C2E4h | TSM RECYCLE COUNT (RECYCLE_COUNT) | 32 | RW | 001A0464h |
| 4005C2E8h | TSM FAST WARMUP CONTROL REGISTER 1 (FAST_CTRL1) | 32 | RW | 0000FF00h |
| 4005C2ECh | TSM FAST WARMUP CONTROL REGISTER 2 (FAST_CTRL2) | 32 | RW | FFFFFFFFh |
| 4005C2F0h | TSM_TIMING00 (TIMING00) | 32 | RW | 67006A00h |
| 4005C2F4h | TSM_TIMING01 (TIMING01) | 32 | RW | 67006A00h |
| 4005C2F8h | TSM_TIMING02 (TIMING02) | 32 | RW | 6700FFFFh |
| 4005C2FCh | TSM_TIMING03 (TIMING03) | 32 | RW | 67006A00h |
| 4005C300h | TSM_TIMING04 (TIMING04) | 32 | RW | 67006A00h |
| 4005C304h | TSM_TIMING05 (TIMING05) | 32 | RW | 67006A00h |
| 4005C308h | TSM_TIMING06 (TIMING06) | 32 | RW | 67006A00h |
| 4005C30Ch | TSM_TIMING07 (TIMING07) | 32 | RW | 05000500h |
| 4005C310h | TSM_TIMING08 (TIMING08) | 32 | RW | 03000300h |
| 4005C314h | TSM_TIMING09 (TIMING09) | 32 | RW | 03000300h |
| 4005C318h | TSM_TIMING10 (TIMING10) | 32 | RW | 67036A03h |
| 4005C31Ch | TSM_TIMING11 (TIMING11) | 32 | RW | FFFF6A03h |

Table continues on the next page...

| Offset | Register | Width (In bits) | Access | Reset value |
|-----------|-------------------------|--------------------|--------|-------------|
| 4005C320h | TSM_TIMING12 (TIMING12) | 32 | RW | 6703FFFFh |
| 4005C324h | TSM_TIMING13 (TIMING13) | 32 | RW | 16004A00h |
| 4005C328h | TSM_TIMING14 (TIMING14) | 32 | RW | 672F645Fh |
| 4005C32Ch | TSM_TIMING15 (TIMING15) | 32 | RW | 67036A03h |
| 4005C330h | TSM_TIMING16 (TIMING16) | 32 | RW | 671AFFFFh |
| 4005C334h | TSM_TIMING17 (TIMING17) | 32 | RW | FFFF6A5Ah |
| 4005C338h | TSM_TIMING18 (TIMING18) | 32 | RW | 67056A05h |
| 4005C33Ch | TSM_TIMING19 (TIMING19) | 32 | RW | 16054A05h |
| 4005C340h | TSM_TIMING20 (TIMING20) | 32 | RW | 67056A05h |
| 4005C344h | TSM_TIMING21 (TIMING21) | 32 | RW | 67046A04h |
| 4005C348h | TSM_TIMING22 (TIMING22) | 32 | RW | 6704FFFFh |
| 4005C34Ch | TSM_TIMING23 (TIMING23) | 32 | RW | FFFF6A04h |
| 4005C350h | TSM_TIMING24 (TIMING24) | 32 | RW | 16004A00h |
| 4005C354h | TSM_TIMING25 (TIMING25) | 32 | RW | 671BFFFFh |
| 4005C358h | TSM_TIMING26 (TIMING26) | 32 | RW | FFFF6A5Ah |
| 4005C35Ch | TSM_TIMING27 (TIMING27) | 32 | RW | 671EFFFFh |
| 4005C360h | TSM_TIMING28 (TIMING28) | 32 | RW | 1F1EFFFFh |
| 4005C364h | TSM_TIMING29 (TIMING29) | 32 | RW | 671CFFFFh |
| 4005C368h | TSM_TIMING30 (TIMING30) | 32 | RW | 671EFFFFh |
| 4005C36Ch | TSM_TIMING31 (TIMING31) | 32 | RW | 671DFFFFh |
| 4005C370h | TSM_TIMING32 (TIMING32) | 32 | RW | 671BFFFFh |
| 4005C374h | TSM_TIMING33 (TIMING33) | 32 | RW | 671EFFFFh |
| 4005C378h | TSM_TIMING34 (TIMING34) | 32 | RW | 67056A05h |
| 4005C37Ch | TSM_TIMING35 (TIMING35) | 32 | RW | FFFF6A5Dh |
| 4005C380h | TSM_TIMING36 (TIMING36) | 32 | RW | 6764FFFFh |
| 4005C384h | TSM_TIMING37 (TIMING37) | 32 | RW | 6564FFFFh |
| 4005C388h | TSM_TIMING38 (TIMING38) | 32 | RW | 670C6A40h |
| 4005C38Ch | TSM_TIMING39 (TIMING39) | 32 | RW | 6764FFFFh |
| 4005C390h | TSM_TIMING40 (TIMING40) | 32 | RW | 6724FFFFh |
| 4005C394h | TSM_TIMING41 (TIMING41) | 32 | RW | 2524FFFFh |
| 4005C398h | TSM_TIMING42 (TIMING42) | 32 | RW | FFFFFFFFh |
| 4005C39Ch | TSM_TIMING43 (TIMING43) | 32 | RW | FFFFFFFFh |
| 4005C3A0h | TSM_TIMING44 (TIMING44) | 32 | RW | FFFFFFFFh |
| 4005C3A4h | TSM_TIMING45 (TIMING45) | 32 | RW | FFFFFFFFh |
| 4005C3A8h | TSM_TIMING46 (TIMING46) | 32 | RW | FFFFFFFFh |
| 4005C3ACh | TSM_TIMING47 (TIMING47) | 32 | RW | FFFFFFFFh |
| 4005C3B0h | TSM_TIMING48 (TIMING48) | 32 | RW | FFFFFFFFh |
| 4005C3B4h | TSM_TIMING49 (TIMING49) | 32 | RW | FFFFFFFFh |
| 4005C3B8h | TSM_TIMING50 (TIMING50) | 32 | RW | FFFFFFFFh |
| 4005C3BCh | TSM_TIMING51 (TIMING51) | 32 | RW | 6703FFFFh |

Table continues on the next page...

Radio Register Overview

| Offset | Register | Width (In bits) | Access | Reset value |
|-----------|---|--------------------|--------|-------------|
| 4005C3C0h | TSM_TIMING52 (TIMING52) | 32 | RW | 1504FFFFh |
| 4005C3C4h | TSM_TIMING53 (TIMING53) | 32 | RW | 6704FFFFh |
| 4005C3C8h | TSM_TIMING54 (TIMING54) | 32 | RW | 1504FFFFh |
| 4005C3CCh | TSM_TIMING55 (TIMING55) | 32 | RW | 671EFFFFh |
| 4005C3D0h | TSM_TIMING56 (TIMING56) | 32 | RW | 671EFFFFh |
| 4005C3D4h | TSM_TIMING57 (TIMING57) | 32 | RW | 1A03FFFFh |
| 4005C3D8h | TSM_TIMING58 (TIMING58) | 32 | RW | FFFF6A03h |

45.2.2.4.2 TRANSCEIVER SEQUENCE MANAGER CONTROL (CTRL)

45.2.2.4.2.1 Address

| Register | Offset |
|----------|-----------|
| CTRL | 4005C2C0h |

45.2.2.4.2.2 Diagram

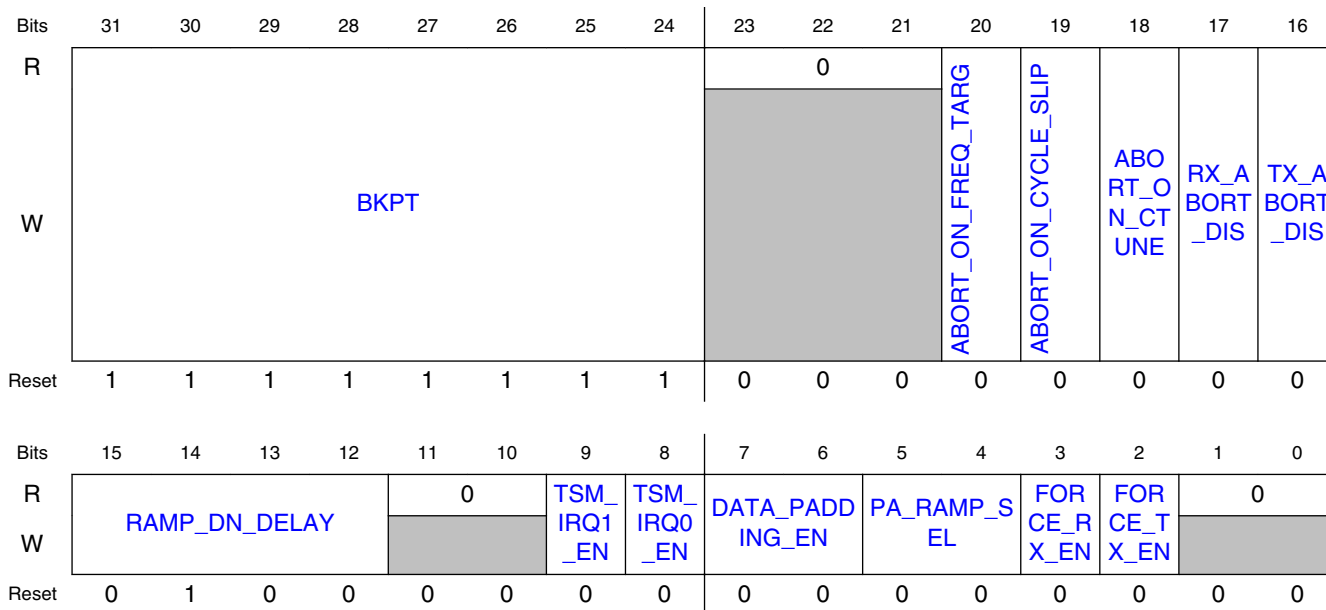

45.2.2.4.2.3 Fields

| Field | Function |
|----------------------------|--|
| 31-24 BKPT | TSM Breakpoint Temporarily halt a TSM sequence during the warmup or warmdown phase. When the TSM counter matches the value of BKPT[7:0], breakpoint will take effect and the TSM counter will stop and hold its count. Breakpoint will remain in effect as long as BKPT[7:0] matches the TSM counter value. The TSM Breakpoint can be lifted by modifying the contents of this register. The default value of this register, 0xFF, is greater than the length of the longest possible sequence, so a breakpoint will never be triggered unless BKPT[7:0] is programmed to a value less than the length of sequence. |
| 23-21 — | Reserved |
| 20 ABORT_ON_FREQ_TARG | Abort On Frequency Target Lock Detect Failure 0b - don't allow TSM abort on Frequency Target Unlock Detect 1b - allow TSM abort on Frequency Target Unlock Detect |
| 19 ABORT_ON_CYCLE_SLIP | Abort On Cycle Slip Lock Detect Failure 0b - don't allow TSM abort on Cycle Slip Unlock Detect 1b - allow TSM abort on Cycle Slip Unlock Detect |
| 18 ABORT_ON_COARSE_TUNE | Abort On Coarse Tune Lock Detect Failure 0b - don't allow TSM abort on Coarse Tune Unlock Detect 1b - allow TSM abort on Coarse Tune Unlock Detect |
| 17 RX_ABORT_DISABLE | Receive Abort Disable RX Abort disable. When set, prevents PLL unlock events during RX sequences from aborting the sequence. |
| 16 TX_ABORT_DISABLE | Transmit Abort Disable TX Abort disable. When set, prevents PLL unlock events during TX sequences from aborting the sequence. |
| 15-12 RAMP_DN_DELAY | PA Ramp Down Delay Delays the start of the PA Ramp Down, relative to the start of the TSM warmdown, by <i>N</i> microseconds, where <i>N</i> =RAMP_DN_DELAY. Range is 0 to 15us. |
| 11-10 — | Reserved |
| 9 TSM_IRQ1_EN | TSM_IRQ1 Enable/Disable bit TSM_IRQ1 Enable/Disable bit. Intended for debug purposes only. 0b - TSM_IRQ1 is disabled 1b - TSM_IRQ1 is enabled |
| 8 TSM_IRQ0_EN | TSM_IRQ0 Enable/Disable bit TSM_IRQ0 Enable/Disable bit. Intended for debug purposes only. 0b - TSM_IRQ0 is disabled 1b - TSM_IRQ0 is enabled |
| 7-6 DATA_PADDING_EN | Data Padding Enable Enables TX Data Padding. Data padding works in conjunction with PA ramping to minimize spectral transients during PA turn-on and turn-off. The nature of the data padding depends on the setting of XCVR_CTRL[PROTOCOL]. NOTE: Data Padding is not supported for Generic FSK modulations 00b - Disable TX Data Padding 01b - Enable TX Data Padding |

Table continues on the next page...

Radio Register Overview

| Field | Function | | | | | | | | | | | | | | | |
|--------------------|---|----------------------------|---------------------|----------------------------|----|---------|---------|----|-----|--------|----|-----|-------|----|-----|-----|
| 5-4 PA_RAMP_SEL | <p>PA Ramp Selection</p> <p>Selects the ramp-rate, and thus the duration, for PA ramping. Ramp-rate is the rate at which the PA ramping logic steps through the PA Ramp Table. There are always 8 ramp steps, if ramping is enabled.</p> <p>NOTE: The default TSM TX sequence needs to be adjusted (re-programmed) for a 4us or 8us ramp.</p> <table border="1"> <thead> <tr> <th>PA_RAMP_SEL[1:0]</th> <th>TOTAL RAMP DURATION</th> <th>DURATION OF EACH RAMP STEP</th> </tr> </thead> <tbody> <tr> <td>00</td> <td>No ramp</td> <td>No ramp</td> </tr> <tr> <td>01</td> <td>2us</td> <td>0.25us</td> </tr> <tr> <td>10</td> <td>4us</td> <td>0.5us</td> </tr> <tr> <td>11</td> <td>8us</td> <td>1us</td> </tr> </tbody> </table> | PA_RAMP_SEL[1:0] | TOTAL RAMP DURATION | DURATION OF EACH RAMP STEP | 00 | No ramp | No ramp | 01 | 2us | 0.25us | 10 | 4us | 0.5us | 11 | 8us | 1us |
| PA_RAMP_SEL[1:0] | TOTAL RAMP DURATION | DURATION OF EACH RAMP STEP | | | | | | | | | | | | | | |
| 00 | No ramp | No ramp | | | | | | | | | | | | | | |
| 01 | 2us | 0.25us | | | | | | | | | | | | | | |
| 10 | 4us | 0.5us | | | | | | | | | | | | | | |
| 11 | 8us | 1us | | | | | | | | | | | | | | |
| 3 FORCE_RX_EN | <p>Force Receive Enable</p> <p>Direct software control to launch a RX TSM sequence. Initiates RX Warmup on a 0 to 1 transition and RX Warmdown on a 1 to 0 transition.</p> <p>0b - TSM Idle 1b - TSM executes a RX sequence</p> | | | | | | | | | | | | | | | |
| 2 FORCE_TX_EN | <p>Force Transmit Enable</p> <p>Direct software control to launch a TX TSM sequence. Initiates a TX Warmup sequence on a 0 to 1 transition and a TX Warmdown sequence on a 1 to 0 transition.</p> <p>0b - TSM Idle 1b - TSM executes a TX sequence</p> | | | | | | | | | | | | | | | |
| 1-0 — | Reserved | | | | | | | | | | | | | | | |

45.2.2.4.3 TSM END OF SEQUENCE (END_OF_SEQ)

45.2.2.4.3.1 Address

| Register | Offset |
|------------|-----------|
| END_OF_SEQ | 4005C2C4h |

45.2.2.4.3.2 Diagram

| | | | | | | | | | | | | | | | | |
|-------|--------------|----|----|----|----|----|----|----|--------------|----|----|----|----|----|----|----|
| Bits | 31 | 30 | 29 | 28 | 27 | 26 | 25 | 24 | 23 | 22 | 21 | 20 | 19 | 18 | 17 | 16 |
| R | END_OF_RX_WD | | | | | | | | END_OF_RX_WU | | | | | | | |
| W | | | | | | | | | | | | | | | | |
| Reset | 0 | 1 | 1 | 0 | 0 | 1 | 1 | 1 | 0 | 1 | 1 | 0 | 0 | 1 | 1 | 0 |
| Bits | 15 | 14 | 13 | 12 | 11 | 10 | 9 | 8 | 7 | 6 | 5 | 4 | 3 | 2 | 1 | 0 |
| R | END_OF_TX_WD | | | | | | | | END_OF_TX_WU | | | | | | | |
| W | | | | | | | | | | | | | | | | |
| Reset | 0 | 1 | 1 | 0 | 1 | 0 | 1 | 0 | 0 | 1 | 1 | 0 | 0 | 0 | 1 | 1 |

45.2.2.4.3.3 Fields

| Field | Function |
|-----------------------|---|
| 31-24 END_OF_RX_WD | End of RX Warmdown This register defines the point at which the TSM RX sequence warmdown completes, and the TSM returns to idle. The duration of the TSM warmdown phase is determined by: END_OF_RX_WD – END_OF_RX_WU. |
| 23-16 END_OF_RX_WU | End of RX Warmup This register defines the length of the TSM RX warmup sequence. After the assertion of a RX sequence-initiating event, when the TSM counter reaches the count matching this register, it will stop and hold its count, and the TSM will transition from the WARMUP to the ON phase. |
| 15-8 END_OF_TX_WD | End of TX Warmdown This register defines the point at which the TSM TX sequence warmdown completes, and the TSM returns to idle. The duration of the TSM warmdown phase is determined by: END_OF_TX_WD – END_OF_TX_WU. |
| 7-0 END_OF_TX_WU | End of TX Warmup This register defines the length of the TSM TX warmup sequence. After the assertion of a TX sequence-initiating event, when the TSM counter reaches the count matching this register, it will stop and hold its count, and the TSM will transition from the WARMUP to the ON phase. |

45.2.2.4.4 TSM OVERRIDE REGISTER 0 (OVRD0)

45.2.2.4.4.1 Address

| Register | Offset |
|----------|-----------|
| OVRD0 | 4005C2C8h |

45.2.2.4.4.2 Diagram

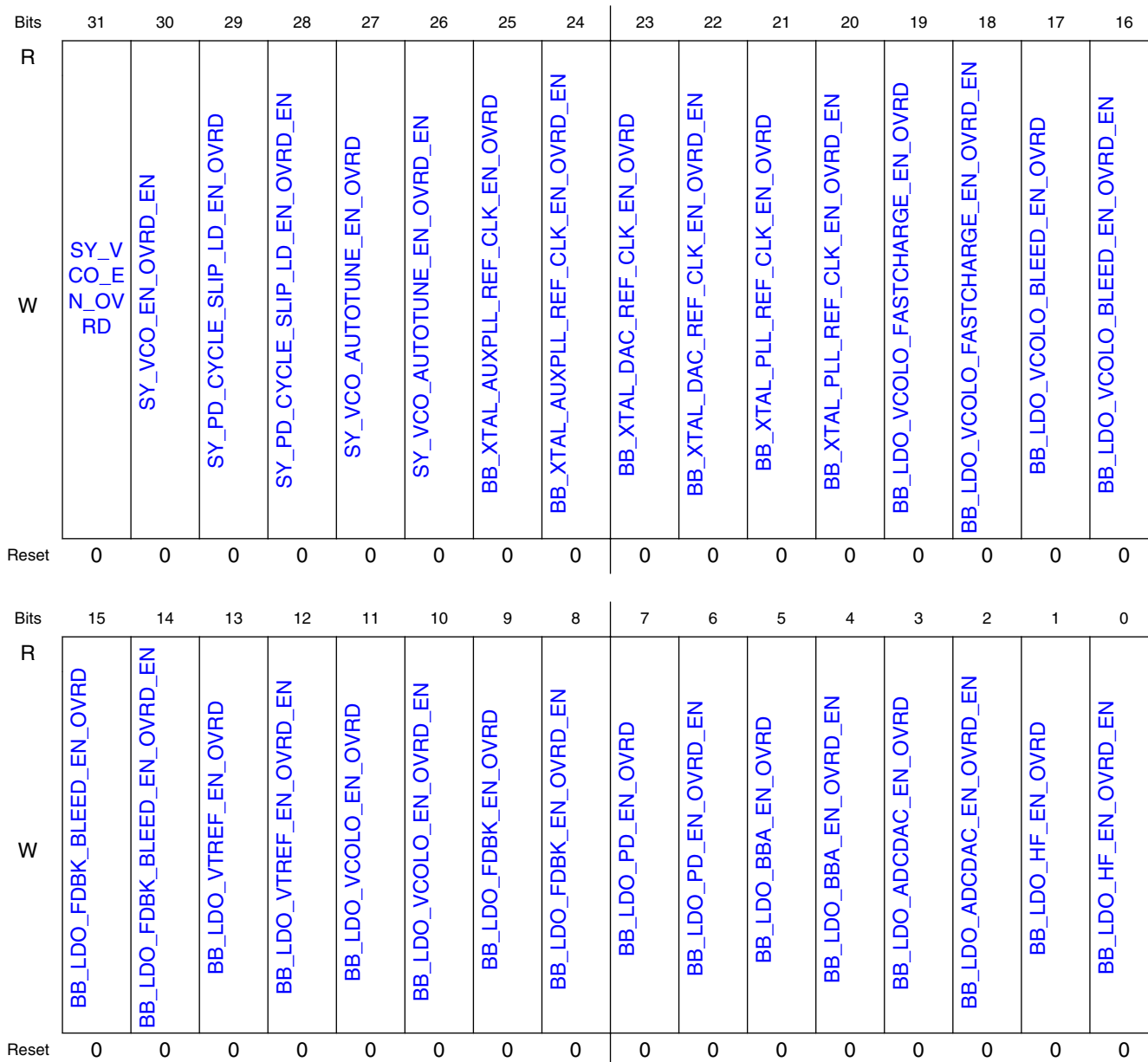

45.2.2.4.4.3 Fields

| Field | Function |
|-------------------------|---|
| 31 SY_VCO_EN_OVRD | Override value for SY_VCO_EN When SY_VCO_EN_OVRD_EN=1, this value overrides the mission mode state of the signal "sy_vco_en". This bit is ignored when SY_VCO_EN_OVRD_EN==0. |
| 30 SY_VCO_EN_OVRD_EN | Override control for SY_VCO_EN 0b - Normal operation. 1b - Use the state of SY_VCO_EN_OVRD to override the signal "sy_vco_en". |

Table continues on the next page...

| Field | Function |
|--|---|
| 29 SY_PD_CYCLE_SLIP_LD_EN_OVRD | Override value for SY_PD_CYCLE_SLIP_LD_EN When SY_PD_CYCLE_SLIP_LD_EN_OVRD_EN=1, this value overrides the mission mode state of the signal "sy_pd_cycle_slip_ld_en". This bit is ignored when SY_PD_CYCLE_SLIP_LD_EN_OVRD_EN==0. |
| 28 SY_PD_CYCLE_SLIP_LD_EN_OVRD_EN | Override control for SY_PD_CYCLE_SLIP_LD_EN 0b - Normal operation. 1b - Use the state of SY_PD_CYCLE_SLIP_LD_EN_OVRD to override the signal "sy_pd_cycle_slip_ld_en". |
| 27 SY_VCO_AUTO_TUNE_EN_OVRD | Override value for SY_VCO_AUTOTUNE_EN When SY_VCO_AUTOTUNE_EN_OVRD_EN=1, this value overrides the mission mode state of the signal "sy_vco_autotune_en". This bit is ignored when SY_VCO_AUTOTUNE_EN_OVRD_EN==0. |
| 26 SY_VCO_AUTO_TUNE_EN_OVRD_EN | Override control for SY_VCO_AUTOTUNE_EN 0b - Normal operation. 1b - Use the state of SY_VCO_AUTOTUNE_EN_OVRD to override the signal "sy_vco_autotune_en". |
| 25 BB_XTAL_AUX_PLL_REF_CLK_EN_OVRD | Override value for BB_XTAL_AUXPLL_REF_CLK_EN When BB_XTAL_AUXPLL_REF_CLK_EN_OVRD_EN=1, this value overrides the mission mode state of the signal "bb_xtal_auxpll_ref_clk_en". This bit is ignored when BB_XTAL_AUXPLL_REF_CLK_EN_OVRD_EN==0. |
| 24 BB_XTAL_AUX_PLL_REF_CLK_EN_OVRD_EN | Override control for BB_XTAL_AUXPLL_REF_CLK_EN 0b - Normal operation. 1b - Use the state of BB_XTAL_AUXPLL_REF_CLK_EN_OVRD to override the signal "bb_xtal_auxpll_ref_clk_en". |
| 23 BB_XTAL_DAC_REF_CLK_EN_OVRD | Override value for BB_XTAL_DAC_REF_CLK_EN When BB_XTAL_DAC_REF_CLK_EN_OVRD_EN=1, this value overrides the mission mode state of the signal "bb_xtal_dac_ref_clk_en". This bit is ignored when BB_XTAL_DAC_REF_CLK_EN_OVRD_EN==0. |
| 22 BB_XTAL_DAC_REF_CLK_EN_OVRD_EN | Override control for BB_XTAL_DAC_REF_CLK_EN 0b - Normal operation. 1b - Use the state of BB_XTAL_DAC_REF_CLK_EN_OVRD to override the signal "bb_xtal_dac_ref_clk_en". |
| 21 BB_XTAL_PLL_REF_CLK_EN_OVRD | Override value for BB_XTAL_PLL_REF_CLK_EN When BB_XTAL_PLL_REF_CLK_EN_OVRD_EN=1, this value overrides the mission mode state of the signal "bb_xtal_pll_ref_clk_en". This bit is ignored when BB_XTAL_PLL_REF_CLK_EN_OVRD_EN==0. |
| 20 BB_XTAL_PLL_REF_CLK_EN_OVRD_EN | Override control for BB_XTAL_PLL_REF_CLK_EN 0b - Normal operation. 1b - Use the state of BB_XTAL_PLL_REF_CLK_EN_OVRD to override the signal "bb_xtal_pll_ref_clk_en". |
| 19 BB_LDO_VCOLO_FASTCHARGE_EN_OVRD | Override value for BB_LDO_VCOLO_FASTCHARGE_EN When BB_LDO_VCOLO_FASTCHARGE_EN_OVRD_EN=1, this value overrides the mission mode state of the signal "bb_ldo_vcolo_fastcharge_en". This bit is ignored when BB_LDO_VCOLO_FASTCHARGE_EN_OVRD_EN==0. |
| 18 | Override control for BB_LDO_VCOLO_FASTCHARGE_EN 0b - Normal operation. |

Table continues on the next page...

Radio Register Overview

| Field | Function |
|-------------------------------------|---|
| BB_LDO_VCOLO_FASTCHARGE_EN_OVRD_EN | 1b - Use the state of BB_LDO_VCOLO_FASTCHARGE_EN_OVRD to override the signal "bb_ldo_vcolo_fastcharge_en". |
| 17 BB_LDO_VCOLO_BLEED_EN_OVRD | Override value for BB_LDO_VCOLO_BLEED_EN When BB_LDO_VCOLO_BLEED_EN_OVRD_EN=1, this value overrides the mission mode state of the signal "bb_ldo_vcolo_bleed_en". This bit is ignored when BB_LDO_VCOLO_BLEED_EN_OVRD_EN==0. |
| 16 BB_LDO_VCOLO_BLEED_EN_OVRD_EN | Override control for BB_LDO_VCOLO_BLEED_EN 0b - Normal operation. 1b - Use the state of BB_LDO_VCOLO_BLEED_EN_OVRD to override the signal "bb_ldo_vcolo_bleed_en". |
| 15 BB_LDO_FDBK_BLEED_EN_OVRD | Override value for BB_LDO_FDBK_BLEED_EN When BB_LDO_FDBK_BLEED_EN_OVRD_EN=1, this value overrides the mission mode state of the signal "bb_ldo_fdbk_bleed_en". This bit is ignored when BB_LDO_FDBK_BLEED_EN_OVRD_EN==0. |
| 14 BB_LDO_FDBK_BLEED_EN_OVRD_EN | Override control for BB_LDO_FDBK_BLEED_EN 0b - Normal operation. 1b - Use the state of BB_LDO_FDBK_BLEED_EN_OVRD to override the signal "bb_ldo_fdbk_bleed_en". |
| 13 BB_LDO_VTREF_EN_OVRD | Override value for BB_LDO_VTREF_EN When BB_LDO_VTREF_EN_OVRD_EN=1, this value overrides the mission mode state of the signal "bb_ldo_vtref_en". This bit is ignored when BB_LDO_VTREF_EN_OVRD_EN==0. |
| 12 BB_LDO_VTREF_EN_OVRD_EN | Override control for BB_LDO_VTREF_EN 0b - Normal operation. 1b - Use the state of BB_LDO_VTREF_EN_OVRD to override the signal "bb_ldo_vtref_en". |
| 11 BB_LDO_VCOLO_EN_OVRD | Override value for BB_LDO_VCOLO_EN When BB_LDO_VCOLO_EN_OVRD_EN=1, this value overrides the mission mode state of the signal "bb_ldo_vcolo_en". This bit is ignored when BB_LDO_VCOLO_EN_OVRD_EN==0. |
| 10 BB_LDO_VCOLO_EN_OVRD_EN | Override control for BB_LDO_VCOLO_EN 0b - Normal operation. 1b - Use the state of BB_LDO_VCOLO_EN_OVRD to override the signal "bb_ldo_vcolo_en". |
| 9 BB_LDO_FDBK_EN_OVRD | Override value for BB_LDO_FDBK_EN When BB_LDO_FDBK_EN_OVRD_EN=1, this value overrides the mission mode state of the signal "bb_ldo_fdbk_en". This bit is ignored when BB_LDO_FDBK_EN_OVRD_EN==0. |
| 8 BB_LDO_FDBK_EN_OVRD_EN | Override control for BB_LDO_FDBK_EN 0b - Normal operation. 1b - Use the state of BB_LDO_FDBK_EN_OVRD to override the signal "bb_ldo_fdbk_en". |
| 7 BB_LDO_PD_EN_OVRD | Override value for BB_LDO_PD_EN When BB_LDO_PD_EN_OVRD_EN=1, this value overrides the mission mode state of the signal "bb_ldo_pd_en". This bit is ignored when BB_LDO_PD_EN_OVRD_EN==0. |
| 6 BB_LDO_PD_EN_OVRD_EN | Override control for BB_LDO_PD_EN 0b - Normal operation. 1b - Use the state of BB_LDO_PD_EN_OVRD to override the signal "bb_ldo_pd_en". |

Table continues on the next page...

| Field | Function |
|--------------------------------|---|
| 5 BB_LDO_BBA_EN_OVRD | Override value for BB_LDO_BBA_EN When BB_LDO_BBA_EN_OVRD_EN=1, this value overrides the mission mode state of the signal "bb_ldo_bba_en". This bit is ignored when BB_LDO_BBA_EN_OVRD_EN==0. |
| 4 BB_LDO_BBA_EN_OVRD_EN | Override control for BB_LDO_BBA_EN 0b - Normal operation. 1b - Use the state of BB_LDO_BBA_EN_OVRD to override the signal "bb_ldo_bba_en". |
| 3 BB_LDO_ADCCDAC_EN_OVRD | Override value for BB_LDO_ADCCDAC_EN When BB_LDO_ADCCDAC_EN_OVRD_EN=1, this value overrides the mission mode state of the signal "bb_ldo_adccdac_en". This bit is ignored when BB_LDO_ADCCDAC_EN_OVRD_EN==0. |
| 2 BB_LDO_ADCCDAC_EN_OVRD_EN | Override control for BB_LDO_ADCCDAC_EN 0b - Normal operation. 1b - Use the state of BB_LDO_ADCCDAC_EN_OVRD to override the signal "bb_ldo_adccdac_en". |
| 1 BB_LDO_HF_EN_OVRD | Override value for BB_LDO_HF_EN When BB_LDO_HF_EN_OVRD_EN=1, this value overrides the mission mode state of the signal "bb_ldo_hf_en". This bit is ignored when BB_LDO_HF_EN_OVRD_EN==0. |
| 0 BB_LDO_HF_EN_OVRD_EN | Override control for BB_LDO_HF_EN 0b - Normal operation. 1b - Use the state of BB_LDO_HF_EN_OVRD to override the signal "bb_ldo_hf_en". |

45.2.2.4.5 TSM OVERRIDE REGISTER 1 (OVRD1)

45.2.2.4.5.1 Address

| Register | Offset |
|----------|-----------|
| OVRD1 | 4005C2CCh |

45.2.2.4.5.2 Diagram

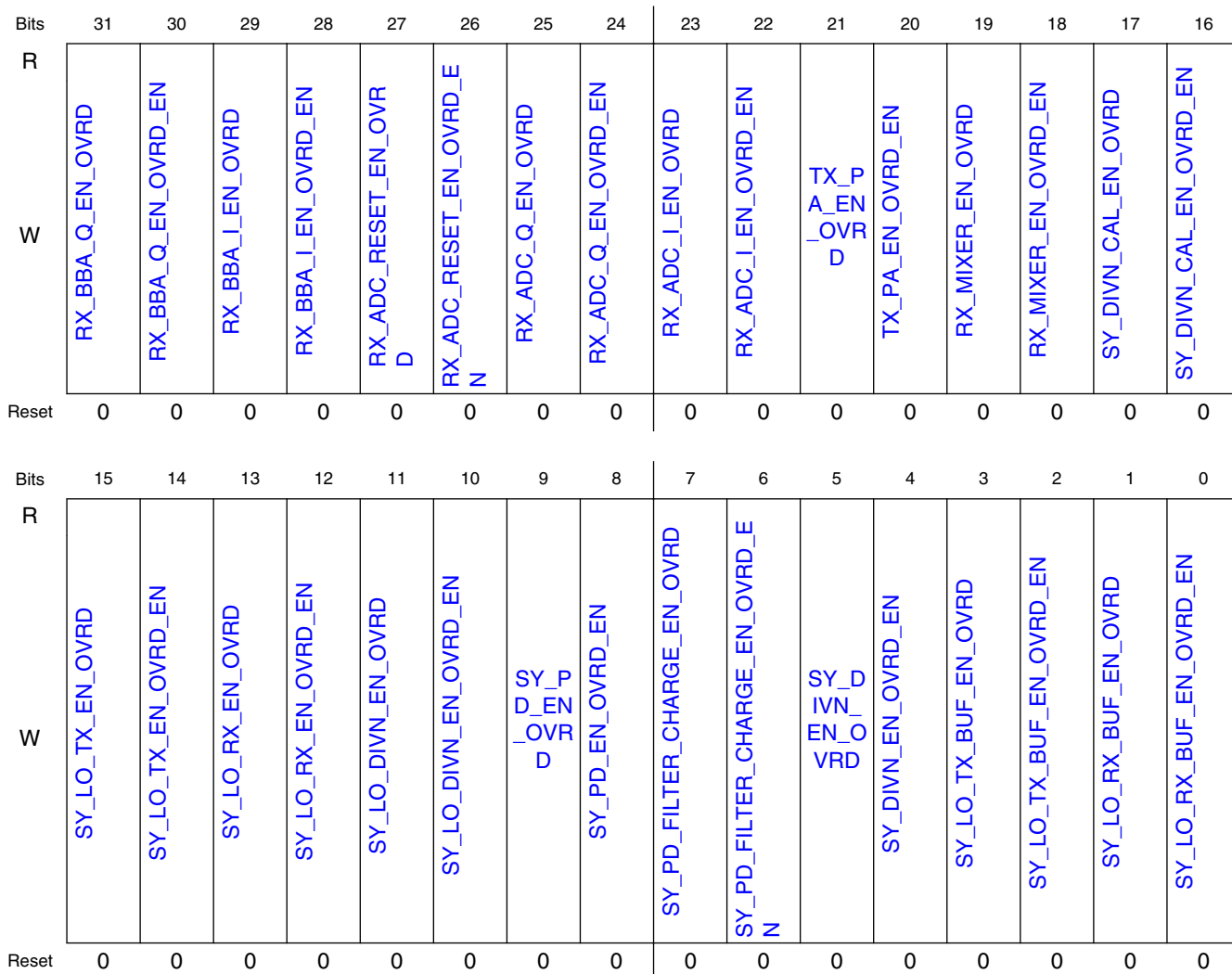

45.2.2.4.5.3 Fields

| Field | Function |
|---------------------------|---|
| 31 RX_BBA_Q_EN_OVRD | Override value for RX_BBA_Q_EN When RX_BBA_Q_EN_OVRD_EN=1, this value overrides the mission mode state of the signal "rx_bba_q_en". This bit is ignored when RX_BBA_Q_EN_OVRD_EN==0. |
| 30 RX_BBA_Q_EN_OVRD_EN | Override control for RX_BBA_Q_EN 0b - Normal operation. 1b - Use the state of RX_BBA_Q_EN_OVRD to override the signal "rx_bba_q_en". |
| 29 RX_BBA_I_EN_OVRD | Override value for RX_BBA_I_EN When RX_BBA_I_EN_OVRD_EN=1, this value overrides the mission mode state of the signal "rx_bba_i_en". This bit is ignored when RX_BBA_I_EN_OVRD_EN==0. |
| 28 | Override control for RX_BBA_I_EN |

Table continues on the next page...

| Field | Function |
|-------------------------|---|
| RX_BBA_I_EN_OVRD_EN | 0b - Normal operation. 1b - Use the state of RX_BBA_I_EN_OVRD to override the signal "rx_bba_i_en". |
| 27 | Override value for RX_ADC_RESET_EN |
| RX_ADC_RESET_EN_OVRD | When RX_ADC_RESET_EN_OVRD_EN=1, this value overrides the mission mode state of the signal "rx_adc_reset_en". This bit is ignored when RX_ADC_RESET_EN_OVRD_EN==0. |
| 26 | Override control for RX_ADC_RESET_EN |
| RX_ADC_RESET_EN_OVRD_EN | 0b - Normal operation. 1b - Use the state of RX_ADC_RESET_EN_OVRD to override the signal "rx_adc_reset_en". |
| 25 | Override value for RX_ADC_Q_EN |
| RX_ADC_Q_EN_OVRD | When RX_ADC_Q_EN_OVRD_EN=1, this value overrides the mission mode state of the signal "rx_adc_q_en". This bit is ignored when RX_ADC_Q_EN_OVRD_EN==0. |
| 24 | Override control for RX_ADC_Q_EN |
| RX_ADC_Q_EN_OVRD_EN | 0b - Normal operation. 1b - Use the state of RX_ADC_Q_EN_OVRD to override the signal "rx_adc_q_en". |
| 23 | Override value for RX_ADC_I_EN |
| RX_ADC_I_EN_OVRD | When RX_ADC_I_EN_OVRD_EN=1, this value overrides the mission mode state of the signal "rx_adc_i_en". This bit is ignored when RX_ADC_I_EN_OVRD_EN==0. |
| 22 | Override control for RX_ADC_I_EN |
| RX_ADC_I_EN_OVRD_EN | 0b - Normal operation. 1b - Use the state of RX_ADC_I_EN_OVRD to override the signal "rx_adc_i_en". |
| 21 | Override value for TX_PA_EN |
| TX_PA_EN_OVRD | When TX_PA_EN_OVRD_EN=1, this value overrides the mission mode state of the signal "tx_pa_en". This bit is ignored when TX_PA_EN_OVRD_EN==0. |
| 20 | Override control for TX_PA_EN |
| TX_PA_EN_OVRD_EN | 0b - Normal operation. 1b - Use the state of TX_PA_EN_OVRD to override the signal "tx_pa_en". |
| 19 | Override value for RX_MIXER_EN |
| RX_MIXER_EN_OVRD | When RX_MIXER_EN_OVRD_EN=1, this value overrides the mission mode state of the signal "rx_mixer_en". This bit is ignored when RX_MIXER_EN_OVRD_EN==0. |
| 18 | Override control for RX_MIXER_EN |
| RX_MIXER_EN_OVRD_EN | 0b - Normal operation. 1b - Use the state of RX_MIXER_EN_OVRD to override the signal "rx_mixer_en". |
| 17 | Override value for SY_DIVN_CAL_EN |
| SY_DIVN_CAL_EN_OVRD | When SY_DIVN_CAL_EN_OVRD_EN=1, this value overrides the mission mode state of the signal "sy_divn_cal_en". This bit is ignored when SY_DIVN_CAL_EN_OVRD_EN==0. |
| 16 | Override control for SY_DIVN_CAL_EN |
| SY_DIVN_CAL_EN_OVRD_EN | 0b - Normal operation. 1b - Use the state of SY_DIVN_CAL_EN_OVRD to override the signal "sy_divn_cal_en". |
| 15 | Override value for SY_LO_TX_EN |
| SY_LO_TX_EN_OVRD | When SY_LO_TX_EN_OVRD_EN=1, this value overrides the mission mode state of the signal "sy_lo_tx_en". This bit is ignored when SY_LO_TX_EN_OVRD_EN==0. |
| 14 | Override control for SY_LO_TX_EN |
| SY_LO_TX_EN_OVRD_EN | 0b - Normal operation. 1b - Use the state of SY_LO_TX_EN_OVRD to override the signal "sy_lo_tx_en". |

Table continues on the next page...

Radio Register Overview

| Field | Function |
|-------------------------------------|---|
| 13 SY_LO_RX_EN_OVRD | Override value for SY_LO_RX_EN When SY_LO_RX_EN_OVRD_EN=1, this value overrides the mission mode state of the signal "sy_lo_rx_en". This bit is ignored when SY_LO_RX_EN_OVRD_EN==0. |
| 12 SY_LO_RX_EN_OVRD_EN | Override control for SY_LO_RX_EN 0b - Normal operation. 1b - Use the state of SY_LO_RX_EN_OVRD to override the signal "sy_lo_rx_en". |
| 11 SY_LO_DIVN_EN_OVRD | Override value for SY_LO_DIVN_EN When SY_LO_DIVN_EN_OVRD_EN=1, this value overrides the mission mode state of the signal "sy_lo_divn_en". This bit is ignored when SY_LO_DIVN_EN_OVRD_EN==0. |
| 10 SY_LO_DIVN_EN_OVRD_EN | Override control for SY_LO_DIVN_EN 0b - Normal operation. 1b - Use the state of SY_LO_DIVN_EN_OVRD to override the signal "sy_lo_divn_en". |
| 9 SY_PD_EN_OVRD | Override value for SY_PD_EN When SY_PD_EN_OVRD_EN=1, this value overrides the mission mode state of the signal "sy_pd_en". This bit is ignored when SY_PD_EN_OVRD_EN==0. |
| 8 SY_PD_EN_OVRD_EN | Override control for SY_PD_EN 0b - Normal operation. 1b - Use the state of SY_PD_EN_OVRD to override the signal "sy_pd_en". |
| 7 SY_PD_FILTER_CHARGE_EN_OVRD | Override value for SY_PD_FILTER_CHARGE_EN When SY_PD_FILTER_CHARGE_EN_OVRD_EN=1, this value overrides the mission mode state of the signal "sy_pd_filter_charge_en". This bit is ignored when SY_PD_FILTER_CHARGE_EN_OVRD_EN==0. |
| 6 SY_PD_FILTER_CHARGE_EN_OVRD_EN | Override control for SY_PD_FILTER_CHARGE_EN 0b - Normal operation. 1b - Use the state of SY_PD_FILTER_CHARGE_EN_OVRD to override the signal "sy_pd_filter_charge_en". |
| 5 SY_DIVN_EN_OVRD | Override value for SY_DIVN_EN When SY_DIVN_EN_OVRD_EN=1, this value overrides the mission mode state of the signal "sy_divn_en". This bit is ignored when SY_DIVN_EN_OVRD_EN==0. |
| 4 SY_DIVN_EN_OVRD_EN | Override control for SY_DIVN_EN 0b - Normal operation. 1b - Use the state of SY_DIVN_EN_OVRD to override the signal "sy_divn_en". |
| 3 SY_LO_TX_BUF_EN_OVRD | Override value for SY_LO_TX_BUF_EN When SY_LO_TX_BUF_EN_OVRD_EN=1, this value overrides the mission mode state of the signal "sy_lo_tx_buf_en". This bit is ignored when SY_LO_TX_BUF_EN_OVRD_EN==0. |
| 2 SY_LO_TX_BUF_EN_OVRD_EN | Override control for SY_LO_TX_BUF_EN 0b - Normal operation. 1b - Use the state of SY_LO_TX_BUF_EN_OVRD to override the signal "sy_lo_tx_buf_en". |
| 1 SY_LO_RX_BUF_EN_OVRD | Override value for SY_LO_RX_BUF_EN When SY_LO_RX_BUF_EN_OVRD_EN=1, this value overrides the mission mode state of the signal "sy_lo_rx_buf_en". This bit is ignored when SY_LO_RX_BUF_EN_OVRD_EN==0. |
| 0 SY_LO_RX_BUF_EN_OVRD_EN | Override control for SY_LO_RX_BUF_EN 0b - Normal operation. 1b - Use the state of SY_LO_RX_BUF_EN_OVRD to override the signal "sy_lo_rx_buf_en". |

45.2.2.4.6 TSM OVERRIDE REGISTER 2 (OVRD2)

45.2.2.4.6.1 Address

| Register | Offset |
|----------|-----------|
| OVRD2 | 4005C2D0h |

45.2.2.4.6.2 Diagram

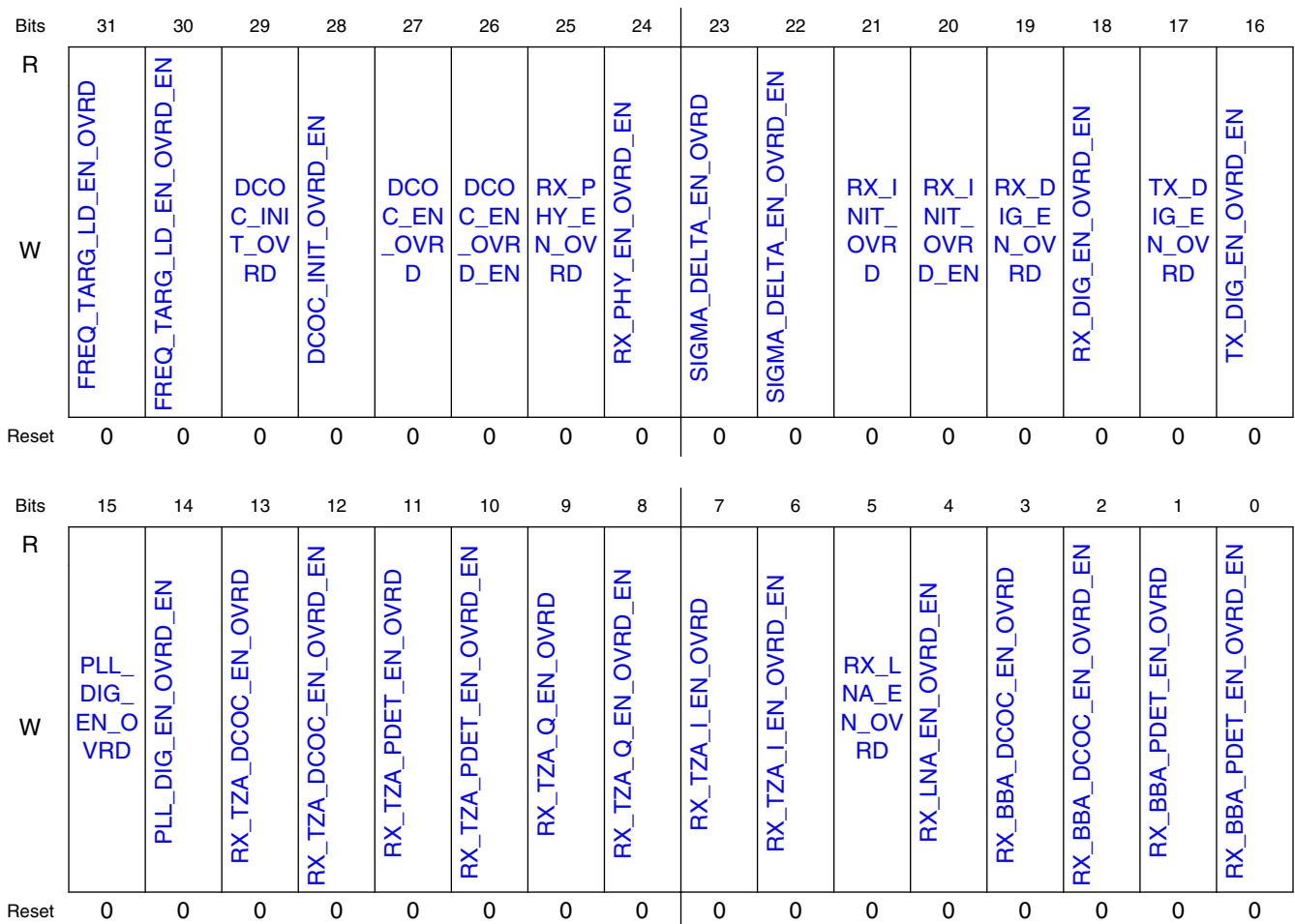

45.2.2.4.6.3 Fields

| Field | Function |
|-------|------------------------------------|
| 31 | Override value for FREQ_TARG_LD_EN |

Table continues on the next page...

Radio Register Overview

| Field | Function |
|-------------------------------|---|
| FREQ_TARG_LD_EN_OVRD | When FREQ_TARG_LD_EN_OVRD_EN=1, this value overrides the mission mode state of the signal "freq_targ_ld_en". This bit is ignored when FREQ_TARG_LD_EN_OVRD_EN==0. |
| 30 FREQ_TARG_LD_EN_OVRD_EN | Override control for FREQ_TARG_LD_EN 0b - Normal operation. 1b - Use the state of FREQ_TARG_LD_EN_OVRD to override the signal "freq_targ_ld_en". |
| 29 DCOC_INIT_OVRD | Override value for DCOC_INIT When DCOC_INIT_OVRD_EN=1, this value overrides the mission mode state of the signal "dcoc_init". This bit is ignored when DCOC_INIT_OVRD_EN==0. |
| 28 DCOC_INIT_OVRD_EN | Override control for DCOC_INIT 0b - Normal operation. 1b - Use the state of DCOC_INIT_OVRD to override the signal "dcoc_init". |
| 27 DCOC_EN_OVRD | Override value for DCOC_EN When DCOC_EN_OVRD_EN=1, this value overrides the mission mode state of the signal "dcoc_en". This bit is ignored when DCOC_EN_OVRD_EN==0. |
| 26 DCOC_EN_OVRD_EN | Override control for DCOC_EN 0b - Normal operation. 1b - Use the state of DCOC_EN_OVRD to override the signal "dcoc_en". |
| 25 RX_PHY_EN_OVRD | Override value for RX_PHY_EN When RX_PHY_EN_OVRD_EN=1, this value overrides the mission mode state of the signal "rx_phy_en". This bit is ignored when RX_PHY_EN_OVRD_EN==0. |
| 24 RX_PHY_EN_OVRD_EN | Override control for RX_PHY_EN 0b - Normal operation. 1b - Use the state of RX_PHY_EN_OVRD to override the signal "rx_phy_en". |
| 23 SIGMA_DELTA_EN_OVRD | Override value for SIGMA_DELTA_EN When SIGMA_DELTA_EN_OVRD_EN=1, this value overrides the mission mode state of the signal "sigma_delta_en". This bit is ignored when SIGMA_DELTA_EN_OVRD_EN==0. |
| 22 SIGMA_DELTA_EN_OVRD_EN | Override control for SIGMA_DELTA_EN 0b - Normal operation. 1b - Use the state of SIGMA_DELTA_EN_OVRD to override the signal "sigma_delta_en". |
| 21 RX_INIT_OVRD | Override value for RX_INIT When RX_INIT_OVRD_EN=1, this value overrides the mission mode state of the signal "rx_init". This bit is ignored when RX_INIT_OVRD_EN==0. |
| 20 RX_INIT_OVRD_EN | Override control for RX_INIT 0b - Normal operation. 1b - Use the state of RX_INIT_OVRD to override the signal "rx_init". |
| 19 RX_DIG_EN_OVRD | Override value for RX_DIG_EN When RX_DIG_EN_OVRD_EN=1, this value overrides the mission mode state of the signal "rx_dig_en". This bit is ignored when RX_DIG_EN_OVRD_EN==0. |
| 18 RX_DIG_EN_OVRD_EN | Override control for RX_DIG_EN 0b - Normal operation. 1b - Use the state of RX_DIG_EN_OVRD to override the signal "rx_dig_en". |
| 17 TX_DIG_EN_OVRD | Override value for TX_DIG_EN When TX_DIG_EN_OVRD_EN=1, this value overrides the mission mode state of the signal "tx_dig_en". This bit is ignored when TX_DIG_EN_OVRD_EN==0. |

Table continues on the next page...

| Field | Function |
|------------------------------|---|
| 16 TX_DIG_EN_OVRD_EN | Override control for TX_DIG_EN 0b - Normal operation. 1b - Use the state of TX_DIG_EN_OVRD to override the signal "tx_dig_en". |
| 15 PLL_DIG_EN_OVRD | Override value for PLL_DIG_EN When PLL_DIG_EN_OVRD_EN=1, this value overrides the mission mode state of the signal "pll_dig_en". This bit is ignored when PLL_DIG_EN_OVRD_EN==0. |
| 14 PLL_DIG_EN_OVRD_EN | Override control for PLL_DIG_EN 0b - Normal operation. 1b - Use the state of PLL_DIG_EN_OVRD to override the signal "pll_dig_en". |
| 13 RX_TZA_DCOC_EN_OVRD | Override control for RX_TZA_DCOC_EN 0b - Normal operation. 1b - Use the state of RX_TZA_DCOC_EN_OVRD to override the signal "rx_tza_dcoc_en". |
| 12 RX_TZA_DCOC_EN_OVRD_EN | Override control for RX_TZA_DCOC_EN 0b - Normal operation. 1b - Use the state of RX_TZA_DCOC_EN_OVRD to override the signal "rx_tza_dcoc_en". |
| 11 RX_TZA_PDET_EN_OVRD | Override value for RX_TZA_PDET_EN When RX_TZA_PDET_EN_OVRD_EN=1, this value overrides the mission mode state of the signal "rx_tza_pdet_en". This bit is ignored when RX_TZA_PDET_EN_OVRD_EN==0. |
| 10 RX_TZA_PDET_EN_OVRD_EN | Override control for RX_TZA_PDET_EN 0b - Normal operation. 1b - Use the state of RX_TZA_PDET_EN_OVRD to override the signal "rx_tza_pdet_en". |
| 9 RX_TZA_Q_EN_OVRD | Override value for RX_TZA_Q_EN When RX_TZA_Q_EN_OVRD_EN=1, this value overrides the mission mode state of the signal "rx_tza_q_en". This bit is ignored when RX_TZA_Q_EN_OVRD_EN==0. |
| 8 RX_TZA_Q_EN_OVRD_EN | Override control for RX_TZA_Q_EN 0b - Normal operation. 1b - Use the state of RX_TZA_Q_EN_OVRD to override the signal "rx_tza_q_en". |
| 7 RX_TZA_I_EN_OVRD | Override value for RX_TZA_I_EN When RX_TZA_I_EN_OVRD_EN=1, this value overrides the mission mode state of the signal "rx_tza_i_en". This bit is ignored when RX_TZA_I_EN_OVRD_EN==0. |
| 6 RX_TZA_I_EN_OVRD_EN | Override control for RX_TZA_I_EN 0b - Normal operation. 1b - Use the state of RX_TZA_I_EN_OVRD to override the signal "rx_tza_i_en". |
| 5 RX_LNA_EN_OVRD | Override value for RX_LNA_EN When RX_LNA_EN_OVRD_EN=1, this value overrides the mission mode state of the signal "rx_lna_en". This bit is ignored when RX_LNA_EN_OVRD_EN==0. |
| 4 RX_LNA_EN_OVRD_EN | Override control for RX_LNA_EN 0b - Normal operation. 1b - Use the state of RX_LNA_EN_OVRD to override the signal "rx_lna_en". |
| 3 RX_BBA_DCOC_EN_OVRD | Override value for RX_BBA_DCOC_EN When RX_BBA_DCOC_EN_OVRD_EN=1, this value overrides the mission mode state of the signal "rx_bba_dcoc_en". This bit is ignored when RX_BBA_DCOC_EN_OVRD_EN==0. |
| 2 | Override control for RX_BBA_DCOC_EN 0b - Normal operation. |

Table continues on the next page...

Radio Register Overview

| Field | Function |
|------------------------|--|
| RX_BBA_DCOC_EN_OVRD_EN | 1b - Use the state of RX_BBA_DCOC_EN_OVRD to override the signal "rx_bba_dcoc_en". |
| 1 | Override value for RX_BBA_PDET_EN |
| RX_BBA_PDET_EN_OVRD | When RX_BBA_PDET_EN_OVRD_EN=1, this value overrides the mission mode state of the signal "rx_bba_pdet_en". This bit is ignored when RX_BBA_PDET_EN_OVRD_EN==0. |
| 0 | Override control for RX_BBA_PDET_EN |
| RX_BBA_PDET_EN_OVRD_EN | 0b - Normal operation. 1b - Use the state of RX_BBA_PDET_EN_OVRD to override the signal "rx_bba_pdet_en". |

45.2.2.4.7 TSM OVERRIDE REGISTER 3 (OVRD3)

45.2.2.4.7.1 Address

| Register | Offset |
|----------|-----------|
| OVRD3 | 4005C2D4h |

45.2.2.4.7.2 Diagram

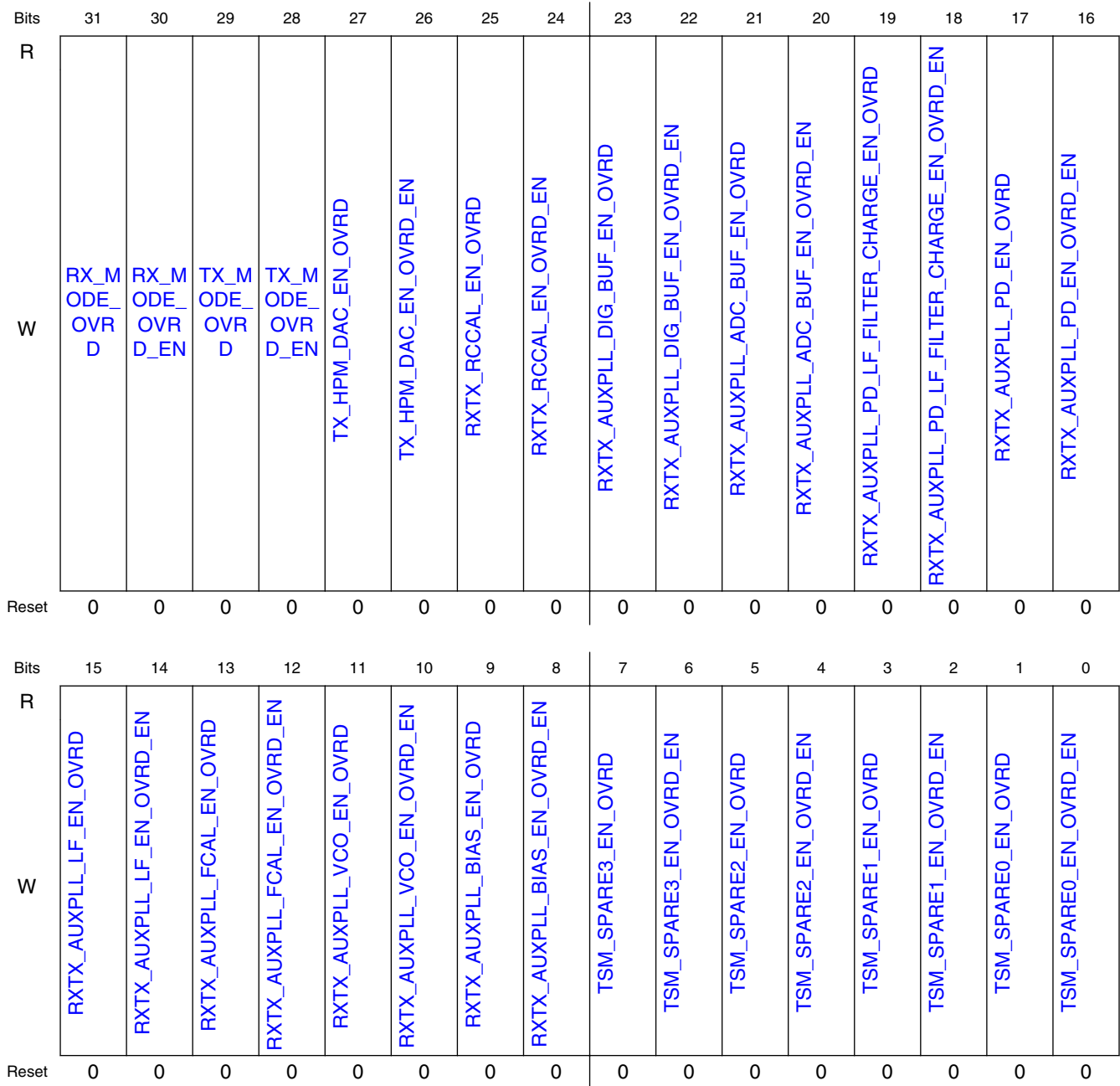

45.2.2.4.7.3 Fields

| Field | Function |
|--------------------|---|
| 31 RX_MODE_OVRD | Override value for RX_MODE When RX_MODE_OVRD_EN=1, this value overrides the mission mode state of the signal "rx_mode". This bit is ignored when RX_MODE_OVRD_EN==0. |
| 30 | Override control for RX_MODE |

Table continues on the next page...

Radio Register Overview

| Field | Function |
|--|--|
| RX_MODE_OVRD_EN | 0b - Normal operation. 1b - Use the state of RX_MODE_OVRD to override the signal "rx_mode". |
| 29 | Override value for TX_MODE |
| TX_MODE_OVRD_RD | When TX_MODE_OVRD_EN=1, this value overrides the mission mode state of the signal "tx_mode". This bit is ignored when TX_MODE_OVRD_EN==0. |
| 28 | Override control for TX_MODE |
| TX_MODE_OVRD_EN | 0b - Normal operation. 1b - Use the state of TX_MODE_OVRD to override the signal "tx_mode". |
| 27 | Override value for TX_HPM_DAC_EN |
| TX_HPM_DAC_EN_OVRD | When TX_HPM_DAC_EN_OVRD_EN=1, this value overrides the mission mode state of the signal "tx_hpm_dac_en". This bit is ignored when TX_HPM_DAC_EN_OVRD_EN==0. |
| 26 | Override control for TX_HPM_DAC_EN |
| TX_HPM_DAC_EN_OVRD_EN | 0b - Normal operation. 1b - Use the state of TX_HPM_DAC_EN_OVRD to override the signal "tx_hpm_dac_en". |
| 25 | Override value for RXTX_RCCAL_EN |
| RXTX_RCCAL_EN_OVRD | When RXTX_RCCAL_EN_OVRD_EN=1, this value overrides the mission mode state of the signal "rxtx_rccal_en". This bit is ignored when RXTX_RCCAL_EN_OVRD_EN==0. |
| 24 | Override control for RXTX_RCCAL_EN |
| RXTX_RCCAL_EN_OVRD_EN | 0b - Normal operation. 1b - Use the state of RXTX_RCCAL_EN_OVRD to override the signal "rxtx_rccal_en". |
| 23 | Override value for RXTX_AUXPLL_DIG_BUF_EN |
| RXTX_AUXPLL_DIG_BUF_EN_OVRD | When RXTX_AUXPLL_DIG_BUF_EN_OVRD_EN=1, this value overrides the mission mode state of the signal "rxtx_auxpll_dig_buf_en". This bit is ignored when RXTX_AUXPLL_DIG_BUF_EN_OVRD_EN==0. |
| 22 | Override control for RXTX_AUXPLL_DIG_BUF_EN |
| RXTX_AUXPLL_DIG_BUF_EN_OVRD_EN | 0b - Normal operation. 1b - Use the state of RXTX_AUXPLL_DIG_BUF_EN_OVRD to override the signal "rxtx_auxpll_dig_buf_en". |
| 21 | Override value for RXTX_AUXPLL_ADC_BUF_EN |
| RXTX_AUXPLL_ADC_BUF_EN_OVRD | When RXTX_AUXPLL_ADC_BUF_EN_OVRD_EN=1, this value overrides the mission mode state of the signal "rxtx_auxpll_adc_buf_en". This bit is ignored when RXTX_AUXPLL_ADC_BUF_EN_OVRD_EN==0. |
| 20 | Override control for RXTX_AUXPLL_ADC_BUF_EN |
| RXTX_AUXPLL_ADC_BUF_EN_OVRD_EN | 0b - Normal operation. 1b - Use the state of RXTX_AUXPLL_ADC_BUF_EN_OVRD to override the signal "rxtx_auxpll_adc_buf_en". |
| 19 | Override value for RXTX_AUXPLL_PD_LF_FILTER_CHARGE_EN |
| RXTX_AUXPLL_PD_LF_FILTER_CHARGE_EN_OVRD | When RXTX_AUXPLL_PD_LF_FILTER_CHARGE_EN_OVRD_EN=1, this value overrides the mission mode state of the signal "rxtx_auxpll_pd_lf_filter_charge_en". This bit is ignored when RXTX_AUXPLL_PD_LF_FILTER_CHARGE_EN_OVRD_EN==0. |
| 18 | Override control for RXTX_AUXPLL_PD_LF_FILTER_CHARGE_EN |
| RXTX_AUXPLL_PD_LF_FILTER_CHARGE_EN_OVRD_EN | 0b - Normal operation. 1b - Use the state of RXTX_AUXPLL_PD_LF_FILTER_CHARGE_EN_OVRD to override the signal "rxtx_auxpll_pd_lf_filter_charge_en". |

Table continues on the next page...

| Field | Function |
|-----------------------------------|--|
| 17 RXTX_AUXPLL_PD_EN_OVRD | Override value for RXTX_AUXPLL_PD_EN When RXTX_AUXPLL_PD_EN_OVRD_EN=1, this value overrides the mission mode state of the signal "rxtx_auxpll_pd_en". This bit is ignored when RXTX_AUXPLL_PD_EN_OVRD_EN==0. |
| 16 RXTX_AUXPLL_PD_EN_OVRD_EN | Override control for RXTX_AUXPLL_PD_EN 0b - Normal operation. 1b - Use the state of RXTX_AUXPLL_PD_EN_OVRD to override the signal "rxtx_auxpll_pd_en". |
| 15 RXTX_AUXPLL_LF_EN_OVRD | Override value for RXTX_AUXPLL_LF_EN When RXTX_AUXPLL_LF_EN_OVRD_EN=1, this value overrides the mission mode state of the signal "rxtx_auxpll_lf_en". This bit is ignored when RXTX_AUXPLL_LF_EN_OVRD_EN==0. |
| 14 RXTX_AUXPLL_LF_EN_OVRD_EN | Override control for RXTX_AUXPLL_LF_EN 0b - Normal operation. 1b - Use the state of RXTX_AUXPLL_LF_EN_OVRD to override the signal "rxtx_auxpll_lf_en". |
| 13 RXTX_AUXPLL_FCAL_EN_OVRD | Override value for RXTX_AUXPLL_FCAL_EN When RXTX_AUXPLL_FCAL_EN_OVRD_EN=1, this value overrides the mission mode state of the signal "rxtx_auxpll_fc_al_en". This bit is ignored when RXTX_AUXPLL_FCAL_EN_OVRD_EN==0. |
| 12 RXTX_AUXPLL_FCAL_EN_OVRD_EN | Override control for RXTX_AUXPLL_FCAL_EN 0b - Normal operation. 1b - Use the state of RXTX_AUXPLL_FCAL_EN_OVRD to override the signal "rxtx_auxpll_fc_al_en". |
| 11 RXTX_AUXPLL_VCO_EN_OVRD | Override value for RXTX_AUXPLL_VCO_EN When RXTX_AUXPLL_VCO_EN_OVRD_EN=1, this value overrides the mission mode state of the signal "rxtx_auxpll_vco_en". This bit is ignored when RXTX_AUXPLL_VCO_EN_OVRD_EN==0. |
| 10 RXTX_AUXPLL_VCO_EN_OVRD_EN | Override control for RXTX_AUXPLL_VCO_EN 0b - Normal operation. 1b - Use the state of RXTX_AUXPLL_VCO_EN_OVRD to override the signal "rxtx_auxpll_vco_en". |
| 9 RXTX_AUXPLL_BIAS_EN_OVRD | Override value for RXTX_AUXPLL_BIAS_EN When RXTX_AUXPLL_BIAS_EN_OVRD_EN=1, this value overrides the mission mode state of the signal "rxtx_auxpll_bias_en". This bit is ignored when RXTX_AUXPLL_BIAS_EN_OVRD_EN==0. |
| 8 RXTX_AUXPLL_BIAS_EN_OVRD_EN | Override control for RXTX_AUXPLL_BIAS_EN 0b - Normal operation. 1b - Use the state of RXTX_AUXPLL_BIAS_EN_OVRD to override the signal "rxtx_auxpll_bias_en". |
| 7 TSM_SPARE3_EN_OVRD | Override value for TSM_SPARE3_EN When TSM_SPARE3_EN_OVRD_EN=1, this value overrides the mission mode state of the signal "tsm_spare3_en". This bit is ignored when TSM_SPARE3_EN_OVRD_EN==0. |
| 6 TSM_SPARE3_EN_OVRD_EN | Override control for TSM_SPARE3_EN 0b - Normal operation. 1b - Use the state of TSM_SPARE3_EN_OVRD to override the signal "tsm_spare3_en". |
| 5 | Override value for TSM_SPARE2_EN |

Table continues on the next page...

Radio Register Overview

| Field | Function |
|----------------------------|---|
| TSM_SPARE2_EN_OVRD | When TSM_SPARE2_EN_OVRD_EN=1, this value overrides the mission mode state of the signal "tsm_spare2_en". This bit is ignored when TSM_SPARE2_EN_OVRD_EN==0. |
| 4 TSM_SPARE2_EN_OVRD_EN | Override control for TSM_SPARE2_EN 0b - Normal operation. 1b - Use the state of TSM_SPARE2_EN_OVRD to override the signal "tsm_spare2_en". |
| 3 TSM_SPARE1_EN_OVRD | Override value for TSM_SPARE1_EN When TSM_SPARE1_EN_OVRD_EN=1, this value overrides the mission mode state of the signal "tsm_spare1_en". This bit is ignored when TSM_SPARE1_EN_OVRD_EN==0. |
| 2 TSM_SPARE1_EN_OVRD_EN | Override control for TSM_SPARE1_EN 0b - Normal operation. 1b - Use the state of TSM_SPARE1_EN_OVRD to override the signal "tsm_spare1_en". |
| 1 TSM_SPARE0_EN_OVRD | Override value for TSM_SPARE0_EN When TSM_SPARE0_EN_OVRD_EN=1, this value overrides the mission mode state of the signal "tsm_spare0_en". This bit is ignored when TSM_SPARE0_EN_OVRD_EN==0. |
| 0 TSM_SPARE0_EN_OVRD_EN | Override control for TSM_SPARE0_EN 0b - Normal operation. 1b - Use the state of TSM_SPARE0_EN_OVRD to override the signal "tsm_spare0_en". |

45.2.2.4.8 PA POWER (PA_POWER)

45.2.2.4.8.1 Address

| Register | Offset |
|----------|-----------|
| PA_POWER | 4005C2D8h |

45.2.2.4.8.2 Function

This contents of this register are used as PA target power when XCVR_CTRL[TGT_PWR_SRC] = 000

45.2.2.4.8.3 Diagram

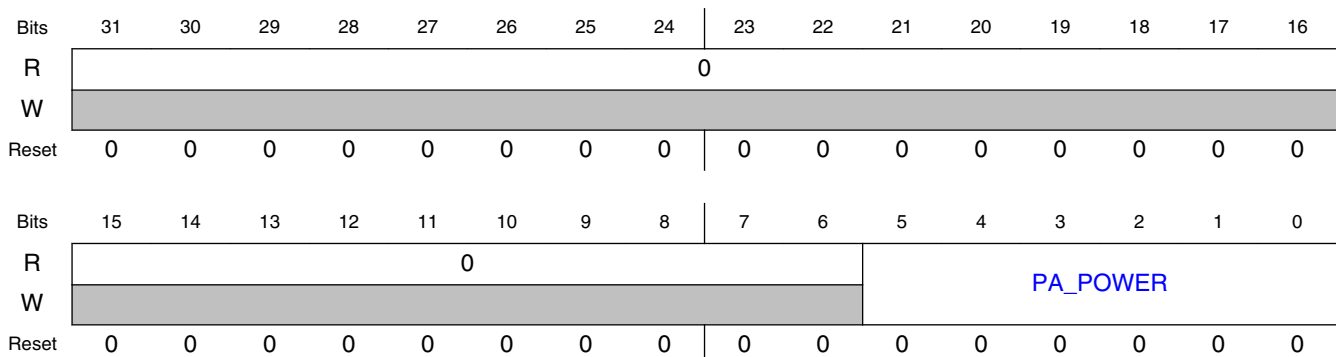

45.2.2.4.8.4 Fields

| Field | Function |
|------------------|--|
| 31-6 Reserved | Reserved |
| 5-0 PA_POWER | PA POWER This contents of this register are used as PA target power when XCVR_CTRL[TGT_PWR_SRC] = 00. The valid values for this field are 0,1,2,4,6,8,...,62 (in increasing order of PA power). That is, above 1, only even numbers are permitted in the PA_POWER bitfield. Odd values of 3..63 are not permitted and will result in unexpected behavior. |

45.2.2.4.9 PA RAMP TABLE 0 (PA_RAMP_TBL0)

45.2.2.4.9.1 Address

| Register | Offset |
|--------------|-----------|
| PA_RAMP_TBL0 | 4005C2DCh |

45.2.2.4.9.2 Function

PA Ramp Table 0

45.2.2.4.9.3 Diagram

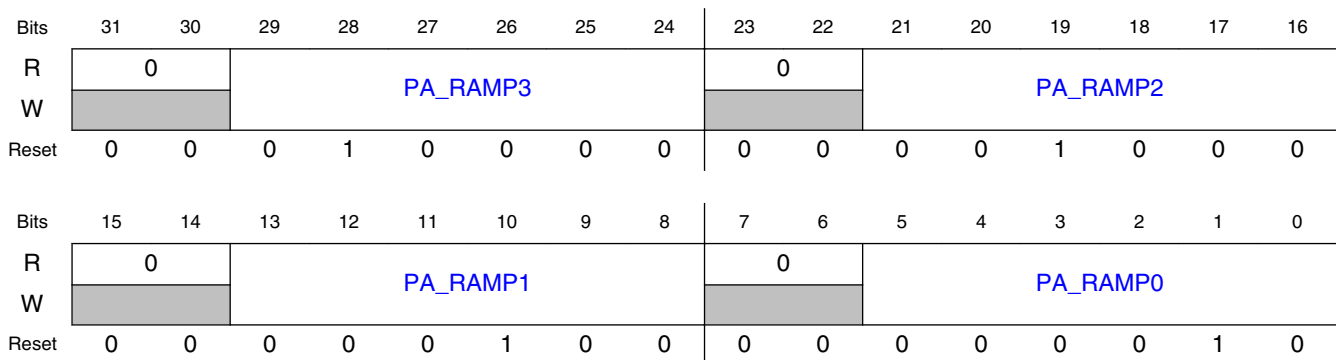

45.2.2.4.9.4 Fields

| Field | Function |
|-------|----------|
| 31-30 | Reserved |

Table continues on the next page...

Radio Register Overview

| Field | Function |
|-------------------|--|
| — | |
| 29-24 PA_RAMP3 | PA_RAMP3 If PA ramping is enabled (TSM_CTRL[PA_RAMP_SEL] > 00), the contents of this register are presented to the PA during PA ramping, for the duration of the fourth ramp step. During PA ramp down, the contents of this register are the PA power value during the fourth-to-last ramp step. In both cases, PA_RAMP3 cannot exceed target power (enforced by PA ramping logic). |
| 23-22 — | Reserved |
| 21-16 PA_RAMP2 | PA_RAMP2 If PA ramping is enabled (TSM_CTRL[PA_RAMP_SEL] > 00), the contents of this register are presented to the PA during PA ramping, for the duration of the third ramp step. During PA ramp down, the contents of this register are the PA power value during the third-to-last ramp step. In both cases, PA_RAMP2 cannot exceed target power (enforced by PA ramping logic). |
| 15-14 — | Reserved |
| 13-8 PA_RAMP1 | PA_RAMP1 If PA ramping is enabled (TSM_CTRL[PA_RAMP_SEL] > 00), the contents of this register are presented to the PA during PA ramping, for the duration of the second ramp step. During PA ramp down, the contents of this register are the PA power value during the second-to-last ramp step. In both cases, PA_RAMP1 cannot exceed target power (enforced by PA ramping logic). |
| 7-6 — | Reserved |
| 5-0 PA_RAMP0 | PA_RAMP0 If PA ramping is enabled (TSM_CTRL[PA_RAMP_SEL] > 00), the contents of this register are presented to the PA during PA ramping, when TSM tx_pa_en transitions low to high, and then for the duration of the first ramp step. During PA ramp down, the contents of this register are the PA power value during the final ramp step. In both cases, PA_RAMP0 cannot exceed target power (enforced by PA ramping logic). When PA ramping is enabled, the contents of PA_RAMP0 are also presented to the PA during sequence-idle conditions. |

45.2.2.4.10 PA RAMP TABLE 1 (PA_RAMP_TBL1)

45.2.2.4.10.1 Address

| Register | Offset |
|--------------|-----------|
| PA_RAMP_TBL1 | 4005C2E0h |

45.2.2.4.10.2 Function

PA Ramp Table 1

45.2.2.4.10.3 Diagram

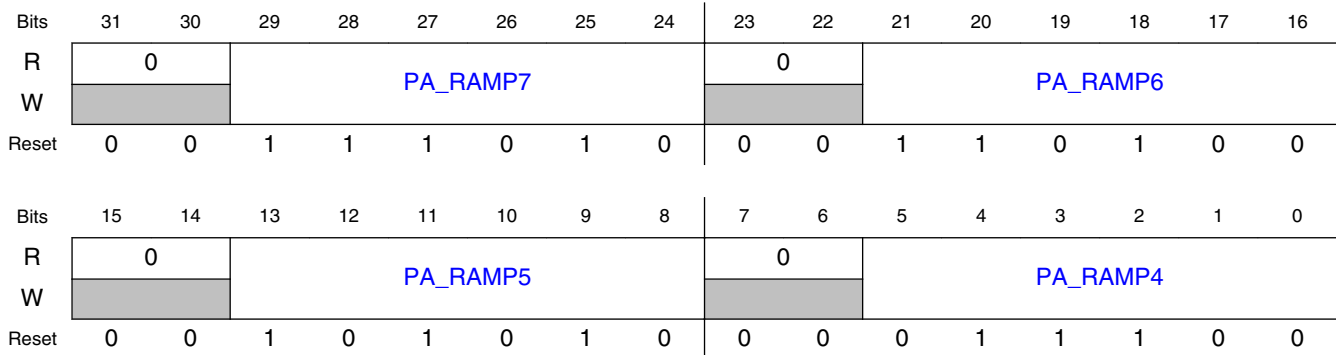

45.2.2.4.10.4 Fields

| Field | Function |
|-------------------|---|
| 31-30 — | Reserved |
| 29-24 PA_RAMP7 | PA_RAMP7 If PA ramping is enabled (TSM_CTRL[PA_RAMP_SEL] > 00), the contents of this register are presented to the PA during PA ramping, for the duration of the eighth (final) ramp step. During PA ramp down, the contents of this register are the PA power value during the eighth-to-last (first) ramp step. In both cases, PA_RAMP7 cannot exceed target power (enforced by PA ramping logic). |
| 23-22 — | Reserved |
| 21-16 PA_RAMP6 | PA_RAMP6 If PA ramping is enabled (TSM_CTRL[PA_RAMP_SEL] > 00), the contents of this register are presented to the PA during PA ramping, for the duration of the seventh ramp step. During PA ramp down, the contents of this register are the PA power value during the seventh-to-last ramp step. In both cases, PA_RAMP6 cannot exceed target power (enforced by PA ramping logic). |
| 15-14 — | Reserved |
| 13-8 PA_RAMP5 | PA_RAMP5 If PA ramping is enabled (TSM_CTRL[PA_RAMP_SEL] > 00), the contents of this register are presented to the PA during PA ramping, for the duration of the sixth ramp step. During PA ramp down, the contents of this register are the PA power value during the sixth-to-last ramp step. In both cases, PA_RAMP5 cannot exceed target power (enforced by PA ramping logic). |
| 7-6 — | Reserved |
| 5-0 PA_RAMP4 | PA_RAMP4 If PA ramping is enabled (TSM_CTRL[PA_RAMP_SEL] > 00), the contents of this register are presented to the PA during PA ramping, for the duration of the fifth ramp step. During PA ramp down, the contents of this register are the PA power value during the fifth-to-last ramp step. In both cases, PA_RAMP4 cannot exceed target power (enforced by PA ramping logic). |

45.2.2.4.11 TSM RECYCLE COUNT (RECYCLE_COUNT)

45.2.2.4.11.1 Address

| Register | Offset |
|---------------|-----------|
| RECYCLE_COUNT | 4005C2E4h |

45.2.2.4.11.2 Function

This register contains the TSM Recycle "Jump-to" points for the 3 types of TSM Recycle

45.2.2.4.11.3 Diagram

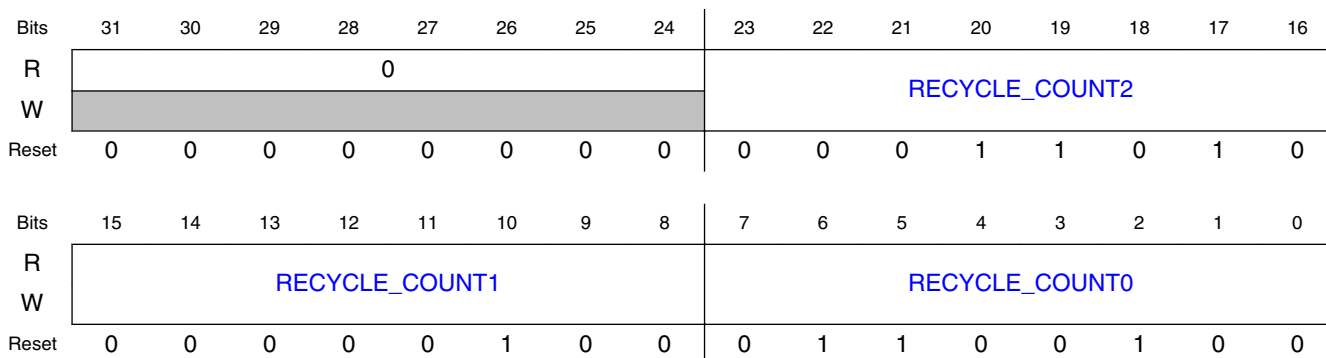

45.2.2.4.11.4 Fields

| Field | Function |
|-------------------------|---|
| 31-24 — | Reserved |
| 23-16 RECYCLE_COUNT2 | TSM RX Recycle Count 2 The RECYCLE_COUNT2[7:0] register determines the TSM count value to which the TSM "recycles" when, in LPPS mode, an LPPS power save cycle completes and the receiver is switched back on, necessitating a foreshortened RX warmup. The intention is for this register to be programmed to a TSM count value that is just prior to the assertion of rx_lna_en, but there are no restrictions on programming this register. An LPPS recycle is a command from the LPPS state machine to TSM, requesting a jump from the TSM ON phase back to a programmable point in the WARMUP phase, and resume counting from there. |
| 15-8 RECYCLE_COUNT1 | TSM RX Recycle Count 1 The RECYCLE_COUNT1[7:0] register determines the TSM count value to which the TSM "recycles" when the 802.15.4 Sequence Manager (ZSM) state "RX_PAN1" is reached and the ZSM asserts tsm_recycle[1] to TSM. The intention is for this register to be programmed to a TSM count value such that the TSM de-asserts, and then re-asserts its "pll_dig_en" output, to effectuate a Dual PAN on-the-fly |

Table continues on the next page...

| Field | Function |
|-----------------------|--|
| | channel change, but there are no restrictions on programming this register. An RX recycle is a command from ZSM to TSM, requesting a jump from the TSM ON phase back to a programmable point in the WARMUP phase, and resume counting from there. A recycle will result from the expiration of the Dual PAN Dwell Timer, at which point an RF-channel change is required. This necessitates the desassertion and reassertion of pll_dig_en, hence the return to the WARMUP phase at the appropriate point. |
| 7-0 RECYCLE_COUNT0 | TSM RX Recycle Count 0 The RECYCLE_COUNT0[7:0] register determines the TSM count value to which the TSM "recycles" when the 802.15.4 Sequence Manager (ZSM) state "RX_CYC" is reached and the ZSM asserts tsm_recycle[0] to TSM. This register also determines the TSM count value to which the TSM recycles when the ZSM state RX_CCCA is reached because tsm_recycle[0] is also asserted in this state. This register also determines the TSM count value to which the TSM recycles when the Generic_FSK Link Layer asserts a tsm_recycle to TSM. The intention is for this register to be programmed to a TSM count value such that the TSM re-asserts its "rx_init" output, but there are no restrictions on programming this register. An RX recycle is a command from any protocol engine to TSM, requesting a jump from the TSM ON phase back to a programmable point in the WARMUP phase, and resume counting from there. A recycle will result from the reception of a packet with bad CRC or one which fails packet-filtering rules, or the end of a CCA operation in Continuous CCA mode which results in a channel indicating "busy". |

45.2.2.4.12 TSM FAST WARMUP CONTROL REGISTER 1 (FAST_CTRL1)

45.2.2.4.12.1 Address

| Register | Offset |
|------------|-----------|
| FAST_CTRL1 | 4005C2E8h |

45.2.2.4.12.2 Function

This register provides enabling and control for Fast TSM Mode

45.2.2.4.12.3 Diagram

| | | | | | | | | | | | | | | | | |
|-------|------------------|----|----|----|----|----|----|----|----|----|----|----|-------------------|-----------------------|----------------------|----------------------|
| Bits | 31 | 30 | 29 | 28 | 27 | 26 | 25 | 24 | 23 | 22 | 21 | 20 | 19 | 18 | 17 | 16 |
| R | 0 | | | | | | | | | | | | | | | |
| W | | | | | | | | | | | | | | | | |
| Reset | 0 | 0 | 0 | 0 | 0 | 0 | 0 | 0 | 0 | 0 | 0 | 0 | 0 | 0 | 0 | 0 |
| Bits | 15 | 14 | 13 | 12 | 11 | 10 | 9 | 8 | 7 | 6 | 5 | 4 | 3 | 2 | 1 | 0 |
| R | FAST_RX2TX_START | | | | | | | | 0 | | | | FAST_WU_CLEA R | FAST_RX2 TX_E N | FAST_RX WU_ EN | FAST_TX WU_ EN |
| W | | | | | | | | | | | | | | | | |
| Reset | 1 | 1 | 1 | 1 | 1 | 1 | 1 | 1 | 0 | 0 | 0 | 0 | 0 | 0 | 0 | 0 |

45.2.2.4.12.4 Fields

| Field | Function |
|------------------------------|---|
| 31-16 — | Reserved |
| 15-8 FAST_RX2TX_ START | TSM "Jump-to" point for a Fast TSM RX-to-TX Transition. This register currently has no functionality. |
| 7-4 — | Reserved |
| 3 FAST_WU_CLE AR | Fast TSM Warmup Clear State This bit clears the RF channel memory in the PLL Digital Block, forcing the next TSM TX Warmup to be normal (not fast), and the next TSM RX Warmup to be normal (not fast), regardless of whether the RF channel has actually changed or not. This bit is not self-clearing. Write '1' to clear channel memory, then write '0' to proceed with TSM operations. |
| 2 FAST_RX2TX_ EN | Fast TSM RX-to-TX Transition Enable This bit currently has no functionality. |
| 1 FAST_RX_WU_ EN | Fast TSM RX Warmup Enable 0b - Fast TSM RX Warmups are disabled 1b - Fast TSM RX Warmups are enabled, if the RF channel has not changed since the last RX warmup, and for BLE mode, the RF channel is not an advertising channel. |
| 0 FAST_TX_WU_ EN | Fast TSM TX Warmup Enable 0b - Fast TSM TX Warmups are disabled 1b - Fast TSM TX Warmups are enabled, if the RF channel has not changed since the last TX warmup, and for BLE mode, the RF channel is not an advertising channel. |

45.2.2.4.13 TSM FAST WARMUP CONTROL REGISTER 2 (FAST_CTRL2)

45.2.2.4.13.1 Address

| Register | Offset |
|------------|-----------|
| FAST_CTRL2 | 4005C2ECh |

45.2.2.4.13.2 Function

This register provides configuration for Fast TSM Mode

45.2.2.4.13.3 Diagram

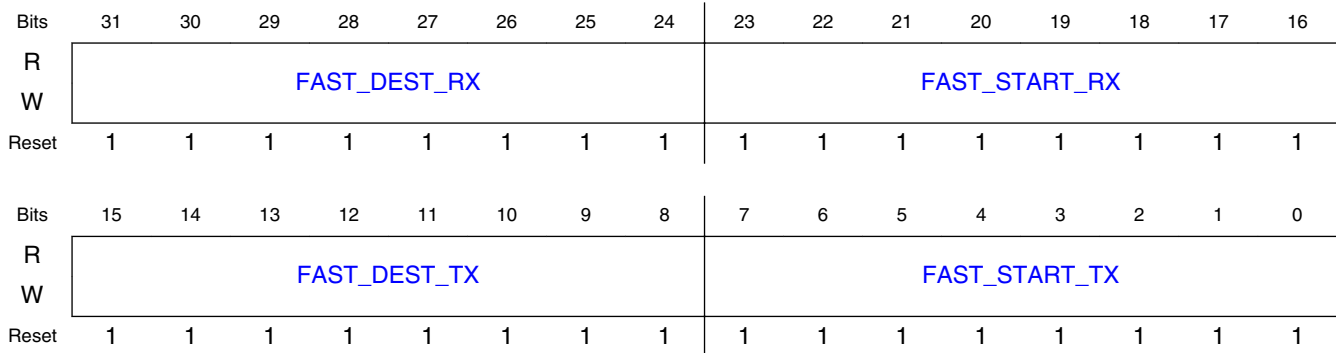

45.2.2.4.13.4 Fields

| Field | Function |
|------------------------|--|
| 31-24 FAST_DEST_RX | <p>Fast TSM RX "Jump-to" Point</p> <p>During a Fast RX Warmup, this value represents the ending TSM count for the portion of the warmup that is to be skipped over. If Fast RX Warmups are enabled, FAST_START_RX[7:0] will never be reached and will instead be replaced by the contents of this register, thereby executing the jump.</p> <p>Example:</p> <p style="padding-left: 40px;">FAST_START_RX = 10 FAST_DEST_RX = 15</p> <p>The TSM will count as follows: ... 7,8,9,15,16,17 ...</p> |
| 23-16 FAST_START_RX | <p>Fast TSM RX "Jump-from" Point</p> <p>During a Fast RX Warmup, this value represents the starting TSM count for the portion of the warmup that is to be skipped over. If Fast RX Warmups are enabled, this count will never be reached; its place in the TSM warmup will be replaced by the contents of FAST_DEST_RX[7:0], thereby executing the jump.</p> |
| 15-8 FAST_DEST_TX | <p>Fast TSM TX "Jump-to" Point</p> <p>During a Fast TX Warmup, this value represents the ending TSM count for the portion of the warmup that is to be skipped over. If Fast TX Warmups are enabled, FAST_START_TX[7:0] will never be reached and will instead be replaced by the contents of this register, thereby executing the jump.</p> <p>Example:</p> <p style="padding-left: 40px;">FAST_START_TX = 10 FAST_DEST_TX = 15</p> <p>The TSM will count as follows: ... 7,8,9,15,16,17 ...</p> |
| 7-0 FAST_START_TX | <p>Fast TSM TX "Jump-from" Point</p> <p>During a Fast TX Warmup, this value represents the starting TSM count for the portion of the warmup that is to be skipped over. If Fast TX Warmups are enabled, this count will never be reached; its place in the TSM warmup will be replaced by the contents of FAST_DEST_TX[7:0], thereby executing the jump.</p> |

45.2.2.4.14 TSM_TIMING00 (TIMING00)

45.2.2.4.14.1 Address

| Register | Offset |
|----------|-----------|
| TIMING00 | 4005C2F0h |

45.2.2.4.14.2 Function

This register contains the timing values to control the assertion and deassertion times for both TX and RX sequences for the BB_LDO_HF_EN TSM signal or signal group.

45.2.2.4.14.3 Diagram

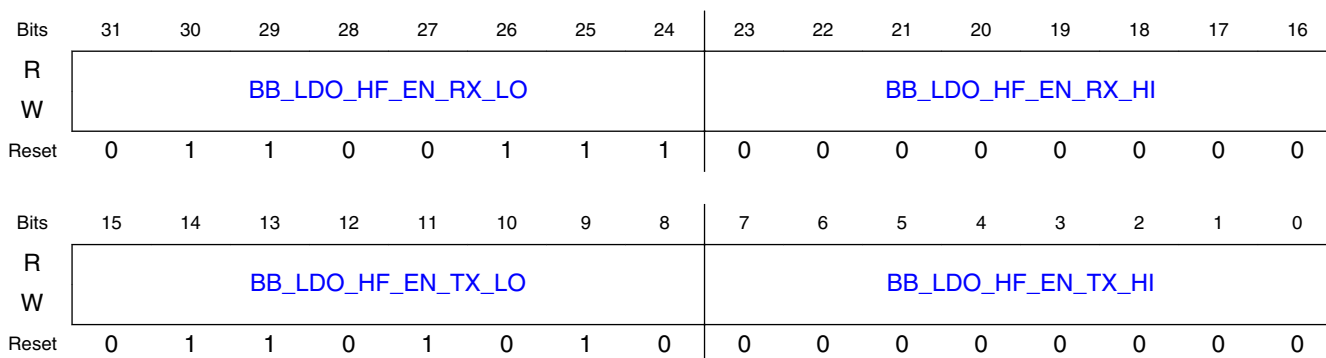

45.2.2.4.14.4 Fields

| Field | Function |
|-----------------------------|---|
| 31-24 BB_LDO_HF_EN_RX_LO | De-assertion time setting for BB_LDO_HF_EN (RX) This field sets the point during a TSM RX sequence (the tsm_count[7:0] value) at which the BB_LDO_HF_EN signal or group will transition from HI to LO. |
| 23-16 BB_LDO_HF_EN_RX_HI | Assertion time setting for BB_LDO_HF_EN (RX) This field sets the point during a TSM RX sequence (the tsm_count[7:0] value) at which the BB_LDO_HF_EN signal or group will transition from LO to HI. |
| 15-8 BB_LDO_HF_EN_TX_LO | De-assertion time setting for BB_LDO_HF_EN (TX) This field sets the point during a TSM TX sequence (the tsm_count[7:0] value) at which the BB_LDO_HF_EN signal or group will transition from HI to LO. |
| 7-0 BB_LDO_HF_EN_TX_HI | Assertion time setting for BB_LDO_HF_EN (TX) This field sets the point during a TSM TX sequence (the tsm_count[7:0] value) at which the BB_LDO_HF_EN signal or group will transition from LO to HI. |

45.2.2.4.15 TSM_TIMING01 (TIMING01)

45.2.2.4.15.1 Address

| Register | Offset |
|----------|-----------|
| TIMING01 | 4005C2F4h |

45.2.2.4.15.2 Diagram

| | | | | | | | | | | | | | | | | |
|-------|------------------------|----|----|----|----|----|----|----|------------------------|----|----|----|----|----|----|----|
| Bits | 31 | 30 | 29 | 28 | 27 | 26 | 25 | 24 | 23 | 22 | 21 | 20 | 19 | 18 | 17 | 16 |
| R | BB_LDO_ADCDAC_EN_RX_LO | | | | | | | | BB_LDO_ADCDAC_EN_RX_HI | | | | | | | |
| W | | | | | | | | | | | | | | | | |
| Reset | 0 | 1 | 1 | 0 | 0 | 1 | 1 | 1 | 0 | 0 | 0 | 0 | 0 | 0 | 0 | 0 |
| Bits | 15 | 14 | 13 | 12 | 11 | 10 | 9 | 8 | 7 | 6 | 5 | 4 | 3 | 2 | 1 | 0 |
| R | BB_LDO_ADCDAC_EN_TX_LO | | | | | | | | BB_LDO_ADCDAC_EN_TX_HI | | | | | | | |
| W | | | | | | | | | | | | | | | | |
| Reset | 0 | 1 | 1 | 0 | 1 | 0 | 1 | 0 | 0 | 0 | 0 | 0 | 0 | 0 | 0 | 0 |

45.2.2.4.15.3 Fields

| Field | Function |
|-------------------------------------|---|
| 31-24 BB_LDO_ADCD AC_EN_RX_LO | De-assertion time setting for BB_LDO_ADCDAC_EN (RX) This field sets the point during a TSM RX sequence (the tsm_count[7:0] value) at which the BB_LDO_ADCDAC_EN signal or group will transition from HI to LO. |
| 23-16 BB_LDO_ADCD AC_EN_RX_HI | Assertion time setting for BB_LDO_ADCDAC_EN (RX) This field sets the point during a TSM RX sequence (the tsm_count[7:0] value) at which the BB_LDO_ADCDAC_EN signal or group will transition from LO to HI. |
| 15-8 BB_LDO_ADCD AC_EN_TX_LO | De-assertion time setting for BB_LDO_ADCDAC_EN (TX) This field sets the point during a TSM TX sequence (the tsm_count[7:0] value) at which the BB_LDO_ADCDAC_EN signal or group will transition from HI to LO. |
| 7-0 BB_LDO_ADCD AC_EN_TX_HI | Assertion time setting for BB_LDO_ADCDAC_EN (TX) This field sets the point during a TSM TX sequence (the tsm_count[7:0] value) at which the BB_LDO_ADCDAC_EN signal or group will transition from LO to HI. |

45.2.2.4.16 TSM_TIMING02 (TIMING02)

45.2.2.4.16.1 Address

| Register | Offset |
|----------|-----------|
| TIMING02 | 4005C2F8h |

45.2.2.4.16.2 Diagram

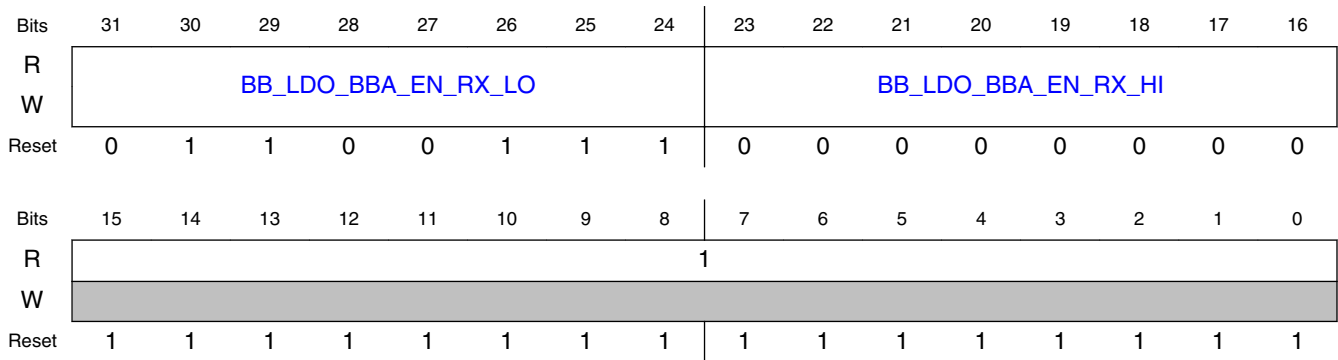

45.2.2.4.16.3 Fields

| Field | Function |
|------------------------------|---|
| 31-24 BB_LDO_BBA_EN_RX_LO | De-assertion time setting for BB_LDO_BBA_EN (RX) This field sets the point during a TSM RX sequence (the tsm_count[7:0] value) at which the BB_LDO_BBA_EN signal or group will transition from HI to LO. |
| 23-16 BB_LDO_BBA_EN_RX_HI | Assertion time setting for BB_LDO_BBA_EN (RX) This field sets the point during a TSM RX sequence (the tsm_count[7:0] value) at which the BB_LDO_BBA_EN signal or group will transition from LO to HI. |
| 15-0 — | Reserved |

45.2.2.4.17 TSM_TIMING03 (TIMING03)

45.2.2.4.17.1 Address

| Register | Offset |
|----------|-----------|
| TIMING03 | 4005C2FCh |

45.2.2.4.17.2 Diagram

| | | | | | | | | | | | | | | | | |
|-------|--------------------|----|----|----|----|----|----|----|--------------------|----|----|----|----|----|----|----|
| Bits | 31 | 30 | 29 | 28 | 27 | 26 | 25 | 24 | 23 | 22 | 21 | 20 | 19 | 18 | 17 | 16 |
| R | BB_LDO_PD_EN_RX_LO | | | | | | | | BB_LDO_PD_EN_RX_HI | | | | | | | |
| W | | | | | | | | | | | | | | | | |
| Reset | 0 | 1 | 1 | 0 | 0 | 1 | 1 | 1 | 0 | 0 | 0 | 0 | 0 | 0 | 0 | 0 |
| Bits | 15 | 14 | 13 | 12 | 11 | 10 | 9 | 8 | 7 | 6 | 5 | 4 | 3 | 2 | 1 | 0 |
| R | BB_LDO_PD_EN_TX_LO | | | | | | | | BB_LDO_PD_EN_TX_HI | | | | | | | |
| W | | | | | | | | | | | | | | | | |
| Reset | 0 | 1 | 1 | 0 | 1 | 0 | 1 | 0 | 0 | 0 | 0 | 0 | 0 | 0 | 0 | 0 |

45.2.2.4.17.3 Fields

| Field | Function |
|-----------------------------|---|
| 31-24 BB_LDO_PD_EN_RX_LO | De-assertion time setting for BB_LDO_PD_EN (RX) This field sets the point during a TSM RX sequence (the tsm_count[7:0] value) at which the BB_LDO_PD_EN signal or group will transition from HI to LO. |
| 23-16 BB_LDO_PD_EN_RX_HI | Assertion time setting for BB_LDO_PD_EN (RX) This field sets the point during a TSM RX sequence (the tsm_count[7:0] value) at which the BB_LDO_PD_EN signal or group will transition from LO to HI. |
| 15-8 BB_LDO_PD_EN_TX_LO | De-assertion time setting for BB_LDO_PD_EN (TX) This field sets the point during a TSM TX sequence (the tsm_count[7:0] value) at which the BB_LDO_PD_EN signal or group will transition from HI to LO. |
| 7-0 BB_LDO_PD_EN_TX_HI | Assertion time setting for BB_LDO_PD_EN (TX) This field sets the point during a TSM TX sequence (the tsm_count[7:0] value) at which the BB_LDO_PD_EN signal or group will transition from LO to HI. |

45.2.2.4.18 TSM_TIMING04 (TIMING04)

45.2.2.4.18.1 Address

| Register | Offset |
|----------|-----------|
| TIMING04 | 4005C300h |

45.2.2.4.18.2 Diagram

| | | | | | | | | | | | | | | | | |
|-------|----------------------|----|----|----|----|----|----|----|----------------------|----|----|----|----|----|----|----|
| Bits | 31 | 30 | 29 | 28 | 27 | 26 | 25 | 24 | 23 | 22 | 21 | 20 | 19 | 18 | 17 | 16 |
| R | BB_LDO_FDBK_EN_RX_LO | | | | | | | | BB_LDO_FDBK_EN_RX_HI | | | | | | | |
| W | | | | | | | | | | | | | | | | |
| Reset | 0 | 1 | 1 | 0 | 0 | 1 | 1 | 1 | 0 | 0 | 0 | 0 | 0 | 0 | 0 | 0 |
| Bits | 15 | 14 | 13 | 12 | 11 | 10 | 9 | 8 | 7 | 6 | 5 | 4 | 3 | 2 | 1 | 0 |
| R | BB_LDO_FDBK_EN_TX_LO | | | | | | | | BB_LDO_FDBK_EN_TX_HI | | | | | | | |
| W | | | | | | | | | | | | | | | | |
| Reset | 0 | 1 | 1 | 0 | 1 | 0 | 1 | 0 | 0 | 0 | 0 | 0 | 0 | 0 | 0 | 0 |

45.2.2.4.18.3 Fields

| Field | Function |
|----------------------|--|
| 31-24 | De-assertion time setting for BB_LDO_FDBK_EN (RX) |
| BB_LDO_FDBK_EN_RX_LO | This field sets the point during a TSM RX sequence (the tsm_count[7:0] value) at which the BB_LDO_FDBK_EN signal or group will transition from HI to LO. |
| 23-16 | Assertion time setting for BB_LDO_FDBK_EN (RX) |
| BB_LDO_FDBK_EN_RX_HI | This field sets the point during a TSM RX sequence (the tsm_count[7:0] value) at which the BB_LDO_FDBK_EN signal or group will transition from LO to HI. |
| 15-8 | De-assertion time setting for BB_LDO_FDBK_EN (TX) |
| BB_LDO_FDBK_EN_TX_LO | This field sets the point during a TSM TX sequence (the tsm_count[7:0] value) at which the BB_LDO_FDBK_EN signal or group will transition from HI to LO. |
| 7-0 | Assertion time setting for BB_LDO_FDBK_EN (TX) |
| BB_LDO_FDBK_EN_TX_HI | This field sets the point during a TSM TX sequence (the tsm_count[7:0] value) at which the BB_LDO_FDBK_EN signal or group will transition from LO to HI. |

45.2.2.4.19 TSM_TIMING05 (TIMING05)

45.2.2.4.19.1 Address

| Register | Offset |
|----------|-----------|
| TIMING05 | 4005C304h |

45.2.2.4.19.2 Diagram

| | | | | | | | | | | | | | | | | |
|-------|-----------------------|----|----|----|----|----|----|----|-----------------------|----|----|----|----|----|----|----|
| Bits | 31 | 30 | 29 | 28 | 27 | 26 | 25 | 24 | 23 | 22 | 21 | 20 | 19 | 18 | 17 | 16 |
| R | BB_LDO_VCOLO_EN_RX_LO | | | | | | | | BB_LDO_VCOLO_EN_RX_HI | | | | | | | |
| W | | | | | | | | | | | | | | | | |
| Reset | 0 | 1 | 1 | 0 | 0 | 1 | 1 | 1 | 0 | 0 | 0 | 0 | 0 | 0 | 0 | 0 |
| Bits | 15 | 14 | 13 | 12 | 11 | 10 | 9 | 8 | 7 | 6 | 5 | 4 | 3 | 2 | 1 | 0 |
| R | BB_LDO_VCOLO_EN_TX_LO | | | | | | | | BB_LDO_VCOLO_EN_TX_HI | | | | | | | |
| W | | | | | | | | | | | | | | | | |
| Reset | 0 | 1 | 1 | 0 | 1 | 0 | 1 | 0 | 0 | 0 | 0 | 0 | 0 | 0 | 0 | 0 |

45.2.2.4.19.3 Fields

| Field | Function |
|--------------------------------|---|
| 31-24 BB_LDO_VCOLO_EN_RX_LO | De-assertion time setting for BB_LDO_VCOLO_EN (RX) This field sets the point during a TSM RX sequence (the tsm_count[7:0] value) at which the BB_LDO_VCOLO_EN signal or group will transition from HI to LO. |
| 23-16 BB_LDO_VCOLO_EN_RX_HI | Assertion time setting for BB_LDO_VCOLO_EN (RX) This field sets the point during a TSM RX sequence (the tsm_count[7:0] value) at which the BB_LDO_VCOLO_EN signal or group will transition from LO to HI. |
| 15-8 BB_LDO_VCOLO_EN_TX_LO | De-assertion time setting for BB_LDO_VCOLO_EN (TX) This field sets the point during a TSM TX sequence (the tsm_count[7:0] value) at which the BB_LDO_VCOLO_EN signal or group will transition from HI to LO. |
| 7-0 BB_LDO_VCOLO_EN_TX_HI | Assertion time setting for BB_LDO_VCOLO_EN (TX) This field sets the point during a TSM TX sequence (the tsm_count[7:0] value) at which the BB_LDO_VCOLO_EN signal or group will transition from LO to HI. |

45.2.2.4.20 TSM_TIMING06 (TIMING06)

45.2.2.4.20.1 Address

| Register | Offset |
|----------|-----------|
| TIMING06 | 4005C308h |

45.2.2.4.20.2 Diagram

| | | | | | | | | | | | | | | | | |
|-------|-----------------------|----|----|----|----|----|----|----|-----------------------|----|----|----|----|----|----|----|
| Bits | 31 | 30 | 29 | 28 | 27 | 26 | 25 | 24 | 23 | 22 | 21 | 20 | 19 | 18 | 17 | 16 |
| R | BB_LDO_VTREF_EN_RX_LO | | | | | | | | BB_LDO_VTREF_EN_RX_HI | | | | | | | |
| W | | | | | | | | | | | | | | | | |
| Reset | 0 | 1 | 1 | 0 | 0 | 1 | 1 | 1 | 0 | 0 | 0 | 0 | 0 | 0 | 0 | 0 |
| Bits | 15 | 14 | 13 | 12 | 11 | 10 | 9 | 8 | 7 | 6 | 5 | 4 | 3 | 2 | 1 | 0 |
| R | BB_LDO_VTREF_EN_TX_LO | | | | | | | | BB_LDO_VTREF_EN_TX_HI | | | | | | | |
| W | | | | | | | | | | | | | | | | |
| Reset | 0 | 1 | 1 | 0 | 1 | 0 | 1 | 0 | 0 | 0 | 0 | 0 | 0 | 0 | 0 | 0 |

45.2.2.4.20.3 Fields

| Field | Function |
|--------------------------------|---|
| 31-24 BB_LDO_VTREF_EN_RX_LO | De-assertion time setting for BB_LDO_VTREF_EN (RX) This field sets the point during a TSM RX sequence (the tsm_count[7:0] value) at which the BB_LDO_VTREF_EN signal or group will transition from HI to LO. |
| 23-16 BB_LDO_VTREF_EN_RX_HI | Assertion time setting for BB_LDO_VTREF_EN (RX) This field sets the point during a TSM RX sequence (the tsm_count[7:0] value) at which the BB_LDO_VTREF_EN signal or group will transition from LO to HI. |
| 15-8 BB_LDO_VTREF_EN_TX_LO | De-assertion time setting for BB_LDO_VTREF_EN (TX) This field sets the point during a TSM TX sequence (the tsm_count[7:0] value) at which the BB_LDO_VTREF_EN signal or group will transition from HI to LO. |
| 7-0 BB_LDO_VTREF_EN_TX_HI | Assertion time setting for BB_LDO_VTREF_EN (TX) This field sets the point during a TSM TX sequence (the tsm_count[7:0] value) at which the BB_LDO_VTREF_EN signal or group will transition from LO to HI. |

45.2.2.4.21 TSM_TIMING07 (TIMING07)

45.2.2.4.21.1 Address

| Register | Offset |
|----------|-----------|
| TIMING07 | 4005C30Ch |

45.2.2.4.21.2 Diagram

| | | | | | | | | | | | | | | | | |
|-------|----------------------------|----|----|----|----|----|----|----|----------------------------|----|----|----|----|----|----|----|
| Bits | 31 | 30 | 29 | 28 | 27 | 26 | 25 | 24 | 23 | 22 | 21 | 20 | 19 | 18 | 17 | 16 |
| R | BB_LDO_FDBK_BLEED_EN_RX_LO | | | | | | | | BB_LDO_FDBK_BLEED_EN_RX_HI | | | | | | | |
| W | | | | | | | | | | | | | | | | |
| Reset | 0 | 0 | 0 | 0 | 0 | 1 | 0 | 1 | 0 | 0 | 0 | 0 | 0 | 0 | 0 | 0 |
| Bits | 15 | 14 | 13 | 12 | 11 | 10 | 9 | 8 | 7 | 6 | 5 | 4 | 3 | 2 | 1 | 0 |
| R | BB_LDO_FDBK_BLEED_EN_TX_LO | | | | | | | | BB_LDO_FDBK_BLEED_EN_TX_HI | | | | | | | |
| W | | | | | | | | | | | | | | | | |
| Reset | 0 | 0 | 0 | 0 | 0 | 1 | 0 | 1 | 0 | 0 | 0 | 0 | 0 | 0 | 0 | 0 |

45.2.2.4.21.3 Fields

| Field | Function |
|-------------------------------------|---|
| 31-24 BB_LDO_FDBK_BLEED_EN_RX_LO | De-assertion time setting for BB_LDO_FDBK_BLEED_EN (RX) This field sets the point during a TSM RX sequence (the tsm_count[7:0] value) at which the BB_LDO_FDBK_BLEED_EN signal or group will transition from HI to LO. |
| 23-16 BB_LDO_FDBK_BLEED_EN_RX_HI | Assertion time setting for BB_LDO_FDBK_BLEED_EN (RX) This field sets the point during a TSM RX sequence (the tsm_count[7:0] value) at which the BB_LDO_FDBK_BLEED_EN signal or group will transition from LO to HI. |
| 15-8 BB_LDO_FDBK_BLEED_EN_TX_LO | De-assertion time setting for BB_LDO_FDBK_BLEED_EN (TX) This field sets the point during a TSM TX sequence (the tsm_count[7:0] value) at which the BB_LDO_FDBK_BLEED_EN signal or group will transition from HI to LO. |
| 7-0 BB_LDO_FDBK_BLEED_EN_TX_HI | Assertion time setting for BB_LDO_FDBK_BLEED_EN (TX) This field sets the point during a TSM TX sequence (the tsm_count[7:0] value) at which the BB_LDO_FDBK_BLEED_EN signal or group will transition from LO to HI. |

45.2.2.4.22 TSM_TIMING08 (TIMING08)

45.2.2.4.22.1 Address

| Register | Offset |
|----------|-----------|
| TIMING08 | 4005C310h |

45.2.2.4.22.2 Diagram

| | | | | | | | | | | | | | | | | |
|-------|-----------------------------|----|----|----|----|----|----|----|-----------------------------|----|----|----|----|----|----|----|
| Bits | 31 | 30 | 29 | 28 | 27 | 26 | 25 | 24 | 23 | 22 | 21 | 20 | 19 | 18 | 17 | 16 |
| R | BB_LDO_VCOLO_BLEED_EN_RX_LO | | | | | | | | BB_LDO_VCOLO_BLEED_EN_RX_HI | | | | | | | |
| W | | | | | | | | | | | | | | | | |
| Reset | 0 | 0 | 0 | 0 | 0 | 0 | 1 | 1 | 0 | 0 | 0 | 0 | 0 | 0 | 0 | 0 |
| Bits | 15 | 14 | 13 | 12 | 11 | 10 | 9 | 8 | 7 | 6 | 5 | 4 | 3 | 2 | 1 | 0 |
| R | BB_LDO_VCOLO_BLEED_EN_TX_LO | | | | | | | | BB_LDO_VCOLO_BLEED_EN_TX_HI | | | | | | | |
| W | | | | | | | | | | | | | | | | |
| Reset | 0 | 0 | 0 | 0 | 0 | 0 | 1 | 1 | 0 | 0 | 0 | 0 | 0 | 0 | 0 | 0 |

45.2.2.4.22.3 Fields

| Field | Function |
|--------------------------------------|---|
| 31-24 BB_LDO_VCOLO_BLEED_EN_RX_LO | De-assertion time setting for BB_LDO_VCOLO_BLEED_EN (RX) This field sets the point during a TSM RX sequence (the tsm_count[7:0] value) at which the BB_LDO_VCOLO_BLEED_EN signal or group will transition from HI to LO. |
| 23-16 BB_LDO_VCOLO_BLEED_EN_RX_HI | Assertion time setting for BB_LDO_VCOLO_BLEED_EN (RX) This field sets the point during a TSM RX sequence (the tsm_count[7:0] value) at which the BB_LDO_VCOLO_BLEED_EN signal or group will transition from LO to HI. |
| 15-8 BB_LDO_VCOLO_BLEED_EN_TX_LO | De-assertion time setting for BB_LDO_VCOLO_BLEED_EN (TX) This field sets the point during a TSM TX sequence (the tsm_count[7:0] value) at which the BB_LDO_VCOLO_BLEED_EN signal or group will transition from HI to LO. |
| 7-0 BB_LDO_VCOLO_BLEED_EN_TX_HI | Assertion time setting for BB_LDO_VCOLO_BLEED_EN (TX) This field sets the point during a TSM TX sequence (the tsm_count[7:0] value) at which the BB_LDO_VCOLO_BLEED_EN signal or group will transition from LO to HI. |

45.2.2.4.23 TSM_TIMING09 (TIMING09)

45.2.2.4.23.1 Address

| Register | Offset |
|----------|-----------|
| TIMING09 | 4005C314h |

45.2.2.4.23.2 Diagram

| | | | | | | | | | | | | | | | | |
|-------|----------------------------------|----|----|----|----|----|----|----|----------------------------------|----|----|----|----|----|----|----|
| Bits | 31 | 30 | 29 | 28 | 27 | 26 | 25 | 24 | 23 | 22 | 21 | 20 | 19 | 18 | 17 | 16 |
| R | BB_LDO_VCOLO_FASTCHARGE_EN_RX_LO | | | | | | | | BB_LDO_VCOLO_FASTCHARGE_EN_RX_HI | | | | | | | |
| W | | | | | | | | | | | | | | | | |
| Reset | 0 | 0 | 0 | 0 | 0 | 0 | 1 | 1 | 0 | 0 | 0 | 0 | 0 | 0 | 0 | 0 |
| Bits | 15 | 14 | 13 | 12 | 11 | 10 | 9 | 8 | 7 | 6 | 5 | 4 | 3 | 2 | 1 | 0 |
| R | BB_LDO_VCOLO_FASTCHARGE_EN_TX_LO | | | | | | | | BB_LDO_VCOLO_FASTCHARGE_EN_TX_HI | | | | | | | |
| W | | | | | | | | | | | | | | | | |
| Reset | 0 | 0 | 0 | 0 | 0 | 0 | 1 | 1 | 0 | 0 | 0 | 0 | 0 | 0 | 0 | 0 |

45.2.2.4.23.3 Fields

| Field | Function |
|---|---|
| 31-24 BB_LDO_VCOLO_FASTCHARGE_EN_RX_LO | De-assertion time setting for BB_LDO_VCOLO_FASTCHARGE_EN (RX) This field sets the point during a TSM RX sequence (the tsm_count[7:0] value) at which the BB_LDO_VCOLO_FASTCHARGE_EN signal or group will transition from HI to LO. |
| 23-16 BB_LDO_VCOLO_FASTCHARGE_EN_RX_HI | Assertion time setting for BB_LDO_VCOLO_FASTCHARGE_EN (RX) This field sets the point during a TSM RX sequence (the tsm_count[7:0] value) at which the BB_LDO_VCOLO_FASTCHARGE_EN signal or group will transition from LO to HI. |
| 15-8 BB_LDO_VCOLO_FASTCHARGE_EN_TX_LO | De-assertion time setting for BB_LDO_VCOLO_FASTCHARGE_EN (TX) This field sets the point during a TSM TX sequence (the tsm_count[7:0] value) at which the BB_LDO_VCOLO_FASTCHARGE_EN signal or group will transition from HI to LO. |
| 7-0 BB_LDO_VCOLO_FASTCHARGE_EN_TX_HI | Assertion time setting for BB_LDO_VCOLO_FASTCHARGE_EN (TX) This field sets the point during a TSM TX sequence (the tsm_count[7:0] value) at which the BB_LDO_VCOLO_FASTCHARGE_EN signal or group will transition from LO to HI. |

45.2.2.4.24 TSM_TIMING10 (TIMING10)

45.2.2.4.24.1 Address

| Register | Offset |
|----------|-----------|
| TIMING10 | 4005C318h |

45.2.2.4.24.2 Diagram

| | | | | | | | | | | | | | | | | |
|-------|------------------------------|----|----|----|----|----|----|----|------------------------------|----|----|----|----|----|----|----|
| Bits | 31 | 30 | 29 | 28 | 27 | 26 | 25 | 24 | 23 | 22 | 21 | 20 | 19 | 18 | 17 | 16 |
| R | BB_XTAL_PLL_REF_CLK_EN_RX_LO | | | | | | | | BB_XTAL_PLL_REF_CLK_EN_RX_HI | | | | | | | |
| W | | | | | | | | | | | | | | | | |
| Reset | 0 | 1 | 1 | 0 | 0 | 1 | 1 | 1 | 0 | 0 | 0 | 0 | 0 | 0 | 1 | 1 |
| Bits | 15 | 14 | 13 | 12 | 11 | 10 | 9 | 8 | 7 | 6 | 5 | 4 | 3 | 2 | 1 | 0 |
| R | BB_XTAL_PLL_REF_CLK_EN_TX_LO | | | | | | | | BB_XTAL_PLL_REF_CLK_EN_TX_HI | | | | | | | |
| W | | | | | | | | | | | | | | | | |
| Reset | 0 | 1 | 1 | 0 | 1 | 0 | 1 | 0 | 0 | 0 | 0 | 0 | 0 | 0 | 1 | 1 |

45.2.2.4.24.3 Fields

| Field | Function |
|---------------------------------------|---|
| 31-24 BB_XTAL_PLL_REF_CLK_EN_RX_LO | De-assertion time setting for BB_XTAL_PLL_REF_CLK_EN (RX) This field sets the point during a TSM RX sequence (the tsm_count[7:0] value) at which the BB_XTAL_PLL_REF_CLK_EN signal or group will transition from HI to LO. |
| 23-16 BB_XTAL_PLL_REF_CLK_EN_RX_HI | Assertion time setting for BB_XTAL_PLL_REF_CLK_EN (RX) This field sets the point during a TSM RX sequence (the tsm_count[7:0] value) at which the BB_XTAL_PLL_REF_CLK_EN signal or group will transition from LO to HI. |
| 15-8 BB_XTAL_PLL_REF_CLK_EN_TX_LO | De-assertion time setting for BB_XTAL_PLL_REF_CLK_EN (TX) This field sets the point during a TSM TX sequence (the tsm_count[7:0] value) at which the BB_XTAL_PLL_REF_CLK_EN signal or group will transition from HI to LO. |
| 7-0 BB_XTAL_PLL_REF_CLK_EN_TX_HI | Assertion time setting for BB_XTAL_PLL_REF_CLK_EN (TX) This field sets the point during a TSM TX sequence (the tsm_count[7:0] value) at which the BB_XTAL_PLL_REF_CLK_EN signal or group will transition from LO to HI. |

45.2.2.4.25 TSM_TIMING11 (TIMING11)

45.2.2.4.25.1 Address

| Register | Offset |
|----------|-----------|
| TIMING11 | 4005C31Ch |

45.2.2.4.25.2 Diagram

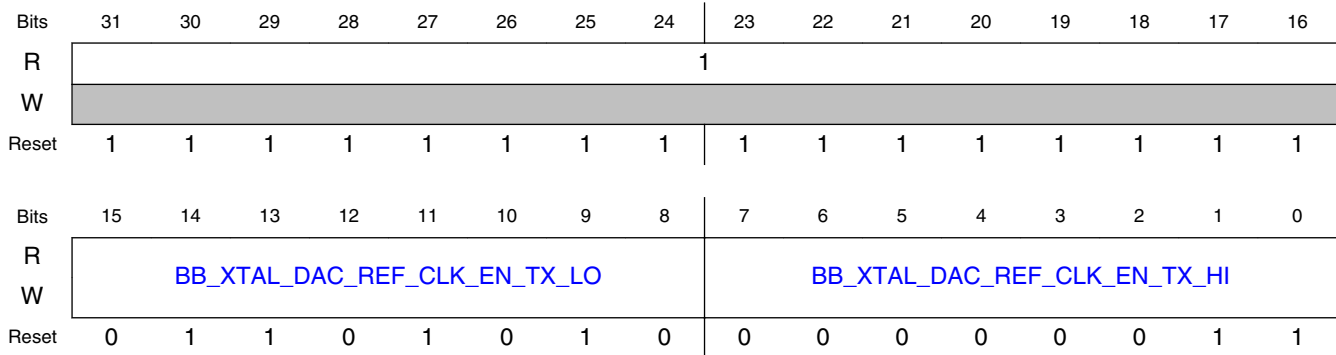

45.2.2.4.25.3 Fields

| Field | Function |
|--------------------------------------|---|
| 31-16 — | Reserved |
| 15-8 BB_XTAL_DAC_REF_CLK_EN_TX_LO | De-assertion time setting for BB_XTAL_DAC_REF_CLK_EN (TX) This field sets the point during a TSM TX sequence (the tsm_count[7:0] value) at which the BB_XTAL_DAC_REF_CLK_EN signal or group will transition from HI to LO. |
| 7-0 BB_XTAL_DAC_REF_CLK_EN_TX_HI | Assertion time setting for BB_XTAL_DAC_REF_CLK_EN (TX) This field sets the point during a TSM TX sequence (the tsm_count[7:0] value) at which the BB_XTAL_DAC_REF_CLK_EN signal or group will transition from LO to HI. |

45.2.2.4.26 TSM_TIMING12 (TIMING12)

45.2.2.4.26.1 Address

| Register | Offset |
|----------|-----------|
| TIMING12 | 4005C320h |

45.2.2.4.26.2 Diagram

| | | | | | | | | | | | | | | | | |
|-------|----------------------------------|----|----|----|----|----|----|----|----------------------------------|----|----|----|----|----|----|----|
| Bits | 31 | 30 | 29 | 28 | 27 | 26 | 25 | 24 | 23 | 22 | 21 | 20 | 19 | 18 | 17 | 16 |
| R | RXTX_AUXPLL_VCO_REF_CLK_EN_RX_LO | | | | | | | | RXTX_AUXPLL_VCO_REF_CLK_EN_RX_HI | | | | | | | |
| W | | | | | | | | | | | | | | | | |
| Reset | 0 | 1 | 1 | 0 | 0 | 1 | 1 | 1 | 0 | 0 | 0 | 0 | 0 | 0 | 1 | 1 |
| Bits | 15 | 14 | 13 | 12 | 11 | 10 | 9 | 8 | 7 | 6 | 5 | 4 | 3 | 2 | 1 | 0 |
| R | 1 | | | | | | | | | | | | | | | |
| W | | | | | | | | | | | | | | | | |
| Reset | 1 | 1 | 1 | 1 | 1 | 1 | 1 | 1 | 1 | 1 | 1 | 1 | 1 | 1 | 1 | 1 |

45.2.2.4.26.3 Fields

| Field | Function |
|---|---|
| 31-24 RXTX_AUXPLL_VCO_REF_CLK_EN_RX_LO | De-assertion time setting for RXTX_AUXPLL_VCO_REF_CLK_EN (RX) This field sets the point during a TSM RX sequence (the tsm_count[7:0] value) at which the RXTX_AUXPLL_VCO_REF_CLK_EN signal or group will transition from HI to LO. |
| 23-16 RXTX_AUXPLL_VCO_REF_CLK_EN_RX_HI | Assertion time setting for RXTX_AUXPLL_VCO_REF_CLK_EN (RX) This field sets the point during a TSM RX sequence (the tsm_count[7:0] value) at which the RXTX_AUXPLL_VCO_REF_CLK_EN signal or group will transition from LO to HI. |
| 15-0 — | Reserved |

45.2.2.4.27 TSM_TIMING13 (TIMING13)

45.2.2.4.27.1 Address

| Register | Offset |
|----------|-----------|
| TIMING13 | 4005C324h |

45.2.2.4.27.2 Diagram

| | | | | | | | | | | | | | | | | |
|-------|--------------------------|----|----|----|----|----|----|----|--------------------------|----|----|----|----|----|----|----|
| Bits | 31 | 30 | 29 | 28 | 27 | 26 | 25 | 24 | 23 | 22 | 21 | 20 | 19 | 18 | 17 | 16 |
| R | SY_VCO_AUTOTUNE_EN_RX_LO | | | | | | | | SY_VCO_AUTOTUNE_EN_RX_HI | | | | | | | |
| W | | | | | | | | | | | | | | | | |
| Reset | 0 | 0 | 0 | 1 | 0 | 1 | 1 | 0 | 0 | 0 | 0 | 0 | 0 | 0 | 0 | 0 |
| Bits | 15 | 14 | 13 | 12 | 11 | 10 | 9 | 8 | 7 | 6 | 5 | 4 | 3 | 2 | 1 | 0 |
| R | SY_VCO_AUTOTUNE_EN_TX_LO | | | | | | | | SY_VCO_AUTOTUNE_EN_TX_HI | | | | | | | |
| W | | | | | | | | | | | | | | | | |
| Reset | 0 | 1 | 0 | 0 | 1 | 0 | 1 | 0 | 0 | 0 | 0 | 0 | 0 | 0 | 0 | 0 |

45.2.2.4.27.3 Fields

| Field | Function |
|---|---|
| 31-24 SY_VCO_AUTO TUNE_EN_RX_ LO | De-assertion time setting for SY_VCO_AUTOTUNE_EN (RX) This field sets the point during a TSM RX sequence (the tsm_count[7:0] value) at which the SY_VCO_AUTOTUNE_EN signal or group will transition from HI to LO. |
| 23-16 SY_VCO_AUTO TUNE_EN_RX_ HI | Assertion time setting for SY_VCO_AUTOTUNE_EN (RX) This field sets the point during a TSM RX sequence (the tsm_count[7:0] value) at which the SY_VCO_AUTOTUNE_EN signal or group will transition from LO to HI. |
| 15-8 SY_VCO_AUTO TUNE_EN_TX_ LO | De-assertion time setting for SY_VCO_AUTOTUNE_EN (TX) This field sets the point during a TSM TX sequence (the tsm_count[7:0] value) at which the SY_VCO_AUTOTUNE_EN signal or group will transition from HI to LO. |
| 7-0 SY_VCO_AUTO TUNE_EN_TX_ HI | Assertion time setting for SY_VCO_AUTOTUNE_EN (TX) This field sets the point during a TSM TX sequence (the tsm_count[7:0] value) at which the SY_VCO_AUTOTUNE_EN signal or group will transition from LO to HI. |

45.2.2.4.28 TSM_TIMING14 (TIMING14)

45.2.2.4.28.1 Address

| Register | Offset |
|----------|-----------|
| TIMING14 | 4005C328h |

45.2.2.4.28.2 Diagram

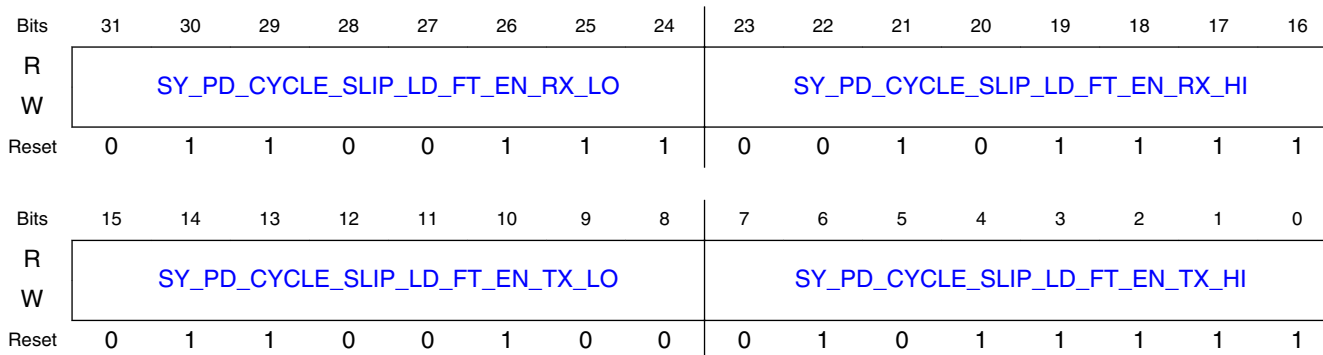

45.2.2.4.28.3 Fields

| Field | Function |
|--|---|
| 31-24 SY_PD_CYCLE_SLIP_LD_FT_EN_RX_LO | De-assertion time setting for SY_PD_CYCLE_SLIP_LD_FT_EN (RX) This field sets the point during a TSM RX sequence (the tsm_count[7:0] value) at which the SY_PD_CYCLE_SLIP_LD_FT_EN signal or group will transition from HI to LO. |
| 23-16 SY_PD_CYCLE_SLIP_LD_FT_EN_RX_HI | Assertion time setting for SY_PD_CYCLE_SLIP_LD_FT_EN (RX) This field sets the point during a TSM RX sequence (the tsm_count[7:0] value) at which the SY_PD_CYCLE_SLIP_LD_FT_EN signal or group will transition from LO to HI. |
| 15-8 SY_PD_CYCLE_SLIP_LD_FT_EN_TX_LO | De-assertion time setting for SY_PD_CYCLE_SLIP_LD_FT_EN (TX) This field sets the point during a TSM TX sequence (the tsm_count[7:0] value) at which the SY_PD_CYCLE_SLIP_LD_FT_EN signal or group will transition from HI to LO. |
| 7-0 SY_PD_CYCLE_SLIP_LD_FT_EN_TX_HI | Assertion time setting for SY_PD_CYCLE_SLIP_LD_FT_EN (TX) This field sets the point during a TSM TX sequence (the tsm_count[7:0] value) at which the SY_PD_CYCLE_SLIP_LD_FT_EN signal or group will transition from LO to HI. |

45.2.2.4.29 TSM_TIMING15 (TIMING15)

45.2.2.4.29.1 Address

| Register | Offset |
|----------|-----------|
| TIMING15 | 4005C32Ch |

45.2.2.4.29.2 Diagram

| | | | | | | | | | | | | | | | | |
|-------|-----------------|----|----|----|----|----|----|----|-----------------|----|----|----|----|----|----|----|
| Bits | 31 | 30 | 29 | 28 | 27 | 26 | 25 | 24 | 23 | 22 | 21 | 20 | 19 | 18 | 17 | 16 |
| R | SY_VCO_EN_RX_LO | | | | | | | | SY_VCO_EN_RX_HI | | | | | | | |
| W | | | | | | | | | | | | | | | | |
| Reset | 0 | 1 | 1 | 0 | 0 | 1 | 1 | 1 | 0 | 0 | 0 | 0 | 0 | 0 | 1 | 1 |
| Bits | 15 | 14 | 13 | 12 | 11 | 10 | 9 | 8 | 7 | 6 | 5 | 4 | 3 | 2 | 1 | 0 |
| R | SY_VCO_EN_TX_LO | | | | | | | | SY_VCO_EN_TX_HI | | | | | | | |
| W | | | | | | | | | | | | | | | | |
| Reset | 0 | 1 | 1 | 0 | 1 | 0 | 1 | 0 | 0 | 0 | 0 | 0 | 0 | 0 | 1 | 1 |

45.2.2.4.29.3 Fields

| Field | Function |
|-----------------|---|
| 31-24 | De-assertion time setting for SY_VCO_EN (RX) |
| SY_VCO_EN_RX_LO | This field sets the point during a TSM RX sequence (the tsm_count[7:0] value) at which the SY_VCO_EN signal or group will transition from HI to LO. |
| 23-16 | Assertion time setting for SY_VCO_EN (RX) |
| SY_VCO_EN_RX_HI | This field sets the point during a TSM RX sequence (the tsm_count[7:0] value) at which the SY_VCO_EN signal or group will transition from LO to HI. |
| 15-8 | De-assertion time setting for SY_VCO_EN (TX) |
| SY_VCO_EN_TX_LO | This field sets the point during a TSM TX sequence (the tsm_count[7:0] value) at which the SY_VCO_EN signal or group will transition from HI to LO. |
| 7-0 | Assertion time setting for SY_VCO_EN (TX) |
| SY_VCO_EN_TX_HI | This field sets the point during a TSM TX sequence (the tsm_count[7:0] value) at which the SY_VCO_EN signal or group will transition from LO to HI. |

45.2.2.4.30 TSM_TIMING16 (TIMING16)

45.2.2.4.30.1 Address

| Register | Offset |
|----------|-----------|
| TIMING16 | 4005C330h |

45.2.2.4.30.2 Diagram

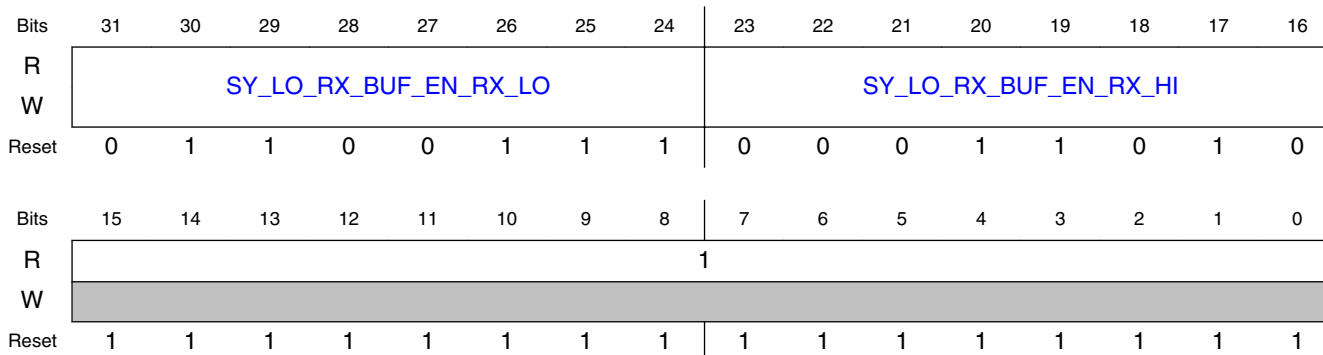

45.2.2.4.30.3 Fields

| Field | Function |
|--------------------------------|---|
| 31-24 SY_LO_RX_BUF_EN_RX_LO | De-assertion time setting for SY_LO_RX_BUF_EN (RX) This field sets the point during a TSM RX sequence (the tsm_count[7:0] value) at which the SY_LO_RX_BUF_EN signal or group will transition from HI to LO. |
| 23-16 SY_LO_RX_BUF_EN_RX_HI | Assertion time setting for SY_LO_RX_BUF_EN (RX) This field sets the point during a TSM RX sequence (the tsm_count[7:0] value) at which the SY_LO_RX_BUF_EN signal or group will transition from LO to HI. |
| 15-0 — | Reserved |

45.2.2.4.31 TSM_TIMING17 (TIMING17)

45.2.2.4.31.1 Address

| Register | Offset |
|----------|-----------|
| TIMING17 | 4005C334h |

45.2.2.4.31.2 Diagram

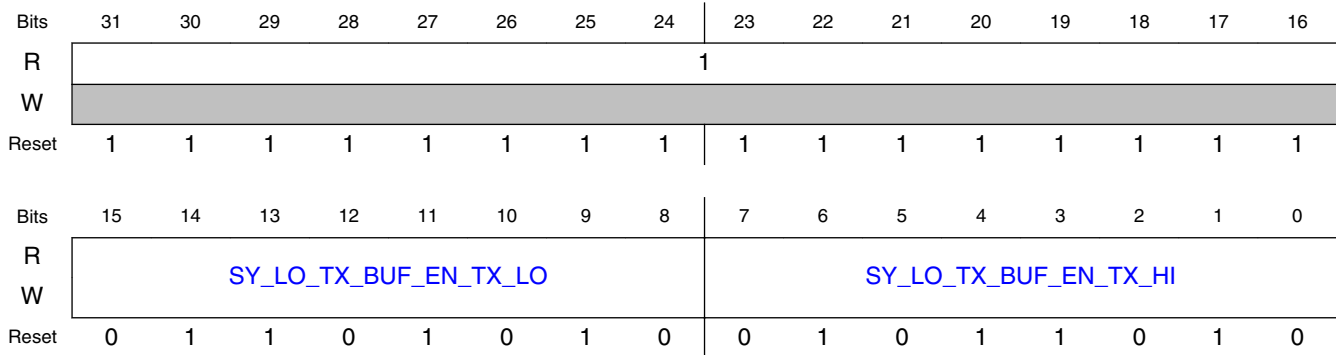

45.2.2.4.31.3 Fields

| Field | Function |
|-------------------------------|---|
| 31-16 — | Reserved |
| 15-8 SY_LO_TX_BUF_EN_TX_LO | De-assertion time setting for SY_LO_TX_BUF_EN (TX) This field sets the point during a TSM TX sequence (the tsm_count[7:0] value) at which the SY_LO_TX_BUF_EN signal or group will transition from HI to LO. |
| 7-0 SY_LO_TX_BUF_EN_TX_HI | Assertion time setting for SY_LO_TX_BUF_EN (TX) This field sets the point during a TSM TX sequence (the tsm_count[7:0] value) at which the SY_LO_TX_BUF_EN signal or group will transition from LO to HI. |

45.2.2.4.32 TSM_TIMING18 (TIMING18)

45.2.2.4.32.1 Address

| Register | Offset |
|----------|-----------|
| TIMING18 | 4005C338h |

45.2.2.4.32.2 Diagram

| | | | | | | | | | | | | | | | | |
|-------|------------------|----|----|----|----|----|----|----|------------------|----|----|----|----|----|----|----|
| Bits | 31 | 30 | 29 | 28 | 27 | 26 | 25 | 24 | 23 | 22 | 21 | 20 | 19 | 18 | 17 | 16 |
| R | SY_DIVN_EN_RX_LO | | | | | | | | SY_DIVN_EN_RX_HI | | | | | | | |
| W | | | | | | | | | | | | | | | | |
| Reset | 0 | 1 | 1 | 0 | 0 | 1 | 1 | 1 | 0 | 0 | 0 | 0 | 0 | 1 | 0 | 1 |
| Bits | 15 | 14 | 13 | 12 | 11 | 10 | 9 | 8 | 7 | 6 | 5 | 4 | 3 | 2 | 1 | 0 |
| R | SY_DIVN_EN_TX_LO | | | | | | | | SY_DIVN_EN_TX_HI | | | | | | | |
| W | | | | | | | | | | | | | | | | |
| Reset | 0 | 1 | 1 | 0 | 1 | 0 | 1 | 0 | 0 | 0 | 0 | 0 | 0 | 1 | 0 | 1 |

45.2.2.4.32.3 Fields

| Field | Function |
|---------------------------|---|
| 31-24 SY_DIVN_EN_RX_LO | De-assertion time setting for SY_DIVN_EN (RX) This field sets the point during a TSM RX sequence (the tsm_count[7:0] value) at which the SY_DIVN_EN signal or group will transition from HI to LO. |
| 23-16 SY_DIVN_EN_RX_HI | Assertion time setting for SY_DIVN_EN (RX) This field sets the point during a TSM RX sequence (the tsm_count[7:0] value) at which the SY_DIVN_EN signal or group will transition from LO to HI. |
| 15-8 SY_DIVN_EN_TX_LO | De-assertion time setting for SY_DIVN_EN (TX) This field sets the point during a TSM TX sequence (the tsm_count[7:0] value) at which the SY_DIVN_EN signal or group will transition from HI to LO. |
| 7-0 SY_DIVN_EN_TX_HI | Assertion time setting for SY_DIVN_EN (TX) This field sets the point during a TSM TX sequence (the tsm_count[7:0] value) at which the SY_DIVN_EN signal or group will transition from LO to HI. |

45.2.2.4.33 TSM_TIMING19 (TIMING19)

45.2.2.4.33.1 Address

| Register | Offset |
|----------|-----------|
| TIMING19 | 4005C33Ch |

45.2.2.4.33.2 Diagram

| | | | | | | | | | | | | | | | | |
|-------|------------------------------|----|----|----|----|----|----|----|------------------------------|----|----|----|----|----|----|----|
| Bits | 31 | 30 | 29 | 28 | 27 | 26 | 25 | 24 | 23 | 22 | 21 | 20 | 19 | 18 | 17 | 16 |
| R | SY_PD_FILTER_CHARGE_EN_RX_LO | | | | | | | | SY_PD_FILTER_CHARGE_EN_RX_HI | | | | | | | |
| W | | | | | | | | | | | | | | | | |
| Reset | 0 | 0 | 0 | 1 | 0 | 1 | 1 | 0 | 0 | 0 | 0 | 0 | 0 | 1 | 0 | 1 |
| Bits | 15 | 14 | 13 | 12 | 11 | 10 | 9 | 8 | 7 | 6 | 5 | 4 | 3 | 2 | 1 | 0 |
| R | SY_PD_FILTER_CHARGE_EN_TX_LO | | | | | | | | SY_PD_FILTER_CHARGE_EN_TX_HI | | | | | | | |
| W | | | | | | | | | | | | | | | | |
| Reset | 0 | 1 | 0 | 0 | 1 | 0 | 1 | 0 | 0 | 0 | 0 | 0 | 0 | 1 | 0 | 1 |

45.2.2.4.33.3 Fields

| Field | Function |
|---------------------------------------|---|
| 31-24 SY_PD_FILTER_CHARGE_EN_RX_LO | De-assertion time setting for SY_PD_FILTER_CHARGE_EN (RX) This field sets the point during a TSM RX sequence (the tsm_count[7:0] value) at which the SY_PD_FILTER_CHARGE_EN signal or group will transition from HI to LO. |
| 23-16 SY_PD_FILTER_CHARGE_EN_RX_HI | Assertion time setting for SY_PD_FILTER_CHARGE_EN (RX) This field sets the point during a TSM RX sequence (the tsm_count[7:0] value) at which the SY_PD_FILTER_CHARGE_EN signal or group will transition from LO to HI. |
| 15-8 SY_PD_FILTER_CHARGE_EN_TX_LO | De-assertion time setting for SY_PD_FILTER_CHARGE_EN (TX) This field sets the point during a TSM TX sequence (the tsm_count[7:0] value) at which the SY_PD_FILTER_CHARGE_EN signal or group will transition from HI to LO. |
| 7-0 SY_PD_FILTER_CHARGE_EN_TX_HI | Assertion time setting for SY_PD_FILTER_CHARGE_EN (TX) This field sets the point during a TSM TX sequence (the tsm_count[7:0] value) at which the SY_PD_FILTER_CHARGE_EN signal or group will transition from LO to HI. |

45.2.2.4.34 TSM_TIMING20 (TIMING20)

45.2.2.4.34.1 Address

| Register | Offset |
|----------|-----------|
| TIMING20 | 4005C340h |

45.2.2.4.34.2 Diagram

| | | | | | | | | | | | | | | | | |
|-------|----------------|----|----|----|----|----|----|----|----------------|----|----|----|----|----|----|----|
| Bits | 31 | 30 | 29 | 28 | 27 | 26 | 25 | 24 | 23 | 22 | 21 | 20 | 19 | 18 | 17 | 16 |
| R | SY_PD_EN_RX_LO | | | | | | | | SY_PD_EN_RX_HI | | | | | | | |
| W | | | | | | | | | | | | | | | | |
| Reset | 0 | 1 | 1 | 0 | 0 | 1 | 1 | 1 | 0 | 0 | 0 | 0 | 0 | 1 | 0 | 1 |
| Bits | 15 | 14 | 13 | 12 | 11 | 10 | 9 | 8 | 7 | 6 | 5 | 4 | 3 | 2 | 1 | 0 |
| R | SY_PD_EN_TX_LO | | | | | | | | SY_PD_EN_TX_HI | | | | | | | |
| W | | | | | | | | | | | | | | | | |
| Reset | 0 | 1 | 1 | 0 | 1 | 0 | 1 | 0 | 0 | 0 | 0 | 0 | 0 | 1 | 0 | 1 |

45.2.2.4.34.3 Fields

| Field | Function |
|-------------------------|---|
| 31-24 SY_PD_EN_RX_LO | De-assertion time setting for SY_PD_EN (RX) This field sets the point during a TSM RX sequence (the tsm_count[7:0] value) at which the SY_PD_EN signal or group will transition from HI to LO. |
| 23-16 SY_PD_EN_RX_HI | Assertion time setting for SY_PD_EN (RX) This field sets the point during a TSM RX sequence (the tsm_count[7:0] value) at which the SY_PD_EN signal or group will transition from LO to HI. |
| 15-8 SY_PD_EN_TX_LO | De-assertion time setting for SY_PD_EN (TX) This field sets the point during a TSM TX sequence (the tsm_count[7:0] value) at which the SY_PD_EN signal or group will transition from HI to LO. |
| 7-0 SY_PD_EN_TX_HI | Assertion time setting for SY_PD_EN (TX) This field sets the point during a TSM TX sequence (the tsm_count[7:0] value) at which the SY_PD_EN signal or group will transition from LO to HI. |

45.2.2.4.35 TSM_TIMING21 (TIMING21)

45.2.2.4.35.1 Address

| Register | Offset |
|----------|-----------|
| TIMING21 | 4005C344h |

45.2.2.4.35.2 Diagram

| | | | | | | | | | | | | | | | | |
|-------|---------------------|----|----|----|----|----|----|----|---------------------|----|----|----|----|----|----|----|
| Bits | 31 | 30 | 29 | 28 | 27 | 26 | 25 | 24 | 23 | 22 | 21 | 20 | 19 | 18 | 17 | 16 |
| R | SY_LO_DIVN_EN_RX_LO | | | | | | | | SY_LO_DIVN_EN_RX_HI | | | | | | | |
| W | | | | | | | | | | | | | | | | |
| Reset | 0 | 1 | 1 | 0 | 0 | 1 | 1 | 1 | 0 | 0 | 0 | 0 | 0 | 1 | 0 | 0 |
| Bits | 15 | 14 | 13 | 12 | 11 | 10 | 9 | 8 | 7 | 6 | 5 | 4 | 3 | 2 | 1 | 0 |
| R | SY_LO_DIVN_EN_TX_LO | | | | | | | | SY_LO_DIVN_EN_TX_HI | | | | | | | |
| W | | | | | | | | | | | | | | | | |
| Reset | 0 | 1 | 1 | 0 | 1 | 0 | 1 | 0 | 0 | 0 | 0 | 0 | 0 | 1 | 0 | 0 |

45.2.2.4.35.3 Fields

| Field | Function |
|------------------------------|---|
| 31-24 SY_LO_DIVN_EN_RX_LO | De-assertion time setting for SY_LO_DIVN_EN (RX) This field sets the point during a TSM RX sequence (the tsm_count[7:0] value) at which the SY_LO_DIVN_EN signal or group will transition from HI to LO. |
| 23-16 SY_LO_DIVN_EN_RX_HI | Assertion time setting for SY_LO_DIVN_EN (RX) This field sets the point during a TSM RX sequence (the tsm_count[7:0] value) at which the SY_LO_DIVN_EN signal or group will transition from LO to HI. |
| 15-8 SY_LO_DIVN_EN_TX_LO | De-assertion time setting for SY_LO_DIVN_EN (TX) This field sets the point during a TSM TX sequence (the tsm_count[7:0] value) at which the SY_LO_DIVN_EN signal or group will transition from HI to LO. |
| 7-0 SY_LO_DIVN_EN_TX_HI | Assertion time setting for SY_LO_DIVN_EN (TX) This field sets the point during a TSM TX sequence (the tsm_count[7:0] value) at which the SY_LO_DIVN_EN signal or group will transition from LO to HI. |

45.2.2.4.36 TSM_TIMING22 (TIMING22)

45.2.2.4.36.1 Address

| Register | Offset |
|----------|-----------|
| TIMING22 | 4005C348h |

45.2.2.4.36.2 Diagram

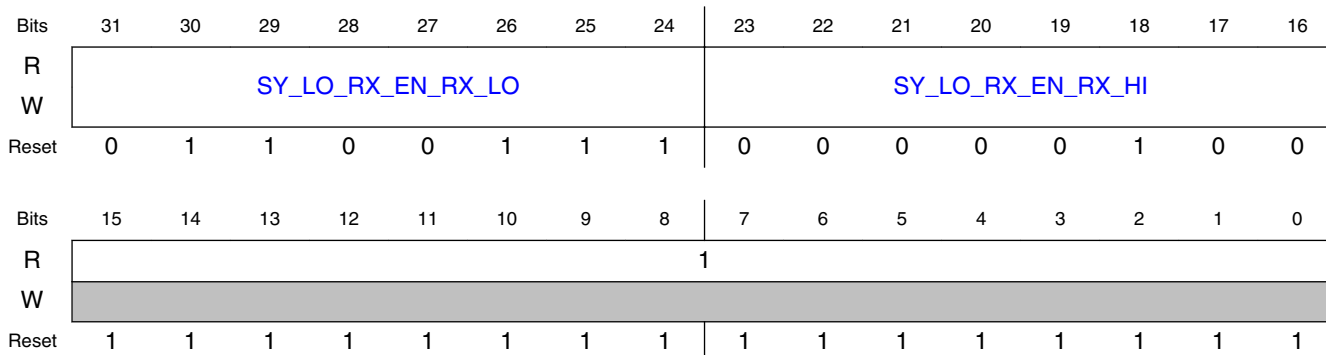

45.2.2.4.36.3 Fields

| Field | Function |
|--------------------------------|---|
| 31-24 SY_LO_RX_EN _RX_LO | De-assertion time setting for SY_LO_RX_EN (RX) This field sets the point during a TSM RX sequence (the tsm_count[7:0] value) at which the SY_LO_RX_EN signal or group will transition from HI to LO. |
| 23-16 SY_LO_RX_EN _RX_HI | Assertion time setting for SY_LO_RX_EN (RX) This field sets the point during a TSM RX sequence (the tsm_count[7:0] value) at which the SY_LO_RX_EN signal or group will transition from LO to HI. |
| 15-0 — | Reserved |

45.2.2.4.37 TSM_TIMING23 (TIMING23)

45.2.2.4.37.1 Address

| Register | Offset |
|----------|-----------|
| TIMING23 | 4005C34Ch |

45.2.2.4.37.2 Diagram

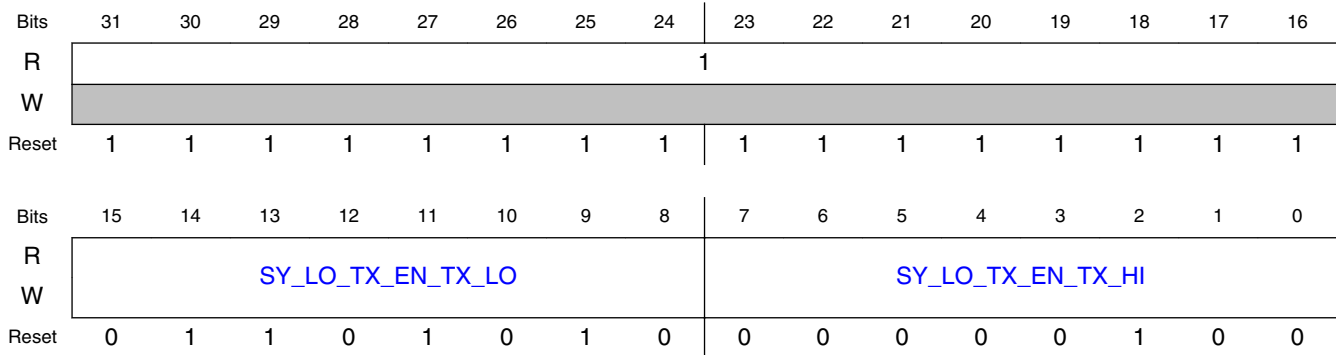

45.2.2.4.37.3 Fields

| Field | Function |
|-------------------------------|---|
| 31-16 — | Reserved |
| 15-8 SY_LO_TX_EN _TX_LO | De-assertion time setting for SY_LO_TX_EN (TX) This field sets the point during a TSM TX sequence (the tsm_count[7:0] value) at which the SY_LO_TX_EN signal or group will transition from HI to LO. |
| 7-0 SY_LO_TX_EN _TX_HI | Assertion time setting for SY_LO_TX_EN (TX) This field sets the point during a TSM TX sequence (the tsm_count[7:0] value) at which the SY_LO_TX_EN signal or group will transition from LO to HI. |

45.2.2.4.38 TSM_TIMING24 (TIMING24)

45.2.2.4.38.1 Address

| Register | Offset |
|----------|-----------|
| TIMING24 | 4005C350h |

45.2.2.4.38.2 Diagram

| | | | | | | | | | | | | | | | | |
|-------|----------------------|----|----|----|----|----|----|----|----------------------|----|----|----|----|----|----|----|
| Bits | 31 | 30 | 29 | 28 | 27 | 26 | 25 | 24 | 23 | 22 | 21 | 20 | 19 | 18 | 17 | 16 |
| R | SY_DIVN_CAL_EN_RX_LO | | | | | | | | SY_DIVN_CAL_EN_RX_HI | | | | | | | |
| W | | | | | | | | | | | | | | | | |
| Reset | 0 | 0 | 0 | 1 | 0 | 1 | 1 | 0 | 0 | 0 | 0 | 0 | 0 | 0 | 0 | 0 |
| Bits | 15 | 14 | 13 | 12 | 11 | 10 | 9 | 8 | 7 | 6 | 5 | 4 | 3 | 2 | 1 | 0 |
| R | SY_DIVN_CAL_EN_TX_LO | | | | | | | | SY_DIVN_CAL_EN_TX_HI | | | | | | | |
| W | | | | | | | | | | | | | | | | |
| Reset | 0 | 1 | 0 | 0 | 1 | 0 | 1 | 0 | 0 | 0 | 0 | 0 | 0 | 0 | 0 | 0 |

45.2.2.4.38.3 Fields

| Field | Function |
|----------------------|--|
| 31-24 | De-assertion time setting for SY_DIVN_CAL_EN (RX) |
| SY_DIVN_CAL_EN_RX_LO | This field sets the point during a TSM RX sequence (the tsm_count[7:0] value) at which the SY_DIVN_CAL_EN signal or group will transition from HI to LO. |
| 23-16 | Assertion time setting for SY_DIVN_CAL_EN (RX) |
| SY_DIVN_CAL_EN_RX_HI | This field sets the point during a TSM RX sequence (the tsm_count[7:0] value) at which the SY_DIVN_CAL_EN signal or group will transition from LO to HI. |
| 15-8 | De-assertion time setting for SY_DIVN_CAL_EN (TX) |
| SY_DIVN_CAL_EN_TX_LO | This field sets the point during a TSM TX sequence (the tsm_count[7:0] value) at which the SY_DIVN_CAL_EN signal or group will transition from HI to LO. |
| 7-0 | Assertion time setting for SY_DIVN_CAL_EN (TX) |
| SY_DIVN_CAL_EN_TX_HI | This field sets the point during a TSM TX sequence (the tsm_count[7:0] value) at which the SY_DIVN_CAL_EN signal or group will transition from LO to HI. |

45.2.2.4.39 TSM_TIMING25 (TIMING25)

45.2.2.4.39.1 Address

| Register | Offset |
|----------|-----------|
| TIMING25 | 4005C354h |

45.2.2.4.39.2 Diagram

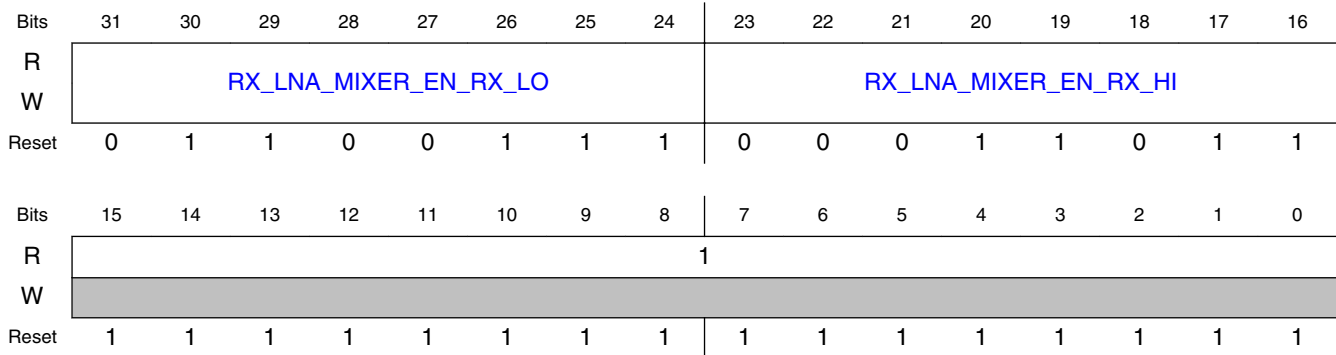

45.2.2.4.39.3 Fields

| Field | Function |
|--------------------------------|---|
| 31-24 RX_LNA_MIXER_EN_RX_LO | De-assertion time setting for RX_LNA_MIXER_EN (RX) This field sets the point during a TSM RX sequence (the tsm_count[7:0] value) at which the RX_LNA_MIXER_EN signal or group will transition from HI to LO. |
| 23-16 RX_LNA_MIXER_EN_RX_HI | Assertion time setting for RX_LNA_MIXER_EN (RX) This field sets the point during a TSM RX sequence (the tsm_count[7:0] value) at which the RX_LNA_MIXER_EN signal or group will transition from LO to HI. |
| 15-0 — | Reserved |

45.2.2.4.40 TSM_TIMING26 (TIMING26)

45.2.2.4.40.1 Address

| Register | Offset |
|----------|-----------|
| TIMING26 | 4005C358h |

45.2.2.4.40.2 Diagram

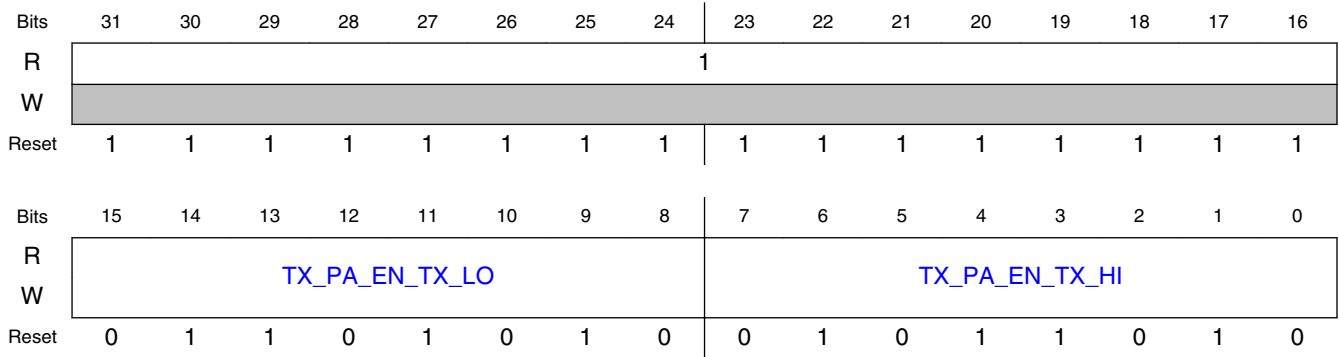

45.2.2.4.40.3 Fields

| Field | Function |
|------------------------|---|
| 31-16 — | Reserved |
| 15-8 TX_PA_EN_TX_LO | De-assertion time setting for TX_PA_EN (TX) This field sets the point during a TSM TX sequence (the tsm_count[7:0] value) at which the TX_PA_EN signal or group will transition from HI to LO. |
| 7-0 TX_PA_EN_TX_HI | Assertion time setting for TX_PA_EN (TX) This field sets the point during a TSM TX sequence (the tsm_count[7:0] value) at which the TX_PA_EN signal or group will transition from LO to HI. |

45.2.2.4.41 TSM_TIMING27 (TIMING27)

45.2.2.4.41.1 Address

| Register | Offset |
|----------|-----------|
| TIMING27 | 4005C35Ch |

45.2.2.4.41.2 Diagram

| | | | | | | | | | | | | | | | | |
|-------|---------------------|----|----|----|----|----|----|----|---------------------|----|----|----|----|----|----|----|
| Bits | 31 | 30 | 29 | 28 | 27 | 26 | 25 | 24 | 23 | 22 | 21 | 20 | 19 | 18 | 17 | 16 |
| R | RX_ADC_I_Q_EN_RX_LO | | | | | | | | RX_ADC_I_Q_EN_RX_HI | | | | | | | |
| W | | | | | | | | | | | | | | | | |
| Reset | 0 | 1 | 1 | 0 | 0 | 1 | 1 | 1 | 0 | 0 | 0 | 1 | 1 | 1 | 1 | 0 |
| Bits | 15 | 14 | 13 | 12 | 11 | 10 | 9 | 8 | 7 | 6 | 5 | 4 | 3 | 2 | 1 | 0 |
| R | 1 | | | | | | | | | | | | | | | |
| W | | | | | | | | | | | | | | | | |
| Reset | 1 | 1 | 1 | 1 | 1 | 1 | 1 | 1 | 1 | 1 | 1 | 1 | 1 | 1 | 1 | 1 |

45.2.2.4.41.3 Fields

| Field | Function |
|------------------------------|---|
| 31-24 RX_ADC_I_Q_EN_RX_LO | De-assertion time setting for RX_ADC_I_Q_EN (RX) This field sets the point during a TSM RX sequence (the tsm_count[7:0] value) at which the RX_ADC_I_Q_EN signal or group will transition from HI to LO. |
| 23-16 RX_ADC_I_Q_EN_RX_HI | Assertion time setting for RX_ADC_I_Q_EN (RX) This field sets the point during a TSM RX sequence (the tsm_count[7:0] value) at which the RX_ADC_I_Q_EN signal or group will transition from LO to HI. |
| 15-0 — | Reserved |

45.2.2.4.42 TSM_TIMING28 (TIMING28)

45.2.2.4.42.1 Address

| Register | Offset |
|----------|-----------|
| TIMING28 | 4005C360h |

45.2.2.4.42.2 Diagram

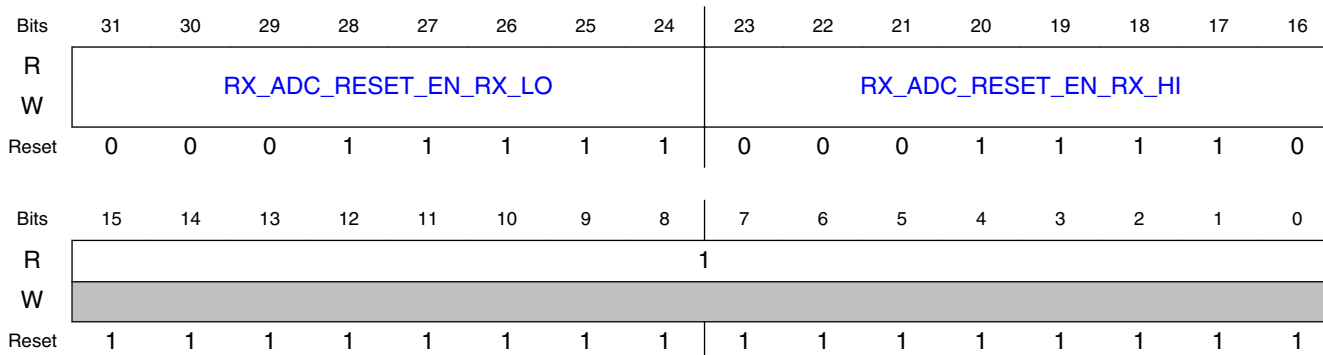

45.2.2.4.42.3 Fields

| Field | Function |
|------------------------------------|---|
| 31-24 RX_ADC_RESE T_EN_RX_LO | De-assertion time setting for RX_ADC_RESET_EN (RX) This field sets the point during a TSM RX sequence (the tsm_count[7:0] value) at which the RX_ADC_RESET_EN signal or group will transition from HI to LO. |
| 23-16 RX_ADC_RESE T_EN_RX_HI | Assertion time setting for RX_ADC_RESET_EN (RX) This field sets the point during a TSM RX sequence (the tsm_count[7:0] value) at which the RX_ADC_RESET_EN signal or group will transition from LO to HI. |
| 15-0 — | Reserved |

45.2.2.4.43 TSM_TIMING29 (TIMING29)

45.2.2.4.43.1 Address

| Register | Offset |
|----------|-----------|
| TIMING29 | 4005C364h |

45.2.2.4.43.2 Diagram

| | | | | | | | | | | | | | | | | |
|-------|---------------------|----|----|----|----|----|----|----|---------------------|----|----|----|----|----|----|----|
| Bits | 31 | 30 | 29 | 28 | 27 | 26 | 25 | 24 | 23 | 22 | 21 | 20 | 19 | 18 | 17 | 16 |
| R | RX_BBA_I_Q_EN_RX_LO | | | | | | | | RX_BBA_I_Q_EN_RX_HI | | | | | | | |
| W | | | | | | | | | | | | | | | | |
| Reset | 0 | 1 | 1 | 0 | 0 | 1 | 1 | 1 | 0 | 0 | 0 | 1 | 1 | 1 | 0 | 0 |
| Bits | 15 | 14 | 13 | 12 | 11 | 10 | 9 | 8 | 7 | 6 | 5 | 4 | 3 | 2 | 1 | 0 |
| R | 1 | | | | | | | | | | | | | | | |
| W | | | | | | | | | | | | | | | | |
| Reset | 1 | 1 | 1 | 1 | 1 | 1 | 1 | 1 | 1 | 1 | 1 | 1 | 1 | 1 | 1 | 1 |

45.2.2.4.43.3 Fields

| Field | Function |
|------------------------------|---|
| 31-24 RX_BBA_I_Q_EN_RX_LO | De-assertion time setting for RX_BBA_I_Q_EN (RX) This field sets the point during a TSM RX sequence (the tsm_count[7:0] value) at which the RX_BBA_I_Q_EN signal or group will transition from HI to LO. |
| 23-16 RX_BBA_I_Q_EN_RX_HI | Assertion time setting for RX_BBA_I_Q_EN (RX) This field sets the point during a TSM RX sequence (the tsm_count[7:0] value) at which the RX_BBA_I_Q_EN signal or group will transition from LO to HI. |
| 15-0 — | Reserved |

45.2.2.4.44 TSM_TIMING30 (TIMING30)

45.2.2.4.44.1 Address

| Register | Offset |
|----------|-----------|
| TIMING30 | 4005C368h |

45.2.2.4.44.2 Diagram

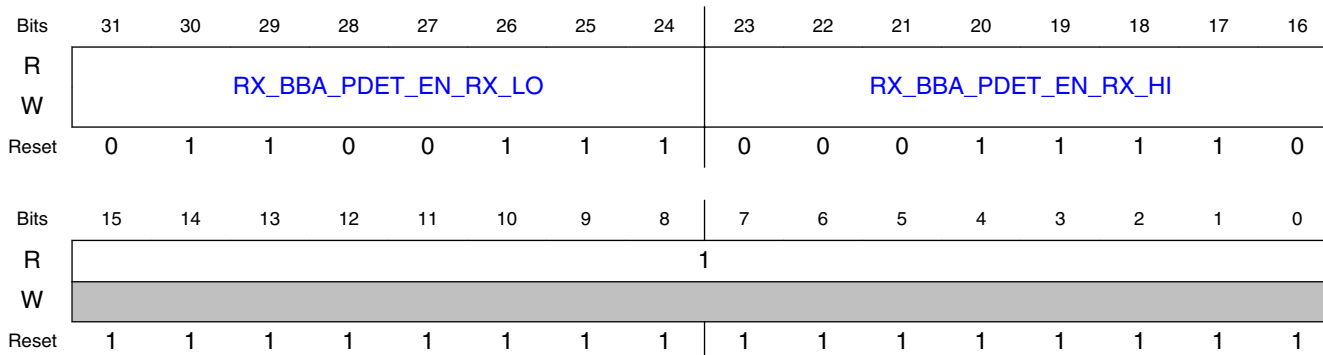

45.2.2.4.44.3 Fields

| Field | Function |
|-------------------------------|---|
| 31-24 RX_BBA_PDET_EN_RX_LO | De-assertion time setting for RX_BBA_PDET_EN (RX) This field sets the point during a TSM RX sequence (the tsm_count[7:0] value) at which the RX_BBA_PDET_EN signal or group will transition from HI to LO. |
| 23-16 RX_BBA_PDET_EN_RX_HI | Assertion time setting for RX_BBA_PDET_EN (RX) This field sets the point during a TSM RX sequence (the tsm_count[7:0] value) at which the RX_BBA_PDET_EN signal or group will transition from LO to HI. |
| 15-0 — | Reserved |

45.2.2.4.45 TSM_TIMING31 (TIMING31)

45.2.2.4.45.1 Address

| Register | Offset |
|----------|-----------|
| TIMING31 | 4005C36Ch |

45.2.2.4.45.2 Diagram

| | | | | | | | | | | | | | | | | |
|-------|--------------------------|----|----|----|----|----|----|----|--------------------------|----|----|----|----|----|----|----|
| Bits | 31 | 30 | 29 | 28 | 27 | 26 | 25 | 24 | 23 | 22 | 21 | 20 | 19 | 18 | 17 | 16 |
| R | RX_BBA_TZA_DCOC_EN_RX_LO | | | | | | | | RX_BBA_TZA_DCOC_EN_RX_HI | | | | | | | |
| W | | | | | | | | | | | | | | | | |
| Reset | 0 | 1 | 1 | 0 | 0 | 1 | 1 | 1 | 0 | 0 | 0 | 1 | 1 | 1 | 0 | 1 |
| Bits | 15 | 14 | 13 | 12 | 11 | 10 | 9 | 8 | 7 | 6 | 5 | 4 | 3 | 2 | 1 | 0 |
| R | 1 | | | | | | | | | | | | | | | |
| W | | | | | | | | | | | | | | | | |
| Reset | 1 | 1 | 1 | 1 | 1 | 1 | 1 | 1 | 1 | 1 | 1 | 1 | 1 | 1 | 1 | 1 |

45.2.2.4.45.3 Fields

| Field | Function |
|-----------------------------------|---|
| 31-24 RX_BBA_TZA_DCOC_EN_RX_LO | De-assertion time setting for RX_BBA_TZA_DCOC_EN (RX) This field sets the point during a TSM RX sequence (the tsm_count[7:0] value) at which the RX_BBA_TZA_DCOC_EN signal or group will transition from HI to LO. |
| 23-16 RX_BBA_TZA_DCOC_EN_RX_HI | Assertion time setting for RX_BBA_TZA_DCOC_EN (RX) This field sets the point during a TSM RX sequence (the tsm_count[7:0] value) at which the RX_BBA_TZA_DCOC_EN signal or group will transition from LO to HI. |
| 15-0 — | Reserved |

45.2.2.4.46 TSM_TIMING32 (TIMING32)

45.2.2.4.46.1 Address

| Register | Offset |
|----------|-----------|
| TIMING32 | 4005C370h |

45.2.2.4.46.2 Diagram

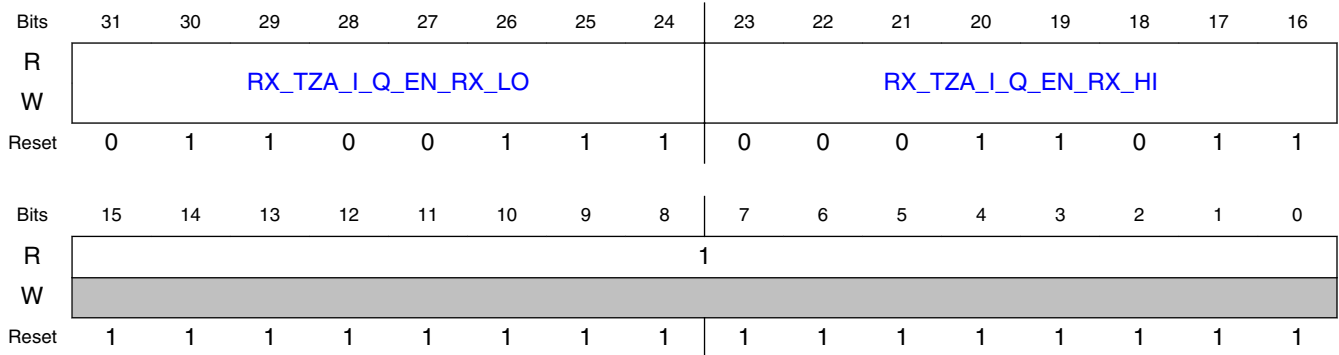

45.2.2.4.46.3 Fields

| Field | Function |
|------------------------------|---|
| 31-24 RX_TZA_I_Q_EN_RX_LO | De-assertion time setting for RX_TZA_I_Q_EN (RX) This field sets the point during a TSM RX sequence (the tsm_count[7:0] value) at which the RX_TZA_I_Q_EN signal or group will transition from HI to LO. |
| 23-16 RX_TZA_I_Q_EN_RX_HI | Assertion time setting for RX_TZA_I_Q_EN (RX) This field sets the point during a TSM RX sequence (the tsm_count[7:0] value) at which the RX_TZA_I_Q_EN signal or group will transition from LO to HI. |
| 15-0 — | Reserved |

45.2.2.4.47 TSM_TIMING33 (TIMING33)

45.2.2.4.47.1 Address

| Register | Offset |
|----------|-----------|
| TIMING33 | 4005C374h |

45.2.2.4.47.2 Diagram

| | | | | | | | | | | | | | | | | |
|-------|----------------------|----|----|----|----|----|----|----|----------------------|----|----|----|----|----|----|----|
| Bits | 31 | 30 | 29 | 28 | 27 | 26 | 25 | 24 | 23 | 22 | 21 | 20 | 19 | 18 | 17 | 16 |
| R | RX_TZA_PDET_EN_RX_LO | | | | | | | | RX_TZA_PDET_EN_RX_HI | | | | | | | |
| W | | | | | | | | | | | | | | | | |
| Reset | 0 | 1 | 1 | 0 | 0 | 1 | 1 | 1 | 0 | 0 | 0 | 1 | 1 | 1 | 1 | 0 |
| Bits | 15 | 14 | 13 | 12 | 11 | 10 | 9 | 8 | 7 | 6 | 5 | 4 | 3 | 2 | 1 | 0 |
| R | 1 | | | | | | | | | | | | | | | |
| W | | | | | | | | | | | | | | | | |
| Reset | 1 | 1 | 1 | 1 | 1 | 1 | 1 | 1 | 1 | 1 | 1 | 1 | 1 | 1 | 1 | 1 |

45.2.2.4.47.3 Fields

| Field | Function |
|-------------------------------|---|
| 31-24 RX_TZA_PDET_EN_RX_LO | De-assertion time setting for RX_TZA_PDET_EN (RX) This field sets the point during a TSM RX sequence (the tsm_count[7:0] value) at which the RX_TZA_PDET_EN signal or group will transition from HI to LO. |
| 23-16 RX_TZA_PDET_EN_RX_HI | Assertion time setting for RX_TZA_PDET_EN (RX) This field sets the point during a TSM RX sequence (the tsm_count[7:0] value) at which the RX_TZA_PDET_EN signal or group will transition from LO to HI. |
| 15-0 — | Reserved |

45.2.2.4.48 TSM_TIMING34 (TIMING34)

45.2.2.4.48.1 Address

| Register | Offset |
|----------|-----------|
| TIMING34 | 4005C378h |

45.2.2.4.48.2 Diagram

| | | | | | | | | | | | | | | | | |
|-------|------------------|----|----|----|----|----|----|----|------------------|----|----|----|----|----|----|----|
| Bits | 31 | 30 | 29 | 28 | 27 | 26 | 25 | 24 | 23 | 22 | 21 | 20 | 19 | 18 | 17 | 16 |
| R | PLL_DIG_EN_RX_LO | | | | | | | | PLL_DIG_EN_RX_HI | | | | | | | |
| W | | | | | | | | | | | | | | | | |
| Reset | 0 | 1 | 1 | 0 | 0 | 1 | 1 | 1 | 0 | 0 | 0 | 0 | 0 | 1 | 0 | 1 |
| Bits | 15 | 14 | 13 | 12 | 11 | 10 | 9 | 8 | 7 | 6 | 5 | 4 | 3 | 2 | 1 | 0 |
| R | PLL_DIG_EN_TX_LO | | | | | | | | PLL_DIG_EN_TX_HI | | | | | | | |
| W | | | | | | | | | | | | | | | | |
| Reset | 0 | 1 | 1 | 0 | 1 | 0 | 1 | 0 | 0 | 0 | 0 | 0 | 0 | 1 | 0 | 1 |

45.2.2.4.48.3 Fields

| Field | Function |
|------------------|--|
| 31-24 | De-assertion time setting for PLL_DIG_EN (RX) |
| PLL_DIG_EN_RX_LO | This field sets the point during a TSM RX sequence (the tsm_count[7:0] value) at which the PLL_DIG_EN signal or group will transition from HI to LO. |
| 23-16 | Assertion time setting for PLL_DIG_EN (RX) |
| PLL_DIG_EN_RX_HI | This field sets the point during a TSM RX sequence (the tsm_count[7:0] value) at which the PLL_DIG_EN signal or group will transition from LO to HI. |
| 15-8 | De-assertion time setting for PLL_DIG_EN (TX) |
| PLL_DIG_EN_TX_LO | This field sets the point during a TSM TX sequence (the tsm_count[7:0] value) at which the PLL_DIG_EN signal or group will transition from HI to LO. |
| 7-0 | Assertion time setting for PLL_DIG_EN (TX) |
| PLL_DIG_EN_TX_HI | This field sets the point during a TSM TX sequence (the tsm_count[7:0] value) at which the PLL_DIG_EN signal or group will transition from LO to HI. |

45.2.2.4.49 TSM_TIMING35 (TIMING35)

45.2.2.4.49.1 Address

| Register | Offset |
|----------|-----------|
| TIMING35 | 4005C37Ch |

45.2.2.4.49.2 Diagram

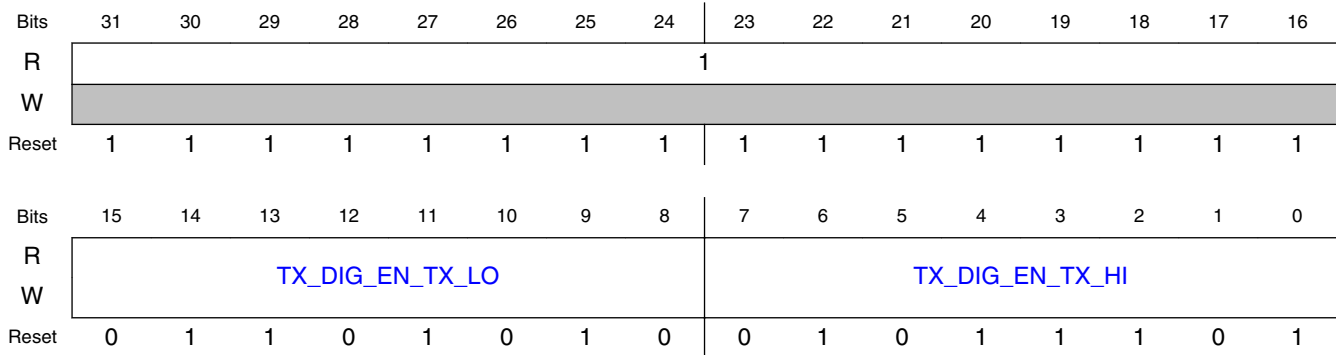

45.2.2.4.49.3 Fields

| Field | Function |
|-------------------------|---|
| 31-16 — | Reserved |
| 15-8 TX_DIG_EN_TX_LO | De-assertion time setting for TX_DIG_EN (TX) This field sets the point during a TSM TX sequence (the tsm_count[7:0] value) at which the TX_DIG_EN signal or group will transition from HI to LO. |
| 7-0 TX_DIG_EN_TX_HI | Assertion time setting for TX_DIG_EN (TX) This field sets the point during a TSM TX sequence (the tsm_count[7:0] value) at which the TX_DIG_EN signal or group will transition from LO to HI. |

45.2.2.4.50 TSM_TIMING36 (TIMING36)

45.2.2.4.50.1 Address

| Register | Offset |
|----------|-----------|
| TIMING36 | 4005C380h |

45.2.2.4.50.2 Diagram

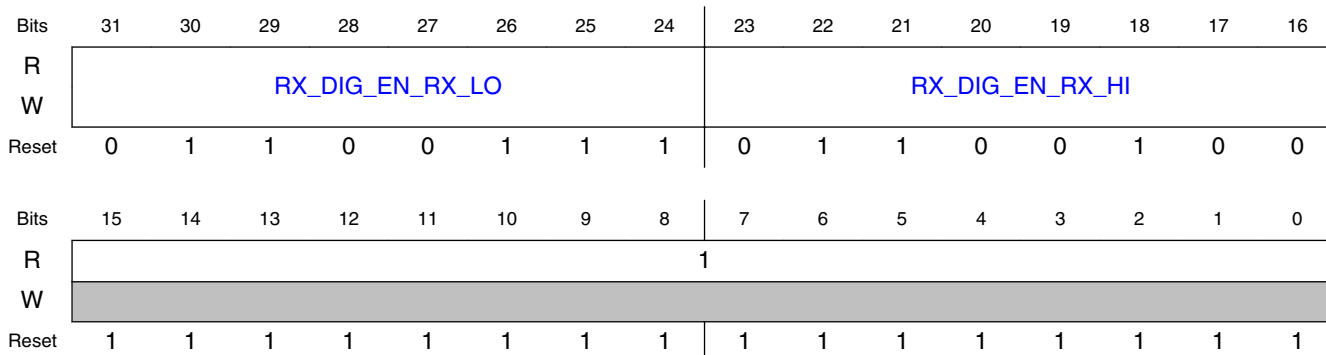

45.2.2.4.50.3 Fields

| Field | Function |
|--------------------------|---|
| 31-24 RX_DIG_EN_RX_LO | De-assertion time setting for RX_DIG_EN (RX) This field sets the point during a TSM RX sequence (the tsm_count[7:0] value) at which the RX_DIG_EN signal or group will transition from HI to LO. |
| 23-16 RX_DIG_EN_RX_HI | Assertion time setting for RX_DIG_EN (RX) This field sets the point during a TSM RX sequence (the tsm_count[7:0] value) at which the RX_DIG_EN signal or group will transition from LO to HI. |
| 15-0 — | Reserved |

45.2.2.4.51 TSM_TIMING37 (TIMING37)

45.2.2.4.51.1 Address

| Register | Offset |
|----------|-----------|
| TIMING37 | 4005C384h |

45.2.2.4.51.2 Diagram

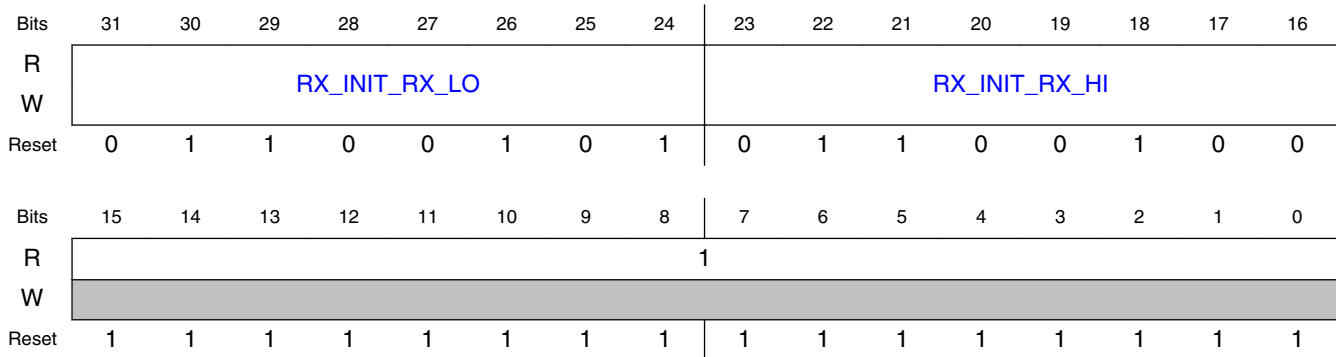

45.2.2.4.51.3 Fields

| Field | Function |
|------------------------|---|
| 31-24 RX_INIT_RX_LO | De-assertion time setting for RX_INIT (RX) This field sets the point during a TSM RX sequence (the tsm_count[7:0] value) at which the RX_INIT signal or group will transition from HI to LO. |
| 23-16 RX_INIT_RX_HI | Assertion time setting for RX_INIT (RX) This field sets the point during a TSM RX sequence (the tsm_count[7:0] value) at which the RX_INIT signal or group will transition from LO to HI. |
| 15-0 — | Reserved |

45.2.2.4.52 TSM_TIMING38 (TIMING38)

45.2.2.4.52.1 Address

| Register | Offset |
|----------|-----------|
| TIMING38 | 4005C388h |

45.2.2.4.52.2 Diagram

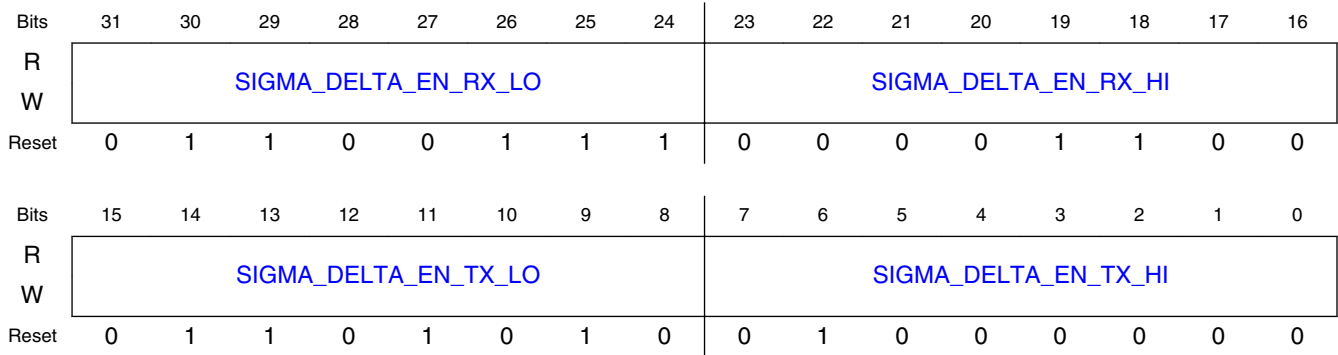

45.2.2.4.52.3 Fields

| Field | Function |
|-------------------------------|---|
| 31-24 SIGMA_DELTA_EN_RX_LO | De-assertion time setting for SIGMA_DELTA_EN (RX) This field sets the point during a TSM RX sequence (the tsm_count[7:0] value) at which the SIGMA_DELTA_EN signal or group will transition from HI to LO. |
| 23-16 SIGMA_DELTA_EN_RX_HI | Assertion time setting for SIGMA_DELTA_EN (RX) This field sets the point during a TSM RX sequence (the tsm_count[7:0] value) at which the SIGMA_DELTA_EN signal or group will transition from LO to HI. |
| 15-8 SIGMA_DELTA_EN_TX_LO | De-assertion time setting for SIGMA_DELTA_EN (TX) This field sets the point during a TSM TX sequence (the tsm_count[7:0] value) at which the SIGMA_DELTA_EN signal or group will transition from HI to LO. |
| 7-0 SIGMA_DELTA_EN_TX_HI | Assertion time setting for SIGMA_DELTA_EN (TX) This field sets the point during a TSM TX sequence (the tsm_count[7:0] value) at which the SIGMA_DELTA_EN signal or group will transition from LO to HI. |

45.2.2.4.53 TSM_TIMING39 (TIMING39)

45.2.2.4.53.1 Address

| Register | Offset |
|----------|-----------|
| TIMING39 | 4005C38Ch |

45.2.2.4.53.2 Diagram

| | | | | | | | | | | | | | | | | |
|-------|-----------------|----|----|----|----|----|----|----|-----------------|----|----|----|----|----|----|----|
| Bits | 31 | 30 | 29 | 28 | 27 | 26 | 25 | 24 | 23 | 22 | 21 | 20 | 19 | 18 | 17 | 16 |
| R | RX_PHY_EN_RX_LO | | | | | | | | RX_PHY_EN_RX_HI | | | | | | | |
| W | | | | | | | | | | | | | | | | |
| Reset | 0 | 1 | 1 | 0 | 0 | 1 | 1 | 1 | 0 | 1 | 1 | 0 | 0 | 1 | 0 | 0 |
| Bits | 15 | 14 | 13 | 12 | 11 | 10 | 9 | 8 | 7 | 6 | 5 | 4 | 3 | 2 | 1 | 0 |
| R | 1 | | | | | | | | | | | | | | | |
| W | | | | | | | | | | | | | | | | |
| Reset | 1 | 1 | 1 | 1 | 1 | 1 | 1 | 1 | 1 | 1 | 1 | 1 | 1 | 1 | 1 | 1 |

45.2.2.4.53.3 Fields

| Field | Function |
|--------------------------|---|
| 31-24 RX_PHY_EN_RX_LO | De-assertion time setting for RX_PHY_EN (RX) This field sets the point during a TSM RX sequence (the tsm_count[7:0] value) at which the RX_PHY_EN signal or group will transition from HI to LO. |
| 23-16 RX_PHY_EN_RX_HI | Assertion time setting for RX_PHY_EN (RX) This field sets the point during a TSM RX sequence (the tsm_count[7:0] value) at which the RX_PHY_EN signal or group will transition from LO to HI. |
| 15-0 — | Reserved |

45.2.2.4.54 TSM_TIMING40 (TIMING40)

45.2.2.4.54.1 Address

| Register | Offset |
|----------|-----------|
| TIMING40 | 4005C390h |

45.2.2.4.54.2 Diagram

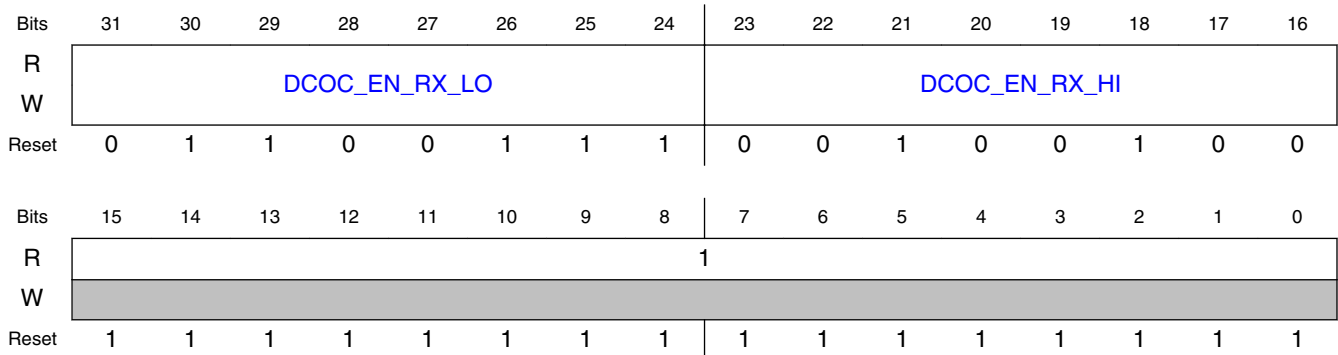

45.2.2.4.54.3 Fields

| Field | Function |
|------------------------|---|
| 31-24 DCOC_EN_RX_LO | De-assertion time setting for DCOC_EN (RX) This field sets the point during a TSM RX sequence (the tsm_count[7:0] value) at which the DCOC_EN signal or group will transition from HI to LO. |
| 23-16 DCOC_EN_RX_HI | Assertion time setting for DCOC_EN (RX) This field sets the point during a TSM RX sequence (the tsm_count[7:0] value) at which the DCOC_EN signal or group will transition from LO to HI. |
| 15-0 — | Reserved |

45.2.2.4.55 TSM_TIMING41 (TIMING41)

45.2.2.4.55.1 Address

| Register | Offset |
|----------|-----------|
| TIMING41 | 4005C394h |

45.2.2.4.55.2 Diagram

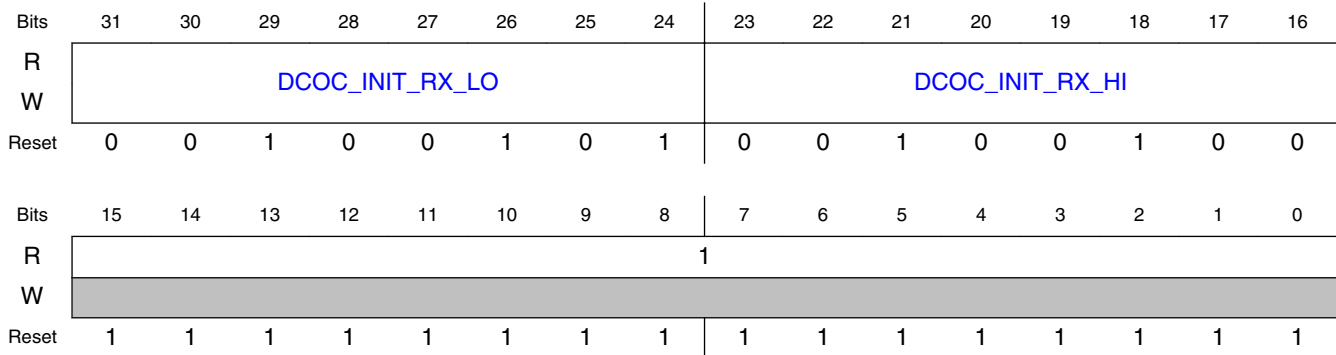

45.2.2.4.55.3 Fields

| Field | Function |
|-----------------|---|
| 31-24 | De-assertion time setting for DCOC_INIT (RX) |
| DCOC_INIT_RX_LO | This field sets the point during a TSM RX sequence (the tsm_count[7:0] value) at which the DCOC_INIT signal or group will transition from HI to LO. |
| 23-16 | Assertion time setting for DCOC_INIT (RX) |
| DCOC_INIT_RX_HI | This field sets the point during a TSM RX sequence (the tsm_count[7:0] value) at which the DCOC_INIT signal or group will transition from LO to HI. |
| 15-0 | Reserved |
| — | |

45.2.2.4.56 TSM_TIMING42 (TIMING42)

45.2.2.4.56.1 Address

| Register | Offset |
|----------|-----------|
| TIMING42 | 4005C398h |

45.2.2.4.56.2 Diagram

| | | | | | | | | | | | | | | | | |
|-------|-----------------------|----|----|----|----|----|----|----|-----------------------|----|----|----|----|----|----|----|
| Bits | 31 | 30 | 29 | 28 | 27 | 26 | 25 | 24 | 23 | 22 | 21 | 20 | 19 | 18 | 17 | 16 |
| R | SAR_ADC_TRIG_EN_RX_LO | | | | | | | | SAR_ADC_TRIG_EN_RX_HI | | | | | | | |
| W | | | | | | | | | | | | | | | | |
| Reset | 1 | 1 | 1 | 1 | 1 | 1 | 1 | 1 | 1 | 1 | 1 | 1 | 1 | 1 | 1 | 1 |
| Bits | 15 | 14 | 13 | 12 | 11 | 10 | 9 | 8 | 7 | 6 | 5 | 4 | 3 | 2 | 1 | 0 |
| R | SAR_ADC_TRIG_EN_TX_LO | | | | | | | | SAR_ADC_TRIG_EN_TX_HI | | | | | | | |
| W | | | | | | | | | | | | | | | | |
| Reset | 1 | 1 | 1 | 1 | 1 | 1 | 1 | 1 | 1 | 1 | 1 | 1 | 1 | 1 | 1 | 1 |

45.2.2.4.56.3 Fields

| Field | Function |
|--------------------------------|---|
| 31-24 SAR_ADC_TRIG_EN_RX_LO | De-assertion time setting for SAR_ADC_TRIG_EN (RX) This field sets the point during a TSM RX sequence (the tsm_count[7:0] value) at which the SAR_ADC_TRIG_EN signal or group will transition from HI to LO. |
| 23-16 SAR_ADC_TRIG_EN_RX_HI | Assertion time setting for SAR_ADC_TRIG_EN (RX) This field sets the point during a TSM RX sequence (the tsm_count[7:0] value) at which the SAR_ADC_TRIG_EN signal or group will transition from LO to HI. |
| 15-8 SAR_ADC_TRIG_EN_TX_LO | De-assertion time setting for SAR_ADC_TRIG_EN (TX) This field sets the point during a TSM TX sequence (the tsm_count[7:0] value) at which the SAR_ADC_TRIG_EN signal or group will transition from HI to LO. |
| 7-0 SAR_ADC_TRIG_EN_TX_HI | Assertion time setting for SAR_ADC_TRIG_EN (TX) This field sets the point during a TSM TX sequence (the tsm_count[7:0] value) at which the SAR_ADC_TRIG_EN signal or group will transition from LO to HI. |

45.2.2.4.57 TSM_TIMING43 (TIMING43)

45.2.2.4.57.1 Address

| Register | Offset |
|----------|-----------|
| TIMING43 | 4005C39Ch |

45.2.2.4.57.2 Diagram

| | | | | | | | | | | | | | | | | |
|-------|---------------------|----|----|----|----|----|----|----|---------------------|----|----|----|----|----|----|----|
| Bits | 31 | 30 | 29 | 28 | 27 | 26 | 25 | 24 | 23 | 22 | 21 | 20 | 19 | 18 | 17 | 16 |
| R | TSM_SPARE0_EN_RX_LO | | | | | | | | TSM_SPARE0_EN_RX_HI | | | | | | | |
| W | | | | | | | | | | | | | | | | |
| Reset | 1 | 1 | 1 | 1 | 1 | 1 | 1 | 1 | 1 | 1 | 1 | 1 | 1 | 1 | 1 | 1 |
| Bits | 15 | 14 | 13 | 12 | 11 | 10 | 9 | 8 | 7 | 6 | 5 | 4 | 3 | 2 | 1 | 0 |
| R | TSM_SPARE0_EN_TX_LO | | | | | | | | TSM_SPARE0_EN_TX_HI | | | | | | | |
| W | | | | | | | | | | | | | | | | |
| Reset | 1 | 1 | 1 | 1 | 1 | 1 | 1 | 1 | 1 | 1 | 1 | 1 | 1 | 1 | 1 | 1 |

45.2.2.4.57.3 Fields

| Field | Function |
|---------------------|---|
| 31-24 | De-assertion time setting for TSM_SPARE0_EN (RX) |
| TSM_SPARE0_EN_RX_LO | This field sets the point during a TSM RX sequence (the tsm_count[7:0] value) at which the TSM_SPARE0_EN signal or group will transition from HI to LO. |
| 23-16 | Assertion time setting for TSM_SPARE0_EN (RX) |
| TSM_SPARE0_EN_RX_HI | This field sets the point during a TSM RX sequence (the tsm_count[7:0] value) at which the TSM_SPARE0_EN signal or group will transition from LO to HI. |
| 15-8 | De-assertion time setting for TSM_SPARE0_EN (TX) |
| TSM_SPARE0_EN_TX_LO | This field sets the point during a TSM TX sequence (the tsm_count[7:0] value) at which the TSM_SPARE0_EN signal or group will transition from HI to LO. |
| 7-0 | Assertion time setting for TSM_SPARE0_EN (TX) |
| TSM_SPARE0_EN_TX_HI | This field sets the point during a TSM TX sequence (the tsm_count[7:0] value) at which the TSM_SPARE0_EN signal or group will transition from LO to HI. |

45.2.2.4.58 TSM_TIMING44 (TIMING44)

45.2.2.4.58.1 Address

| Register | Offset |
|----------|-----------|
| TIMING44 | 4005C3A0h |

45.2.2.4.58.2 Diagram

| | | | | | | | | | | | | | | | | |
|-------|---------------------|----|----|----|----|----|----|----|---------------------|----|----|----|----|----|----|----|
| Bits | 31 | 30 | 29 | 28 | 27 | 26 | 25 | 24 | 23 | 22 | 21 | 20 | 19 | 18 | 17 | 16 |
| R | TSM_SPARE1_EN_RX_LO | | | | | | | | TSM_SPARE1_EN_RX_HI | | | | | | | |
| W | | | | | | | | | | | | | | | | |
| Reset | 1 | 1 | 1 | 1 | 1 | 1 | 1 | 1 | 1 | 1 | 1 | 1 | 1 | 1 | 1 | 1 |
| Bits | 15 | 14 | 13 | 12 | 11 | 10 | 9 | 8 | 7 | 6 | 5 | 4 | 3 | 2 | 1 | 0 |
| R | TSM_SPARE1_EN_TX_LO | | | | | | | | TSM_SPARE1_EN_TX_HI | | | | | | | |
| W | | | | | | | | | | | | | | | | |
| Reset | 1 | 1 | 1 | 1 | 1 | 1 | 1 | 1 | 1 | 1 | 1 | 1 | 1 | 1 | 1 | 1 |

45.2.2.4.58.3 Fields

| Field | Function |
|---------------------|---|
| 31-24 | De-assertion time setting for TSM_SPARE1_EN (RX) |
| TSM_SPARE1_EN_RX_LO | This field sets the point during a TSM RX sequence (the tsm_count[7:0] value) at which the TSM_SPARE1_EN signal or group will transition from HI to LO. |
| 23-16 | Assertion time setting for TSM_SPARE1_EN (RX) |
| TSM_SPARE1_EN_RX_HI | This field sets the point during a TSM RX sequence (the tsm_count[7:0] value) at which the TSM_SPARE1_EN signal or group will transition from LO to HI. |
| 15-8 | De-assertion time setting for TSM_SPARE1_EN (TX) |
| TSM_SPARE1_EN_TX_LO | This field sets the point during a TSM TX sequence (the tsm_count[7:0] value) at which the TSM_SPARE1_EN signal or group will transition from HI to LO. |
| 7-0 | Assertion time setting for TSM_SPARE1_EN (TX) |
| TSM_SPARE1_EN_TX_HI | This field sets the point during a TSM TX sequence (the tsm_count[7:0] value) at which the TSM_SPARE1_EN signal or group will transition from LO to HI. |

45.2.2.4.59 TSM_TIMING45 (TIMING45)

45.2.2.4.59.1 Address

| Register | Offset |
|----------|-----------|
| TIMING45 | 4005C3A4h |

45.2.2.4.59.2 Diagram

| | | | | | | | | | | | | | | | | |
|-------|---------------------|----|----|----|----|----|----|----|---------------------|----|----|----|----|----|----|----|
| Bits | 31 | 30 | 29 | 28 | 27 | 26 | 25 | 24 | 23 | 22 | 21 | 20 | 19 | 18 | 17 | 16 |
| R | TSM_SPARE2_EN_RX_LO | | | | | | | | TSM_SPARE2_EN_RX_HI | | | | | | | |
| W | | | | | | | | | | | | | | | | |
| Reset | 1 | 1 | 1 | 1 | 1 | 1 | 1 | 1 | 1 | 1 | 1 | 1 | 1 | 1 | 1 | 1 |
| Bits | 15 | 14 | 13 | 12 | 11 | 10 | 9 | 8 | 7 | 6 | 5 | 4 | 3 | 2 | 1 | 0 |
| R | TSM_SPARE2_EN_TX_LO | | | | | | | | TSM_SPARE2_EN_TX_HI | | | | | | | |
| W | | | | | | | | | | | | | | | | |
| Reset | 1 | 1 | 1 | 1 | 1 | 1 | 1 | 1 | 1 | 1 | 1 | 1 | 1 | 1 | 1 | 1 |

45.2.2.4.59.3 Fields

| Field | Function |
|---------------------|---|
| 31-24 | De-assertion time setting for TSM_SPARE2_EN (RX) |
| TSM_SPARE2_EN_RX_LO | This field sets the point during a TSM RX sequence (the tsm_count[7:0] value) at which the TSM_SPARE2_EN signal or group will transition from HI to LO. |
| 23-16 | Assertion time setting for TSM_SPARE2_EN (RX) |
| TSM_SPARE2_EN_RX_HI | This field sets the point during a TSM RX sequence (the tsm_count[7:0] value) at which the TSM_SPARE2_EN signal or group will transition from LO to HI. |
| 15-8 | De-assertion time setting for TSM_SPARE2_EN (TX) |
| TSM_SPARE2_EN_TX_LO | This field sets the point during a TSM TX sequence (the tsm_count[7:0] value) at which the TSM_SPARE2_EN signal or group will transition from HI to LO. |
| 7-0 | Assertion time setting for TSM_SPARE2_EN (TX) |
| TSM_SPARE2_EN_TX_HI | This field sets the point during a TSM TX sequence (the tsm_count[7:0] value) at which the TSM_SPARE2_EN signal or group will transition from LO to HI. |

45.2.2.4.60 TSM_TIMING46 (TIMING46)

45.2.2.4.60.1 Address

| Register | Offset |
|----------|-----------|
| TIMING46 | 4005C3A8h |

45.2.2.4.60.2 Diagram

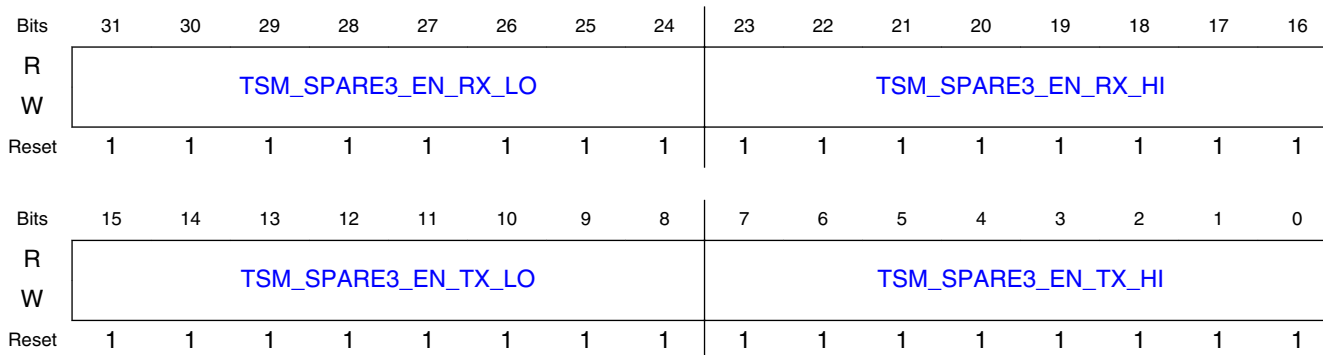

45.2.2.4.60.3 Fields

| Field | Function |
|---------------------|---|
| 31-24 | De-assertion time setting for TSM_SPARE3_EN (RX) |
| TSM_SPARE3_EN_RX_LO | This field sets the point during a TSM RX sequence (the tsm_count[7:0] value) at which the TSM_SPARE3_EN signal or group will transition from HI to LO. |
| 23-16 | Assertion time setting for TSM_SPARE3_EN (RX) |
| TSM_SPARE3_EN_RX_HI | This field sets the point during a TSM RX sequence (the tsm_count[7:0] value) at which the TSM_SPARE3_EN signal or group will transition from LO to HI. |
| 15-8 | De-assertion time setting for TSM_SPARE3_EN (TX) |
| TSM_SPARE3_EN_TX_LO | This field sets the point during a TSM TX sequence (the tsm_count[7:0] value) at which the TSM_SPARE3_EN signal or group will transition from HI to LO. |
| 7-0 | Assertion time setting for TSM_SPARE3_EN (TX) |
| TSM_SPARE3_EN_TX_HI | This field sets the point during a TSM TX sequence (the tsm_count[7:0] value) at which the TSM_SPARE3_EN signal or group will transition from LO to HI. |

45.2.2.4.61 TSM_TIMING47 (TIMING47)

45.2.2.4.61.1 Address

| Register | Offset |
|----------|-----------|
| TIMING47 | 4005C3ACh |

45.2.2.4.61.2 Diagram

| | | | | | | | | | | | | | | | | |
|-------|---------------------|----|----|----|----|----|----|----|---------------------|----|----|----|----|----|----|----|
| Bits | 31 | 30 | 29 | 28 | 27 | 26 | 25 | 24 | 23 | 22 | 21 | 20 | 19 | 18 | 17 | 16 |
| R | GPIO0_TRIG_EN_RX_LO | | | | | | | | GPIO0_TRIG_EN_RX_HI | | | | | | | |
| W | | | | | | | | | | | | | | | | |
| Reset | 1 | 1 | 1 | 1 | 1 | 1 | 1 | 1 | 1 | 1 | 1 | 1 | 1 | 1 | 1 | 1 |
| Bits | 15 | 14 | 13 | 12 | 11 | 10 | 9 | 8 | 7 | 6 | 5 | 4 | 3 | 2 | 1 | 0 |
| R | GPIO0_TRIG_EN_TX_LO | | | | | | | | GPIO0_TRIG_EN_TX_HI | | | | | | | |
| W | | | | | | | | | | | | | | | | |
| Reset | 1 | 1 | 1 | 1 | 1 | 1 | 1 | 1 | 1 | 1 | 1 | 1 | 1 | 1 | 1 | 1 |

45.2.2.4.61.3 Fields

| Field | Function |
|------------------------------|---|
| 31-24 GPIO0_TRIG_EN_RX_LO | De-assertion time setting for GPIO0_TRIG_EN (RX) This field sets the point during a TSM RX sequence (the tsm_count[7:0] value) at which the GPIO0_TRIG_EN signal or group will transition from HI to LO. |
| 23-16 GPIO0_TRIG_EN_RX_HI | Assertion time setting for GPIO0_TRIG_EN (RX) This field sets the point during a TSM RX sequence (the tsm_count[7:0] value) at which the GPIO0_TRIG_EN signal or group will transition from LO to HI. |
| 15-8 GPIO0_TRIG_EN_TX_LO | De-assertion time setting for GPIO0_TRIG_EN (TX) This field sets the point during a TSM TX sequence (the tsm_count[7:0] value) at which the GPIO0_TRIG_EN signal or group will transition from HI to LO. |
| 7-0 GPIO0_TRIG_EN_TX_HI | Assertion time setting for GPIO0_TRIG_EN (TX) This field sets the point during a TSM TX sequence (the tsm_count[7:0] value) at which the GPIO0_TRIG_EN signal or group will transition from LO to HI. |

45.2.2.4.62 TSM_TIMING48 (TIMING48)

45.2.2.4.62.1 Address

| Register | Offset |
|----------|-----------|
| TIMING48 | 4005C3B0h |

45.2.2.4.62.2 Diagram

| | | | | | | | | | | | | | | | | |
|-------|---------------------|----|----|----|----|----|----|----|---------------------|----|----|----|----|----|----|----|
| Bits | 31 | 30 | 29 | 28 | 27 | 26 | 25 | 24 | 23 | 22 | 21 | 20 | 19 | 18 | 17 | 16 |
| R | GPIO1_TRIG_EN_RX_LO | | | | | | | | GPIO1_TRIG_EN_RX_HI | | | | | | | |
| W | | | | | | | | | | | | | | | | |
| Reset | 1 | 1 | 1 | 1 | 1 | 1 | 1 | 1 | 1 | 1 | 1 | 1 | 1 | 1 | 1 | 1 |
| Bits | 15 | 14 | 13 | 12 | 11 | 10 | 9 | 8 | 7 | 6 | 5 | 4 | 3 | 2 | 1 | 0 |
| R | GPIO1_TRIG_EN_TX_LO | | | | | | | | GPIO1_TRIG_EN_TX_HI | | | | | | | |
| W | | | | | | | | | | | | | | | | |
| Reset | 1 | 1 | 1 | 1 | 1 | 1 | 1 | 1 | 1 | 1 | 1 | 1 | 1 | 1 | 1 | 1 |

45.2.2.4.62.3 Fields

| Field | Function |
|------------------------------|---|
| 31-24 GPIO1_TRIG_EN_RX_LO | De-assertion time setting for GPIO1_TRIG_EN (RX) This field sets the point during a TSM RX sequence (the tsm_count[7:0] value) at which the GPIO1_TRIG_EN signal or group will transition from HI to LO. |
| 23-16 GPIO1_TRIG_EN_RX_HI | Assertion time setting for GPIO1_TRIG_EN (RX) This field sets the point during a TSM RX sequence (the tsm_count[7:0] value) at which the GPIO1_TRIG_EN signal or group will transition from LO to HI. |
| 15-8 GPIO1_TRIG_EN_TX_LO | De-assertion time setting for GPIO1_TRIG_EN (TX) This field sets the point during a TSM TX sequence (the tsm_count[7:0] value) at which the GPIO1_TRIG_EN signal or group will transition from HI to LO. |
| 7-0 GPIO1_TRIG_EN_TX_HI | Assertion time setting for GPIO1_TRIG_EN (TX) This field sets the point during a TSM TX sequence (the tsm_count[7:0] value) at which the GPIO1_TRIG_EN signal or group will transition from LO to HI. |

45.2.2.4.63 TSM_TIMING49 (TIMING49)

45.2.2.4.63.1 Address

| Register | Offset |
|----------|-----------|
| TIMING49 | 4005C3B4h |

45.2.2.4.63.2 Diagram

| | | | | | | | | | | | | | | | | |
|-------|---------------------|----|----|----|----|----|----|----|---------------------|----|----|----|----|----|----|----|
| Bits | 31 | 30 | 29 | 28 | 27 | 26 | 25 | 24 | 23 | 22 | 21 | 20 | 19 | 18 | 17 | 16 |
| R | GPIO2_TRIG_EN_RX_LO | | | | | | | | GPIO2_TRIG_EN_RX_HI | | | | | | | |
| W | | | | | | | | | | | | | | | | |
| Reset | 1 | 1 | 1 | 1 | 1 | 1 | 1 | 1 | 1 | 1 | 1 | 1 | 1 | 1 | 1 | 1 |
| Bits | 15 | 14 | 13 | 12 | 11 | 10 | 9 | 8 | 7 | 6 | 5 | 4 | 3 | 2 | 1 | 0 |
| R | GPIO2_TRIG_EN_TX_LO | | | | | | | | GPIO2_TRIG_EN_TX_HI | | | | | | | |
| W | | | | | | | | | | | | | | | | |
| Reset | 1 | 1 | 1 | 1 | 1 | 1 | 1 | 1 | 1 | 1 | 1 | 1 | 1 | 1 | 1 | 1 |

45.2.2.4.63.3 Fields

| Field | Function |
|------------------------------|---|
| 31-24 GPIO2_TRIG_EN_RX_LO | De-assertion time setting for GPIO2_TRIG_EN (RX) This field sets the point during a TSM RX sequence (the tsm_count[7:0] value) at which the GPIO2_TRIG_EN signal or group will transition from HI to LO. |
| 23-16 GPIO2_TRIG_EN_RX_HI | Assertion time setting for GPIO2_TRIG_EN (RX) This field sets the point during a TSM RX sequence (the tsm_count[7:0] value) at which the GPIO2_TRIG_EN signal or group will transition from LO to HI. |
| 15-8 GPIO2_TRIG_EN_TX_LO | De-assertion time setting for GPIO2_TRIG_EN (TX) This field sets the point during a TSM TX sequence (the tsm_count[7:0] value) at which the GPIO2_TRIG_EN signal or group will transition from HI to LO. |
| 7-0 GPIO2_TRIG_EN_TX_HI | Assertion time setting for GPIO2_TRIG_EN (TX) This field sets the point during a TSM TX sequence (the tsm_count[7:0] value) at which the GPIO2_TRIG_EN signal or group will transition from LO to HI. |

45.2.2.4.64 TSM_TIMING50 (TIMING50)

45.2.2.4.64.1 Address

| Register | Offset |
|----------|-----------|
| TIMING50 | 4005C3B8h |

45.2.2.4.64.2 Diagram

| | | | | | | | | | | | | | | | | |
|-------|---------------------|----|----|----|----|----|----|----|---------------------|----|----|----|----|----|----|----|
| Bits | 31 | 30 | 29 | 28 | 27 | 26 | 25 | 24 | 23 | 22 | 21 | 20 | 19 | 18 | 17 | 16 |
| R | GPIO3_TRIG_EN_RX_LO | | | | | | | | GPIO3_TRIG_EN_RX_HI | | | | | | | |
| W | | | | | | | | | | | | | | | | |
| Reset | 1 | 1 | 1 | 1 | 1 | 1 | 1 | 1 | 1 | 1 | 1 | 1 | 1 | 1 | 1 | 1 |
| Bits | 15 | 14 | 13 | 12 | 11 | 10 | 9 | 8 | 7 | 6 | 5 | 4 | 3 | 2 | 1 | 0 |
| R | GPIO3_TRIG_EN_TX_LO | | | | | | | | GPIO3_TRIG_EN_TX_HI | | | | | | | |
| W | | | | | | | | | | | | | | | | |
| Reset | 1 | 1 | 1 | 1 | 1 | 1 | 1 | 1 | 1 | 1 | 1 | 1 | 1 | 1 | 1 | 1 |

45.2.2.4.64.3 Fields

| Field | Function |
|------------------------------|---|
| 31-24 GPIO3_TRIG_EN_RX_LO | De-assertion time setting for GPIO3_TRIG_EN (RX) This field sets the point during a TSM RX sequence (the tsm_count[7:0] value) at which the GPIO3_TRIG_EN signal or group will transition from HI to LO. |
| 23-16 GPIO3_TRIG_EN_RX_HI | Assertion time setting for GPIO3_TRIG_EN (RX) This field sets the point during a TSM RX sequence (the tsm_count[7:0] value) at which the GPIO3_TRIG_EN signal or group will transition from LO to HI. |
| 15-8 GPIO3_TRIG_EN_TX_LO | De-assertion time setting for GPIO3_TRIG_EN (TX) This field sets the point during a TSM TX sequence (the tsm_count[7:0] value) at which the GPIO3_TRIG_EN signal or group will transition from HI to LO. |
| 7-0 GPIO3_TRIG_EN_TX_HI | Assertion time setting for GPIO3_TRIG_EN (TX) This field sets the point during a TSM TX sequence (the tsm_count[7:0] value) at which the GPIO3_TRIG_EN signal or group will transition from LO to HI. |

45.2.2.4.65 TSM_TIMING51 (TIMING51)

45.2.2.4.65.1 Address

| Register | Offset |
|----------|-----------|
| TIMING51 | 4005C3BCh |

45.2.2.4.65.2 Diagram

| | | | | | | | | | | | | | | | | |
|-------|---------------------------|----|----|----|----|----|----|----|---------------------------|----|----|----|----|----|----|----|
| Bits | 31 | 30 | 29 | 28 | 27 | 26 | 25 | 24 | 23 | 22 | 21 | 20 | 19 | 18 | 17 | 16 |
| R | RXTX_AUXPLL_BIAS_EN_RX_LO | | | | | | | | RXTX_AUXPLL_BIAS_EN_RX_HI | | | | | | | |
| W | | | | | | | | | | | | | | | | |
| Reset | 0 | 1 | 1 | 0 | 0 | 1 | 1 | 1 | 0 | 0 | 0 | 0 | 0 | 0 | 1 | 1 |
| Bits | 15 | 14 | 13 | 12 | 11 | 10 | 9 | 8 | 7 | 6 | 5 | 4 | 3 | 2 | 1 | 0 |
| R | 1 | | | | | | | | | | | | | | | |
| W | | | | | | | | | | | | | | | | |
| Reset | 1 | 1 | 1 | 1 | 1 | 1 | 1 | 1 | 1 | 1 | 1 | 1 | 1 | 1 | 1 | 1 |

45.2.2.4.65.3 Fields

| Field | Function |
|------------------------------------|---|
| 31-24 RXTX_AUXPLL_BIAS_EN_RX_LO | De-assertion time setting for RXTX_AUXPLL_BIAS_EN (RX) This field sets the point during a TSM RX sequence (the tsm_count[7:0] value) at which the RXTX_AUXPLL_BIAS_EN signal or group will transition from HI to LO. |
| 23-16 RXTX_AUXPLL_BIAS_EN_RX_HI | Assertion time setting for RXTX_AUXPLL_BIAS_EN (RX) This field sets the point during a TSM RX sequence (the tsm_count[7:0] value) at which the RXTX_AUXPLL_BIAS_EN signal or group will transition from LO to HI. |
| 15-0 — | Reserved |

45.2.2.4.66 TSM_TIMING52 (TIMING52)

45.2.2.4.66.1 Address

| Register | Offset |
|----------|-----------|
| TIMING52 | 4005C3C0h |

45.2.2.4.66.2 Diagram

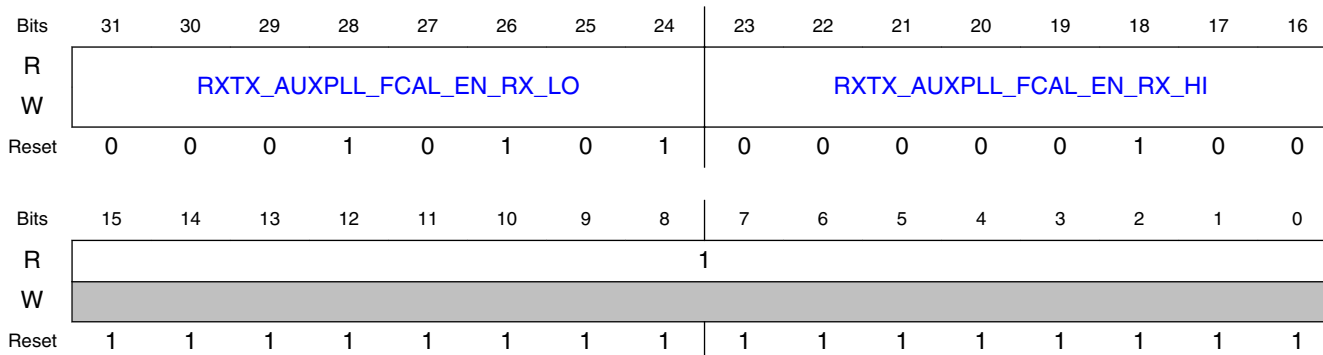

45.2.2.4.66.3 Fields

| Field | Function |
|------------------------------------|---|
| 31-24 RXTX_AUXPLL_FCAL_EN_RX_LO | De-assertion time setting for RXTX_AUXPLL_FCAL_EN (RX) This field sets the point during a TSM RX sequence (the tsm_count[7:0] value) at which the RXTX_AUXPLL_FCAL_EN signal or group will transition from HI to LO. |
| 23-16 RXTX_AUXPLL_FCAL_EN_RX_HI | Assertion time setting for RXTX_AUXPLL_FCAL_EN (RX) This field sets the point during a TSM RX sequence (the tsm_count[7:0] value) at which the RXTX_AUXPLL_FCAL_EN signal or group will transition from LO to HI. |
| 15-0 — | Reserved |

45.2.2.4.67 TSM_TIMING53 (TIMING53)

45.2.2.4.67.1 Address

| Register | Offset |
|----------|-----------|
| TIMING53 | 4005C3C4h |

45.2.2.4.67.2 Diagram

| | | | | | | | | | | | | | | | | |
|-------|----------------------------|----|----|----|----|----|----|----|----------------------------|----|----|----|----|----|----|----|
| Bits | 31 | 30 | 29 | 28 | 27 | 26 | 25 | 24 | 23 | 22 | 21 | 20 | 19 | 18 | 17 | 16 |
| R | RXTX_AUXPLL_LF_PD_EN_RX_LO | | | | | | | | RXTX_AUXPLL_LF_PD_EN_RX_HI | | | | | | | |
| W | | | | | | | | | | | | | | | | |
| Reset | 0 | 1 | 1 | 0 | 0 | 1 | 1 | 1 | 0 | 0 | 0 | 0 | 0 | 1 | 0 | 0 |
| Bits | 15 | 14 | 13 | 12 | 11 | 10 | 9 | 8 | 7 | 6 | 5 | 4 | 3 | 2 | 1 | 0 |
| R | 1 | | | | | | | | | | | | | | | |
| W | | | | | | | | | | | | | | | | |
| Reset | 1 | 1 | 1 | 1 | 1 | 1 | 1 | 1 | 1 | 1 | 1 | 1 | 1 | 1 | 1 | 1 |

45.2.2.4.67.3 Fields

| Field | Function |
|-------------------------------------|---|
| 31-24 RXTX_AUXPLL_LF_PD_EN_RX_LO | De-assertion time setting for RXTX_AUXPLL_LF_PD_EN (RX) This field sets the point during a TSM RX sequence (the tsm_count[7:0] value) at which the RXTX_AUXPLL_LF_PD_EN signal or group will transition from HI to LO. |
| 23-16 RXTX_AUXPLL_LF_PD_EN_RX_HI | Assertion time setting for RXTX_AUXPLL_LF_PD_EN (RX) This field sets the point during a TSM RX sequence (the tsm_count[7:0] value) at which the RXTX_AUXPLL_LF_PD_EN signal or group will transition from LO to HI. |
| 15-0 — | Reserved |

45.2.2.4.68 TSM_TIMING54 (TIMING54)

45.2.2.4.68.1 Address

| Register | Offset |
|----------|-----------|
| TIMING54 | 4005C3C8h |

45.2.2.4.68.2 Diagram

| | | | | | | | | | | | | | | | | |
|-------|--|----|----|----|----|----|----|----|--|----|----|----|----|----|----|----|
| Bits | 31 | 30 | 29 | 28 | 27 | 26 | 25 | 24 | 23 | 22 | 21 | 20 | 19 | 18 | 17 | 16 |
| R | RXTX_AUXPLL_PD_LF_FILTER_CHARGE_EN_RX_LO | | | | | | | | RXTX_AUXPLL_PD_LF_FILTER_CHARGE_EN_RX_HI | | | | | | | |
| W | | | | | | | | | | | | | | | | |
| Reset | 0 | 0 | 0 | 1 | 0 | 1 | 0 | 1 | 0 | 0 | 0 | 0 | 0 | 1 | 0 | 0 |
| Bits | 15 | 14 | 13 | 12 | 11 | 10 | 9 | 8 | 7 | 6 | 5 | 4 | 3 | 2 | 1 | 0 |
| R | 1 | | | | | | | | | | | | | | | |
| W | | | | | | | | | | | | | | | | |
| Reset | 1 | 1 | 1 | 1 | 1 | 1 | 1 | 1 | 1 | 1 | 1 | 1 | 1 | 1 | 1 | 1 |

45.2.2.4.68.3 Fields

| Field | Function |
|---|---|
| 31-24 RXTX_AUXPLL_PD_LF_FILTER_CHARGE_EN_RX_LO | De-assertion time setting for RXTX_AUXPLL_PD_LF_FILTER_CHARGE_EN (RX) This field sets the point during a TSM RX sequence (the tsm_count[7:0] value) at which the RXTX_AUXPLL_PD_LF_FILTER_CHARGE_EN signal or group will transition from HI to LO. |
| 23-16 RXTX_AUXPLL_PD_LF_FILTER_CHARGE_EN_RX_HI | Assertion time setting for RXTX_AUXPLL_PD_LF_FILTER_CHARGE_EN (RX) This field sets the point during a TSM RX sequence (the tsm_count[7:0] value) at which the RXTX_AUXPLL_PD_LF_FILTER_CHARGE_EN signal or group will transition from LO to HI. |
| 15-0 — | Reserved |

45.2.2.4.69 TSM_TIMING55 (TIMING55)

45.2.2.4.69.1 Address

| Register | Offset |
|----------|-----------|
| TIMING55 | 4005C3CCh |

45.2.2.4.69.2 Diagram

| | | | | | | | | | | | | | | | | |
|-------|------------------------------|----|----|----|----|----|----|----|------------------------------|----|----|----|----|----|----|----|
| Bits | 31 | 30 | 29 | 28 | 27 | 26 | 25 | 24 | 23 | 22 | 21 | 20 | 19 | 18 | 17 | 16 |
| R | RXTX_AUXPLL_ADC_BUF_EN_RX_LO | | | | | | | | RXTX_AUXPLL_ADC_BUF_EN_RX_HI | | | | | | | |
| W | | | | | | | | | | | | | | | | |
| Reset | 0 | 1 | 1 | 0 | 0 | 1 | 1 | 1 | 0 | 0 | 0 | 1 | 1 | 1 | 1 | 0 |
| Bits | 15 | 14 | 13 | 12 | 11 | 10 | 9 | 8 | 7 | 6 | 5 | 4 | 3 | 2 | 1 | 0 |
| R | 1 | | | | | | | | | | | | | | | |
| W | | | | | | | | | | | | | | | | |
| Reset | 1 | 1 | 1 | 1 | 1 | 1 | 1 | 1 | 1 | 1 | 1 | 1 | 1 | 1 | 1 | 1 |

45.2.2.4.69.3 Fields

| Field | Function |
|---------------------------------------|---|
| 31-24 RXTX_AUXPLL_ADC_BUF_EN_RX_LO | De-assertion time setting for RXTX_AUXPLL_ADC_BUF_EN (RX) This field sets the point during a TSM RX sequence (the tsm_count[7:0] value) at which the RXTX_AUXPLL_ADC_BUF_EN signal or group will transition from HI to LO. |
| 23-16 RXTX_AUXPLL_ADC_BUF_EN_RX_HI | Assertion time setting for RXTX_AUXPLL_ADC_BUF_EN (RX) This field sets the point during a TSM RX sequence (the tsm_count[7:0] value) at which the RXTX_AUXPLL_ADC_BUF_EN signal or group will transition from LO to HI. |
| 15-0 — | Reserved |

45.2.2.4.70 TSM_TIMING56 (TIMING56)

45.2.2.4.70.1 Address

| Register | Offset |
|----------|-----------|
| TIMING56 | 4005C3D0h |

45.2.2.4.70.2 Diagram

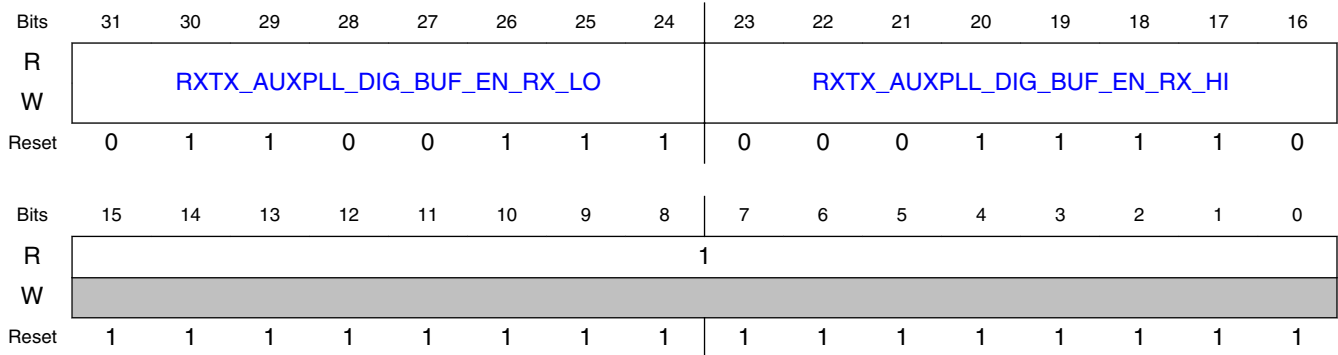

45.2.2.4.70.3 Fields

| Field | Function |
|---------------------------------------|---|
| 31-24 RXTX_AUXPLL_DIG_BUF_EN_RX_LO | De-assertion time setting for RXTX_AUXPLL_DIG_BUF_EN (RX) This field sets the point during a TSM RX sequence (the tsm_count[7:0] value) at which the RXTX_AUXPLL_DIG_BUF_EN signal or group will transition from HI to LO. |
| 23-16 RXTX_AUXPLL_DIG_BUF_EN_RX_HI | Assertion time setting for RXTX_AUXPLL_DIG_BUF_EN (RX) This field sets the point during a TSM RX sequence (the tsm_count[7:0] value) at which the RXTX_AUXPLL_DIG_BUF_EN signal or group will transition from LO to HI. |
| 15-0 — | Reserved |

45.2.2.4.71 TSM_TIMING57 (TIMING57)

45.2.2.4.71.1 Address

| Register | Offset |
|----------|-----------|
| TIMING57 | 4005C3D4h |

45.2.2.4.71.2 Diagram

| | | | | | | | | | | | | | | | | |
|-------|---------------------|----|----|----|----|----|----|----|---------------------|----|----|----|----|----|----|----|
| Bits | 31 | 30 | 29 | 28 | 27 | 26 | 25 | 24 | 23 | 22 | 21 | 20 | 19 | 18 | 17 | 16 |
| R | RXTX_RCCAL_EN_RX_LO | | | | | | | | RXTX_RCCAL_EN_RX_HI | | | | | | | |
| W | | | | | | | | | | | | | | | | |
| Reset | 0 | 0 | 0 | 1 | 1 | 0 | 1 | 0 | 0 | 0 | 0 | 0 | 0 | 0 | 1 | 1 |
| Bits | 15 | 14 | 13 | 12 | 11 | 10 | 9 | 8 | 7 | 6 | 5 | 4 | 3 | 2 | 1 | 0 |
| R | 1 | | | | | | | | | | | | | | | |
| W | | | | | | | | | | | | | | | | |
| Reset | 1 | 1 | 1 | 1 | 1 | 1 | 1 | 1 | 1 | 1 | 1 | 1 | 1 | 1 | 1 | 1 |

45.2.2.4.71.3 Fields

| Field | Function |
|------------------------------|---|
| 31-24 RXTX_RCCAL_EN_RX_LO | De-assertion time setting for RXTX_RCCAL_EN (RX) This field sets the point during a TSM RX sequence (the tsm_count[7:0] value) at which the RXTX_RCCAL_EN signal or group will transition from HI to LO. |
| 23-16 RXTX_RCCAL_EN_RX_HI | Assertion time setting for RXTX_RCCAL_EN (RX) This field sets the point during a TSM RX sequence (the tsm_count[7:0] value) at which the RXTX_RCCAL_EN signal or group will transition from LO to HI. |
| 15-0 — | Reserved |

45.2.2.4.72 TSM_TIMING58 (TIMING58)

45.2.2.4.72.1 Address

| Register | Offset |
|----------|-----------|
| TIMING58 | 4005C3D8h |

45.2.2.4.72.2 Diagram

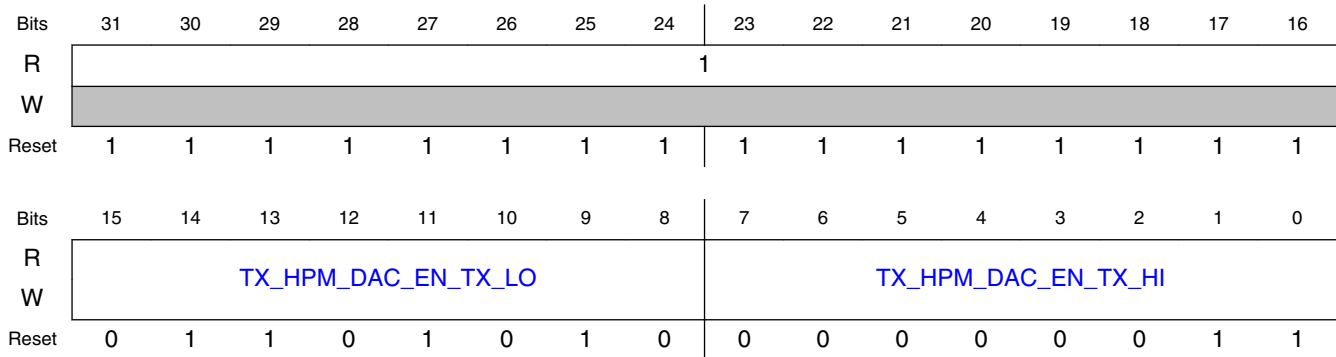

45.2.2.4.72.3 Fields

| Field | Function |
|-----------------------------|---|
| 31-16 — | Reserved |
| 15-8 TX_HPM_DAC_EN_TX_LO | De-assertion time setting for TX_HPM_DAC_EN (TX) This field sets the point during a TSM TX sequence (the tsm_count[7:0] value) at which the TX_HPM_DAC_EN signal or group will transition from HI to LO. |
| 7-0 TX_HPM_DAC_EN_TX_HI | Assertion time setting for TX_HPM_DAC_EN (TX) This field sets the point during a TSM TX sequence (the tsm_count[7:0] value) at which the TX_HPM_DAC_EN signal or group will transition from LO to HI. |

45.2.2.5 XCVR_MISC Register Descriptions

45.2.2.5.1 XCVR_CTRL_ADDR Memory Map

Base address: 4005C280h

| Offset | Register | Width (In bits) | Access | Reset value |
|-----------|--|--------------------|--------|------------------|
| 4005C280h | TRANSCEIVER CONTROL (XCVR_CTRL) | 32 | RW | 00101000h |
| 4005C284h | TRANSCEIVER STATUS (XCVR_STATUS) | 32 | W1C | See description. |
| 4005C288h | BLE ARBITRATION CONTROL (BLE_ARB_CTRL) | 32 | RW | 00000000h |
| 4005C290h | OVERWRITE VERSION (OVERWRITE_VER) | 32 | RW | 00000000h |
| 4005C294h | TRANSCEIVER DMA CONTROL (DMA_CTRL) | 32 | RW | 00000300h |

Table continues on the next page...

| Offset | Register | Width (In bits) | Access | Reset value |
|-----------|--|--------------------|--------|-------------|
| 4005C298h | TRANSCEIVER DMA DATA (DMA_DATA) | 32 | RO | 00000000h |
| 4005C2A0h | PACKET RAM CONTROL (PACKET_RAM_CTRL) | 32 | RW | 00000000h |
| 4005C2A4h | FAD CONTROL (FAD_CTRL) | 32 | RW | 0000F080h |
| 4005C2A8h | LOW POWER PREAMBLE SEARCH CONTROL (LPPS_CTRL) | 32 | RW | 64260000h |
| 4005C2ACh | WIFI COEXISTENCE CONTROL (RF_NOT_ALLOWED_CTRL) | 32 | RW | 00000000h |
| 4005C2B0h | CRC/WHITENER CONTROL (CRCW_CFG) | 32 | RW | 00000001h |
| 4005C2B4h | CRC ERROR CORRECTION MASK (CRC_EC_MASK) | 32 | RO | 00000000h |
| 4005C2B8h | CRC RESULT (CRC_RES_OUT) | 32 | RO | 00000000h |

45.2.2.5.2 TRANSCEIVER CONTROL (XCVR_CTRL)

45.2.2.5.2.1 Address

| Register | Offset |
|-----------|-----------|
| XCVR_CTRL | 4005C280h |

45.2.2.5.2.2 Diagram

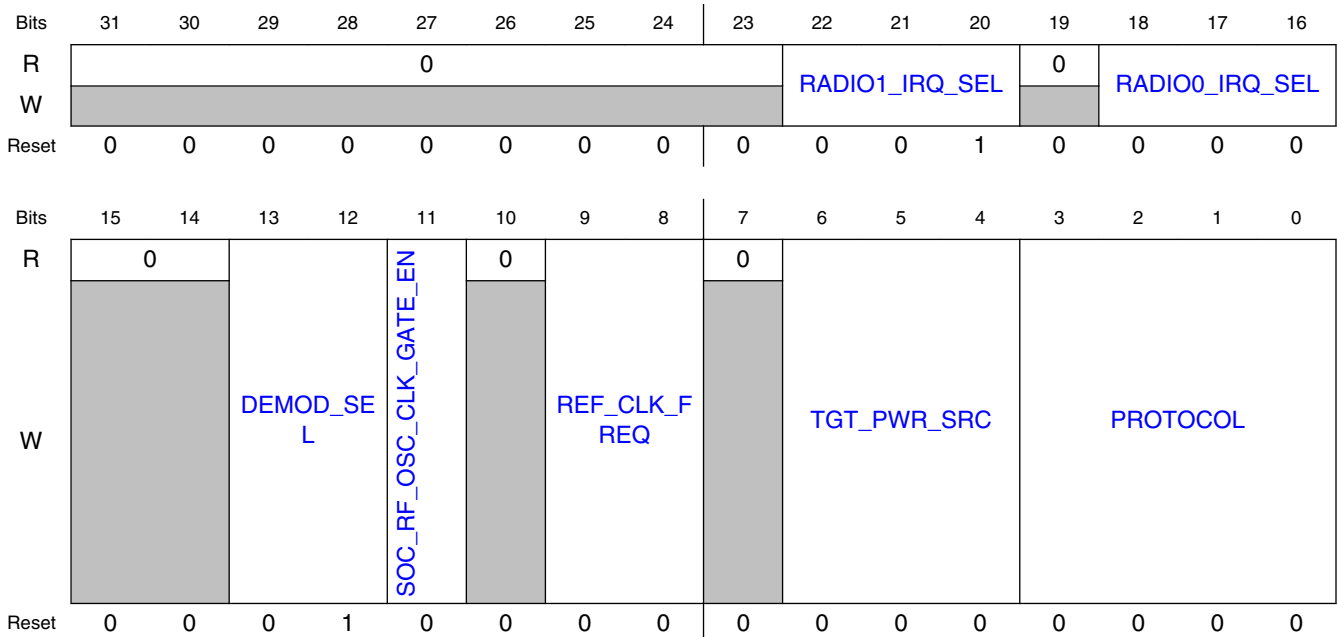

45.2.2.5.2.3 Fields

| Field | Function |
|------------------------------|--|
| 31-23 — | Reserved |
| 22-20 RADIO1_IRQ_SEL | RADIO1_IRQ_SEL Assigns Radio #1 Interrupt (ipi_int_radio1) to a Protocol Engine 000b - Assign Radio #1 Interrupt to BLE 001b - Assign Radio #1 Interrupt to 802.15.4 010b - Radio #1 Interrupt unassigned 011b - Assign Radio #1 Interrupt to GENERIC_FSK 100b - Radio #1 Interrupt unassigned 101b - Radio #1 Interrupt unassigned 110b - Radio #1 Interrupt unassigned 111b - Radio #1 Interrupt unassigned |
| 19 — | Reserved |
| 18-16 RADIO0_IRQ_SEL | RADIO0_IRQ_SEL Assigns Radio #0 Interrupt (ipi_int_radio0) to a Protocol Engine 000b - Assign Radio #0 Interrupt to BLE 001b - Assign Radio #0 Interrupt to 802.15.4 010b - Radio #0 Interrupt unassigned 011b - Assign Radio #0 Interrupt to GENERIC_FSK 100b - Radio #0 Interrupt unassigned 101b - Radio #0 Interrupt unassigned 110b - Radio #0 Interrupt unassigned 111b - Radio #0 Interrupt unassigned |
| 15-14 — | Reserved |
| 13-12 DEMOD_SEL | Demodulator Selector This bit selects the demodulator used during reception 00b - No demodulator selected 01b - Use Freescale Constant Envelope demodulator 10b - Use Legacy 802.15.4 demodulator 11b - Reserved |
| 11 SOC_RF_OSC_CLK_GATE_EN | SOC_RF_OSC_CLK_GATE_EN Enable 3V version of RF OSC Clock for use by the SoC |
| 10 — | Reserved |
| 9-8 REF_CLK_FREQ | Radio Reference Clock Frequency This register selects the Reference Clock Frequency for the Radio. 00b - 32 MHz 01b - 26 MHz 10b - Reserved 11b - Reserved |
| 7 — | Reserved |
| 6-4 | Target Power Source |

Table continues on the next page...

| Field | Function | | | | | | | | | | | | | | | | | | |
|------------------|---|------------------|---------------------|-------|-------------------------------------|-------|-----------------|-------|--|-------|----------|-------|--|-------|----------|-------|----------|-------|--|
| TGT_PWR_SRC C | For determining transmit power, the TGT_PWR_SRC[2:0] bits control target power selection, according to the following table. <table border="1"> <thead> <tr> <th>TGT_PWR_SRC[2:0]</th> <th>TARGET POWER SOURCE</th> </tr> </thead> <tbody> <tr> <td>0b000</td> <td>PA_POWER[5:0] register (XCVR space)</td> </tr> <tr> <td>0b001</td> <td>BTLE Link Layer</td> </tr> <tr> <td>0b010</td> <td>802.15.4 Link Layer (PA_PWR[5:0] register in 802.15.4 space)</td> </tr> <tr> <td>0b011</td> <td>Reserved</td> </tr> <tr> <td>0b100</td> <td>GENERIC_FSK Link Layer (TX_POWER[5:0] register in GENERIC_FSK space)</td> </tr> <tr> <td>0b101</td> <td>Reserved</td> </tr> <tr> <td>0b110</td> <td>Reserved</td> </tr> <tr> <td>0b111</td> <td>PROTOCOL[3:0] bits determine target power source</td> </tr> </tbody> </table> | TGT_PWR_SRC[2:0] | TARGET POWER SOURCE | 0b000 | PA_POWER[5:0] register (XCVR space) | 0b001 | BTLE Link Layer | 0b010 | 802.15.4 Link Layer (PA_PWR[5:0] register in 802.15.4 space) | 0b011 | Reserved | 0b100 | GENERIC_FSK Link Layer (TX_POWER[5:0] register in GENERIC_FSK space) | 0b101 | Reserved | 0b110 | Reserved | 0b111 | PROTOCOL[3:0] bits determine target power source |
| TGT_PWR_SRC[2:0] | TARGET POWER SOURCE | | | | | | | | | | | | | | | | | | |
| 0b000 | PA_POWER[5:0] register (XCVR space) | | | | | | | | | | | | | | | | | | |
| 0b001 | BTLE Link Layer | | | | | | | | | | | | | | | | | | |
| 0b010 | 802.15.4 Link Layer (PA_PWR[5:0] register in 802.15.4 space) | | | | | | | | | | | | | | | | | | |
| 0b011 | Reserved | | | | | | | | | | | | | | | | | | |
| 0b100 | GENERIC_FSK Link Layer (TX_POWER[5:0] register in GENERIC_FSK space) | | | | | | | | | | | | | | | | | | |
| 0b101 | Reserved | | | | | | | | | | | | | | | | | | |
| 0b110 | Reserved | | | | | | | | | | | | | | | | | | |
| 0b111 | PROTOCOL[3:0] bits determine target power source | | | | | | | | | | | | | | | | | | |
| 3-0 PROTOCOL | Radio Protocol Selection This register selects the Radio Communication Protocol. 0000b - BLE 0001b - BLE in MBAN 0010b - BLE overlap MBAN 0011b - Reserved 0100b - 802.15.4 0101b - 802.15.4j 0110b - 128 Channel FSK 0111b - 128 Channel GFSK 1000b - Generic FSK 1001b - MSK | | | | | | | | | | | | | | | | | | |

45.2.2.5.3 TRANSCEIVER STATUS (XCVR_STATUS)

45.2.2.5.3.1 Address

| Register | Offset |
|-------------|-----------|
| XCVR_STATUS | 4005C284h |

45.2.2.5.3.2 Diagram

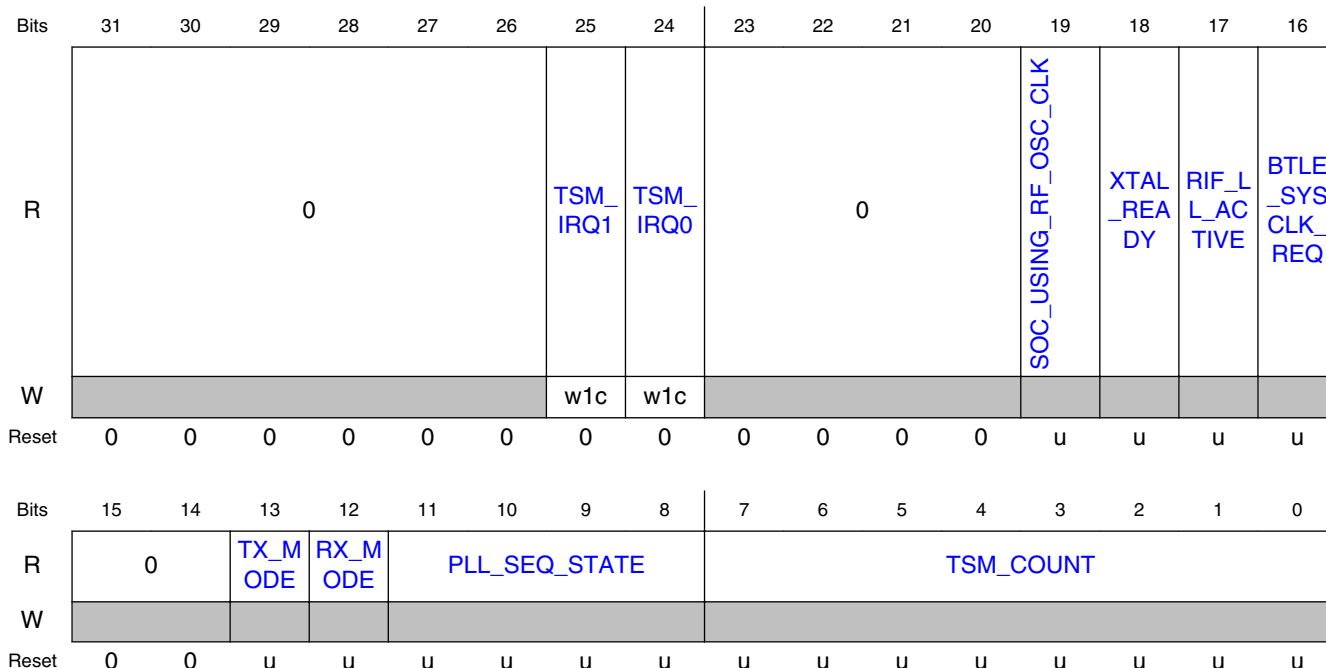

45.2.2.5.3.3 Fields

| Field | Function |
|----------------------------|---|
| 31-26 — | Reserved |
| 25 TSM_IRQ1 | TSM Interrupt #1 0b - TSM Interrupt #1 is not asserted. 1b - TSM Interrupt #1 is asserted. Write '1' to this bit to clear it. |
| 24 TSM_IRQ0 | TSM Interrupt #0 0b - TSM Interrupt #0 is not asserted. 1b - TSM Interrupt #0 is asserted. Write '1' to this bit to clear it. |
| 23-20 — | Reserved |
| 19 SOC_USING_RF_OSC_CLK | SOC Using RF Clock Indication SoC signal from the CLKGEN that asserts high when the MCG is configured to use RF OSC clock as the SoC clock source |
| 18 XTAL_READY | RF Oscillator Xtal Ready Oscillator warmup count complete. 0b - Indicates that the RF Oscillator is disabled or has not completed its warmup. 1b - Indicates that the RF Oscillator has completed its warmup count and is ready for use. |
| 17 RIF_LL_ACTIVE | Link Layer Active Indication Reflects the state of the BTLE “Link Layer Active” status bit. RIF_LL_ACTIVE is to be used by the host as an 'early' indication to prevent host to do any operations while BTLE IP is doing transceiver operations, so as to reduce the peak power and noise. |

Table continues on the next page...

| Field | Function |
|-----------------------|---|
| 16 BTLE_SYSCLK_REQ | BTLE System Clock Request Reflects the state of the BTLE oscillator request signal. BTLE_SYSCLK_REQ is the BTLE control for the RF Oscillator. BTLE will deassert this signal upon entering DSM (deep sleep mode) to request oscillator turn-off, and will re-assert it prior to exiting DSM. The turn-on leadtime on this signal for exiting DSM, is programmable with the BTLE block. This read-only bit can thus be queried to ascertain the power-state of BTLE. |
| 15-14 — | Reserved |
| 13 TX_MODE | Transmit Mode Indicates an TX transceiver operation is in progress. |
| 12 RX_MODE | Receive Mode Indicates an RX transceiver operation is in progress. |
| 11-8 PLL_SEQ_STATE | PLL Sequence State Reflects the state of the PLL digital state machine. 0000b - PLL OFF 0010b - CTUNE 0011b - CTUNE_SETTLE 0110b - HPMCAL1 1000b - HPMCAL1_SETTLE 1010b - HPMCAL2 1100b - HPMCAL2_SETTLE 1111b - PLLREADY |
| 7-0 TSM_COUNT | TSM_COUNT Reflects the instantaneous value of the TSM counter. |

45.2.2.5.4 BLE ARBITRATION CONTROL (BLE_ARB_CTRL)

45.2.2.5.4.1 Address

| Register | Offset |
|--------------|-----------|
| BLE_ARB_CTRL | 4005C288h |

Radio Register Overview

45.2.2.5.4.2 Diagram

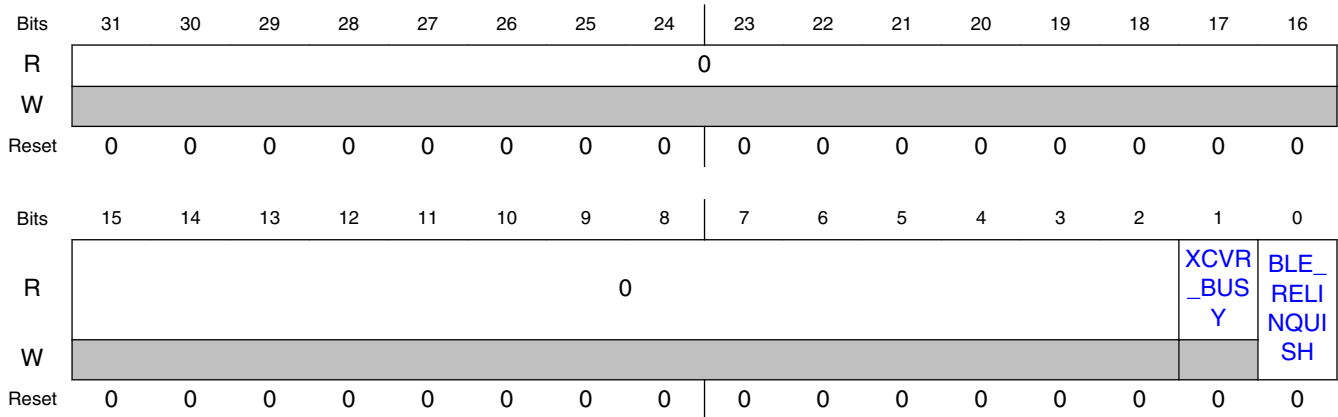

45.2.2.5.4.3 Fields

| Field | Function |
|-------------------------|--|
| 31-2 Reserved | Reserved |
| 1 XCVR_BUSY | Transceiver Busy Status Bit 0b - RF Channel in available (TSM is idle) 1b - RF Channel in use (TSM is busy) |
| 0 BLE_RELINQUI SH | BLE Relinquish Control This bit forces the BLE protocol engine to immediately relinquish access to the RF Channel, in favor of another protocol with higher arbitration priority. BLE is denied RF channel access by blocking BLE access to the TSM; when this bit is subsequently cleared, BLE access is restored. |

45.2.2.5.5 OVERWRITE VERSION (OVERWRITE_VER)

45.2.2.5.5.1 Address

| Register | Offset |
|---------------|-----------|
| OVERWRITE_VER | 4005C290h |

45.2.2.5.5.2 Function

The Overwrite Version allows software to store a version number of trim and calibration values which are used to overwrite the chip default values in the registers. Typically, software would perform the overwrite of the defaults in transceiver registers and then write the version number from the file containing the overwrite values into this register.

NOTE

This register has no hardware connections, it is simply a designated storage location for a version number.

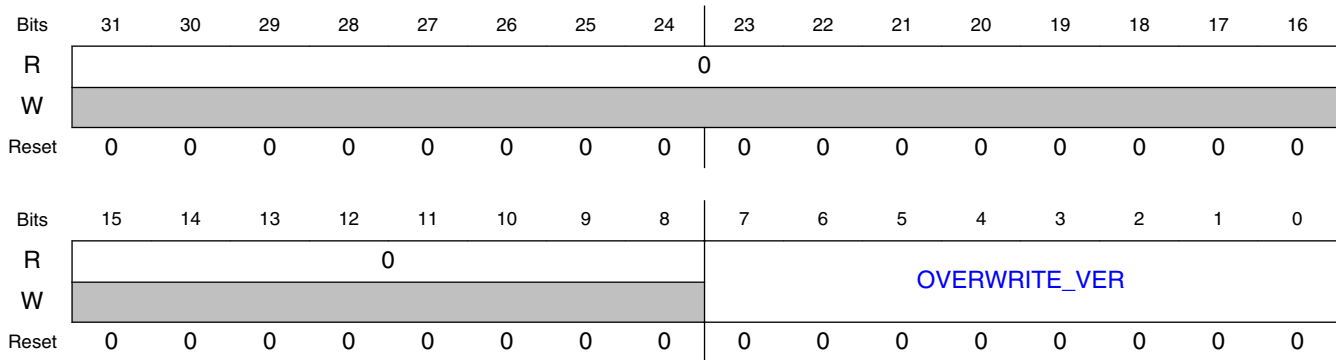
45.2.2.5.5.3 Diagram**45.2.2.5.5.4 Fields**

| Field | Function |
|--------------------------|---|
| 31-8 Reserved | Reserved |
| 7-0 OVERWRITE_V ER | Overwrite Version Number. Points to the version number of the overwrites.h file used to initialize the device; can be used by software to identify a version-controlled set of non-default values to be written into the transceiver's register map. |

45.2.2.5.6 TRANSCEIVER DMA CONTROL (DMA_CTRL)**45.2.2.5.6.1 Address**

| Register | Offset |
|----------|-----------|
| DMA_CTRL | 4005C294h |

45.2.2.5.6.2 Diagram

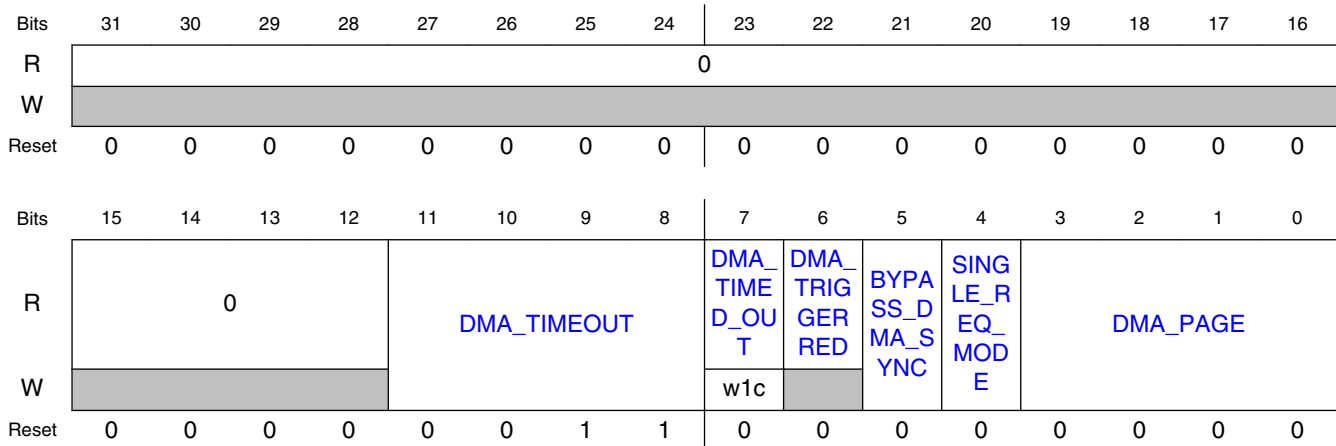

45.2.2.5.6.3 Fields

| Field | Function |
|----------------------|--|
| 31-12 Reserved | Reserved |
| 11-8 DMA_TIMEOUT | DMA Timeout In DMA Single Request Mode, adverse consequences may result if the transceiver's ips_xfr_wait signal is asserted for an excessively long period of time, which could occur due to mis-programming of the DMA2 controller, and/or the transceiver itself. DMA Timeout forces the transceiver's ips_xfr_wait low after <i>N</i> microseconds and sets the DMA_TIMED_OUT status bit, where <i>N</i> =DMA_TIMEOUT. DMA_TIMEOUT is only relevant when SINGLE_REQ_MODE=1, otherwise the transceiver does not assert ips_xfr_wait. |
| 7 DMA_TIMED_OUT | DMA Transfer Timed Out Status bit indicates that the transceiver DMA, while operating in Single Request Mode, asserted ips_xfr_wait for a period in excess of the programmed DMA_TIMEOUT setting, resulting in a timeout condition where the transceiver has forced ips_xfr_wait low. After a timeout, before resuming DMA operations, set DMA_PAGE=0 to disable DMA, and write 1 to this bit to clear it. 0b - A DMA timeout has not occurred 1b - A DMA timeout has occurred in Single Request Mode since the last time this bit was cleared |
| 6 DMA_TRIGGERED | DMA TRIGGERED This status bit becomes set when the PHY indicates that a Network Address match has occurred. In some cases it may be desirable to delay the start of DMA transfers until such a match occurs; in such cases, software can poll this bit, and once it becomes set, immediately select the desired DMA_PAGE to initiate DMA transfers. This bit is intended for use with DMA_PAGE=13, but is available on all pages. Its usage is optional. |
| 5 BYPASS_DMA_SYNC | Bypass External DMA Synchronization When using transceiver DMA with SINGLE_REQ_MODE=0, synchronization external to the transceiver must be bypassed in order to minimize bus access latency. Using DMA in this mode also requires that the MCU and transceiver both are configured to operate in the RF Oscillator clock domain. 0b - Don't Bypass External Synchronization. Use this setting if SINGLE_REQ_MODE=1. 1b - Bypass External Synchronization. This setting is mandatory if SINGLE_REQ_MODE=0. |
| 4 | DMA Single Request Mode |

Table continues on the next page...

| Field | Function |
|-----------------|---|
| SINGLE_REQ_MODE | <p>Configures the transceiver to transfer the entire block of DMA data with only a single initial request (ipd_req_radio_rx). The DMA2 controller must be configured accordingly. In this mode, the transceiver will use ips_xfr_wait to pace the individual transactions. Single Request Mode should not be used with DMA Pages 11, 12, or 13, because the data rate is too low and therefore ips_xfr_wait would remain asserted for excessively long periods.</p> <p>0b - Disable Single Request Mode. The transceiver will assert ipd_req_radio_rx whenever it has a new sample ready for transfer.</p> <p>1b - Enable Single Request Mode. A single initial request by the transceiver will transfer the entire DMA block of data</p> |
| 3-0 DMA_PAGE | <p>Transceiver DMA Page Selector</p> <p>Selects the page of receiver data for storage to system memory when using Transceiver DMA Debug Mode. Setting this register to a non-zero value enables the DMA interface logic. Setting this register to zero disables the interface and gates off all associated clocking. The available DMA pages are listed below.</p> <p>0000b - DMA Idle 0001b - RX_DIG I and Q 0010b - RX_DIG I Only 0011b - RX_DIG Q Only 0100b - RAW ADC I and Q 0101b - RAW ADC I Only 0110b - RAW ADC Q only 0111b - DC Estimator I and Q 1000b - DC Estimator I Only 1001b - DC Estimator Q only 1010b - RX_DIG Phase Output 1011b - Demodulator Hard Decision 1100b - Demodulator Soft Decision 1101b - Demodulator Data Output 1110b - Demodulator CFO Phase Output 1111b - Reserved</p> |

45.2.2.5.7 TRANSCEIVER DMA DATA (DMA_DATA)

45.2.2.5.7.1 Address

| Register | Offset |
|----------|-----------|
| DMA_DATA | 4005C298h |

45.2.2.5.7.2 Diagram

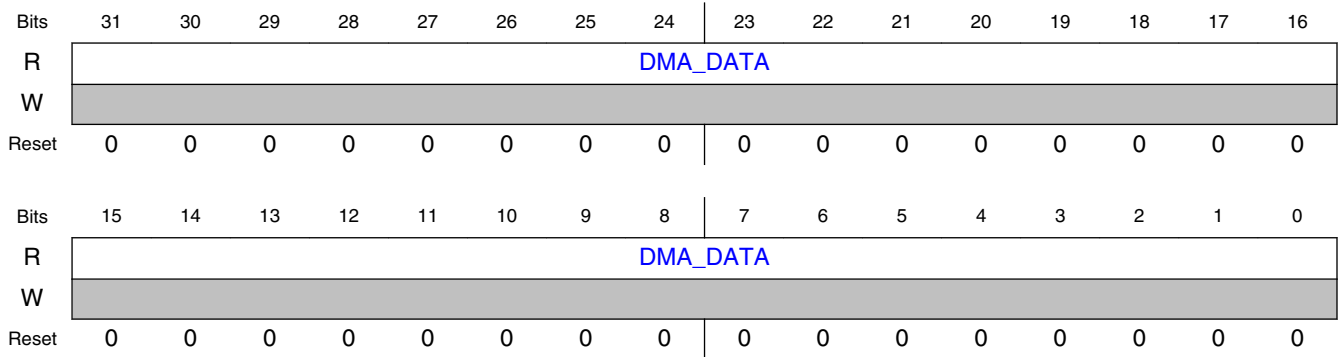

45.2.2.5.7.3 Fields

| Field | Function |
|------------------|--|
| 31-0 DMA_DATA | <p>DMA Data Register</p> <p>This register is the singular address location at which the SoC DMA controller accesses samples from the transceiver for transfer to system memory. During DMA operation, the contents of this register depend on the DMA Page selected. The DMA Data register is intended for DMA purposes only, not Host IPS accesses, but Host IPS bus access to this register is not prohibited.</p> |

45.2.2.5.8 PACKET RAM CONTROL (PACKET_RAM_CTRL)

45.2.2.5.8.1 Address

| Register | Offset |
|-----------------|-----------|
| PACKET_RAM_CTRL | 4005C2A0h |

45.2.2.5.8.2 Diagram

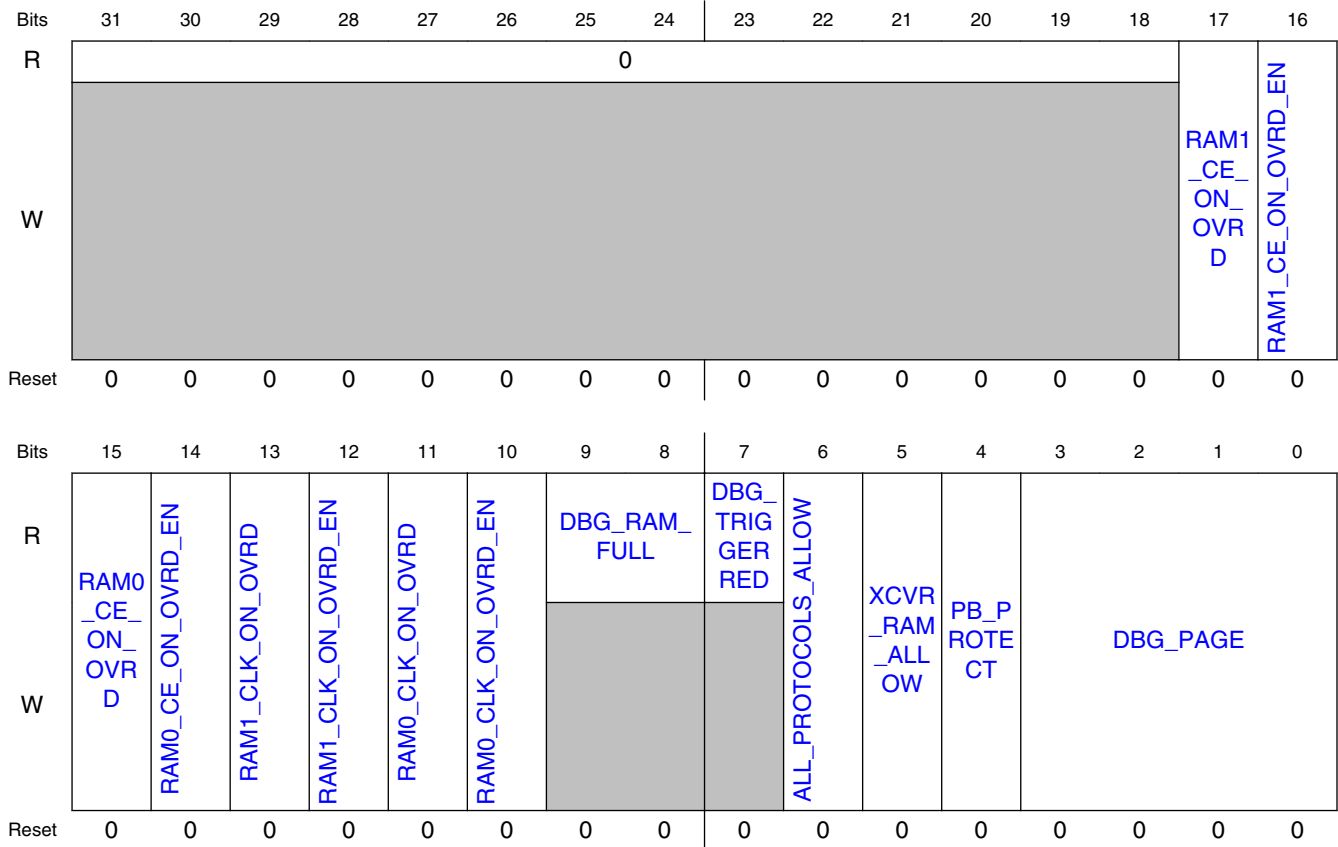

45.2.2.5.8.3 Fields

| Field | Function |
|--------------------------|---|
| 31-18 — | Reserved |
| 17 RAM1_CE_ON_OVRD | Override value for RAM1 CE (Chip Enable) When RAM1_CE_ON_OVRD_EN=1, this value overrides the mission mode state of the RAM1 CE. This bit is ignored when RAM1_CE_ON_OVRD_EN=0. |
| 16 RAM1_CE_ON_OVRD_EN | Override control for RAM1 CE (Chip Enable) 0b - Normal operation. 1b - Use the state of RAM1_CE_ON_OVRD to override the RAM1 CE. |
| 15 RAM0_CE_ON_OVRD | Override value for RAM0 CE (Chip Enable) When RAM0_CE_ON_OVRD_EN=1, this value overrides the mission mode state of the RAM0 CE. This bit is ignored when RAM0_CE_ON_OVRD_EN=0. |
| 14 RAM0_CE_ON_OVRD_EN | Override control for RAM0 CE (Chip Enable) 0b - Normal operation. 1b - Use the state of RAM0_CE_ON_OVRD to override the RAM0 CE. |
| 13 | Override value for RAM1 Clock Gate Enable |

Table continues on the next page...

Radio Register Overview

| Field | Function |
|---------------------------|---|
| RAM1_CLK_ON_OVRD | When RAM1_CLK_ON_OVRD_EN=1, this value overrides the mission mode state of the RAM1 Clock Gate Enable. This bit is ignored when RAM1_CLK_ON_OVRD_EN=0. |
| 12 RAM1_CLK_ON_OVRD_EN | Override control for RAM1 Clock Gate Enable 0b - Normal operation. 1b - Use the state of RAM1_CLK_ON_OVRD to override the RAM1 Clock Gate Enable. |
| 11 RAM0_CLK_ON_OVRD | Override value for RAM0 Clock Gate Enable When RAM0_CLK_ON_OVRD_EN=1, this value overrides the mission mode state of the RAM0 Clock Gate Enable. This bit is ignored when RAM0_CLK_ON_OVRD_EN=0. |
| 10 RAM0_CLK_ON_OVRD_EN | Override control for RAM0 Clock Gate Enable 0b - Normal operation. 1b - Use the state of RAM0_CLK_ON_OVRD to override the RAM0 Clock Gate Enable. |
| 9-8 DBG_RAM_FULL | DBG_RAM_FULL[1:0] Status Bits indicating that Packet RAM0 (or RAM1) is full, and the Packet RAM Debug engine has attempted to write another word to that RAM. This, and any subsequent write attempts, will not alter the contents of the RAM, once it has reached capacity. Set DBG_PAGE=0 to clear the DBG_RAM_FULL[1:0] bits. 00b - Neither Packet RAM0 nor RAM1 is full x1b - Packet RAM0 has been filled to capacity. 1xb - Packet RAM1 has been filled to capacity. |
| 7 DBG_TRIGGERED | DBG_TRIGGERED This status bit becomes set when the PHY indicates that a Network Address match has occurred. In some cases it may be desirable to delay the start of Packet RAM debug transfers until such a match occurs; in such cases, software can poll this bit, and once it becomes set, immediately select the desired DBG_PAGE to initiate data transfers to Packet RAM. This bit is intended for use with DBG_PAGE=13, but is available on all pages. Its usage is optional. |
| 6 ALL_PROTOCOLS_ALLOW | Allow IPS bus access to Packet RAM for any protocol at any time. Each supported protocol has an associated IPS bus, with which it can access protocol-specific registers, as well as Packet RAM. Normally IPS bus access to the Packet RAM is restricted to the protocol currently selected by the XCVR_CTRL[PROTOCOL] register, and access attempts by other protocols will result in an assert of ips_xfr_err on the offending IPS interface. When ALL_PROTOCOLS_ALLOW=1, these inhibitions are removed, and any IPS bus can access Packet RAM at any time without any error signalling. 0b - IPS bus access to Packet RAM is restricted to the protocol engine currently selected by XCVR_CTRL[PROTOCOL]. 1b - All IPS bus access to Packet RAM permitted, regardless of XCVR_CTRL[PROTOCOL] setting |
| 5 XCVR_RAM_ALLOW | Allow Packet RAM Transceiver Access This bit must be set before performing accesses to the Packet RAM using transceiver address space. Transceiver space accesses to Packet RAM are intended for debug purposes only; the individual protocol engines, and the associated IPS busses, have exclusive access to Packet RAM in mission modes. Transceiver space accesses to Packet RAM include direct accesses to RAM at transceiver addresses 0x700 - 0xF80, as well as Packet RAM Debug Mode. When this bit is set, control of RAM clock gating and RAM chip enables are forced on continuously, taking these controls away from the protocol engines. NOTE: In Packet RAM Debug mode, this bit should be set to 1 first, prior to setting DBG_PAGE to any non-zero setting 0b - Protocol Engines, and associated IPS busses, have exclusive access to Packet RAM (mission mode) 1b - Transceiver-space access to Packet RAM, including Packet RAM debug mode, are allowed |
| 4 PB_PROTECT | Packet Buffer Protect |

Table continues on the next page...

| Field | Function |
|-----------------|--|
| | Protect Packet Buffer contents against overwriting by the next received packet. Applies to all protocols except BLE 0b - Incoming received packets overwrite Packet Buffer RX contents (default) 1b - Incoming received packets are blocked from overwriting Packet Buffer RX contents |
| 3-0 DBG_PAGE | Packet RAM Debug Page Selector Selects the page of receiver data for storage to Packet RAM using Transceiver Packet RAM Debug Mode. Setting this register to a non-zero value enables the Packet RAM Debug mode interface logic. Setting this register to zero disables the interface logic and gates off all associated clocking. The available RAM Debug pages are listed below. 0000b - Packet RAM Debug Mode Idle 0001b - RX_DIG I and Q 0010b - Reserved 0011b - Reserved 0100b - RAW ADC I and Q 0101b - Reserved 0110b - Reserved 0111b - DC Estimator I and Q 1000b - Reserved 1001b - Reserved 1010b - RX_DIG Phase Output 1011b - Demodulator Hard Decision 1100b - Demodulator Soft Decision 1101b - Demodulator Data Output 1110b - Demodulator CFO Phase Output 1111b - Reserved |

45.2.2.5.9 FAD CONTROL (FAD_CTRL)

45.2.2.5.9.1 Address

| Register | Offset |
|----------|-----------|
| FAD_CTRL | 4005C2A4h |

45.2.2.5.9.2 Diagram

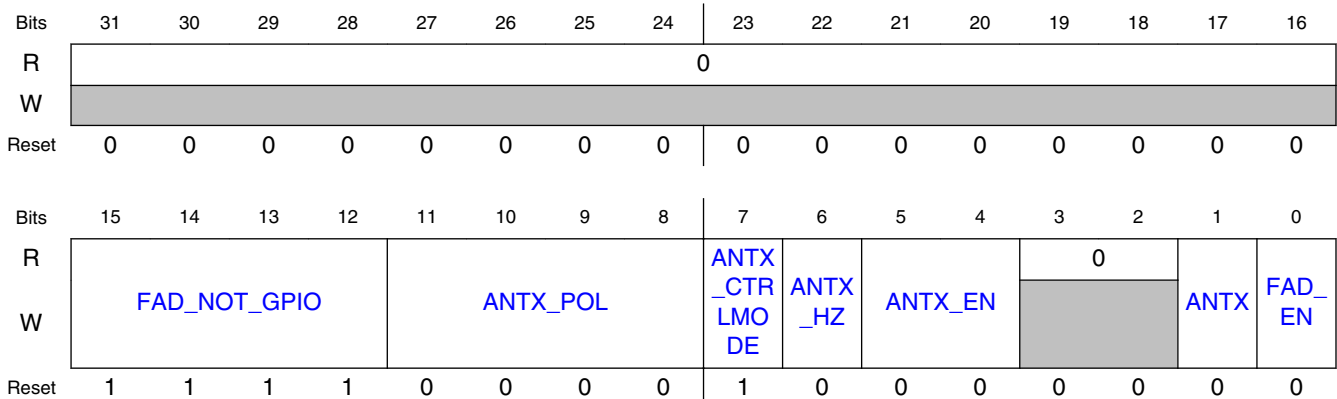

45.2.2.5.9.3 Fields

| Field | Function |
|-----------------------|--|
| 31-16 — | Reserved |
| 15-12 FAD_NOT_GPIO | <p>FAD versus GPIO Mode Selector</p> <p>xxx1: The ANT_A pad is controlled by the antenna-selection algorithm, modified by the register settings above {ANTX_CTRLMODE, ANTX_EN, ANTX_POL}</p> <p>xxx0: The ANT_A pad is controlled directly by the TSM output gpio0_trig_en</p> <p>xx1x: The ANT_B pad is controlled by the antenna-selection algorithm, modified by the register settings above {ANTX_CTRLMODE, ANTX_EN, ANTX_POL}</p> <p>xx0x: The ANT_B pad is controlled directly by the TSM output gpio1_trig_en</p> <p>x1xx: The TX_SWITCH pad is controlled by the antenna-selection algorithm, modified by the register settings above {ANTX_CTRLMODE, ANTX_EN, ANTX_POL}</p> <p>x0xx: The TX_SWITCH pad is controlled directly by the TSM output gpio2_trig_en</p> <p>1xxx: The RX_SWITCH pad is controlled by the antenna-selection algorithm, modified by the register settings above {ANTX_CTRLMODE, ANTX_EN, ANTX_POL}</p> <p>0xxx: The RX_SWITCH pad is controlled directly by the TSM output gpio3_trig_en</p> |
| 11-8 ANTX_POL | <p>FAD Antenna Controls Polarity</p> <p>Control the polarity of the FAD pins:</p> <p>ANTX_POL<0>=1 : invert the ANT_A output</p> <p>ANTX_POL<1>=1 : invert the ANT_B output</p> <p>ANTX_POL<2>=1 : invert the TX_SWITCH output</p> <p>ANTX_POL<3>=1 : invert the RX_SWITCH output</p> |
| 7 ANTX_CTRLMODE | <p>Antenna Diversity Control Mode</p> <p>When ANTX_CTRLMODE=1 (dual mode):</p> <p>ANT_A=NOT(ANTX) AND (GPIO3_TRIG_EN OR GPIO2_TRIG_EN)</p> <p>ANT_B=ANTX AND (GPIO3_TRIG_EN OR GPIO2_TRIG_EN)</p> <p>TX_SWITCH=GPIO2_TRIG_EN</p> <p>RX_SWITCH=GPIO3_TRIG_EN</p> <p>When ANTX_CTRLMODE=0 (single mode):</p> <p>ANT_A=NOT(ANTX) AND (GPIO3_TRIG_EN OR GPIO2_TRIG_EN)</p> <p>ANT_B=ANTX AND (GPIO3_TRIG_EN OR GPIO2_TRIG_EN)</p> <p>TX_SWITCH=GPIO2_TRIG_EN</p> <p>RX_SWITCH=(GPIO3_TRIG_EN OR GPIO2_TRIG_EN)</p> <p>GPIO2_TRIG_EN and GPIO3_TRIG_EN are outputs of the Transceiver Sequence Manager (TSM). The TSM timing registers associated with GPIO2_TRIG_EN and GPIO3_TRIG_EN should be programmed with the desired TX_SWITCH and RX_SWITCH timing, before enabling Fast Antenna Diversity.</p> |
| 6 ANTX_HZ | <p>FAD PAD Tristate Control</p> <p>0b - ANT_A, ANT_B, RX_SWITCH and TX_SWITCH are actively driven outputs.</p> |

Table continues on the next page...

| Field | Function |
|----------------|---|
| | 1b - Antenna controls high impedance- Set ANT_A, ANT_B, RX_SWITCH and TX_SWITCH in high impedance. |
| 5-4 ANTX_EN | FAD Antenna Controls Enable For any of the 4 FAD-related outputs {ANT_A, ANT_B, TX_SWITCH, RX_SWITCH}, when the associated register control bit (FAD_NOT_GPIO[x]=1) puts that output in FAD mode, ANTX_EN[1:0] determines which pairs of FAD related outputs are enabled: 00b - all disabled (held low) 01b - only RX/TX_SWITCH enabled 10b - only ANT_A/B enabled 11b - all enabled |
| 3-2 — | Reserved |
| 1 ANTX | Antenna Selection State If FAD_EN=0, the ANTX bit is used to take manual (software) control of the antenna selection, overriding the FAD state machine; in this case, the readback value of ANTX is whatever was last written by the host. If FAD_EN=1, the FAD state machine controls antenna selection, and the readback value of ANTX reflects the machine-selected antenna. |
| 0 FAD_EN | Fast Antenna Diversity Enable 0b - Fast Antenna Diversity disabled 1b - Fast Antenna Diversity enabled for 802.15.4 |

45.2.2.5.10 LOW POWER PREAMBLE SEARCH CONTROL (LPPS_CTRL)

45.2.2.5.10.1 Address

| Register | Offset |
|-----------|-----------|
| LPPS_CTRL | 4005C2A8h |

45.2.2.5.10.2 Diagram

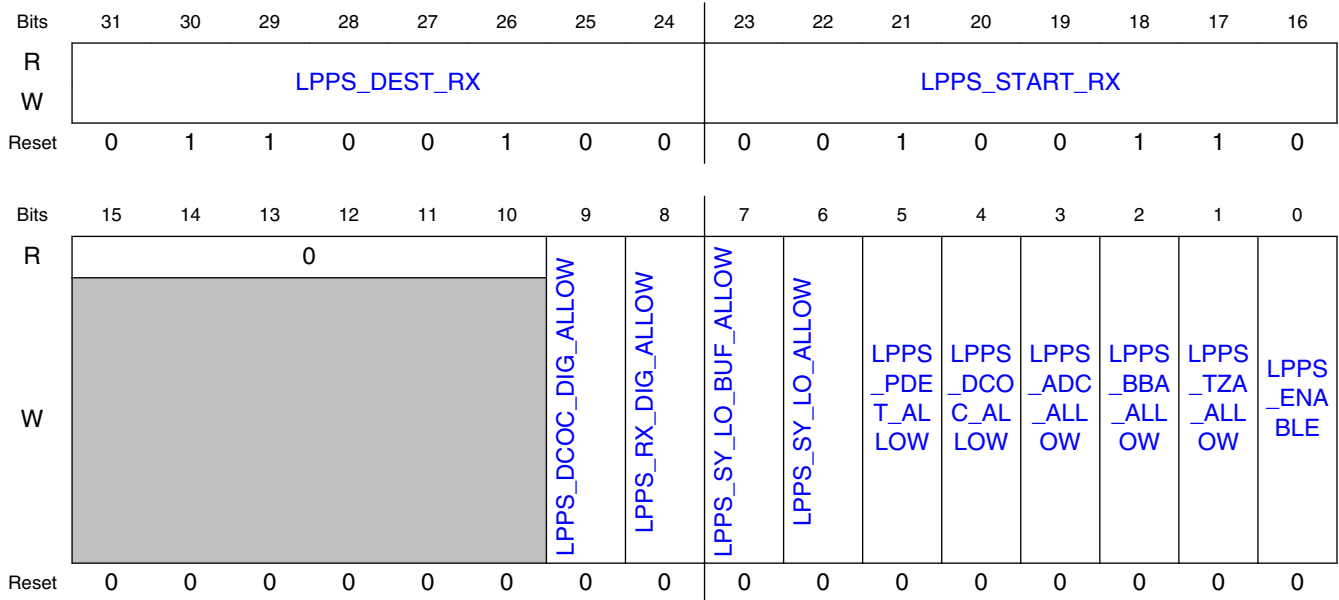

45.2.2.5.10.3 Fields

| Field | Function |
|--------------------------|--|
| 31-24 LPPS_DEST_RX | LPPS Fast TSM RX Warmup "Jump-to" Point During a LPPS Fast RX Warmup, this value represents the ending TSM count for the portion of the warmup that is to be skipped over. In an LPPS Fast RX Warmup, LPPS_START_RX[7:0] will never be reached and will instead be replaced by the contents of this register, thereby executing the jump. Example: LPPS_START_RX = 10 LPPS_DEST_RX = 15 The TSM will count as follows: ... 7,8,9,15,16,17 ... |
| 23-16 LPPS_START_RX | LPPS Fast TSM RX Warmup "Jump-from" Point During a LPPS Fast RX Warmup, this value represents the starting TSM count for the portion of the warmup that is to be skipped over. In an LPPS Fast RX Warmup, this count will never be reached; its place in the TSM warmup will be replaced by the contents of LPPS_DEST_RX[7:0], thereby executing the jump. |
| 15-10 — | Reserved |
| 9 LPPS_DCOC_DIG_ALLOW | LPPS_DCOC_DIG_ALLOW When set to one, allows the following TSM outputs to be controlled by the LPPS state machine: dcoc_en |
| 8 LPPS_RX_DIG_ALLOW | LPPS_RX_DIG_ALLOW When set to one, allows the following TSM outputs to be controlled by the LPPS state machine: rx_dig_en |
| 7 | LPPS_SY_LO_BUF_ALLOW |

Table continues on the next page...

| Field | Function |
|----------------------|--|
| LPPS_SY_LO_BUF_ALLOW | When set to one, allows the following TSM outputs to be controlled by the LPPS state machine: sy_lo_rx_buf_en |
| 6 | LPPS_SY_LO_ALLOW |
| LPPS_SY_LO_ALLOW | When set to one, allows the following TSM outputs to be controlled by the LPPS state machine: sy_lo_rx_en |
| 5 | LPPS_PDET_ALLOW |
| LPPS_PDET_ALLOW | When set to one, allows the following TSM outputs to be controlled by the LPPS state machine: rx_bba_pdet_en, rx_tza_pdet_en |
| 4 | LPPS_DCOC_ALLOW |
| LPPS_DCOC_ALLOW | When set to one, allows the following TSM outputs to be controlled by the LPPS state machine: rx_bba_dcoc_en, rx_tza_dcoc_en |
| 3 | LPPS_ADC_ALLOW |
| LPPS_ADC_ALLOW | When set to one, allows the following TSM outputs to be controlled by the LPPS state machine: rx_adc_en, rx_adc_i_en, rx_adc_q_en |
| 2 | LPPS_BBA_ALLOW |
| LPPS_BBA_ALLOW | When set to one, allows the following TSM outputs to be controlled by the LPPS state machine: rx_bba_i_en, rx_bba_q_en |
| 1 | LPPS_TZA_ALLOW |
| LPPS_TZA_ALLOW | When set to one, allows the following TSM outputs to be controlled by the LPPS state machine: rx_lna_en, rx_tza_i_en, rx_tza_q_en |
| 0 | LPPS_ENABLE |
| LPPS_ENABLE | Master enable for LPPS mode. Allows correlators to be duty-cycled during Preamble Search, and selected analog and digital blocks to be duty-cycled simultaneously. |

45.2.2.5.11 WIFI COEXISTENCE CONTROL (RF_NOT_ALLOWED_CTRL)

45.2.2.5.11.1 Address

| Register | Offset |
|---------------------|-----------|
| RF_NOT_ALLOWED_CTRL | 4005C2ACh |

45.2.2.5.11.2 Diagram

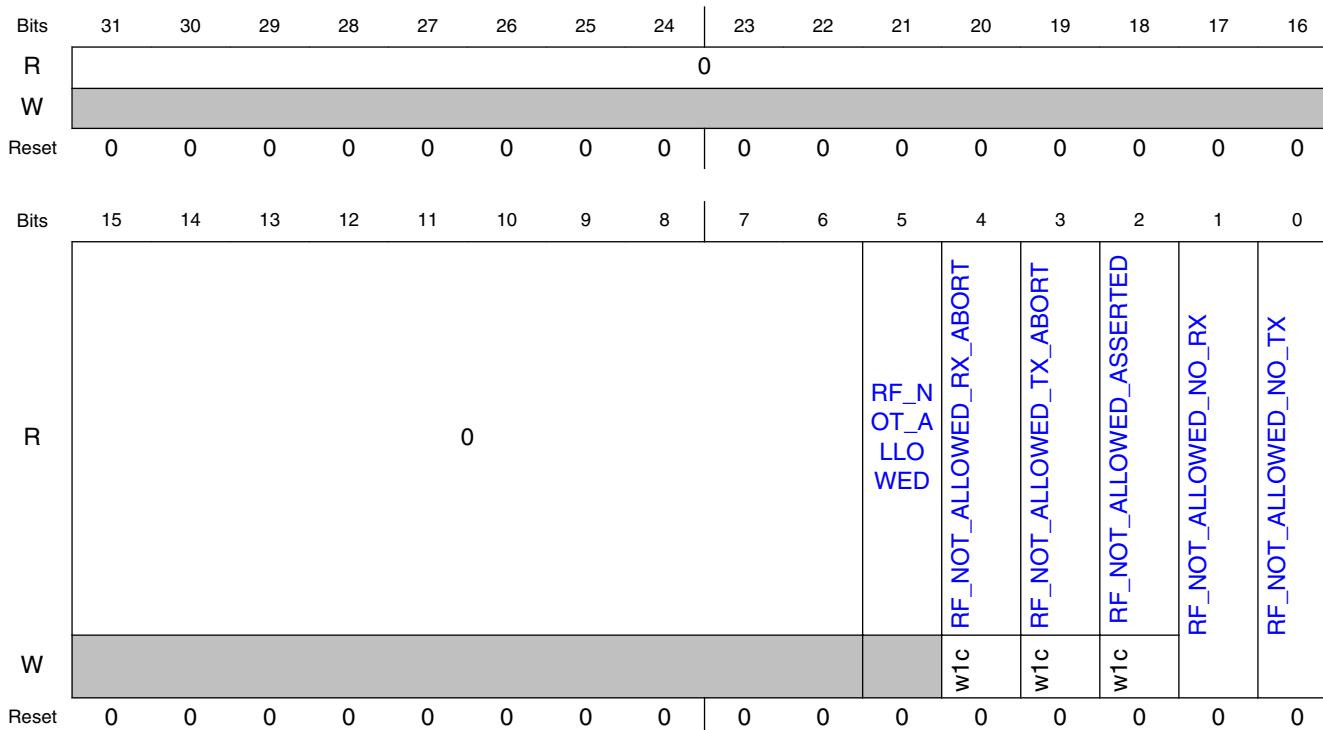

45.2.2.5.11.3 Fields

| Field | Function |
|------------------------------|--|
| 31-6 Reserved | Reserved |
| 5 RF_NOT_ALLOWED WED | RF_NOT_ALLOWED Reflects the instantaneous state of the RF_NOT_ALLOWED pin, synchronized into the RF OSC clock domain. |
| 4 RF_NOT_ALLOWED_RX_ABORT | RF_NOT_ALLOWED_RX_ABORT 0b - A RX abort due to assertion on RF_NOT_ALLOWED has not occurred 1b - A RX abort due to assertion on RF_NOT_ALLOWED has occurred since the last time this bit was cleared |
| 3 RF_NOT_ALLOWED_TX_ABORT | RF_NOT_ALLOWED_TX_ABORT 0b - A TX abort due to assertion on RF_NOT_ALLOWED has not occurred 1b - A TX abort due to assertion on RF_NOT_ALLOWED has occurred since the last time this bit was cleared |
| 2 RF_NOT_ALLOWED_ASSERTED | RF_NOT_ALLOWED_ASSERTED 0b - Assertion on RF_NOT_ALLOWED has not occurred 1b - Assertion on RF_NOT_ALLOWED has occurred since the last time this bit was cleared |
| 1 RF_NOT_ALLOWED_NO_RX | RF_NOT_ALLOWED_NO_RX 0b - Assertion on RF_NOT_ALLOWED has no effect on RX |

Table continues on the next page...

| Field | Function |
|-------------------------------|---|
| RF_NOT_ALLO WED_NO_RX | 1b - Assertion on RF_NOT_ALLOWED can abort RX |
| 0 RF_NOT_ALLO WED_NO_TX | RF_NOT_ALLOWED_NO_TX 0b - Assertion on RF_NOT_ALLOWED has no effect on TX 1b - Assertion on RF_NOT_ALLOWED can abort TX |

45.2.2.5.12 CRC/WHITENER CONTROL (CRCW_CFG)

45.2.2.5.12.1 Address

| Register | Offset |
|----------|-----------|
| CRCW_CFG | 4005C2B0h |

45.2.2.5.12.2 Diagram

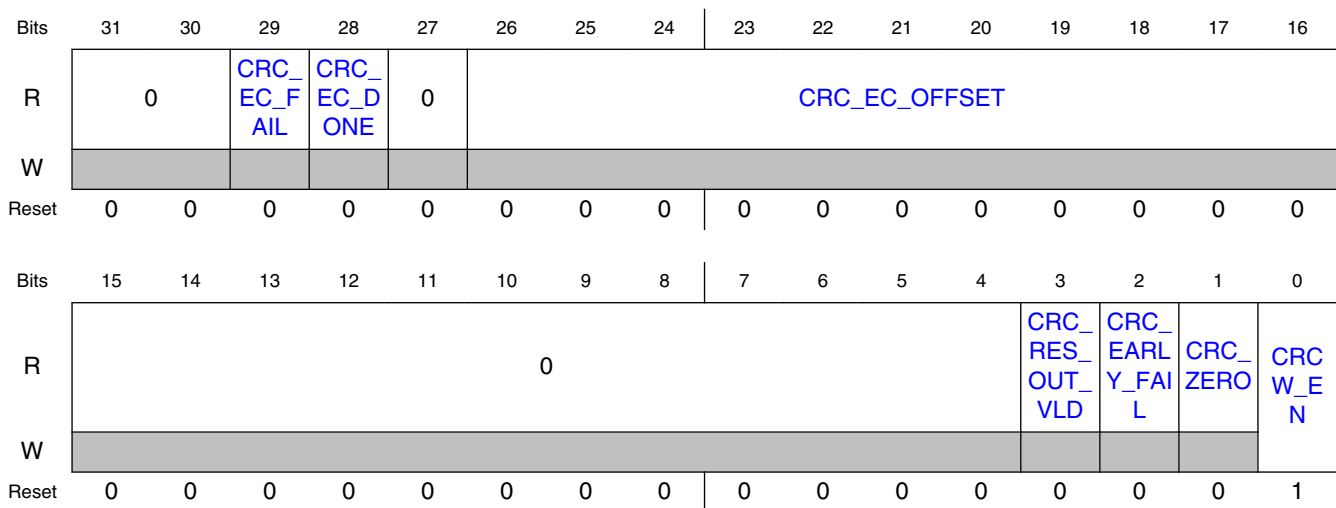

45.2.2.5.12.3 Fields

| Field | Function |
|-------------------|--|
| 31-30 — | Reserved |
| 29 CRC_EC_FAIL | CRC error correction fail This signal is cleared when <i>crc_init</i> is asserted. It is set after the completion of a CRC error correction calculation that does not find a valid data correction solution or if error correction was disabled and the CRC check found an error. |

Table continues on the next page...

Radio Register Overview

| Field | Function |
|----------------------------|--|
| 28 CRC_EC_DON E | CRC error correction done This signal is cleared when <i>crc_init</i> is asserted. It is set after the error correction logic completes processing the syndrome. It is immediately set after a packet is received if no error was detected or if error correction is disabled. Otherwise, it can take up to N system clocks after the packet is received to assert, with N = (number of bits used in the CRC calculation, including the CRC value). |
| 27 — | Reserved |
| 26-16 CRC_EC_OFFS ET | CRC error correction offset This value provides the byte offset within the data packet to which the CRC error correction mask should be XOR-ed. This value is valid if the <i>crc_ec_done</i> signal is asserted and the <i>crc_ec_fail</i> signal is not asserted. The offset includes only the bytes used in the CRC calculation, including the CRC value. |
| 15-4 — | Reserved |
| 3 CRC_RES_OUT _VLD | CRC result output valid CRC result output valid. |
| 2 CRC_EARLY_F AIL | CRC error correction fail This signal is cleared when <i>crc_init</i> is asserted. It is set after the completion of a CRC error correction calculation that does not find a valid data correction solution or if error correction was disabled and the CRC check found an error. |
| 1 CRC_ZERO | CRC zero This signal is asserted at any time that the CRC shift register contains a value of zero |
| 0 CRCW_EN | CRC calculation enable Input data bits loaded with this signal asserted are used in the CRC calculation. |

45.2.2.5.13 CRC ERROR CORRECTION MASK (CRC_EC_MASK)

45.2.2.5.13.1 Address

| Register | Offset |
|-------------|-----------|
| CRC_EC_MASK | 4005C2B4h |

45.2.2.5.13.2 Diagram

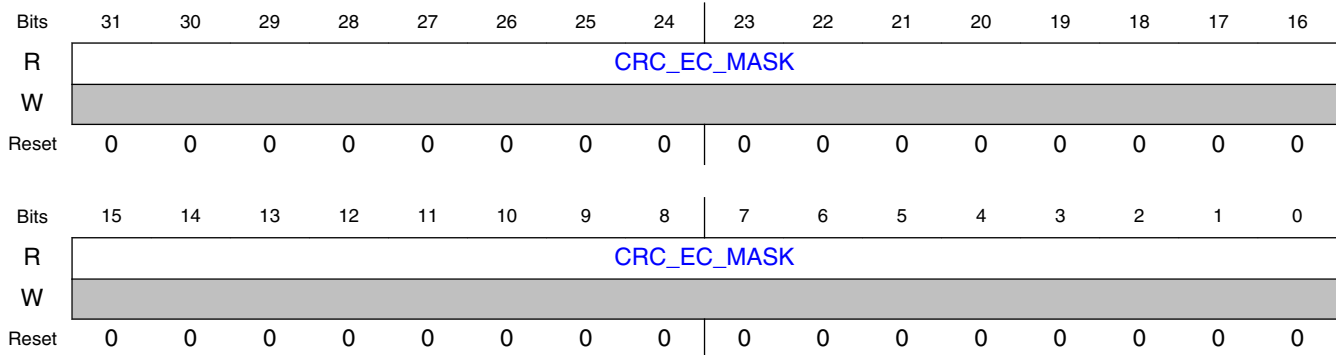

45.2.2.5.13.3 Fields

| Field | Function |
|-------------|---|
| 31-0 | CRC error correction mask |
| CRC_EC_MASK | This value provides a 32-bit XOR mask that must be applied to the input data packet to correct the burst errors detected by the error correction calculation. This value is valid if the <i>crc_ec_done</i> signal is asserted and the <i>crc_ec_fail</i> signal is not asserted. |

45.2.2.5.14 CRC RESULT (CRC_RES_OUT)

45.2.2.5.14.1 Address

| Register | Offset |
|-------------|-----------|
| CRC_RES_OUT | 4005C2B8h |

45.2.2.5.14.2 Diagram

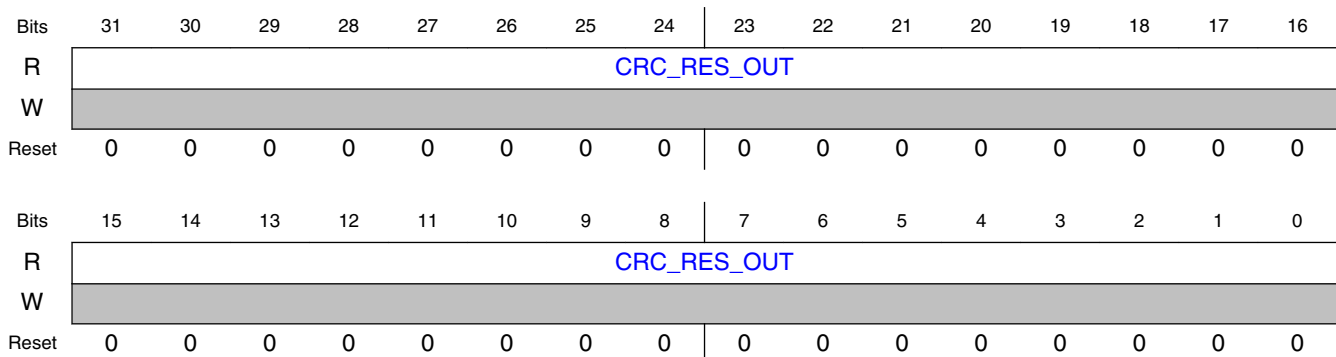

45.2.2.5.14.3 Fields

| Field | Function |
|-------------|--|
| 31-0 | CRC result output |
| CRC_RES_OUT | This bus provides the instantaneous value of the CRC shift register. |

45.2.2.6 XCVR_PHY Register Descriptions

45.2.2.6.1 XCVR_RX_PHY_ADDR Memory Map

Base address: 4005C400h

| Offset | Register | Width (In bits) | Access | Reset value |
|-----------|--|--------------------|--------|-------------|
| 4005C400h | PREAMBLE REFERENCE WAVEFORM 0 (PHY_PRE_REF0) | 32 | RW | FDDDEB39h |
| 4005C404h | PREAMBLE REFERENCE WAVEFORM 1 (PHY_PRE_REF1) | 32 | RW | BEFBFFFFh |
| 4005C408h | PREAMBLE REFERENCE WAVEFORM 2 (PHY_PRE_REF2) | 32 | RW | 0000CE75h |
| 4005C420h | PHY CONFIGURATION REGISTER 1 (PHY_CFG1) | 32 | RW | 1070CD16h |
| 4005C424h | PHY CONFIGURATION REGISTER 2 (PHY_CFG2) | 32 | RW | 01000A48h |
| 4005C428h | PHY EARLY/LATE CONFIGURATION REGISTER (PHY_EL_CFG) | 32 | RW | 00000000h |
| 4005C42Ch | PHY NETWORK ADDRESS FOR BSM (NTW_ADR_BSM) | 32 | RW | 00000000h |
| 4005C430h | PHY STATUS REGISTER (PHY_STATUS) | 32 | RO | 00000000h |

45.2.2.6.2 PREAMBLE REFERENCE WAVEFORM 0 (PHY_PRE_REF0)

45.2.2.6.2.1 Offset

| Register | Offset |
|--------------|-----------|
| PHY_PRE_REF0 | 4005C400h |

45.2.2.6.2.2 Diagram

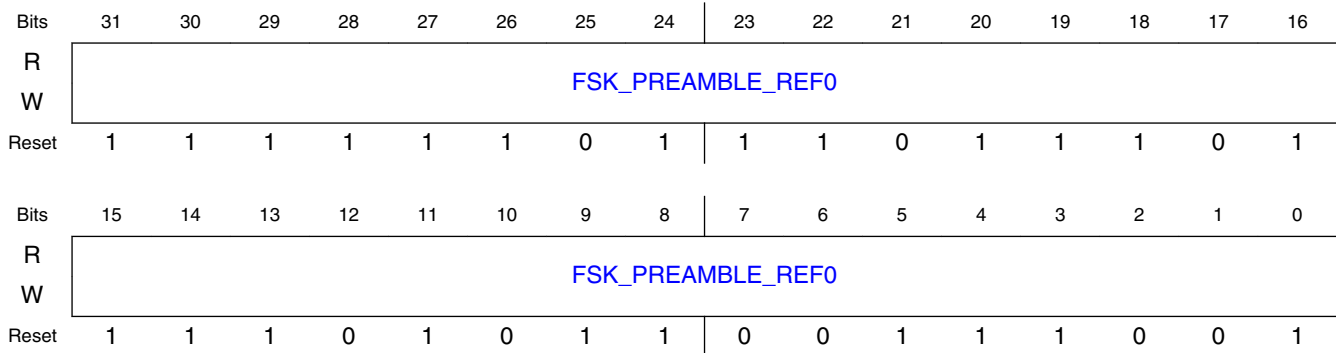

45.2.2.6.2.3 Fields

| Field | Function | | | | | | | | | | | | | | | | | | | | | | | | | | | | |
|---------------------------|---|-------------------|-------------------|-------------------|-------------------|--------------------------|------------|------------|------------|---------------------|------------|------------|------------|--------------------|------------|------------|------------|--------------------|------------|------------|------------|--------------------|------------|------------|------------|-----|------------|------------|------------|
| 31-0 FSK_PREAMBLE_REF0 | <p>Base preamble reference waveform containing sixteen 5-bit phase values represented in 2's complement notation using 1 sign bit and 4 fractional bits.</p> <p>Thus, the range of representable values is $[-1, 1-1/16]$ and they correspond to phases in the range $[-\pi, \pi(1-1/16)]$.</p> <p>Preamble reference waveform is an 80-bit vector; FSK_PREAMBLE_REF0 constitutes the lowest (least significant) component. The entire reference waveform is assembled by concatenating the following register values:</p> <p>Reference Waveform = {FSK_PREAMBLE_REF2[15:0], FSK_PREAMBLE_REF1[31:0], FSK_PREAMBLE_REF0[31:0]}</p> <p>The preamble reference waveforms for various PHY configurations are as follows:</p> <table border="1"> <thead> <tr> <th>Generic FSK MODE</th> <th>FSK_PREAMBLE_REF0</th> <th>FSK_PREAMBLE_REF1</th> <th>FSK_PREAMBLE_REF2</th> </tr> </thead> <tbody> <tr> <td>BLE (GFSK BT=0.5, h=0.5)</td> <td>0x79CDEB39</td> <td>0xCE77DEF7</td> <td>0x0000CEB7</td> </tr> <tr> <td>GFSK BT=0.5, h=0.32</td> <td>0xBBDE739B</td> <td>0xDEFBDEF7</td> <td>0x0000E739</td> </tr> <tr> <td>GFSK BT=0.5, h=0.7</td> <td>0x37ACE2F7</td> <td>0xADF3BDEF</td> <td>0x0000BE33</td> </tr> <tr> <td>GFSK BT=0.3, h=0.5</td> <td>0x7BCDEB39</td> <td>0xCEF7DEF7</td> <td>0x0000CEB7</td> </tr> <tr> <td>GFSK BT=0.7, h=0.5</td> <td>0x79CDEB39</td> <td>0xCE77DEF7</td> <td>0x0000CEB7</td> </tr> <tr> <td>MSK</td> <td>0x79CDEB38</td> <td>0xCE77DFF7</td> <td>0x0000CEB7</td> </tr> </tbody> </table> | Generic FSK MODE | FSK_PREAMBLE_REF0 | FSK_PREAMBLE_REF1 | FSK_PREAMBLE_REF2 | BLE (GFSK BT=0.5, h=0.5) | 0x79CDEB39 | 0xCE77DEF7 | 0x0000CEB7 | GFSK BT=0.5, h=0.32 | 0xBBDE739B | 0xDEFBDEF7 | 0x0000E739 | GFSK BT=0.5, h=0.7 | 0x37ACE2F7 | 0xADF3BDEF | 0x0000BE33 | GFSK BT=0.3, h=0.5 | 0x7BCDEB39 | 0xCEF7DEF7 | 0x0000CEB7 | GFSK BT=0.7, h=0.5 | 0x79CDEB39 | 0xCE77DEF7 | 0x0000CEB7 | MSK | 0x79CDEB38 | 0xCE77DFF7 | 0x0000CEB7 |
| Generic FSK MODE | FSK_PREAMBLE_REF0 | FSK_PREAMBLE_REF1 | FSK_PREAMBLE_REF2 | | | | | | | | | | | | | | | | | | | | | | | | | | |
| BLE (GFSK BT=0.5, h=0.5) | 0x79CDEB39 | 0xCE77DEF7 | 0x0000CEB7 | | | | | | | | | | | | | | | | | | | | | | | | | | |
| GFSK BT=0.5, h=0.32 | 0xBBDE739B | 0xDEFBDEF7 | 0x0000E739 | | | | | | | | | | | | | | | | | | | | | | | | | | |
| GFSK BT=0.5, h=0.7 | 0x37ACE2F7 | 0xADF3BDEF | 0x0000BE33 | | | | | | | | | | | | | | | | | | | | | | | | | | |
| GFSK BT=0.3, h=0.5 | 0x7BCDEB39 | 0xCEF7DEF7 | 0x0000CEB7 | | | | | | | | | | | | | | | | | | | | | | | | | | |
| GFSK BT=0.7, h=0.5 | 0x79CDEB39 | 0xCE77DEF7 | 0x0000CEB7 | | | | | | | | | | | | | | | | | | | | | | | | | | |
| MSK | 0x79CDEB38 | 0xCE77DFF7 | 0x0000CEB7 | | | | | | | | | | | | | | | | | | | | | | | | | | |

45.2.2.6.3 PREAMBLE REFERENCE WAVEFORM 1 (PHY_PRE_REF1)

45.2.2.6.3.1 Offset

| Register | Offset |
|--------------|-----------|
| PHY_PRE_REF1 | 4005C404h |

45.2.2.6.3.2 Diagram

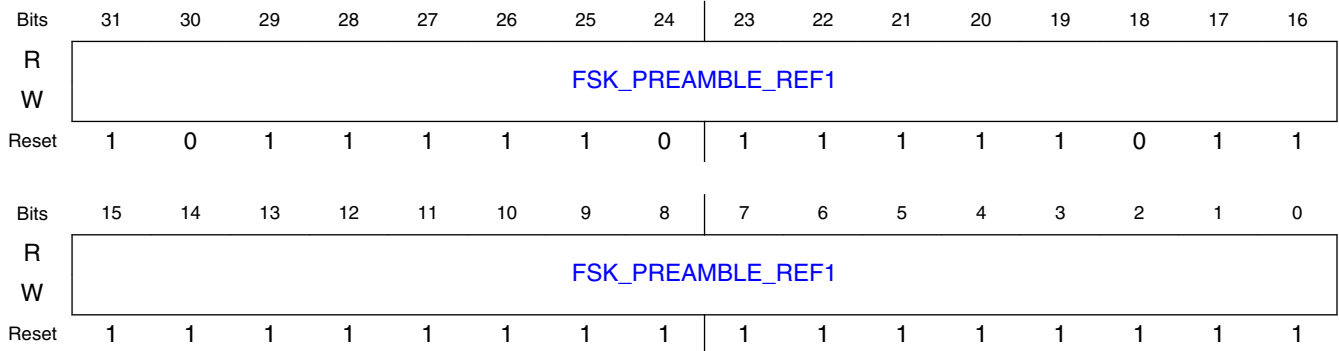

45.2.2.6.3.3 Fields

| Field | Function |
|-------------------------------|-----------------------------|
| 31-0 FSK_PREAMBL E_REF1 | Refer to FSK_PREAMBLE_REF0. |

45.2.2.6.4 PREAMBLE REFERENCE WAVEFORM 2 (PHY_PRE_REF2)

45.2.2.6.4.1 Offset

| Register | Offset |
|--------------|-----------|
| PHY_PRE_REF2 | 4005C408h |

45.2.2.6.4.2 Diagram

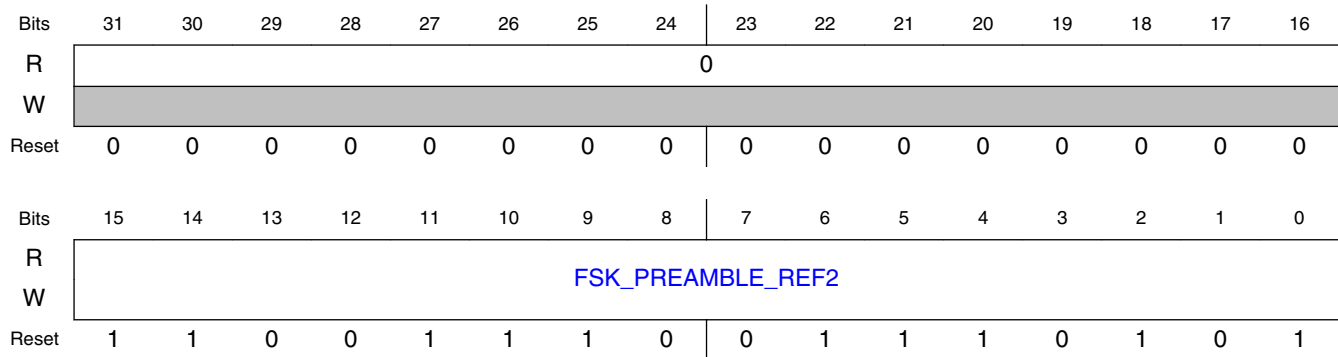

45.2.2.6.4.3 Fields

| Field | Function |
|-------------------------------|-----------------------------|
| 31-16 — | Reserved |
| 15-0 FSK_PREAMBL E_REF2 | Refer to FSK_PREAMBLE_REF0. |

45.2.2.6.5 PHY CONFIGURATION REGISTER 1 (PHY_CFG1)

45.2.2.6.5.1 Offset

| Register | Offset |
|----------|-----------|
| PHY_CFG1 | 4005C420h |

45.2.2.6.5.2 Diagram

| | | | | | | | | | | | | | | | | |
|-------|------------|-----------------|----|----|----|-------|----|-------|----------------|-----------------|------------|-------|----------------|---------------|----------------|----|
| Bits | 31 | 30 | 29 | 28 | 27 | 26 | 25 | 24 | 23 | 22 | 21 | 20 | 19 | 18 | 17 | 16 |
| R | 0 | BLE_NTW_ADR_THR | | | 0 | RFU02 | | RFU01 | 0 | FSK_FTS_TIMEOUT | | | 0 | | | |
| W | | | | | | | | | | | | | | | | |
| Reset | 0 | 0 | 0 | 1 | 0 | 0 | 0 | 0 | 0 | 1 | 1 | 1 | 0 | 0 | 0 | 0 |
| Bits | 15 | 14 | 13 | 12 | 11 | 10 | 9 | 8 | 7 | 6 | 5 | 4 | 3 | 2 | 1 | 0 |
| R | CTS_THRESH | | | | | | | | DEMOD_CLK_MODE | | BSM_ENABLE | RFU00 | FSK_BIT_INVERT | AA_OUTPUT_SEL | AA_PAYLOAD_ACK | 0 |
| W | | | | | | | | | | | | 0 | | | | |
| Reset | 1 | 1 | 0 | 0 | 1 | 1 | 0 | 1 | 0 | 0 | 0 | 1 | 0 | 1 | 1 | 0 |

45.2.2.6.5.3 Fields

| Field | Function |
|--------------------------|---|
| 31 — | Reserved |
| 30-28 BLE_NTW_ADR_THR | BLE Network Address Match Bit Error Threshold Number of Tolerated bit errors for Access Address correlation in BLE mode |
| 27-26 — | Reserved |
| 25 RFU02 | Reserved for future use. |
| 24 RFU01 | Reserved for future use. |
| 23 — | Reserved |
| 22-20 FSK_FTS_TIMEOUT | FSK FTS Timeout Number of symbols FTS is allowed to proceed beyond the expected end of the longest AA in FSK 000b - 4 symbols 001b - 5 symbols 010b - 6 symbols 011b - 7 symbols 100b - 8 symbols 101b - 9 symbols 110b - 10 symbols 111b - 11 symbols |
| 19-16 — | Reserved |
| 15-8 CTS_THRESH | CTS Correlation Threshold |

Table continues on the next page...

| Field | Function | | | | | | | | | | | | | | | | | | | | | | | | | | | | | | | | |
|---------------------------|---|-------------------|-------------------------------|------------------|-------------------------------|--------------------------|------|--------|-----------|---------------------------|------|--------|-----------|--------------------|-----|--------|-----------|--------------------|------|--------|-----------|-----|-----|--------|-----------|--------------------|-----|--------|-----------|--------------------|------|--------|-----------|
| | <p>Coarse Timing Search (CTS) correlation threshold is an unsigned 8-bit fixed-point number that represents a range of CTS threshold representable values in $[0, \dots, 1-1/2^8] = \{0000\ 0000, \dots, 1111\ 1111\}$. CTS Threshold is a function of the PHY modulation scheme, data rate, and the receiver chain filtering characteristics and is chosen to maximize the performance.</p> <p>The table below shows the threshold values for an assortment of FSK schemes. They are determined from Simulink model simulations. For more details, please refer to the Multi-PHY chapter in the 2.4GHz Radio 2 ADD.</p> <table border="1"> <thead> <tr> <th>Modulation Scheme</th> <th>Data Rate (kbps)</th> <th>CTS_THRESH value</th> <th>CTS_THRESH bit representation</th> </tr> </thead> <tbody> <tr> <td>BLE (GFSK BT=0.5, h=0.5)</td> <td>1000</td> <td>0.7500</td> <td>1100 0000</td> </tr> <tr> <td>ANT (GFSK BT=0.5, h=0.32)</td> <td>1000</td> <td>0.8008</td> <td>1100 1101</td> </tr> <tr> <td>GFSK BT=0.5, h=0.7</td> <td>500</td> <td>0.7500</td> <td>1100 0000</td> </tr> <tr> <td>GFSK BT=0.3, h=0.5</td> <td>1000</td> <td>0.8516</td> <td>1101 1010</td> </tr> <tr> <td>MSK</td> <td>500</td> <td>0.8125</td> <td>1101 0000</td> </tr> <tr> <td>GFSK BT=0.5, h=0.5</td> <td>250</td> <td>0.8750</td> <td>1110 0000</td> </tr> <tr> <td>GFSK BT=0.7, h=0.5</td> <td>1000</td> <td>0.8515</td> <td>1101 1010</td> </tr> </tbody> </table> | Modulation Scheme | Data Rate (kbps) | CTS_THRESH value | CTS_THRESH bit representation | BLE (GFSK BT=0.5, h=0.5) | 1000 | 0.7500 | 1100 0000 | ANT (GFSK BT=0.5, h=0.32) | 1000 | 0.8008 | 1100 1101 | GFSK BT=0.5, h=0.7 | 500 | 0.7500 | 1100 0000 | GFSK BT=0.3, h=0.5 | 1000 | 0.8516 | 1101 1010 | MSK | 500 | 0.8125 | 1101 0000 | GFSK BT=0.5, h=0.5 | 250 | 0.8750 | 1110 0000 | GFSK BT=0.7, h=0.5 | 1000 | 0.8515 | 1101 1010 |
| Modulation Scheme | Data Rate (kbps) | CTS_THRESH value | CTS_THRESH bit representation | | | | | | | | | | | | | | | | | | | | | | | | | | | | | | |
| BLE (GFSK BT=0.5, h=0.5) | 1000 | 0.7500 | 1100 0000 | | | | | | | | | | | | | | | | | | | | | | | | | | | | | | |
| ANT (GFSK BT=0.5, h=0.32) | 1000 | 0.8008 | 1100 1101 | | | | | | | | | | | | | | | | | | | | | | | | | | | | | | |
| GFSK BT=0.5, h=0.7 | 500 | 0.7500 | 1100 0000 | | | | | | | | | | | | | | | | | | | | | | | | | | | | | | |
| GFSK BT=0.3, h=0.5 | 1000 | 0.8516 | 1101 1010 | | | | | | | | | | | | | | | | | | | | | | | | | | | | | | |
| MSK | 500 | 0.8125 | 1101 0000 | | | | | | | | | | | | | | | | | | | | | | | | | | | | | | |
| GFSK BT=0.5, h=0.5 | 250 | 0.8750 | 1110 0000 | | | | | | | | | | | | | | | | | | | | | | | | | | | | | | |
| GFSK BT=0.7, h=0.5 | 1000 | 0.8515 | 1101 1010 | | | | | | | | | | | | | | | | | | | | | | | | | | | | | | |
| 7-6 DEMOD_CLK_MODE | Demodulator Clock Mode 00b - Normal 01b - Demodulate all samples 10b - Reserved 11b - Reserved | | | | | | | | | | | | | | | | | | | | | | | | | | | | | | | | |
| 5 BSM_EN_BLE | BLE Bit Streaming Mode Enable bit Enable the serialized, received BLE packet bitstream to appear on the BSM pins of the SoC. (See the XCVR BSM Block Guide) 0b - BSM for BLE disabled 1b - BSM for BLE enabled | | | | | | | | | | | | | | | | | | | | | | | | | | | | | | | | |
| 4 RFU00 | Reserved for future use. | | | | | | | | | | | | | | | | | | | | | | | | | | | | | | | | |
| 3 FSK_BIT_INVERT | FSK Bit Invert Inverts FSK mapping of symbols to bits when asserted. | | | | | | | | | | | | | | | | | | | | | | | | | | | | | | | | |
| | <table border="1"> <thead> <tr> <th>FSK_BIT_INVERT</th> <th>$E_s \geq 0$</th> <th>$E_s < 0$</th> </tr> </thead> <tbody> <tr> <td>0</td> <td>1</td> <td>0</td> </tr> <tr> <td>1</td> <td>0</td> <td>1</td> </tr> </tbody> </table> <p>In the table above, E_s is the soft bit output from the symbol demodulator.</p> | FSK_BIT_INVERT | $E_s \geq 0$ | $E_s < 0$ | 0 | 1 | 0 | 1 | 0 | 1 | | | | | | | | | | | | | | | | | | | | | | | |
| FSK_BIT_INVERT | $E_s \geq 0$ | $E_s < 0$ | | | | | | | | | | | | | | | | | | | | | | | | | | | | | | | |
| 0 | 1 | 0 | | | | | | | | | | | | | | | | | | | | | | | | | | | | | | | |
| 1 | 0 | 1 | | | | | | | | | | | | | | | | | | | | | | | | | | | | | | | |
| 2 AA_OUTPUT_SEL | Access Address Output Select Selects whether the demodulated AA bit sequence or the matched AA pattern is output. 0b - demodulated 1b - matched | | | | | | | | | | | | | | | | | | | | | | | | | | | | | | | | |
| 1 | Access Address Playback | | | | | | | | | | | | | | | | | | | | | | | | | | | | | | | | |

Table continues on the next page...

Radio Register Overview

| Field | Function | | | | | | | | | | | | |
|-------------|--|---|---------------|-------------|---|---|---|---|---|---|---|---|---|
| AA_PLAYBACK | <p>Enable/disable output of Access Address bit sequence via <i>data_out</i> port depending on <i>aa_output_sel</i> according to the following table:</p> <table border="1"> <thead> <tr> <th>AA_PLAYBACK</th> <th>AA_OUTPUT_SEL</th> <th>ACTIONUNITS</th> </tr> </thead> <tbody> <tr> <td>0</td> <td>X</td> <td>Only PDU bits output via <i>data_out</i> port. No AA bits</td> </tr> <tr> <td>1</td> <td>0</td> <td>Demodulated AA bits followed by PDU bits are output via <i>data_out</i> port.</td> </tr> <tr> <td>1</td> <td>1</td> <td>Matched AA bits followed by PDU bits are output via <i>data_out</i> port.</td> </tr> </tbody> </table> <p>Note: This bit must be set to 1 for Generic FSK, and must be set to 0 for BLE.</p> | AA_PLAYBACK | AA_OUTPUT_SEL | ACTIONUNITS | 0 | X | Only PDU bits output via <i>data_out</i> port. No AA bits | 1 | 0 | Demodulated AA bits followed by PDU bits are output via <i>data_out</i> port. | 1 | 1 | Matched AA bits followed by PDU bits are output via <i>data_out</i> port. |
| AA_PLAYBACK | AA_OUTPUT_SEL | ACTIONUNITS | | | | | | | | | | | |
| 0 | X | Only PDU bits output via <i>data_out</i> port. No AA bits | | | | | | | | | | | |
| 1 | 0 | Demodulated AA bits followed by PDU bits are output via <i>data_out</i> port. | | | | | | | | | | | |
| 1 | 1 | Matched AA bits followed by PDU bits are output via <i>data_out</i> port. | | | | | | | | | | | |
| 0 — | Reserved | | | | | | | | | | | | |

45.2.2.6.6 PHY CONFIGURATION REGISTER 2 (PHY_CFG2)

45.2.2.6.6.1 Offset

| Register | Offset |
|----------|-----------|
| PHY_CFG2 | 4005C424h |

45.2.2.6.6.2 Diagram

| | | | | | | | | | | | | | | | | | |
|-------|------|----|----|----|---------------|----|------|------|------|------|------|------|-----------------|------|------|------|------|
| Bits | 31 | 30 | 29 | 28 | 27 | 26 | 25 | 24 | 23 | 22 | 21 | 20 | 19 | 18 | 17 | 16 | |
| R | PHY_ | 0 | | | | | RFU1 | RFU1 | RFU1 | RFU1 | RFU1 | RFU1 | RFU1 | RFU1 | RFU0 | RFU0 | RFU0 |
| W | CLK_ | | | | | | 6 | 5 | 4 | 3 | 2 | 1 | 0 | 9 | 8 | 7 | |
| Reset | 0 | 0 | 0 | 0 | 0 | 0 | 0 | 1 | 0 | 0 | 0 | 0 | 0 | 0 | 0 | 0 | |
| Bits | 15 | 14 | 13 | 12 | 11 | 10 | 9 | 8 | 7 | 6 | 5 | 4 | 3 | 2 | 1 | 0 | |
| R | 0 | | | | X2_DEMOD_GAIN | | | | RFU0 | RFU0 | RFU0 | RFU0 | PHY_FIFO_PRECHG | | | | |
| W | | | | | | | | | 6 | 5 | 4 | 3 | | | | | |
| Reset | 0 | 0 | 0 | 0 | 1 | 0 | 1 | 0 | 0 | 1 | 0 | 0 | 1 | 0 | 0 | 0 | |

45.2.2.6.6.3 Fields

| Field | Function | | | | | | | | |
|---------------------------|--|---------------------|----------------------------------|---------------------|----------------------------------|--------------------------|------|--------|------|
| 31 PHY_CLK_ON | Force PHY Clock On (testmode) 0b - PHY clock is enabled by TSM output: rx_phy_en 1b - PHY clock is forced on at all times | | | | | | | | |
| 30-26 — | Reserved | | | | | | | | |
| 25 RFU16 | Reserved for future use. | | | | | | | | |
| 24 RFU15 | Reserved for future use. | | | | | | | | |
| 23 RFU14 | Reserved for future use. | | | | | | | | |
| 22 RFU13 | Reserved for future use. | | | | | | | | |
| 21 RFU12 | Reserved for future use. | | | | | | | | |
| 20 RFU11 | Reserved for future use. | | | | | | | | |
| 19 RFU10 | Reserved for future use. | | | | | | | | |
| 18 RFU09 | Reserved for future use. | | | | | | | | |
| 17 RFU08 | Reserved for future use. | | | | | | | | |
| 16 RFU07 | Reserved for future use. | | | | | | | | |
| 15-12 — | Reserved | | | | | | | | |
| 11-8 X2_DEMOD_G AIN | <p>X2_DEMOD_GAIN</p> <p>Gain parameter used in the symbol demodulator. The unsigned fixed-point gain is 4 bits wide representing a range of representable gain values: $[0, \dots, 1-1/2^4] = \{0000, \dots, 1111\}$. X2_DEMOD_GAIN is a function of the PHY modulation, scheme, data rate, and the receiver chain filtering characteristics and is chosen to minimize the demodulation bit error rate.</p> <p>The table below shows the recommended values for an assortment of FSK schemes. They are determined from Simulink model simulations. For more details, please refer to the Multi-PHY chapter in the 2.4GHz Radio Gen 2 ADD.</p> <table border="1"> <thead> <tr> <th>Modulation Scheme</th> <th>Data Rate (kbps)</th> <th>X2_DEMOD_GAIN value</th> <th>X2_DEMOD_GAIN bit representation</th> </tr> </thead> <tbody> <tr> <td>BLE (GFSK BT=0.5, h=0.5)</td> <td>1000</td> <td>0.6250</td> <td>1010</td> </tr> </tbody> </table> | Modulation Scheme | Data Rate (kbps) | X2_DEMOD_GAIN value | X2_DEMOD_GAIN bit representation | BLE (GFSK BT=0.5, h=0.5) | 1000 | 0.6250 | 1010 |
| Modulation Scheme | Data Rate (kbps) | X2_DEMOD_GAIN value | X2_DEMOD_GAIN bit representation | | | | | | |
| BLE (GFSK BT=0.5, h=0.5) | 1000 | 0.6250 | 1010 | | | | | | |

Table continues on the next page...

Radio Register Overview

| Field | Function | | | |
|----------------------------|---|------------------|---------------------|----------------------------------|
| | Modulation Scheme | Data Rate (kbps) | X2_DEMOD_GAIN value | X2_DEMOD_GAIN bit representation |
| | ANT (GFSK BT=0.5, h=0.32) | 1000 | 0.1875 | 0011 |
| | GFSK BT=0.5, h=0.7 | 500 | 0.6250 | 1010 |
| | GFSK BT=0.3, h=0.5 | 1000 | 0.6250 | 1010 |
| | MSK | 500 | 0.6250 | 1010 |
| | GFSK BT=0.5, h=0.5 | 250 | 0.2500 | 0100 |
| | GFSK BT=0.7, h=0.5 | 1000 | 0.5000 | 1000 |
| | | | | |
| 7 RFU06 | Reserved for future use. | | | |
| 6 RFU05 | Reserved for future use. | | | |
| 5 RFU04 | Reserved for future use. | | | |
| 4 RFU03 | Reserved for future use. | | | |
| 3-0 PHY_FIFO_PR ECHG | PHY FIFO Precharge Level Indicates the precharge depth of the output FIFO. | | | |

45.2.2.6.7 PHY EARLY/LATE CONFIGURATION REGISTER (PHY_EL_CFG)

45.2.2.6.7.1 Offset

| Register | Offset |
|------------|-----------|
| PHY_EL_CFG | 4005C428h |

45.2.2.6.7.2 Diagram

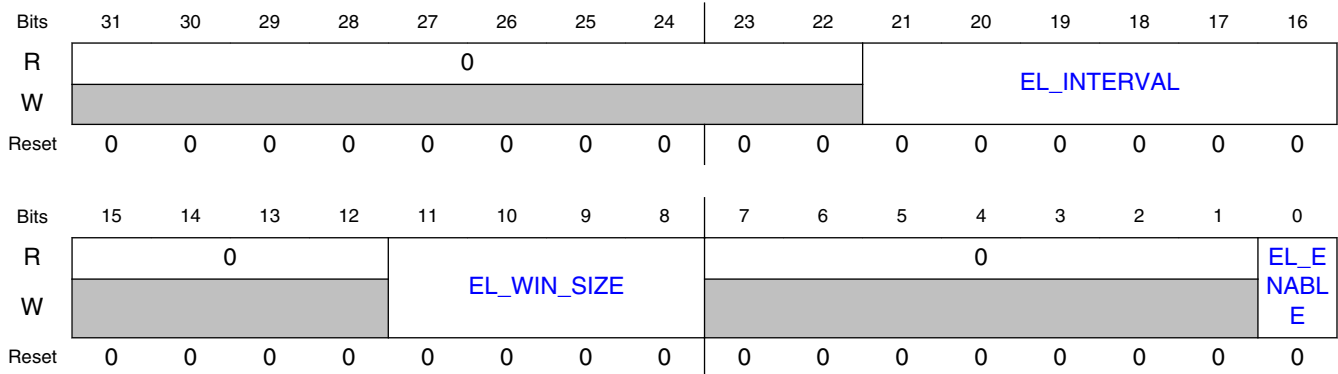

45.2.2.6.7.3 Fields

| Field | Function | | | | | | | | | |
|----------------------|---|-----------|-----|----------|------------------|---|---|------------------|----|---|
| 31-22 — | Reserved | | | | | | | | | |
| 21-16 EL_INTERVAL | EL_INTERVAL No. of FSK/IEEE 802.15.4 symbols between successive EL operation windows. Valid in both FSK and IEEE 802.15.4 modes. | | | | | | | | | |
| | <table border="1"> <thead> <tr> <th>Parameter</th> <th>BLE</th> <th>802.15.4</th> </tr> </thead> <tbody> <tr> <td>EL_WIN_SIZE[3:0]</td> <td>8</td> <td>3</td> </tr> <tr> <td>EL_INTERVAL[5:0]</td> <td>32</td> <td>7</td> </tr> </tbody> </table> | Parameter | BLE | 802.15.4 | EL_WIN_SIZE[3:0] | 8 | 3 | EL_INTERVAL[5:0] | 32 | 7 |
| Parameter | BLE | 802.15.4 | | | | | | | | |
| EL_WIN_SIZE[3:0] | 8 | 3 | | | | | | | | |
| EL_INTERVAL[5:0] | 32 | 7 | | | | | | | | |
| 15-12 — | Reserved | | | | | | | | | |
| 11-8 EL_WIN_SIZE | EL_WIN_SIZE Number of successive FSK/IEEE 802.15.4 symbols over which one EL operation occurs. Valid in both FSK and IEEE 802.15.4 modes. | | | | | | | | | |
| 7-1 — | Reserved | | | | | | | | | |
| 0 EL_ENABLE | EL_ENABLE Enable/disable EL mechanism during PDU/PSDU demodulation 0b - Disable Early/Late 1b - Enable Early/Late | | | | | | | | | |

45.2.2.6.8 PHY NETWORK ADDRESS FOR BSM (NTW_ADR_BSM)

45.2.2.6.8.1 Offset

| Register | Offset |
|-------------|-----------|
| NTW_ADR_BSM | 4005C42Ch |

45.2.2.6.8.2 Diagram

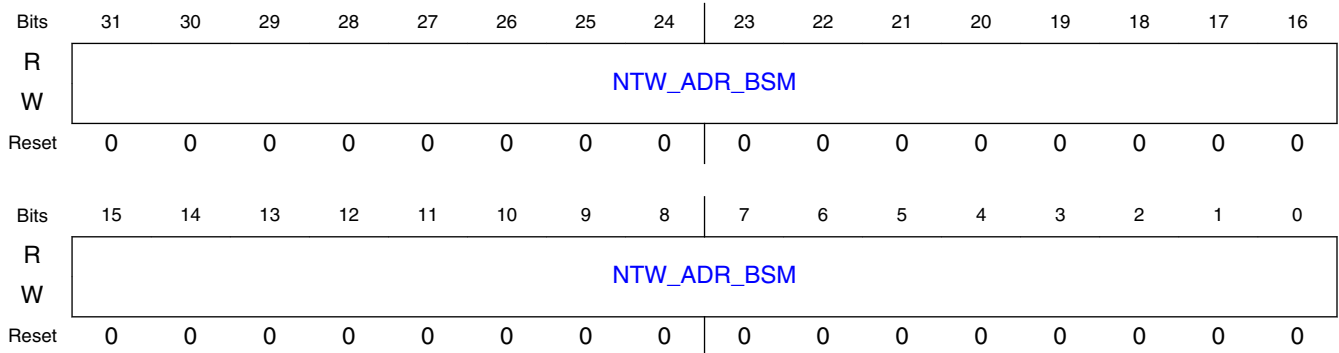

45.2.2.6.8.3 Fields

| Field | Function |
|-------------|--|
| 31-0 | NTW_ADR_BSM |
| NTW_ADR_BSM | PHY will search for this 32-bit Access Address when PHY_CFG1[BSM_EN_BLE]=1 |

45.2.2.6.9 PHY STATUS REGISTER (PHY_STATUS)

45.2.2.6.9.1 Offset

| Register | Offset |
|------------|-----------|
| PHY_STATUS | 4005C430h |

45.2.2.6.9.2 Diagram

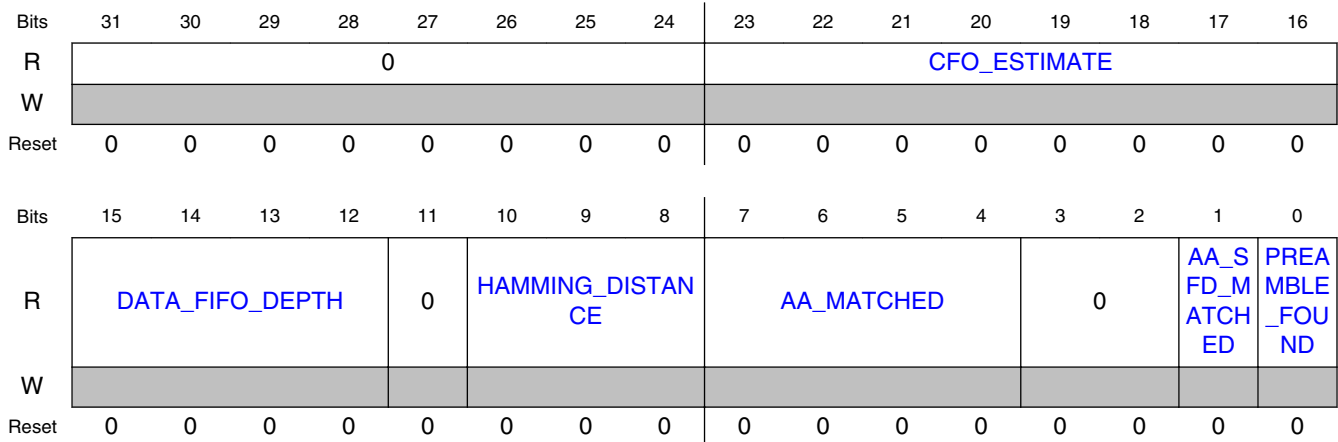

45.2.2.6.9.3 Fields

| Field | Function |
|--------------------------|---|
| 31-24 — | Reserved |
| 23-16 CFO_ESTIMATE | Carrier Frequency Offset Estimate Most recent estimate for Carrier Frequency Offset. The multiplication factor is 7812: i.e., CFO_ESTIMATE x 7812 = actually frequency offset in Hz (ideally). |
| 15-12 DATA_FIFO_DEPTH | DATA FIFO DEPTH Instantaneous depth of the PHY output FIFO. The difference between the FIFO write pointer and read pointer. |
| 11 — | Reserved |
| 10-8 HAMMING_DISTANCE | HAMMING DISTANCE Valid only in FSK mode. Indicates hamming distance between observed AA pattern and the candidate AA pattern that was found to be the best match. |
| 7-4 AA_MATCHED | Access Address Matched All bits reset in IDLE state. When any bit asserted, indicates which of the 4 Network Addresses has been matched. Valid only in FSK mode. 0000b - No Network Address has matched 0001b - Network Address 0 has matched 0010b - Network Address 1 has matched 0100b - Network Address 2 has matched 1000b - Network Address 3 has matched |
| 3-2 — | Reserved |
| 1 AA_SFD_MATCHED | Access Address or SFD Found Reset in IDLE state or when activate_search is de-asserted. Asserted when the AA/SFD is found. |

Table continues on the next page...

Radio Register Overview

| Field | Function |
|-------------------------|---|
| 0 PREAMBLE_FO UND | Preamble Found Reset in IDLE state or when <i>activate_search</i> is de-asserted. Asserted when the preamble is found and the coarse symbol timing is determined. If the subsequent AA/SFD search fails and the receiver resumes CTS, this signal will be reset. |

45.2.2.7 XCVR_ZBDEMOM Register Descriptions

45.2.2.7.1 XCVR_ZBDEMOM_ADDR Memory Map

Base address: 4005C480h

| Offset | Register | Width (In bits) | Access | Reset value |
|-----------|--|--------------------|--------|------------------|
| 4005C480h | 802.15.4 DEMOD CORRELLATOR CONTROL (CORR_CTRL) | 32 | RW | See description. |
| 4005C484h | 802.15.4 DEMOD PN TYPE (PN_TYPE) | 32 | RW | 0000001h |
| 4005C488h | 802.15.4 DEMOD PN CODE (PN_CODE) | 32 | RW | 744AC39Bh |
| 4005C48Ch | 802.15.4 DEMOD SYMBOL SYNC CONTROL (SYNC_CTRL) | 32 | RW | 00000008h |
| 4005C490h | 802.15.4 CCA/LQI SOURCE (CCA_LQI_SRC) | 32 | RW | 00000004h |
| 4005C494h | FAD CORRELATOR THRESHOLD (FAD_THR) | 32 | RW | 00000082h |
| 4005C498h | 802.15.4 AFC STATUS (ZBDEM_AFC) | 32 | RW | See description. |

45.2.2.7.2 802.15.4 DEMOD CORRELLATOR CONTROL (CORR_CTRL)

45.2.2.7.2.1 Address

| Register | Offset |
|-----------|-----------|
| CORR_CTRL | 4005C480h |

45.2.2.7.2.2 Diagram

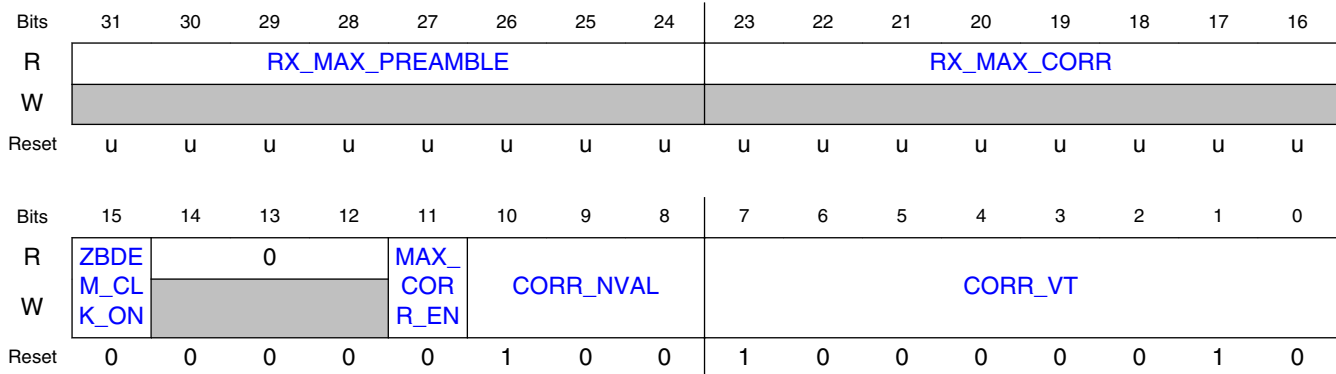

45.2.2.7.2.3 Fields

| Field | Function |
|--------------------------|--|
| 31-24 RX_MAX_PREAMBLE | RX_MAX_PREAMBLE Max correlator during preamble-- max correlator value found during the preamble. |
| 23-16 RX_MAX_CORR | RX_MAX_CORR Max correlator after preamble-- max correlator value found in packet after the preamble (refreshed every symbol rate if MAX_CORR_EN=1). |
| 15 ZBDEM_CLK_ON | Force 802.15.4 Demodulator Clock On 0b - Normal Operation 1b - Force 802.15.4 Demodulator Clock On (debug purposes only) |
| 14-12 — | Reserved |
| 11 MAX_CORR_EN | MAX_CORR_EN Max correlator after preamble enable-- Enable the refresh of the max corr register |
| 10-8 CORR_NVAL | CORR_NVAL Number of consecutively detected zero-symbols required to declare a preamble detected |
| 7-0 CORR_VT | CORR_VT Correlator threshold, defines the sensitivity of demod during the preamble search state |

45.2.2.7.3 802.15.4 DEMOD PN TYPE (PN_TYPE)

45.2.2.7.3.1 Address

| Register | Offset |
|----------|-----------|
| PN_TYPE | 4005C484h |

45.2.2.7.3.2 Diagram

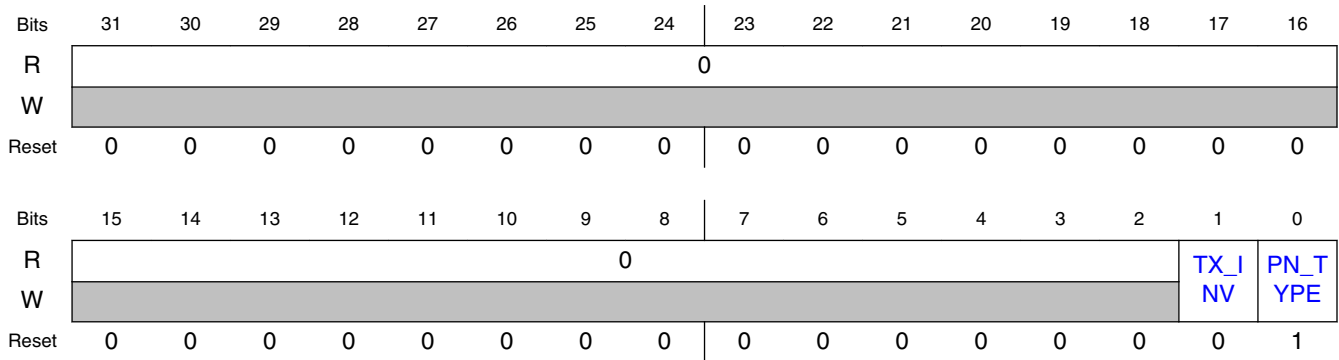

45.2.2.7.3.3 Fields

| Field | Function |
|------------------|---|
| 31-2 Reserved | Reserved |
| 1 TX_INV | TX_INV test mode to invert the transmission |
| 0 PN_TYPE | PN_TYPE PN Type - Pseudo Noise Chip Code Type (802.15.4=1) |

45.2.2.7.4 802.15.4 DEMOD PN CODE (PN_CODE)

45.2.2.7.4.1 Address

| Register | Offset |
|----------|-----------|
| PN_CODE | 4005C488h |

45.2.2.7.4.2 Function

Pseudo Noise Chip Code Seed Value

45.2.2.7.4.3 Diagram

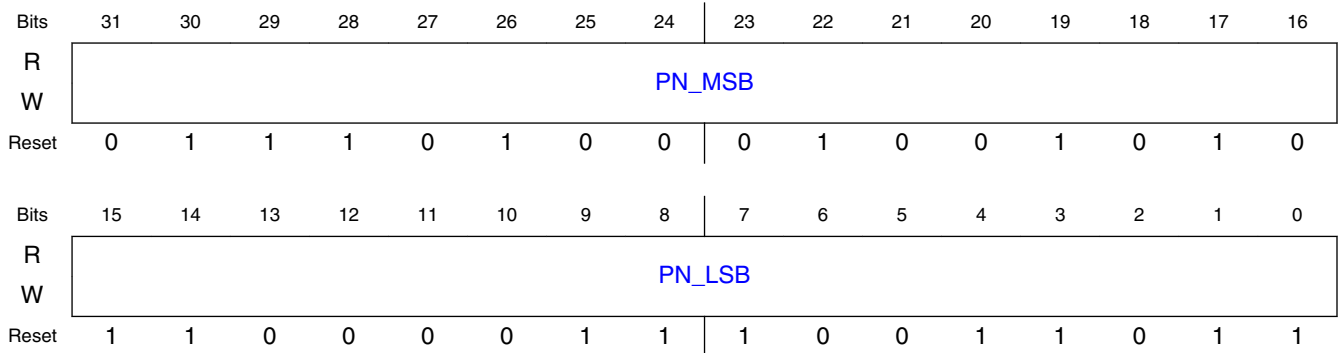

45.2.2.7.4.4 Fields

| Field | Function |
|-----------------|---------------------------|
| 31-16 PN_MSB | PN_MSB PN_CODE MS half |
| 15-0 PN_LSB | PN_LSB PN_CODE LS half |

45.2.2.7.5 802.15.4 DEMOD SYMBOL SYNC CONTROL (SYNC_CTRL)

45.2.2.7.5.1 Address

| Register | Offset |
|-----------|-----------|
| SYNC_CTRL | 4005C48Ch |

45.2.2.7.5.2 Diagram

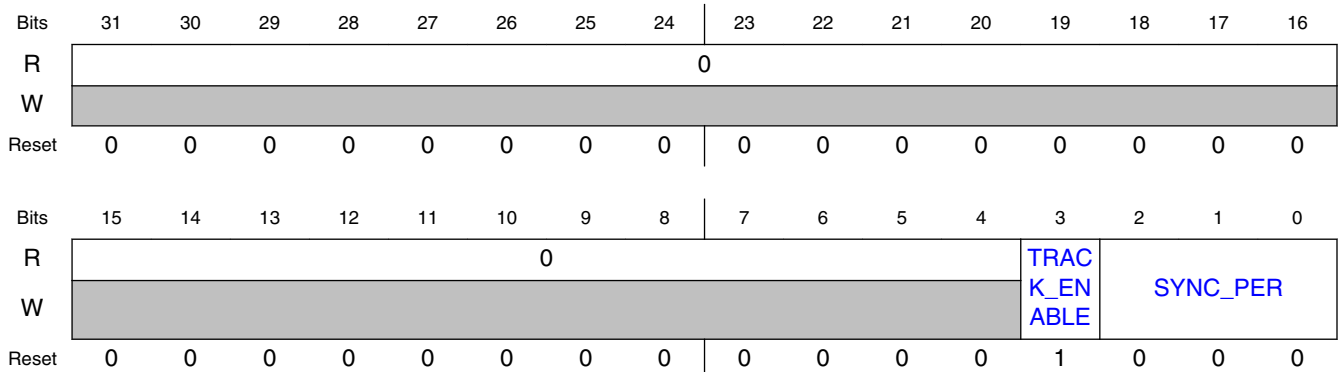

45.2.2.7.5.3 Fields

| Field | Function |
|-------------------|---|
| 31-4 Reserved | Reserved |
| 3 TRACK_ENABLE | TRACK_ENABLE 0b - symbol timing synchronization tracking disabled in Rx frontend 1b - symbol timing synchronization tracking enabled in Rx frontend (default) |
| 2-0 SYNC_PER | Symbol Sync Tracking Period determines update rate for symbol timing, per equation. An early/late measurement is made every $2^{\text{SYNC_PER}[2:0]}$ symbols. Valid range of SYNC_PER[2:0] is 0 to 4. |

45.2.2.7.6 802.15.4 CCA/LQI SOURCE (CCA_LQI_SRC)

45.2.2.7.6.1 Address

| Register | Offset |
|-------------|-----------|
| CCA_LQI_SRC | 4005C490h |

45.2.2.7.6.2 Function

Selects the Source of CCA and LQI Information Provided to the 802.15.4 Link Layer

45.2.2.7.6.3 Diagram

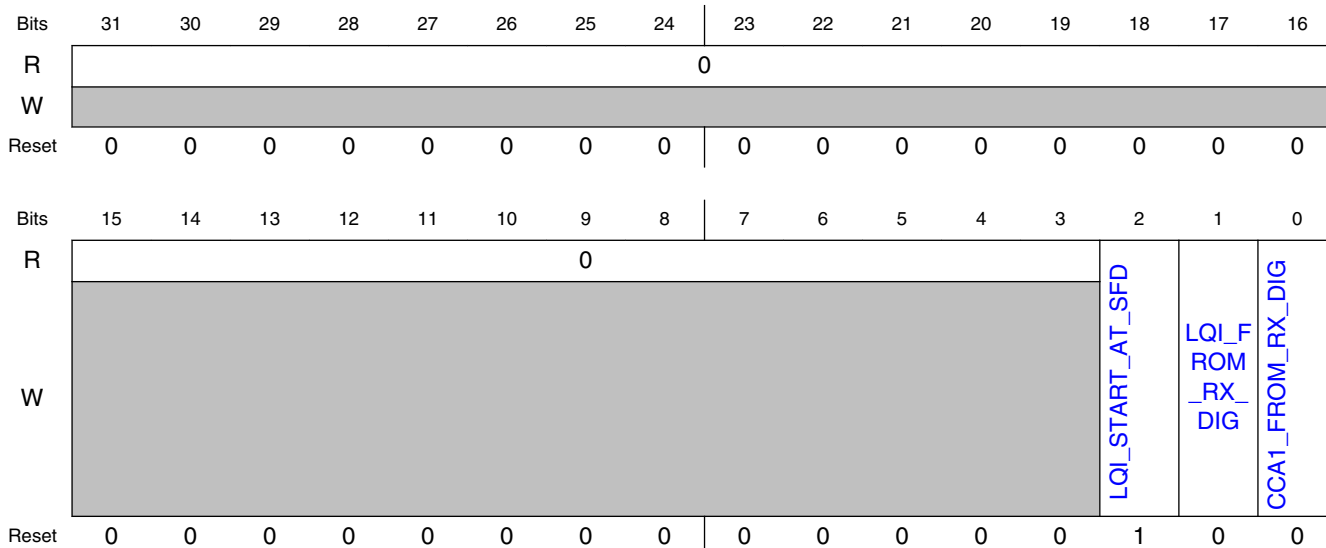

45.2.2.7.6.4 Fields

| Field | Function |
|-----------------------|---|
| 31-3 Reserved | Reserved |
| 2 LQI_START_AT_SFD | Select Start Point for LQI Computation 0b - Start LQI computation at Preamble Detection (similar to previous Freescale 802.15.4 products) 1b - Start LQI computation at SFD (Start of Frame Delimiter) Detection |
| 1 LQI_FROM_RX_DIG | Selects the Source of LQI (Link Quality Indicator) Information Provided to the 802.15.4 Link Layer 0b - Use the LQI information computed internally in the 802.15.4 Demod 1b - Use the LQI information computed by the RX Digital |
| 0 CCA1_FROM_RX_DIG | Selects the Source of CCA1 (Clear Channel Assessment Mode 1) Information Provided to the 802.15.4 Link Layer 0b - Use the CCA1 information computed internally in the 802.15.4 Demod 1b - Use the CCA1 information computed by the RX Digital |

45.2.2.7.7 FAD CORRELATOR THRESHOLD (FAD_THR)

45.2.2.7.7.1 Address

| Register | Offset |
|----------|-----------|
| FAD_THR | 4005C494h |

45.2.2.7.7.2 Diagram

| | | | | | | | | | | | | | | | | |
|-------|----|----|----|----|----|----|----|----|---------|----|----|----|----|----|----|----|
| Bits | 31 | 30 | 29 | 28 | 27 | 26 | 25 | 24 | 23 | 22 | 21 | 20 | 19 | 18 | 17 | 16 |
| R | 0 | | | | | | | | | | | | | | | |
| W | | | | | | | | | | | | | | | | |
| Reset | 0 | 0 | 0 | 0 | 0 | 0 | 0 | 0 | 0 | 0 | 0 | 0 | 0 | 0 | 0 | 0 |
| Bits | 15 | 14 | 13 | 12 | 11 | 10 | 9 | 8 | 7 | 6 | 5 | 4 | 3 | 2 | 1 | 0 |
| R | 0 | | | | | | | | FAD_THR | | | | | | | |
| W | | | | | | | | | | | | | | | | |
| Reset | 0 | 0 | 0 | 0 | 0 | 0 | 0 | 0 | 1 | 0 | 0 | 0 | 0 | 0 | 1 | 0 |

45.2.2.7.7.3 Fields

| Field | Function |
|-------|----------|
| 31-8 | Reserved |

Table continues on the next page...

Radio Register Overview

| Field | Function |
|----------------|---|
| Reserved | |
| 7-0 FAD_THR | FAD_THR Correlator threshold at which the FAD will select the antenna. |

45.2.2.7.8 802.15.4 AFC STATUS (ZBDEM_AFC)

45.2.2.7.8.1 Address

| Register | Offset |
|-----------|-----------|
| ZBDEM_AFC | 4005C498h |

45.2.2.7.8.2 Diagram

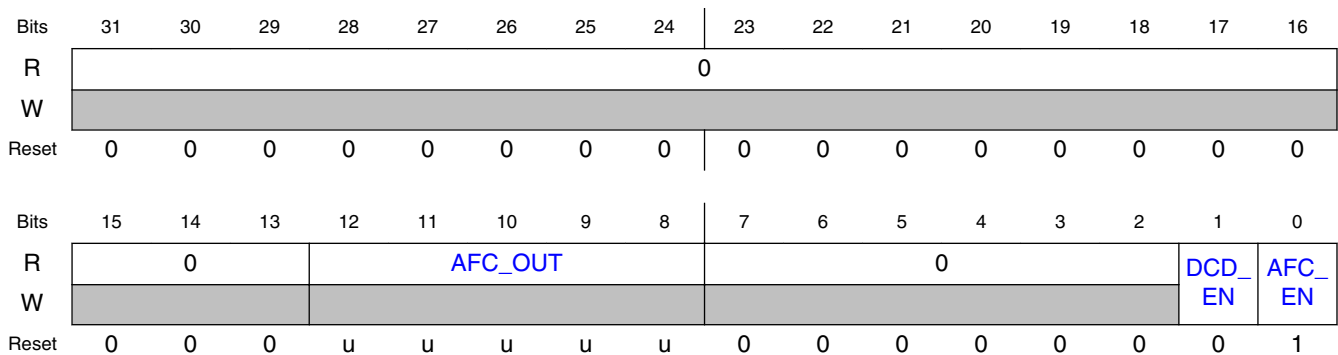

45.2.2.7.8.3 Fields

| Field | Function |
|-------------------|--|
| 31-13 Reserved | Reserved |
| 12-8 AFC_OUT | AFC_OUT AFC Result from the last received packet. Format is Signed, Two's Complement. Each LSB represents 15KHz of Frequency Offset |
| 7-2 — | Reserved |
| 1 DCD_EN | DCD_EN 0b - NCD Mode (default) 1b - DCD Mode |
| 0 | AFC_EN |

| Field | Function |
|--------|---|
| AFC_EN | the AFC Function 0b - AFC is disabled 1b - AFC is enabled |

45.2.3 Link Layer Memory Map and Register Definition

The Link Layer memory map and description of registers are included in the following register section.

45.2.3.1 BLE Register Descriptions

45.2.3.1.1 Platform Registers

Platform Register Descriptions for the Bluetooth Link Layer

Instruction Register

| Addr 16-bit | Addr 32-bit | Register Name | RW | Description | Reset |
|----------------|----------------|------------------|----|--|--------|
| 0x00 | 0x000 | COMMAND_REGISTER | WO | Instructions register to send commands to link layer hardware for controlling hardware operations. | 0xXX00 |

| Field | Bit | Description | Reset |
|-----------------|-------|--|-------|
| Reserved | 15:10 | Not used | XX |
| conn_index[1:0] | 9:8 | Connection index to specify the command is for which connection engine. | 0 |
| command | 7:0 | 8-bit command from firmware to the link layer controller. See Instruction Set for the list of instructions and their opcodes. The instruction results in the link layer hardware starting/stopping an operation. | 00 |

Radio Register Overview

| Field | Bit | Description | Reset |
|-------|-----|--|-------|
| | | <p><u>Notes on use</u></p> <p>1. Few of the commands will require other configuration registers to be set, before the command is written. Refer to Instruction Set for details of the registers to be set before setting these instructions.</p> | |

Event clear Register

| Addr 16-bit | Addr 32-bit | Register Name | RW | Description | Reset |
|----------------|----------------|---------------|----|--|--------|
| 0x04 | 0x008 | EVENT_CLEAR | WO | <p>Clears the source of the interrupt. This register is written by firmware to clear interrupts set in the EVENT_STATUS register.</p> <p>One or more interrupts can be cleared in a single write operation, by writing a 1 at the bit fields specific to the interrupts being cleared. It is not required to write a follow-up write with zero as the previous write is not actually stored.</p> | 0x0000 |

| Field | Bit | Description | Reset |
|--------------|------|--|-------|
| Reserved | 15:6 | Not used. | XX |
| Dsm_intr_clr | 5 | Clear deep sleep mode exit interrupt. Write to the register with this bit set to 1, clears the interrupt source. | |
| Sm_intr_clr | 4 | Clear sleep-mode-exit interrupt. Write to the register with this bit set to 1, clears the interrupt source. | |
| Reserved | 3:0 | Not used. | |

Event status register

| Addr 16-bit | Addr 32-bit | Register Name | RW | Description | Reset |
|----------------|----------------|---------------|----|--|--------|
| 0x04 | 0x008 | EVENT_STATUS | RO | Event (Interrupt) status. Indicates pending events which require servicing by firmware. Each of the status bits is set by the link layer hardware. The bits are set till they are cleared by firmware by writing to appropriate event clear registers. | 0x0000 |

| Field | Bit | Description | Reset |
|-----------|------|---|-------|
| Reserved | 15:6 | Not used. | XX |
| Dsm_intr | 5 | Deep sleep mode exit interrupt. This bit is set, when link layer hardware exits from deep sleep mode. The bit is cleared when firmware writes to EVENT_CLEAR register with this bit position set to 1. | 0 |
| Sm_intr | 4 | Sleep-mode-exit interrupt. This bit is set, when link layer hardware exits from sleep mode. The bit is cleared when firmware writes to EVENT_CLEAR register with this bit position set to 1. | 0 |
| Conn_intr | 3 | Connection interrupt. If bit is set to 1, it indicates an event occurred in the connection operation. This interrupt is aggregation of interrupts for all the connections. The source of the event for the specific connection needs to be read from the CONN_INTR_STATUS register specific to the connection. This bit is cleared, when firmware clears ALL interrupts by writing to the CONN_INTR_CLEAR register. | 0 |

Table continues on the next page...

Radio Register Overview

| | | | |
|-----------|---|---|---|
| Init_intr | 2 | Initiator interrupt. If bit is set to 1, it indicates an event occurred in the initiating procedure. The source of the event needs to be read from the INIT_STATUS register. This bit is cleared, when firmware clears ALL interrupts by writing to the INIT_INTR_CLEAR register. | 0 |
| Scan_intr | 1 | Scanner interrupt. If bit is set to 1, it indicates an event occurred in the scanning procedure. The source of the event needs to be read from the SCAN_STATUS register. This bit is cleared, when firmware clears ALL interrupts by writing to the SCAN_INTR_CLEAR register. | 0 |
| Adv_intr | 0 | Advertiser interrupt. If bit is set to 1, it indicates an event occurred in the advertising procedure. The source of the event needs to be read from the ADV_STATUS register. This bit is cleared, when firmware clears ALL interrupts by writing to the ADV_INTR_CLEAR register. | 0 |

Event enable register

| Addr 16-bit | Addr 32-bit | Register Name | RW | Description | Reset |
|----------------|----------------|---------------|----|---|--------|
| 0x08 | 0x010 | EVENT_ENABLE | RW | Event indications enable. The register enables/masks each of the possible event sources from causing an interrupt. The bit fields mask only the events from interrupting the firmware. However hardware can still generate the interrupt. Firmware, when detects one interrupt, can mask all the interrupts temporarily, by clearing the register | 0x0000 |

| Addr 16-bit | Addr 32-bit | Register Name | RW | Description | Reset |
|----------------|----------------|---------------|----|---|-------|
| | | | | value to 0x0000. The interrupts can be masked till the first interrupt is processed and enable the interrupts back. This ensures no new interrupts is missed while firmware is processing one. | |

| Field | Bit | Description | Reset |
|-------------|------|---|-------|
| Reserved | 15:6 | Not used. | XX |
| Dsm_int_en | 5 | Deep Sleep-mode-exit interrupt enable. 1 – enable deep sleep mode exit event to interrupt the firmware. 0 – disable deep sleep mode exit interrupt to firmware. | 0 |
| Sm_int_en | 4 | Sleep-mode-exit interrupt enable. 1 – enable sleep mode exit event to interrupt the firmware. 0 – disable sleep mode exit interrupt to firmware. | 0 |
| Conn_int_en | 3 | Connection interrupt enable. 1 – enable connection procedure to interrupt the firmware. 0 – disable connection procedure interrupt to firmware. | 0 |
| Init_int_en | 2 | Initiator interrupt enable. 1 – enable initiator procedure to interrupt the firmware. 0 – disable initiator procedure interrupt to firmware. | 0 |
| Scn_int_en | 1 | Scanner interrupt enable. 1 – enable scan procedure to interrupt the firmware. | 0 |

Table continues on the next page...

Radio Register Overview

| Field | Bit | Description | Reset |
|------------|-----|---|-------|
| | | 0 – disable scan procedure interrupt to firmware. | |
| Adv_int_en | 0 | Advertiser interrupt enable. 1 – enable advertiser procedure to interrupt the firmware. 0 – disable advertiser procedure interrupt to firmware. | 0 |

Wakeup Configuration register

| Addr 16-bit | Addr 32-bit | Register Name | RW | Description | Reset |
|----------------|----------------|---------------|----|---|--------|
| 0x5C | 0x0B8 | WAKEUP_CONFIG | RW | Wakeup configuration to configure the various offsets while waking up from sleep mode or deep sleep mode. | 0x0000 |

| Field | Bit | Description | Reset |
|------------------------------|-------|--|-------|
| Dsm_offset_to_wakeup_instant | 15:10 | Number of “slots” before the wake up instant before which the hardware needs to exit from deep sleep mode. The slot is of 625 us period. This is a one-time configuration field, which is used every time hardware does an auto-wakeup before the next wakeup instant. | 0 |
| Sm_offset_to_wakeup_instant | 9 | Number of “slots” (1slot = 625 microseconds) before the wake up instant before which the hardware needs to exit from sleep mode. This is a onetime configuration field, which is used every time hardware does an auto-wakeup before the next wakeup instant. | 0 |
| Retain_in_dsm2 | 8 | “1” indicates Connection RAM to be retained during DSM2. | 0 |
| Osc_startup_delay | 7:0 | Oscillator stabilization/startup delay. This is in X.Y format where X is in terms of number | 00 |

| Field | Bit | Description | Reset |
|-------|-----|--|-------|
| | | <p>of BT slots (625 us) and Y is in terms of number of clock periods of 16KHz clock input, required for RF oscillator to stabilize the clock output to the controller on its output pin, after oscillator is turned ON. In this period the clock is assumed to be unstable, and so the controller does not turn on the clock to internal logic till this period is over. This means, the wake up from deep sleep mode must account for this delay before the wakeup instant.</p> <p>Osc_startup_delay[7:5] is number of slots(625 us)</p> <p>Osc_startup_delay[4:0] is number of clock periods of 16KHz clock</p> <p>(Warning: Min. value of Osc_startup_delay [4:0] supported is 1 and Max. value is 9. Therefore programmable range is 1 to 9)</p> | |

NOTE

In case of firm ware DSM exit mode: Exit from DSM shall be in synchronization with ref_clk (625 us slots timing) and shall not come out of DSM mode before meeting the oscillator start up delay. It is expected to have 0 to 625 us extra delay to wake-up from DSM, depends upon the assertion of the dsm_exit signal (firmware exit).

Sleep Threshold register

| Addr 16-bit | Addr 32-bit | Register Name | RW | Description | Reset |
|----------------|----------------|-----------------|----|--|--------|
| 0x5E | 0x0BC | SLEEP_THRESHOLD | RW | Sleep Threshold register. Stores threshold values for entering sleep mode or deep sleep mode. The threshold values | 0x0000 |

Radio Register Overview

| Addr 16-bit | Addr 32-bit | Register Name | RW | Description | Reset |
|----------------|----------------|---------------|----|---|-------|
| | | | | are compared with the inactivity period to determine entry into one of the modes. | |

| Field | Bit | Description | Reset |
|---------------------|-------|---|-------|
| Sm_threshold[3:0] | 15:12 | Number of inactive “slots” above which the device can enter sleep mode. If the number of slots is below this threshold, then device will not enter sleep mode. | 0 |
| Dsm_threshold[11:0] | 11:0 | Number of inactive “slots” above which the device can enter sleep mode. If the number of slots is below this threshold, then device will not enter deep sleep mode. | 0 |

NOTE

Typically $dsm_threshold > sm_threshold$ value. This means the following behavior is expected

| No. of inactive slots(N) | Behaviour |
|--------------------------------------|-----------------|
| $N < sm_threshold$ | No power save |
| $Sm_threshold < N < dsm_threshold$ | Sleep Mode |
| $N > dsm_threshold$ | Deep sleep mode |

Wakeup control register

| Addr 16-bit | Addr 32-bit | Register Name | RW | Description | Reset |
|----------------|----------------|--------------------|----|---|--------|
| 0x60 | 0x0C0 | WAKEUP_CONTR OL | RW | Wakeup instant register. Program the 16-bit reference clock value for auto-wakeup from deep sleep mode. | 0x0000 |

| Field | Bit | Description | Reset |
|----------------------|------|--|-------|
| Wakeup_instant[15:0] | 15:0 | Instant, with reference to the internal 16-bit clock reference, at which the hardware must wakeup from deep sleep mode. This is calculated by firmware based on the next closest instant where a controller operation is required (like advertiser/scanner). Firmware reads the next instant of the procedures in the corresponding *_NEXT_INSTANT registers. This value is used only when hardware auto wakeup from deep sleep mode is enabled in the clock control register. | 0 |

NOTE

It is recommended to program wakeup_instant such a way that the actual instant to wakeup shall be at least two counts (two slots of 625 us) ahead of reference clock when entering DSM. The actual instant to wakeup is “wakeup_instant – dsm_offset_to_wakeup_instant – osc_startup_delay, and it shall be greater than “reference clock + 2”

Clock control register

| Addr 16-bit | Addr 32-bit | Register Name | RW | Description | Reset |
|----------------|----------------|---------------|----|--|--------|
| 0x62 | 0x0C4 | CLOCK_CONFIG | RW | Clock control and configuration. Controls clock gating and clock switch logic. | 0x0080 |

| Field | Bit | Description | Reset |
|--------------------|-----|--|-------|
| Deep_sleep_mode_en | 15 | Enable deep sleep mode. 1 – enable, 0 – disable. Enables hardware logic related to deep sleep mode to control the deep sleep mode operation. If disabled, the | 0 |

Table continues on the next page...

Radio Register Overview

| Field | Bit | Description | Reset |
|-------------------|-----|---|-------|
| | | related logic is not executed and hardware cannot enter deep sleep mode. | |
| Sleep_mode_en | 14 | Enable sleep mode. 1 – enable, 0 – disable. Enables hardware to control sleep mode operation. | 0 |
| Dsm_intr_en | 13 | Enable DSM exit interrupt. 1 – enable, 0 – disable. Enables hardware to generate an interrupt while exiting deep sleep mode. When enabled, interrupt is generated independent of whether exit procedure is initiated by hardware or firmware. | 0 |
| sm_intr_en | 12 | Enable SM exit interrupt. 1 – enable, 0 – disable. Enables hardware to generate an interrupt while exiting sleep mode – irrespective of whether it is initiated by hardware or firmware. The interrupt is captured and stored till it gets cleared. Disabling this bit mask the sleep mode exit event from hardware & firmware. | 0 |
| Dsm_auto_sleep_en | 11 | Enable deep sleep mode auto entry in hardware. 1 – enable hardware to enter DSM automatically 0 – disable hardware to enter DSM automatically. | 0 |
| Sm_auto_wkup_en | 10 | Enable sleep mode auto wakeup enable. 1- enable, 0 – disable. Enables hardware to automatically wakeup from sleep mode at the instant = <i>wakeup_instant</i> – <i>sm_offset_to_wakeup_instant</i> . The <i>wakeup_instant</i> is the field in the <i>wakeup control register</i> described earlier. The <i>sm_offset_to_wakeup_instant</i> value is the field described in the <i>wakeup configuration register</i> . | 0 |
| Lpo_sel_external | 9 | Select external sleep clock. 1 – External clock, 0 - internal generated clock. | 0 |

Table continues on the next page...

| Field | Bit | Description | Reset |
|-------------------------------|-----|---|-------|
| | | The field is used to select either the low power clock input on sleep_clk input pin(of frequency 16.384KHz) directly to run the DSM logic or to use the internal generated reference clock(of 16KHz) for the same. | |
| Lpo_clk_freq_sel | 8 | Clock frequency select. 0 – 32 kHz, 1 – 32.768 kHz. Base frequency of the sleep_clk input used for generating the internal reference clock of approximate 16 khz frequency. | 0 |
| LLH_idle (READ ONLY field) | 7 | Indicates if hardware is doing any transmit/receive operation or there is a pending interrupt from hardware. This information is used by firmware to decide to program the hardware into deep sleep mode. 1 – LL hardware is idle. 0 – LL hardware is busy. In this case LL hardware will not enter deep sleep mode, even if firmware gives an enter DSM command. (In this situation hardware generates dsm exit interrupt to inform firmware that DSM entry was not successful). | 1 |
| Reserved | 6 | Not used | |
| Sysclk_gate_en | 5 | Sysclk gate enable. 1- enable, 0 – disable. Enables clock gating of system clock input to the link layer. If 1, it enables the DSM logic to control the clock gate for system clock input from pin. If 0, the DSM logic has no control and the system clock is always ON. | 0 |
| Coreclk_gate_en | 4 | Core clock gate enable. 1 – enable, 0 – disable. Enables gating of clock to the llh_core module in hardware. If 1, the sleep mode/deep sleep mode logic can control the clock gate to shutdown/ wakeup the clock to the | 0 |

Table continues on the next page...

Radio Register Overview

| Field | Bit | Description | Reset |
|------------------|-----|---|-------|
| | | module. If 0, the logic has no control and clock is always turned ON. | |
| Conn_clk_gate_en | 3 | <p>Connection block clock gate enable. 1 – enable, 0 – disable.</p> <p>Enables gating of clock to the connection module (llh_connch_top) in hardware. If 1, the sleep mode logic can control the clock gate to shutdown/wakeup the clock to the engine. If 0, the logic has no control and clock to the module is always turned ON.</p> | 0 |
| Init_clk_gate_en | 2 | <p>Initiator block clock gate enable. 1 – enable, 0 – disable.</p> <p>Enables gating of clock to the initiator module (llh_init). If 1, the sleep mode logic can control the clock gate to shutdown/wakeup the clock to the module. If 0, the logic has no control and clock to the module is always turned ON.</p> | 0 |
| Scan_clk_gate_en | 1 | <p>Scan block clock gate enable. 1 – enable, 0 – disable.</p> <p>Enables gating of clock to the scanner module (llh_scan) in hardware. If 1, the sleep mode logic can control the clock gate to shutdown/wakeup the clock to the module. If 0, the logic has no control and clock to the module is always turned ON.</p> | 0 |
| Adv_clk_gate_en | 0 | <p>Advertiser block clock gate enable. 1 – enable, 0 – disable.</p> <p>Enables gating of clock to the advertiser module (llh_adv) in hardware. If 1, the sleep mode logic can control the clock gate to shutdown/wakeup the clock to the module. If 0, the logic has no control and clock to the module is always turned ON.</p> | 0 |

Reference Clock register

| Addr 16-bit | Addr 32-bit | Register Name | RW | Description | Reset |
|----------------|----------------|---------------|----|--|--------|
| 0x64 | 0x0C8 | TIM_COUNTER_L | RO | 16-bit reference clock used for timing reference in the operation of the hardware. | 0x0000 |

| Field | Bit | Description | Reset |
|-------------|------|--|-------|
| Clock[15:0] | 15:0 | 16-bit internal reference clock. The clock is a free running clock, incremented by a 625 us periodic pulse. It is used as a reference clock to derive all the timing required as per protocol. | 0000 |

BLE Time Control

| Addr 16-bit | Addr 32-bit | Register Name | RW | Description | Reset |
|----------------|----------------|---------------|----|------------------------------------|--------|
| 0X6C | 0XD8 | TIME_CONTROL | WO | LLH clock frequency configuration. | 0x0000 |

| Field | Bit | Description | Reset |
|---------------------|------|--|-------|
| RFU | 15:8 | Not used | 0x0 |
| bb_clk_freq_minus_1 | 7:3 | The frequency information (FREQ – 1) of the clock input to LL Hardware is configured in this register by the firmware during initialization. This information is used inside LL Hardware to derive timing information for the Bluetooth operations. For example, if the frequency of the input clock is 12 MHz this field shall be programmed to 0xB. (1 less than frequency) | 0x0 |
| RFU | 2:0 | Not used | 0x0 |

DSM configuration register

Radio Register Overview

| Addr 16-bit | Addr 32-bit | Register Name | RW | Description | Reset |
|----------------|----------------|---------------|----|-----------------------------|--------|
| 0X51A | 0XA34 | DSM_CONFIG | RW | DSM configuration register. | 0x0008 |

| Field | Bit | Description | Reset |
|---------------------------|------|--|-------|
| Not used | 15:9 | Not used | 0x0 |
| enable_conn_clk_ctrl[1:0] | 8:7 | Each bit corresponds to one connection engine (bit 7 for conn engine 0). Each of the bits if set to '1' will enable LLH to turn on corresponding CONNECTION engine clock on EXIT_SM command from firmware. To use this feature CONNECTION NAP modes shall be enabled in LLH. | 0x0 |
| enable_init_clk_ctrl | 6 | If this bit is set to '1' then LLH will turn on INIT engine clock on EXIT_SM command from firmware. To use this feature INIT NAP modes shall be enabled in LLH. | 0x0 |
| enable_scan_clk_ctrl | 5 | If this bit is set to '1' then LLH will turn on SCAN engine clock on EXIT_SM command from firmware. To use this feature SACN NAP mode shall be enabled in LLH. | 0x0 |
| enable_adv_clk_ctrl | 4 | If this bit is set to '1' then LLH will turn on ADV engine clock on EXIT_SM command from firmware. To use this feature ADV NAP mode shall be enabled in LLH. | 0x0 |
| enable_eng_clk_ctrl | 3 | Configuration bit for turning off all engine specific clocks after wakeup from SHUTDOWN (after register restore is complete). If this bit is set to '1' then LLH will turn off all engine specific clocks after restore_done. To use this feature all NAP modes shall be enabled in LLH. | 0x1 |
| restore_done_bypass | 2 | Configuration bit for bypassing wait for restore_done signal to exit from RESTORE state. If this bit is set to '1' then power control FSM will move to next state without waiting for restore_done from RESTORE | 0x0 |

Table continues on the next page...

| Field | Bit | Description | Reset |
|-------------------|-----|---|-------|
| | | state and if this bit is set to '0' then power state machine will wait in RESTORE state till restore_done comes. This bit can be effectively used to reduce wakeup time if restore gets completed in one LP clock cycle. | |
| store_done_bypass | 1 | Configuration bit for bypassing wait for store_done signal to enter in to SHUTDOWN. If this bit is set to '1' then power control FSM will move to next state without waiting for store_done from STORE state and if this bit is set to '0' then power state machine will wait in STORE state till store_done comes. This bit can be effectively used to reduce SHUTDOWN entry time if store gets completed in one LP clock cycle. | 0x0 |
| dsm_config | 0 | Configuration bit for DSM SHUTDOWN LLH store and restore control. If this bit is set to '1' then LLH will do the store and restore of its registers on its own during entry and after exit from shutdown. To use this feature DSM SHUTDOWN mode is to be supported and also LLH shall have access to RETENTION RAM. | 0x0 |

NOTE

To enable dynamic power saving through selective clock gating of different engines LL firmware will set the configuration bits corresponding to BT procedures which are active. This will ensure that clocks to only active blocks are enabled during EXIT_SM command from LL firmware to LL hardware. User can over-ride this mode by setting the bits.

Nearest Instant register

Radio Register Overview

| Addr 16-bit | Addr 32-bit | Register Name | RW | Description | Reset |
|----------------|----------------|---------------|----|--|--------|
| 0X520 | 0XA40 | NEAREST_INST | RO | This register reports the next immediate instant in terms of bt_clock value (actual value being reported is INSTANT – 3) where hardware has any scheduled BT activity. Firmware reads this register along with the TIM_COUNTER_L register to calculate the possibility of power save mode entry. | 0x0000 |

| Field | Bit | Description | Reset |
|------------------------|------|---|--------|
| global_nearest_instant | 15:0 | This field holds the immediate future value of BT_CLOCK where a scheduled Bluetooth activity is supposed to happen. When no Bluetooth activity is running the register will hold current BT_CLOCK value – 3. | 0x0000 |

45.2.3.1.2 Advertising Channel Registers

Advertising Channel Register Descriptions for the Bluetooth Link Layer

Advertising parameters register

| Addr 16-bit | Addr 32-bit | Register Name | RW | Description | Reset |
|----------------|----------------|---------------|----|--|--------|
| 0x0C | 0x018 | ADV_PARAMS | RW | Advertising parameters register. Firmware sets the necessary parameters for the advertising procedure into this register before issuing start advertise command. The | 0x00E0 |

| Addr 16-bit | Addr 32-bit | Register Name | RW | Description | Reset |
|----------------|----------------|---------------|----|--|-------|
| | | | | fields in this register correspond to the fields in the LE_Set_Advertising_Parameters HCI command. | |

| Field | Bit | Description | Reset |
|---------------------------------------|-------|--|-------|
| peer_rx_txaddr (Read Only) | 15 | Transmit address field of the received packet indicating the peer address type as public/random. This field is used by firmware to report peer_addr_type parameter in the connection complete event. 0 – addr type is public. 1 – addr type is random. | 0 |
| peer_addr_resolved_reg (Read Only) | 14 | Address resolution status of the received packet if the received address was RPA. 0 – RPA resolution fail 1 – RPA resolution pass. Else this bit is set to zero. | 0 |
| Reserved | 13 | Not used | |
| slv_index | 12:11 | Slave index is programmed by FW before initiation procedure for selecting connection engine in slave role connection. Number of supported engines is 2. (Index from 0x0 to 0x1) | 0 |
| adv_low_duty_cycle | 10 | This bit field is used to specify to the Controller the Low Duty Cycle connectable directed advertising variant being used. 1 – Low Duty Cycle Connectable Directed Advertising. 0 – High Duty Cycle Connectable Directed Advertising. | 0 |
| Force_scan_rsp (Write Only) | 9 | Force scan response packet always. <i>Used only if TESTER build is enabled.</i> | 0 |

Table continues on the next page...

Radio Register Overview

| Field | Bit | Description | Reset |
|-----------------|-----|---|-------|
| | | <p>1 – Override ADV packet type and send scan response packet type in the header field in all ADV packets</p> <p>0 – no effect.</p> | |
| Rx_addr | 8 | <p>Peer addresses type. This is the Direct_Address_type field programmed, only if ADV_DIRECT_IND type is sent.</p> <p>1 – Rxaddr type is random.</p> <p>0 – Rxaddr type is public.</p> | 0 |
| Adv_channel_map | 7:5 | <p>Advertising channel map indicates the advertising channels used for advertising. By setting the bit, corresponding channel is enabled for use. At least one channel bit should be set.</p> <p>Bit 7- enable channel 39.</p> <p>Bit 6 - enable channel 38.</p> <p>Bit 5 - enable channel 37.</p> | 7 |
| Adv_filt_policy | 4:3 | <p>Advertising filter policy. The set of devices that the advertising procedure uses for device filtering is called the White List .</p> <p>0x00 – Allow scan request from any device, allow connect request from any device.</p> <p>0x01– Allow scan request from devices in white list only, allow connect request from any device.</p> <p>0x10 – Allow scan request from any device, allow connect request from devices in white list only.</p> <p>0x11 – Allow scan request from devices in white list only, allow connect request from devices in white list only.</p> | 0 |
| Adv_type | 2:1 | <p>The Advertising type is used to determine the packet type that is used for advertising when advertising is enabled.</p> <p>00b – Connectable undirected advertising. (adv_ind)</p> | 0 |

Table continues on the next page...

| Field | Bit | Description | Reset |
|----------|-----|---|-------|
| | | 01b – Connectable directed advertising (adv_direct_ind). 10b – Discoverable undirected advertising (adv_discover_ind) 11b – Non connectable undirected advertising (adv_nonconn_ind). | |
| Reserved | 0 | Reserved for future use. | 0 |

Advertising Interval register

| Addr 16-bit | Addr 32-bit | Register Name | RW | Description | Reset |
|----------------|----------------|----------------------|----|--|--------|
| 0x0E | 0x01C | ADV_INTERVAL_TIMEOUT | RW | Advertising interval register. It is the interval between two consecutive advertising events. For directed advertising, this register holds the timeout value. Has a resolution of 625 us. Time = N * 625 us Time Range: 20 ms to 10.24 s. Firmware updates this value before issuing start advertise command. | 0x0020 |

| Field | Bit | Description | Reset |
|--------------|------|---|--------|
| Adv_interval | 15:0 | Range: 0x0020 to 0x4000 (For ADV_IND) 0x00A0 to 0x4000 (For ADV_SCAN_IND and NONCONN_IND) For directed advertising, firmware programs the default value of 1.28 s. | 0x0010 |

Advertising interrupt clear register

| Addr 16-bit | Addr 32-bit | Register Name | RW | Description | Reset |
|----------------|----------------|----------------|----|--|--------|
| 0x10 | 0x020 | ADV_INTR_CLEAR | WO | Clears the source of the interrupt. This register is written by firmware to clear interrupts set in the ADV_STATUS register. One or more interrupts can be cleared in a single write operation, by setting the bit field to 1 for corresponding interrupt. It is not required to write a follow-up write with bit 0, as the previous bit 1 is not actually stored. | 0x0000 |

| Field | Bit | Description | Reset |
|------------------|------|---|-------|
| Reserved | 15:8 | Not used. | XX |
| adv_timeout | 7 | Clear adv_timeout interrupt. Applicable in ADV_DIRECT_IND advertising. Write to the register with this bit set to 1, clears the interrupt source. | 0 |
| slv_connected | 6 | Clear slave connected interrupt. Write to the register with this bit set to 1, clears the interrupt source. | 0 |
| conn_req_rx_intr | 5 | Clear connect request packet received interrupt. Write to the register with this bit set to 1, clears the interrupt source | 0 |
| scan_req_rx_intr | 4 | Clear scan request packet received interrupt. Write to the register with this bit set to 1, clears the interrupt source | 0 |
| scn_rsp_tx_intr | 3 | Clear scan response packet transmitted interrupt. Write to the register with this bit set to 1, clears the interrupt source | 0 |

Table continues on the next page...

| Field | Bit | Description | Reset |
|----------------|-----|--|-------|
| adv_tx_intr | 2 | Clear adv packet transmitted interrupt. Write to the register with this bit set to 1, clears the interrupt source | 0 |
| adv_close_intr | 1 | Clear advertising event stop interrupt. Write to the register with this bit set to 1, clears the interrupt source | 0 |
| adv_strt_intr | 0 | Clear advertising event start interrupt. Write to the register with this bit set to 1, clears the interrupt source | 0 |

Advertising status register

| Addr 16-bit | Addr 32-bit | Register Name | RW | Description | Reset |
|----------------|----------------|---------------|----|--|--------|
| 0x10 | 0x020 | ADV_STATUS | RO | Advertising status register shows the status of the interrupts. Each of the status bits is set by the advertising procedure in hardware. The bits are set till they are cleared by firmware by writing to appropriate interrupt clear registers. | 0x0000 |

| Field | Bit | Description | Reset |
|-------------|------|--|-------|
| Reserved | 15:9 | Not used. | XX |
| Adv_on | 8 | Advertiser procedure is ON in hardware. Indicates that advertiser procedure is ON in hardware. 1 – on 0 – off | 0 |
| adv_timeout | 7 | If this bit is set it indicates that the directed advertising event has timed out after 1.28 s. Applicable in adv_direct_ind advertising only. | 0 |

Table continues on the next page...

Radio Register Overview

| Field | Bit | Description | Reset |
|------------------|-----|--|-------|
| slv_connected | 6 | If this bit is set it indicates that connection is created as slave. | 0 |
| conn_req_rx_intr | 5 | If this bit is set it indicates connect request packet is received. | 0 |
| scan_req_rx_intr | 4 | If this bit is set it indicates scan request packet received. | 0 |
| scn_rsp_tx_intr | 3 | If this bit is set it indicates scan response packet transmitted in response to previous scan request packet received. | 0 |
| adv_tx_intr | 2 | If this bit is set it indicates ADV packet is transmitted. | 0 |
| adv_close_intr | 1 | If this bit is set it indicates current advertising event is closed. | 0 |
| adv_strt_intr | 0 | If this bit is set it indicates a new advertising event started after interval expiry. | 0 |

Advertising next instant register

| Addr 16-bit | Addr 32-bit | Register Name | RW | Description | Reset |
|----------------|----------------|------------------|----|--|--------|
| 0x12 | 0x024 | ADV_NEXT_INSTANT | RO | Shows the instant at which the next advertising event begins. This is with reference to internal reference clock of resolution 625 us. | 0x0000 |

| Field | Bit | Description | Reset |
|------------------|------|---|-------|
| next_adv_instant | 15:0 | Shows the next start of advertising event with reference to the internal reference clock. | 0 |

Scan Interval register

| Addr 16-bit | Addr 32-bit | Register Name | RW | Description | Reset |
|----------------|----------------|---------------|----|---|--------|
| 0x14 | 0x028 | SCAN_INTERVAL | RW | Scan interval register. Interval between two consecutive scanning events. Firmware sets the scanning interval value to this register before issuing start scan command. | 0x0010 |

| Field | Bit | Description | Reset |
|---------------|------|---|--------|
| scan_interval | 15:0 | Interval between two consecutive scanning events. Range: 0x0004 to 0x4000 Default: 0x0010 (10 ms) Time = N * 625 us Time Range: 2.5 ms to 10.24 s . | 0X0010 |

Scan Window register

| Addr 16-bit | Addr 32-bit | Register Name | RW | Description | Reset |
|----------------|----------------|---------------|----|---|--------|
| 0x16 | 0x02C | SCAN_WINDOW | RW | Scan window register. Duration of scan in a scanning event, which should be less than or equal to scan interval value . Firmware sets the scan window value to this register before issuing start scan command. | 0x0010 |

| Field | Bit | Description | Reset |
|-------------|------|--|--------|
| scan_window | 15:0 | Duration of scan in a scanning event, which should be less than or equal to scan interval value. | 0X0010 |

Radio Register Overview

| Field | Bit | Description | Reset |
|-------|-----|--|-------|
| | | Range: 0x0004 to 0x4000 Default: 0x0010 (10 ms) Time = N * 625 us Time Range: 2.5 ms to 10.24 s . | |

Scan parameters register

| Addr 16-bit | Addr 32-bit | Register Name | RW | Description | Reset |
|----------------|----------------|---------------|----|---|--------|
| 0x18 | 0x030 | SCAN_PARAM | RW | Scanning parameters register. Firmware sets the necessary parameters for scanning procedure into this register before issuing start scan command. The fields are derived from the LE_Set_Scan_Parameters HCI command. | 0x0000 |

| Field | Bit | Description | Reset |
|------------------|------|--|-------|
| Reserved | 15:7 | Not used. | XX |
| scan_tx_addr[1] | 6 | MSB of the device's Own address. This bit along with scan_tx_addr[0] decides the own address used for scanner. | 0 |
| Dup_filt_en | 5 | Filter duplicate packets. 1 – Duplicate packet filtering enabled. 0 – Duplicate packet filtering not enabled. This field is derived from the <i>LE_set_scan_enable</i> command. | 0 |
| scan_filt_policy | 4:3 | The scanner filter policy determines how the scanner processes advertising packets . | 0 |

Table continues on the next page...

| Field | Bit | Description | Reset |
|-----------------|-----|--|-------|
| | | <p>0x00 – Accept advertising packets from any device. A connectable Directed advertising packet not containing the scanner's device address is ignored.</p> <p>0x01 – Accept advertising packets from only devices in the whitelist . A connectable Directed advertising packet not containing the scanner's device address is ignored.</p> <p>0x10 – Accept advertising packets from any device. A connectable Directed advertising packet is not ignored if the InitA is a resolvable private address.</p> <p>0x11 – Accept advertising packets from only devices in the whitelist. A connectable Directed advertising packet is not ignored if the InitA is a resolvable private address.</p> <p>Adv_direct_ind packets which are not addressed to this device are ignored.</p> | |
| scan_type | 2:1 | <p>0x00 – passive scanning. (default)</p> <p>0x01 – active scanning.</p> <p>0x10 – RFU</p> <p>0x11 – RFU</p> | 0 |
| scan_tx_addr[0] | 0 | <p>Device's own address type.</p> <p>1 – addr type is random.</p> <p>0 – addr type is public.</p> <p>NOTE: Scan_tx_addr[1:0]</p> <p>0x0 – use public address</p> <p>0x1 – use random address</p> <p>0x2 – use RPA if matching entry is available in Resolving list else use public address.</p> | 0 |

Radio Register Overview

| Field | Bit | Description | Reset |
|-------|-----|---|-------|
| | | 0x3 – use RPA if matching entry is available in Resolving list else use random address. | |

Scan interrupt clear register

| Addr 16-bit | Addr 32-bit | Register Name | RW | Description | Reset |
|----------------|----------------|-----------------|----|--|--------|
| 0x1C | 0x038 | SCAN_INTR_CLEAR | WO | Clears the source of the interrupt. This register is written by firmware to clear interrupts set in the SCAN_STATUS register. One or more interrupts can be cleared in a single write operation. | 0x0000 |

| Field | Bit | Description | Reset |
|------------------|------|--|-------|
| Reserved | 15:5 | Not used. | XX |
| scan_rsp_rx_intr | 4 | Clear scan_rsp packet received interrupt. Write to the register with this bit set to 1, clears the interrupt source. | 0 |
| adv_rx_intr | 3 | Clear adv packet received interrupt. Write to the register with this bit set to 1, clears the interrupt source | 0 |
| scan_tx_intr | 2 | Clear scan request packet transmitted interrupt. Write to the register with this bit set to 1, clears the interrupt source | 0 |
| scan_close_intr | 1 | Clear scan event close interrupt. Write to the register with this bit set to 1, clears the interrupt source | 0 |
| scan_strt_intr | 0 | Clear scan event start interrupt. Write to the register with this bit set to 1, clears the interrupt source | 0 |

Scan status register

| Addr 16-bit | Addr 32-bit | Register Name | RW | Description | Reset |
|----------------|----------------|---------------|----|--|--------|
| 0x1C | 0x038 | SCAN_STATUS | RO | Shows the status of the interrupt. This register is read by firmware to learn the pending scan interrupts that are set and are to be served. | 0x0000 |

| Field | Bit | Description | Reset |
|----------------------|--------------|---|-------|
| Reserved | 15:9 and 7:6 | Not used. | XX |
| scan_on | 8 | Scan procedure is active. 1 – scan procedure is active. 0 – scan procedure is not active. | |
| scan_rsp_adv_rx_intr | 5 | If this bit is set after both SCAN_RSP and ADV packets are received. This interrupt may be enabled, if firmware desires to be interrupted after complete reception, instead of interrupt for each packet – which are enabled by bits 4 and 3. | 0 |
| scan_rsp_rx_intr | 4 | If this bit is set it indicates SCAN_RSP packet is received. Firmware can read the content of the packet from the INIT_SCN_ADV_RX_FIFO. | 0 |
| adv_rx_intr | 3 | If this bit is set it indicates ADV packet received. Firmware can read the content of the packet from the INIT_SCN_ADV_RX_FIFO. | 0 |
| scan_tx_intr | 2 | If this bit is set it indicates scan request packet is transmitted. | 0 |
| scan_close_intr | 1 | If this bit is set it indicates scan window is closed. | 0 |
| scan_strt_intr | 0 | If this bit is set it indicates scan window is opened. | 0 |

NOTE

scan_rsp_adv_rx_intr — This interrupt is generated while active scanning ,after receiving both the adv and scan response packets, in case of receiving adv_ind and adv_discover_ind. Currently not in use.

scan_rsp_rx_intr – This interrupt is generated while active scanning upon receiving scan response packet.

adv_rx_intr – This interrupt is generated while active/passive scanning upon receiving adv packets.

Scan next instant register

| Addr 16-bit | Addr 32-bit | Register Name | RW | Description | Reset |
|----------------|----------------|-------------------|----|--|--------|
| 0x1E | 0x03C | SCAN_NEXT_INSTANT | RO | Shows the instant with respect to internal reference clock of resolution 625 us at which next scanning event begins. | 0x0000 |

| Field | Bit | Description | Reset |
|-------------------|------|--|-------|
| next_scan_instant | 15:0 | Shows the instant with respect to internal reference clock at which next scanning window begins. | 0 |

Initiator Interval register

| Addr 16-bit | Addr 32-bit | Register Name | RW | Description | Reset |
|----------------|----------------|---------------|----|---|--------|
| 0x20 | 0x040 | INIT_INTERVAL | RW | Initiator interval register. Firmware sets the initiator's scanning interval value to this register before issuing create connection command. | 0x0000 |

| Field | Bit | Description | Reset |
|--------------------|------|--|--------|
| Init_scan_interval | 15:0 | Interval between two consecutive scanning events. Range: 0x0004 to 0x4000 Time = N * 625 us Time Range: 2.5 ms to 10.24 s . | 0X0000 |

Initiator window register

| Addr 16-bit | Addr 32-bit | Register Name | RW | Description | Reset |
|----------------|----------------|---------------|----|---|--------|
| 0x22 | 0x044 | INIT_WINDOW | RW | Initiator window register. Firmware sets the scan window value to this register before issuing the create connection command. | 0x0000 |

| Field | Bit | Description | Reset |
|------------------|------|--|--------|
| Init_scan_window | 15:0 | Duration of scan in a scanning event, which should be less than or equal to scan interval value. Range: 0x0004 to 0x4000 Default: 0x0010 (10 ms) Time = N * 625 us Time Range: 2.5 ms to 10.24 s . | 0X0000 |

Initiator parameter register

| Addr 16-bit | Addr 32-bit | Register Name | RW | Description | Reset |
|----------------|----------------|---------------|----|---|--------|
| 0x24 | 0x048 | INIT_PARAM | RW | Initiator parameters register. Firmware sets the necessary parameters for initiation procedure to this register before issuing the create connection command. The | 0x0000 |

Radio Register Overview

| Addr 16-bit | Addr 32-bit | Register Name | RW | Description | Reset |
|----------------|----------------|---------------|----|--|-------|
| | | | | fields in this register are derived from the parameters in the LE_Create_Connection HCI command. | |

| Field | Bit | Description | Reset |
|---------------------------------------|-------|---|-------|
| Reserved | 15:10 | Not used. | XX |
| peer_rpa_resolved_capt (Read only) | 9 | If received peer address is an RPA, this bit represents the RPA resolution status. ie., 1 – RPA resolution pass. 0 – RPA resolution fail. Else this bit is set to zero. | 0 |
| init_tx_addr[1] | 8 | MSB of the device's Own address type. This bit along with init_tx_addr[0] decides the own address of the device. | 0 |
| Reserved | 7 | Not used | XX |
| Init_conn_index | 6:4 | Firmware programs the index of the conn engine for the master connection at init start. Index can be in the range 0x0 to 0x1. | 0x0 |
| init_filt_policy | 3 | The Initiator_Filter_Policy is used to determine whether the White List is used or not used. 0 – White list is not used to determine which advertiser to connect to. Instead the Peer_Address_Type and Peer Address fields are used to specify the address type and address of the advertising device to connect to. 1 – White list is used to determine the advertising device to connect to. Peer_Address_Type and Peer_Address fields are ignored when whitelist is used. | 0 |

Table continues on the next page...

| Field | Bit | Description | Reset |
|---------------------------------------|-----|--|-------|
| init_rx_addr[1] | 2 | MSB of the device's peer address type (FW programmed). This bit along with init_rx_addr[0] decides the peer address of the device. | 0 |
| rx_addr/rx_tx_addr init_rx_addr[0] | 1 | Peer address type. The rx_addr field is updated by the receiver with the address type of the received connectable advertising packet. 1- addr type is random. 0-addr type is public. LSB of the device's peer address type (FW programmed). Init_rx_addr[1:0] – 0x0 – public address 0x1 – random address 0x2 – public identity address 0x3 – random(static) identity address | 0 |
| Tx_addr init_tx_addr[0] | 0 | Own address type. 1 – addr type is random. 0 – addr type is public. LSB of the device's Own address type. Init_tx_addr[1:0] - 0x0 – use public address (addr type is zero) 0x1 – use public address (addr type is one) 0x2 – use RPA if matching entry is available in Resolving list else use public address. 0x3 – use RPA if matching entry is available in Resolving list else use random address. | 0 |

Initiator interrupt clear register

Radio Register Overview

| Addr 16-bit | Addr 32-bit | Register Name | RW | Description | Reset |
|----------------|----------------|-----------------|----|--|--------|
| 0x28 | 0x050 | INIT_INTR_CLEAR | WO | Clears the source of the interrupt. This register is written by firmware to clear interrupts set in the INIT_STATUS register. One or more interrupts can be cleared in a single write operation. | 0x0000 |

| Field | Bit | Description | Reset |
|----------------------|------|--|-------|
| Reserved | 15:5 | Not used. | XX |
| master_conn_created | 4 | Clear master connection created interrupt. Write to the register with this bit set to 1, clears the interrupt source. | 0 |
| Reserved | 3 | Not used. | X |
| Init_tx_start | 2 | Clear init transmission start interrupt. Write to the register with this bit set to 1, clears the interrupt source. | 0 |
| init_close_window | 1 | Clear Initiator scan window close interrupt. Write to the register with this bit set to 1, clears the interrupt source | 0 |
| init_interval_expire | 0 | Clear Initiator scan window start interrupt. Write to the register with this bit set to 1, clears the interrupt source | 0 |

Initiator status register

| Addr 16-bit | Addr 32-bit | Register Name | RW | Description | Reset |
|----------------|----------------|---------------|----|---|--------|
| 0x28 | 0x050 | INIT_STATUS | RO | Shows the status of the interrupt. This register is read by firmware to learn the pending initiator interrupts that are set and are to be served. | 0x0000 |

| Field | Bit | Description | Reset |
|----------------------|------|---|-------|
| Reserved | 15:5 | Not used. | XX |
| master_conn_created | 4 | If this bit is set it indicates connection is created as master. | 0 |
| Reserved | 3 | Not used. | X |
| Init_tx_start | 2 | If this bit is set it indicates initiator packet (CONREQ) transmission has started. | 0 |
| init_close_window | 1 | If this bit is set it indicates initiator scan window has finished. | 0 |
| init_interval_expire | 0 | If this bit is set it indicates initiator scan window has started. | 0 |

Initiator next instant register

| Addr 16-bit | Addr 32-bit | Register Name | RW | Description | Reset |
|----------------|----------------|-------------------|----|--|--------|
| 0x2A | 0x054 | INIT_NEXT_INSTANT | RO | Shows the instant with respect to internal reference clock of 625 us resolution at which next initiator scanning event begins. | 0x0000 |

| Field | Bit | Description | Reset |
|-------------------|------|---|-------|
| next_init_instant | 15:0 | Shows the instant with respect to internal reference clock at which next initiator scanning event begins. | 0 |

Initiator Anchor Point register

| Addr 16-bit | Addr 32-bit | Register Name | RW | Description | Reset |
|----------------|----------------|-------------------|----|--|--------|
| 0x100 | 0x200 | INIT_ANCHOR_POINT | RW | Firmware programs this register (while programming INIT parameters) with the instant (value of bt_clock) at which the initiator should start the procedure | 0x0000 |

Radio Register Overview

| Addr 16-bit | Addr 32-bit | Register Name | RW | Description | Reset |
|----------------|----------------|---------------|----|--|-------|
| | | | | for the first time. This will give firmware a better control in effectively scheduling the new connections in the multiple connection scenarios. | |

| Field | Bit | Description | Reset |
|-------------------|------|--|-------|
| Init_anchor_point | 15:0 | The value of bt_clock (625 us period) at which initiator should start the procedure. | 0 |

Device Random address lower register

| Addr 16-bit | Addr 32-bit | Register Name | RW | Description | Reset |
|----------------|----------------|---------------------|----|--|--------|
| 0x2C | 0x058 | DEV_RAND_ADD R_L | RW | Lower 16 bit random address of the device. | 0x0000 |

| Field | Bit | Description | Reset |
|-----------|------|--|-------|
| Rand_addr | 15:0 | Lower 16 bit of 48-bit random address of the device. | 0 |

Device Random address middle register

| Addr 16-bit | Addr 32-bit | Register Name | RW | Description | Reset |
|----------------|----------------|---------------------|----|---|--------|
| 0x2E | 0x05C | DEV_RAND_ADD R_M | RW | Middle 16 bit random address of the device. | 0x0000 |

| Field | Bit | Description | Reset |
|-----------|------|---|-------|
| Rand_addr | 15:0 | Middle 16 bit of 48-bit random address of the device. | 0 |

Device Random address higher register

| Addr 16-bit | Addr 32-bit | Register Name | RW | Description | Reset |
|----------------|----------------|---------------------|----|---|--------|
| 0x30 | 0x060 | DEV_RANDOM_ADDR_R_H | RW | Higher 16 bit random address of the device. | 0x0000 |

| Field | Bit | Description | Reset |
|-----------|------|---|-------|
| Rand_addr | 15:0 | Higher 16 bit of 48-bit random address of the device. | 0 |

Peer address lower register

| Addr 16-bit | Addr 32-bit | Register Name | RW | Description | Reset |
|----------------|----------------|---------------|----|--|--------|
| 0x34 | 0x068 | PEER_ADDR_L | RW | Lower 16 bit address of the peer device. | 0x0000 |

| Field | Bit | Description | Reset |
|-----------|------|--|-------|
| peer_addr | 15:0 | Lower 16-bit of 48-bit address of the peer device. | 0 |

Peer address middle register

| Addr 16-bit | Addr 32-bit | Register Name | RW | Description | Reset |
|----------------|----------------|---------------|----|---|--------|
| 0x36 | 0x06C | PEER_ADDR_M | RW | Middle 16-bit address of the peer device. | 0x0000 |

| Field | Bit | Description | Reset |
|-----------|------|---|-------|
| peer_addr | 15:0 | Middle 16-bit of 48-bit address of the peer device. | 0 |

Peer address higher register

Radio Register Overview

| Addr 16-bit | Addr 32-bit | Register Name | RW | Description | Reset |
|----------------|----------------|---------------|----|---|--------|
| 0x38 | 0x070 | PEER_ADDR_H | RW | Higher 16-bit address of the peer device. | 0x0000 |

| Field | Bit | Description | Reset |
|-----------|------|--|-------|
| peer_addr | 15:0 | Higher 16-bit of 48-bit of address of the peer device. | 0 |

Initiator Peer Address Lower Register

| Addr 16-bit | Addr 32-bit | Register Name | RW | Description | Reset |
|----------------|----------------|------------------|----|--|--------|
| 0x66 | 0x0CC | INIT_PEER_ADDR_L | RW | Lower 16-bit of init peer address. This register is used only if multiple connections are supported. | 0x0000 |

| Field | Bit | Description | Reset |
|----------------|------|---|-------|
| Init_peer_addr | 15:0 | Lower 16-bit of the 48-bit init peer address. | 0 |

Initiator Peer Address Middle Register

| Addr 16-bit | Addr 32-bit | Register Name | RW | Description | Reset |
|----------------|----------------|------------------|----|---|--------|
| 0x68 | 0x0D0 | INIT_PEER_ADDR_M | RW | Middle 16-bit of init peer address. This register is used only if multiple connections are supported. | 0x0000 |

| Field | Bit | Description | Reset |
|----------------|------|--|-------|
| Init_peer_addr | 15:0 | Middle 16-bit of the 48 bit init peer address. | 0 |

Initiator Peer Address Upper Register

| Addr 16-bit | Addr 32-bit | Register Name | RW | Description | Reset |
|----------------|----------------|------------------|----|--|--------|
| 0x6A | 0x0D4 | INIT_PEER_ADDR_H | RW | Lower 16-bit of init peer address. This register is used only if multiple connections are supported. | 0x0000 |

| Field | Bit | Description | Reset |
|----------------|------|---|-------|
| Init_peer_addr | 15:0 | Upper 16-bit of the 48-bit init peer address. | 0 |

The peer address registers are used for multiple purposes. The register is written by firmware to provide the peer address to be used for a hardware procedure. When firmware reads the register, it reads back peer address values updated by hardware.

While doing directed Advertising, the firmware writes the peer address of the device specified by the `Direct_Address` parameter of the `LE_Set_Advertising_Parameters` command.

While device is configured as an initiator without white list filtering, the peer address specified in the `peer_address` field of the create connection command is programmed into this register, which is used by hardware procedures.

While device is configured as an initiator and white list is enabled, firmware can read this register to get the address of the peer device from which connectable ADV packet was received and to which the connection is created.

When a connection is created as a slave, the firmware can read this register to get the address of the peer device to which connection is created.

INIT_PEER_ADDR is used only for multiple connection support where peer address for initiation is kept at INIT_PEER_ADDR register and ADV peer address is kept/read from PEER_ADDR register.

White List address type register

| Addr 16-bit | Addr 32-bit | Register Name | RW | Description | Reset |
|----------------|----------------|---------------|----|---------------------------------------|--------|
| 0x3C | 0x078 | WL_ADDR_TYPE | RW | Stores the address type of the device | 0x0000 |

Radio Register Overview

| Addr 16-bit | Addr 32-bit | Register Name | RW | Description | Reset |
|----------------|----------------|---------------|----|-------------------------------|-------|
| | | | | addresses stored in whitelist | |

| Field | Bit | Description | Reset |
|----------|------|---|-------|
| Reserved | 15:8 | Reserved | 0 |
| type | 7:0 | 8 address type bits corresponding to the device address stored. 1 – Address type is random. 0 – Address type is public. | 0 |

White list enable register

| Addr 16-bit | Addr 32-bit | Register Name | RW | Description | Reset |
|----------------|----------------|---------------|----|---|--------|
| 0x3E | 0x7C | WL_ENABLE | RW | Stores the valid entry bit corresponding to each of the device address stored in the whitelist. | 0x0000 |

| Field | Bit | Description | Reset |
|----------|------|---|-------|
| Reserved | 15:8 | Reserved for future use | |
| en | 7:0 | Stores the valid entry bit corresponding to each of the eight device addresses stored in the whitelist memory in the hardware. 1 – White list entry is valid. 0 – White list entry invalid. | 0 |

Advertising data transmit FIFO

| Addr 16-bit | Addr 32-bit | Register Name | RW | Description | Reset |
|----------------|----------------|------------------|----|--|--------|
| 0x70 | 0x0E0 | ADV_TX_DATA_FIFO | WO | IO mapped FIFO of depth 16 (2 byte wide), to store ADV data of maximum | 0x0000 |

| Addr 16-bit | Addr 32-bit | Register Name | RW | Description | Reset |
|----------------|----------------|---------------|----|---|-------|
| | | | | length 31 bytes for transmitting. Firmware writes consecutive words by writing to the same address location. | |

| Field | Bit | Description | Reset |
|-------|------|------------------------------------|-------|
| data | 15:0 | Advertising data for transmission. | 0 |

Adv scan response data transmit FIFO

| Addr 16-bit | Addr 32-bit | Register Name | RW | Description | Reset |
|----------------|----------------|---------------------|----|--|--------|
| 0x74 | 0x0E8 | ADV_SCN_RSP_TX_FIFO | WO | IO mapped FIFO of depth 16 (2 byte wide), to store scan response data of maximum length 31 bytes for transmitting. Firmware writes consecutive words by writing to the same location. | 0x0000 |

| Field | Bit | Description | Reset |
|-------|------|--------------------------------------|-------|
| data | 15:0 | scan response data for transmission. | 0 |

NOTE

ADV_TX_DATA_FIFO and ADV_SCN_RSP_TX_FIFO shares same physical FIFO of depth 32. 16 locations for each FIFO are allocated.

| | | |
|------------------------------------|-------------|-------------------------|
| ADV_TX_DATA_FIFO address 16'h70 | Data byte 1 | Length of adv host data |
| Data byte 3 | Data byte 2 | |

Table continues on the next page...

Radio Register Overview

| | | |
|---------------------------------------|--------------|-----------------------------------|
| Data byte 31 | Data byte 30 | Length of scan response host data |
| ADV_SCN_RSP_TX_FIFO address 16'h74 | Data byte 1 | |
| Data byte 3 | Data byte 2 | |
| Data byte 31 | Data byte 30 | |

The length of the payload combined with first payload data and loaded to the advertise channel data transmit FIFO followed by rest of the host data.

Example: Structure of advertising channel transmit FIFO.

bit15 bit8 bit7 bit0

| [15:8] | [7:0] |
|-------------|--------------------------------------|
| Data byte 1 | Length of the payload stored in FIFO |
| Data byte 3 | Data byte 2 |
| Data byte 5 | Data byte 4 |
| Data byte 7 | Data byte 6 |

Conn request data Transmit FIFO

| Addr 16-bit | Addr 32-bit | Register Name | RW | Description | Reset |
|----------------|----------------|----------------------|----|---|--------|
| 0x78 | 0x0F0 | CONN_REQ_TX_F IFO | WO | IO mapped FIFO of depth 48, to store connection request data of maximum length 34 bytes for transmitting. | 0x0000 |

| Field | Bit | Description | Reset |
|-------|------|--|-------|
| Data | 15:0 | Connection request data during transmit operation. | 0 |

Adv scan response data receive FIFO

| Addr 16-bit | Addr 32-bit | Register Name | RW | Description | Reset |
|----------------|----------------|--------------------------|----|--|--------|
| 0x7C | 0x0F8 | INIT_SCN_ADV_R X_FIFO | RO | IO mapped FIFO of depth 64, to store ADV and | 0x0000 |

| Addr 16-bit | Addr 32-bit | Register Name | RW | Description | Reset |
|----------------|----------------|---------------|----|---|-------|
| | | | | SCAN_RSP header and payload received by the scanner. The RSSI value at the time of reception of this packet is also stored. Firmware reads from the same address to read out consecutive words of data. | |

| Field | Bit | Description | Reset |
|-------|------|---|-------|
| Data | 15:0 | adv, scan response data during receive operation. | 0 |

NOTE

The 16 bit header is first loaded to the advertise channel data receive FIFO followed by the payload data and then 16 bit RSSI.

Example: Structure of advertising channel receives FIFO with payload with even number of bytes.

| [15:8] | [7:0] |
|-------------|-------------|
| Header 2 | Header 1 |
| Data byte 2 | Data byte 1 |
| Data byte 4 | Data byte 3 |
| Data byte 6 | Data byte 5 |
| RSSI | RSSI |

Example: Structure of advertising channel receive FIFO with payload with odd number of bytes.

| [15:8] | [7:0] |
|-------------|-------------|
| Header 2 | Header 1 |
| Data byte 2 | Data byte 1 |
| Data byte 4 | Data byte 3 |

Table continues on the next page...

Radio Register Overview

| [15:8] | [7:0] |
|--------|-------------|
| | Data byte 5 |
| RSSI | RSSI |

Device public address lower register

| Addr 16-bit | Addr 32-bit | Register Name | RW | Description | Reset |
|----------------|----------------|--------------------|----|--|--------|
| 0XE0 | 0X1C0 | DEV_PUB_ADDR_ L | RW | Lower 16 bit public address of the device. | 0x3412 |

| Field | Bit | Description | Reset |
|-------------|------|--|--------|
| public_addr | 15:0 | Lower 16-bit of 48-bit public address of the device. | 0x3412 |

Device public address middle register

| Addr 16-bit | Addr 32-bit | Register Name | RW | Description | Reset |
|----------------|----------------|--------------------|----|---|--------|
| 0XE2 | 0X1C4 | DEV_PUB_ADDR_ M | RW | Middle 16-bit public address of the device. | 0x0056 |

| Field | Bit | Description | Reset |
|-------------|------|---|--------|
| public_addr | 15:0 | Middle 16-bit of 48-bit public address of the device. | 0x0056 |

Device public address higher register

| Addr 16-bit | Addr 32-bit | Register Name | RW | Description | Reset |
|----------------|----------------|--------------------|----|---|--------|
| 0XE4 | 0X1C8 | DEV_PUB_ADDR_ H | RW | Higher 16-bit public address of the device. | 0x0000 |

| Field | Bit | Description | Reset |
|-------------|------|--|-------|
| public_addr | 15:0 | Higher 16-bit of 48-bit public address of the peer device. | 0 |

Advertising channel transmit power register

| Addr 16-bit | Addr 32-bit | Register Name | RW | Description | Reset |
|----------------|----------------|-----------------|----|---|--------|
| 0XE6 | 0X1CC | ADV_CH_TX_POWER | RW | <p>The advertising channel transmit power register sets the transmit power level used for LE advertising channel packets and for <u>DTM mode transmissions</u>.</p> <p>The same register is used for setting Transmit power level of all non-connection channels. This includes: Advertising, scanning, Initiating, and Direct test mode (DTM Transmitter tests).</p> | 0x874F |

| Field | Bit | Description | Reset |
|--------------------|-----|--|--------|
| adv_transmit_power | 5:0 | <p>Size: 1 Octet (signed integer)</p> <p>Range: $-20 \leq N \leq 10$</p> <p>Units: dBm</p> <p>Accuracy: +/- 4 dBm in general.</p> <p>In implementation this is a radio specific value. Only the lower 6 bits are used in this device.</p> | 0x874F |

Offset to first instant register

| Addr 16-bit | Addr 32-bit | Register Name | RW | Description | Reset |
|----------------|----------------|-------------------------|----|---|--------|
| 0XE8 | 0X1D0 | OFFSET_TO_FIRST_INSTANT | RW | <p>Offset to the first instant register. The first event instant is determined by firmware based on other procedures which may be on with various</p> | 0x0006 |

Radio Register Overview

| Addr 16-bit | Addr 32-bit | Register Name | RW | Description | Reset |
|----------------|----------------|---------------|----|---|-------|
| | | | | <p>intervals, so as to not overlap on the existing procedure instants. For this, firmware determines the offset to the first instant from the current clock and programs the offset in OFFSET_TO_FIRST_INSTANT register.</p> <p>Unit is in time slots of 625 us</p> <p>For example if current clock value is 0004, and offset is 0008, then first event will begin when clock value becomes 000c.</p> | |

| Field | Bit | Description | Reset |
|-----------------------|------|--|--------|
| offset_to_first_event | 15:0 | <p>The offset with respect to the internal reference clock at which instant the first event occurs.</p> <p>This register will give flexibility to the firmware to position the connection at a desired point with respect to the internal free running clock. It is optional to be updated by firmware. This is not updated in the current firmware. This is for future use.</p> | 0x0006 |

Advertiser configuration register

| Addr 16-bit | Addr 32-bit | Register Name | RW | Description | Reset |
|----------------|----------------|---------------|----|--|--------|
| 0xEA | 0x1D4 | ADV_CONFIG | RW | Advertiser procedure configuration register. Firmware sets the | 0x20FF |

| Addr 16-bit | Addr 32-bit | Register Name | RW | Description | Reset |
|----------------|----------------|---------------|----|---|-------|
| | | | | configuration parameters to this register before issuing start adv command. | |

| Field | Bit | Description | Reset |
|--------------------|-------|--|--------|
| adv_pkt_interval | 15:11 | Time between the beginnings of two consecutive advertising PDU's. Time = N * 625 us Time Range: <=10 ms | 00100b |
| Reserved | 10:9 | Not used. | 0 |
| Adv_rand_disable | 8 | Disable randomization of adv interval. When disabled, interval is same as programmed in adv_interval register. | 0 |
| adv_timeout_en | 7 | Enable adv_timeout interrupt. Applicable in adv_direct_ind advertising. | 1 |
| slv_connected_en | 6 | Enable slave connected interrupt. | 1 |
| adv_conn_req_rx_en | 5 | Enable connect request packet received interrupt. | 1 |
| adv_scn_req_rx_en | 4 | Enable scan request packet received interrupt. | 1 |
| scn_tx_en | 3 | Enable scan response packet transmitted interrupt. | 1 |
| adv_tx_en | 2 | Enable adv packet transmitted interrupt. | 1 |
| adv_cls_en | 1 | Enable advertising event stop interrupt. | 1 |
| adv_strt_en | 0 | Enable advertising event start interrupt. | 1 |

Scan configuration register

| Addr 16-bit | Addr 32-bit | Register Name | RW | Description | Reset |
|----------------|----------------|---------------|----|--|--------|
| 0xEC | 0x1D8 | SCAN_CONFIG | RW | Scanner procedure configuration register. Firmware sets the configuration parameters to this | 0xE07F |

Radio Register Overview

| Addr 16-bit | Addr 32-bit | Register Name | RW | Description | Reset |
|----------------|----------------|---------------|----|--|-------|
| | | | | register before issuing start scan command | |

| Field | Bit | Description | Reset |
|------------------|-------|---|-------|
| scan_channel_map | 15:13 | Advertising channels that are enabled for scanning operation. 15 – Enables channel 39 for use. 14 – Enables channel 38 for use. 13 – Enables channel 37 for use. | 111 |
| Reserved | 12 | Not used. | X |
| backoff_enable | 11 | Enable random backoff feature in scanner. 1 – enable. 0 – disable. | 0 |
| Reserved | 10:5 | Not used | XX |
| scn_rsp_rx_en | 4 | Enable scan_rsp packet received interrupt. | 1 |
| adv_rx_en | 3 | Enable adv packet received interrupt. | 1 |
| scn_tx_en | 2 | Enable scan request packet transmitted interrupt. | 1 |
| scn_close_en | 1 | Enable scan event close interrupt. | 1 |
| scn_strt_en | 0 | Enable scan event start interrupt. | 1 |

Initiator configuration register

| Addr 16-bit | Addr 32-bit | Register Name | RW | Description | Reset |
|----------------|----------------|---------------|----|---|--------|
| 0xEE | 0x1DC | INIT_CONFIG | RW | Initiator procedure configuration register. Firmware sets the configuration parameters to this register before issuing create | 0x0000 |

| Addr 16-bit | Addr 32-bit | Register Name | RW | Description | Reset |
|----------------|----------------|---------------|----|-----------------------|-------|
| | | | | connection command | |

| Field | Bit | Description | Reset |
|------------------|-------|---|-------|
| init_channel_map | 15:13 | Advertising channels that are enabled for initiator scanning operation. 15 – Enables channel 39 for use. 14 – Enables channel 38 for use. 13 – Enables channel 37 for use. | 0 |
| Reserved | 12:8 | Not used | XX |
| conn_created | 4 | Enable master connection created interrupt | 0 |
| Reserved | 3 | Reserved | |
| conn_req_tx_en | 2 | Enables connection request packet transmission start interrupt. | 0 |
| init_close_en | 1 | Enable Initiator scan window close interrupt. | 0 |
| init_strt_en | 0 | Enable Initiator scan window start interrupt. | 0 |

Whitelist base address register

| Addr 16-bit | Addr 32-bit | Register Name | RW | Description | Reset |
|----------------|----------------|---------------------|----|--|--------|
| 0X1A0 | 0X340 | WHITELIST_BASE_ADDR | RW | It is the starting address of white list memory which holds the white listed device address. For a 48 bit device address, three writes of 16 bits is required at the appropriate offset from this base address. The whitelist device addresses are stored as group of 3-words at offset of | 0x0000 |

Radio Register Overview

| Addr 16-bit | Addr 32-bit | Register Name | RW | Description | Reset |
|----------------|----------------|---------------|----|--|-------|
| | | | | <p>N*3, where N=0 to 7, from this base address.</p> <p>While writing the device address, the firmware writes the address in the following order for storage.</p> <p>1st write – [15:0], 2nd write – [31:16], 3rd write – [47:32] bits of the device address.</p> | |

| Field | Bit | Description | Reset |
|-------------|------|--|-------|
| Device_addr | 15:0 | Device address values written to white list memory are written as 16-bit wide address. | 0 |

Whitelist end address register

| Addr 16-bit | Addr 32-bit | Register Name | RW | Description | Reset |
|----------------|----------------|--------------------|----|---|--------|
| 0X1D0 | 0X3A0 | WHITELIST_END_ADDR | RW | It is the last address of white list memory which holds the white list device address. It holds last [47:32] bits of 8th white list device address. It is not accessed by firmware, only used for hardware reference. | 0x0000 |

| Field | Bit | Description | Reset |
|-------------|------|--|-------|
| Device_addr | 15:0 | Device address values written to white list memory are written as 16-bit wide address. | 0 |

Advertiser Tx memory base address register – Reserved for future use

| Addr 16-bit | Addr 32-bit | Register Name | RW | Description | Reset |
|----------------|----------------|--------------------------|----|--|--------|
| 0X160 | 0X2C0 | ADV_TX_MEM_BA SE_ADDR | RW | It is the starting address of ADV Tx memory which holds the data to be transmitted during Advertising operation. | 0x0000 |

| Field | Bit | Description | Reset |
|-------|------|---|-------|
| Data | 15:0 | Data values written to Tx memory are written as 16-bit wide data. | 0 |

Connection Tx memory base address register

| Addr 16-bit | Addr 32-bit | Register Name | RW | Description | Reset |
|----------------|----------------|--------------------------|----|---|--------|
| 0X800 | 0X1000 | CONN_TXMEM_B ASE_ADDR | WO | <p>It is the starting address of Connection Transmit data memory which holds the data to be transmitted during connection.</p> <p>The connection Transmit memory is individually addressable location for firmware. So firmware writes to consecutive even address values to write the next word (2-byte) of data. Hardware accesses this memory as a FIFO. The hardware buffer index is managed in hardware. No buffer index needs to be maintained for firmware access.</p> | 0x0000 |

Radio Register Overview

| Field | Bit | Description | Reset |
|-------|------|---|-------|
| Data | 15:0 | Data values written to Tx memory are written as 16-bit wide data. | 0 |

Connection Rx memory base address register

| Addr 16-bit | Addr 32-bit | Register Name | RW | Description | Reset |
|----------------|----------------|--------------------------|----|--|--------|
| 0X400 | 0X800 | CONN_RXMEM_B ASE_ADDR | RO | It is the starting address of Connection Receive data memory/FIFO which holds the data to be received during connection. The connection receive memory/ FIFO is used as a FIFO by both hardware and firmware. Firmware needs to read from the same address to read out the consecutive words in the FIFO. | 0x0000 |

| Field | Bit | Description | Reset |
|-------|------|--|-------|
| Data | 15:0 | Data values read from Rx memory are read as 16-bit wide data | 0 |

Conn_req_word0 register

| Addr 16-bit | Addr 32-bit | Register Name | RW | Description | Reset |
|----------------|----------------|--------------------|----|--|--------|
| 0x1E0 | 0x3C0 | CONN_REQ_WOR D0 | RW | The connect request word0 register must be programmed with the access address value of the connect request packet, before initiating | 0x0000 |

| Addr 16-bit | Addr 32-bit | Register Name | RW | Description | Reset |
|----------------|----------------|---------------|----|--|-------|
| | | | | connection. After slave connection this value can be obtained by reading this register on the advertiser side. | |

| Field | Bit | Description | Reset |
|-------------------|------|---|--------|
| Access_addr[15:0] | 15:0 | This field defines the lower 16 bits of the access address that is to be sent in the connect request packet of the initiator. | 0x0000 |

Conn_req_word1 register

| Addr 16-bit | Addr 32-bit | Register Name | RW | Description | Reset |
|----------------|----------------|----------------|----|---|--------|
| 0x1E2 | 0x3C4 | CONN_REQ_WORD1 | RW | The connect request word1 register must be programmed with the access address value of the connect request packet, before initiating connection. After slave connection this value can be obtained by reading this register on the advertiser side. | 0x0000 |

| Field | Bit | Description | Reset |
|-----------------------|------|---|--------|
| Access_Address[31:16] | 15:0 | This field defines the upper 16 bits of the access address that is to be sent in the connect request packet of the initiator. | 0x0000 |

Conn_req_word2 register

Radio Register Overview

| Addr 16-bit | Addr 32-bit | Register Name | RW | Description | Reset |
|----------------|----------------|--------------------|----|--|--------|
| 0x1E4 | 0x3C8 | CONN_REQ_WOR D2 | RW | This field defines the lower byte[7:0] of the CRC initialization value, and tx_window_size[7:0], to be sent in the connect request packet of the initiator. After slave connection these values can be obtained by reading this register on the advertiser side. | 0x0000 |

| Field | Bit | Description | Reset |
|---------------------|------|---|-------|
| crc_init[7:0] | 15:8 | This field defines the lower byte[7:0] of the CRC initialization value. | 0 |
| Tx_window_size[7:0] | 7:0 | <p>window_size along with the window_offset is used to calculate the first connection point anchor point for the master.</p> <p>This shall be a multiple of 1.25 ms in the range of 1.25 ms to the lesser of 10 ms and (connInterval – 1.25 ms).</p> <p>Values range from 0 to 10 ms.</p> | 0 |

Conn_req_word3 register

| Addr 16-bit | Addr 32-bit | Register Name | RW | Description | Reset |
|----------------|----------------|--------------------|----|--|--------|
| 0x1E6 | 0x3CC | CONN_REQ_WOR D3 | RW | This field must be programmed with the upper byte [23:8] of the CRC initialization value. After slave connection this value can be obtained by reading this register on the advertiser side. | 0x0000 |

| Field | Bit | Description | Reset |
|----------------|------|---|--------|
| crc_init[23:8] | 15:0 | This field defines the upper byte [23:8] of the CRC initialization value that is to be sent in the connect request packet of the initiator. | 0x0000 |

Conn_req_word4 register

| Addr 16-bit | Addr 32-bit | Register Name | RW | Description | Reset |
|----------------|----------------|--------------------|----|--|--------|
| 0x1E8 | 0x3D0 | CONN_REQ_WOR D4 | RW | This field defines the 16 bits of the transmit window offset that is to be sent in the connect request packet of the initiator. After slave connection this value can be obtained by reading this register on the advertiser side. | 0x0000 |

| Field | Bit | Description | Reset |
|------------------|------|---|-------|
| Tx_window_offset | 15:0 | This is used to determine the anchor point for the master transmission. Range: This shall be a multiple of 1.25 ms in the range of 0 ms to connInterval value. | 0 |

Conn_req_word5 register

| Addr 16-bit | Addr 32-bit | Register Name | RW | Description | Reset |
|----------------|----------------|--------------------|----|---|--------|
| 0x1EA | 0x3D4 | CONN_REQ_WOR D5 | RW | This field defines the 16 bits of the connection interval value that is to be sent in the connect request packet of the initiator. After slave connection this value can be obtained by reading this register on the advertiser side. | 0x0000 |

Radio Register Overview

| Field | Bit | Description | Reset |
|-------------------|------|---|--------|
| Conn_interval_val | 15:0 | The value configured in this register determines the spacing between the connection events. This shall be a multiple of 1.25 ms in the range of 7.5 ms to 4.0 s. | 0x0000 |

Conn_req_word6 register

| Addr 16-bit | Addr 32-bit | Register Name | RW | Description | Reset |
|----------------|----------------|--------------------|----|---|--------|
| 0x1EC | 0x3D8 | CONN_REQ_WOR D6 | RW | This field defines the 16 bits of the slave latency value that is to be sent in the connect request packet of the initiator. After slave connection this value can be obtained by reading this register on the advertiser side. | 0x0000 |

| Field | Bit | Description | Reset |
|-----------------|------|---|--------|
| Slv_latency_val | 15:0 | The value configured in this field defines the number of consecutive connection events that the slave device is not required to listen for master. The value of connSlaveLatency should not cause a Supervision Timeout. This shall be an integer in the range of 0 to $((\text{connSupervision Timeout}/\text{connInterval})-1)$. connSlaveLatency shall also be less than 500. | 0x0000 |

Conn_req_word7 register

| Addr 16-bit | Addr 32-bit | Register Name | RW | Description | Reset |
|----------------|----------------|--------------------|----|---|--------|
| 0x1EE | 0x3DC | CONN_REQ_WOR D7 | RW | This field defines the 16 bits of the supervision timeout value that is to be sent in the connect request packet of the initiator. After slave connection this value can be obtained by reading this register on the advertiser side. | 0x0000 |

| Field | Bit | Description | Reset |
|------------|------|---|--------|
| Sup_to_val | 15:0 | This field defines the maximum time between two received Data packet PDUs before the connection is considered lost. This shall be a multiple of 10 ms in the range of 100 ms to 32.0 s and it shall be larger than $(1+\text{connSlaveLatency}) \cdot \text{connInterval}$. | 0x0000 |

Conn_req_word8 register

| Addr 16-bit | Addr 32-bit | Register Name | RW | Description | Reset |
|----------------|----------------|--------------------|----|---|--------|
| 0x1F0 | 0x3E0 | CONN_REQ_WOR D8 | RW | This field defines the channel map for channels [15:0], that is to be sent in the connect request packet of the initiator. After slave connection this value can be obtained by reading this register on the advertiser side. | 0x0000 |

Radio Register Overview

| Field | Bit | Description | Reset |
|---------------------|------|--|---------------|
| Data_channels[15:0] | 15:0 | This register field indicates which of the data channels are in use. This stores the information for the lower 16 (15:0) data channel indices. 1 – indicates the corresponding data channel is used 0 – indicates the channel is unused. | Data_channels |

Conn_req_word9 register

| Addr 16-bit | Addr 32-bit | Register Name | RW | Description | Reset |
|----------------|----------------|--------------------|----|--|--------|
| 0x1F2 | 0x3E4 | CONN_REQ_WOR D9 | RW | This field defines the channel map for channels [31:16], that is to be sent in the connect request packet of the initiator. After slave connection this value can be obtained by reading this register on the advertiser side. | 0x0000 |

| Field | Bit | Description | Reset |
|----------------------|------|--|---------------|
| Data_channels[31:16] | 15:0 | This register field indicates which of the data channels are in use. This stores the information for the middle 16 (31:16) data channel indices. 1 – indicates the corresponding data channel is used 0 – indicates the channel is unused. | Data_channels |

Conn_req_word10 register

| Addr 16-bit | Addr 32-bit | Register Name | RW | Description | Reset |
|----------------|----------------|---------------------|----|---|--------|
| 0x1F4 | 0x3E8 | CONN_REQ_WOR D10 | RW | This field defines the channel map for channels | 0x0000 |

| Addr 16-bit | Addr 32-bit | Register Name | RW | Description | Reset |
|----------------|----------------|---------------|----|--|-------|
| | | | | [36:32], that is to be sent in the connect request packet of the initiator. After slave connection this value can be obtained by reading this register on the advertiser side. | |

| Field | Bit | Description | Reset |
|----------------------|-----|--|---------------|
| Data_channels[36:32] | 4:0 | This register field indicates which of the data channels are in use. This stores the information for the upper 5 (36:32) data channel indices. 1 – indicates the corresponding data channel is used 0 – indicates the channel is unused. | Data_channels |

Conn_req_word11 register

| Addr 16-bit | Addr 32-bit | Register Name | RW | Description | Reset |
|----------------|----------------|---------------------|----|---|--------|
| 0x1F6 | 0x3EC | CONN_REQ_WOR D11 | RW | The connect request word0 register must be programmed with Connection parameters sca, hop_increment value of the connect request packet, before initiating connection. After slave connection this value can be obtained by reading this register on the advertiser side. | 0x0000 |

Radio Register Overview

| Field | Bit | Description | Reset |
|--------------------|-----|---|-------|
| Sca[2:0] | 7:5 | This field defines the sleep clock accuracies given in ppm. | 0 |
| hop_increment[4:0] | 4:0 | This field is used for the data channel selection process. | 0 |

RPA timer interval register

| Addr 16-bit | Addr 32-bit | Register Name | RW | Description | Reset |
|----------------|----------------|------------------------|----|--|--------|
| 0x582 | 0xB04 | RPA_TIMER_INTE RVAL | RW | The RPA timer interval register stores the RPA refresh time interval. (FW programmed). | 0x0000 |

| Field | Bit | Description | Reset |
|------------------------|------|---|-------|
| rpa_timer_interval_val | 15:0 | This field holds the lower value of the RPA refresh time interval in seconds. | 0 |

RPA timer interval register_U

| Addr 16-bit | Addr 32-bit | Register Name | RW | Description | Reset |
|----------------|----------------|--------------------------|----|--|--------|
| 0x58A | 0xB14 | RPA_TIMER_INTE RVAL_U | RW | The RPA timer interval register stores the RPA refresh time interval. (FW programmed). | 0x0000 |

| Field | Bit | Description | Reset |
|------------------------|-----|---|-------|
| rpa_timer_interval_val | 9:0 | This field holds the upper value of the RPA refresh time interval in seconds. | 0 |

Privacy Configuration register

| Addr 16-bit | Addr 32-bit | Register Name | RW | Description | Reset |
|----------------|----------------|-----------------------|----|---|--------|
| 0x108 | 0x210 | LL_PRIVACY_CO NFIG | RW | This register fields can be set to enable/disable Privacy feature in LLH. | 0x0000 |

| Field | Bit | Description | Reset |
|----------------|------|--|-------|
| Reserved | 15:1 | Reserved for future use. | 0 |
| privacy_config | 0 | Whenever this bit is set LLH will try to resolve the address for all ADVCH procedures. | 0 |

RPA selection index register

| Addr 16-bit | Addr 32-bit | Register Name | RW | Description | Reset |
|----------------|----------------|-----------------------------|----|--|-------|
| 0x10A | 0x214 | CURRENT_LOCAL _IRK_INDEX | RW | This register is programmed by firmware before advertising and Initiation procedures. This bit is used to indicate the local IRK to be used by HW during advertising and Initiation procedures. | 0xFF |

| Field | Bit | Description | Reset |
|---------------------|---|---|-------|
| Reserved | 15:8 | Reserved for future use. | 0 |
| cur_local_irk_index | 7:4 | This field holds the resolving list index corresponding to the IRK to be used for the INIT procedure. This field is invalid when white list is enabled. Value 0xF – valid IRK for INIT procedure is not set in resolving list. | 0xF |
| 3:0 | This field holds the resolving list index corresponding to the IRK to be used for the ADV | 0xF | |

Radio Register Overview

| Field | Bit | Description | Reset |
|-------|--|-------------|-------|
| | procedure. This field is also valid when white list is enabled. Value 0xF – valid IRK for ADV procedure is not set in resolving list. | | |

Peer identity address type register

| Addr 16-bit | Addr 32-bit | Register Name | RW | Description | Reset |
|----------------|----------------|-------------------------|----|--|-------|
| 0x10C | 0x218 | PEER_IDENTITY_ADDR_TYPE | RW | This register stores the peer identity address type (Public or Random) corresponding to the IRK pair populated in the resolving list. The value is valid if the resolving list entry is valid. | 0x0 |

| Field | Bit | Description | Reset |
|-------------------|------|---|-------|
| Reserved | 15:4 | Reserved for future use. | 0 |
| peer_id_addr_type | 3:0 | Peer_id_addr_type [i] = 0/1 => ith resolving list entry corresponds to a peer whose address is public/random. | 0 |

Resolving list entry valid register

| Addr 16-bit | Addr 32-bit | Register Name | RW | Description | Reset |
|----------------|----------------|----------------|----|---|-------|
| 0x10E | 0x21C | RES_LIST_VALID | RW | This register is used to indicate to HW which resolving list entries are valid/invalid. | 0x0 |

| Field | Bit | Description | Reset |
|----------|------|--------------------------|-------|
| Reserved | 15:4 | Reserved for future use. | 0 |

Table continues on the next page...

| Field | Bit | Description | Reset |
|--------------------|-----|--|-------|
| device_valid_entry | 3:0 | Device_valid_entry [i] = 0/1 => 0 ith resolving list entry is invalid/valid. | 0 |

Advertising parameters 2 register

| Addr 16-bit | Addr 32-bit | Register Name | RW | Description | Reset |
|----------------|----------------|---------------|----|--|-------|
| 0x0A | 0x14 | ADV_PARAMS_2 | RW | This register stores the own address type for the Advertising procedure. | 0x0 |

| Field | Bit | Description | Reset |
|-------------|------|---|-------|
| Reserved | 15:2 | Reserved for future use. | 0 |
| adv_tx_addr | 1:0 | Device Own_address_type field. 0x0 – Own address type is public address. 0x1 – Own address type is random address. 0x2 – Own address type is RPA. If resolving list contains no matching entry, use public address. 0x3 – Own address type is RPA. If resolving list contains no matching entry, use random address. | 0 |

Local IRK 0 registers

| Addr 16-bit | Addr 32-bit | Register Name | RW | Description | Reset |
|----------------|-----------------|---------------|----|---|--|
| 0xD00 – 0xD0E | 0x1A00 – 0x1A1C | L_IRK_0_x | RW | These registers store the local IRK value for 0th resolving list entry. IRK value is of 128 bits and stored in Little Endian format (lowest address register has the LSW). | 0x0000000000000000 0000000000000000 0000 |

Radio Register Overview

| Field | Bit | Description | Reset |
|-----------------|-------|---|-------|
| dev_localirk[0] | 127:0 | This field has the 128 bit value of local IRK for 0th resolving list entry. | 0 |

Local IRK 1 registers

| Addr 16-bit | Addr 32-bit | Register Name | RW | Description | Reset |
|----------------|-----------------|---------------|----|--|--|
| 0xD10 – 0xD1E | 0x1A20 – 0x1A3C | L_IRK_1_x | RW | These registers store the local IRK value for first resolving list entry. IRK value is of 128 bits and stored in Little Endian format (lowest address register has the LSW). | 0x0000000000000000 0000000000000000 0000 |

| Field | Bit | Description | Reset |
|-----------------|-------|---|-------|
| dev_localirk[1] | 127:0 | This field has the 128 bit value of local IRK for first resolving list entry. | 0 |

Local IRK 2 registers

| Addr 16-bit | Addr 32-bit | Register Name | RW | Description | Reset |
|----------------|-----------------|---------------|----|---|--|
| 0xD20 – 0xD2E | 0x1A40 – 0x1A5C | L_IRK_2_x | RW | These registers store the local IRK value for second resolving list entry. IRK value is of 128 bits and stored in Little Endian format (lowest address register has the LSW). | 0x0000000000000000 0000000000000000 0000 |

| Field | Bit | Description | Reset |
|-----------------|-------|--|-------|
| dev_localirk[2] | 127:0 | This field has the 128 bit value of local IRK for second resolving list entry. | 0 |

Local IRK 3 registers

| Addr 16-bit | Addr 32-bit | Register Name | RW | Description | Reset |
|----------------|-----------------|---------------|----|--|--|
| 0xD30 – 0xD3E | 0x1A60 – 0x1A7C | L_IRK_3_x | RW | These registers store the local IRK value for third resolving list entry. IRK value is of 128 bits and stored in Little Endian format (lowest address register has the LSW). | 0x0000000000000000 0000000000000000 0000 |

| Field | Bit | Description | Reset |
|-----------------|-------|---|-------|
| dev_localirk[3] | 127:0 | This field has the 128 bit value of local IRK for third resolving list entry. | 0 |

Peer IRK 0 registers

| Addr 16-bit | Addr 32-bit | Register Name | RW | Description | Reset |
|----------------|-----------------|---------------|----|---|--|
| 0xD80 – 0xD8E | 0x1B00 – 0x1B1C | P_IRK_0_x | RW | These registers store the peer IRK value for 0 th resolving list entry. IRK value is of 128 bits and stored in Little Endian format (lowest address register has the LSW). | 0x0000000000000000 0000000000000000 0000 |

| Field | Bit | Description | Reset |
|----------------|-------|--|-------|
| dev_peerirk[0] | 127:0 | This field has the 128 bit value of peer IRK for 0 th resolving list entry. | 0 |

Peer IRK 1 registers

Radio Register Overview

| Addr 16-bit | Addr 32-bit | Register Name | RW | Description | Reset |
|----------------|-----------------|---------------|----|---|--|
| 0xD90 – 0xD9E | 0x1B20 – 0x1B3C | P_IRK_1_x | RW | These registers store the peer IRK value for first resolving list entry. IRK value is of 128 bits and stored in Little Endian format (lowest address register has the LSW). | 0x0000000000000000 0000000000000000 0000 |

| Field | Bit | Description | Reset |
|----------------|-------|--|-------|
| dev_peerirk[1] | 127:0 | This field has the 128 bit value of peer IRK for first resolving list entry. | 0 |

Peer IRK 2 registers

| Addr 16-bit | Addr 32-bit | Register Name | RW | Description | Reset |
|----------------|-----------------|---------------|----|---|--|
| 0xDA0 – 0DAE | 0x1B40 – 0x1B5C | P_IRK_2_x | RW | These registers store the peer IRK value for 2 nd resolving list entry. IRK value is of 128 bits and stored in Little Endian format (lowest address register has the LSW). | 0x0000000000000000 0000000000000000 0000 |

| Field | Bit | Description | Reset |
|----------------|-------|--|-------|
| dev_peerirk[2] | 127:0 | This field has the 128 bit value of peer IRK for 2 nd resolving list entry. | 0 |

Peer IRK 3 registers

| Addr 16-bit | Addr 32-bit | Register Name | RW | Description | Reset |
|----------------|-----------------|---------------|----|--|--|
| 0xDB0 – 0DBE | 0x1B60 – 0x1B7C | P_IRK_3_x | RW | These registers store the peer IRK value for 3 rd resolving list entry. | 0x0000000000000000 0000000000000000 0000 |

| Addr 16-bit | Addr 32-bit | Register Name | RW | Description | Reset |
|----------------|----------------|---------------|----|--|-------|
| | | | | IRK value is of 128 bits and stored in Little Endian format (lowest address register has the LSW). | |

| Field | Bit | Description | Reset |
|----------------|-------|--|-------|
| dev_peerirk[3] | 127:0 | This field has the 128 bit value of peer IRK for 3 rd resolving list entry. | 0 |

Peer identity address 0 registers

| Addr 16-bit | Addr 32-bit | Register Name | RW | Description | Reset |
|----------------|-----------------|------------------|----|--|----------------|
| 0xE00 – 0xE04 | 0x1C00 – 0x1C08 | PEER_ID_ADDR_0_x | RW | These registers store the peer identity address for 0 th resolving list entry. Identity address is of 48 bits and stored in Little Endian format (lowest address register has the LSW). | 0x000000000000 |

| Field | Bit | Description | Reset |
|----------------------|------|--|-------|
| dev_identity_addr[0] | 47:0 | This field has the 48 bit value of peer ID address for 0 th resolving list entry. | 0 |

Peer identity address 1 registers

| Addr 16-bit | Addr 32-bit | Register Name | RW | Description | Reset |
|----------------|-----------------|------------------|----|---|----------------|
| 0xE06 – 0xE0A | 0x1C0C – 0x1C14 | PEER_ID_ADDR_1_x | RW | These registers store the peer identity address for 1 st resolving list entry. Identity address is of 48 bits and stored in Little Endian format | 0x000000000000 |

Radio Register Overview

| Addr 16-bit | Addr 32-bit | Register Name | RW | Description | Reset |
|----------------|----------------|---------------|----|--|-------|
| | | | | (lowest address register has the LSW). | |

| Field | Bit | Description | Reset |
|----------------------|------|--|-------|
| dev_identity_addr[1] | 47:0 | This field has the 48 bit value of peer ID address for 1st resolving list entry. | 0 |

Peer identity address 2 registers

| Addr 16-bit | Addr 32-bit | Register Name | RW | Description | Reset |
|----------------|-----------------|------------------|----|--|----------------|
| 0xE0C – 0xE10 | 0x1C18 – 0x1C20 | PEER_ID_ADDR_2_x | RW | These registers store the peer identity address for 2 nd resolving list entry. Identity address is of 48 bits and stored in Little Endian format (lowest address register has the LSW). | 0x000000000000 |

| Field | Bit | Description | Reset |
|----------------------|------|--|-------|
| dev_identity_addr[2] | 47:0 | This field has the 48 bit value of peer ID address for 2 nd resolving list entry. | 0 |

Peer identity address 3 registers

| Addr 16-bit | Addr 32-bit | Register Name | RW | Description | Reset |
|----------------|-----------------|------------------|----|--|----------------|
| 0xE12 – 0xE16 | 0x1C24 – 0x1C2C | PEER_ID_ADDR_3_x | RW | These registers store the peer identity address for 3 rd resolving list entry. Identity address is of 48 bits and stored in Little Endian format (lowest address register has the LSW). | 0x000000000000 |

| Field | Bit | Description | Reset |
|----------------------|------|--|-------|
| dev_identity_addr[3] | 47:0 | This field has the 48 bit value of peer ID address for 3 rd resolving list entry. | 0 |

Local RPA 0 registers

| Addr 16-bit | Addr 32-bit | Register Name | RW | Description | Reset |
|----------------|-----------------|---------------|----|--|----------------|
| 0xE30 – 0xE34 | 0x1C60 – 0x1C68 | L_RPA_0_x | RO | These registers store the local RPA generated by the HW using the local IRK of the 0 th resolving list entry. RPA is of 48 bits and stored in Little Endian format (lowest address register has the LSW). | 0x000000000000 |

| Field | Bit | Description | Reset |
|-----------------|------|--|-------|
| self_rpa_list_0 | 47:0 | This field has the 48 bit value of local RPA for 0 th resolving list entry. | 0 |

Local RPA 1 registers

| Addr 16-bit | Addr 32-bit | Register Name | RW | Description | Reset |
|----------------|-----------------|---------------|----|--|----------------|
| 0xE36 – 0xE3A | 0x1C6C – 0x1C74 | L_RPA_1_x | RO | These registers store the local RPA generated by the HW using the local IRK of the 1 st resolving list entry. RPA is of 48 bits and stored in Little Endian format (lowest address register has the LSW). | 0x000000000000 |

Radio Register Overview

| Field | Bit | Description | Reset |
|-----------------|------|--|-------|
| self_rpa_list_1 | 47:0 | This field has the 48 bit value of local RPA for 1 st RESOLVING LIST entry. | 0 |

Local RPA 2 registers

| Addr 16-bit | Addr 32-bit | Register Name | RW | Description | Reset |
|----------------|-----------------|---------------|----|--|----------------|
| 0xE3C – 0xE40 | 0x1C78 – 0x1C80 | L_RPA_2_x | RO | These registers store the local RPA generated by the HW using the local IRK of the 2 nd RESOLVING LIST entry. RPA is of 48 bits and stored in Little Endian format (lowest address register has the LSW). | 0x000000000000 |

| Field | Bit | Description | Reset |
|-----------------|------|--|-------|
| self_rpa_list_2 | 47:0 | This field has the 48 bit value of local RPA for 2 nd RESOLVING LIST entry. | 0 |

Local RPA 3 registers

| Addr 16-bit | Addr 32-bit | Register Name | RW | Description | Reset |
|----------------|-----------------|---------------|----|--|----------------|
| 0xE42 – 0xE46 | 0x1C84 – 0x1C8C | L_RPA_3_x | RO | These registers store the local RPA generated by the HW using the local IRK of the 3 rd resolving list entry. RPA is of 48 bits and stored in Little Endian format (lowest address register has the LSW). | 0x000000000000 |

| Field | Bit | Description | Reset |
|-----------------|------|--|-------|
| self_rpa_list_3 | 47:0 | This field has the 48 bit value of local RPA for 3 rd RESOLVING LIST entry. | 0 |

Peer RPA 0 registers

| Addr 16-bit | Addr 32-bit | Register Name | RW | Description | Reset |
|----------------|-----------------|---------------|----|--|----------------|
| 0xE60 – 0xE64 | 0x1CC0 – 0x1CC8 | P_RPA_0_x | RO | These registers store the peer RPA generated by the HW using the peer IRK of the 0 th resolving list entry. RPA is of 48 bits and stored in Little Endian format (lowest address register has the LSW). | 0x000000000000 |

| Field | Bit | Description | Reset |
|-----------------|------|---|-------|
| peer_rpa_list_0 | 47:0 | This field has the 48 bit value of peer RPA for 0 th resolving list entry. | 0 |

Peer RPA 1 registers

| Addr 16-bit | Addr 32-bit | Register Name | RW | Description | Reset |
|----------------|-----------------|---------------|----|--|----------------|
| 0xE66 – 0xE6A | 0x1CCC – 0x1CD4 | P_RPA_1_x | RO | These registers store the peer RPA generated by the HW using the peer IRK of the 1 st resolving list entry. RPA is of 48 bits and stored in Little Endian format (lowest address register has the LSW). | 0x000000000000 |

Radio Register Overview

| Field | Bit | Description | Reset |
|-----------------|------|---|-------|
| peer_rpa_list_1 | 47:0 | This field has the 48 bit value of peer RPA for 1 st resolving list entry. | 0 |

Peer RPA 2 registers

| Addr 16-bit | Addr 32-bit | Register Name | RW | Description | Reset |
|----------------|-----------------|---------------|----|--|----------------|
| 0xE6C-0xE70 | 0x1CD8 – 0x1CE0 | P_RPA_2_x | RO | These registers store the peer RPA generated by the HW using the peer IRK of the 2 nd resolving list entry. RPA is of 48 bits and stored in Little Endian format (lowest address register has the LSW). | 0x000000000000 |

| Field | Bit | Description | Reset |
|-----------------|------|---|-------|
| peer_rpa_list_2 | 47:0 | This field has the 48 bit value of peer RPA for 2 nd resolving list entry. | 0 |

Peer RPA 3 registers

| Addr 16-bit | Addr 32-bit | Register Name | RW | Description | Reset |
|----------------|-----------------|---------------|----|--|----------------|
| 0xE72-0xE76 | 0x1CE4 – 0x1CEC | P_RPA_3_x | RO | These registers store the peer RPA generated by the HW using the peer IRK of the 3 rd resolving list entry. RPA is of 48 bits and stored in Little Endian format (lowest address register has the LSW). | 0x000000000000 |

| Field | Bit | Description | Reset |
|-----------------|------|---|-------|
| peer_rpa_list_3 | 47:0 | This field has the 48 bit value of peer RPA for 3 rd resolving list entry. | 0 |

RPA timer wrap count register

| Addr 16-bit | Addr 32-bit | Register Name | RW | Description | Reset |
|----------------|----------------|----------------------|----|--|-------|
| 0x586 | 0xB0C | RPA_TIMER_WRAP_COUNT | RO | The RPA timer wrap count register stores the wrap count value. A wrap is a complete bt_clock roll from 0x0000 to 0xFFFF. | 0x0 |

| Field | Bit | Description | Reset |
|----------------------|-------|---|-------|
| Reserved | 15:10 | Not used | 0 |
| rpa_timer_wrap_count | 9:0 | This field holds the bt_clock wrap count value. | 0 |

RPA timer current wrap register

| Addr 16-bit | Addr 32-bit | Register Name | RW | Description | Reset |
|----------------|----------------|------------------------|----|--|-------|
| 0x584 | 0xB08 | RPA_TIMER_CURRENT_WRAP | RO | The RPA timer current wrap register stores the current wrap count value. | 0x0 |

| Field | Bit | Description | Reset |
|------------------------|-------|--|-------|
| Reserved | 15:12 | Not used | 0 |
| rpa_timer_current_wrap | 11:2 | This field holds RPA timer's current wrap count value. | 0 |
| rpa_timer_en | 1 | Indicates whether RPA timer is ON in hardware. 1 – on 0 – off | 0 |
| wrap_valid | 0 | Indicates whether RPA timer's wrap is valid. 1 – wrap is valid 0 – wrap is invalid | 0 |

RPA timer next instant register

| Addr 16-bit | Addr 32-bit | Register Name | RW | Description | Reset |
|----------------|----------------|------------------------|----|---|-------|
| 0x588 | 0xB10 | RPA_TIMER_NEXT_INSTANT | RO | Holds the next RPA timer instant value. | 0x0 |

| Field | Bit | Description | Reset |
|------------------------|-------|--|-------|
| Reserved | 15:10 | Not used | 0 |
| rpa_timer_next_instant | 9:0 | Holds the next RPA timer instant value. This instant is valid when wrap valid = 1. | 0 |

45.2.3.1.3 Data Channel Registers

Data Channel Register Descriptions for the Bluetooth Link Layer

Transmit window offset register

| Addr 16-bit | Addr 32-bit | Register Name | RW | Description | Reset |
|----------------|----------------|------------------------|----|---|--------|
| 0x40 | 0x080 | TRANSMIT_WINDOW_OFFSET | RW | Stores the transmit window offset parameter used during connection setup and connection update procedures. The register is updated by hardware when device is slave. | 0x0000 |

| Field | Bit | Description | Reset |
|---------------|------|---|-------|
| window_offset | 15:0 | This is used to determine the first anchor point for the master transmission, from the time of connection creation. Range: This shall be a multiple of 1.25 ms in the range of 0 ms to connInterval value. | 0 |

Transmit window size register

| Addr 16-bit | Addr 32-bit | Register Name | RW | Description | Reset |
|----------------|----------------|----------------------|----|--|--------|
| 0x42 | 0x084 | TRANSMIT_WINDOW_SIZE | RW | Stores the transmit window size parameter used during connection setup and connection update procedures. The register is updated by hardware when device is slave. | 0x0000 |

| Field | Bit | Description | Reset |
|-------------|-----|---|-------|
| window_size | 7:0 | <p>window_size along with the window_offset is used to calculate the first connection point anchor point for the master.</p> <p>This shall be a multiple of 1.25 ms in the range of 1.25 ms to the lesser of 10 ms and (connInterval – 1.25 ms).</p> <p>Values range from 0 to 10 ms.</p> | 0 |

Data channel map 0 (lower word) register

| Addr 16-bit | Addr 32-bit | Register Name | RW | Description | Reset |
|----------------|----------------|------------------|----|---|--------|
| 0x44 | 0x088 | DATA_CHANNELS_LO | RW | Stores the channel map for channels [15:0]. The register is updated by firmware whenever a new/updated channel map is available for the connection. | 0x0000 |

| Field | Bit | Description | Reset |
|-------|-----|-------------|-------|
|-------|-----|-------------|-------|

Table continues on the next page...

Radio Register Overview

| | | | |
|---------------|------|---|--------|
| Data_channels | 15:0 | This register field indicates which of the data channels are in use. This stores the information for the lower 16 (15:0) data channel indices. '1' indicates the corresponding data channel is used and '0' indicates the channel is unused. | 0x0000 |
|---------------|------|---|--------|

Data channel map 0(middle word) register

| Addr 16-bit | Addr 32-bit | Register Name | RW | Description | Reset |
|----------------|----------------|------------------|----|---|--------|
| 0x46 | 0x08C | DATA_CHANNELS_M0 | RW | Stores the channel map for channels[31:16]. The register is updated by firmware whenever a new/updated channel map is available for the connection. | 0x0000 |

| Field | Bit | Description | Reset |
|---------------|------|---|--------|
| Data_channels | 15:0 | This register field indicates which of the data channels are in use. This stores the information for the middle 16 (31:16) data channel indices. '1' indicates the corresponding data channel is used and '0' indicates the channel is unused. | 0x0000 |

Data channel map 0(upper word) register

| Addr 16-bit | Addr 32-bit | Register Name | RW | Description | Reset |
|----------------|----------------|------------------|----|--|--------|
| 0x48 | 0x090 | DATA_CHANNELS_H0 | RW | Stores the channel map for channels[36:32]. The register is updated by firmware whenever a new/updated | 0x0000 |

| | | | | | |
|--|--|--|--|--|--|
| | | | | channel map is available for the connection. | |
|--|--|--|--|--|--|

| Field | Bit | Description | Reset |
|---------------|------|---|-------|
| Data_channels | 15:5 | Unused | 0 |
| Data_channels | 4:0 | This register field indicates which of the data channels are in use. This stores the information for the upper 5 (36:32) data channel indices. '1' indicates the corresponding data channel is used and '0' indicates the channel is unused. | 0x00 |

Data channel map 1 (lower word) register

| Addr 16-bit | Addr 32-bit | Register Name | RW | Description | Reset |
|----------------|----------------|------------------|----|--|--------|
| 0x4C | 0x098 | DATA_CHANNELS_L1 | RW | Stores the channel map for channels[15:0]. The register is updated by firmware whenever a new/updated channel map is available for the connection. | 0x0000 |

| Field | Bit | Description | Reset |
|---------------|------|--|--------|
| Data_channels | 15:0 | This register field indicates which of the data channels are in use. This stores the information for the lower 16 data channel indices. '1' indicates the corresponding data channel is used and '0' indicates the channel is unused. | 0x0000 |

Data channel map 1 (middle word) register

| Addr | Addr | Register Name | RW | Description | Reset |
|------|------|---------------|----|-------------|-------|
|------|------|---------------|----|-------------|-------|

Table continues on the next page...

Radio Register Overview

| 16-bit | 32-bit | | | | |
|--------|--------|------------------|----|---|--------|
| 0x4E | 0x09C | DATA_CHANNELS_M1 | RW | Stores the channel map for channels[31:16]. The register is updated by firmware whenever a new/updated channel map is available for the connection. | 0x0000 |

| Field | Bit | Description | Reset |
|---------------|------|---|--------|
| Data_channels | 15:0 | This register field indicates which of the data channels are in use. This stores the information for the middle 16 data channel indices. '1' indicates the corresponding data channel is used and '0' indicates the channel is unused. | 0x0000 |

Data channel map 1 (upper word) register

| Addr 16-bit | Addr 32-bit | Register Name | RW | Description | Reset |
|----------------|----------------|------------------|----|---|--------|
| 0x50 | 0x0A0 | DATA_CHANNELS_H1 | RW | Stores the channel map for channels[36:32]. The register is updated by firmware whenever a new/updated channel map is available for the connection. | 0x0000 |

| Field | Bit | Description | Reset |
|---------------|------|--|-------|
| Data_channels | 15:5 | Unused | 0 |
| Data_channels | 4:0 | This register field indicates which of the data channels are in use. This stores the information for the upper 5 data channel indices. | 0x00 |

| | | | |
|--|--|---|--|
| | | '1' indicates the corresponding data channel is used and '0' indicates the channel is unused. | |
|--|--|---|--|

Note: The Data channel map 0 and data channel map 1 are two sets of channel maps stored, common for all the connections. At any given time, only two maps can be maintained and the connections will use one of the two sets as indicated by the channel map index field in the CE_CNFG_STS registers specific to the link. Firmware must also manage to update this field along with the map.

Connection channel Status register

| Addr 16-bit | Addr 32-bit | Register Name | RW | Description | Reset |
|----------------|----------------|---------------|----|--|--------|
| 0x56 | 0x0AC | CONN_STATUS | RO | Indicates the status of the connection channel data path and other common connection channel operations. | 0x0000 |

| Field | Bit | Description | Reset |
|-------------------|-------|---|-------|
| Rx_packet_counter | 15:12 | This field stores the count for the number of receive packets in the receive FIFO that are still not ready by firmware. The counter value is incremented by hardware for every good packet it stores in the FIFO. After firmware reads a packet, it decrements the counter by issuing the PACKET_RECEIVED command from the commander. | 0 |
| Reserved | 11:0 | Reserved for future use | 0 |

Connection configuration register

| Addr 16-bit | Addr 32-bit | Register Name | RW | Description | Reset |
|----------------|----------------|---------------|----|-------------|-------|
| | | | | | |

Table continues on the next page...

Radio Register Overview

| | | | | | |
|------|-------|-------------|----|--|--------|
| 0xF0 | 0x1E0 | CONN_CONFIG | RW | This register fields can be set to configure the LLH in data transfer scenarios. | 0x631F |
|------|-------|-------------|----|--|--------|

| Field | Bit | Description | Reset |
|---------------------|-----|--|-------|
| pdu_index_auto_updt | 15 | <p>This bit enable the LL hardware to update the index of the PDU being queued in the data buffer.</p> <p>0x0- LL Hardware to update the index of the PDU being queued.</p> <p>0x1- LL firmware to update the index when PDU is queued.</p> | 0x0 |
| mask_suto_at_update | 14 | <p>This bit is used to enable/disable masking of internal hardware supervision timeout trigger when switching from old connection parameters to new parameters.</p> <p>1 - Enable</p> <p>0 - Disable</p> | 0x01 |
| extend_cu_tx_win | 13 | <p>This bit is used to enable/disable extending the additional rx window on slave side during connection update in event of packet miss at the update instant.</p> <p>1 - Enable</p> <p>0 - Disable</p> | 0x01 |
| slv_md_config | 12 | <p>Configuration is provided to send last data packet with MD bit set/zero or one (only for slave mode).</p> <p>SLV_MD_CONFIG bit has effect only when md_bit_ctr bit is not set</p> <p>0 – The MD bit is set based on the transmit buffer empty condition. The last packet goes with a MD bit set since the FIFO would not be empty as we have to retain the data in the buffer till we realize the ACK from the remote side.</p> | 0x0 |

Table continues on the next page...

| | | | |
|-----------|----|---|-----|
| | | 1 - MD bit will be controlled based on the availability of next data in the FIFO. So send last data packet with MD bit zero or one. If the data transmitted is the last packet in the FIFO the MD bit will be '0' in that packet. Only if the next location holds data then MD bit will be '1'. | |
| aww_en | 11 | This field indicates whether window widen optimization is enable or not. 0 – It indicates AWW is enable 1 – It indicates AWW is disable | 0x0 |
| sl_dsm_en | 10 | This resiter field indicates whether slave latency dsm is enable or not. 0 – It indicates SL_DSM is enable 1 – It indicates SL_DSM is disable | 0x0 |

| | | | |
|-------------------|---|--|-----|
| index_not_in_addr | 9 | This register field indicates whether connection index is present in address or not. 1 – Index is not in address 0 – Index is in address | 0x1 |
| Sw_cntrl_md | 8 | This register field indicates whether the MD (More Data) bit needs to be controlled by 'software' or, 'hardware and software logic combined'. 1 - MD bit is exclusively controlled by software, ie based on status of <i>CE_CNFG_STS_REGISTER[6 J] - md bit</i> . 0 - MD Bit in the transmitted pdu is controlled by software and hardware logic. MD bit is set in transmitted packet, only if the software has set the md bit in <i>CE_CNFG_STS_REGISTER[6]</i> and either of the following conditions is true, | 0x1 |

Radio Register Overview

| | | | |
|--|--|--|--|
| | | <ol style="list-style-type: none"> 1. If there are packets queued for transmission. 2. If there is an acknowledgement awaited from the remote side for the packet transmitted. | |
|--|--|--|--|

| | | | |
|-------------------|-----|--|-----|
| rx_intr_threshold | 7:4 | <p>This register field allows setting a threshold for the packet received interrupt to the firmware.</p> <p>For example if the value programmed is</p> <p>0x2 – then LLH will generate interrupt only on receiving the second packet.</p> <p>In any case if the received number of packets in a conn event is less than the threshold or there are still packets (less than threshold) pending in the Rx FIFO, LLH will generate the interrupt at the ce_close.</p> <p>Min value possible is 1. Max value depends on the Rx FIFO capacity.</p> | 0x1 |
| rx_pkt_limit | 3:0 | <p>Defines a limit for the number of Rx packets that can be received by the LLH. Default maximum value is 0xF. Minimum value shall be '1' or no packet will be stored in the Rx FIFO.</p> | 0xF |

Note:

The DUT should not send empty packets with MD bit set to 1. This will extend the connection event and increase the power consumption which is unnecessary. However there could be scenarios where maximum throughput is the target. In that case we would need to extend the connection event and allow additional time for the software to queue additional data. So both the behaviors are kept in the implementation and can be selected using md_bit_ctr (ie CONN_CONFIG[8]).

md_bit_ctr = 1 - MD bit is exclusively controlled by software.

If this bit is set, the MD bit in the transmitted packets is exclusively based on the status of md bit (CE_CNFG_STS_REGISTER[6]).

In this mode, empty packets with MD bit set would be transmitted by us during the time an acknowledgement is being processed in the other end. This feature will extend the connection event since the remote end host will get see the MD bit and so stays in the same connection event, and this will allow us more time for our software to process the acknowledgement and queue additional data from the host to hardware. This is useful when we need to maximize the data transmitted in a connection interval.

sw_cntrl_md = 0 - MD bit is controlled by software and hardware logic.

Note that MD bit is not set in the transmitted packet if software has not set the md bit in CE_CNFG_STS_REGISTER[6] as 0b.

In this mode of operation an empty packet will still be sent since the send status clearing and more data check is at same time.

Connection channel transmit power register

| Addr 16-bit | Addr 32-bit | Register Name | RW | Description | Reset |
|----------------|----------------|------------------|----|---|--------|
| 0xF2 | 0x1E4 | CONN_CH_TX_POWER | RW | Connection channel transmit power. This register controls transmit power on all connection channel transmissions. | 0x0000 |

| Field | Bit | Description | Reset |
|--------------------|-----|--|--------|
| Conn_tx_power[5:0] | 5:0 | Transmit power to be used for all packets transmitted on the connection channel. | 0x0000 |

Connection Interrupt mask register

| Addr 16-bit | Addr 32-bit | Register Name | RW | Description | Reset |
|----------------|----------------|----------------|----|---|--------|
| 0xF8 | 0x1F0 | CONN_INTR_MASK | RW | Connection Interrupt enable register. This register controls enabling of interrupts and other | 0x0000 |

Radio Register Overview

| | | | | | |
|--|--|--|--|-------------------------------------|--|
| | | | | enables common for all connections. | |
|--|--|--|--|-------------------------------------|--|

| Field | Bit | Description | Reset |
|--------------------------|-------|--|-------|
| ping_nearly_expired_intr | 15 | If this bit is set ping timer nearly expired interrupt is enabled. | 0 |
| ping_timer_expired_intr | 14 | If this bit is set ping timer expired interrupt is enabled. | 0 |
| Reserved | 13:10 | Unused. | 0 |
| rx_bad_pdu_int_en | 9 | If this bit is set packet receive bad pdu interrupt is enabled. Effective only when bit 6 is set. | 0 |
| rx_good_pdu_int_en | 8 | If this bit is set packet receive good pdu interrupt is enabled. Effective only when bit 6 is set. | 0 |
| conn_updt_intr_en | 7 | If this bit is set connection update interrupt is enabled. | 0 |
| ce_rx_int_en | 6 | If this bit is set interrupt is enabled for reception of packet in a connection event. Bit 8 and 9 are sub-mask bits below this mask. | 0 |
| ce_tx_ack_int_en | 5 | If this bit is set transmission acknowledgement interrupt is enabled: This interrupt is generated to indicate to the firmware that a non-empty packet transmitted is successfully acknowledged by the remote device. For negative acknowledgements from remote device, this interrupt indication is not generated. | 0 |
| close_ce_int_en | 4 | If this bit is set connection event closed interrupt is enabled. | 0 |
| start_ce_int_en | 3 | If this bit is set connection event start interrupt is enabled | 0 |
| map_updt_int_en | 2 | If this bit is set, channel map update interrupt is enabled. | 0 |
| conn_estb_int_en | 1 | If this bit is set connection establishment interrupt is enabled. | 0 |
| conn_cl_int_en | 0 | If this bit is set connection closed interrupt is enabled. | 0 |

Slave timing control register

| Addr 16-bit | Addr 32-bit | Register Name | RW | Description | Reset |
|----------------|----------------|--------------------------|----|---|--------|
| 0xFA | 0x1F4 | SLAVE_TIMING_C ONTROL | RW | Slave timing control register. This register controls slave related timing. | 0xBE96 |

| Field | Bit | Description | Reset |
|--------------------|------|---|-------|
| Slave_time_adj_val | 15:8 | Timing adjust value. The internal micro second counter is adjusted to this value whenever slave receives a good access address match at connection anchor point. This will ensure the slave gets synchronized to master timing. | 0xBE |
| Slave_time_set_val | 7:0 | Programmable adjust value to the clock counter when slave is connected | 0x96 |

Window widen for offset register

| Addr 16-bit | Addr 32-bit | Register Name | RW | Description | Reset |
|----------------|----------------|-------------------------|----|---|--------|
| 0xB2 | 0x164 | WINDOW_WIDEN_ WINOFF | RW | Window widen value corresponding to transmitwindowoffs et. Firmware calculates the possible drift due to transmitwindowoffs et to the first packet after connection/ connection update and programs the value into this register. The value is in microseconds. | 0x000A |

| Field | Bit | Description | Reset |
|----------|-------|-------------|-------|
| Reserved | 15:12 | Unused | |

Table continues on the next page...

Radio Register Overview

| | | | |
|--------------|------|--|-----|
| Window_widen | 11:0 | This field stores the additional number of microseconds the slave must conn_config its listening window to listen for a master packet for receiving the first packet after connection creation. This value is calculated based on the window offset value to the first anchor point. This is used at connection setup directly. During connection setup, this value is added with window_widen_intvl register value to calculate the window widening size. | 00A |
|--------------|------|--|-----|

Connection Index register

| Addr 16-bit | Addr 32-bit | Register Name | RW | Description | Reset |
|----------------|----------------|---------------|----|--|--------|
| 0x58 | 0x0B0 | CONN_INDEX | RW | <p>Index of the connection to which the connection-specific parameter is being written to or read from. Firmware shall update this register with proper index before writing/reading the connection-specific registers (refer to register summary before for the connection specific register set).</p> <p>This register is relevant only for multiple connection support. If multiple connection is supported but number of connections is made one then the register value needs to be kept 0x0.</p> | 0x0000 |

| Field | Bit | Description | Reset |
|-------|-----|-------------|-------|
|-------|-----|-------------|-------|

Table continues on the next page...

| | | | |
|---------------|------|---|---|
| RFU | 15:2 | Reserved | 0 |
| fw_conn_index | 1:0 | This field is used to index the multiple connections existing. Range is 0 to 1. 0x0 – Connection Engine 0 in LLH 0x1 – Connection Engine 1 in LLH | 0 |

Connection Interrupt clear register

| Addr 16-bit | Addr 32-bit | Register Name | RW | Description | Reset |
|----------------|----------------|-----------------|----|--|--------|
| 0x54 | 0x0A8 | CONN_INTR_CLEAR | WO | Clear connection interrupts. Write to the register to clear one more connection interrupts. This register is implemented per connection. To clear interrupt for a specific connection, connection index register must be programmed before writing to this register. | 0x0000 |

| Field | Bit | Description | Reset |
|-------------------------------|------|---|-------|
| conn_ping_timer_nearly_expire | 15 | If this bit is written with 1, it clears the conn_ping_timer_nearly_expire interrupt. | 0 |
| conn_ping_timer_expire | 14 | If this bit is written with 1, it clears the conn_ping_timer_expire interrupt. | 0 |
| Reserved | 13:8 | Unused | 0 |
| con_updt_done | 7 | If this bit is written with 1, it clears the connection updated interrupt. | 0 |
| ce_rx | 6 | If this bit is written with 1, it clears the connection event received interrupt. | 0 |

Table continues on the next page...

Radio Register Overview

| | | | |
|---------------|---|---|---|
| ce_tx_ack | 5 | If this bit is written with 1, it clears the ce transmission acknowledgement interrupt. | 0 |
| close_ce | 4 | If this bit is written with 1, it clears the connection event closed interrupt. | 0 |
| start_ce | 3 | If this bit is written with 1, it clears the connection event started interrupt. | 0 |
| map_updt_done | 2 | If this bit is written with 1, it clears the map update done interrupt. | 0 |
| conn_estb | 1 | If this bit is written with 1, it clears the connection established interrupt. | 0 |
| conn_closed | 0 | If this bit is written with 1, it clears the connection updated interrupt. | 0 |

Connection Interrupt status register

| Addr 16-bit | Addr 32-bit | Register Name | RW | Description | Reset |
|----------------|----------------|------------------|----|--|--------|
| 0x54 | 0x0A8 | CONN_INTR_STATUS | RO | Connection Interrupt status register. To read interrupt for a specific connection, connection index register must be programmed before reading from this register. | 0x0000 |

| Field | Bit | Description | Reset |
|-------------------------|-------|--|-------|
| ping_nearly_expird_intr | 15 | If this is set, it indicates that ping timer has nearly expired. | 0 |
| ping_timer_expird_intr | 14 | If this is set, it indicates that ping timer has expired. | 0 |
| rx_pdu_status | 13:11 | Status of PDU received. This information is valid along with receive interrupt. Xx1 – Bad Packet (packet with CRC error) 000 – empty PDU 010 - new data (non-empty) PDU | 0 |

Table continues on the next page...

| | | 110 – Duplicate Packet | |
|----------------|------|--|---|
| discon_status | 10:8 | Reason for disconnect – indicates the reason the link is disconnected by hardware. 001 – connection failed to be established 010 - supervision timeout 011 – kill connection by host 100 – kill connection after ACK transmitted 101 – PDU response timer expired | 0 |
| con_updt_done | 7 | This bit is set when the last connection event with previous connection parameters is reached. The bit is set immediately after the receive operation at the anchor point of the last connection event. | 0 |
| ce_rx | 6 | If this bit is set it indicates that a packet is received in the connection event. | 0 |
| ce_tx_ack | 5 | If this bit is set it indicates that the connection event transmission acknowledgement is received for the previous non-empty packet transmitted. | 0 |
| close_ce | 4 | If this bit is set it indicates that the connection event closed interrupt has happened. | 0 |
| start_ce | 3 | If this bit is set it indicates that the connection event started interrupt has happened. | 0 |
| map_updt_done | 2 | If this bit is set it indicates that the channel map update is completed at the instant specified by the firmware. | 0 |
| conn_estb_updt | 1 | If this bit is set it indicates that the connection has been established. The bit is also set when a connection update procedure is completed, at the start of the first anchor point with the updated parameters. | 0 |
| conn_closed | 0 | If this bit is set it indicates that the link is disconnected. | 0 |

Connection Interval register

Radio Register Overview

| Addr 16-bit | Addr 32-bit | Register Name | RW | Description | Reset |
|----------------|----------------|---------------|----|--|--------|
| 0x80 | 0x100 | CONN_INTERVAL | RW | Connection Interval registers. Firmware writes the connection interval specific to the connection. The connection index register must be programmed with index of the connection, before programming the register. | 0x0000 |

| Field | Bit | Description | Reset |
|---------------------|------|---|--------|
| connection Interval | 15:0 | The value configured in this register determines the spacing between the connection events. This shall be a multiple of 1.25 ms in the range of 7.5 ms to 4.0 s. | 0x0000 |

Supervision timeout register

| Addr 16-bit | Addr 32-bit | Register Name | RW | Description | Reset |
|----------------|----------------|---------------|----|---|--------|
| 0x82 | 0x104 | SUP_TIMEOUT | RW | Supervision timeout for the connection. The connection index register must be programmed with index of the connection, before programming the register. | 0x0000 |

| Field | Bit | Description | Reset |
|---------------------|------|---|--------|
| supervision_timeout | 15:0 | This field defines the maximum time between two received Data packet PDUs before the connection is considered lost. | 0x0000 |

| | | | |
|--|--|--|--|
| | | This shall be a multiple of 10 ms in the range of 100 ms to 32.0 s and it shall be larger than $(1 + \text{connSlaveLatency}) * \text{connInterval}$. | |
|--|--|--|--|

Slave Latency register

| Addr 16-bit | Addr 32-bit | Register Name | RW | Description | Reset |
|----------------|----------------|---------------|----|---|--------|
| 0x84 | 0x108 | SLAVE_LATENCY | RW | Slave latency for the connection. The connection index register must be programmed with index of the connection, before programming the register. | 0x0000 |

| Field | Bit | Description | Reset |
|---------------|------|--|--------|
| slave_latency | 15:0 | <p>The value configured in this field defines the number of consecutive connection events that the slave device is not required to listen for master.</p> <p>The value of <code>connSlaveLatency</code> should not cause a Supervision Timeout.</p> <p>This shall be an integer in the range of 0 to $((\text{connSupervision Timeout} / \text{connInterval}) - 1)$. <code>connSlaveLatency</code> shall also be less than 500.</p> | 0x0000 |

Connection event length register

| Addr 16-bit | Addr 32-bit | Register Name | RW | Description | Reset |
|----------------|----------------|---------------|----|---|--------|
| 0x86 | 0x10C | CE_LENGTH | RW | Connection event length for the connection. The connection index register must be | 0x0000 |

Radio Register Overview

| | | | | | |
|--|--|--|--|---|--|
| | | | | programmed with index of the connection, before programming the register. | |
|--|--|--|--|---|--|

| Field | Bit | Description | Reset |
|-------------------------|------|--|--------|
| Connection event Length | 15:0 | <p>This field defines the length of Connection event. This value is derived from the CE length HCI parameters received from the host. This determines the number of master transmit slots in a connection event, subject to either of the MD bits being set. If both MD bits are set to 0, this has no effect.</p> <p>Units : 625 us.</p> <p>Note: The connection event length as specified by the CE_LENGTH shall not exceed CONN_INTERVAL – 1.25 ms.</p> | 0x0000 |

The CE-length parameter, according to the Bluetooth specification, is the length of the connection event.

Take an example to illustrate this scenario:

Assume a connection with interval = 100ms. that the application has put allowed 20ms of CE-length.

Here, the CE-length can be up to 100ms (100ms - 150us to be exact).

If the connection is maintained for 5 minutes, there could be $10 \times 60 \times 5 = 3000$ connection-intervals.

The CE-length need not maintained constant during all the 3000 connection events.

Here are the typical cases that determine the value of CE-length:

(1) No data packets exchanged. we are just maintaining time and frequency synchronization. In this case, only a packet pair will be exchanged every connection interval. Here, CE-length = 1.

(2) Average of 10 packets to be sent per connection event.

We can pump data in multiple ways here:

2.1: Send data at uniform rate : In this case, the CE-length will be enough to accommodate 10 packets, which will take about 7ms. As this is less than application enforced limit of 20ms, we can comfortably push all the 10 data packets in this connection interval. So data will be pumped to the other BT device at the same rate as is received from my application.

2.2: Can send data in bursts. Assume that we accumulate data for 1 second and pump out at the end of 1 second (this is not done by our Bluetooth stack, the application needs to buffer the data). So, at 10th connection interval, we have 100 packets accumulated. We are now ready to pump this data. 100 packets take about 70 ms. This is above the application enforced 20ms. So, the hardware can pump data that can fill up 20ms. The remaining data will be deferred to the next connection interval.

So, in this case, you would see a CE-length spread over time like this (Per connection interval):

0,0,0,0,0,0,0,0,0,0, 20,20,20,10,0,0,0,0,0,0, 20,20,20,10,0,0,0,0,0,0,
20,20,20,10,0,0,0,0,0,0,

and so on.

(3) We are receiving data at the same rate as in (2). This case is to honor data sent by the other BT-device by giving it more time in the current connection interval.

In (2) and (3) you will see non-empty packets either transmitted or received. We can also utilize the CE-length for different reasons:

(4) A transaction is in progress, and we are expecting a response packet very soon. In this case, we may be exchanging only empty packets now, and in the next few packet-pairs.

In this case, you will the CE-length to be large, and a non-empty packet may not be exchanged in all the slots.

Access address (lower) register

| Addr 16-bit | Addr 32-bit | Register Name | RW | Description | Reset |
|----------------|----------------|--------------------------------|----|--|--------|
| 0x88 | 0x110 | PDU_ACCESS_AD DR_L_REGISTER | RW | Access address bits 15:0 for the connection. The connection index register must be programmed with index of the connection, before programming the register. | 0x0000 |

Radio Register Overview

| Field | Bit | Description | Reset |
|-------------------------------|------|--|--------|
| PDU Access Address Lower bits | 15:0 | This field defines the lower 16 bits of the access address for each Link layer connection between any two devices. | 0x0000 |

Access address (upper) register

| Addr 16-bit | Addr 32-bit | Register Name | RW | Description | Reset |
|----------------|----------------|----------------------------|----|---|--------|
| 0x8A | 0x114 | PDU_ACCESS_ADDR_H_REGISTER | RW | Access address bits 32:16 for the connection. The connection index register must be programmed with index of the connection, before programming the register. | 0x0000 |

| Field | Bit | Description | Reset |
|-------------------------------|------|---|--------|
| PDU Access Address Lower bits | 15:0 | This field defines the higher 16 bits of the access address for each Link layer connection between any two devices. | 0x0000 |

Connect Event Instant register

| Addr 16-bit | Addr 32-bit | Register Name | RW | Description | Reset |
|----------------|----------------|-----------------|----|--|--------|
| 0x8C | 0x118 | CONN_CE_INSTANT | RW | This is the instant used for connection update procedure and channel map update procedure. | 0x0000 |

| Field | Bit | Description | Reset |
|------------|------|--|--------|
| Ce_instant | 15:0 | This is the value of the free running Connection Event counter when the new parameters of 'connection update' and/or 'Channel map update' will be effective. Range : 0x0000 to 0xFFFF | 0x0000 |

Connect Event Counter register

| Addr 16-bit | Addr 32-bit | Register Name | RW | Description | Reset |
|----------------|----------------|-----------------|----|--|--------|
| 0x92 | 0x124 | CONN_CE_COUNTER | RO | This is the free running counter, connEventCounter as defined by Bluetooth spec. | 0x0000 |

| Field | Bit | Description | Reset |
|------------------------|------|---|--------|
| connectionEventCounter | 15:0 | Firmware will read the instantaneous Event counter from this register, during connection update and channel map update procedure. Firmware will use this value to calculate the instant from which the new parameters (for connection update and channel map update) will be effective. | 0x0000 |

Connection configuration & status register

| Addr 16-bit | Addr 32-bit | Register Name | RW | Description | Reset |
|----------------|----------------|----------------------|----|---|--------|
| 0x8E | 0x11C | CE_CNFG_STS_REGISTER | RW | <p>Connection specific configuration and status information register.</p> <p>This register facilitates the pause/resume mechanism of data PDUs by LL , typically used during "enable encryption" procedure.</p> <p>In case multiple connections are supported, "connection index register" has to be written by the f/w</p> | 0x0000 |

Radio Register Overview

| | | | | |
|--|--|--|--|--|
| | | | | before programming/reading this register |
|--|--|--|--|--|

| Field | Bit | Description | Reset |
|----------------------|-------|--|-------|
| current_pdu_index | 15:12 | Read Only field. The index of the transmit packet buffer that is currently in transmission/ waiting for transmission. | 0 |
| Reserved | 11 | Reserved for future use. | 0 |
| conn_active | 10 | Read Only field . This bit is '1' whenever the connection is active. | 0 |
| force_nesn0 | 9 | not used | 0 |
| pause_data | 8 | Pause data. 1 – pause data, 0 – do not pause. Pause the data transfer on the connection. The current_pdu_index in hardware does not move to next index until pause_data is cleared. | 0 |
| map_index/curr_index | 7 | Mixed info field. Written by firmware to select the channel map register set to be used by hardware for this connection. 1 – use channel map register set 1. 0 – use channel map register set 0. When firmware reads this field, it returns the current map index being used in hardware. | 0 |
| md | 6 | MD bit set to '1' indicates device has more data to be sent. | 0 |
| mas_slv | 5 | mas_slv bit set to '1' indicates that device is configured as a master or a slave. 1 – master, 0 – slave. | 0 |
| data_list_head_up | 4 | Update the first packet buffer index ready for transmission to start/resume data transfer after a pause. <u>The bit must be toggled every time the firmware needs to indicate the start/resume. This requires a read modify write operation.</u> | 0 |

Table continues on the next page...

| | | | |
|------------------------------------|-----|--|---|
| Data_list_index/ last_ack_index | 3:0 | Data list index for start/ resume. This field must be valid along with data_list_head_up and indicate the transmit packet buffer index at which the data is loaded. The default number of buffers in the IP is 5, but may be customized for a customer. The buffers are indexed 0 to 4. Hardware will start the next data transmission from the index indicated by this field. | 0 |
|------------------------------------|-----|--|---|

Next CE instant register

| Addr 16-bit | Addr 32-bit | Register Name | RW | Description | Reset |
|----------------|----------------|-----------------|----|--|--------|
| 0x90 | 0x120 | NEXT_CE_INSTANT | RO | 16-bit internal reference clock value at which the next connection event will occur on a connection. The connection index register must be programmed with index of the connection, before reading the register. | 0x0000 |

| Field | Bit | Description | Reset |
|---------|------|--|--------|
| Instant | 15:0 | 16-bit internal reference clock value at which the next connection event will occur on a connection. The connection index register must be programmed with index of the connection, before reading the register. | 0x0000 |

Connection parameter 1 register

| Addr | Addr | Register Name | RW | Description | Reset |
|------|------|---------------|----|-------------|-------|
|------|------|---------------|----|-------------|-------|

Table continues on the next page...

Radio Register Overview

| 16-bit | 32-bit | | | | |
|--------|--------|-------------|----|---|--------|
| 0xF4 | 0x1E8 | CONN_PARAM1 | RW | Connection parameters like sca, hop_increment and crc_init exchanged in connect_request of this connection. | 0x0000 |

| Field | Bit | Description | Reset |
|--------------------|------|---|-------|
| crc_init[7:0] | 15:8 | This field defines the lower byte (7:0) of the CRC initialization vector. | 0 |
| hop_increment[4:0] | 7:3 | Hop increment for connection channel. | |
| sca[2:0] | 2:0 | Sleep Clock accuracy value. | |

Connection parameter 2 register

| Addr 16-bit | Addr 32-bit | Register Name | RW | Description | Reset |
|----------------|----------------|---------------|----|--|--------|
| 0xF6 | 0x1EC | CONN_PARAM2 | RW | Connection parameter crc_init bits 24:7 exchanged in connect_request of this connection. The connection index register must be programmed with index of the connection, before reading the register. | 0x0000 |

| Field | Bit | Description | Reset |
|----------------|------|---|--------|
| crc_init[23:8] | 15:0 | This field defines the upper two bytes (23:8) of the CRC initialization vector. | 0x0000 |

Connection Update New Interval

| Addr 16-bit | Addr 32-bit | Register Name | RW | Description | Reset |
|----------------|----------------|---------------|----|-------------|-------|
|----------------|----------------|---------------|----|-------------|-------|

Table continues on the next page...

| | | | | | |
|-------|-------|--------------------------|----|---|--------|
| 0x1D2 | 0x3A4 | CONN_UPDATE_NEW_INTERVAL | RW | The connection interval that will be effective after the connection update instant. | 0x0000 |
|-------|-------|--------------------------|----|---|--------|

| Field | Bit | Description | Reset |
|-------------------------|------|---|--------|
| Conn_interval_new[15:0] | 15:0 | This register will have the new connection interval that the hardware will use after the connection update instant. Before the instant, the connection interval in the register CONN_INTERVAL will be used by hardware. | 0x0000 |

- Connection Update New Latency

| Addr 16-bit | Addr 32-bit | Register Name | RW | Description | Reset |
|----------------|----------------|-------------------------|----|---|--------|
| 0x1D4 | 0x3A8 | CONN_UPDATE_NEW_LATENCY | RW | The slave latency that will be effective after the connection update instant. | 0x0000 |

| Field | Bit | Description | Reset |
|-------------------------|------|---|--------|
| Slave_latency_new[15:0] | 15:0 | This register will have the new slave latency parameter that the hardware will use after the connection update instant. Before the instant, the connection interval in the register SLAVE_LATENCY will be used by hardware. | 0x0000 |

- Connection Update New Su To

| Addr 16-bit | Addr 32-bit | Register Name | RW | Description | Reset |
|----------------|----------------|-----------------------|----|---|--------|
| 0x1D6 | 0x3AC | CONN_UPDATE_NEW_SU_TO | RW | The Supervision timeout that will be effective after the connection update instant. | 0x0000 |

Radio Register Overview

| Field | Bit | Description | Reset |
|----------------------|------|---|--------|
| Conn_so_to_new[15:0] | 15:0 | This register will have the new supervision timeout that the hardware will use after the connection update instant. Before the instant, the connection interval in the register SUP_TIMEOUT will be used by hardware. | 0x0000 |

- Connection Update New slaveLatency x connInterval value

| Addr 16-bit | Addr 32-bit | Register Name | RW | Description | Reset |
|----------------|----------------|-----------------------------|----|---|--------|
| 0x1D8 | 0x3B0 | CONN_UPDATE_NEW_SL_INTERVAL | RW | The (slaveLatency * connInterval) value that will be effective after the connection update instant. | 0x0000 |

| Field | Bit | Description | Reset |
|----------------------------|------|--|--------|
| sl_conn_interval_new[15:0] | 15:0 | This register will have the new SL*CI value that the hardware will use after the connection update instant. Before the instant, the connection interval in the register SL_CONN_INTERVAL will be used by hardware. | 0x0000 |

Window Widen for Interval register

| Addr 16-bit | Addr 32-bit | Register Name | RW | Description | Reset |
|----------------|----------------|-----------------------|----|--|--------|
| 0xB0 | 0x160 | WINDOW_WIDEN_INTERVAL | RW | Window widening value based on connection interval of the connection. The connection index register must be programmed with index of the | 0x000A |

| | | | | | |
|--|--|--|--|--|--|
| | | | | connection, before reading the register. | |
|--|--|--|--|--|--|

| Field | Bit | Description | Reset |
|--------------|-------|--|--------|
| Reserved | 15:12 | Not used | |
| Window_widen | 11:0 | <p>This value defines the increased listening time for the slave.</p> <p>The windowWidening shall be smaller than $((\text{connInterval}/2) - T_IFS)$ us)</p> <p>This value is calculated by firmware based on the drift, the connection interval value. The value is the unit widening value for one connection interval duration. In case of slave latency, this value is accumulated till the next anchor point at which the slave will listen.</p> | 0x000A |

PDU response timer register

| Addr 16-bit | Addr 32-bit | Register Name | RW | Description | Reset |
|----------------|----------------|----------------|----|--|--------|
| 0x502 | 0xA04 | PDU_RESP_TIMER | RW | PDU response timer register. This timer is used to monitor the time to get the response for the control procedures for which timeout rules are specified in the specification. | 0x0000 |

| Field | Bit | Description | Reset |
|-------------------|------|---|-------|
| Pdu_resp_time_val | 15:0 | <p>This register is loaded with the count value to monitor the time to get a response for the control PDU sent to a peer device.</p> <p>Firmware starts the timer by issuing the command, RESP_TIMER_ON, after it</p> | 0 |

Radio Register Overview

| | | |
|--|--|---|
| | | <p>has queued a control PDU for transmission that requires a response.</p> <p>If a response is received, firmware stops and clears the timer by issuing the command RESP_TIMER_OFF.</p> <p>If this timer expires, it results in hardware closing the connection and triggering a conn_closed interrupt.</p> <p>The <i>discon_status</i> field in the Connection status register is set with the appropriate reason.</p> <p>Units : Milliseconds. Resolution : 1.25 ms</p> |
|--|--|---|

Next response timeout instant register

| Addr 16-bit | Addr 32-bit | Register Name | RW | Description | Reset |
|----------------|----------------|---------------------|----|--|--------|
| 0x504 | 0xA08 | NEXT_RESP_TIMER_EXP | RO | 16-bit internal reference clock value at which the next PDU response timeout event will occur on a connection. | 0x0000 |

| Field | Bit | Description | Reset |
|------------------------|------|--|--------|
| Next_resp_timer_expire | 15:0 | <p>This field defines the clock instant at which the next PDU response timeout event will occur on a connection.</p> <p>This is with reference to the 16-bit internal reference clock.</p> | 0x0000 |

Next Supervision timeout instant register

| Addr 16-bit | Addr 32-bit | Register Name | RW | Description | Reset |
|----------------|----------------|---------------|----|---|--------|
| 0x506 | 0xA0C | NEXT_SUP_TO | RO | 16-bit internal reference clock value at which the next supervision | 0x0000 |

| | | | | | |
|--|--|--|--|---|--|
| | | | | timeout event will occur on a connection. | |
|--|--|--|--|---|--|

| Field | Bit | Description | Reset |
|----------------------|------|---|--------|
| Next_timeout_instant | 15:0 | This field defines the clock instant at which the next connection supervision timeout event will occur on a connection. This is with reference to the 16-bit internal reference clock. | 0x0000 |

Data list SENT Status register

| Addr 16-bit | Addr 32-bit | Register Name | RW | Description | Reset |
|----------------|----------------|-----------------------|----|---|--------|
| 0x94 | 0x128 | DATA_LIST_SENT_STATUS | WO | The register is used by firmware to indicate that a packet buffer is queued (loaded) with data for transmission. Firmware sets a SENT bit in hardware corresponding to the packet buffer queued with a packet for transmission. | 0x0000 |

| Field | Bit | Description | Reset |
|-----------|------|--|-------|
| Reserved | 15:9 | Unused | 0 |
| Set/Clear | 8 | Used to set the SENT bit in hardware for the selected packet buffer. 1 – packet queued When firmware has a packet to send, firmware first loads the next available packet buffer. Then the hardware SENT bit is set by writing 1 to this bit field along with the list_index field that identified | 0 |

Table continues on the next page...

Radio Register Overview

| | | | |
|------------|-----|--|---|
| | | <p>the buffer index. This indicates that a packet has been queued in the data buffer for sending. This packet is now ready to be transmitted.</p> <p>The SENT bit in hardware is cleared by hardware only when it has received an acknowledgement from the remote device.</p> <p>Firmware typically does not clear the bit. However, It only clears the bit on its own if it needs to 'flush' a packet from the buffer, without waiting to receive acknowledgement from the remote device, firmware clears BIT7 along with the list_index specified.</p> <p>Note: This register has a different meaning in the Read-path</p> | |
| List_index | 7:0 | <p>Indicates the buffer index for which the SENT bit is being updated by firmware.</p> <p>The default number of buffers in the IP is 5. The index range is 0-4.</p> | 0 |

Data list ACK update register

| Addr 16-bit | Addr 32-bit | Register Name | RW | Description | Reset |
|----------------|----------------|----------------------|----|--|--------|
| 0x96 | 0x12C | DATA_LIST_ACK_STATUS | WO | Clear ACK indication for the packet, as reported by link layer hardware. | 0x0000 |

| Field | Bit | Description | Reset |
|-----------|------|--|--------|
| Reserved | 15:9 | Unused | 0x0000 |
| Set/clear | 8 | Firmware uses the field to clear the ACK bit in the hardware to indicate that the acknowledgement for the transmit packet has been received and processed by firmware. | 0 |

Table continues on the next page...

| | | | |
|------------|-----|--|---|
| | | <p>Firmware clears the ACK bit in the hardware by writing in this register only after the acknowledgement is processed successfully by firmware.</p> <p>For clearing ack for a packet transmitted in fifo-index : '3', firmware will write '3' in the 'list-index' field and set this bit (BIT7) to 0.</p> <p>This is the indication that the corresponding packet buffer identified by List-Index is cleared of previous transmission and can be re-used for another packet from now on.</p> <p>The ACK bit in hardware is set by hardware when it has successfully transmitted a packet.</p> <p>Note: This register has a different meaning in the Read-path</p> | |
| List_index | 7:0 | <p>Indicates the buffer index for which the ACK bit is being updated by firmware.</p> <p>The default number of buffers in the IP is 5. The index range is 0-4.</p> | 0 |

Data list SENT status register

| Addr 16-bit | Addr 32-bit | Register Name | RW | Description | Reset |
|----------------|----------------|-----------------------|----|---|--------|
| 0x94 | 0x128 | DATA_LIST_SENT_STATUS | RO | Status of SENT bit of all the transmit buffers available in the hardware. | 0x0000 |

| Field | Bit | Description | Reset |
|----------|------|--|--------|
| Reserved | 15:8 | Unused | 0x0000 |
| tx_sent | 7:0 | <p>The bits in this field indicate the status of the SENT bit in the hardware for each packet buffer. The bit values are</p> <p>1 – queued</p> | 0 |

Radio Register Overview

| | | |
|--|--|--|
| | | <p>0 – no packet / packet ack received by hardware</p> <p>Example1: If the read value is : 0x03, then packets in buffer 0 and buffer 1 are in the queue to be transmitted. All the other FIFOs are empty or hardware has cleared them after receiving acknowledgement.</p> |
|--|--|--|

Data list ACK update register

| Addr 16-bit | Addr 32-bit | Register Name | RW | Description | Reset |
|----------------|----------------|----------------------|----|--|--------|
| 0x96 | 0x12C | DATA_LIST_ACK_STATUS | RO | Status of ACK bit of all the transmit buffers available in the hardware. | 0x0000 |

| Field | Bit | Description | Reset |
|----------|------|---|--------|
| Reserved | 15:8 | Unused | 0x0000 |
| tx_ack | 7:0 | <p>If a particular bit is set, then the packet in the selected buffer has been transmitted (at least once) by the hardware and hardware is waiting for acknowledgement.</p> <p>Example1 : If the read value is : 0x03, then packets in FIFO-0 and FIFO-1 are acknowledged by the remote device. These acknowledgements are pending to be processed by firmware.</p> <p>Example2 : If the read value is : 0x02, then packet FIFO-1 is acknowledged by the remote device. This acknowledgement is pending to be processed by firmware.</p> <p>Note : This register has a different meaning in the Write-path.</p> | 0 |

The SENT bit and ACK bit have to be taken together to understand the meaning of packet status. The table below describes how the two bits are sequentially updated by either hardware/firmware to complete one data transmission.

| SENT | ACK | Description |
|------|-----|---|
| 0 | 0 | Buffer is empty. No packet is queued in the buffer |
| 1 | 0 | Packet is queued by firmware. |
| 1 | 1 | Packet is transmitted by hardware. Hardware is waiting for acknowledgement. |
| 0 | 1 | Hardware has received ACK. Firmware has not yet processed the ACK. |
| 0 | 0 | Firmware has processed the ack. The buffer is again empty. |

Device Data List Status Register

| Addr 16-bit | Addr 32-bit | Register Name | RW | Description | Reset |
|----------------|----------------|-------------------------|----|---|--------|
| 0x290 | 0x520 | DEVICE_DATA_LIST_STATUS | RO | Status of data packets queued and sent. | 0x0000 |

| Field | Bit | Description | Reset |
|-------------------------|------|--|--------|
| Reserved | 15:8 | Unused | 0x0000 |
| device_data_list_status | 7:0 | These bits the status of data packet queued and sent at device level. If the particular bit is set to '1' indicates that there either pending PDU in the queue or pending ACK to be cleared. Based on the status of this register FW will queue next PDU. Note : This register is used only in shared connection tx_fifo. | 0 |

Data list Index 0 register

| Addr | Addr | Register Name | RW | Description | Reset |
|------|------|---------------|----|-------------|-------|
|------|------|---------------|----|-------------|-------|

Table continues on the next page...

Radio Register Overview

| 16-bit | 32-bit | | | | |
|--------|--------|-------------|----|--------------------------|--------|
| 0x98 | 0x130 | LIST_INDEX0 | WO | Reserved for future use. | 0x0000 |

Data list Index 1 register

| Addr 16-bit | Addr 32-bit | Register Name | RW | Description | Reset |
|----------------|----------------|---------------|----|--------------------------|--------|
| 0x9A | 0x134 | LIST_INDEX1 | WO | Reserved for future use. | 0x0000 |

Data buffer descriptor 0-7 register

| Addr 16-bit | Addr 32-bit | Register Name | RW | Description | Reset |
|--|----------------|---|----|--|--------|
| 0xA0-0xAE | 0x140-0x15C | DATA_MEM_DESCRIPTOR0- DATA_MEM_DESCRIPTOR7 | RW | Descriptor for packet stored in the each of the transmit buffer which includes the packet specific information like length and LLID. | 0x0000 |
| DATA_MEM_DESCRIPTOR 5 to DATA_MEM_DESCRIPTOR 7 is RFU. | | | | | |

| Field | Bit | Description | Reset |
|-------------|------|---|-------|
| conn_handle | 15:8 | Unused. Reserved for future use. | 0x0 |
| Enc | 7 | Unused. Reserved for future use. | |
| Data_length | 6:2 | This field indicates the length of the data packet. Range: 0x0 to 0x1F. | 0 |
| LLID | 1:0 | The LLID indicates whether the packet is an LL Data PDU or an LL Control PDU. 00b= Reserved. 01b=LL Data PDU: Continuation fragment of an L2CAP message or an Empty PDU. 10b=LL Data PDU: Start of an L@CAP message or a complete L2CAP message with no fragmentation. | |

| | | | |
|--|--|---------------------|--|
| | | 11b=LL Control PDU. | |
|--|--|---------------------|--|

Feature Configuration register

| Addr 16-bit | Addr 32-bit | Register Name | RW | Description | Reset |
|----------------|----------------|------------------------|----|--|--------|
| 0x508 | 0xA10 | LLH_FEATURE_C ONFIG | RW | Enabling/Disabling of different features implemented in connection. | 0x0000 |

| Field | Bit | Description | Reset |
|----------------|-----|---|-------|
| Reserved | 7:2 | RFU | 0 |
| Quick_transmit | 0 | Quick transmit feature in slave latency is enabled by setting this bit. When slave latency is enabled, this feature enables the slave to transmit in the immediate connection interval, in case required, instead of waiting till the end of slave latency | 0 |

Adaptive Window Widening Config

| Addr 16-bit | Addr 32-bit | Register Name | RW | Description | Reset |
|----------------|----------------|---------------|----|--|--------|
| 0x50A | 0xA14 | AWW_CONFIG | RW | Enabling/Disabling of various AWW specific functions and AWW configurable parameters. | 0xE244 |

| Field | Bit | Description | Reset |
|------------------------|-----|---|-------|
| aww_error_tolerance_en | 15 | This bit enables/disables the access code bit error tolerance functionality. 1 – enable 0 - disable | 1 |

Table continues on the next page...

Radio Register Overview

| | | | |
|-------------------------|-------|--|------|
| aww_tolerance_threshold | 14:10 | This value sets the lower bound on tolerance of bit errors in access code to overlook AWW history recapture. Eg., 0x18 implies 32-24 = 8 bit errors are tolerable. | 0x18 |
| aww_alg_auto_switch_en | 9:9 | This bit is used to enable/disable the functionality of automatic switching between the AWW algorithms i.e The Conservative Mode and Greedy Mode. 1 – Enable 0 – Disable | 1 |
| aww_alg_sel | 8:8 | IF the AWW algorithm auto switch functionality is disabled, this bit is used to manually select the AWW algorithm to be used. 1 – Greedy Mode 0 – Conservative Mode | 0 |
| constancy_cnt_init_val | 7:4 | This value defines the number of connection events for which the adaptive window module checks if master anchor points variations fall within set threshold before switching from conservative mode to greedy mode. Valid Range : (0x1,0xf) | 0x04 |
| Obs_ce_cnt_init_val | 3:0 | This value defines the number of connection events for which the adaptive window module performs measurements of master anchor point swing before it applies the optimized window in accordance with conservative mode aww algorithm. Valid Range : (0x1,0xf) | 0x04 |

Slave Window Adjustment

| Addr 16-bit | Addr 32-bit | Register Name | RW | Description | Reset |
|----------------|----------------|---------------|----|---|--------|
| 0x50C | 0xA18 | SLV_WIN_ADJ | RW | Programmable adjust value to add to the calculated window widen | 0x0010 |

| | | | | | |
|--|--|--|--|--|--|
| | | | | value. This allows the firmware to add flexibility to calculated value of drift - to compensate for any underestimated drift in the manufacturer specification of crystal drift. | |
|--|--|--|--|--|--|

| Field | Bit | Description | Reset |
|-------------|-------|--|-------|
| Reserved | 15:11 | Unused | 0x00 |
| Slv_win_adj | 10:0 | Window Adjust value. This value is added to the calculated slave window widening value to be used as final window widen value. | 0x10 |

slaveLatency x connInterval value

| Addr 16-bit | Addr 32-bit | Register Name | RW | Description | Reset |
|----------------|----------------|----------------------|----|--|-------|
| 0x50E | 0xA1C | SL_CONN_INTER VAL | RW | Programmable Register which holds the (slaveLatency * connInterval) value for the connection. | |

| Field | Bit | Description | Reset |
|----------------------|------|---|--------|
| Sl_conn_interval_val | 15:0 | This field defines the (SL*CI) product for the ongoing connection. This value is used in calculation of next connection instant during slave latency. | 0x0000 |

LE Ping timer address register

| Addr | Addr | Register Name | RW | Description | Reset |
|------|------|---------------|----|-------------|-------|
|------|------|---------------|----|-------------|-------|

Table continues on the next page...

Radio Register Overview

| 16-bit | 32-bit | | | | |
|--------|--------|----------------------|----|--|--------|
| 0x510 | 0xA20 | CONN_PING_TIMER_ADDR | RW | <p>The register used to configure the LE Authenticated payload Timeout (LE APTO) which is the Maximum amount of time specified between packets authenticated by a MIC.</p> <p>This value of ping timer is in the order of 10ms, valid range 0x1 ~ 0xFFFF</p> | 0x0000 |

LE Ping connection timer offset

| Addr 16-bit | Addr 32-bit | Register Name | RW | Description | Reset |
|----------------|----------------|------------------------|----|--|--------|
| 0x512 | 0xA24 | CONN_PING_TIMER_OFFSET | RW | <p>The value of ping timer nearly expired offset in the order of 10ms, valid range 0x0 ~ 0xFFFF. This is the time period after which the ping timer nearly expired interrupt is generated.</p> | 0x0000 |

LE Ping timer next expiry instant

| Addr 16-bit | Addr 32-bit | Register Name | RW | Description | Reset |
|----------------|----------------|--------------------------|----|---|--------|
| 0x514 | 0xA28 | CONN_PING_TIMER_NEXT_EXP | RO | <p>The value of ping timer next expiry instant in the terms of native clock value (least 16 bit value of the 17 bit ping counter).</p> <p>This together with CONN_PING_TIMER_NEXT_EXP_W</p> | 0x0000 |

| | | | | | |
|--|--|--|--|---|--|
| | | | | RAP will provide the correct status of ping timer duration. | |
|--|--|--|--|---|--|

LE Ping timer next expiry wrap count

| Addr 16-bit | Addr 32-bit | Register Name | RW | Description | Reset |
|----------------|----------------|---------------------------|----|---|--------|
| 0x516 | 0xA2C | CONN_SEC_CUR RENT_WRAP | RO | This register holds the current position of the Ping timer. | 0x0000 |

| Field | Bit | Description | Reset |
|-----------------------|------|--|-------|
| RESERVED | 15:9 | RFU | 0x0 |
| CONN_SEC_NEAR_WRAP | 8:5 | This field provides the time offset of the nearly expired event from the authentication payload timeout event. This offset is in the order of 40959.375 ms and specifies the time offset after starting the ping timer the nearly expired event will be generated. Time= N*40959.375 ms. | 0x0 |
| CONN_SEC_CURRENT_WRAP | 4:1 | This field provides the current position of the ping timer and the value is in the order of 40959.375 ms. Time= N*40959.375 ms For Example if the APTO configured in 655,350 ms and this field returns 10, it means another 6 more units are remaining for the APTO event to be generated. | 0x0 |
| WRAP_VALID | 0 | This field will be '1' from nearly expired event to the authenticated payload timeout or till the next reload of the ping timer. | 0x0 |

Connection Arbiter Parameter register

| Addr 16-bit | Addr 32-bit | Register Name | RW | Description | Reset |
|----------------|----------------|---------------|----|-------------|-------|
| | | | | | |

Table continues on the next page...

Radio Register Overview

| | | | | | |
|-------|-------|---------------------|----|--|-----|
| 0x102 | 0x204 | CONN_ARB_PAR AMS | RO | Register holds the highest priority request to the connection arbiter from the connection engines. | 0xF |
|-------|-------|---------------------|----|--|-----|

| Field | Bit | Description | Reset |
|------------------|------|---|-------|
| Reserved | 15:4 | Not used | -- |
| priority_pointer | 3:0 | Pointer for the highest priority request to the connection arbiter. | 0xF |

Conn_SUTO_CI_Ratio register

| Addr 16-bit | Addr 32-bit | Register Name | RW | Description | Reset |
|----------------|----------------|------------------------|----|--|--------|
| 0x104 | 0x208 | CONN_SUTO_CI_ RATIO | RW | Firmware programs this register with connection supervision timeout to connection interval ratio at the time of connection creation/connection update. | 0x0000 |

| Field | Bit | Description | Reset |
|--------------------------|-------|--|--------|
| RFU | 15:13 | Not used | 0x0 |
| conn_suto_ci_ratio[12:0] | 12:0 | This register will have the ratio of the connection supervision timeout to the connection interval as programmed by the firmware before a connection creation or a connection update. The value is used by hardware to update the priority of a connection link that is nearing connection timeout due to packet miss. | 0x0000 |

Connection Priority Config register

| Addr | Addr | Register Name | RW | Description | Reset |
|------|------|---------------|----|-------------|-------|
|------|------|---------------|----|-------------|-------|

Table continues on the next page...

| | 32-bit | | | | |
|-------|--------|--------------------|----|---|--------|
| 0x106 | 0x20C | CONN_PRIORITY_CNFG | RW | This register is used by the firmware to override the hardware priority and set the priority of each connection link in the connection arbiter. The value of Zero has the least priority. | 0x0000 |

| Field | Bit | Description | Reset |
|--------------|------|---|-------|
| priority_sel | 15 | If this bit is set to '1' connection arbiter will use the firmware programmed priority set in this register for each connection engine. | 0 |
| RFU | 14:6 | Not used | 0x0 |
| fw_priority1 | 5:3 | Firmware programmed priority for connection engine 1. | 0x0 |
| fw_priority0 | 2:0 | Firmware programmed priority for connection engine 0. | 0x0 |

Connection Update New SUP_TO to CI ratio

| Addr | Addr 32-bit | Register Name | RW | Description | Reset |
|-------|----------------|---------------------------|----|--|--------|
| 0x1DA | 0x3B4 | CONN_UPDT_NEW_SU_CI_RATIO | RW | The Supervision Timeout to conn interval ratio that will be effective after the connection update instant. Firmware programs this register along with other connection update parameter registers. | 0x0000 |

| Field | Bit | Description | Reset |
|------------------------|-------|--|--------|
| RFU | 15:13 | Not used. | 0x0 |
| conn_suto_ci_ratio_new | 12:0 | This register will have the new supervision timeout to | 0x0000 |

Radio Register Overview

| | | |
|--|--|--|
| | | connection interval ratio that the hardware will use after the connection update instant. Before the instant, the value in the register CONN_SUTO_CI_RATIO will be used by hardware. |
|--|--|--|

Slave Window Offset Full register

| Addr 16-bit | Addr 32-bit | Register Name | RW | Description | Reset |
|----------------|----------------|---------------------|----|--|--------|
| 0x1DC | 0x3B8 | SL_WIN_OFF_F ULL | RW | This register is programmed with the maximum possible window widen value by the firmware when dsm entry during slave latency feature is enabled. This value is used by the hardware to calculate the next ce instant being reported to firmware. | 0x0000 |

| Field | Bit | Description | Reset |
|--------------------|------|--|--------|
| RFU | 15:6 | Not used. | 0x0 |
| sl_window_off_full | 5:0 | Value of maximum possible window widen programmed by the firmware when slave latency dsm feature is enabled. | 0x0000 |

Connection RSSI register

| Addr 16-bit | Addr 32-bit | Register Name | RW | Description | Reset |
|----------------|----------------|------------------|----|---|--------|
| 0x518 | 0xA30 | CONN_RX_RS SI | RO | This connection register holds the RSSI value of the last good (empty/non-empty) packet | 0x0000 |

| | | | | | |
|--|--|--|--|--------------------------------------|--|
| | | | | received by the specific connection. | |
|--|--|--|--|--------------------------------------|--|

| Field | Bit | Description | Reset |
|--------------|------|---|--------|
| conn_rx_rssi | 15:0 | RSSI during the last good packet received in the specific connection. | 0x0000 |

Connection Rx Memory read enable register

| Addr 16-bit | Addr 32-bit | Register Name | RW | Description | Reset |
|----------------|----------------|---------------------------------|----|---|--------|
| 0x522 | 0xA44 | LLH_MEM_READ_ENABLE_CONTROL_REG | WO | This register is used by the firmware to control read access to the connection Rx memory. | 0x0000 |

| Field | Bit | Description | Reset |
|--------------------|-------|--|-------|
| Reserved | 15:14 | Not Used | 0x0 |
| conn_rxmem_rd_ctrl | 0 | When this bit is '1', connection Rx memory is enabled. | 0 |

45.2.3.1.4 Test and Debug Registers

Test and Debug Register Descriptions for the Bluetooth Link Layer

DTM control register

| Addr 16-bit | Addr 32-bit | Register Name | RW | Description | Reset |
|----------------|----------------|-----------------|----|---|--------|
| 0xB8 | 0x170 | LE_RF_TEST_MODE | RW | LE Direct Test Mode (DTM) configuration and control register. Used to control the direct test mode (DTM) operation. | 0x0000 |

Radio Register Overview

| Field | Bit | Description | Reset |
|---------------------|-------|--|-------|
| Test_length[5:0] | 15:10 | 0x00-0x25 Length in bytes of payload data in each packet 0x3F – Continuous Transmit mode with 1010 pattern. 0x26-0xFF(except 0x3F) Reserved for future use | 0 |
| Pkt_payload[2:0] | 9:7 | Payload type as per the HCI parameter. 0x00 Pseudo-Random bit sequence 9 0x01 Pattern of alternating bits '11110000' 0x02 Pattern of alternating bits '10101010' 0x03 Pseudo-Random bit sequence 15 0x04 Pattern of All '1' bits 0x05 Pattern of All '0' bits 0x06 Pattern of alternating bits '00001111' 0x07 Pattern of alternating bits '0101' 0x08-0xFF Reserved for future use | 0 |
| Test_type | 6 | Mixed Info Field. Read: 1 – Indicates DTM test ON 0 – Indicates DTM test OFF Write: 1 – To enable continuous receive mode 0 – To disable continuous receive mode | 0 |
| Test_frequency[5:0] | 5:0 | $N = (F - 2402) / 2$ Range: 0x00 – 0x27. Frequency Range : 2402 MHz to 2480 MHz | 0 |

DTM receive packet count register

| Addr 16-bit | Addr 32-bit | Register Name | RW | Description | Reset |
|----------------|----------------|----------------------|----|---------------------------|--------|
| 0xBA | 0x174 | DTM_RX_PKT_CO UNT | RO | Count of the number of LE | 0x0000 |

| | | | | | |
|--|--|--|--|--|--|
| | | | | packets received when device is configured in receive test mode. | |
|--|--|--|--|--|--|

| Field | Bit | Description | Reset |
|-----------------------|------|--|-------|
| Rx_packet_count[15:0] | 15:0 | Number of packets received in receive test mode. | 0 |

Connection channel test control register

| Addr 16-bit | Addr 32-bit | Register Name | RW | Description | Reset |
|----------------|----------------|-------------------|----|--|--------|
| 0xBC | 0x178 | CONN_TEST_CONTROL | RW | Connection test control register. To introduce test behavior in the operation of connection. | 0x0000 |

| Field | Bit | Description | Reset |
|---------------------|------|---|-------|
| Reserved | 15:8 | Reserved for future use | 0 |
| Nonempty_pdu_rxnack | 7 | NACK the received packet, if rx packet is a NON-EMPTY PDU. 1 – Always NACK (no acknowledgement) 0 – No change from normal behavior | 0 |
| Empty_pdu_rxnack | 6 | NACK received packet, if rx packet is an EMPTY PDU. 1 – Always NACK 0 – No change from normal behavior | 0 |
| Nonempty_pdu_retx | 5 | Retransmit previous transmitted non-empty PDU irrespective of received NESN (whether acknowledged or not). 1 – Always retransmit 0 – No change from normal behavior | 0 |

Table continues on the next page...

Radio Register Overview

| | | | |
|------------------|---|---|---|
| empty_pdu_retx | 4 | Retransmit previous transmitted empty PDU irrespective of received NESN (whether acknowledged or not). 1 – Always retransmit 0 – No change from normal behavior | 0 |
| Nonempty_crc_err | 3 | Cause CRC field error in transmitted non-empty PDU (only). 1 – Causes CRC error 0 – no change from normal behavior | 0 |
| empty_crc_err | 2 | Cause CRC field error in transmitted empty PDU (only). 1 – Causes CRC error 0 – no change from normal behavior | 0 |
| Nonempty_acc_err | 1 | Causes Access address error in transmitted non-empty PDU. 1 – Causes access address error 0 – no change from normal behavior | 0 |
| empty_acc_err | 0 | Causes Access address error in transmitted empty PDU. 1 – Causes access address error 0 – no change from normal behavior | 0 |

Advertising channel test control register

| Addr 16-bit | Addr 32-bit | Register Name | RW | Description | Reset |
|----------------|----------------|--------------------|----|---|--------|
| 0xBE | 0x17C | ADVCH_TEST_CONTROL | RW | Advertising channel test control register. To introduce advertising channel test control operation. | 0x0000 |

| Field | Bit | Description | Reset |
|----------------|------|--|-------|
| Reserved | 15:7 | Reserved for future use | 0 |
| Scan_tx_hdr | 6 | Corrupt the tx header of SCAN_REQ packet 1 – corrupt the address 0 – no change | |
| Peer_addr_err | 5 | Corrupt the peer address field in the SCAN_REQ packet 1 – corrupt the address 0 – no change | 0 |
| Rcv_txaddr_err | 4 | Corrupt the received transmit address type indication 1 – corrupt the tx address type (invert the bit) 0 – no change | 0 |
| Scnrsp_tx_err | 3 | Introduce CRC error in scan response packet. 1 – corrupt CRC 0 – no change | 0 |
| Rx_crc_err | 2 | Receive packet CRC error indication. 1 – Indicate CRC error of received packet, irrespective of good/bad CRC 0 – No change from normal behavior | 0 |
| Tx_crc_err | 1 | Corrupt transmit packet CRC, irrespective of packet type. 1 – Corrupt CRC 0 – No change in normal behavior This is done by corrupting the crc_init value. | 0 |
| Tx_acc_err | 0 | Corrupt transmit packet access address. 1 – Corrupt access address 0 – No change in normal behavior | 0 |

DTM Error Count

| Addr 16-bit | Addr 32-bit | Register Name | RW | Description | Reset |
|----------------|----------------|---------------|----|-------------|-------|
|----------------|----------------|---------------|----|-------------|-------|

Table continues on the next page...

Radio Register Overview

| | | | | | |
|------|-------|-------------------|----|---|--------|
| 0xC0 | 0x180 | DTM_CRC_ERR_COUNT | RO | Indicates number of packets received with CRC error in the DTM mode | 0x0000 |
|------|-------|-------------------|----|---|--------|

| Field | Bit | Description | Reset |
|-----------------------|--------|--|-------|
| dtm_crc_err_pkt_count | [15:0] | DTM CRC error packet count. Used for Debug purpose only. | 0 |

Channel Address register

| Addr 16-bit | Addr 32-bit | Register Name | RW | Description | Reset |
|-------------|-------------|-------------------|----|--|--------|
| 0xC4 | 0x188 | CH_ADDR/ TXRX_HOP | RO | Contains value of the transmit and receive hop frequency | 0x0000 |

| Field | Bit | Description | Reset |
|-----------|--------|--|-------|
| reserved | 15 | Reserved for future use | 0 |
| hop_ch_rx | [14:8] | Receive channel index. Channel index on which previous packet is received. | 0 |
| reserved | 7 | Reserved for future use | 0 |
| hop_ch_tx | [6:0] | Transmit channel index. Channel index on which previous packet is transmitted. | 0 |

Divider Value Register for SCA

| Addr 16-bit | Addr 32-bit | Register Name | RW | Description | Reset |
|-------------|-------------|---------------|----|--|--------|
| 0x500 | 0xA00 | DIV_VAL_ADDR | RW | This value will go to divide by N module to derive various sleep clock frequencies | 0x1F3C |

| Reference Clock | Divider Value | Output Sleep Frequency(kHz) | PPM | SCA |
|-----------------|---------------|-----------------------------|------------|-----------|
| Decimal | Hex | | | |
| 16.384 kHz | 7808 | 1E80 | 16.39351 | 580.59674 |
| 7809 | 1E81 | 16.39135 | 448.73375 | 0 |
| 7810 | 1E82 | 16.38920 | 317.56129 | 0 |
| 7811 | 1E83 | 16.38722 | 196.25739 | 1 |
| 7812 | 1E84 | 16.38501 | 61.54619 | 4 |
| 7813 | 1E85 | 16.38287 | -69.19713 | 4 |
| 7814 | 1E86 | 16.38097 | -185.16635 | 1 |
| 7815 | 1E87 | 16.37870 | -323.70446 | 0 |
| 7816 | 1E88 | 16.37668 | -446.48984 | 0 |
| 16 kHz | 7996 | 1F3C | 16.00811 | 507.13706 |
| 7997 | 1F3D | 16.00610 | 380.94506 | 0 |
| 7998 | 1F3E | 16.00414 | 258.94704 | 0 |
| 7999 | 1F3F | 16.00221 | 137.93902 | 2 |
| 8000 | 1F40 | 15.99992 | -4.79998 | 7 |
| 8001 | 1F41 | 15.99786 | -133.74211 | 2 |
| 8002 | 1F42 | 15.99585 | -259.13283 | 0 |
| 8003 | 1F43 | 15.99392 | -380.01553 | 0 |
| 8004 | 1F44 | 15.99192 | -505.02482 | |

A macro 'SCA_DRIFT' is used to select the clock source for the Sleep Clock.

When the SCA_DRIFT macro is enabled then the sleep clock source is derived from the 64MHz based on the register DIV_VAL_ADDR setting. Otherwise sleep clock source is the on board 32.768 kHz

From 64 MHz of RF clock either 16 kHz or 16.384 kHz clock is derived using DCM (Digital Clock Manager, clock multiplier by 2) and a clock divider (divide by N). 64 MHz clock is given to DCM and this multiplied clock of 128 MHz is given to divide by N module. With 64 MHz clock only, it was not possible to cover lower, middle and upper range of required SCA (0 to 7) that led to use a DCM to get a higher clock and desired SCA values.

Clock divider value is given into a Programmable Read/Write register DIV_VAL_ADDR, whose address is 0x500 for 16 bit address bus.

Config.xml file is having all power up configuration parameters for BlueLite IP. This will be loaded into Hardware after Reset.

Radio Register Overview

For the validation, In order to introduce SCA other than '0' which is by default configuration of BlueLitE IP, one has to change corresponding "sca" field in config.xml file also. E.g. if one has selected SCA of 4 from table 2 given, then DIV_VAL_ADDR has to be programmed with 0x1E84 for positive ~61 PPM or 0x1E85 for negative ~69 PPM and "sca" field in config.xml has to be updated with 0x04.

Whenever SCA value is chosen from sleep clock frequency of 16 kHz, at that time internal adjustment for sleep clock frequency is not required. For that "clock_config" field in config.xml has to be updated with 0xA020.

DTM 2 wire UART Baud rate configuration

| Addr 16-bit | Addr 32-bit | Register Name | RW | Description | Reset |
|----------------|----------------|----------------------|----|---|--------|
| 0x580 | 0xB00 | DTM_2WIRE_CON FIG | RW | This value will go to different baud rate generator module for DTM 2 wire UART. | 0x006F |

| Field | Bit | Description | Reset |
|-----------------------|------|---|--------|
| dtm_2wire_baud_config | 15:0 | This value will be given to baud clock generator module. For different input clock frequency to LLH, this value will be different to generate corresponding baud clock as mentioned in below table. | 0x006F |

| Radio clock | Baud rate | Configuration Value |
|-------------|-----------|---------------------|
| 26 MHz | 1200 | 0x2A3B |
| 2400 | 0X151E | 0X19FA |
| 9600 | 0X0546 | |
| 14400 | 0X0384 | |
| 19200 | 0X02A1 | |
| 38400 | 0X0152 | |
| 57600 | 0X00E1 | |
| 115200 | 0X006F | |
| 32MHz | 1200 | |
| 2400 | 0X0CFE | 0X033E |
| 9600 | 0X033E | |

Table continues on the next page...

| | |
|--------|--------|
| 14400 | 0X0229 |
| 19200 | 0X019E |
| 38400 | 0X00D0 |
| 57600 | 0X008A |
| 115200 | 0X0042 |

45.2.3.1.5 Interface Registers

Interface Register Descriptions for the Bluetooth Link Layer

Receive trigger control register

| Addr 16-bit | Addr 32-bit | Register Name | RW | Description | Reset |
|----------------|----------------|-----------------------|----|--|--------|
| 0XFC | 0X1F8 | RECEIVE_TRIG_C TRL | RW | Receivers trigger control register. The threshold value for access address match, the access match trigger timeout is programmed to this register by firmware. | 0x0000 |

| Field | Bit | Description | Reset |
|-----------------------|------|---|-------|
| Acc_trigger_timeout | 15:8 | If access address match does not occur then within this time from the start of receive operation, the receive operation times out and stops. An internal counter value of 1usec resolution is continuously compared with the value programmed. Max value :0Xff | 0 |
| Reserved | 7 | Not used—RFU | 0 |
| | 6 | RFU | |
| Acc_trigger_threshold | 5:0 | Access address match threshold value. Number of bits of access address that should match with the expected access address to trigger an access code match. | 0 |

Radio Register Overview

| | | |
|--|--|---|
| | | <p>Max value : 32 (for 32-bit access address)</p> <p>Lower values may be programmed for bad radios or channels but care must be taken to ensure there are no 'false' matches due to reduced number of bits required to match.</p> <p>NOTE: BQB spec mandates this to be 32. So ensure that the standard versions have 32. For debugging or RF tuning, we can experiment with smaller values.</p> |
|--|--|---|

Transmit/Receive data delay Register

| | | | | | |
|------|-------|----------------|----|--|--------|
| 0xC8 | 0x190 | TX_RX_ON_DELAY | RW | Controls the delay in link layer from internal reference point, to start the transmit and receive operation. | 0x0000 |
|------|-------|----------------|----|--|--------|

| Field | Bit | Description | Reset |
|-----------------|------|---|-------|
| Txon_delay[7:0] | 15:8 | Transmit delay – Delay from internal trigger of transmit to transmission of first bit on air. It is used to control the T_IFS. The delay is in resolution of 1 microsecond. | 0x00 |
| Rxon_delay[7:0] | 7:0 | Receive delay – Delay from start of receive to expected first bit of receive packet at the controller. Used to control the turn on time of radio to optimize on power. The delay is in resolution of 1 microsecond. | 0x00 |

Transmit/receive synthesizer delay register

| | | | | | |
|------|-------|-------------------|----|---|--------|
| 0xCC | 0x198 | TX_RX_SYNTH_DELAY | RW | Controls the link layer behavior after waiting for TSM Warmup Time. | 0x0000 |
|------|-------|-------------------|----|---|--------|

| Field | Bit | Description | Reset |
|---------------------|------|--|-------|
| Tx_synth_delay[7:0] | 15:8 | Transmit synthesizer delay – For KW41 this value is derived from equation in XCVR_INIT based solely on TSM TX warmup time. | 0x00 |
| Rx_synth_delay[7:0] | 7:0 | Receive synthesizer delay – For KW41 this value is derived from equation in XCVR_INIT based solely on TSM RX warmup time. | 0x00 |

RSSI Register

| | | | | | |
|------|-------|-----------------|----|---|--------|
| 0xD8 | 0x1B0 | RADIO_RSSI_READ | RO | Indicates the RSSI value read from the radio for the last packet received. Mixed-info-field/register | 0x0000 |
|------|-------|-----------------|----|---|--------|

| Field | Bit | Description | Reset |
|-----------|------|--|-------|
| Rssi_data | 15:0 | Indicates the RSSI value read from the radio for the last packet received. The meaning is specific to the RF IC used. Mixed-info-field/register | 0x0 |

BLE_RF_ACTIVE_PERIOD register

| | | | | | |
|------|-------|----------------------|----|--|--------|
| 0x5A | 0x0B4 | ble_rf_active_period | RW | <ul style="list-style-type: none"> Register to specify the time offset before the start of a transceiver operation (i.e., a Tx/Rx) at which "BLE_RF_ACTIVE" output signal shall be asserted by the LLH. The purpose of the "BLE_RF_ACTIVE" signal is to indicate to the host of any upcoming transceiver activity. The host may schedule not to do any power intensive operations during this time to reduce the system peak power. BLE_RF_ACTIVE is a preemption signal for the system power management system to be ready for the upcoming radio operation. The time offset is specified in the units of BT slots (625us). | 0x0000 |
|------|-------|----------------------|----|--|--------|

Radio Register Overview

| | | | |
|--|--|--|--|
| | | | <p>NOTE: The BLE_RF_ACTIVE signal will be asserted at the specified time offset before a transceiver operation and remain asserted till the end of the operation.</p> <p>NOTE: During multichannel advertising the BLE_RF_ACTIVE signal will only remain asserted for the first channel event. Subsequent channel events will not generate a BLE_RF_ACTIVE signal. The system power management should use this first BLE_RF_ACTIVE signal to transition to ready state for the duration of the multichannel advertising event.</p> |
|--|--|--|--|

| Field | Bit | Description | Reset |
|---------------------|------|---|-------|
| Reserved | 15:7 | RFU | xx |
| ble_rf_active_slots | 6 | Polarity bit for ble_rf_active 0: active high 1: active low. | |
| ble_rf_active_slots | 5:0 | Number of BT slots (625 us) in advance of the actual start of the slot (tx/Rx) to assert ble_rf_active. "ble_rf_active" is always de-asserted when the value is 6'h0 (all zeros) and always asserted when the value is 6'h3F(all ones) Therefore the Min. value is 625 us and the Max value is 62*625 us. | 0 |

45.2.3.1.6 Instruction Set

Instruction Set Description for the Bluetooth Link Layer

Instruction Set

| Command | Opcode | Description |
|-----------|--------|---|
| START_ADV | 0x40 | Start Advertiser operation. The associated Advertiser configuration registers are programmed before the command is issued. |

Table continues on the next page...

| | | |
|---------------------|------|--|
| | | [refer to llh_set_adv_parameters function in lec_llh/simulation/llh_driver/ll_hardware_api.c file] |
| STOP_ADV | 0x41 | Stop advertiser operation. |
| START_SCAN | 0x42 | Start scanner operation. The associated configuration registers must be programmed before the command is issued. [refer to llh_set_scan_parameters function in lec_llh/simulation/llh_driver/ll_hardware_api.c file] |
| STOP_SCAN | 0x43 | Stop the scanner operation. |
| START_INIT | 0x44 | Start connection creation operation. The associated configuration registers must be programmed before the command is issued. [refer to create_connection function in lec_llh/simulation/llh_driver/ll_hardware_api.c file] |
| STOP_INIT | 0x45 | Cancel connection creation operation. |
| DTM_TX_START | 0x46 | Start Direct Test Mode Transmit Test. The associated configuration registers must be programmed before the command is issued. [refer to dtm_tx_test function in lec_llh/simulation/llh_driver/ll_hardware_api.c file] |
| DTM_RX_START | 0x47 | Start Direct Test Mode Receive Test. The associated configuration registers must be programmed before the command is issued. [refer to dtm_rx_test function in lec_llh/simulation/llh_driver/ll_hardware_api.c file] |
| DTM_STOP | 0x48 | Stop Direct Test Mode. |
| UPDATE_CHAN_MAP | 0x4B | Update channel map for the connection. |
| UPDATE_CONN_INSTANT | 0x4C | Start connection update procedure for the connection. |
| PACKET_RECEIVED | 0x4D | Indicates a received connection packet is read by firmware from connection receive FIFO. |
| ENTER_DSM | 0x50 | Enter deep sleep mode. |
| ENTER_SM | 0x51 | Enter sleep mode. |
| EXIT_SM | 0x52 | Exit sleep mode |

Table continues on the next page...

Radio Register Overview

| | | |
|----------------------|------|---|
| ENC_CLK_ON | 0x53 | Turn on clock to encryption block |
| ENC_CLK_OFF | 0x54 | Turn off clock to encryption block |
| ADV_CLK_ON | 0x55 | Turn on clock to advertiser block in NAP mode. |
| ADV_CLK_OFF | 0x56 | Turn off clock to advertiser block in NAP mode. |
| SCAN_CLK_ON | 0x57 | Turn on clock to scanner block in NAP mode. |
| SCAN_CLK_OFF | 0x58 | Turn off clock to scanner block in NAP mode. |
| INIT_CLK_ON | 0x59 | Turn on clock to initiator block in NAP mode. |
| INIT_CLK_OFF | 0x5a | Turn off clock to initiator block in NAP mode. |
| CONN_CLK_ON | 0x5b | Turn on clock to connection block in NAP mode. |
| CONN_CLK_OFF | 0x5c | Turn off clock to connection block in NAP mode. |
| UPDATE_CONN | 0x68 | Update connection parameters. Deprecated. |
| KILL_CONN | 0x70 | Kill connection immediately. |
| KILL_CONN_AFTER_TX | 0x71 | Kill connection after a transmit operation is over. |
| RESET_US_COUNTER | 0xc3 | Reset microsecond counter |
| RESP_TIMER_ON | 0x72 | Start PDU response timer. The PDU_RESP_TIMER register must be programmed with timeout value before issuing this command. |
| RESP_TIMER_OFF | 0x73 | Stop PDU response timer. |
| RESET_READ_PTR | 0x74 | Reset the white list memory read pointer to 0. |
| *CONN_PING_TIMER_ON | 0x75 | Start connection ping timer |
| *CONN_PING_TIMER_OFF | 0x76 | Stop connection ping timer |
| ENTER_DSM_SHUTDOWN | 0x77 | Enter deep sleep mode with shutdown |
| STORE_START | 0x78 | Firmware triggers the store process |
| RESTORE_START | 0x79 | Firmware triggers the restore process |
| DATA_RESTORE_ON | 0x7A | Firmware data restore enable |
| DATA_RESTORE_OFF | 0x7B | Firmware data restore disable |
| START_RPA_TIMER | 0x7C | Start Privacy RPA timer |
| STOP_RPA_TIMER | 0x7D | Stop Privacy RPA timer |
| START_RPA_GEN | 0x7E | Start RPA address generation |

45.2.3.2 BLE_RF Register Descriptions

45.2.3.2.1 BTLE_RF Memory Map

| Offset | Register | Width (In bits) | Access | Reset value |
|-----------|--|--------------------|--------|------------------|
| 4005B600h | BLUETOOTH LOW ENERGY PART ID (BLE_PART_ID) | 16 | RO | 0003h |
| 4005B604h | BLE DSM STATUS (DSM_STATUS) | 16 | RO | See description. |
| 4005B608h | BLUETOOTH LOW ENERGY MISCELLANEOUS CONTROL (MISC_CTRL) | 16 | RW | 0000h |

45.2.3.2.2 BLUETOOTH LOW ENERGY PART ID (BLE_PART_ID)

45.2.3.2.2.1 Address

| Register | Offset |
|-------------|-----------|
| BLE_PART_ID | 4005B600h |

45.2.3.2.2.2 Diagram

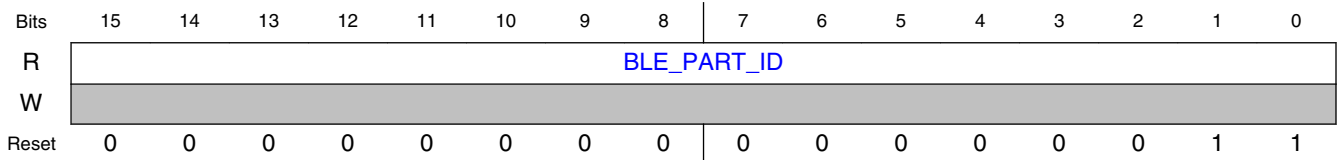

45.2.3.2.2.3 Fields

| Field | Function |
|---------------------|---|
| 15-0 BLE_PART_ID | BLE Part ID 0000000000000000b - Pre-production 0000000000000001b - Pre-production 0000000000000010b - KW40Z 0000000000000011b - KW41Z |

45.2.3.2.3 BLE DSM STATUS (DSM_STATUS)

45.2.3.2.3.1 Address

| Register | Offset |
|------------|-----------|
| DSM_STATUS | 4005B604h |

45.2.3.2.3.2 Function

BLE Deep Sleep Mode Status Register

45.2.3.2.3.3 Diagram

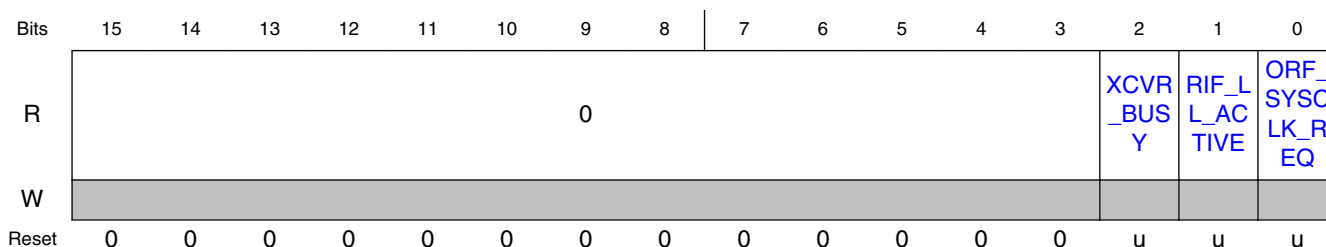

45.2.3.2.3.4 Fields

| Field | Function |
|----------------------|---|
| 15-3 — | Reserved. |
| 2 XCVR_BUSY | Transceiver Busy Status Bit 0b - RF Channel in available (TSM is idle) 1b - RF Channel in use (TSM is busy) |
| 1 RIF_LL_ACTIVE | Link Layer Active Reflects the state of the BLE LL output of the same name, the signal to be used by the host as an 'early' indication to prevent host to do any operations while the BLE block is doing transceiver operations, so as to reduce the peak power and noise. |
| 0 ORF_SYSCCLK_REQ | RF Oscillator Requested Reflects the state of the BLE LL output of the same name, the control signal used to enable/disable the RF Oscillator for entry and exit from DSM (deep sleep mode). |

45.2.3.2.4 BLUETOOTH LOW ENERGY MISCELLANEOUS CONTROL (MISC_CTRL)

45.2.3.2.4.1 Address

| Register | Offset |
|-----------|-----------|
| MISC_CTRL | 4005B608h |

45.2.3.2.4.2 Function

BLE Miscellaneous Control Register

45.2.3.2.4.3 Diagram

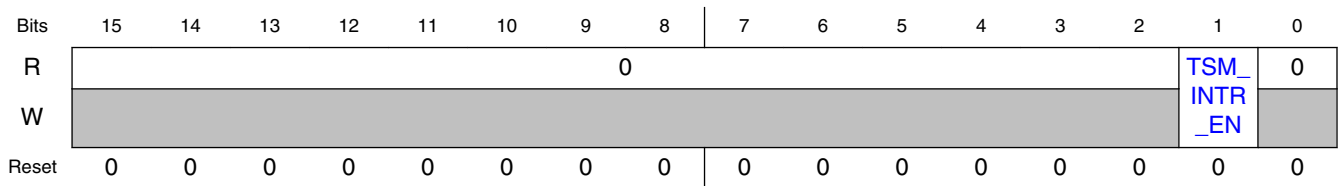

45.2.3.2.4.4 Fields

| Field | Function |
|------------------|--|
| 15-2 — | Reserved. |
| 1 TSM_INTR_EN | TSM Interrupt Enable This control bit enables the TSM Interrupt for BLE. If TSM_INTR_EN=1 and a TSM Interrupt occurs during a BLE TX or RX operation, bit [8] of the BLE_EVENT_STATUS register will become set. 0b - a TSM Interrupt during a BLE TX or RX sequence will not set bit [8] of BLE_EVENT_STATUS 1b - a TSM Interrupt during a BLE TX or RX sequence will set bit [8] of BLE_EVENT_STATUS |
| 0 — | Reserved. |

45.2.3.3 ZLL Register Descriptions

45.2.3.3.1 ZLL Memory Map

| Offset | Register | Width (In bits) | Access | Reset value |
|-----------|---|--------------------|--------|------------------|
| 4005D000h | INTERRUPT REQUEST STATUS (IRQSTS) | 32 | RW | See description. |
| 4005D004h | PHY CONTROL (PHY_CTRL) | 32 | RW | 0805FF00h |
| 4005D008h | EVENT TIMER (EVENT_TMR) | 32 | RW | See description. |
| 4005D00Ch | TIMESTAMP (TIMESTAMP) | 32 | RO | See description. |
| 4005D010h | T1 COMPARE (T1CMP) | 32 | RW | 00FFFFFFh |
| 4005D014h | T2 COMPARE (T2CMP) | 32 | RW | 00FFFFFFh |
| 4005D018h | T2 PRIME COMPARE (T2PRIMECMP) | 32 | RW | 0000FFFFh |
| 4005D01Ch | T3 COMPARE (T3CMP) | 32 | RW | 00FFFFFFh |
| 4005D020h | T4 COMPARE (T4CMP) | 32 | RW | 00FFFFFFh |
| 4005D024h | PA POWER (PA_PWR) | 32 | RW | 00000000h |
| 4005D028h | CHANNEL NUMBER 0 (CHANNEL_NUM0) | 32 | RW | 00000012h |
| 4005D02Ch | LQI AND RSSI (LQI_AND_RSSI) | 32 | RO | See description. |
| 4005D030h | MAC SHORT ADDRESS 0 (MACSHORTADDRS0) | 32 | RW | FFFFFFFFh |
| 4005D034h | MAC LONG ADDRESS 0 LSB (MACLONGADDRS0_LSB) | 32 | RW | FFFFFFFFh |
| 4005D038h | MAC LONG ADDRESS 0 MSB (MACLONGADDRS0_MSB) | 32 | RW | FFFFFFFFh |
| 4005D03Ch | RECEIVE FRAME FILTER (RX_FRAME_FILTER) | 32 | RW | See description. |
| 4005D040h | CCA AND LQI CONTROL (CCA_LQI_CTRL) | 32 | RW | 0866004Bh |
| 4005D044h | CCA2 CONTROL (CCA2_CTRL) | 32 | RW | See description. |
| 4005D04Ch | DSM CONTROL (DSM_CTRL) | 32 | RW | 00000000h |
| 4005D050h | BSM CONTROL (BSM_CTRL) | 32 | RW | 00000000h |
| 4005D054h | MAC SHORT ADDRESS FOR PAN1 (MACSHORTADDRS1) | 32 | RW | FFFFFFFFh |
| 4005D058h | MAC LONG ADDRESS 1 LSB (MACLONGADDRS1_LSB) | 32 | RW | FFFFFFFFh |
| 4005D05Ch | MAC LONG ADDRESS 1 MSB (MACLONGADDRS1_MSB) | 32 | RW | FFFFFFFFh |
| 4005D060h | DUAL PAN CONTROL (DUAL_PAN_CTRL) | 32 | RW | See description. |
| 4005D064h | CHANNEL NUMBER 1 (CHANNEL_NUM1) | 32 | RW | 0000007Fh |
| 4005D068h | SAM CONTROL (SAM_CTRL) | 32 | RW | 80804000h |
| 4005D06Ch | SOURCE ADDRESS MANAGEMENT TABLE (SAM_TABLE) | 32 | RW | See description. |
| 4005D070h | SOURCE ADDRESS MANAGEMENT MATCH (SAM_MATCH) | 32 | RO | See description. |
| 4005D074h | SAM FREE INDEX (SAM_FREE_IDX) | 32 | RO | See description. |
| 4005D078h | SEQUENCE CONTROL AND STATUS (SEQ_CTRL_STS) | 32 | RW | See description. |

Table continues on the next page...

| Offset | Register | Width (In bits) | Access | Reset value |
|--------------------------|---|--------------------|--------|------------------|
| 4005D07Ch | ACK DELAY (ACKDELAY) | 32 | RW | 00000007h |
| 4005D080h | FILTER FAIL CODE (FILTERFAIL_CODE) | 32 | RW | See description. |
| 4005D084h | RECEIVE WATER MARK (RX_WTR_MARK) | 32 | RW | 000000FFh |
| 4005D08Ch | SLOT PRELOAD (SLOT_PRELOAD) | 32 | RW | 00000074h |
| 4005D090h | 802.15.4 SEQUENCE STATE (SEQ_STATE) | 32 | RO | See description. |
| 4005D094h | TIMER PRESCALER (TMR_PRESCALE) | 32 | RW | 00000005h |
| 4005D098h | LENIENCY LSB (LENIENCY_LSB) | 32 | RW | 00000000h |
| 4005D09Ch | LENIENCY MSB (LENIENCY_MSB) | 32 | RW | 00000000h |
| 4005D0A0h | PART ID (PART_ID) | 32 | RO | 00000002h |
| 4005D100h - 4005D17Eh | Packet Buffer TX (PKT_BUFFER_TX0 - PKT_BUFFER_TX63) | 16 | RW | See description. |
| 4005D180h - 4005D1FEh | Packet Buffer RX (PKT_BUFFER_RX0 - PKT_BUFFER_RX63) | 16 | RW | See description. |

45.2.3.3.2 INTERRUPT REQUEST STATUS (IRQSTS)

45.2.3.3.2.1 Address

| Register | Offset |
|----------|-----------|
| IRQSTS | 4005D000h |

45.2.3.3.2.2 Function

The IRQSTS register indicates the status of interrupt requests in the 802.15.4 module.

45.2.3.3.2.3 Diagram

| | | | | | | | | | | | | | | | | |
|-------|----|-----------------|----|----|----|----|----|----|----------|----------|----------|----------|----------|----------|----------|----------|
| Bits | 31 | 30 | 29 | 28 | 27 | 26 | 25 | 24 | 23 | 22 | 21 | 20 | 19 | 18 | 17 | 16 |
| R | 0 | RX_FRAME_LENGTH | | | | | | | TMR4 MSK | TMR3 MSK | TMR2 MSK | TMR1 MSK | TMR4 IRQ | TMR3 IRQ | TMR2 IRQ | TMR1 IRQ |
| W | | | | | | | | | | | | | w1c | w1c | w1c | w1c |
| Reset | 0 | u | u | u | u | u | u | u | 1 | 1 | 1 | 1 | u | u | u | u |

| | | | | | | | | | | | | | | | | |
|-------|-----------|-----|----------|----|-----------------|---------|---|----------|---------------|------------------|-------------------|----------------|---------|--------|--------|---------|
| Bits | 15 | 14 | 13 | 12 | 11 | 10 | 9 | 8 | 7 | 6 | 5 | 4 | 3 | 2 | 1 | 0 |
| R | CRC VALID | CCA | SRCA DDR | PI | ENH_PKT_STAT US | TSM_IRQ | 0 | WAKE_IRQ | RX_F RM_P END | PLL_UNLO CK_I RQ | FILTE RFAI L_IR Q | RXW TRM RKIR Q | CCAI RQ | RXIR Q | TXIR Q | SEQI RQ |
| W | | | | | | | | w1c | | w1c | w1c | w1c | w1c | w1c | w1c | w1c |
| Reset | u | u | u | u | u | u | 0 | u | u | u | u | u | u | u | u | u |

45.2.3.3.2.4 Fields

| Field | Function |
|--------------------------|--|
| 31 — | Reserved. |
| 30-24 RX_FRAME_LENGTH | Receive Frame Length Contents of the PHR (PHY header), or FrameLength field, of the most recently received packet. Read-only. |
| 23 TMR4MSK | Timer Comperator 4 Interrupt Mask bit 0b - allows interrupt when comparator matches event timer count 1b - Interrupt generation is disabled, but a TMR4IRQ flag can be set |
| 22 TMR3MSK | Timer Comperator 3 Interrupt Mask bit 0b - allows interrupt when comparator matches event timer count 1b - Interrupt generation is disabled, but a TMR3IRQ flag can be set |
| 21 TMR2MSK | Timer Comperator 2 Interrupt Mask bit 0b - allows interrupt when comparator matches event timer count 1b - Interrupt generation is disabled, but a TMR2IRQ flag can be set |
| 20 TMR1MSK | Timer Comperator 1 Interrupt Mask bit 0b - allows interrupt when comparator matches event timer count 1b - Interrupt generation is disabled, but a TMR1IRQ flag can be set |
| 19 TMR4IRQ | Timer 4 IRQ Timer Comparator 4 Interrupt Status bit: Indicates T4CMP comparator value matched event timer counter. This is write '1' to clear bit |
| 18 TMR3IRQ | Timer 3 IRQ Timer Comparator 3 Interrupt Status bit: Indicates T3CMP comparator value matched event timer counter. This is write '1' to clear bit |
| 17 TMR2IRQ | Timer 2 IRQ Timer Comparator 2 Interrupt Status bit: Indicates comparator value matched event timer counter. This flag is shared between the T2CMP (24-bit) and T2PRIMECMP (16-bit) compare registers. This is write '1' to clear bit |

Table continues on the next page...

| Field | Function |
|----------------------|--|
| 16 TMR1IRQ | Timer 1 IRQ Timer Comparator 1 Interrupt Status bit: Indicates T1CMP comparator value matched event timer counter. This is write '1' to clear bit |
| 15 CRCVALID | CRC Valid Status Code Redundancy Check Valid: This flag indicates the compare result between the FCS field, in the most-recently received frame, and the internally calculated CRC value. This flag is cleared at next receiver warm up. 0b - Rx FCS != calculated CRC (incorrect) 1b - Rx FCS = calculated CRC (correct) |
| 14 CCA | CCA Status Channel IDLE/BUSY indicator. This indicator is valid at CCAIRQ and also at SEQIRQ. This flag is cleared at next receiver warm up. 0b - IDLE 1b - BUSY |
| 13 SRCADDR | Source Address Match Status If Source Address Management is engaged, meaning at least one of the following bits is set: SAP0_EN SAA0_EN SAP1_EN SAA1_EN Then SRCADDR will be set to 1 if the packet just received is a poll request (PI=1), and at least one of the following conditions is met: SAP0_EN and SAP0_ADDR_PRESENT SAA0_EN and SAA0_ADDR_ABSENT SAP1_EN and SAP1_ADDR_PRESENT SAA1_EN and SAA1_ADDR_ABSENT If SRCADDR=1, this indicates to SW that the Packet Processor has determined that an auto-TxACK frame must be transmitted with the FramePending subfield of the FrameControlField set to 1. HW will assemble and transmit this Ack packet. If the above conditions are not met, SRCADDR will be cleared to 0. |
| 12 PI | Poll Indication 0b - the received packet was not a data request 1b - the received packet was a data request, regardless of whether a Source Address table match occurred, or whether Source Address Management is enabled or not |
| 11 ENH_PKT_STATUS | Enhanced Packet Status 0b - The last packet received was neither 4e- nor 2015-compliant 1b - The last packet received was 4e- or 2015-compliant (RX_FRAME_FILTER register should be queried for additional status bits) |
| 10 TSM_IRQ | TSM IRQ TSM Interrupt Request 0b - A TSM Interrupt has not occurred 1b - A TSM Interrupt has occurred |
| 9 — | Reserved. |
| 8 WAKE_IRQ | WAKE Interrupt Request Wake Interrupt. The RSIM SLEEP_TMR has matched the RSIM ZIGBEE_WAKE register, and DSM has exited. The 802.15.4 EVENT_TMR has resumed counting. 0b - A Wake Interrupt has not occurred |

Table continues on the next page...

Radio Register Overview

| Field | Function |
|-------------------------|---|
| | 1b - A Wake Interrupt has occurred |
| 7 RX_FRM_PEND | RX Frame Pending Status of the frame pending bit of the frame control field for the most-recently received packet. Read-only. |
| 6 PLL_UNLOCK_I RQ | PLL Unlock IRQ PLL Un-lock Interrupt Status bit. A '1' indicates an unlock event has occurred in the PLL. This is write a '1' to clear bit. 0b - A PLL Unlock Interrupt has not occurred 1b - A PLL Unlock Interrupt has occurred |
| 5 FILTERFAIL_IR Q | Filter Fail IRQ Receiver Packet Filter Fail Interrupt Status bit. A '1' indicates that the most-recently received packet has been rejected due to elements within the packet. This is write a '1' to clear bit. In Dual PAN mode, FILTERFAIL_IRQ applies to either or both networks, as follows: A: If PAN0 and PAN1 occupy different channels and CURRENT_NETWORK=0, FILTERFAIL_IRQ applies to PAN0. B: If PAN0 and PAN1 occupy different channels and CURRENT_NETWORK=1, FILTERFAIL_IRQ applies to PAN1. C: If PAN0 and PAN1 occupy the same channel, FILTERFAIL_IRQ is the logical 'AND' of the individual PANs' Filter Fail status. 0b - A Filter Fail Interrupt has not occurred 1b - A Filter Fail Interrupt has occurred |
| 4 RXWTRMRKIR Q | Receive Watermark IRQ Receiver Byte Count Water Mark Interrupt Status bit. A '1' indicates that the number of bytes specified in the RX_WTR_MARK register has been reached. This is write a '1' to clear bit. 0b - A Receive Watermark Interrupt has not occurred 1b - A Receive Watermark Interrupt has occurred |
| 3 CCAIRQ | CCA IRQ Clear Channel Assessment Interrupt Status bit. A '1' indicates completion of CCA operation. This is write '1' to clear bit. 0b - A CCA Interrupt has not occurred 1b - A CCA Interrupt has occurred |
| 2 RXIRQ | RX IRQ Receiver Interrupt Status bit. A '1' indicates the completion of a receive operation. This is write a '1' to clear bit. 0b - A RX Interrupt has not occurred 1b - A RX Interrupt has occurred |
| 1 TXIRQ | TX IRQ Transmitter Interrupt Status bit. A '1' indicates the completion of a transmit operation. This is write a '1' to clear bit. 0b - A TX Interrupt has not occurred 1b - A TX Interrupt has occurred |
| 0 SEQIRQ | Sequencer IRQ Sequence-end Interrupt Status bit. A '1' indicates the completion of an autosequence. This interrupt will assert whenever the Sequence Manager transitions from non-idle to idle state, for any reason. This is write a '1' to clear bit. 0b - A Sequencer Interrupt has not occurred 1b - A Sequencer Interrupt has occurred |

45.2.3.3.3 PHY CONTROL (PHY_CTRL)

45.2.3.3.3.1 Address

| Register | Offset |
|----------|-----------|
| PHY_CTRL | 4005D004h |

45.2.3.3.3.2 Function

PHY Control Register

45.2.3.3.3.3 Diagram

| | | | | | | | | | | | | | | | | |
|-------|--------------|----------------------------|----------------------------|-------------------------|------------|-----------|---------------------|---------------------|--------------------|--------------------|--------------------|--------------------|-------------|-------------|----|------------------|
| Bits | 31 | 30 | 29 | 28 | 27 | 26 | 25 | 24 | 23 | 22 | 21 | 20 | 19 | 18 | 17 | 16 |
| R | | | | | | 0 | PRO MISC UOUS | TC2P RIME _EN | TMR4 CMP_ EN | TMR3 CMP_ EN | TMR2 CMP_ EN | TMR1 CMP_ EN | 0 | TSM_ MSK | 0 | WAK E_MS K |
| W | TRCV_ MSK | TC3T MOU T | PANC ORD NTR0 | CCATYPE | | | | | | | | | | | | |
| Reset | 0 | 0 | 0 | 0 | 1 | 0 | 0 | 0 | 0 | 0 | 0 | 0 | 0 | 1 | 0 | 1 |
| Bits | 15 | 14 | 13 | 12 | 11 | 10 | 9 | 8 | 7 | 6 | 5 | 4 | 3 | 2 | 1 | 0 |
| R | | | | | | | | | TMRT RIGE N | SLOT TED | CCAB FRTX | RXAC KRQ D | AUTO ACK | | | |
| W | CRC_ MSK | PLL_ UNLO CK_M SK | FILTE RFAI L_MS K | RX_ WMR K_MS K | CCA MSK | RXM SK | TXMS K | SEQ MSK | | | | | | | | XCVSEQ |
| Reset | 1 | 1 | 1 | 1 | 1 | 1 | 1 | 1 | 0 | 0 | 0 | 0 | 0 | 0 | 0 | 0 |

45.2.3.3.3.4 Fields

| Field | Function |
|----------------|---|
| 31 TRCV_MS | Transceiver Global Interrupt Mask Transceiver Global Interrupt Mask 0b - Enable any unmasked interrupt source to assert 802.15.4 interrupt 1b - Mask all interrupt sources from asserting 802.15.4 interrupt |
| 30 TC3TMOU | TMR3 Timeout Enable TMR3 Timeout Enable 0b - TMR3 is a software timer only 1b - Enable TMR3 to abort Rx or CCCA operations. |
| 29 PANCORND | Device is a PAN Coordinator on PAN0 Device is a PAN Coordinator on PAN0. Allows device to receive packets with no destination address, if Source PAN ID matches. |
| 28-27 | Clear Channel Assessment Type |

Table continues on the next page...

Radio Register Overview

| Field | Function |
|----------------------|--|
| CCATYPE | Clear Channel Assessment Type. Selects one of four possible functions for CCA or Energy Detect, per below. 00b - ENERGY DETECT 01b - CCA MODE 1 10b - CCA MODE 2 11b - CCA MODE 3 |
| 26 — | Reserved. |
| 25 PROMISCUOUS | Promiscuous Mode Enable Bypasses most packet filtering. 0b - normal mode 1b - all packet filtering except frame length checking (FrameLength >=5 and FrameLength <=127) is bypassed. |
| 24 TC2PRIME_EN | Timer 2 Prime Compare Enable 0b - Don't allow a match of the lower 16 bits of Event Timer to T2PRIMECMP to set TMR2IRQ 1b - Allow a match of the lower 16 bits of Event Timer to T2PRIMECMP to set TMR2IRQ |
| 23 TMR4CMP_EN | Timer 4 Compare Enable 0b - Don't allow an Event Timer Match to T4CMP to set TMR4IRQ 1b - Allow an Event Timer Match to T4CMP to set TMR4IRQ |
| 22 TMR3CMP_EN | Timer 3 Compare Enable 0b - Don't allow an Event Timer Match to T3CMP to set TMR3IRQ 1b - Allow an Event Timer Match to T3CMP to set TMR3IRQ |
| 21 TMR2CMP_EN | Timer 2 Compare Enable 0b - Don't allow an Event Timer Match to T2CMP or T2PRIMECMP to set TMR2IRQ 1b - Allow an Event Timer Match to T2CMP or T2PRIMECMP to set TMR2IRQ |
| 20 TMR1CMP_EN | Timer 1 Compare Enable 0b - Don't allow an Event Timer Match to T1CMP to set TMR1IRQ 1b - Allow an Event Timer Match to T1CMP to set TMR1IRQ |
| 19 — | Reserved. |
| 18 TSM_MSK | Reserved. 0b - allows assertion of a TSM interrupt to generate a 802.15.4 interrupt 1b - Assertion of a TSM interrupt will set the TSM_IRQ status bit, but a 802.15.4 interrupt is not generated |
| 17 — | Reserved. |
| 16 WAKE_MSK | Reserved. 0b - Allows a wakeup from DSM to generate a 802.15.4 interrupt 1b - Wakeup from DSM will set the WAKE_IRQ status bit, but a 802.15.4 interrupt is not generated |
| 15 CRC_MSK | CRC Mask CRC Mask 0b - sequence manager ignores CRCVALID and considers the receive operation complete after the last octet of the frame has been received. 1b - sequence manager requires CRCVALID=1 at the end of the received frame in order for the receive operation to complete successfully; if CRCVALID=0, sequence manager will return to preamble-detect mode after the last octet of the frame has been received. |
| 14 PLL_UNLOCK_MSK | PLL Unlock Interrupt Mask 0b - allows PLL unlock event to generate a 802.15.4 interrupt |

Table continues on the next page...

| Field | Function |
|--------------------------|---|
| | 1b - A PLL unlock event will set the PLL_UNLOCK_IRQ status bit, but a 802.15.4 interrupt is not generated |
| 13 FILTERFAIL_M SK | FilterFail Interrupt Mask FilterFail Interrupt Mask 0b - allows Packet Processor Filtering Failure to generate a 802.15.4 interrupt 1b - A Packet Processor Filtering Failure will set the FILTERFAIL_IRQ status bit, but a 802.15.4 interrupt is not generated |
| 12 RX_WMRK_MS K | RX Watermark Interrupt Mask RX Watermark Interrupt Mask 0b - allows a Received Byte Count match to the RX_WTR_MARK threshold register to generate a 802.15.4 interrupt 1b - A Received Byte Count match to the RX_WTR_MARK threshold register will set the RXWTRMRKIRQ status bit, but a 802.15.4 interrupt is not generated |
| 11 CCAMSK | CCA Interrupt Mask CCA Interrupt Mask 0b - allows completion of a CCA operation to generate a 802.15.4 interrupt 1b - Completion of a CCA operation will set the CCA status bit, but a 802.15.4 interrupt is not generated |
| 10 RXMSK | RX Interrupt Mask 0b - allows completion of a RX operation to generate a 802.15.4 interrupt 1b - Completion of a RX operation will set the RXIRQ status bit, but a 802.15.4 interrupt is not generated |
| 9 TXMSK | TX Interrupt Mask 0b - allows completion of a TX operation to generate a 802.15.4 interrupt 1b - Completion of a TX operation will set the TXIRQ status bit, but a 802.15.4 interrupt is not generated |
| 8 SEQMSK | Sequencer Interrupt Mask 0b - allows completion of an autosequence to generate a 802.15.4 interrupt 1b - Completion of an autosequence will set the SEQIRQ status bit, but a 802.15.4 interrupt is not generated |
| 7 TMRTRIGEN | Timer2 Trigger Enable 0b - programmed sequence initiates immediately upon write to XCVSEQ. 1b - allow timer TC2 (or TC2') to initiate a preprogrammed sequence (see XCVSEQ register). |
| 6 SLOTTED | Slotted Mode Slotted Mode, for beacon-enabled networks. Applies only to Sequences T, TR, and R, ignored during all other sequences. Used, in concert with CCABFRTX, to determine how many CCA measurements are required prior to a transmit operation. Also used during R sequence to determine whether the ensuing transmit acknowledge frame (if any) needs to be synchronized to a backoff slot boundary. |
| 5 CCABFRTX | CCA Before TX Applies only to Sequences T and TR, ignored during all other sequences. 0b - no CCA required, transmit operation begins immediately. 1b - at least one CCA measurement is required prior to the transmit operation (see also SLOTTED). |
| 4 RXACKRQD | Receive Acknowledge Frame required Applies only to Sequence TR, ignored during all other sequences. 0b - An ordinary receive frame (any type of frame) follows the transmit frame. 1b - A receive Ack frame is expected to follow the transmit frame (non-Ack frames are rejected). |
| 3 AUTOACK | Auto Acknowledge Enable Applies only to Sequence R and Sequence TR, ignored during other sequences |

Table continues on the next page...

Radio Register Overview

| Field | Function |
|---------------|--|
| | 0b - sequence manager will not follow a receive frame with a Tx Ack frame, under any conditions; the autosequence will terminate after the receive frame. 1b - sequence manager will follow a receive frame with an automatic hardware-generated Tx Ack frame, assuming other necessary conditions are met. |
| 2-0 XCVSEQ | 802.15.4 Transceiver Sequence Selector The Transceiver Sequence Selector register selects an autosequence for the sequence manager to execute. Sequence initiation can be immediate, or scheduled (see TMRTRIGEN). A write of XCVSEQ=IDLE will abort any ongoing sequence. A write of XCVSEQ=IDLE must always be performed after a sequence is complete, and before a new sequence is programmed. Any write to XCVSEQ other than XCVSEQ=IDLE during an ongoing sequence, shall be ignored. The mapping of XCVSEQ to sequence types is as follows: 000b - I (IDLE) 001b - R (RECEIVE) 010b - T (TRANSMIT) 011b - C (CCA) 100b - TR (TRANSMIT/RECEIVE) 101b - CCCA (CONTINUOUS CCA) 110b - Reserved 111b - Reserved |

45.2.3.3.4 EVENT TIMER (EVENT_TMR)

45.2.3.3.4.1 Address

| Register | Offset |
|-----------|-----------|
| EVENT_TMR | 4005D008h |

45.2.3.3.4.2 Diagram

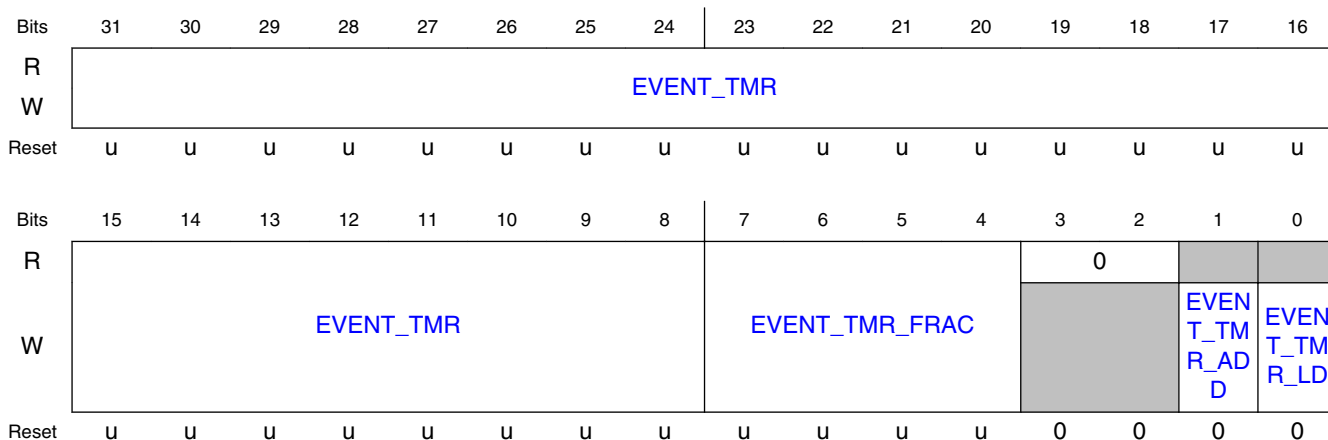

45.2.3.3.4.3 Fields

| Field | Function |
|-----------------------|---|
| 31-8 EVENT_TMR | Event Timer Integer Component The EVENT_TMR represents a 28-bit number with 24 Integer bits and 4 Fractional bits. This field is the integer component, which appears to the left of the decimal point. Most 802.15.4 operations which relate to the Event Timer require only the integer component. |
| 7-4 EVENT_TMR_FRAC | Event Timer Fractional Component The EVENT_TMR represents a 28-bit number with 24 Integer bits and 4 Fractional bits. This field is the fractional component, which appears to the right of the decimal point. The fractional component can be ignored for most 802.15.4 operations which relate to the Event Timer; it has been provided only to allow for microsecond accuracy when software updates the Event Timer after a long period of DSM (sleep) mode |
| 3-2 — | Reserved. |
| 1 EVENT_TMR_ADD | Event Timer Add Enable Increments the Event Timer by the values written to the EVENT_TMR[23:0] and EVENT_TMR_FRAC[3:0] fields of this register. |
| 0 EVENT_TMR_LOAD | Event Timer Load Enable Loads the Event Timer with the values written to the EVENT_TMR[23:0] and EVENT_TMR_FRAC[3:0] fields of this register. |

45.2.3.3.5 TIMESTAMP (TIMESTAMP)

45.2.3.3.5.1 Address

| Register | Offset |
|-----------|-----------|
| TIMESTAMP | 4005D00Ch |

45.2.3.3.5.2 Diagram

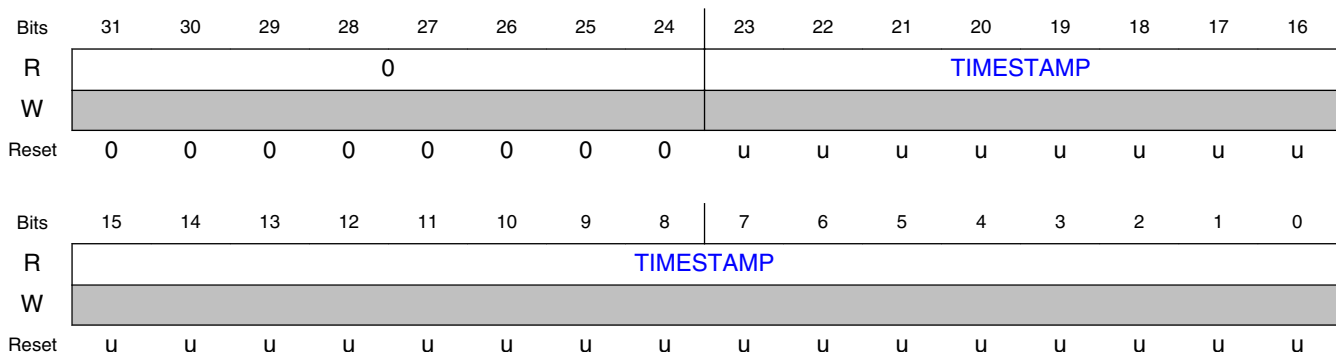

45.2.3.3.5.3 Fields

| Field | Function |
|-------------------|---|
| 31-24 — | Reserved. |
| 23-0 TIMESTAMP | Timestamp Holds the latched value of the Event Timer current time corresponding to the beginning of the most recently received packet, at the point of SFD detection |

45.2.3.3.6 T1 COMPARE (T1CMP)

45.2.3.3.6.1 Address

| Register | Offset |
|----------|-----------|
| T1CMP | 4005D010h |

45.2.3.3.6.2 Function

TMR1 Compare Value

45.2.3.3.6.3 Diagram

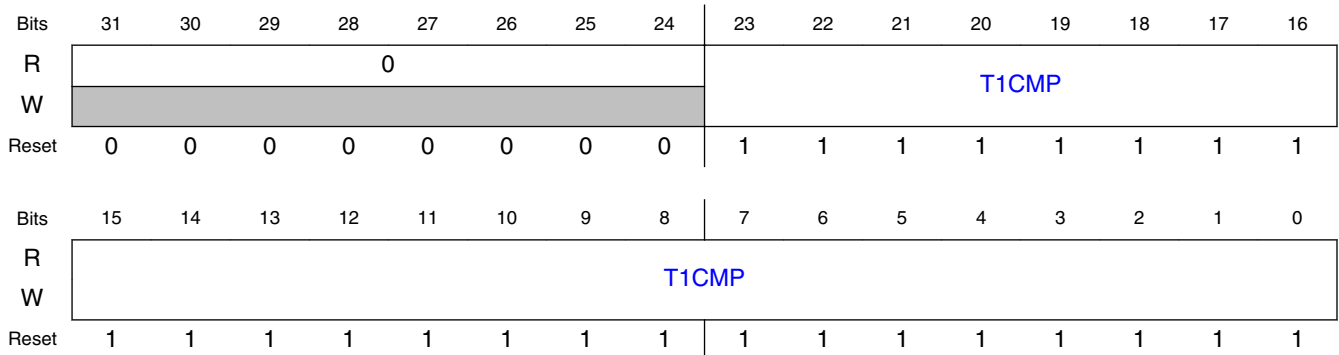

45.2.3.3.6.4 Fields

| Field | Function |
|------------|-----------|
| 31-24 — | Reserved. |

Table continues on the next page...

| Field | Function |
|---------------|---|
| 23-0 T1CMP | TMR1 Compare Value TMR1 compare value. If TMR1CMP_EN=1 and the Event Timer matches this value, TMR1IRQ is set. |

45.2.3.3.7 T2 COMPARE (T2CMP)

45.2.3.3.7.1 Address

| Register | Offset |
|----------|-----------|
| T2CMP | 4005D014h |

45.2.3.3.7.2 Function

TMR2 Compare Value

45.2.3.3.7.3 Diagram

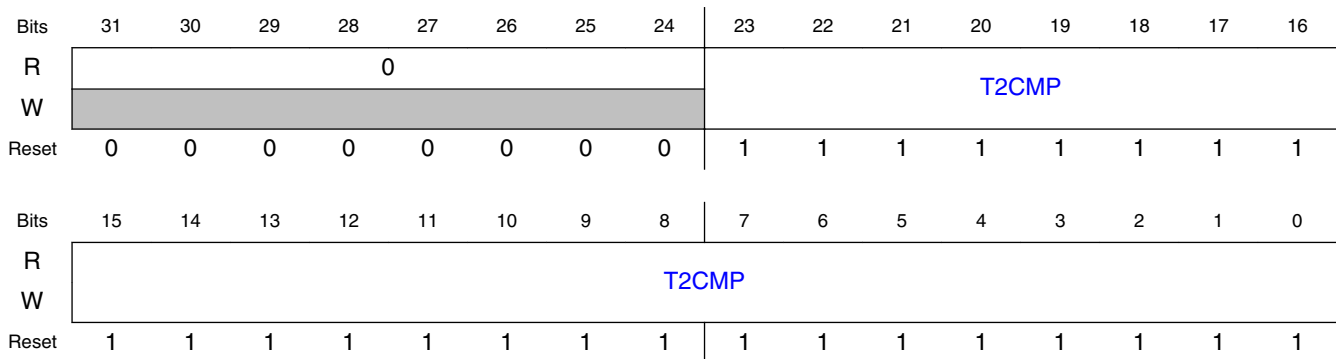

45.2.3.3.7.4 Fields

| Field | Function |
|---------------|---|
| 31-24 — | Reserved. |
| 23-0 T2CMP | TMR2 Compare Value TMR2 compare value. If TMR2CMP_EN=1 and TC2PRIME_EN=0 and the Event Timer matches this value, TMR2IRQ is set. |

45.2.3.3.8 T2 PRIME COMPARE (T2PRIMECMP)

45.2.3.3.8.1 Address

| Register | Offset |
|------------|-----------|
| T2PRIMECMP | 4005D018h |

45.2.3.3.8.2 Function

TMR2 Prime Compare Value

45.2.3.3.8.3 Diagram

| | | | | | | | | | | | | | | | | |
|-------|------------|----|----|----|----|----|----|----|----|----|----|----|----|----|----|----|
| Bits | 31 | 30 | 29 | 28 | 27 | 26 | 25 | 24 | 23 | 22 | 21 | 20 | 19 | 18 | 17 | 16 |
| R | 0 | | | | | | | | | | | | | | | |
| W | | | | | | | | | | | | | | | | |
| Reset | 0 | 0 | 0 | 0 | 0 | 0 | 0 | 0 | 0 | 0 | 0 | 0 | 0 | 0 | 0 | 0 |
| Bits | 15 | 14 | 13 | 12 | 11 | 10 | 9 | 8 | 7 | 6 | 5 | 4 | 3 | 2 | 1 | 0 |
| R | T2PRIMECMP | | | | | | | | | | | | | | | |
| W | | | | | | | | | | | | | | | | |
| Reset | 1 | 1 | 1 | 1 | 1 | 1 | 1 | 1 | 1 | 1 | 1 | 1 | 1 | 1 | 1 | 1 |

45.2.3.3.8.4 Fields

| Field | Function |
|--------------------|---|
| 31-16 — | Reserved. |
| 15-0 T2PRIMECMP | TMR2 Prime Compare Value TMR2 compare value. If TMR2CMP_EN=1 and TC2PRIME_EN=1 and the Event Timer matches this value, TMR2IRQ is set. |

45.2.3.3.9 T3 COMPARE (T3CMP)

45.2.3.3.9.1 Address

| Register | Offset |
|----------|-----------|
| T3CMP | 4005D01Ch |

45.2.3.3.9.2 Function

TMR3 Compare Value

45.2.3.3.9.3 Diagram

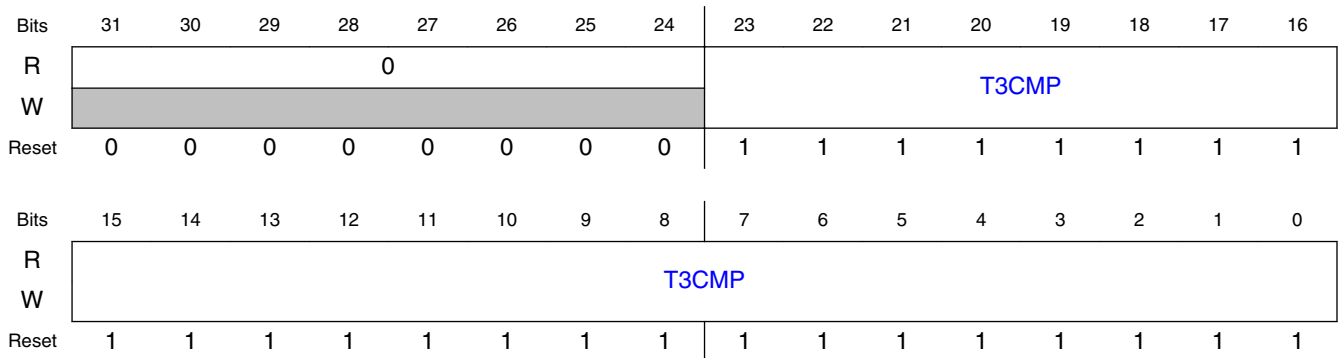

45.2.3.3.9.4 Fields

| Field | Function |
|---------------|---|
| 31-24 — | Reserved. |
| 23-0 T3CMP | TMR3 Compare Value TMR3 compare value. If TMR3CMP_EN=1 and the Event Timer matches this value, TMR3IRQ is set. |

45.2.3.3.10 T4 COMPARE (T4CMP)

45.2.3.3.10.1 Address

| Register | Offset |
|----------|-----------|
| T4CMP | 4005D020h |

45.2.3.3.10.2 Function

TMR4 Compare Value

45.2.3.3.10.3 Diagram

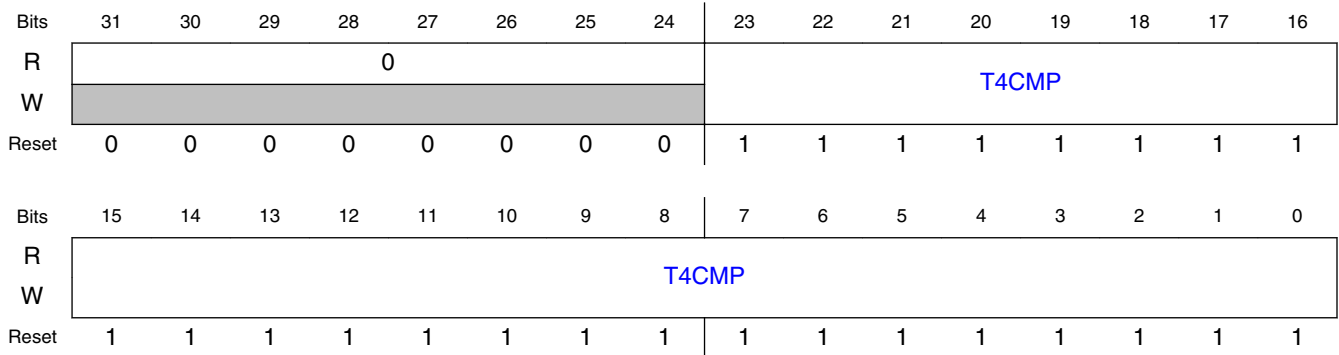

45.2.3.3.10.4 Fields

| Field | Function |
|---------------|---|
| 31-24 — | Reserved. |
| 23-0 T4CMP | TMR4 Compare Value TMR4 compare value. If TMR4CMP_EN=1 and the Event Timer matches this value, TMR4IRQ is set. |

45.2.3.3.11 PA POWER (PA_PWR)

45.2.3.3.11.1 Address

| Register | Offset |
|----------|-----------|
| PA_PWR | 4005D024h |

45.2.3.3.11.2 Diagram

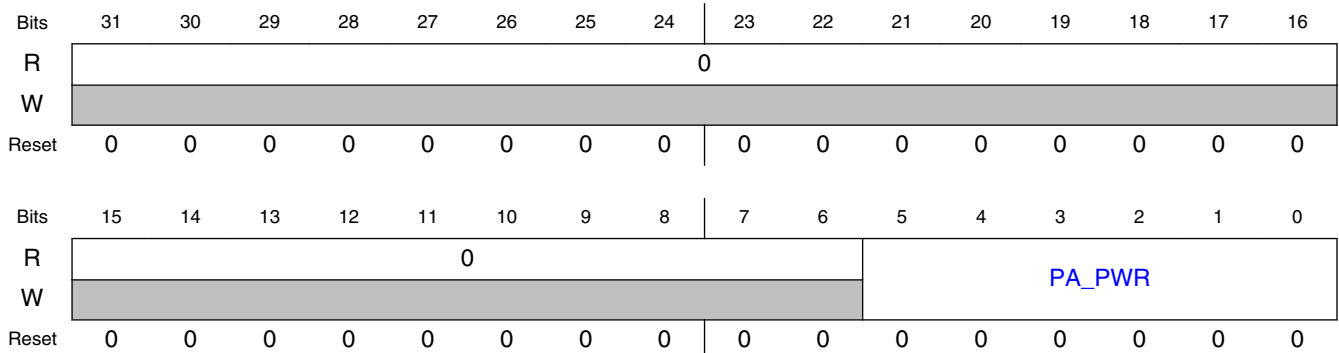

45.2.3.3.11.3 Fields

| Field | Function |
|------------------|-----------|
| 31-6 Reserved | Reserved. |
| 5-0 PA_PWR | PA Power |

45.2.3.3.12 CHANNEL NUMBER 0 (CHANNEL_NUM0)

45.2.3.3.12.1 Address

| Register | Offset |
|--------------|-----------|
| CHANNEL_NUM0 | 4005D028h |

45.2.3.3.12.2 Function

Channel Number for PAN0

45.2.3.3.12.3 Diagram

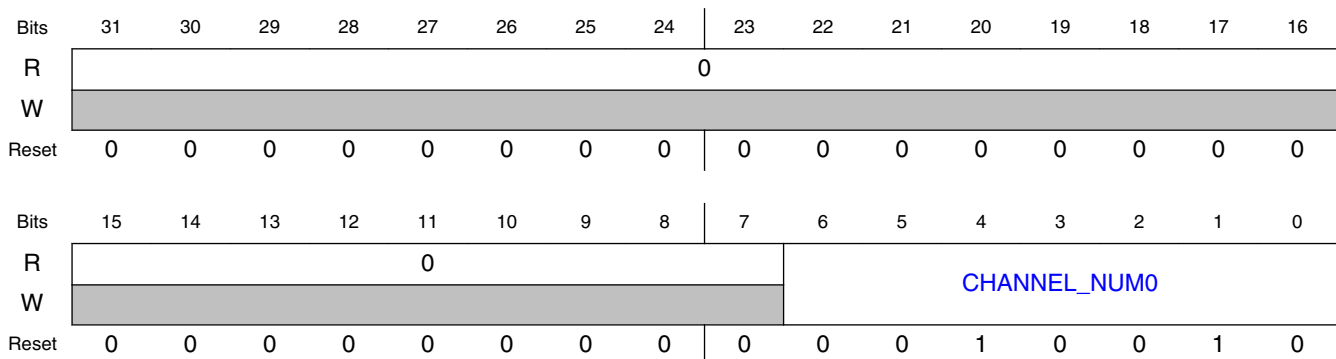

45.2.3.3.12.4 Fields

| Field | Function |
|------------------|-------------------------|
| 31-7 Reserved | Reserved. |
| 6-0 | Channel Number for PAN0 |

Radio Register Overview

| Field | Function |
|--------------|--|
| CHANNEL_NUM0 | This is the mapped channel number used to transmit and receive 802.15.4 packets. If Dual PAN is engaged, this register applies to PAN0. CHANNEL_NUM0 should be in the range: 11 <= CHANNEL_NUM0 <= 26 |

45.2.3.3.13 LQI AND RSSI (LQI_AND_RSSI)

45.2.3.3.13.1 Address

| Register | Offset |
|--------------|-----------|
| LQI_AND_RSSI | 4005D02Ch |

45.2.3.3.13.2 Diagram

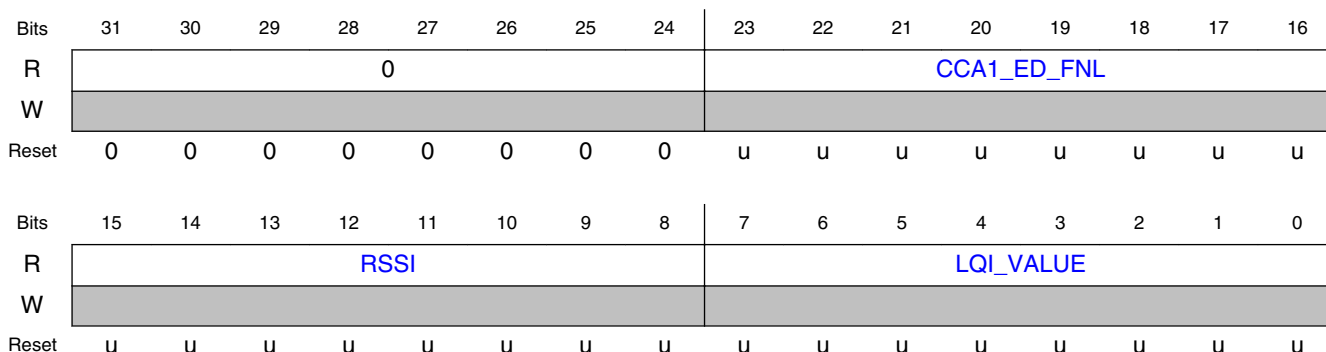

45.2.3.3.13.3 Fields

| Field | Function |
|----------------------|---|
| 31-24 — | Reserved. |
| 23-16 CCA1_ED_FNL | Final Result for CCA Mode 1 and Energy Detect Output register to show final averaged RSSI value or compensated value of the same at the end of a CCA Mode1 or Energy Detect computation. |
| 15-8 RSSI | RSSI Value Received Signal Strength Indicator, in dBm |
| 7-0 LQI_VALUE | LQI Value Link Quality Indicator for the most recently received packet. (LQI is also available in the Packet Buffer, at the end of the received packet data) |

45.2.3.3.14 MAC SHORT ADDRESS 0 (MACSHORTADDRS0)

45.2.3.3.14.1 Address

| Register | Offset |
|----------------|-----------|
| MACSHORTADDRS0 | 4005D030h |

45.2.3.3.14.2 Function

MAC SHORT ADDRESS for PAN0

45.2.3.3.14.3 Diagram



45.2.3.3.14.4 Fields

| Field | Function |
|----------------|--|
| 31-16 | MAC SHORT ADDRESS FOR PAN0 |
| MACSHORTADDRS0 | MAC Short Address for PAN0, for 16-bit destination addressing mode. The packet processor compares the incoming packet's Destination Address against the contents of this register to determine if the packet is addressed to this device. |
| 15-0 | MAC PAN ID for PAN0 |
| MACPANID0 | MAC PAN ID for PAN0. The packet processor compares the incoming packet's Destination PAN ID against the contents of this register to determine if the packet is addressed to this device; or if the incoming packet is a Beacon frame, the packet processor compares the incoming packet Source PAN ID against this register. Also, if PANCORNTRO=1, and the incoming packet has no Destination Address field, and if the incoming packet is a Data or MAC Command frame, the packet processor compares the incoming packet Source PAN ID against this register. |

45.2.3.3.15 MAC LONG ADDRESS 0 LSB (MACLONGADDRS0_LSB)

45.2.3.3.15.1 Address

| Register | Offset |
|------------------------|-----------|
| MACLONGADDRS0_LSB B | 4005D034h |

45.2.3.3.15.2 Function

MAC LONG ADDRESS for PAN0 LSB

45.2.3.3.15.3 Diagram

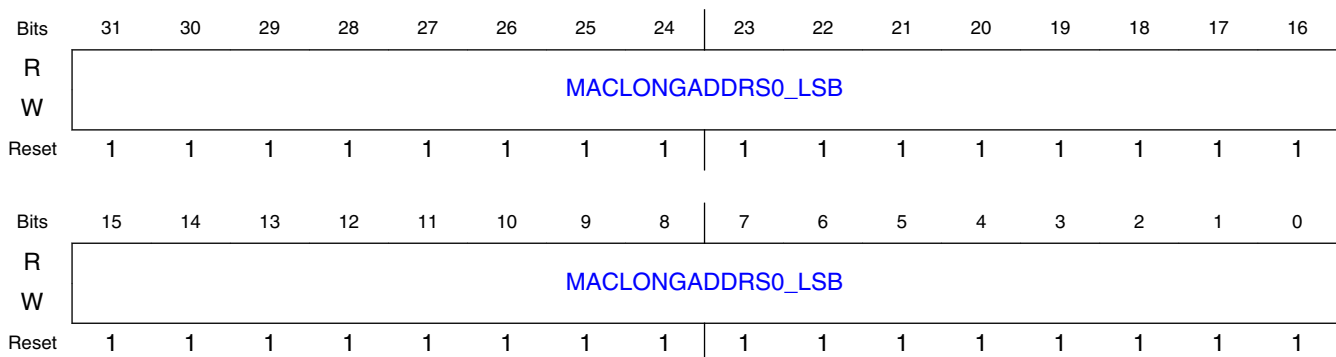

45.2.3.3.15.4 Fields

| Field | Function |
|-------------------|--|
| 31-0 | MAC LONG ADDRESS for PAN0 LSB |
| MACLONGADDRS0_LSB | MAC Long Address for PAN0, for 64-bit destination addressing mode. The packet processor compares the incoming packet's Destination Address against the contents of this register to determine if the packet is addressed to this device. |

45.2.3.3.16 MAC LONG ADDRESS 0 MSB (MACLONGADDRS0_MSB)

45.2.3.3.16.1 Address

| Register | Offset |
|-----------------------|-----------|
| MACLONGADDRS0_MS B | 4005D038h |

45.2.3.3.16.2 Function

MAC LONG ADDRESS for PAN0 MSB

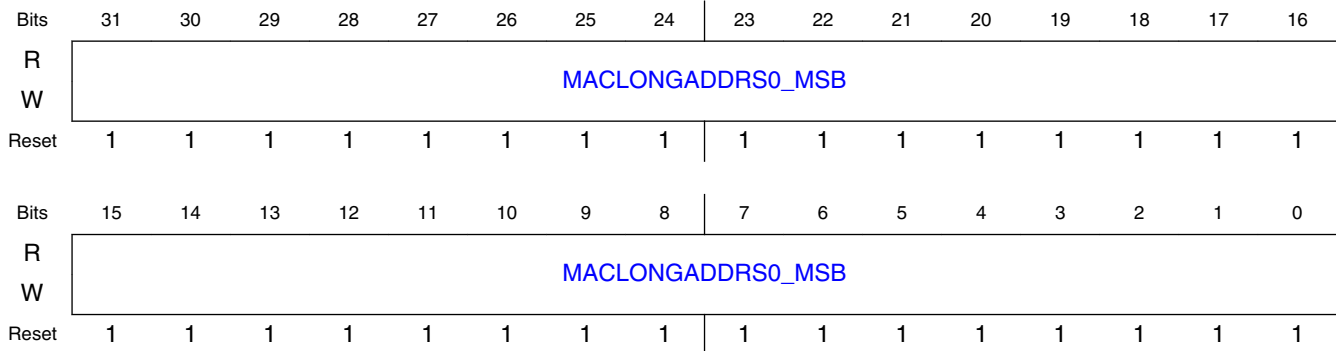
45.2.3.3.16.3 Diagram**45.2.3.3.16.4 Fields**

| Field | Function |
|-----------------------|--|
| 31-0 | MAC LONG ADDRESS for PAN0 MSB |
| MACLONGADD RS0_MSB | MAC Long Address for PAN0, for 64-bit destination addressing mode. The packet processor compares the incoming packet's Destination Address against the contents of this register to determine if the packet is addressed to this device. |

45.2.3.3.17 RECEIVE FRAME FILTER (RX_FRAME_FILTER)**45.2.3.3.17.1 Address**

| Register | Offset |
|-----------------|-----------|
| RX_FRAME_FILTER | 4005D03Ch |

45.2.3.3.17.2 Function

RECEIVE FRAME FILTER

45.2.3.3.17.3 Diagram

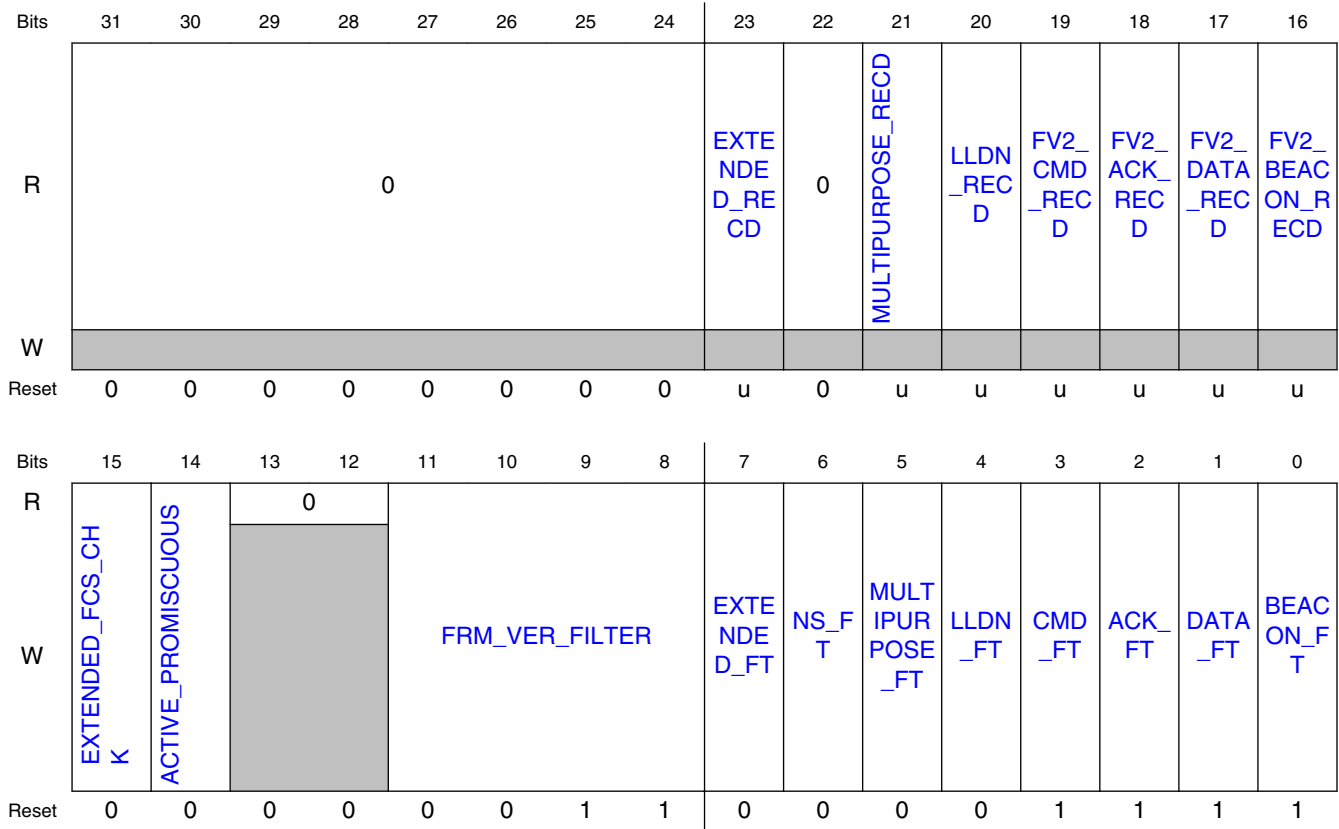

45.2.3.3.17.4 Fields

| Field | Function |
|--------------------------|--|
| 31-24 — | Reserved. |
| 23 EXTENDED_REC'D | Extended Packet Received 0b - The last packet received was not Frame Type EXTENDED 1b - The last packet received was Frame Type EXTENDED, and EXTENDED_FT=1 to allow such packets. |
| 22 — | Reserved. |
| 21 MULTIPURPOSE_REC'D | Multipurpose Packet Received 0b - last packet received was not Frame Type MULTIPURPOSE 1b - The last packet received was Frame Type MULTIPURPOSE, and MULTIPURPOSE_FT=1 to allow such packets. |
| 20 LLDN_REC'D | LLDN Packet Received 0b - The last packet received was not Frame Type LLDN 1b - The last packet received was Frame Type LLDN, and LLDN_FT=1 to allow such packets. |
| 19 | Frame Version 2 MAC Command Packet Received 0b - The last packet received was not Frame Type MAC Command with Frame Version 2 |

Table continues on the next page...

| Field | Function |
|------------------------------|---|
| FV2_CMD_REC D | 1b - The last packet received was Frame Type MAC Command with Frame Version 2, and FRM_VER_FILTER[2]=1 to allow such packets |
| 18 FV2_ACK_REC D | Frame Version 2 Acknowledge Packet Received 0b - The last packet received was not Frame Type Ack with Frame Version 2 1b - The last packet received was Frame Type Ack with Frame Version 2, and FRM_VER_FILTER[2]=1 to allow such packets |
| 17 FV2_DATA_RE CD | Frame Version 2 Data Packet Received 0b - The last packet received was not Frame Type Data with Frame Version 2 1b - The last packet received was Frame Type Data with Frame Version 2, and FRM_VER_FILTER[2]=1 to allow such packets |
| 16 FV2_BEACON_ RECD | Frame Version 2 Beacon Packet Received 0b - The last packet received was not Frame Type Beacon with Frame Version 2 1b - The last packet received was Frame Type Beacon with Frame Version 2, and FRM_VER_FILTER[2]=1 to allow such packets |
| 15 EXTENDED_FC S_CHK | Verify FCS on Frame Type Extended 0b - Packet Processor will not check FCS for Frame Type EXTENDED (default) 1b - Packet Processor will check FCS at end-of-packet based on packet length derived from PHR, for Frame Type EXTENDED |
| 14 ACTIVE_PROMI SCUOUS | Active Promiscuous 0b - normal operation 1b - Provide Data Indication on all received packets under the same rules which apply in PROMISCUOUS mode, however acknowledge those packets under rules which apply in non-PROMISCUOUS mode |
| 13-12 — | Reserved. |
| 11-8 FRM_VER_FILT ER | Frame Version selector. The incoming packet's Frame Control Field is parsed to obtain the FrameVersion subfield, and that value is compared against this register, in accordance with the following: xxx1: Accept received packets with FrameVersion=00 xx1x: Accept received packets with FrameVersion=01 x1xx: Accept received packets with FrameVersion=10 1xxx: Accept received packets with FrameVersion=11 These filtering rules apply to Beacon, Acknowledge, Data, and MAC Command Frame Types, since these frame types require a 2-octet Frame Control Field which embeds a 2-bit FrameVersion subfield. Later frame types introduced in the 802.15.4e addendum (LLDN, Multipurpose) don't guarantee a FrameVersion subfield with the original meaning, so these filtering rules do not apply to these frame types. See registers LLDN_FT and MULTIPURPOSE_FT. For Acknowledge frames, FrameVersion bits are ignored by the Packet Processor, irrespective of FRM_VER_FILTER. |
| 7 EXTENDED_FT | Extended Frame Type Enable 0b - reject all Extended frames 1b - Extended frame type enabled (Frame Type 7). |
| 6 NS_FT | "Not Specified" Frame Type Enable This bit enables reception of all Frame Types not covered by the other _FT bits in this register. 0b - reject all "Not Specified" frames 1b - Not-specified (reserved) frame type enabled. Applies to Frame Type 6. No packet filtering is performed, except for frame length checking (FrameLength >=5 and FrameLength <=127). No AUTOACK is transmitted for this Frame Type |
| 5 | Multipurpose Frame Type Enable 0b - reject all Multipurpose frames |

Table continues on the next page...

Radio Register Overview

| Field | Function |
|-----------------|---|
| MULTIPURPOSE_FT | 1b - Multipurpose frame type enabled (Frame Type 5). |
| 4 LLDN_FT | LLDN Frame Type Enable 0b - reject all LLDN frames 1b - LLDN frame type enabled (Frame Type 4). |
| 3 CMD_FT | MAC Command Frame Type Enable 0b - reject all MAC Command frames 1b - MAC Command frame type enabled. |
| 2 ACK_FT | Ack Frame Type Enable 0b - reject all Acknowledge frames 1b - Acknowledge frame type enabled. |
| 1 DATA_FT | Data Frame Type Enable 0b - reject all Beacon frames 1b - Data frame type enabled. |
| 0 BEACON_FT | Beacon Frame Type Enable 0b - reject all Beacon frames 1b - Beacon frame type enabled. |

45.2.3.3.18 CCA AND LQI CONTROL (CCA_LQI_CTRL)

45.2.3.3.18.1 Address

| Register | Offset |
|--------------|-----------|
| CCA_LQI_CTRL | 4005D040h |

45.2.3.3.18.2 Diagram

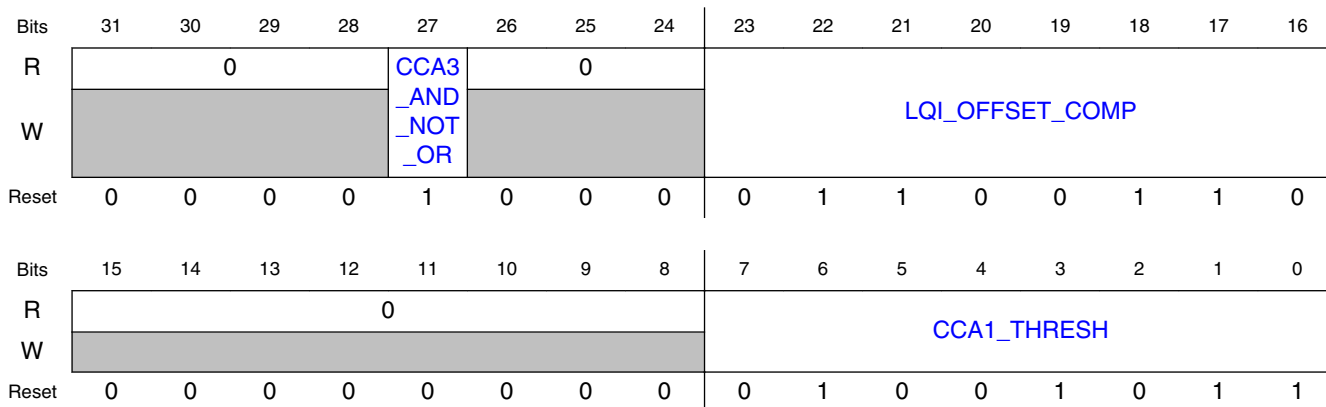

45.2.3.3.18.3 Fields

| Field | Function |
|------------------------------|--|
| 31-28 — | Reserved. |
| 27 CCA3_AND_NO T_OR | CCA Mode 3 AND not OR Determines the way CCA3 is required to be detected 0b - CCA1 or CCA2 1b - CCA1 and CCA2 |
| 26-24 — | Reserved. |
| 23-16 LQI_OFFSET_C OMP | LQI Offset Compensation Programmable amount to offset RSSI based LQI value |
| 15-8 — | Reserved. |
| 7-0 CCA1_THRESH | CCA Mode 1 Threshold Programmable energy threshold register for CCA mode 1. |

45.2.3.3.19 CCA2 CONTROL (CCA2_CTRL)

45.2.3.3.19.1 Address

| Register | Offset |
|-----------|-----------|
| CCA2_CTRL | 4005D044h |

45.2.3.3.19.2 Function

CCA Mode 2 Control

45.2.3.3.19.3 Diagram

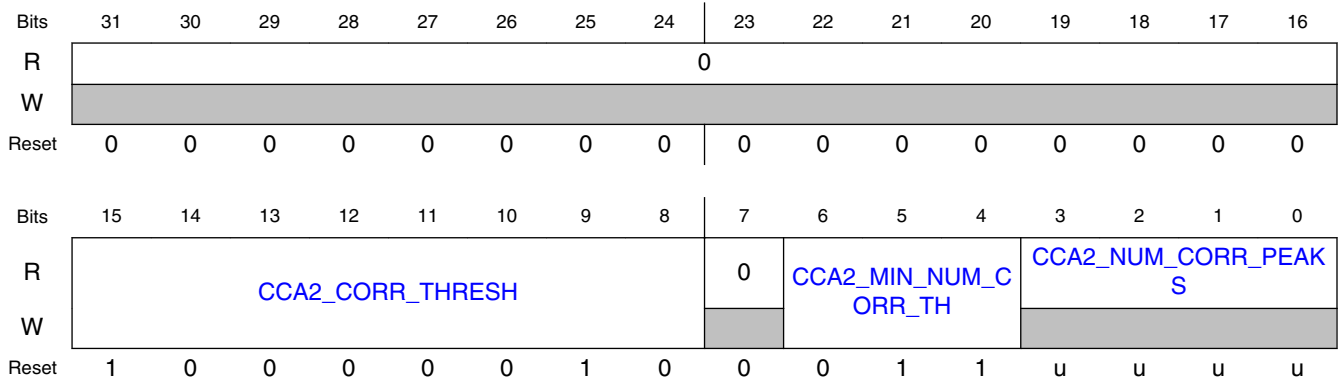

45.2.3.3.19.4 Fields

| Field | Function |
|------------------------------------|--|
| 31-16 — | Reserved. |
| 15-8 CCA2_CORR_T HRESH | CCA Mode 2 Correlation Threshold Correlator threshold used to qualify correlator peaks counted by CCA2_NUM_CORR_PEA KS. Correlator peaks exceeding this value increment CCA2_NUM_CORR_PEA KS. |
| 7 — | Reserved. |
| 6-4 CCA2_MIN_NU M_CORR_TH | CCA Mode 2 Threshold Number of Correlation Peaks Programmable threshold to be compared against number of correlation peaks that exceeded CCA2_CORR_THRESH for detecting CCA mode 2. Number of peaks detected = CCA2_MIN_NUM_CORR_TH + 1; Example: If it is programmed to 3, CCA2 logic looks for at least 4 correlation peaks that crossed the threshold, to indicate channel is idle or busy. |
| 3-0 CCA2_NUM_C ORR_PEA KS | CCA Mode 2 Number of Correlation Peaks Detected Counts of number of peaks that crossed CCA2_CORR_THRESH in CCA Mode 2 operation |

45.2.3.3.20 DSM CONTROL (DSM_CTRL)

45.2.3.3.20.1 Address

| Register | Offset |
|----------|-----------|
| DSM_CTRL | 4005D04Ch |

45.2.3.3.20.2 Diagram

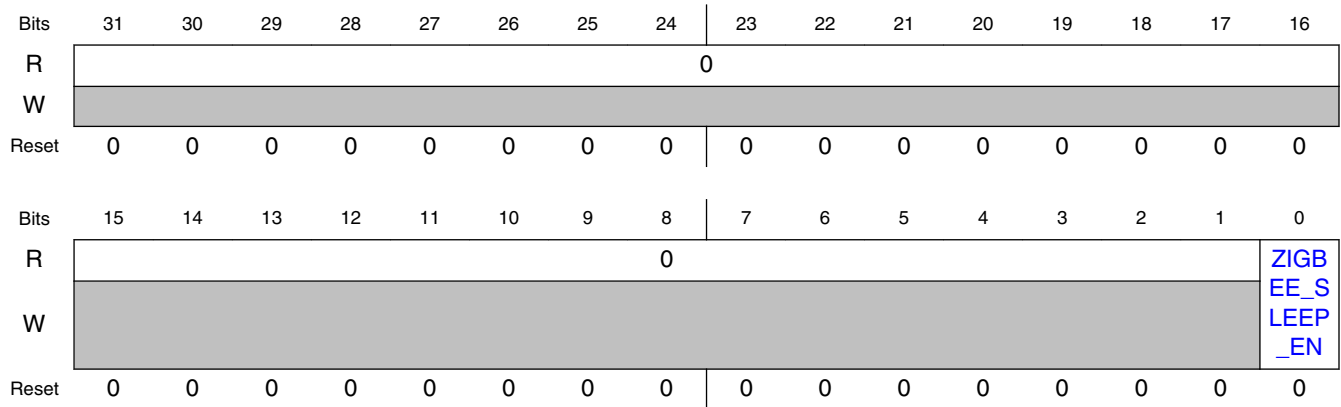

45.2.3.3.20.3 Fields

| Field | Function |
|----------------------|---|
| 31-1 Reserved | Reserved. |
| 0 ZIGBEE_SLEEP_EN | 802.15.4 sleep enable If ZIGBEE_SLEEP_EN=1, enter DSM and freeze EVENT_TMR when ZIG_SLEEP matches DSM_TIMER. Note: ZIG_SLEEP and DSM_TIMER registers reside in RSIM space. |

45.2.3.3.21 BSM CONTROL (BSM_CTRL)

45.2.3.3.21.1 Address

| Register | Offset |
|----------|-----------|
| BSM_CTRL | 4005D050h |

45.2.3.3.21.2 Diagram

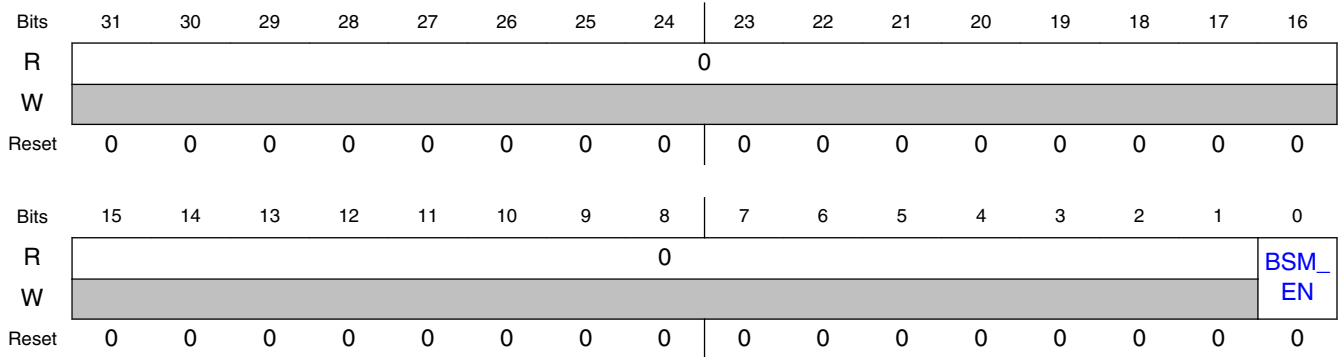

45.2.3.3.21.3 Fields

| Field | Function |
|------------------|---|
| 31-1 Reserved | Reserved. |
| 0 BSM_EN | BSM Enable 0b - 802.15.4 Bit Streaming Mode Disabled 1b - 802.15.4 Bit Streaming Mode Enabled |

45.2.3.3.22 MAC SHORT ADDRESS FOR PAN1 (MACSHORTADDRS1)

45.2.3.3.22.1 Address

| Register | Offset |
|----------------|-----------|
| MACSHORTADDRS1 | 4005D054h |

45.2.3.3.22.2 Function

The MACSHORTADDRS1 register .

45.2.3.3.22.3 Diagram

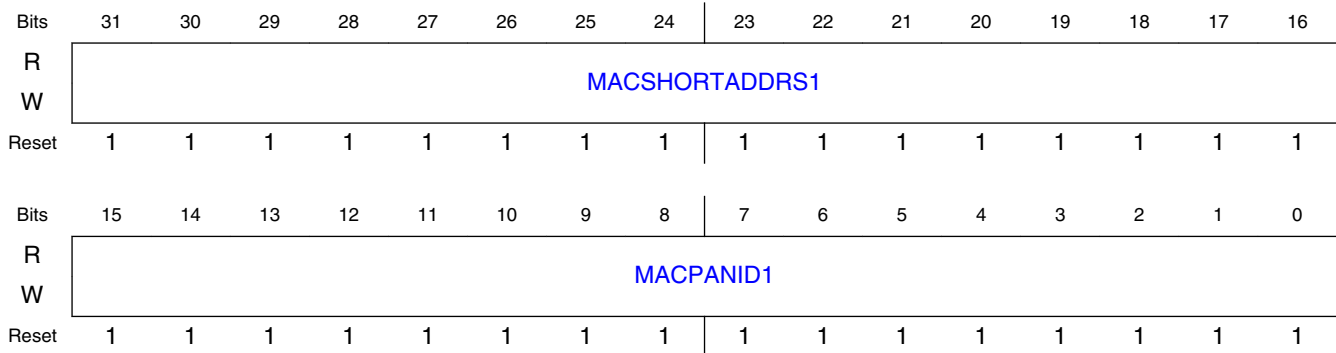

45.2.3.3.22.4 Fields

| Field | Function |
|----------------|---|
| 31-16 | MAC SHORT ADDRESS for PAN1 |
| MACSHORTADDRS1 | MAC Short Address for PAN1, for 16-bit destination addressing mode. The packet processor compares the incoming packet's Destination Address against the contents of this register to determine if the packet is addressed to this device. |
| 15-0 | MAC PAN ID for PAN1 |
| MACPANID1 | MAC PAN ID for PAN1. The packet processor compares the incoming packet's Destination PAN ID against the contents of this register to determine if the packet is addressed to this device; or if the incoming packet is a Beacon frame, the packet processor compares the incoming packet Source PAN ID against this register. Also, if PANCORDNTR1=1, and the incoming packet has no Destination Address field, and if the incoming packet is a Data or MAC Command frame, the packet processor compares the incoming packet Source PAN ID against this register. |

45.2.3.3.23 MAC LONG ADDRESS 1 LSB (MACLONGADDRS1_LSB)

45.2.3.3.23.1 Address

| Register | Offset |
|-------------------|-----------|
| MACLONGADDRS1_LSB | 4005D058h |

45.2.3.3.23.2 Function

MAC Long Address for PAN1, for 64-bit destination addressing mode. The packet processor compares the incoming packet's Destination Address against the contents of this register to determine if the packet is addressed to this device.

45.2.3.3.23.3 Diagram

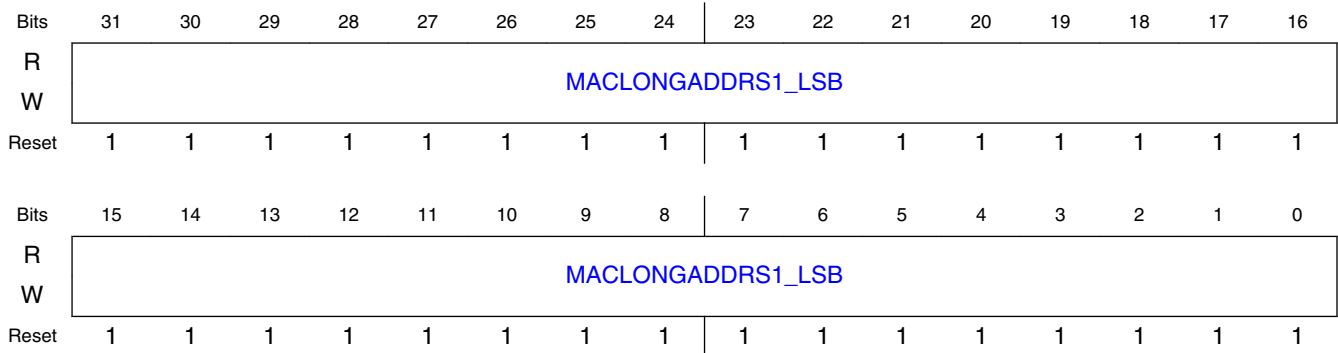

45.2.3.3.23.4 Fields

| Field | Function |
|-------------------|--|
| 31-0 | MAC LONG ADDRESS for PAN1 LSB |
| MACLONGADDRS1_LSB | MAC Long Address for PAN1, for 64-bit destination addressing mode. The packet processor compares the incoming packet's Destination Address against the contents of this register to determine if the packet is addressed to this device. |

45.2.3.3.24 MAC LONG ADDRESS 1 MSB (MACLONGADDRS1_MSB)

45.2.3.3.24.1 Address

| Register | Offset |
|-------------------|-----------|
| MACLONGADDRS1_MSB | 4005D05Ch |

45.2.3.3.24.2 Function

MAC Long Address for PAN1, for 64-bit destination addressing mode. The packet processor compares the incoming packet's Destination Address against the contents of this register to determine if the packet is addressed to this device.

45.2.3.3.24.3 Diagram

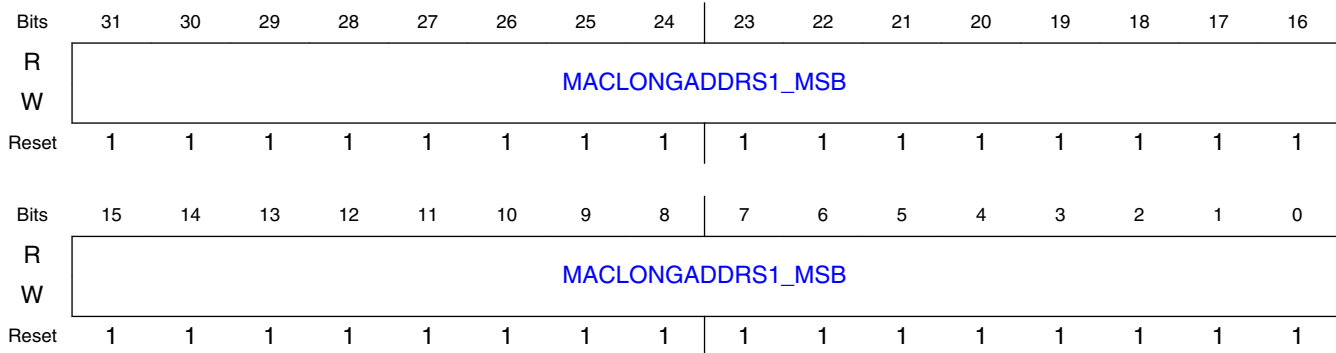

45.2.3.3.24.4 Fields

| Field | Function |
|-------------------|--|
| 31-0 | MAC LONG ADDRESS for PAN1 MSB |
| MACLONGADDRS1_MSB | MAC Long Address for PAN1, for 64-bit destination addressing mode. The packet processor compares the incoming packet's Destination Address against the contents of this register to determine if the packet is addressed to this device. |

45.2.3.3.25 DUAL PAN CONTROL (DUAL_PAN_CTRL)

45.2.3.3.25.1 Address

| Register | Offset |
|---------------|-----------|
| DUAL_PAN_CTRL | 4005D060h |

45.2.3.3.25.2 Function

Dual PAN Control Register

45.2.3.3.25.3 Diagram

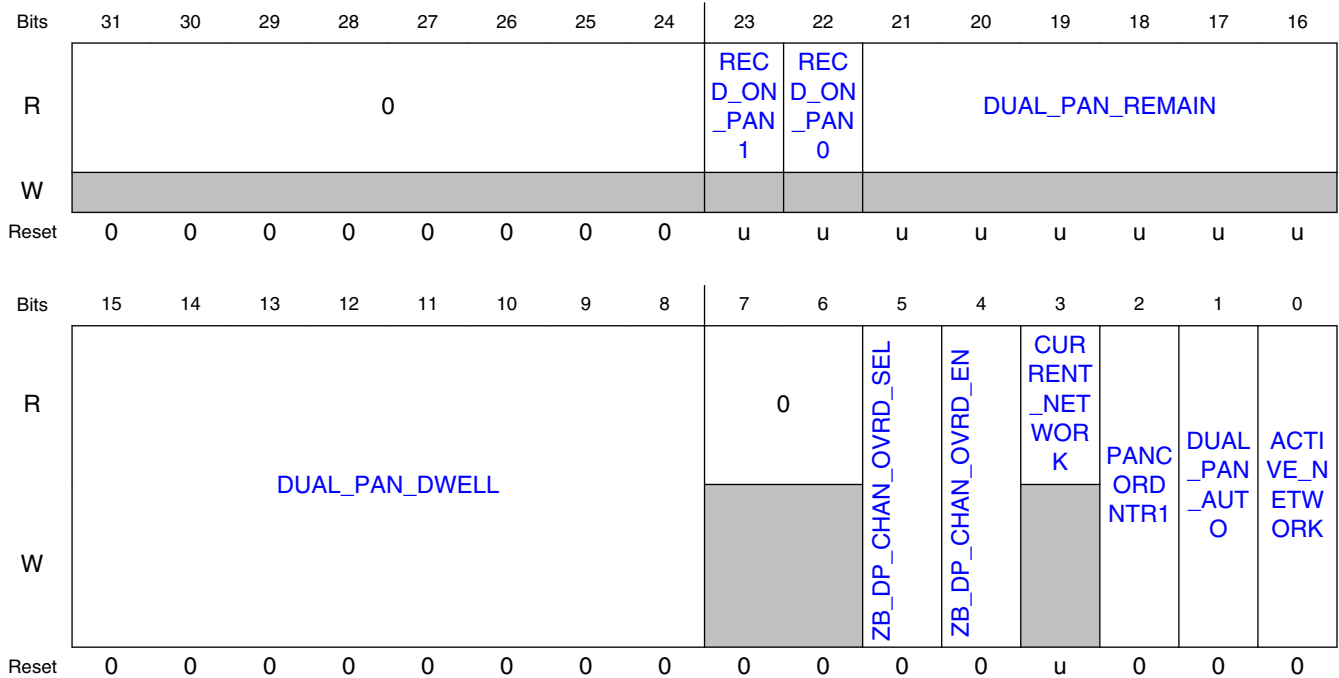

45.2.3.3.25.4 Fields

| Field | Function |
|--------------------------|---|
| 31-24 — | Reserved. |
| 23 RECD_ON_PAN1 | Last Packet was Received on PAN1 Indicates the packet which was just received, was received on PAN1. In Dual PAN mode operating on 2 different channels, RECD_ON_PAN1 will be set if CURRENT_NETWORK=1 when the packet was received, regardless of FILTERFAIL status. In DUAL PAN mode operating with same channel on both networks, CURRENT_NETWORK will be ignored and RECD_ON_PAN1 will be set only if a valid packet was received on PAN1 (PAN1's FILTERFAIL_FLAG is deasserted). RECD_ON_PAN1 remains valid until the start of the next autosequence. |
| 22 RECD_ON_PAN0 | Last Packet was Received on PAN0 Indicates the packet which was just received, was received on PAN0. In Dual PAN mode operating on 2 different channels, RECD_ON_PAN0 will be set if CURRENT_NETWORK=0 when the packet was received, regardless of FILTERFAIL status. In DUAL PAN mode operating with same channel on both networks, CURRENT_NETWORK will be ignored and RECD_ON_PAN0 will be set only if a valid packet was received on PAN0 (PAN0's FILTERFAIL_FLAG is deasserted). RECD_ON_PAN0 remains valid until the start of the next autosequence. |
| 21-16 DUAL_PAN_REMAIN | Time Remaining before next PAN switch in auto Dual PAN mode This read-only register indicates time remaining before next PAN switch in auto Dual PAN mode. The units for this register, depend on the PRESCALER setting (bits [1:0]) in the DUAL_PAN_DWELL register, according to the following table: |

Table continues on the next page...

| Field | Function | | | | | | | | | | | | | | | | |
|------------------------------|---|------------------------------|------------------------|-----------------------|---------------------|----|-------|------------|----|-------|-------------|----|------|------------|----|------|-------------------|
| | DUAL_PAN_DWELL PRESCALER | DUAL_PAN_REMAIN UNITS | | | | | | | | | | | | | | | |
| | 00 | 0.5ms | | | | | | | | | | | | | | | |
| | 01 | 2.5ms | | | | | | | | | | | | | | | |
| | 10 | 10ms | | | | | | | | | | | | | | | |
| | 11 | 50ms | | | | | | | | | | | | | | | |
| | <p>The readback value indicates that between N-1 and N timebase units remain until the next PAN switch. For example, a DUAL_PAN_REMAIN readback value of 3, with a DUAL_PAN_DWELL PRESCALER setting of 2 (10ms), indicates that between 20ms (2*10ms) and 30ms (3*10ms), remain until the next automatic PAN switch.</p> | | | | | | | | | | | | | | | | |
| 15-8 DUAL_PAN_D WELL | <p>Dual PAN Channel Frequency Dwell Time</p> <p>Channel Frequency Dwell Time. In Auto Dual PAN mode, hardware will toggle the PAN, after dwelling on the current PAN for the interval described below (assuming Preamble/SFD not detected). A write to DUAL_PAN_DWELL, always re-initializes the DWELL TIMER to the programmed value. If a write to DUAL_PAN_DWELL occurs during an autosequence, the DWELL TIMER will begin counting down immediately. If a write to DUAL_PAN_DWELL occurs when there is no autosequence underway, the DWELL TIMER will not begin counting until the next autosequence begins; it will begin counting at the start of the sequence warmup.</p> <table border="1"> <thead> <tr> <th>PRESCALER (bits [1:0])</th> <th>TIMEBASE (bits [7:2])</th> <th>RANGE (min) - (max)</th> </tr> </thead> <tbody> <tr> <td>00</td> <td>0.5ms</td> <td>0.5 - 32ms</td> </tr> <tr> <td>01</td> <td>2.5ms</td> <td>2.5 - 160ms</td> </tr> <tr> <td>10</td> <td>10ms</td> <td>10 - 640ms</td> </tr> <tr> <td>11</td> <td>50ms</td> <td>50ms - 3.2seconds</td> </tr> </tbody> </table> <p>A write to DUAL_PAN_DWELL also causes the value of ACTIVE_NETWORK to get latched into the hardware. This latched value will be the starting point for the automatic dual-pan mode (i.e., start on PAN0 or on PAN1). The starting value takes effect immediately (if sequence is underway and DUAL_PAN_AUTO=1), or is otherwise delayed until sequence starts and DUAL_PAN_AUTO=1.</p> | | PRESCALER (bits [1:0]) | TIMEBASE (bits [7:2]) | RANGE (min) - (max) | 00 | 0.5ms | 0.5 - 32ms | 01 | 2.5ms | 2.5 - 160ms | 10 | 10ms | 10 - 640ms | 11 | 50ms | 50ms - 3.2seconds |
| PRESCALER (bits [1:0]) | TIMEBASE (bits [7:2]) | RANGE (min) - (max) | | | | | | | | | | | | | | | |
| 00 | 0.5ms | 0.5 - 32ms | | | | | | | | | | | | | | | |
| 01 | 2.5ms | 2.5 - 160ms | | | | | | | | | | | | | | | |
| 10 | 10ms | 10 - 640ms | | | | | | | | | | | | | | | |
| 11 | 50ms | 50ms - 3.2seconds | | | | | | | | | | | | | | | |
| 7-6 — | Reserved. | | | | | | | | | | | | | | | | |
| 5 ZB_DP_CHAN_ OVRD_SEL | <p>Dual PAN Channel Override Selector</p> <p>This bit works with ZB_DP_CHAN_OVRD_EN to allow one of the two Dual PAN channels to use Direct Frequency programming. See description for ZB_DP_CHAN_OVRD_EN.</p> | | | | | | | | | | | | | | | | |
| 4 ZB_DP_CHAN_ OVRD_EN | <p>Dual PAN Channel Override Enable</p> <p>In Dual PAN mode, in case there is a need to generate a frequency which may be offset from the 16 prescribed 5MHz-spaced channels, to, for example, avoid interference on one of the Dual PAN channels, a method has been provided to accomplish that, by designating one of the two PAN channels to use the transceiver's set of direct frequency-programming registers, instead of CHANNEL_NUMx. Programming the direct frequency-programming registers -- integer, numerator, and denominator, allows an RF frequency to be selected with much more precision than the 5MHz granularity of the 802.15.4 mapped-channel registers, CHANNEL_NUM0 and CHANNEL_NUM1.</p> | | | | | | | | | | | | | | | | |

Table continues on the next page...

Radio Register Overview

| Field | Function | | | | | | | | | | | | | | | | |
|----------------------|---|----------------------------------|----------------------------------|----------------------------------|----------------------------------|---|---|-------------------|-------------------|---|---|------------------------------|-------------------|---|---|-------------------|------------------------------|
| | <p>Two bits have been provided in 802.15.4 space to realize this feature: ZB_DP_CHAN_OVRD_SEL and ZB_DP_CHAN_OVRD_EN. When ZB_DP_CHAN_OVRD_EN=1, this enables one of the Dual PAN channels to use the direct frequency programming. The ZB_DP_CHAN_OVRD_SEL bit determines which channel uses the direct programming, according to the following table:</p> <table border="1"> <thead> <tr> <th>ZB_DP_CHAN_OVRD_EN</th> <th>ZB_DP_CHAN_OVRD_SEL</th> <th>PAN0 Frequency Determined by ...</th> <th>PAN1 Frequency Determined by ...</th> </tr> </thead> <tbody> <tr> <td>0</td> <td>X</td> <td>CHANNEL_NUM0[6:0]</td> <td>CHANNEL_NUM1[6:0]</td> </tr> <tr> <td>1</td> <td>0</td> <td>DIRECT FREQUENCY PROGRAMMING</td> <td>CHANNEL_NUM1[6:0]</td> </tr> <tr> <td>1</td> <td>1</td> <td>CHANNEL_NUM0[6:0]</td> <td>DIRECT FREQUENCY PROGRAMMING</td> </tr> </tbody> </table> <p>Direct Frequency Programming is accomplished by setting the PLL's Integer, Numerator, and Denominator registers to the appropriate values for the desired RF frequency.</p> | ZB_DP_CHAN_OVRD_EN | ZB_DP_CHAN_OVRD_SEL | PAN0 Frequency Determined by ... | PAN1 Frequency Determined by ... | 0 | X | CHANNEL_NUM0[6:0] | CHANNEL_NUM1[6:0] | 1 | 0 | DIRECT FREQUENCY PROGRAMMING | CHANNEL_NUM1[6:0] | 1 | 1 | CHANNEL_NUM0[6:0] | DIRECT FREQUENCY PROGRAMMING |
| ZB_DP_CHAN_OVRD_EN | ZB_DP_CHAN_OVRD_SEL | PAN0 Frequency Determined by ... | PAN1 Frequency Determined by ... | | | | | | | | | | | | | | |
| 0 | X | CHANNEL_NUM0[6:0] | CHANNEL_NUM1[6:0] | | | | | | | | | | | | | | |
| 1 | 0 | DIRECT FREQUENCY PROGRAMMING | CHANNEL_NUM1[6:0] | | | | | | | | | | | | | | |
| 1 | 1 | CHANNEL_NUM0[6:0] | DIRECT FREQUENCY PROGRAMMING | | | | | | | | | | | | | | |
| 3 CURRENT_NETWORK | <p>Indicates which PAN is currently selected by hardware</p> <p>This read-only bit indicates which PAN is currently selected by hardware in automatic Dual PAN mode 0b - PAN0 is selected 1b - PAN1 is selected</p> | | | | | | | | | | | | | | | | |
| 2 PANCORDNTR1 | <p>Device is a PAN Coordinator on PAN1</p> <p>Device is a PAN Coordinator on PAN1. Allows device to receive packets with no destination address, if Source PAN ID matches.</p> | | | | | | | | | | | | | | | | |
| 1 DUAL_PAN_AUTO | <p>Activates automatic Dual PAN operating mode</p> <p>Activates automatic Dual PAN operating mode. In this mode, PAN-switching is controlled by hardware at a pre-programmed rate, determined by DUAL_PAN_DWELL. 0: Manual Dual PAN mode (or Single PAN mode). 1: Auto Dual PAN Mode</p> <p>Whenever DUAL_PAN_AUTO=0, CURRENT_NETWORK=ACTIVE_NETWORK at all times. In other words, software directly controls which PAN is selected. Whenever DUAL_PAN_AUTO=1, CURRENT_NETWORK is controlled by hardware.</p> | | | | | | | | | | | | | | | | |
| 0 ACTIVE_NETWORK | <p>Active Network Selector</p> <p>Selects the PAN on which to transceive, by activating a PAN parameter set (PAN0 or PAN1). In Manual Dual PAN mode (or Single PAN mode), this bit selects the active PAN parameter set (channel and addressing parameters) which governs all autosequences. In Auto Dual PAN mode, this bit selects the PAN on which to begin transceiving, latched at the point at which DUAL_PAN_DWELL register is written. 0b - Select PAN0 1b - Select PAN1</p> | | | | | | | | | | | | | | | | |

45.2.3.3.26 CHANNEL NUMBER 1 (CHANNEL_NUM1)

45.2.3.3.26.1 Address

| Register | Offset |
|--------------|-----------|
| CHANNEL_NUM1 | 4005D064h |

45.2.3.3.26.2 Diagram

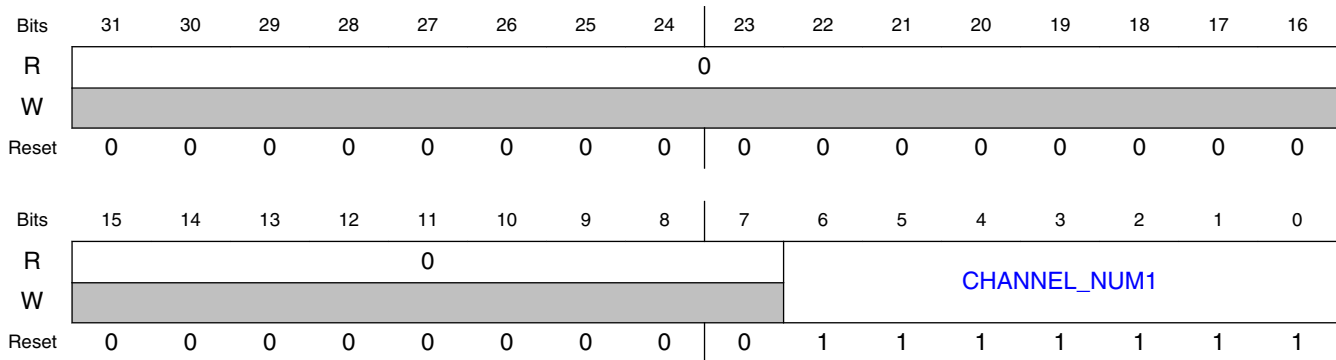

45.2.3.3.26.3 Fields

| Field | Function |
|---------------------|---|
| 31-7 Reserved | Reserved. |
| 6-0 CHANNEL_NUM1 | <p>Channel Number for PAN1</p> <p>This is the mapped channel number used to transmit and receive 802.15.4 packets. This register applies to PAN1 only. CHANNEL_NUM1 should be in the range: $11 \leq \text{CHANNEL_NUM1} \leq 26$</p> <p>Note: This register should not be programmed, and left in its default state, if Dual PAN mode is not in use.</p> |

45.2.3.3.27 SAM CONTROL (SAM_CTRL)

45.2.3.3.27.1 Address

| Register | Offset |
|----------|-----------|
| SAM_CTRL | 4005D068h |

45.2.3.3.27.2 Function

Source Address Management Control Register

45.2.3.3.27.3 Diagram

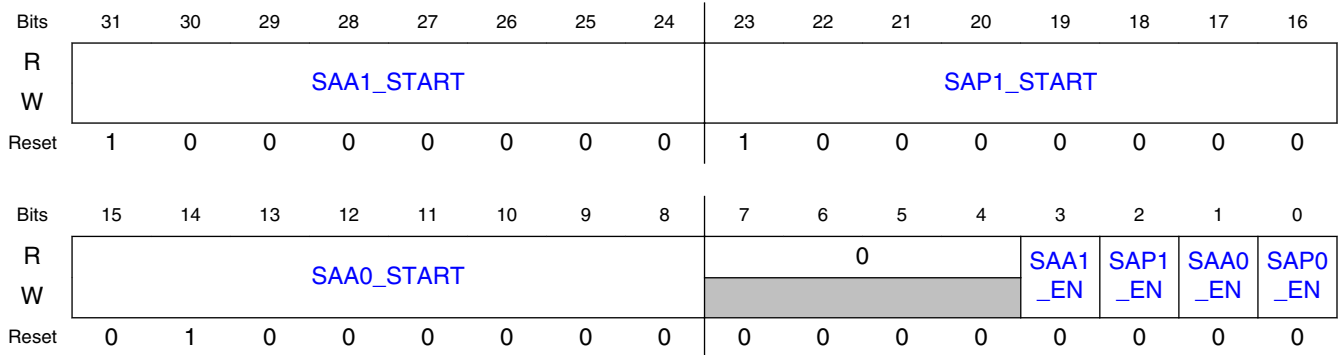

45.2.3.3.27.4 Fields

| Field | Function |
|---------------------|--|
| 31-24 SAA1_START | First Index of SAA1 partition |
| 23-16 SAP1_START | First Index of SAP1 partition |
| 15-8 SAA0_START | First Index of SAA0 partition |
| 7-4 — | Reserved. |
| 3 SAA1_EN | Enables SAA1 Partition of the SAM Table 0b - Disables SAA1 Partition 1b - Enables SAA1 Partition |
| 2 SAP1_EN | Enables SAP1 Partition of the SAM Table 0b - Disables SAP1 Partition 1b - Enables SAP1 Partition |
| 1 SAA0_EN | Enables SAA0 Partition of the SAM Table 0b - Disables SAA0 Partition 1b - Enables SAA0 Partition |
| 0 SAP0_EN | Enables SAP0 Partition of the SAM Table 0b - Disables SAP0 Partition 1b - Enables SAP0 Partition |

45.2.3.3.28 SOURCE ADDRESS MANAGEMENT TABLE (SAM_TABLE)

45.2.3.3.28.1 Address

| Register | Offset |
|-----------|-----------|
| SAM_TABLE | 4005D06Ch |

45.2.3.3.28.2 Function

Source Address Management Table

45.2.3.3.28.3 Diagram

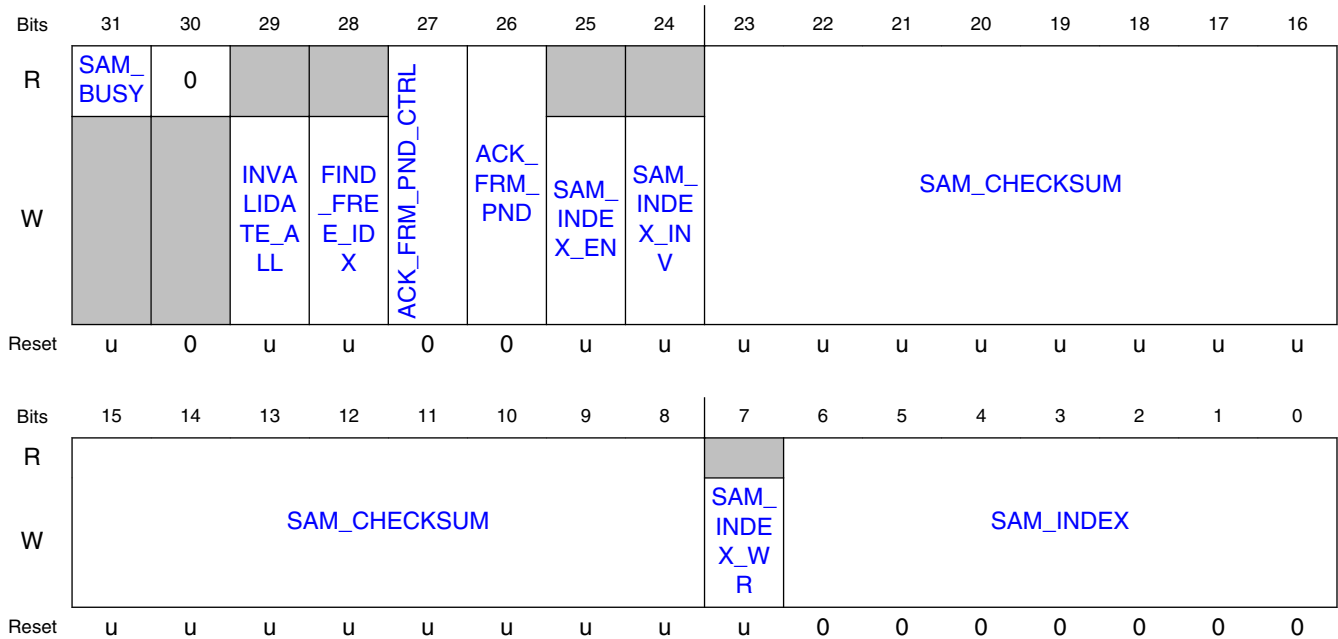

45.2.3.3.28.4 Fields

| Field | Function |
|----------------------|--|
| 31 SAM_BUSY | SAM Table Update Status Bit Hardware is in the process of updating the Source Address table, either in response to a poll indication from the packet processor, or due to software setting FIND_FREE_IDX=1. In the latter case, software should poll SAM_BUSY until low before accessing the "First Free Index" registers. Read-only bit. |
| 30 — | Reserved. |
| 29 INVALIDATE_ALL | Invalidate Entire SAM Table Writing a 1 to this bit clears all 128 Valid bits. Invalidates the entire table. Write-only bit. Writing 0 to this bit has no effect. Readback value is indeterminate. |
| 28 FIND_FREE_IDX | Find First Free Index After modifying Valid bits (enabling or invalidating), write this bit to 1 to force hardware to update the "First Free Index" registers to account for the changed Valid bits. This hardware update process takes 4us. Software can poll SAM_BUSY to determine when the table update is complete. Write-only bit. Writing 0 to this bit has no effect. Readback value is indeterminate. |
| 27 | Manual Control for AutoTxAck FramePending field |

Table continues on the next page...

Radio Register Overview

| Field | Function |
|----------------------|--|
| ACK_FRM_PND_CTRL | 0b - the FramePending field of the Frame Control Field of the next automatic TX acknowledge packet is determined by hardware 1b - the FramePending field of the Frame Control Field of the next automatic TX acknowledge packet tracks ACK_FRM_PEND |
| 26 ACK_FRM_PND | State of AutoTxAck FramePending field when SAM Acceleration is Disabled Software can take manual control of the FramePending field of the Frame Control Field of the next automatic TX acknowledge packet, by setting ACK_FRM_PND_CTRL=1; in that case FramePending will track the state of this bit. The FramePending field also tracks this bit if Source Address Management is completely disabled, i.e., SAP0_EN=SAA0_EN=SAP1_EN=SAA1_EN=0 Otherwise, the FramePending field is determined by Source Address Management (SAM) hardware. |
| 25 SAM_INDEX_EN | Enable the SAM table index selected by SAM_INDEX |
| 24 SAM_INDEX_INV | Invalidate the SAM table index selected by SAM_INDEX |
| 23-8 SAM_CHECKSUM | Software-computed source address checksum, to be installed into a table index Software-computed source address checksum, to be installed into a table index. The value on SAM_CHECKSUM[15:0] can be installed into the table with a single, atomic 32-bit write; in that case, the write data would contain the desired SAM_INDEX[6:0] and SAM_CHECKSUM[15:0], and SAM_INDEX_WR=1. If SAM_INDEX_WR=0, then the SAM_INDEX[6:0] register is written, but the checksum is <i>not</i> written to the table. The readback value of SAM_CHECKSUM[15:0] is the contents of the SAM Table at the location pointed to by SAM_INDEX[6:0]. To readback from a specific table index, software should first write the desired index to SAM_INDEX[6:0], and then read back the checksum from the table on SAM_CHECKSUM[15:0]. |
| 7 SAM_INDEX_WR | Enables SAM Table Contents to be updated For 32-bit writes, SAM_INDEX_WR must be set to indicate that the table entry specified by SAM_INDEX[6:0] is to be written; if SAM_INDEX_WR=0, the table entry is not written, but the SAM_INDEX[6:0] register is updated. For 8-bit writes, this bit is ignored. |
| 6-0 SAM_INDEX | Contains the SAM table index to be enabled or invalidated Contains the table index to be enabled or invalidated. Software must ensure that the index is within the range of the desired partition. |

45.2.3.3.29 SOURCE ADDRESS MANAGEMENT MATCH (SAM_MATCH)

45.2.3.3.29.1 Address

| Register | Offset |
|-----------|-----------|
| SAM_MATCH | 4005D070h |

45.2.3.3.29.2 Diagram

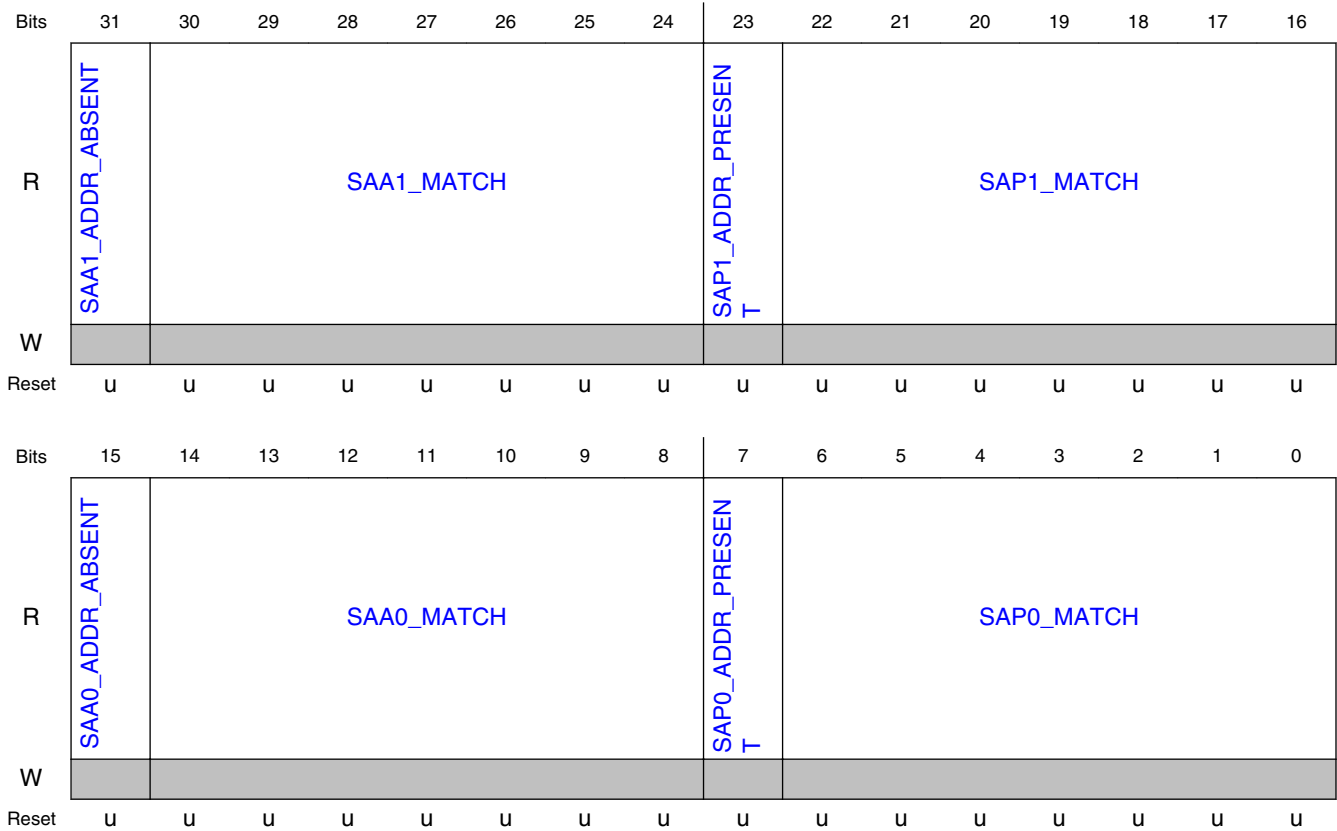

45.2.3.3.29.3 Fields

| Field | Function |
|------------------------|--|
| 31 SAA1_ADDR_ABSENT | A Checksum Match is Absent in the SAP1 Partition of the SAM Table |
| 30-24 SAA1_MATCH | Index in the SAA1 Partition of the SAM Table corresponding to the first checksum match |
| 23 SAP1_ADDR_PRESEN | A Checksum Match is Present in the SAP1 Partition of the SAM Table |
| 22-16 SAP1_MATCH | Index in the SAP1 Partition of the SAM Table corresponding to the first checksum match |
| 15 SAA0_ADDR_ABSENT | A Checksum Match is Absent in the SAA0 Partition of the SAM Table |
| 14-8 SAA0_MATCH | Index in the SAA0 Partition of the SAM Table corresponding to the first checksum match |

Table continues on the next page...

Radio Register Overview

| Field | Function |
|----------------------------|--|
| 7 SAP0_ADDR_P RESENT | A Checksum Match is Present in the SAP0 Partition of the SAM Table |
| 6-0 SAP0_MATCH | Index in the SAP0 Partition of the SAM Table corresponding to the first checksum match |

45.2.3.3.30 SAM FREE INDEX (SAM_FREE_IDX)

45.2.3.3.30.1 Address

| Register | Offset |
|--------------|-----------|
| SAM_FREE_IDX | 4005D074h |

45.2.3.3.30.2 Diagram

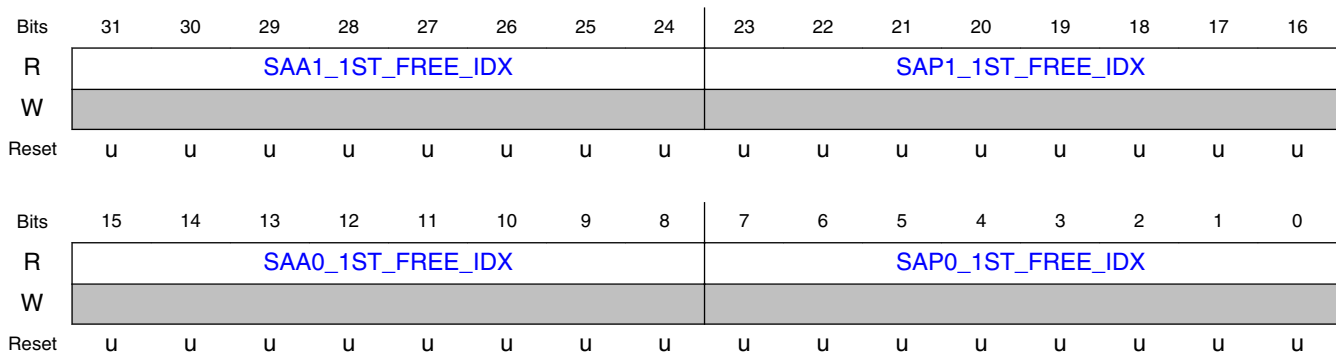

45.2.3.3.30.3 Fields

| Field | Function |
|--------------------------------|---|
| 31-24 SAA1_1ST_FR EE_IDX | First non-enabled (invalid) index in the SAA1 partition |
| 23-16 SAP1_1ST_FR EE_IDX | First non-enabled (invalid) index in the SAP1 partition |
| 15-8 SAA0_1ST_FR EE_IDX | First non-enabled (invalid) index in the SAA0 partition |

Table continues on the next page...

| Field | Function |
|------------------------------|---|
| 7-0 SAP0_1ST_FR EE_IDX | First non-enabled (invalid) index in the SAP0 partition |

45.2.3.3.31 SEQUENCE CONTROL AND STATUS (SEQ_CTRL_STS)

45.2.3.3.31.1 Address

| Register | Offset |
|--------------|-----------|
| SEQ_CTRL_STS | 4005D078h |

45.2.3.3.31.2 Diagram

| | | | | | | | | | | | | | | | | |
|-------|---------------------|-------------|--------------------|-----------------|----------|---------------------|---------------------|--------------------|---------------|----------------|--------------|---------------|------------------------|---------------------|--------------|--------------|
| Bits | 31 | 30 | 29 | 28 | 27 | 26 | 25 | 24 | 23 | 22 | 21 | 20 | 19 | 18 | 17 | 16 |
| R | 0 | | | | | PLL_ ABO RTED | TC3_ ABO RTED | SW_ ABO RTED | 0 | SEQ_T_STATUS | | | | | | |
| W | [Greyed out] | | | | | | | | | | | | | | | |
| Reset | 0 | 0 | 0 | 0 | 0 | u | u | u | 0 | 0 | u | u | u | u | u | u |
| Bits | 15 | 14 | 13 | 12 | 11 | 10 | 9 | 8 | 7 | 6 | 5 | 4 | 3 | 2 | 1 | 0 |
| R | TMR2_SEQ_TRIG_ARMED | RX_M ODE | RX_TIMEOUT_PENDING | NEW_SEQ_INHIBIT | SEQ_IDLE | XCVSEQ_ACTUAL | | | CONTINUOUS_EN | FORCE_RC_ERROR | NO_RX_CYCLE | LATCH_PRamble | EVENT_TMR_DO_NOT_LATCH | CLR_NEW_SEQ_INHIBIT | 0 | |
| W | [Greyed out] | | | | | | | | [Greyed out] | [Greyed out] | [Greyed out] | [Greyed out] | [Greyed out] | [Greyed out] | [Greyed out] | [Greyed out] |
| Reset | u | u | u | u | u | u | u | u | 0 | 0 | 0 | 0 | 1 | 0 | 0 | 0 |

45.2.3.3.31.3 Fields

| Field | Function |
|------------|-----------|
| 31-27 — | Reserved. |

Table continues on the next page...

Radio Register Overview

| Field | Function |
|-------------------------------|--|
| 26 PLL_ABORTED | Autosequence has terminated due to an PLL unlock event when asserted, indicates that the autosequence has terminated due to an PLL unlock event. This bit is valid at the SEQIRQ interrupt. Hardware will maintain this bit asserted until the next autosequence commences. Read-only bit. |
| 25 TC3_ABORTED | autosequence has terminated due to an TMR3 timeout when asserted, indicates that the autosequence has terminated due to an TC3 (TMR3) timeout during a receive operation. This bit is valid at the SEQIRQ interrupt. Hardware will maintain this bit asserted until the next autosequence commences. Read-only bit. |
| 24 SW_ABORTED | Autosequence has terminated due to a Software abort. when asserted, indicates that the autosequence has terminated due to an Software abort. Software can abort any programmed autosequence by writing Sequence I to XCVSEQ. This bit is valid at the SEQIRQ interrupt. Hardware will maintain this bit asserted until the next autosequence commences. Read-only bit. |
| 23-22 — | Reserved. |
| 21-16 SEQ_T_STATU S | Status of the just-completed or ongoing Sequence T or Sequence TR Status of the just-completed (or ongoing) Sequence T or Sequence TR autosequence. This register is valid at all times during, and after, the Sequence T or Sequence TR. Not valid for other types of autosequences. This is a read-only register. The bits of this register map to status, according to the following table: [0] 1st CCA complete (CCABFRTX=1) [1] 2nd CCA complete (SLOTTED=1) [2] Tx operation complete [3] Rx Recycle occurred (Sequence TR only) [4] Rx operation complete (Sequence TR only) [5] TxAck operation complete(Sequence TR only) |
| 15 TMR2_SEQ_TR IG_ARMED | indicates that TMR2 has been programmed and is armed to trigger a new autosequence when asserted, indicates that TMR2 has been programmed and is "armed" to trigger a new autosequence, when 802.15.4 Sequence Manager timer-triggering mode is selected (i.e., TMRTRIGEN=1). When timer-triggering mode is selected, TMR2 must be re-programmed (using either T2CMP or T2PRIMECMP), in advance of each new sequence. Once TMR2 is programmed, this bit will be asserted, and will remain asserted until the new sequence commences (at TMR2 match). Hardware will deassert this bit when the new sequence starts. When TMRTRIGEN=0, this bit should be ignored. Read-only bit. |
| 14 RX_MODE | RX Operation in Progress when asserted, this Sequence Manager Output indicates that an RX operation is in progress. An RX operation can be part of a complex transmit autosequence such as a Sequence TR. CCA and ED operations are considered RX operations, during which rx_mode is asserted. Read-only bit. |
| 13 RX_TIMEOUT_ PENDING | Indicates a TMR3 RX Timeout is Pending when asserted, indicates that a TMR3 timeout (RX timeout) flag has been set by Hardware, but the Sequence Manager has not yet aborted because an RX operation is not currently underway. This would be the case, for example, during a Sequence TR, if a TMR3 timeout were to occur during the transmit operation of this sequence; the sequence would not be aborted by Hardware until the receive operation begins. This bit will always be 0 if TC3TMOUT=0. Read-only bit. |
| 12 NEW_SEQ_INH IBIT | New Sequence Inhibit When asserted, indicates that a new programmed autosequence has commenced (TMR2 match has occurred if TMRTRIGEN=1). Once this bit is asserted, software is blocked from commanding any "new" |

Table continues on the next page...

| Field | Function |
|-----------------------------|---|
| | autosequences (other than Sequence I to abort the current sequence), until the current sequence completes. Hardware will ignore a sequence-change command from software while this bit is asserted. Hardware will automatically deassert this bit once the sequence completes. Read-only bit. |
| 11 SEQ_IDLE | SM Sequence Idle Indicator |
| 10-8 XCVSEQ_ACTUAL | Indicates the programmed sequence that has been recognized by the ZSM Sequence Manager Reflects the programmed sequence that has been recognized by the 802.15.4 Sequence Manager. Takes into account the fact that sequence-change commands from software are ignored while a sequence is underway (see NEW_SEQ_INHIBIT). Read-only bits. |
| 7 CONTINUOUS_EN | Enable Continuous TX or RX Mode Continuous Mode Enable (Continuous TX or RX). Note: Dual PAN mode should not be engaged in Continuous TX or RX modes. 0b - normal operation 1b - Continuous TX or RX mode is enabled (depending on XCVSEQ setting). |
| 6 FORCE_CRC_ERROR | Induce a CRC Error in Transmitted Packets 0b - normal operation 1b - Force the next transmitted packet to have a CRC error |
| 5 NO_RX_RECYCLE | Disable Automatic RX Sequence Recycling when asserted, prevents the 802.15.4 Sequence Manager (ZSM) from automatically re-starting (recycling) the receiver when a packet is received which results in a FilterFail or CRC failure. Normally, on a RX recycle, the ZSM returns to the RX_WU (warmup) state, and then resumes from there with a new, foreshortened, Rx warmup, in search of a new preamble. When this bit is set, the Sequence Manager will instead return to idle state, and issue a SEQIRQ, after a FilterFail or CRC failure. |
| 4 LATCH_PREAMBLE | Stickiness Control for Preamble Detection 0b - Don't make PREAMBLE_DET and SFD_DET bits of PHY_STS (SEQ_STATE) Register "sticky", i.e. these status bits reflect the realtime, dynamic state of preamble_detect and sfd_detect 1b - Make PREAMBLE_DET and SFD_DET bits of PHY_STS (SEQ_STATE) Register "sticky", i.e., occurrences of preamble and SFD detection are latched and held until the start of the next autosequence |
| 3 EVENT_TMR_DO_NOT_LATCH | Overrides the automatic hardware latching of the Event Timer when asserted, overrides the automatic hardware latching of the Event Timer that prevents the timer from updating while software reads the 3 Event Timer bytes. This allows the Event Timer LS byte to continue to update without reading the upper 2 bytes. Overriding the automatic latching of the Event Timer should be used with caution, as it can allow the Event Timer lower bytes to get out-of-sync with the upper bytes. However, it can be useful when polling the Event Timer LS byte for a value that is just a few counts in the future. |
| 2 CLR_NEW_SEQ_INHIBIT | Overrides the automatic hardware locking of the programmed XCVSEQ while an autosequence is underway when asserted, overrides the automatic hardware locking of the programmed XCVSEQ while an autosequence is underway. Asserting this feature will allow software to change the programmed autosequence "on-the-fly", without aborting and returning to idle between sequences. Overriding the hardware lockout of XCVSEQ should be used with caution, since the Sequence Manager is not designed (or verified) for manual state transitions between one type of autosequence and other (i.e., Sequence T -> Sequence R). |
| 1-0 — | Reserved. |

45.2.3.3.32 ACK DELAY (ACKDELAY)

45.2.3.3.32.1 Address

| Register | Offset |
|----------|-----------|
| ACKDELAY | 4005D07Ch |

45.2.3.3.32.2 Function

Provides a fine-tune adjustment of the time delay between Rx warmdown and the beginning of Tx warmup for an autoTxAck packet.

45.2.3.3.32.3 Diagram

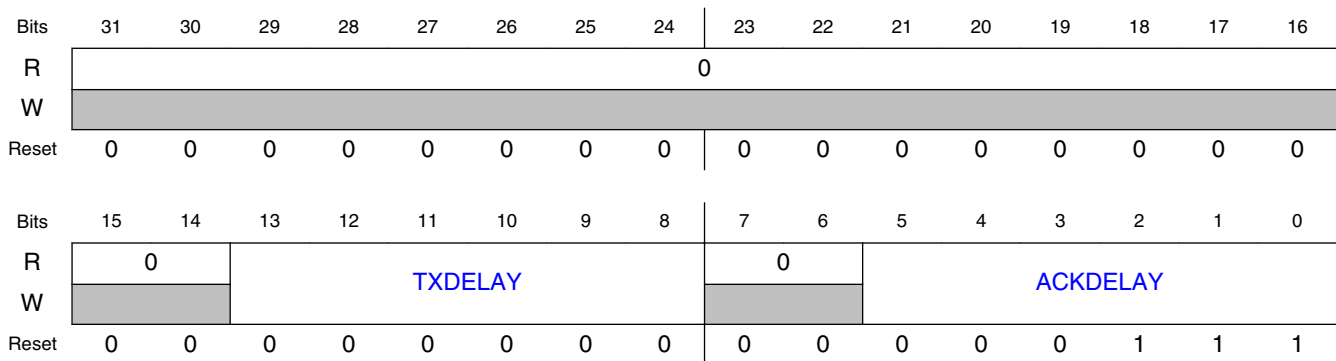

45.2.3.3.32.4 Fields

| Field | Function |
|-------------------|---|
| 31-14 Reserved | Reserved. |
| 13-8 TXDELAY | TX Delay Provides a fine-tune adjustment of the time delay between post-CCA Rx warm-down and the beginning of Tx warm-up for an Tx (non-Ack) packet. TXDELAY register will apply in both SLOTTED and UNSLOTTED modes, but only to T sequences (e.g., T, TR, and T(R)), not TxAck operations. This is a two's complement value. The minimum permissible value is -19 (0x2D). Values less than -19 will lead to unexpected results. Resolution = 2us. Range = +/- 62us. Max TXDELAY = 0x1F. Min TXDELAY = 0x2D. |
| 7-6 | Reserved. |

Table continues on the next page...

| Field | Function |
|-----------------|--|
| — | |
| 5-0 ACKDELAY | <p>ACK Delay</p> <p>Provides a fine-tune adjustment of the time delay between Rx warmdown and the beginning of Tx warmup for an Tx Acknowledge packet. ACKDELAY register will apply to both SLOTTED and UNSLOTTED TxAck, but only to TxAck (not T sequences). This is a two's complement value. The minimum permissible value is -19 (0x2D). Values less than -19 will lead to unexpected results.</p> <p>Resolution = 2us.</p> <p>Range = +/- 62us.</p> <p>Max ACKDELAY = 0x1F.</p> <p>Min ACKDELAY = 0x2D.</p> |

45.2.3.3.33 FILTER FAIL CODE (FILTERFAIL_CODE)

45.2.3.3.33.1 Address

| Register | Offset |
|-----------------|-----------|
| FILTERFAIL_CODE | 4005D080h |

45.2.3.3.33.2 Diagram

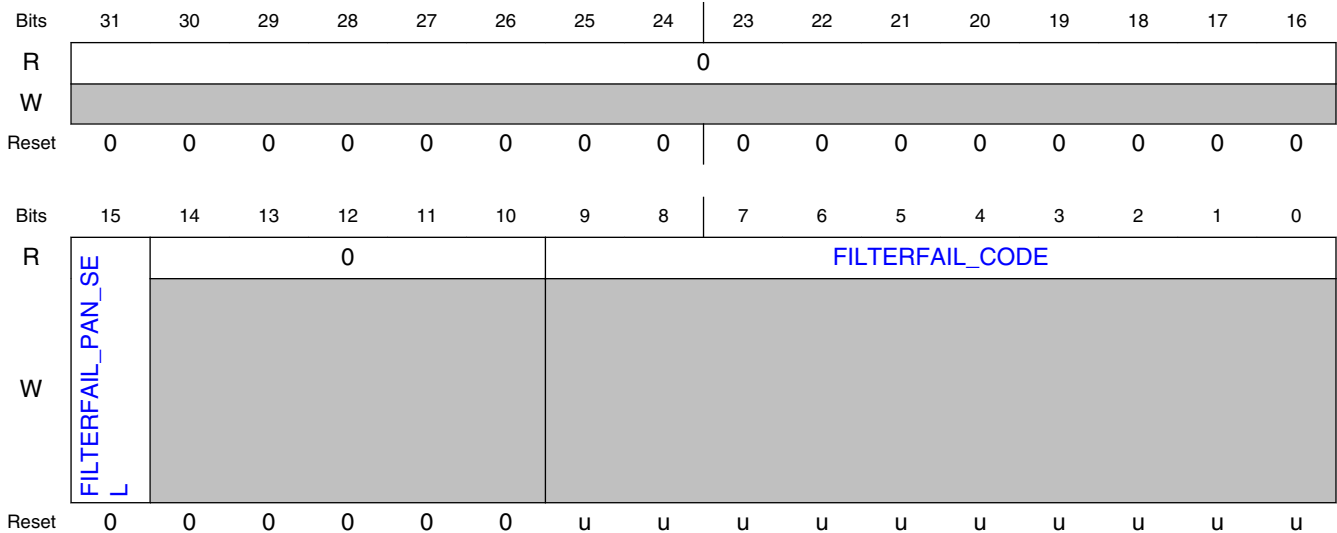

45.2.3.3.33.3 Fields

| Field | Function | | | | | | | | | | | | | | | | | | | | | | |
|--------------------------|--|---------------------|-----------------------|-----|--|-----|--|-----|---|-----|--------------------------------------|-----|---|-----|--|-----|---|-----|---|-----|---|-----|---|
| 31-16 — | Reserved. | | | | | | | | | | | | | | | | | | | | | | |
| 15 FILTERFAIL_PAN_SEL | PAN Selector for Filter Fail Code 0b - FILTERFAIL_CODE[9:0] will report the FILTERFAIL status of PAN0 1b - FILTERFAIL_CODE[9:0] will report the FILTERFAIL status of PAN1 | | | | | | | | | | | | | | | | | | | | | | |
| 14-10 — | Reserved. | | | | | | | | | | | | | | | | | | | | | | |
| 9-0 FILTERFAIL_CODE | Filter Fail Code Code indicating what condition, or conditions, caused the Packet Processor to reject the just-received packet. The bits of FILTERFAIL_CODE indicate the reason for packet rejection according to the table below: | | | | | | | | | | | | | | | | | | | | | | |
| | <table border="1"> <thead> <tr> <th>FILTERFAIL CODE BIT</th> <th>REASON FOR FILTERFAIL</th> </tr> </thead> <tbody> <tr> <td>[0]</td> <td>Fails Stage 1 Frame Length Checking (FL < 5 or FL > MAXFRAMELENGTH) Note: FL < 3 will not generate an SFD, so this bit will not be set</td> </tr> <tr> <td>[1]</td> <td>Fails Stage 1 Section 7.2.1.1.6 or Section 7.2.1.1.8 Checking (DST_ADDR_MODE or SRC_ADDR_MODE = 1)</td> </tr> <tr> <td>[2]</td> <td>Fails Stage 1 Section 7.2.1.1.5 Checking (Illegal PAN_ID_COMPRESSION Usage)</td> </tr> <tr> <td>[3]</td> <td>Fails Stage 1 Frame Version Checking</td> </tr> <tr> <td>[4]</td> <td>Fails Stage 2 Auto-RxAck Checking (Illegal Ack Frame Format in Sequence TR)</td> </tr> <tr> <td>[5]</td> <td>Fails Stage 2 Frame Type Checking (Incorrect Frame Filter Bit setting)</td> </tr> <tr> <td>[6]</td> <td>Fails Stage 2 Frame Length Checking (Illegal Beacon, Data, or Cmd FL)</td> </tr> <tr> <td>[7]</td> <td>Fails Stage 2 Addressing Mode Checking (Illegal Addressing Mode for Beacon, Data, OR Cmd)</td> </tr> <tr> <td>[8]</td> <td>Fails Stage 2 Sequence Number Matching (Sequence TR Only)</td> </tr> <tr> <td>[9]</td> <td>Fails Stage 2 PAN ID or Address Checking (Beacon, Data, or Cmd)</td> </tr> </tbody> </table> | FILTERFAIL CODE BIT | REASON FOR FILTERFAIL | [0] | Fails Stage 1 Frame Length Checking (FL < 5 or FL > MAXFRAMELENGTH) Note: FL < 3 will not generate an SFD, so this bit will not be set | [1] | Fails Stage 1 Section 7.2.1.1.6 or Section 7.2.1.1.8 Checking (DST_ADDR_MODE or SRC_ADDR_MODE = 1) | [2] | Fails Stage 1 Section 7.2.1.1.5 Checking (Illegal PAN_ID_COMPRESSION Usage) | [3] | Fails Stage 1 Frame Version Checking | [4] | Fails Stage 2 Auto-RxAck Checking (Illegal Ack Frame Format in Sequence TR) | [5] | Fails Stage 2 Frame Type Checking (Incorrect Frame Filter Bit setting) | [6] | Fails Stage 2 Frame Length Checking (Illegal Beacon, Data, or Cmd FL) | [7] | Fails Stage 2 Addressing Mode Checking (Illegal Addressing Mode for Beacon, Data, OR Cmd) | [8] | Fails Stage 2 Sequence Number Matching (Sequence TR Only) | [9] | Fails Stage 2 PAN ID or Address Checking (Beacon, Data, or Cmd) |
| FILTERFAIL CODE BIT | REASON FOR FILTERFAIL | | | | | | | | | | | | | | | | | | | | | | |
| [0] | Fails Stage 1 Frame Length Checking (FL < 5 or FL > MAXFRAMELENGTH) Note: FL < 3 will not generate an SFD, so this bit will not be set | | | | | | | | | | | | | | | | | | | | | | |
| [1] | Fails Stage 1 Section 7.2.1.1.6 or Section 7.2.1.1.8 Checking (DST_ADDR_MODE or SRC_ADDR_MODE = 1) | | | | | | | | | | | | | | | | | | | | | | |
| [2] | Fails Stage 1 Section 7.2.1.1.5 Checking (Illegal PAN_ID_COMPRESSION Usage) | | | | | | | | | | | | | | | | | | | | | | |
| [3] | Fails Stage 1 Frame Version Checking | | | | | | | | | | | | | | | | | | | | | | |
| [4] | Fails Stage 2 Auto-RxAck Checking (Illegal Ack Frame Format in Sequence TR) | | | | | | | | | | | | | | | | | | | | | | |
| [5] | Fails Stage 2 Frame Type Checking (Incorrect Frame Filter Bit setting) | | | | | | | | | | | | | | | | | | | | | | |
| [6] | Fails Stage 2 Frame Length Checking (Illegal Beacon, Data, or Cmd FL) | | | | | | | | | | | | | | | | | | | | | | |
| [7] | Fails Stage 2 Addressing Mode Checking (Illegal Addressing Mode for Beacon, Data, OR Cmd) | | | | | | | | | | | | | | | | | | | | | | |
| [8] | Fails Stage 2 Sequence Number Matching (Sequence TR Only) | | | | | | | | | | | | | | | | | | | | | | |
| [9] | Fails Stage 2 PAN ID or Address Checking (Beacon, Data, or Cmd) | | | | | | | | | | | | | | | | | | | | | | |

45.2.3.3.34 RECEIVE WATER MARK (RX_WTR_MARK)

45.2.3.3.34.1 Address

| Register | Offset |
|-------------|-----------|
| RX_WTR_MARK | 4005D084h |

45.2.3.3.34.2 Diagram

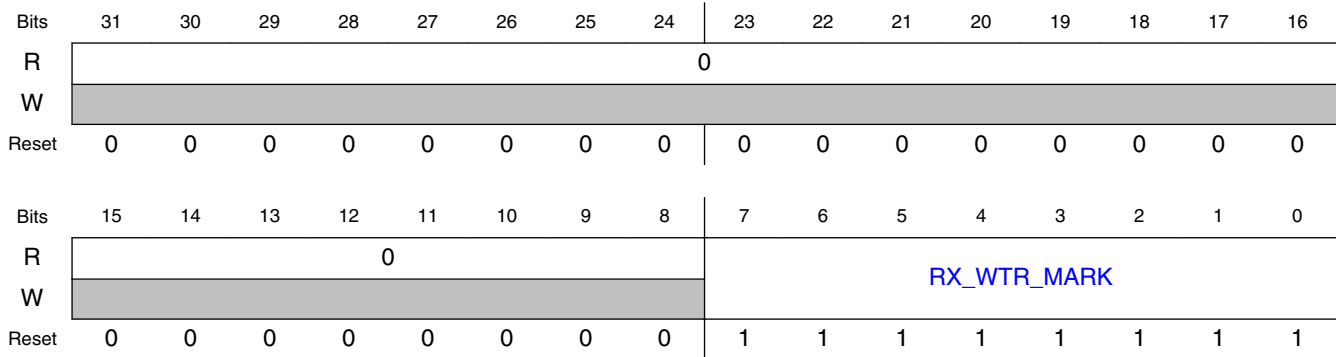

45.2.3.3.34.3 Fields

| Field | Function |
|--------------------|--|
| 31-8 Reserved | Reserved. |
| 7-0 RX_WTR_MARK | RECEIVE WATER MARK Receive byte count (octets) needed to trigger a RXWTRMRKIRQ interrupt . A setting of 0 generates an interrupt at end of the Frame Length field (first byte after SFD). A setting of 1 generates an interrupt after the first byte of Frame Control Field, etc. |

45.2.3.3.35 SLOT PRELOAD (SLOT_PRELOAD)

45.2.3.3.35.1 Address

| Register | Offset |
|--------------|-----------|
| SLOT_PRELOAD | 4005D08Ch |

45.2.3.3.35.2 Function

Slotted Mode Preload

45.2.3.3.35.3 Diagram

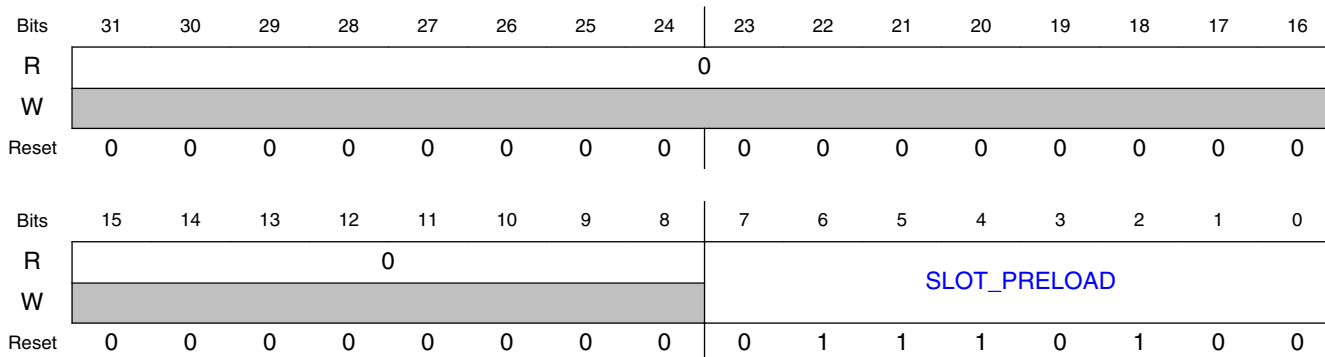

45.2.3.3.35.4 Fields

| Field | Function |
|---------------------|--|
| 31-8 Reserved | Reserved. |
| 7-0 SLOT_PRELOAD | Slotted Mode Preload This register represents the number that gets loaded into the slot_timer at SFD detect, which ultimately determines when the next slot boundary will occur. Due to processing delays within the analog front-end and digital modem, the point at which SFD is detected by the modem, is delayed relative to over-the-air timing. This register setting compensates for that delay. This timing parameter is critical for the Sequence R autosequence in slotted mode, when an automatic TxAck is required. |

45.2.3.3.36 802.15.4 SEQUENCE STATE (SEQ_STATE)

45.2.3.3.36.1 Address

| Register | Offset |
|-----------|-----------|
| SEQ_STATE | 4005D090h |

45.2.3.3.36.2 Function

802.15.4 Sequence State Register

45.2.3.3.36.3 Diagram

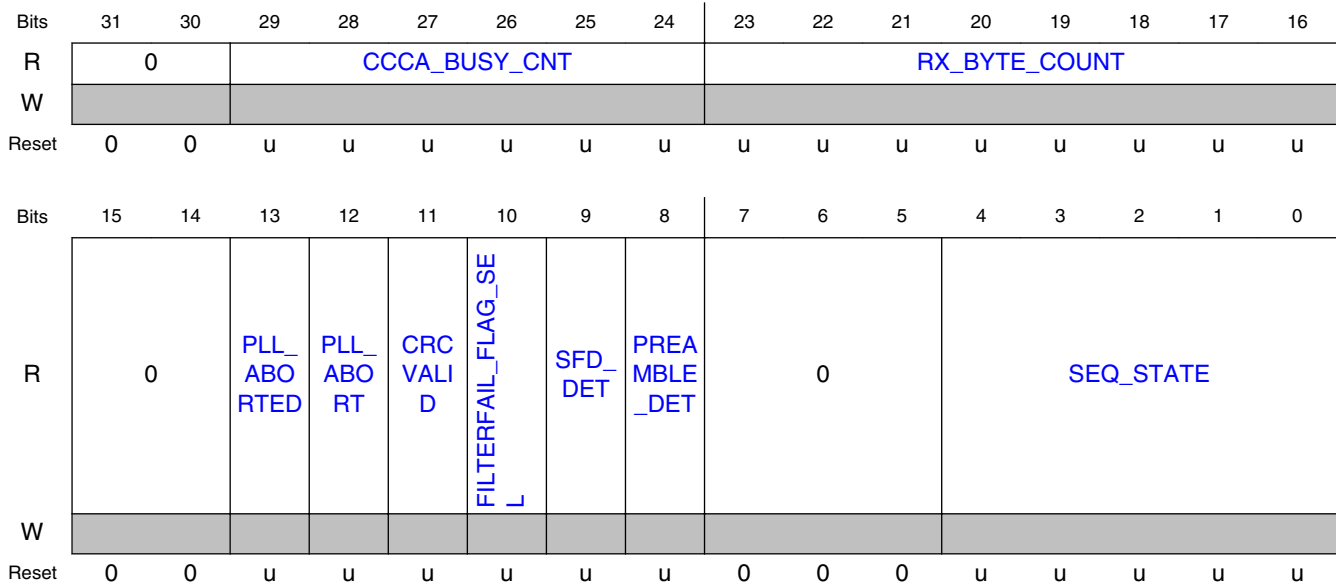

45.2.3.3.36.4 Fields

| Field | Function |
|------------------------|---|
| 31-30 — | Reserved. |
| 29-24 CCCA_BUSY_CNT | Number of CCA Measurements resulting in Busy Channel For Sequence CCA mode only, this register indicates the number of "busy" CCA attempts which occurred during the autosequence, before the channel was detected to be idle. This register can also be read in real-time (during the autosequence) to determine how many busy CCA attempts have occurred to that point. The register saturates at 63 (i.e, if there are more than 63 busy attempts, the register will continue to read 63). This register is automatically cleared to zero by hardware when the next autosequence commences. Read-only register. |
| 23-16 RX_BYTE_COUNT | Realtime Received Byte Count During packet reception, this read-only register is a real-time indicator of the number of bytes that have been received. This register will read 0 until SFD and PHR have been received. It will read 1 after the first byte of Frame Control Field has been received, etc. |
| 15-14 — | Reserved. |
| 13 PLL_ABORTED | Autosequence has terminated due to an PLL unlock event when asserted, indicates that the autosequence has terminated due to an PLL unlock event. This bit is valid at the SEQIRQ interrupt. Hardware will maintain this bit asserted until the next autosequence commences. This bit is a read-only mirror of the register bit of the same name in the ABORT_STS (SEQ_CTRL_STS) register. |
| 12 PLL_ABORT | Raw PLL Abort Signal This bit reflects the instantaneous, consolidated status of the PLL unlock detection circuits; if asserted high, indicates that at least one of the three PLL unlock detect mechanisms is currently reporting an unlocked condition. |

Table continues on the next page...

Radio Register Overview

| Field | Function |
|---------------------------|---|
| 11 CRCVALID | <p>CRC Valid Indicator</p> <p>Cyclic Redundancy Check Valid: This flag indicates the compare result between the FCS field, in the most-recently received frame, and the internally calculated CRC value. This flag is cleared at next receiver warm up.</p> <p>0b - Rx FCS != calculated CRC (incorrect) 1b - Rx FCS = calculated CRC (correct)</p> |
| 10 FILTERFAIL_FLAG_SEL | <p>Consolidated Filter Fail Flag</p> <p>0: The incoming, or just-received packet, passed packet filtering rules. 1: The incoming, or just-received packet, failed packet filtering rules</p> <p>When FILTERFAIL_FLAG_SEL=1, a non-zero FILTERFAIL_CODE is present (see FILTERFAIL_CODE registers).</p> <p>In Dual PAN mode, FILTERFAIL_FLAG_SEL applies to either or both networks, as follows:</p> <p>A: If PAN0 and PAN1 occupy different channels and CURRENT_NETWORK=0, FILTERFAIL_FLAG_SEL applies to PAN0. B: If PAN0 and PAN1 occupy different channels and CURRENT_NETWORK=1, FILTERFAIL_FLAG_SEL applies to PAN1. C: If PAN0 and PAN1 occupy the same channel, FILTERFAIL_FLAG_SEL is the logical 'AND' of the individual PANs' FILTERFAIL_FLAG bits.</p> |
| 9 SFD_DET | <p>SFD Detected</p> <p>0: an 802.15.4 preamble-and-SFD have not been detected. 1: An 802.15.4 preamble-and-SFD have been detected.</p> <p>The function of this read-only bit depends on the setting of the LATCH_PREAMBLE bit of the SEQ_MGR_CTRL register. If LATCH_PREAMBLE=1, any preamble-and-SFD detection during a Sequence R (even false detections), will set this bit, and it will remain set (sticky) until the start of the next autosequence. If LATCH_PREAMBLE=0, this bit is not sticky, and reflects the instantaneous state of the SFD-detection circuit; for false SFD, the bit will clear when the false nature of the SFD is recognized (i.e., an RX recycle). When LATCH_PREAMBLE=0, SFD_DET should be considered valid only while an autosequence is underway.</p> |
| 8 PREAMBLE_DETECT | <p>Preamble Detected</p> <p>0: an 802.15.4 preamble has not been detected. 1: An 802.15.4 preamble has been detected.</p> <p>The function of this read-only bit depends on the setting of the LATCH_PREAMBLE bit of the SEQ_MGR_CTRL register. If LATCH_PREAMBLE=1, any preamble detection during a Sequence R (even false detections), will set this bit, and it will remain set (sticky) until the start of the next autosequence. If LATCH_PREAMBLE=0, this bit is not sticky, and reflects the instantaneous state of the preamble-detection circuit; for false preambles, the bit will clear when the false nature of the preamble is recognized. When LATCH_PREAMBLE=0, PREAMBLE_DET should be considered valid only while an autosequence is underway.</p> |
| 7-5 — | Reserved. |
| 4-0 SEQ_STATE | <p>ZSM Sequence State</p> <p>This read-only register reflects the instantaneous state of the 802.15.4 Sequence Manager</p> |

45.2.3.3.37 TIMER PRESCALER (TMR_PRESCALE)

45.2.3.3.37.1 Address

| Register | Offset |
|--------------|-----------|
| TMR_PRESCALE | 4005D094h |

45.2.3.3.37.2 Function

Timer Prescaler Control Register

45.2.3.3.37.3 Diagram

| | | | | | | | | | | | | | | | | | |
|-------|----|----|----|----|----|----|----|----|----|----|----|----|----|----|----|--------------|---|
| Bits | 31 | 30 | 29 | 28 | 27 | 26 | 25 | 24 | 23 | 22 | 21 | 20 | 19 | 18 | 17 | 16 | |
| R | 0 | | | | | | | | | | | | | | | | |
| W | | | | | | | | | | | | | | | | | |
| Reset | 0 | 0 | 0 | 0 | 0 | 0 | 0 | 0 | 0 | 0 | 0 | 0 | 0 | 0 | 0 | 0 | |
| Bits | 15 | 14 | 13 | 12 | 11 | 10 | 9 | 8 | 7 | 6 | 5 | 4 | 3 | 2 | 1 | 0 | |
| R | 0 | | | | | | | | | | | | | | | TMR_PRESCALE | |
| W | | | | | | | | | | | | | | | | | |
| Reset | 0 | 0 | 0 | 0 | 0 | 0 | 0 | 0 | 0 | 0 | 0 | 0 | 0 | 0 | 1 | 0 | 1 |

45.2.3.3.37.4 Fields

| Field | Function |
|---------------------|--|
| 31-3 Reserved | Reserved. |
| 2-0 TMR_PRESCALE | <p>Timer Prescaler</p> <p>Timer Prescaler. Establishes the Event Timer clock rate, (maximum timer duration)</p> <p>Note:To take advantage of the EVENT_TMR Fractional bits for 802.15.4 DSM mode, only the default setting ("5", or 62.5KHz) is allowed.</p> <ul style="list-style-type: none"> 000b - Reserved 001b - Reserved 010b - 500kHz (33.55 S) 011b - 250kHz (67.11 S) 100b - 125kHz (134.22 S) 101b - 62.5kHz (268.44 S) -- default 110b - 31.25kHz (536.87 S) 111b - 15.625kHz (1073.74 S) |

45.2.3.3.38 LENIENCY_LSB (LENIENCY_LSB)

45.2.3.3.38.1 Address

| Register | Offset |
|--------------|-----------|
| LENIENCY_LSB | 4005D098h |

45.2.3.3.38.2 Function

Packet Processor Leniency Bits (LSB)

45.2.3.3.38.3 Diagram

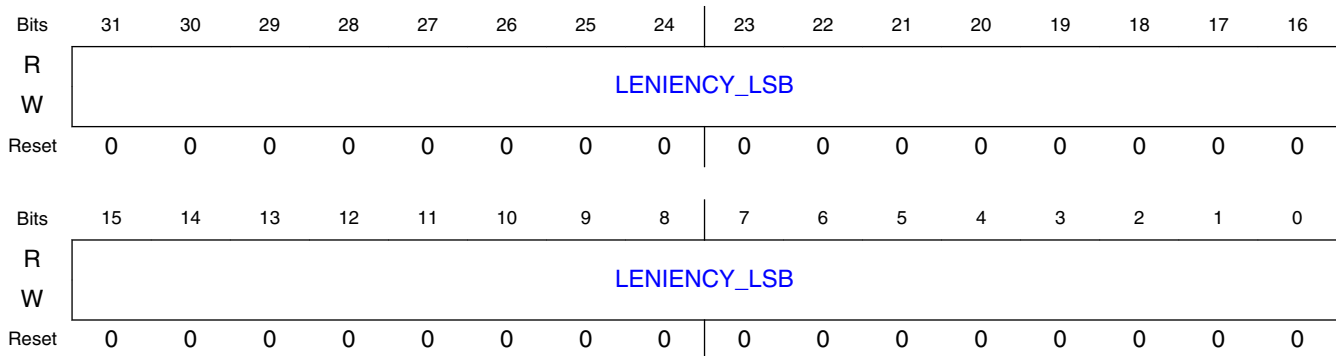

45.2.3.3.38.4 Fields

| Field | Function | | | | | | | | | | |
|----------------------|--|--------------|----------------------------------|-------------|--|-------------|---|-------------|---|-------------|--|
| 31-0 LENIENCY_LSB | <p>Leniency LSB Register</p> <p>The Packet Processor performs filtering on all received packets, in order to determine whether the packet is intended for the device. The packet filtering is based on rules. In case any of the packet filtering rules need to be overridden, a 40-bit "leniency register" has been provided. When the leniency register is programmed to its default value (0), all hardware packet filtering rules are in effect, and if an incoming packet violates any rule, a "Filter Fail" will occur (packet will be rejected). When a given leniency register bit is asserted, the packet filtering rule assigned to that bit will not be in effect, and if any incoming packet violates that rule (but no other rules), then a "Filter Fail" will not occur, the packet will not be rejected, the packet will be treated as "intended for the device", and software will be notified of the incoming packet. The table below shows the assignment of leniency bits to packet filtering rules.</p> <table border="1"> <thead> <tr> <th>LENIENCY BIT</th> <th>PACKET FILTERING RULE OVERRIDDEN</th> </tr> </thead> <tbody> <tr> <td>leniency[0]</td> <td>Override Stage 1 Frame Length Checking (FL < 5 or FL > MAXFRAMELENGTH)</td> </tr> <tr> <td>leniency[1]</td> <td>Override Stage 1 Section 7.2.1.1.6 Checking (DST_ADDR_MODE = 1)</td> </tr> <tr> <td>leniency[2]</td> <td>Override Stage 1 Section 7.2.1.1.8 Checking (SRC_ADDR_MODE = 1)</td> </tr> <tr> <td>leniency[3]</td> <td>Override Stage 1 Section 7.2.1.1.5 Checking (Illegal PAN_ID_COMPRESSION Usage)</td> </tr> </tbody> </table> | LENIENCY BIT | PACKET FILTERING RULE OVERRIDDEN | leniency[0] | Override Stage 1 Frame Length Checking (FL < 5 or FL > MAXFRAMELENGTH) | leniency[1] | Override Stage 1 Section 7.2.1.1.6 Checking (DST_ADDR_MODE = 1) | leniency[2] | Override Stage 1 Section 7.2.1.1.8 Checking (SRC_ADDR_MODE = 1) | leniency[3] | Override Stage 1 Section 7.2.1.1.5 Checking (Illegal PAN_ID_COMPRESSION Usage) |
| LENIENCY BIT | PACKET FILTERING RULE OVERRIDDEN | | | | | | | | | | |
| leniency[0] | Override Stage 1 Frame Length Checking (FL < 5 or FL > MAXFRAMELENGTH) | | | | | | | | | | |
| leniency[1] | Override Stage 1 Section 7.2.1.1.6 Checking (DST_ADDR_MODE = 1) | | | | | | | | | | |
| leniency[2] | Override Stage 1 Section 7.2.1.1.8 Checking (SRC_ADDR_MODE = 1) | | | | | | | | | | |
| leniency[3] | Override Stage 1 Section 7.2.1.1.5 Checking (Illegal PAN_ID_COMPRESSION Usage) | | | | | | | | | | |

| Field | Function | |
|--------------|---------------------|--|
| | LENIENCY BIT | PACKET FILTERING RULE OVERRIDDEN |
| leniency[4] | | Override Stage 2 Auto-RxAck Checking (Illegal Ack Frame Format in Sequence TR) |
| leniency[5] | | Override Stage 2 Frame Length Checking (Illegal Beacon, Data, or Cmd FL) |
| leniency[6] | | Override Stage 2 Beacon Frame Address Mode Violations |
| leniency[7] | | Override Stage 2 Data Frame Address Mode Violations |
| leniency[8] | | Override Stage 2 MAC Command Frame Address Mode Violations |
| leniency[9] | | Override Stage 2 Sequence Number Matching |
| leniency[10] | | Override Stage 2 Filter for DST_ADDR_MODE_NONE/ SRC_ADDR_MODE_SHORT (Beacon Only) |
| leniency[11] | | Override Stage 2 Filter for DST_ADDR_MODE_NONE/ SRC_ADDR_MODE_SHORT (Data and MAC Command Only) |
| leniency[12] | | Override Stage 2 Dst PAN ID Filter for DST_ADDR_MODE_SHORT/ SRC_ADDR_MODE_NONE (Data and MAC Command Only) |
| leniency[13] | | Override Stage 2 Dst Short Addr Filter for DST_ADDR_MODE_SHORT/ SRC_ADDR_MODE_NONE (Data and MAC Command Only) |
| leniency[14] | | Override Stage 2 PAN ID Filter for DST_ADDR_MODE_SHORT/ SRC_ADDR_MODE_SHORT/PAN_ID_COMPRESSION (Beacon Only) |
| leniency[15] | | Override Stage 2 PAN ID Filter for DST_ADDR_MODE_SHORT/ SRC_ADDR_MODE_SHORT/PAN_ID_COMPRESSION (Data and MAC Command Only) |
| leniency[16] | | Override Stage 2 Dst Short Addr Filter for DST_ADDR_MODE_SHORT/ SRC_ADDR_MODE_SHORT/PAN_ID_COMPRESSION (Data and MAC Command Only) |
| leniency[17] | | Override Stage 2 PAN ID Filter for DST_ADDR_MODE_SHORT/ SRC_ADDR_MODE_SHORT/NO_PAN_ID_COMPRESSION (Beacon Only) |
| leniency[18] | | Override Stage 2 PAN ID Filter for DST_ADDR_MODE_SHORT/ SRC_ADDR_MODE_SHORT/NO_PAN_ID_COMPRESSION (Data and MAC Command Only) |
| leniency[19] | | Override Stage 2 Dst Addr Filter for DST_ADDR_MODE_SHORT/ SRC_ADDR_MODE_SHORT/NO_PAN_ID_COMPRESSION (Data and MAC Command Only) |
| leniency[20] | | Override Stage 2 Src PAN ID Filter for DST_ADDR_MODE_NONE/ SRC_ADDR_MODE_LONG/NO_PAN_ID_COMPRESSION (Beacon Only) |
| leniency[21] | | Override Stage 2 Src PAN ID Filter for DST_ADDR_MODE_NONE/ SRC_ADDR_MODE_LONG/NO_PAN_ID_COMPRESSION (Data and MAC Command Only) |
| leniency[22] | | Override Stage 2 Dst PAN ID Filter for DST_ADDR_MODE_LONG/ SRC_ADDR_MODE_NONE (Data and MAC Command Only) |
| leniency[23] | | Override Stage 2 Dst Long Addr Filter for DST_ADDR_MODE_LONG/ SRC_ADDR_MODE_NONE (Data and MAC Command Only) |
| leniency[24] | | Override Stage 2 PAN ID Filter for DST_ADDR_MODE_SHORT/ SRC_ADDR_MODE_LONG/PAN_ID_COMPRESSION (Beacon Only) |
| leniency[25] | | Override Stage 2 PAN ID Filter for DST_ADDR_MODE_SHORT/ SRC_ADDR_MODE_LONG/PAN_ID_COMPRESSION (Data and MAC Command Only) |

Radio Register Overview

| Field | Function | |
|-------|---------------------|--|
| | LENIENCY BIT | PACKET FILTERING RULE OVERRIDDEN |
| | leniency[26] | Override Stage 2 Dst Long Addr Filter for DST_ADDR_MODE_SHORT/ SRC_ADDR_MODE_LONG/PAN_ID_COMPRESSION (Data and MAC Command Only) |
| | leniency[27] | Override Stage 2 PAN ID Filter for DST_ADDR_MODE_LONG/ SRC_ADDR_MODE_SHORT/PAN_ID_COMPRESSION (Beacon Only) |
| | leniency[28] | Override Stage 2 PAN ID Filter for DST_ADDR_MODE_LONG/ SRC_ADDR_MODE_SHORT/PAN_ID_COMPRESSION (Data and Mac Command Only) |
| | leniency[29] | Override Stage 2 Dst Long Addr Filter for DST_ADDR_MODE_LONG/ SRC_ADDR_MODE_SHORT/PAN_ID_COMPRESSION (Data and Mac Command Only) |
| | leniency[30] | Override Stage 2 PAN ID Filter for DST_ADDR_MODE_SHORT/ SRC_ADDR_MODE_LONG/NO_PAN_ID_COMPRESSION (Beacon Only) |
| | leniency[31] | Override Stage 2 PAN ID Filter for DST_ADDR_MODE_SHORT/ SRC_ADDR_MODE_LONG/NO_PAN_ID_COMPRESSION (Data and MAC Command Only) |

45.2.3.3.39 LENIENCY MSB (LENIENCY_MSB)

45.2.3.3.39.1 Address

| Register | Offset |
|--------------|-----------|
| LENIENCY_MSB | 4005D09Ch |

45.2.3.3.39.2 Function

Packet Processor Leniency Bits (MSB)

45.2.3.3.39.3 Diagram

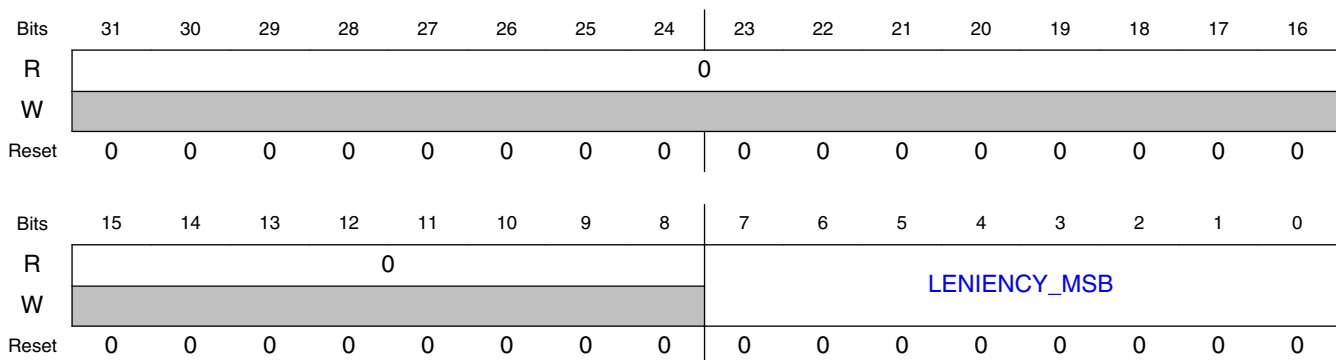

45.2.3.3.39.4 Fields

| Field | Function | | | | | | | | | | | | | | | | | | |
|---------------------|--|--------------|----------------------------------|--------------|--|--------------|---|--------------|--|--------------|---|--------------|--|--------------|--|--------------|---|--------------|---|
| 31-8 Reserved | Reserved. | | | | | | | | | | | | | | | | | | |
| 7-0 LENIENCY_MSB | <p>Leniency MSB Register</p> <p>The Packet Processor performs filtering on all received packets, in order to determine whether the packet is intended for the device. The packet filtering is based on rules. In case any of the packet filtering rules need to be overridden, a 40-bit "leniency register" has been provided. When the leniency register is programmed to its default value (0), all hardware packet filtering rules are in effect, and if an incoming packet violates any rule, a "Filter Fail" will occur (packet will be rejected). When a given leniency register bit is asserted, the packet filtering rule assigned to that bit will not be in effect, and if any incoming packet violates that rule (but no other rules), then a "Filter Fail" will not occur, the packet will not be rejected, the packet will be treated as "intended for the device", and software will be notified of the incoming packet. The table below shows the assignment of leniency bits to packet filtering rules.</p> <table border="1"> <thead> <tr> <th>LENIENCY BIT</th> <th>PACKET FILTERING RULE OVERRIDDEN</th> </tr> </thead> <tbody> <tr> <td>leniency[32]</td> <td>Override Stage 2 Short Addr Filter for DST_ADDR_MODE_SHORT/ SRC_ADDR_MODE_LONG/NO_PAN_ID_COMPRESSION (Data and MAC Command Only)</td> </tr> <tr> <td>leniency[33]</td> <td>Override Stage 2 PAN ID Filter for DST_ADDR_MODE_LONG/ SRC_ADDR_MODE_SHORT/NO_PAN_ID_COMPRESSION (Beacon Only)</td> </tr> <tr> <td>leniency[34]</td> <td>Override Stage 2 PAN ID Filter for DST_ADDR_MODE_LONG/ SRC_ADDR_MODE_SHORT/NO_PAN_ID_COMPRESSION (Data and MAC Command Only)</td> </tr> <tr> <td>leniency[35]</td> <td>Override Stage 2 Long Addr Filter for DST_ADDR_MODE_LONG/ SRC_ADDR_MODE_SHORT/NO_PAN_ID_COMPRESSION (Data and MAC Command Only)</td> </tr> <tr> <td>leniency[36]</td> <td>Override Stage 2 PAN ID Filter for DST_ADDR_MODE_LONG/ SRC_ADDR_MODE_LONG (Beacon Only)</td> </tr> <tr> <td>leniency[37]</td> <td>Override Stage 2 PAN ID Filter for DST_ADDR_MODE_LONG/ SRC_ADDR_MODE_LONG (Data and MAC Command Only)</td> </tr> <tr> <td>leniency[38]</td> <td>Override Stage 2 Long Addr Filter for DST_ADDR_MODE_LONG/ SRC_ADDR_MODE_LONG (Data and MAC Command Only)</td> </tr> <tr> <td>leniency[39]</td> <td> <p>Allow an auto-TxAck frame to be sent, after a receive frame which has all of the following parameters:</p> <ol style="list-style-type: none"> 1. Destination PAN ID = Broadcast (0xFFFF) 2. Destination Address = !Broadcast (not 0xFFFF) 3. Destination Address Mode = Short <p>Nominally, the SEQ_MGR inhibits auto-TxAck on such frames.</p> </td> </tr> </tbody> </table> | LENIENCY BIT | PACKET FILTERING RULE OVERRIDDEN | leniency[32] | Override Stage 2 Short Addr Filter for DST_ADDR_MODE_SHORT/ SRC_ADDR_MODE_LONG/NO_PAN_ID_COMPRESSION (Data and MAC Command Only) | leniency[33] | Override Stage 2 PAN ID Filter for DST_ADDR_MODE_LONG/ SRC_ADDR_MODE_SHORT/NO_PAN_ID_COMPRESSION (Beacon Only) | leniency[34] | Override Stage 2 PAN ID Filter for DST_ADDR_MODE_LONG/ SRC_ADDR_MODE_SHORT/NO_PAN_ID_COMPRESSION (Data and MAC Command Only) | leniency[35] | Override Stage 2 Long Addr Filter for DST_ADDR_MODE_LONG/ SRC_ADDR_MODE_SHORT/NO_PAN_ID_COMPRESSION (Data and MAC Command Only) | leniency[36] | Override Stage 2 PAN ID Filter for DST_ADDR_MODE_LONG/ SRC_ADDR_MODE_LONG (Beacon Only) | leniency[37] | Override Stage 2 PAN ID Filter for DST_ADDR_MODE_LONG/ SRC_ADDR_MODE_LONG (Data and MAC Command Only) | leniency[38] | Override Stage 2 Long Addr Filter for DST_ADDR_MODE_LONG/ SRC_ADDR_MODE_LONG (Data and MAC Command Only) | leniency[39] | <p>Allow an auto-TxAck frame to be sent, after a receive frame which has all of the following parameters:</p> <ol style="list-style-type: none"> 1. Destination PAN ID = Broadcast (0xFFFF) 2. Destination Address = !Broadcast (not 0xFFFF) 3. Destination Address Mode = Short <p>Nominally, the SEQ_MGR inhibits auto-TxAck on such frames.</p> |
| LENIENCY BIT | PACKET FILTERING RULE OVERRIDDEN | | | | | | | | | | | | | | | | | | |
| leniency[32] | Override Stage 2 Short Addr Filter for DST_ADDR_MODE_SHORT/ SRC_ADDR_MODE_LONG/NO_PAN_ID_COMPRESSION (Data and MAC Command Only) | | | | | | | | | | | | | | | | | | |
| leniency[33] | Override Stage 2 PAN ID Filter for DST_ADDR_MODE_LONG/ SRC_ADDR_MODE_SHORT/NO_PAN_ID_COMPRESSION (Beacon Only) | | | | | | | | | | | | | | | | | | |
| leniency[34] | Override Stage 2 PAN ID Filter for DST_ADDR_MODE_LONG/ SRC_ADDR_MODE_SHORT/NO_PAN_ID_COMPRESSION (Data and MAC Command Only) | | | | | | | | | | | | | | | | | | |
| leniency[35] | Override Stage 2 Long Addr Filter for DST_ADDR_MODE_LONG/ SRC_ADDR_MODE_SHORT/NO_PAN_ID_COMPRESSION (Data and MAC Command Only) | | | | | | | | | | | | | | | | | | |
| leniency[36] | Override Stage 2 PAN ID Filter for DST_ADDR_MODE_LONG/ SRC_ADDR_MODE_LONG (Beacon Only) | | | | | | | | | | | | | | | | | | |
| leniency[37] | Override Stage 2 PAN ID Filter for DST_ADDR_MODE_LONG/ SRC_ADDR_MODE_LONG (Data and MAC Command Only) | | | | | | | | | | | | | | | | | | |
| leniency[38] | Override Stage 2 Long Addr Filter for DST_ADDR_MODE_LONG/ SRC_ADDR_MODE_LONG (Data and MAC Command Only) | | | | | | | | | | | | | | | | | | |
| leniency[39] | <p>Allow an auto-TxAck frame to be sent, after a receive frame which has all of the following parameters:</p> <ol style="list-style-type: none"> 1. Destination PAN ID = Broadcast (0xFFFF) 2. Destination Address = !Broadcast (not 0xFFFF) 3. Destination Address Mode = Short <p>Nominally, the SEQ_MGR inhibits auto-TxAck on such frames.</p> | | | | | | | | | | | | | | | | | | |

45.2.3.3.40 PART ID (PART_ID)

45.2.3.3.40.1 Address

| Register | Offset |
|----------|-----------|
| PART_ID | 4005D0A0h |

45.2.3.3.40.2 Diagram

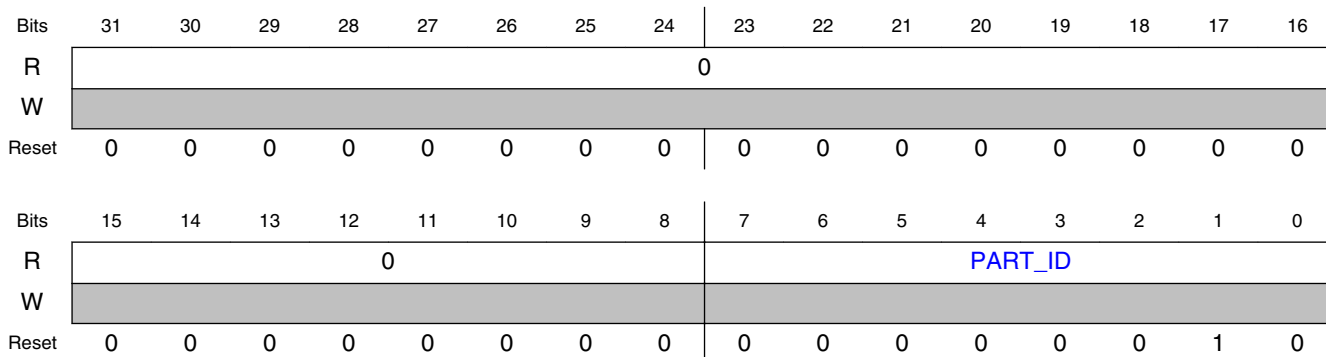

45.2.3.3.40.3 Fields

| Field | Function |
|------------------|------------------|
| 31-8 Reserved | Reserved. |
| 7-0 PART_ID | 802.15.4 Part ID |

45.2.3.3.41 Packet Buffer TX (PKT_BUFFER_TXa)

45.2.3.3.41.1 Address

For a = 0 to 63:

| Register | Offset |
|----------------|----------------------|
| PKT_BUFFER_TXa | 4005D100h + (a × 2h) |

45.2.3.3.41.2 Function

Packet Buffer TX

45.2.3.3.41.3 Diagram

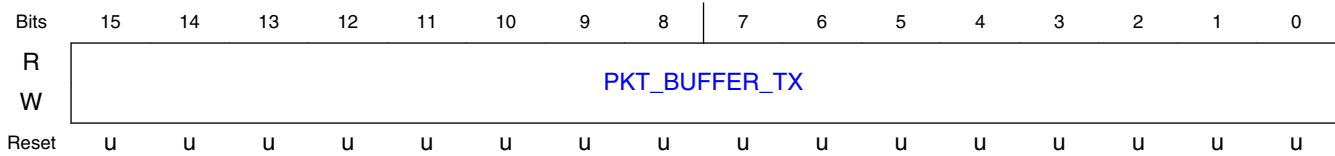

45.2.3.3.41.4 Fields

| Field | Function |
|---------------|---------------------|
| 15-0 | Packet Buffer Entry |
| PKT_BUFFER_TX | Packet Buffer Word |

45.2.3.3.42 Packet Buffer RX (PKT_BUFFER_RXa)

45.2.3.3.42.1 Address

For a = 0 to 63:

| Register | Offset |
|----------------|----------------------|
| PKT_BUFFER_RXa | 4005D180h + (a × 2h) |

45.2.3.3.42.2 Function

Packet Buffer RX

45.2.3.3.42.3 Diagram

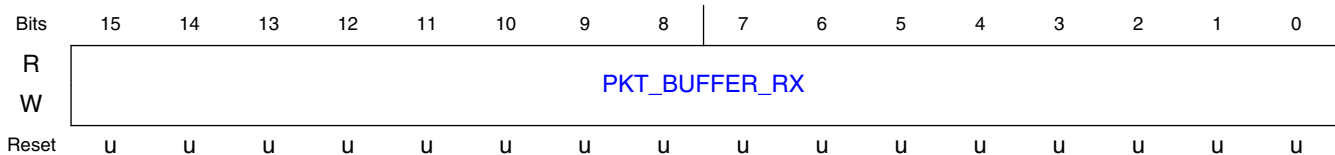

45.2.3.3.42.4 Fields

| Field | Function |
|-------|---------------------|
| 15-0 | Packet Buffer Entry |

Radio Register Overview

| Field | Function |
|---------------|--------------------|
| PKT_BUFFER_RX | Packet Buffer Word |

45.2.3.4 GENERIC_FSK Register Descriptions

45.2.3.4.1 FSK Memory Map

| Offset | Register | Width (In bits) | Access | Reset value |
|-----------|--|--------------------|--------|------------------|
| 4005F000h | IRQ CONTROL (IRQ_CTRL) | 32 | RW | See description. |
| 4005F004h | EVENT TIMER (EVENT_TMR) | 32 | RW | See description. |
| 4005F008h | T1 COMPARE (T1_CMP) | 32 | RW | 00FFFFFFh |
| 4005F00Ch | T2 COMPARE (T2_CMP) | 32 | RW | 00FFFFFFh |
| 4005F010h | TIMESTAMP (TIMESTAMP) | 32 | RO | See description. |
| 4005F014h | TRANSCEIVER CONTROL (XCVR_CTRL) | 32 | RW | See description. |
| 4005F018h | TRANSCEIVER STATUS (XCVR_STS) | 32 | RO | See description. |
| 4005F01Ch | TRANSCEIVER CONFIGURATION (XCVR_CFG) | 32 | RW | See description. |
| 4005F020h | CHANNEL NUMBER (CHANNEL_NUM) | 32 | RW | 00000000h |
| 4005F024h | TRANSMIT POWER (TX_POWER) | 32 | RW | 00000000h |
| 4005F028h | NETWORK ADDRESS CONTROL (NTW_ADR_CTRL) | 32 | RW | See description. |
| 4005F02Ch | NETWORK ADDRESS 0 (NTW_ADR_0) | 32 | RW | 55555555h |
| 4005F030h | NETWORK ADDRESS 1 (NTW_ADR_1) | 32 | RW | 55555555h |
| 4005F034h | NETWORK ADDRESS 2 (NTW_ADR_2) | 32 | RW | 55555555h |
| 4005F038h | NETWORK ADDRESS 3 (NTW_ADR_3) | 32 | RW | 55555555h |
| 4005F03Ch | RECEIVE WATERMARK (RX_WATERMARK) | 32 | RW | See description. |
| 4005F040h | DSM CONTROL (DSM_CTRL) | 32 | WO | See description. |
| 4005F044h | PART ID (PART_ID) | 32 | RO | 00000000h |
| 4005F060h | PACKET CONFIGURATION (PACKET_CFG) | 32 | RW | See description. |
| 4005F064h | H0 CONFIGURATION (H0_CFG) | 32 | RW | 00000000h |
| 4005F068h | H1 CONFIGURATION (H1_CFG) | 32 | RW | 00000000h |

Table continues on the next page...

| Offset | Register | Width (In bits) | Access | Reset value |
|--------------------------|---|--------------------|--------|---------------------|
| 4005F06Ch | CRC CONFIGURATION (CRC_CFG) | 32 | RW | 00000002h |
| 4005F070h | CRC INITIALIZATION (CRC_INIT) | 32 | RW | 00000000h |
| 4005F074h | CRC POLYNOMIAL (CRC_POLY) | 32 | RW | 10210000h |
| 4005F078h | CRC XOR OUT (CRC_XOR_OUT) | 32 | RW | 00000000h |
| 4005F07Ch | WHITENER CONFIGURATION (WHITEN_CFG) | 32 | RW | 01FF0918h |
| 4005F080h | WHITENER POLYNOMIAL (WHITEN_POLY) | 32 | RW | 00000021h |
| 4005F084h | WHITENER SIZE THRESHOLD (WHITEN_SZ_THR) | 32 | RW | 00000800h |
| 4005F088h | BIT RATE (BITRATE) | 32 | RW | 00000000h |
| 4005F08Ch | PACKET BUFFER PARTITION POINT (PB_PARTITION) | 32 | RW | 00000220h |
| 4005F700h - 4005FF7Eh | PACKET BUFFER (PACKET_BUFFER_0 - PACKET_BUFFER_10 87) | 16 | RW | See description. |

45.2.3.4.2 IRQ CONTROL (IRQ_CTRL)

45.2.3.4.2.1 Address

| Register | Offset |
|----------|-----------|
| IRQ_CTRL | 4005F000h |

45.2.3.4.2.2 Diagram

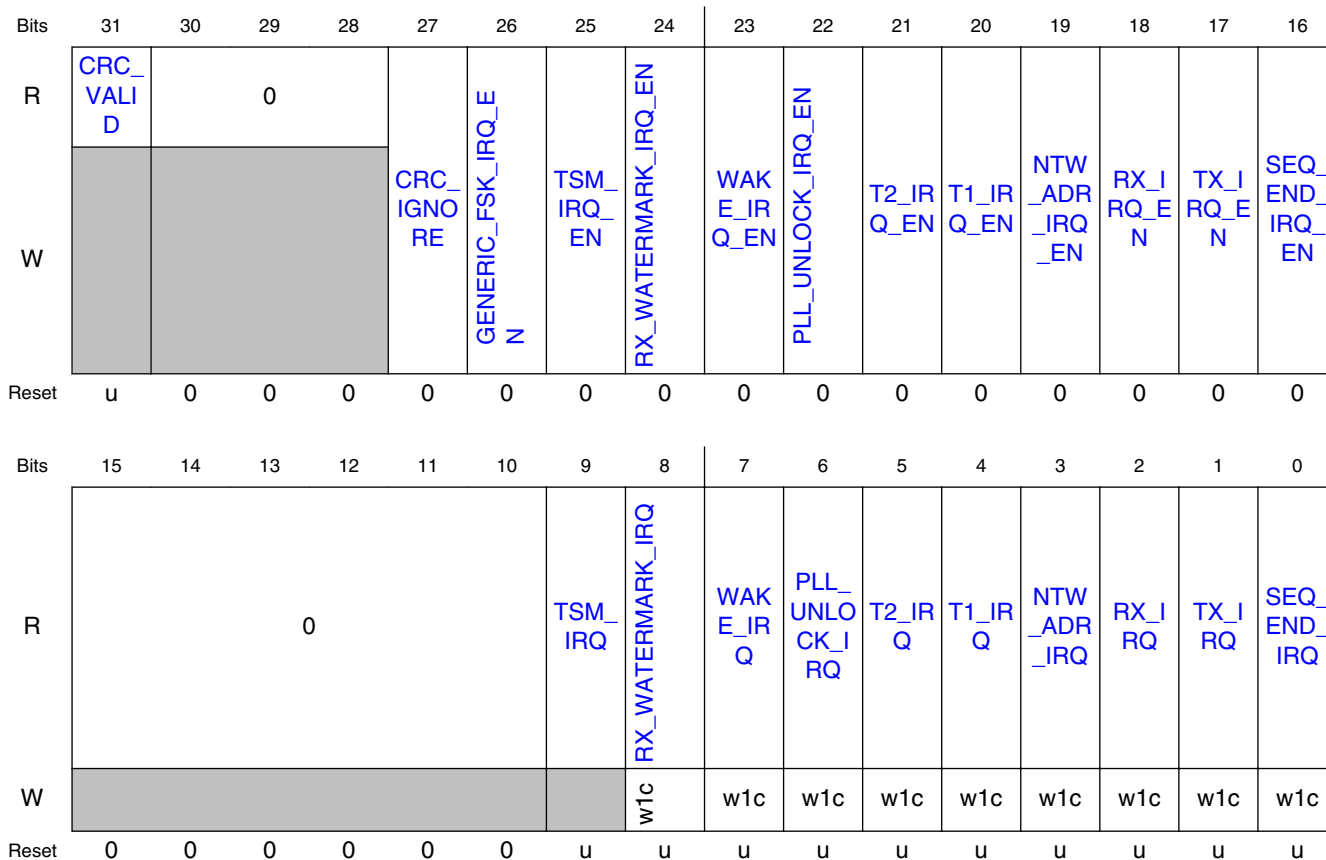

45.2.3.4.2.3 Fields

| Field | Function |
|--------------------------|---|
| 31 CRC_VALID | CRC Valid CRC Valid indicator for RX packets. This bit becomes valid at RX_IRQ, and remains valid until the start of the next RX TSM sequence. 0b - CRC of RX packet is not valid. 1b - CRC of RX packet is valid. |
| 30-28 — | Reserved. |
| 27 CRC_IGNORE | CRC Ignore If set, assert RX_IRQ even for a received packet which fails CRC verification. 0b - RX_IRQ will not be asserted for a received packet which fails CRC verification. 1b - RX_IRQ will be asserted even for a received packet which fails CRC verification. |
| 26 GENERIC_FSK_IRQ_EN | GENERIC_FSK_IRQ Master Enable Master enable for the GENERIC_FSK_IRQ interrupt line to the MCU. 0b - All GENERIC_FSK Interrupts are disabled. 1b - All GENERIC_FSK Interrupts can be enabled. |
| 25 | TSM_IRQ Enable |

Table continues on the next page...

| Field | Function |
|-------------------------------|--|
| TSM_IRQ_EN | 0b - TSM Interrupt is not enabled. 1b - TSM Interrupt is enabled. |
| 24 RX_WATERMA RK_IRQ_EN | RX_WATERMARK_IRQ Enable 0b - RX Watermark Interrupt is not enabled. 1b - RX Watermark Interrupt is enabled. |
| 23 WAKE_IRQ_EN | WAKE_IRQ Enable 0b - Wake Interrupt is not enabled. 1b - Wake Interrupt is enabled. |
| 22 PLL_UNLOCK_I RQ_EN | PLL_UNLOCK_IRQ Enable 0b - PLL Unlock Interrupt is not enabled. 1b - PLL Unlock Interrupt is enabled. |
| 21 T2_IRQ_EN | T2_IRQ Enable 0b - Timer1 (T2) Compare Interrupt is not enabled. 1b - Timer1 (T2) Compare Interrupt is enabled. |
| 20 T1_IRQ_EN | T1_IRQ Enable 0b - Timer1 (T1) Compare Interrupt is not enabled. 1b - Timer1 (T1) Compare Interrupt is enabled. |
| 19 NTW_ADR_IRQ _EN | NTW_ADR_IRQ Enable 0b - Network Address Match Interrupt is not enabled. 1b - Network Address Match Interrupt is enabled. |
| 18 RX_IRQ_EN | RX_IRQ Enable 0b - RX Interrupt is not enabled. 1b - RX Interrupt is enabled. |
| 17 TX_IRQ_EN | TX_IRQ Enable 0b - TX Interrupt is not enabled. 1b - TX Interrupt is enabled. |
| 16 SEQ_END_IRQ _EN | SEQ_END_IRQ Enable 0b - Sequence End Interrupt is not enabled. 1b - Sequence End Interrupt is enabled. |
| 15-10 — | Reserved. |
| 9 TSM_IRQ | TSM Interrupt Indicates TSM0_IRQ or TSM1_IRQ is set in XCVR_STATUS. Clear the bits there. For debug purposes. 0b - TSM0_IRQ and TSM1_IRQ are both clear. 1b - Indicates TSM0_IRQ or TSM1_IRQ is set in XCVR_STATUS. |
| 8 RX_WATERMA RK_IRQ | RX Watermark Interrupt Asserts when RX Byte Counter == RX_WATERMARK[12:0] 0b - RX Watermark Interrupt is not asserted. 1b - RX Watermark Interrupt is asserted. |
| 7 WAKE_IRQ | Wake Interrupt Wake Interrupt. The SLEEP_TMR has matched GENERIC_FSK_WAKE and DSM has exited. The GENERIC_FSK_EVENT_TMR has resumed counting. 0b - Wake Interrupt is not asserted. 1b - Wake Interrupt is asserted. |
| 6 PLL_UNLOCK_I RQ | PLL Unlock Interrupt An unlock event has occurred. 0b - PLL Unlock Interrupt is not asserted. |

Table continues on the next page...

Radio Register Overview

| Field | Function |
|------------------|--|
| | 1b - PLL Unlock Interrupt is asserted. |
| 5 T2_IRQ | Timer2 (T2) Compare Interrupt 0b - Timer2 (T2) Compare Interrupt is not asserted. 1b - Timer2 (T2) Compare Interrupt is asserted. |
| 4 T1_IRQ | Timer1 (T1) Compare Interrupt 0b - Timer1 (T1) Compare Interrupt is not asserted. 1b - Timer1 (T1) Compare Interrupt is asserted. |
| 3 NTW_ADR_IRQ | Network Address Match Interrupt A Network Address Match has occurred. 0b - Network Address Match Interrupt is not asserted. 1b - Network Address Match Interrupt is asserted. |
| 2 RX_IRQ | RX Interrupt The RX sequence has completed with a successful packet reception. 0b - RX Interrupt is not asserted. 1b - RX Interrupt is asserted. |
| 1 TX_IRQ | TX Interrupt The TX sequence has completed with a successful packet transmission. 0b - TX Interrupt is not asserted. 1b - TX Interrupt is asserted. |
| 0 SEQ_END_IRQ | Sequence End Interrupt Will assert when any TX or RX sequence ends for any reason. 0b - Sequence End Interrupt is not asserted. 1b - Sequence End Interrupt is asserted. |

45.2.3.4.3 EVENT TIMER (EVENT_TMR)

45.2.3.4.3.1 Address

| Register | Offset |
|-----------|-----------|
| EVENT_TMR | 4005F004h |

45.2.3.4.3.2 Diagram

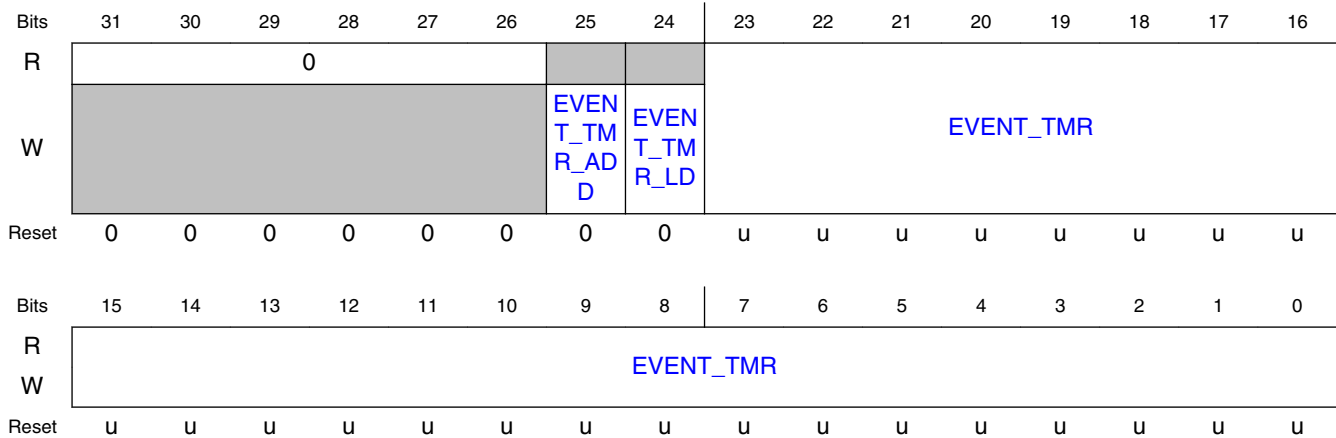

45.2.3.4.3.3 Fields

| Field | Function |
|---------------------|--|
| 31-26 — | Reserved. |
| 25 EVENT_TMR_ADD | Event Timer Add A write access with this bit increments EVENT_TMR by the contents of EVENT_TMR[23:0]. This is a signed addition. |
| 24 EVENT_TMR_LD | Event Timer Load A write access with this bit set loads EVENT_TMR with the contents of EVENT_TMR[23:0] |
| 23-0 EVENT_TMR | Event Timer Event Timer can be read in these byte locations. To update the Event Timer, either: 1. Write the desired EVENT_TMR to these bytes and set EVENT_TMR_LD=1, or, 2. Write the desired EVENT_TMR increment amount to these bytes and set EVENT_TMR_ADD=1. Note: for EVENT_TMR_ADD, EVENT_TMR[23:0] is a signed, two's-complement value. |

45.2.3.4.4 T1 COMPARE (T1_CMP)

45.2.3.4.4.1 Address

| Register | Offset |
|----------|-----------|
| T1_CMP | 4005F008h |

45.2.3.4.4.2 Diagram

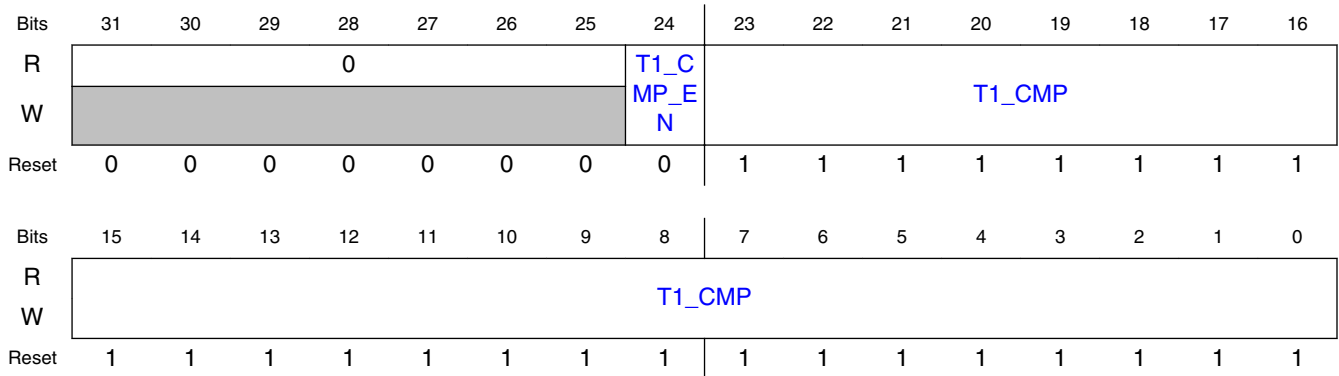

45.2.3.4.4.3 Fields

| Field | Function |
|-----------------|--|
| 31-25 — | Reserved. |
| 24 T1_CMP_EN | Timer1 (T1) Compare Enable Enable Timer Compare #1 (T1_CMP) to generate T1_IRQ and/or execute Sequence Commands. |
| 23-0 T1_CMP | Timer1 (T1) Compare Value Timer1 (T1) Compare Value. Can be used to generate T1_IRQ and/or launch Sequence Commands |

45.2.3.4.5 T2 COMPARE (T2_CMP)

45.2.3.4.5.1 Address

| Register | Offset |
|----------|-----------|
| T2_CMP | 4005F00Ch |

45.2.3.4.5.2 Diagram

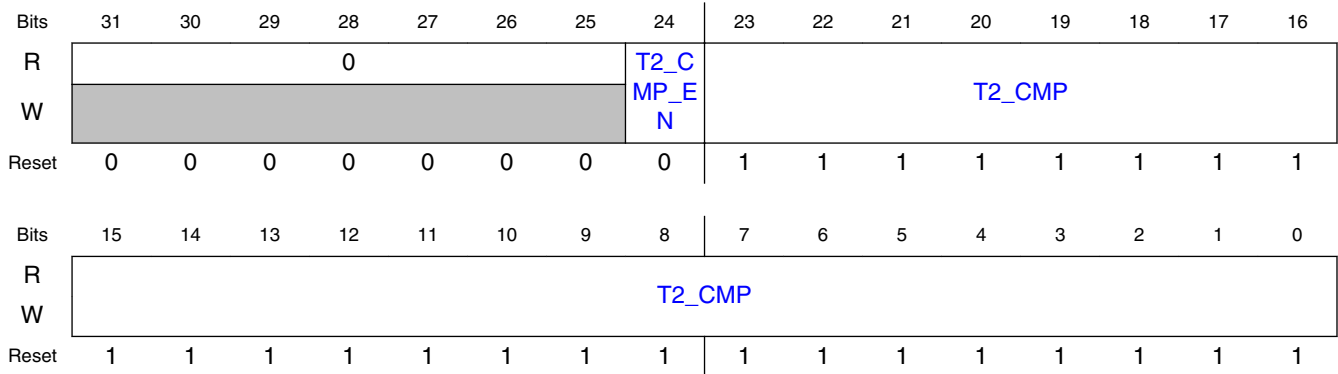

45.2.3.4.5.3 Fields

| Field | Function |
|-----------------|--|
| 31-25 — | Reserved. |
| 24 T2_CMP_EN | Timer2 (T2) Compare Enable Enable Timer Compare #2 (T2_CMP) to generate T2_IRQ and/or execute Sequence Commands. |
| 23-0 T2_CMP | Timer2 (T2) Compare Value Timer2 (T2) Compare Value. Can be used to generate T2_IRQ and/or launch Sequence Commands |

45.2.3.4.6 TIMESTAMP (TIMESTAMP)

45.2.3.4.6.1 Address

| Register | Offset |
|-----------|-----------|
| TIMESTAMP | 4005F010h |

Radio Register Overview

45.2.3.4.6.2 Diagram

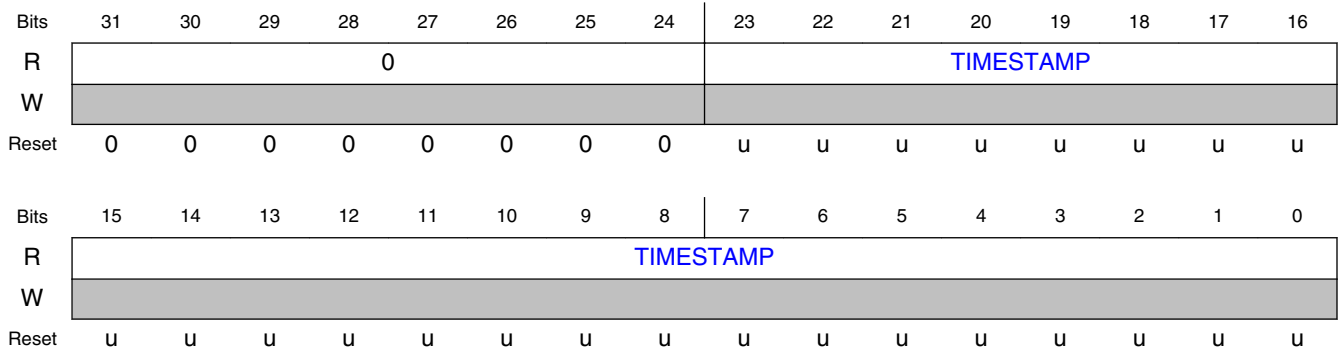

45.2.3.4.6.3 Fields

| Field | Function |
|-------------------|--|
| 31-24 — | Reserved. |
| 23-0 TIMESTAMP | Received Packet Timestamp Received Packet Timestamp. Captured at NTW_ADR_IRQ. |

45.2.3.4.7 TRANSCEIVER CONTROL (XCVR_CTRL)

45.2.3.4.7.1 Address

| Register | Offset |
|-----------|-----------|
| XCVR_CTRL | 4005F014h |

45.2.3.4.7.2 Diagram

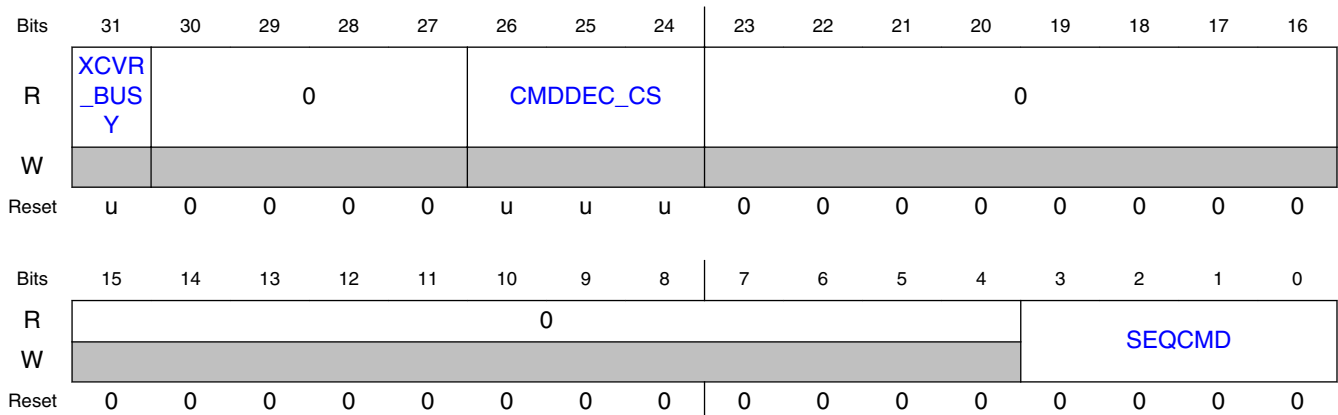

45.2.3.4.7.3 Fields

| Field | Function |
|--------------------|---|
| 31 XCVR_BUSY | Transceiver Busy For multi-protocol arbitration, XCVR_BUSY=1 indicates an RX or TX operation is underway, by either GENERIC_FSK, or some other protocol. 0b - IDLE 1b - BUSY |
| 30-27 — | Reserved. |
| 26-24 CMDDEC_CS | Command Decode Current State of the Command Decoder FSM (debug only) |
| 23-4 Reserved | Reserved. |
| 3-0 SEQCMD | Sequence Commands 0000b - No Action 0001b - TX Start Now 0010b - TX Start @ T1 Timer Compare Match (EVENT_TMR = T1_CMP) 0011b - TX Start @ T2 Timer Compare Match (EVENT_TMR = T2_CMP) 0100b - TX Cancel -- Cancels pending TX events but do not abort a TX-in-progress 0101b - RX Start Now 0110b - RX Start @ T1 Timer Compare Match (EVENT_TMR = T1_CMP) 0111b - RX Start @ T2 Timer Compare Match (EVENT_TMR = T2_CMP) 1000b - RX Stop @ T1 Timer Compare Match (EVENT_TMR = T1_CMP) 1001b - RX Stop @ T2 Timer Compare Match (EVENT_TMR = T2_CMP) 1010b - RX Cancel -- Cancels pending RX events but do not abort a RX-in-progress 1011b - Abort All - Cancels all pending events and abort any sequence-in-progress 1100b - Reserved 1101b - Reserved 1110b - Reserved 1111b - Reserved |

45.2.3.4.8 TRANSCEIVER STATUS (XCVR_STS)

45.2.3.4.8.1 Address

| Register | Offset |
|----------|-----------|
| XCVR_STS | 4005F018h |

45.2.3.4.8.2 Diagram

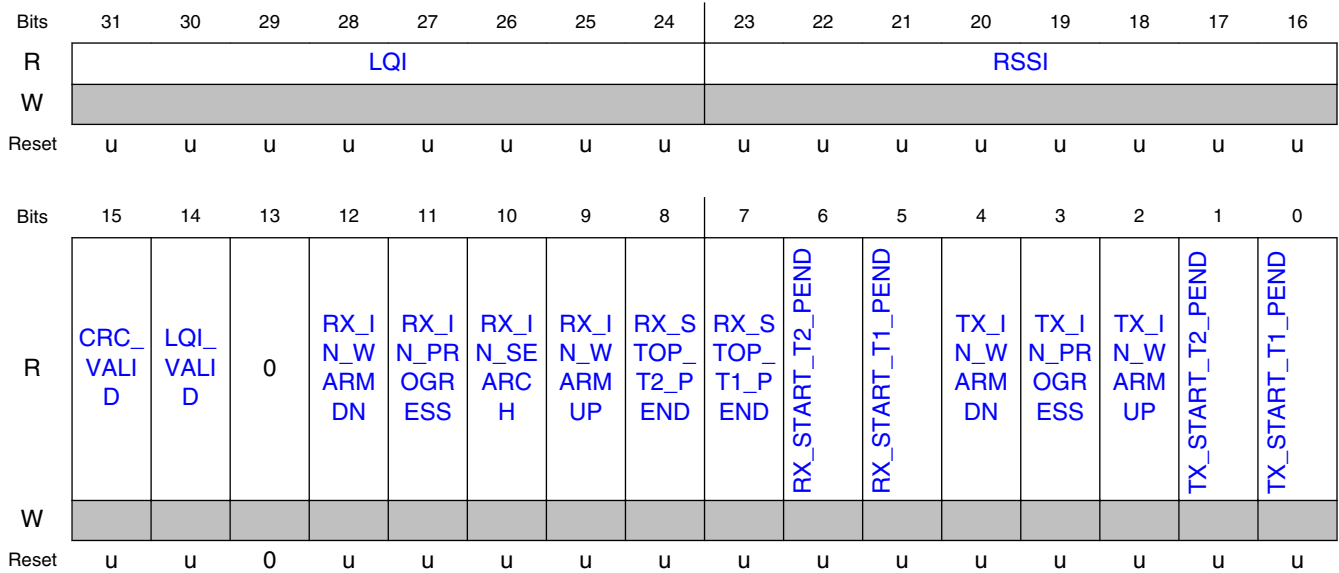

45.2.3.4.8.3 Fields

| Field | Function |
|-----------------------|--|
| 31-24 LQI | Link Quality Indicator This field is valid when LQI_VALID=1. LQI is a unsigned, unitless value. |
| 23-16 RSSI | Received Signal Strength Indicator, in dBm |
| 15 CRC_VALID | CRC Valid Indicator CRC Valid indicator for RX packets. 0b - CRC is not valid for RX packet. 1b - CRC is valid for RX packet. |
| 14 LQI_VALID | LQI Valid Indicator LQI Valid indicator for RX packets. This bit becomes set when the LQI computation completes for the packet currently being received, and remains set for the remainder of the packet. 0b - LQI is not yet valid for RX packet. 1b - LQI is valid for RX packet. |
| 13 — | Reserved. |
| 12 RX_IN_WARM_DOWN | RX Warmdown Status RX Sequence in TSM Warmdown |
| 11 RX_IN_PROGRESS | RX in Progress Status RX Packet Reception Currently Underway |
| 10 | RX Search Status |

Table continues on the next page...

| Field | Function |
|-----------------------|--|
| RX_IN_SEARCH | RX Sequence in Network Address Search |
| 9 RX_IN_WARMUP | RX Warmup Status RX Sequence in TSM Warmup |
| 8 RX_STOP_T2_PEND | RX T2 Start Pending Status RX Sequence will stop @ next T2 Match |
| 7 RX_STOP_T1_PEND | RX T1 Stop Pending Status RX Sequence will stop @ next T1 Match |
| 6 RX_START_T2_PEND | RX T2 Start Pending Status RX Sequence will start @ next T2 Match |
| 5 RX_START_T1_PEND | RX T1 Start Pending Status RX Sequence will start @ next T1 Match |
| 4 TX_IN_WARMDOWN | TX Warmdown Status TX Sequence in TSM Warmdown |
| 3 TX_IN_PROGRESS | TX in Progress Status TX Packet Transmission Currently Underway |
| 2 TX_IN_WARMUP | TX Warmup Status TX Sequence in TSM Warmup |
| 1 TX_START_T2_PEND | TX T2 Start Pending Status TX Sequence will start @ next T2 Match |
| 0 TX_START_T1_PEND | TX T1 Start Pending Status TX Sequence will start @ next T1 Match |

45.2.3.4.9 TRANSCEIVER CONFIGURATION (XCVR_CFG)

45.2.3.4.9.1 Address

| Register | Offset |
|----------|-----------|
| XCVR_CFG | 4005F01Ch |

45.2.3.4.9.2 Diagram

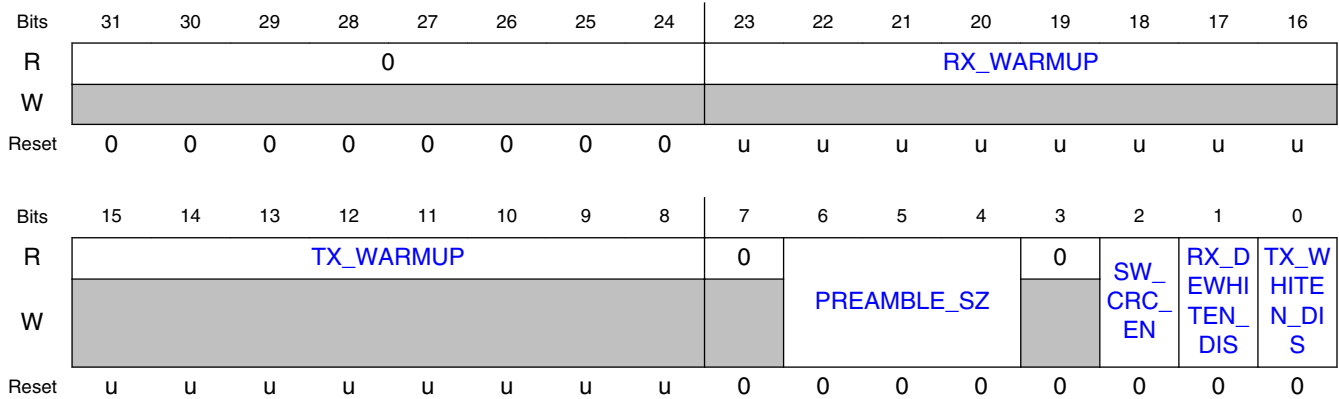

45.2.3.4.9.3 Fields

| Field | Function |
|------------------------|---|
| 31-24 — | Reserved. |
| 23-16 RX_WARMUP | Receive Warmup Time RX warmup time, in microseconds, provided to Link Layer software, so that warmup time can be accounted for when scheduling over-the-air transactions. |
| 15-8 TX_WARMUP | Transmit Warmup Time TX warmup time, in microseconds, provided to Link Layer software, so that warmup time can be accounted for when scheduling over-the-air transactions. |
| 7 — | Reserved. |
| 6-4 PREAMBLE_SZ | Preamble Size Number of Octets = PREAMBLE_SZ + 1, where 0 <= PREAMBLE_SZ <= 7 |
| 3 — | Reserved. |
| 2 SW_CRC_EN | Software CRC Enable Software override of the HW-computed CRC for TX. Software must write CRC to Packet Buffer (RAM) |
| 1 RX_DEWHITEN_DIS | RX De-Whitening Disable Disable all de-whitening on RX packets |
| 0 TX_WHITEN_DISABLE | TX Whitening Disable Disable all whitening on TX packets |

45.2.3.4.10 CHANNEL NUMBER (CHANNEL_NUM)

45.2.3.4.10.1 Address

| Register | Offset |
|-------------|-----------|
| CHANNEL_NUM | 4005F020h |

45.2.3.4.10.2 Diagram

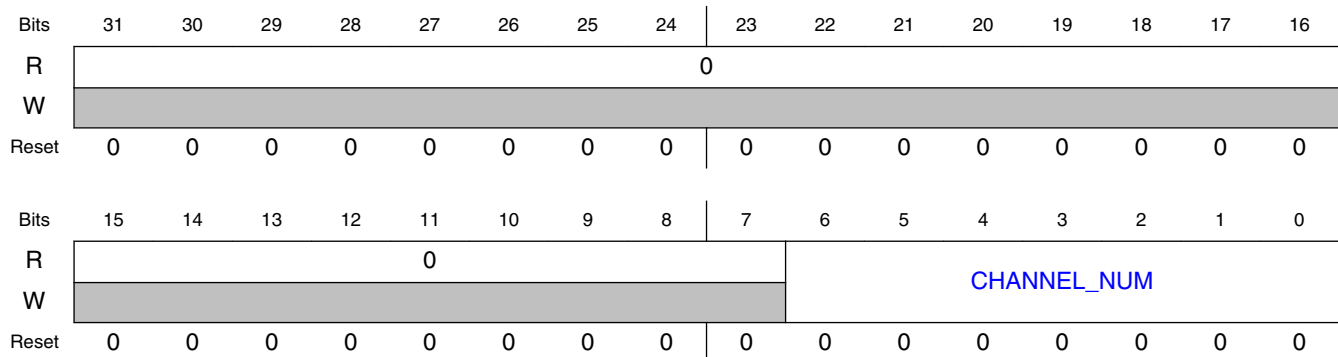

45.2.3.4.10.3 Fields

| Field | Function |
|--------------------|---|
| 31-7 Reserved | Reserved. |
| 6-0 CHANNEL_NUM | Channel Number RF Channel Select: $0 \leq \text{CHANNEL_NUM} \leq 127$; Formula: $F = (2360 + \text{CHANNEL_NUM})$ [in MHz] |

45.2.3.4.11 TRANSMIT POWER (TX_POWER)

45.2.3.4.11.1 Address

| Register | Offset |
|----------|-----------|
| TX_POWER | 4005F024h |

45.2.3.4.11.2 Diagram

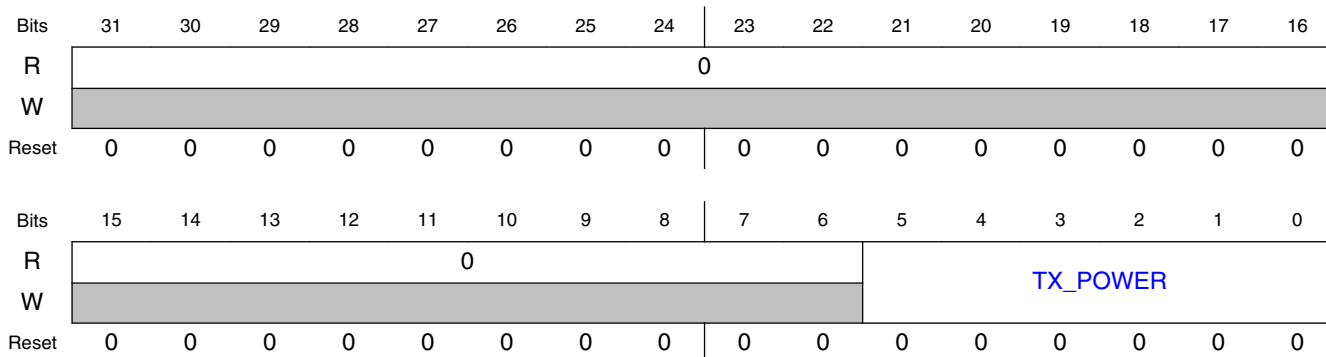

45.2.3.4.11.3 Fields

| Field | Function |
|------------------|-----------------------------------|
| 31-6 Reserved | Reserved. |
| 5-0 TX_POWER | Transmit Power PA Power Level. |

45.2.3.4.12 NETWORK ADDRESS CONTROL (NTW_ADR_CTRL)

45.2.3.4.12.1 Address

| Register | Offset |
|--------------|-----------|
| NTW_ADR_CTRL | 4005F028h |

45.2.3.4.12.2 Diagram

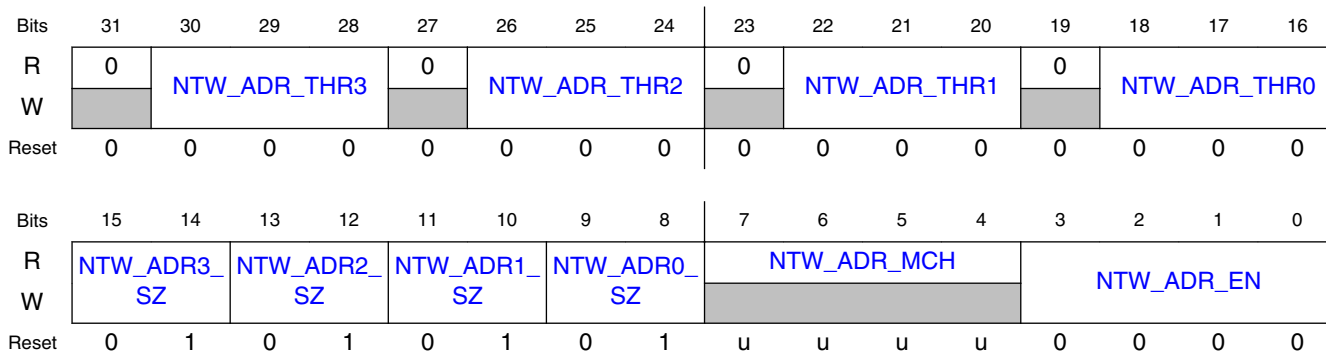

45.2.3.4.12.3 Fields

| Field | Function |
|---------------------------|---|
| 31 — | Reserved. |
| 30-28 NTW_ADR_TH R3 | Network Address 3 Threshold Number of Tolerated bit errors for Network Address 3 |
| 27 — | Reserved. |
| 26-24 NTW_ADR_TH R2 | Network Address 2 Threshold Number of Tolerated bit errors for Network Address 2 |
| 23 — | Reserved. |
| 22-20 NTW_ADR_TH R1 | Network Address 1 Threshold Number of Tolerated bit errors for Network Address 1 |
| 19 — | Reserved. |
| 18-16 NTW_ADR_TH R0 | Network Address 0 Threshold Number of Tolerated bit errors for Network Address 0 |
| 15-14 NTW_ADR3_SZ | Network Address 3 Size 00b - Network Address 3 requires a 8-bit correlation 01b - Network Address 3 requires a 16-bit correlation 10b - Network Address 3 requires a 24-bit correlation 11b - Network Address 3 requires a 32-bit correlation |
| 13-12 NTW_ADR2_SZ | Network Address 2 Size 00b - Network Address 2 requires a 8-bit correlation 01b - Network Address 2 requires a 16-bit correlation 10b - Network Address 2 requires a 24-bit correlation 11b - Network Address 2 requires a 32-bit correlation |
| 11-10 NTW_ADR1_SZ | Network Address 1 Size 00b - Network Address 1 requires a 8-bit correlation 01b - Network Address 1 requires a 16-bit correlation 10b - Network Address 1 requires a 24-bit correlation 11b - Network Address 1 requires a 32-bit correlation |
| 9-8 NTW_ADR0_SZ | Network Address 0 Size 00b - Network Address 0 requires a 8-bit correlation 01b - Network Address 0 requires a 16-bit correlation 10b - Network Address 0 requires a 24-bit correlation 11b - Network Address 0 requires a 32-bit correlation |
| 7-4 NTW_ADR_MC H | Network Address Match Indicates which of the 4 Network Addresses has matched in the PHY. Valid during an RX sequence at the point of match, and remains asserted until either: |

Table continues on the next page...

Radio Register Overview

| Field | Function |
|-------------------|--|
| | 1. The next RX sequence begins (if the current packet passed CRC and header filtering), or, 2. An RX recycle to Network Address search (if the current packet failed CRC or header filtering) 0001b - Network Address 0 has matched 0010b - Network Address 1 has matched 0100b - Network Address 2 has matched 1000b - Network Address 3 has matched |
| 3-0 NTW_ADR_EN | Network Address Enable Enable Network Address N for PHY correlation, where $0 \leq N \leq 3$. Any bit combination can be set. 0001b - Enable Network Address 0 for correlation 0010b - Enable Network Address 1 for correlation 0100b - Enable Network Address 2 for correlation 1000b - Enable Network Address 3 for correlation |

45.2.3.4.13 NETWORK ADDRESS 0 (NTW_ADR_0)

45.2.3.4.13.1 Address

| Register | Offset |
|-----------|-----------|
| NTW_ADR_0 | 4005F02Ch |

45.2.3.4.13.2 Diagram

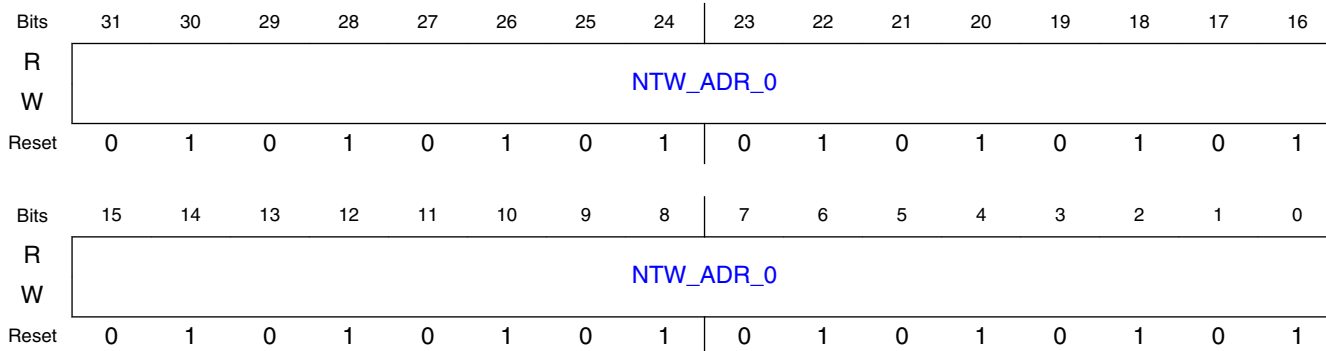

45.2.3.4.13.3 Fields

| Field | Function |
|-------------------|--|
| 31-0 NTW_ADR_0 | Network Address 0 The PHY will search for this Network Address if $NTW_ADR_CTRL[NTW_ADR_EN[0]] = 1$ |

45.2.3.4.14 NETWORK ADDRESS 1 (NTW_ADR_1)

45.2.3.4.14.1 Address

| Register | Offset |
|-----------|-----------|
| NTW_ADR_1 | 4005F030h |

45.2.3.4.14.2 Diagram

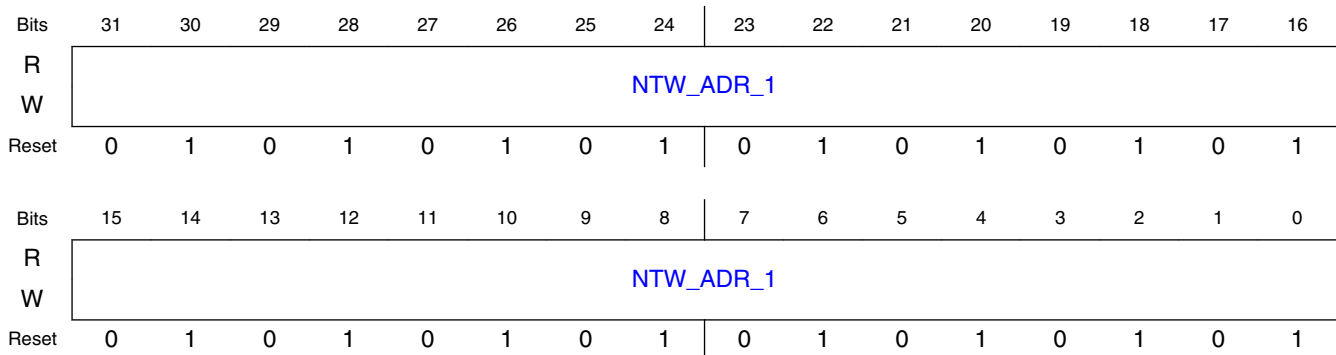

45.2.3.4.14.3 Fields

| Field | Function |
|-----------|---|
| 31-0 | Network Address 1 |
| NTW_ADR_1 | The PHY will search for this Network Address if NTW_ADR_CTRL[NTW_ADR_EN[1]] = 1 |

45.2.3.4.15 NETWORK ADDRESS 2 (NTW_ADR_2)

45.2.3.4.15.1 Address

| Register | Offset |
|-----------|-----------|
| NTW_ADR_2 | 4005F034h |

45.2.3.4.15.2 Diagram

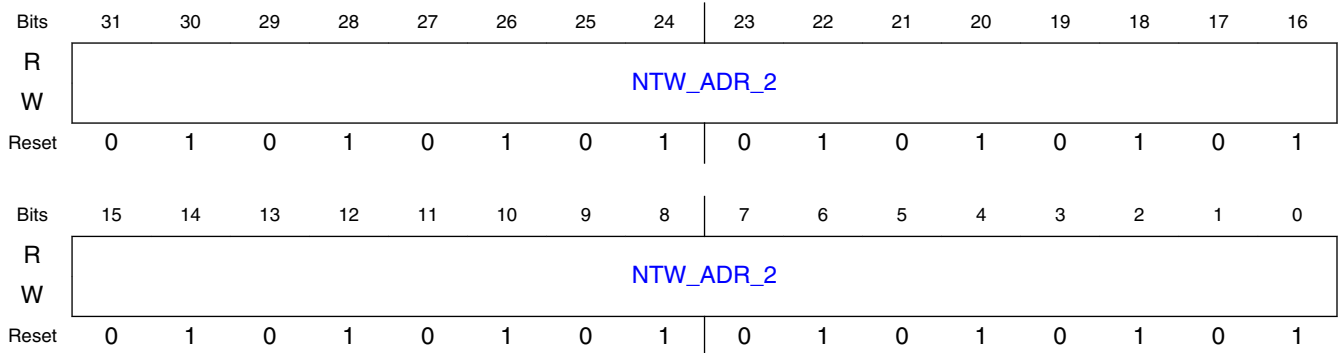

45.2.3.4.15.3 Fields

| Field | Function |
|-----------|---|
| 31-0 | Network Address 2 |
| NTW_ADR_2 | The PHY will search for this Network Address if NTW_ADR_CTRL[NTW_ADR_EN[2]] = 1 |

45.2.3.4.16 NETWORK ADDRESS 3 (NTW_ADR_3)

45.2.3.4.16.1 Address

| Register | Offset |
|-----------|-----------|
| NTW_ADR_3 | 4005F038h |

45.2.3.4.16.2 Diagram

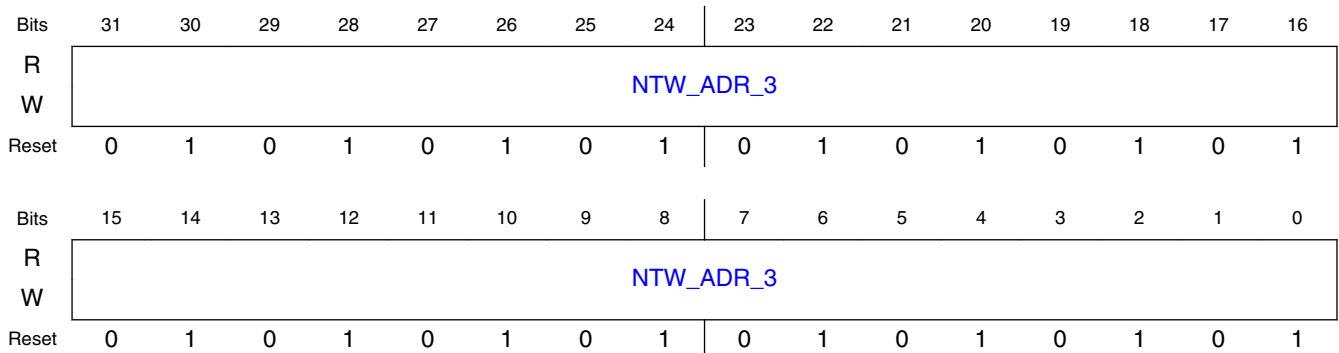

45.2.3.4.16.3 Fields

| Field | Function |
|-------------------|--|
| 31-0 NTW_ADR_3 | Network Address 2 The PHY will search for this Network Address if NTW_ADR_CTRL[NTW_ADR_EN[3]] = 1 |

45.2.3.4.17 RECEIVE WATERMARK (RX_WATERMARK)

45.2.3.4.17.1 Address

| Register | Offset |
|--------------|-----------|
| RX_WATERMARK | 4005F03Ch |

45.2.3.4.17.2 Diagram

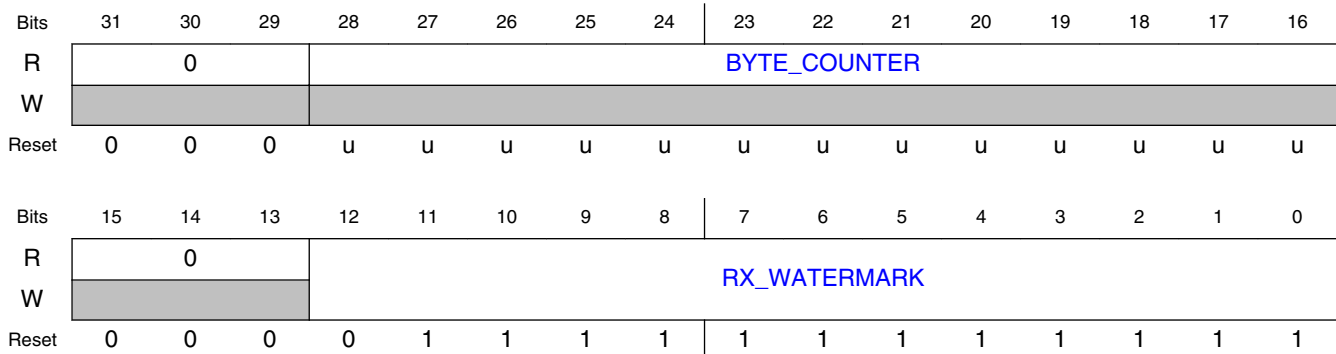

45.2.3.4.17.3 Fields

| Field | Function |
|----------------------------|--|
| 31-29 — | Reserved. |
| 28-16 BYTE_COUNTER R | Byte Counter Reflects the current Byte Count, for TX and RX. This is a signed, twos-complement value. For values less than zero, indicates the preamble transmission is underway (TX only). A value of 0 indicates the first octet of Network Address is being transmitted or received. A value of 1 indicates the second octet of Network Address is being transmitted or received. Etc. |
| 15-13 — | Reserved. |
| 12-0 | Receive Watermark |

Radio Register Overview

| Field | Function |
|--------------|---|
| RX_WATERMARK | Sets the trigger for RX_WATERMARK_IRQ. Trigger the RX_WATERMARK_IRQ when: RX Byte Counter == RX_WATERMARK[12:0] |
| RK | |

45.2.3.4.18 DSM CONTROL (DSM_CTRL)

45.2.3.4.18.1 Address

| Register | Offset |
|----------|-----------|
| DSM_CTRL | 4005F040h |

45.2.3.4.18.2 Diagram

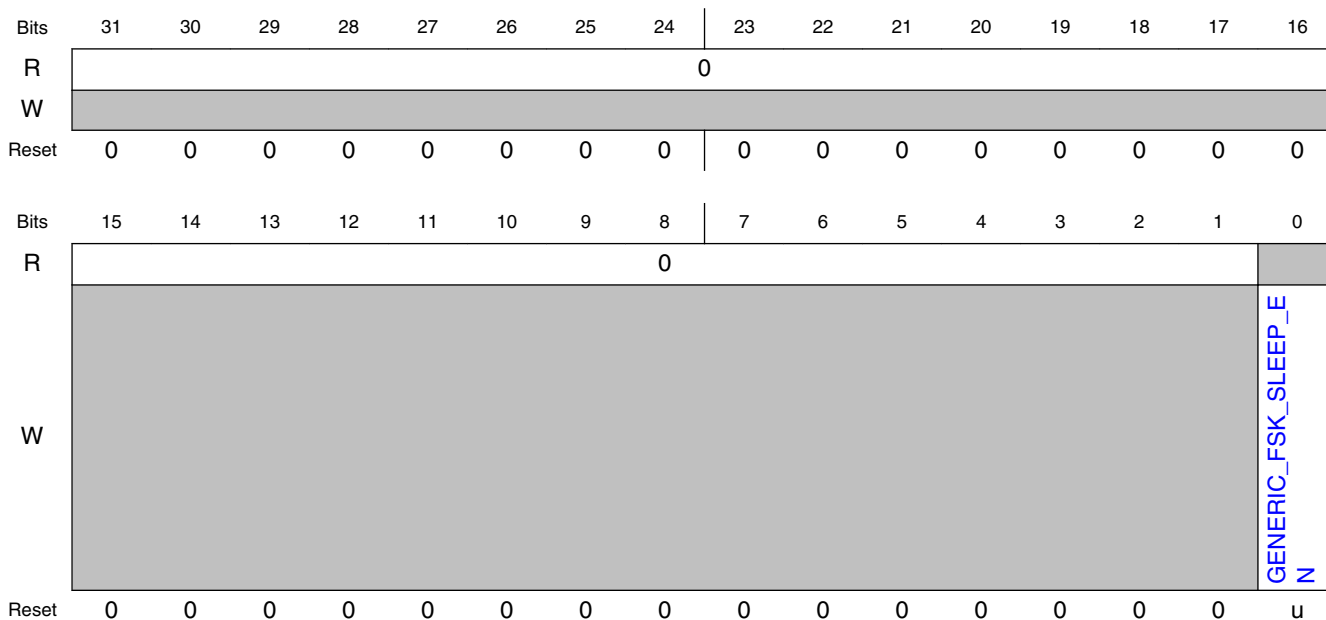

45.2.3.4.18.3 Fields

| Field | Function |
|---------------------------|---|
| 31-1 Reserved | Reserved. |
| 0 GENERIC_FSK_SLEEP_EN | GENERIC_FSK DSM Sleep Enable If GENERIC_FSK_SLEEP_EN=1, enter DSM and freeze EVENT_TMR when GEN_SLEEP matches DSM_TIMER. Note: GEN_SLEEP and DSM_TIMER registers reside in RSIM space. |

45.2.3.4.19 PART ID (PART_ID)

45.2.3.4.19.1 Address

| Register | Offset |
|----------|-----------|
| PART_ID | 4005F044h |

45.2.3.4.19.2 Diagram

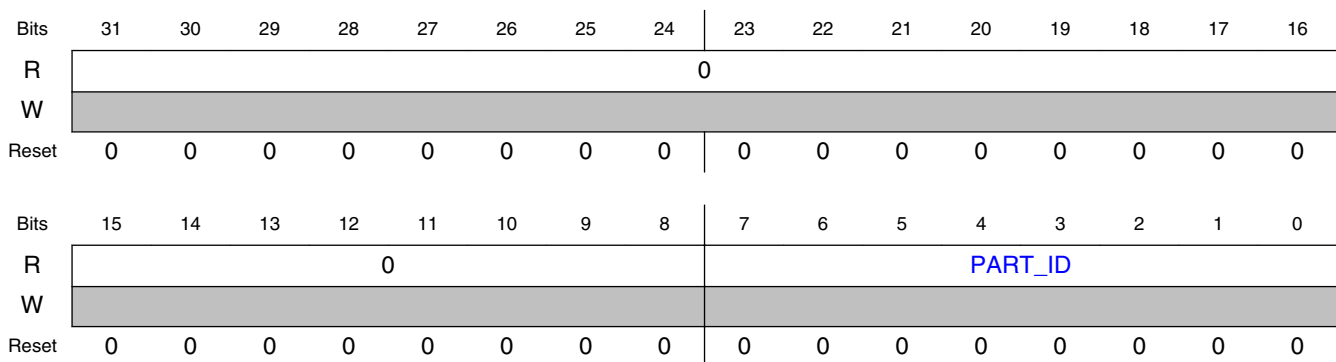

45.2.3.4.19.3 Fields

| Field | Function |
|------------------|--|
| 31-8 Reserved | Reserved. |
| 7-0 PART_ID | Part ID Part ID to identify HW revision of the Generic FSK Link Layer |

45.2.3.4.20 PACKET CONFIGURATION (PACKET_CFG)

45.2.3.4.20.1 Address

| Register | Offset |
|------------|-----------|
| PACKET_CFG | 4005F060h |

45.2.3.4.20.2 Diagram

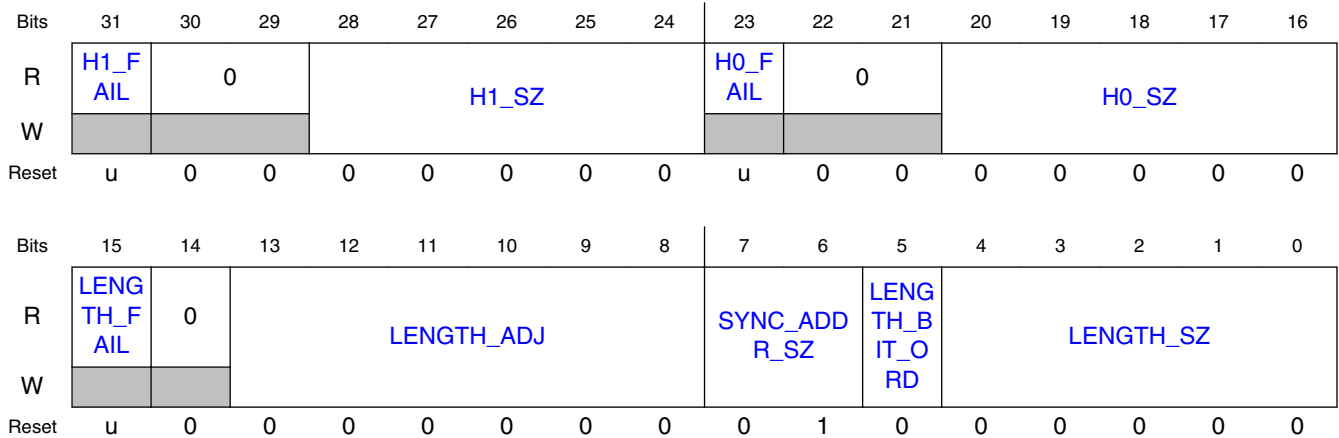

45.2.3.4.20.3 Fields

| Field | Function |
|---------------------|--|
| 31 H1_FAIL | H1 Violated Status Bit For packets received with REC_BAD_PKT=1, H1_FAIL indicates the received H1 header field violates the H1_MASK/H1_MATCH pattern |
| 30-29 — | Reserved. |
| 28-24 H1_SZ | H1 Size Length of H1 in bits; 0 <= H1_SZ <= 16 |
| 23 H0_FAIL | H0 Violated Status Bit For packets received with REC_BAD_PKT=1, H0_FAIL indicates the received H0 header field violates the H0_MASK/H0_MATCH pattern |
| 22-21 — | Reserved. |
| 20-16 H0_SZ | H0 Size Size of H0 in bits; 0 <= H0_SZ <= 16 |
| 15 LENGTH_FAIL | Maximum Length Violated Status Bit For packets received with REC_BAD_PKT=1, LENGTH_FAIL indicates the extracted LENGTH header field exceeded LENGTH_MAX |
| 14 — | Reserved. |
| 13-8 LENGTH_ADJ | Length Adjustment Signed Adjustment to the LENGTH field for TX and RX. A value of 0 (default) means LENGTH is interpreted as PAYLOAD + CRC |
| 7-6 SYNC_ADDR_SZ | Sync Address Size Number of Octets = SYNC_ADDR_SZ + 1, 0 <= SYNC_ADDR_SZ <= 3. |

Table continues on the next page...

| Field | Function |
|-----------------------|--|
| 5 LENGTH_BIT_ORDER | LENGTH Bit Order Bit order for the LENGTH field of the header 0b - LS Bit First 1b - MS Bit First |
| 4-0 LENGTH_SZ | LENGTH Size Size of LENGTH field of the header, in bits; 0 <= LENGTH_SZ <= 16 |

45.2.3.4.21 H0 CONFIGURATION (H0_CFG)

45.2.3.4.21.1 Address

| Register | Offset |
|----------|-----------|
| H0_CFG | 4005F064h |

45.2.3.4.21.2 Diagram

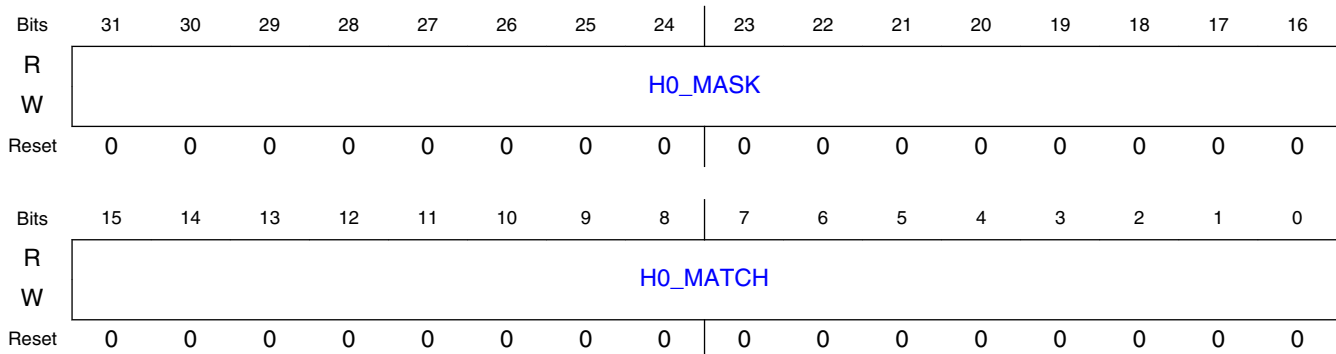

45.2.3.4.21.3 Fields

| Field | Function |
|------------------|--|
| 31-16 H0_MASK | H0 Mask Register For each bit that is set to 1, the received H0 field must match the corresponding bit of H0_MATCH[15:0], else the received packet is rejected. |
| 15-0 H0_MATCH | H0 Match Register For each bit of H0_MASK[15:0] that is set to 1, the received H0 field must match this register, else the received packet is rejected. |

45.2.3.4.22 H1 CONFIGURATION (H1_CFG)

45.2.3.4.22.1 Address

| Register | Offset |
|----------|-----------|
| H1_CFG | 4005F068h |

45.2.3.4.22.2 Diagram

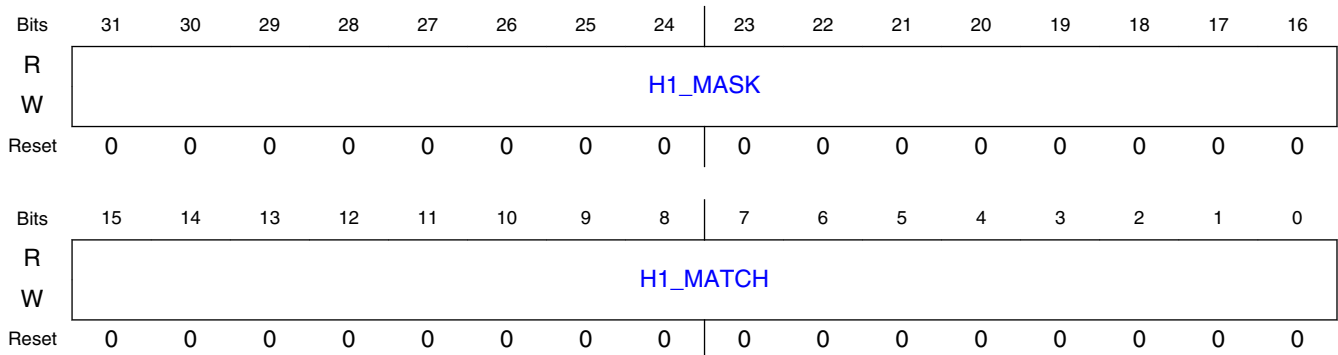

45.2.3.4.22.3 Fields

| Field | Function |
|------------------|--|
| 31-16 H1_MASK | H1 Mask Register For each bit that is set to 1, the received H1 field must match the corresponding bit of H1_MATCH[15:0], else the received packet is rejected. |
| 15-0 H1_MATCH | H1 Match Register For each bit of H1_MASK[15:0] that is set to 1, the received H1 field must match this register, else the received packet is rejected. |

45.2.3.4.23 CRC CONFIGURATION (CRC_CFG)

45.2.3.4.23.1 Address

| Register | Offset |
|----------|-----------|
| CRC_CFG | 4005F06Ch |

45.2.3.4.23.2 Diagram

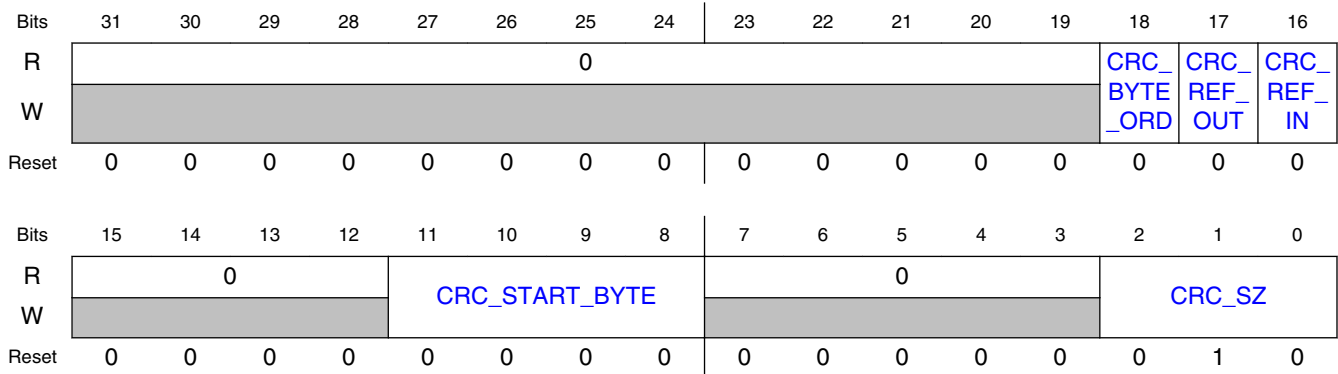

45.2.3.4.23.3 Fields

| Field | Function |
|------------------------|--|
| 31-19 — | Reserved. |
| 18 CRC_BYTE_ORDER | CRC Byte Order 0b - LS Byte First 1b - MS Byte First |
| 17 CRC_REF_OUT | CRC Reflect Out 0b - do not manipulate CRC result 1b - CRC result is to be reflected bitwise (operated on entire word) |
| 16 CRC_REF_IN | CRC Reflect In 0b - do not manipulate input data stream 1b - reflect each byte in the input stream bitwise |
| 15-12 — | Reserved. |
| 11-8 CRC_START_BYTE | Configure CRC Start Point Start CRC with this byte position. Byte #0 is the first byte of Sync Address |
| 7-3 — | Reserved. |
| 2-0 CRC_SZ | CRC Size (in octets) Number of CRC Octets = CRC_SZ, 0 <= CRC_SZ <= 4. |

45.2.3.4.24 CRC INITIALIZATION (CRC_INIT)

45.2.3.4.24.1 Address

| Register | Offset |
|----------|-----------|
| CRC_INIT | 4005F070h |

45.2.3.4.24.2 Diagram

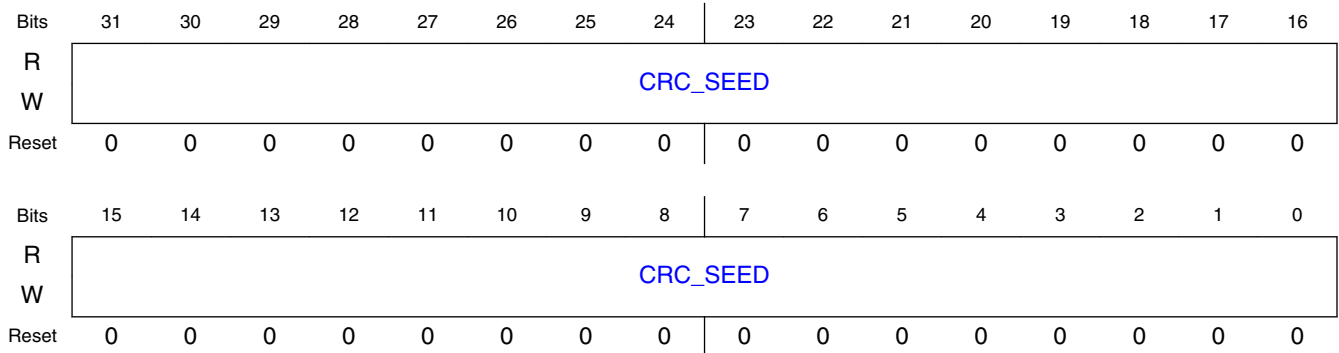

45.2.3.4.24.3 Fields

| Field | Function |
|----------|----------------------------|
| 31-0 | CRC Seed Value |
| CRC_SEED | Initial Value for CRC LFSR |

45.2.3.4.25 CRC POLYNOMIAL (CRC_POLY)

45.2.3.4.25.1 Address

| Register | Offset |
|----------|-----------|
| CRC_POLY | 4005F074h |

45.2.3.4.25.2 Diagram

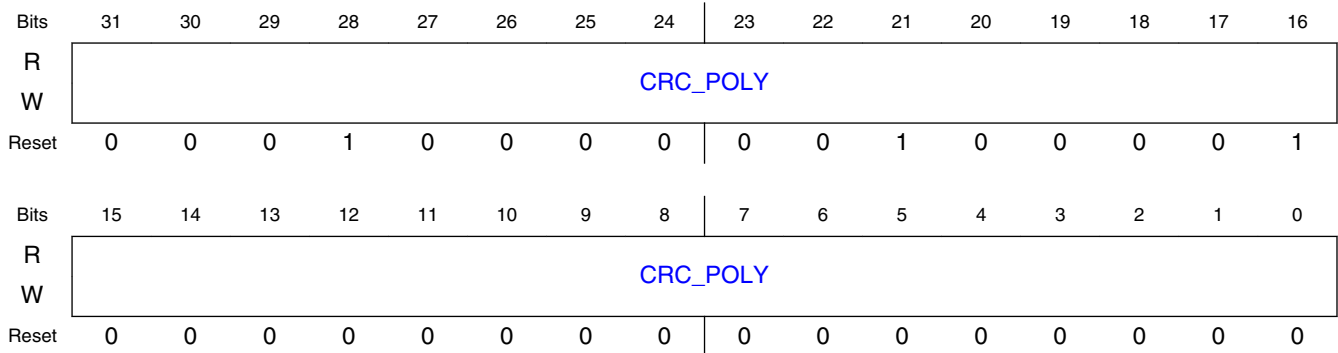

45.2.3.4.25.3 Fields

| Field | Function |
|------------------|-----------------|
| 31-0 CRC_POLY | CRC Polynomial. |

45.2.3.4.26 CRC XOR OUT (CRC_XOR_OUT)

45.2.3.4.26.1 Address

| Register | Offset |
|-------------|-----------|
| CRC_XOR_OUT | 4005F078h |

45.2.3.4.26.2 Diagram

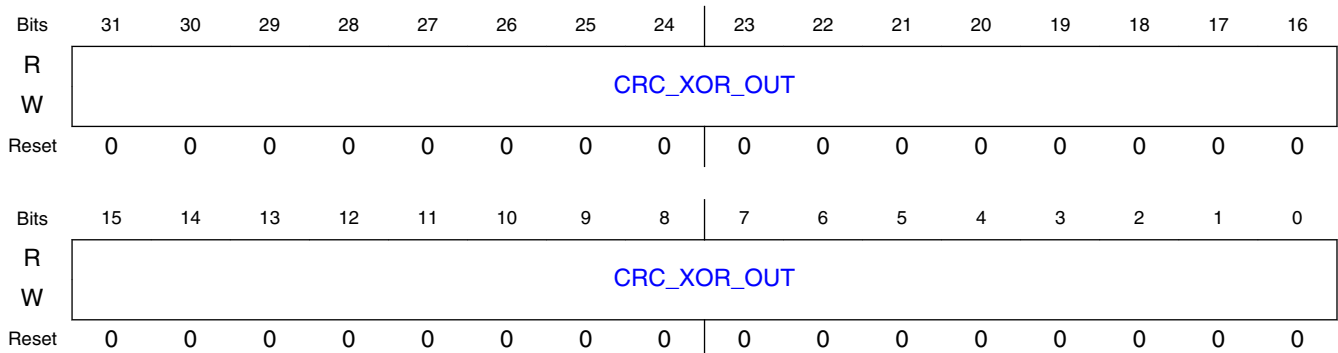

45.2.3.4.26.3 Fields

| Field | Function |
|-------------|--|
| 31-0 | CRC XOR OUT Register |
| CRC_XOR_OUT | XOR mask for CRC result (for no mask, should be 0) |

45.2.3.4.27 WHITENER CONFIGURATION (WHITEN_CFG)

45.2.3.4.27.1 Address

| Register | Offset |
|------------|-----------|
| WHITEN_CFG | 4005F07Ch |

45.2.3.4.27.2 Diagram

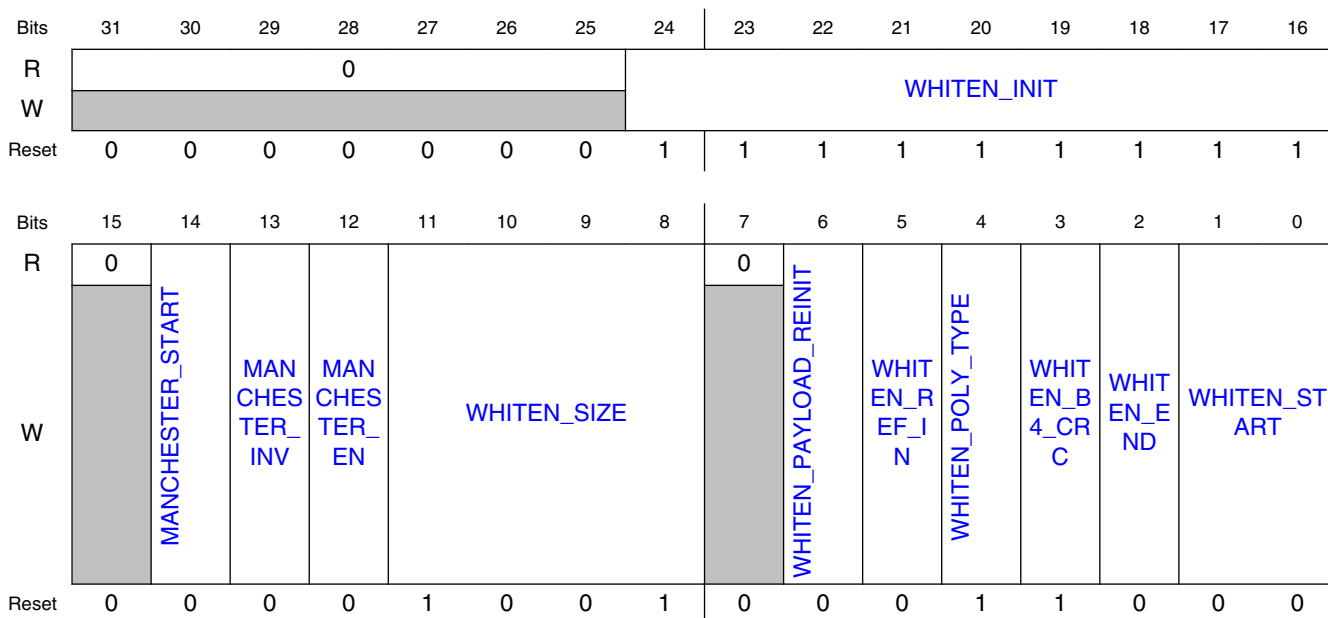

45.2.3.4.27.3 Fields

| Field | Function |
|-------|---|
| 31-25 | Reserved. |
| — | |
| 24-16 | Initialization Value for Whitening/De-whitening |

Table continues on the next page...

| Field | Function |
|--------------------------------|--|
| WHITEN_INIT | |
| 15 — | Reserved. |
| 14 MANCHESTER _START | Configure Manchester Encoding Start Point 0b - Start Manchester coding at start-of-payload 1b - Start Manchester coding at start-of-header |
| 13 MANCHESTER _INV | Configure for Inverted Manchester Encoding 0b - Manchester coding as per 802.3 1b - Manchester coding as per 802.3 but with the encoding signal inverted |
| 12 MANCHESTER _EN | Configure for Manchester Encoding/Decoding 0b - Disable Manchester encoding (TX) and decoding (RX) 1b - Enable Manchester encoding (TX) and decoding (RX) |
| 11-8 WHITEN_SIZE | Length of Whitener LFSR |
| 7 — | Reserved. |
| 6 WHITEN_PAYL OAD_REINIT | Configure for Whitener re-initialization 0b - Don't re-initialize Whitener LFSR at start-of-payload 1b - Re-initialize Whitener LFSR at start-of-payload |
| 5 WHITEN_REF_I N | Whiten Reflect Input The input data stream is reflected, bit-wise, per byte, if this register bit is asserted. Bit 7 becomes bit 0, bit 6 becomes bit 1, etc. This register bit will only cause the reflection of the payload data bits as they are used in the whiten calculation and will not cause any change in the output bit order. |
| 4 WHITEN_POLY _TYPE | Whiten Polynomial Type A Fibonacci type LFSR is used with the whiten polynomial if this register bit is asserted. Otherwise, a Galois type LFSR is used. |
| 3 WHITEN_B4_C RC | Configure for Whitening-before-CRC Sets the order of Bit Stream Processing for TX and RX. 0b - CRC before whiten/de-whiten 1b - Whiten/de-whiten before CRC |
| 2 WHITEN_END | Configure end-of-whitening 0b - end whiten at end-of-payload 1b - end whiten at end-of-crc |
| 1-0 WHITEN_STAR T | Configure Whitener Start Point 00b - no whitening 01b - start whitening at start-of-H0 10b - start whitening at start-of-H1 but only if LENGTH > WHITEN_SZ_THR 11b - start whitening at start-of-payload but only if LENGTH > WHITEN_SZ_THR |

45.2.3.4.28 WHITENER POLYNOMIAL (WHITEN_POLY)

45.2.3.4.28.1 Address

| Register | Offset |
|-------------|-----------|
| WHITEN_POLY | 4005F080h |

45.2.3.4.28.2 Diagram

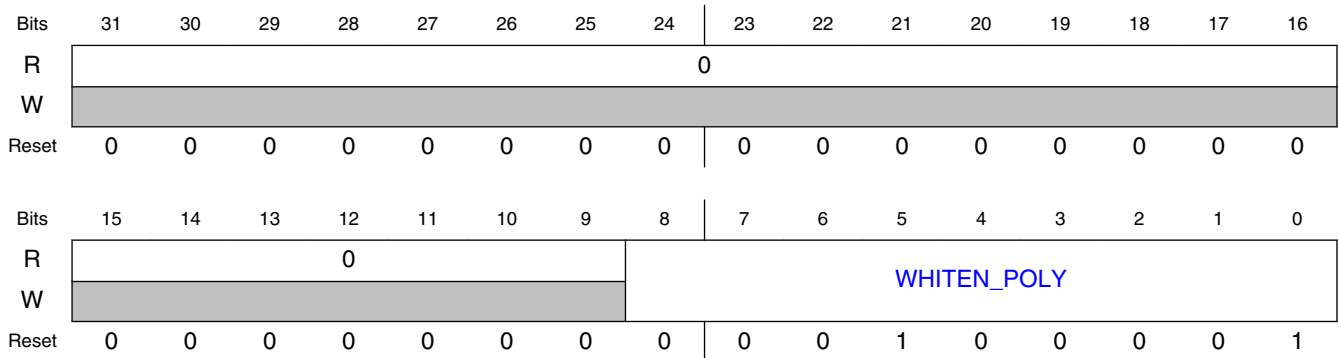

45.2.3.4.28.3 Fields

| Field | Function |
|--------------------|--|
| 31-9 Reserved | Reserved. |
| 8-0 WHITEN_POLY | Whitener Polynomial The 9-bit polynomial used in the whiten calculation. The polynomial value must be right-justified if smaller than 9-bits. |

45.2.3.4.29 WHITENER SIZE THRESHOLD (WHITEN_SZ_THR)

45.2.3.4.29.1 Address

| Register | Offset |
|---------------|-----------|
| WHITEN_SZ_THR | 4005F084h |

45.2.3.4.29.2 Diagram

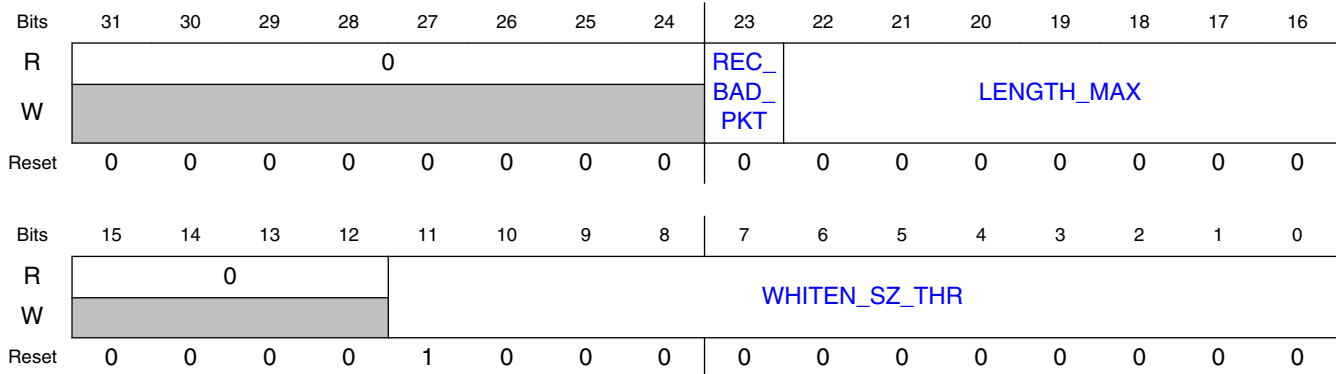

45.2.3.4.29.3 Fields

| Field | Function |
|---------------------------|--|
| 31-24 — | Reserved. |
| 23 REC_BAD_PKT | Receive Bad Packets Enable Packets which fail H0-filtering, H1-filtering, or Maximum Length-filtering, to be fully received without an RX recycle (intended for debug purposes) 0b - packets which fail H0, H1, or LENGTH_MAX result in an automatic recycle after the header is received and parsed 1b - packets which fail H0, H1, or LENGTH_MAX are received in their entirety |
| 22-16 LENGTH_MAX | Maximum Length for Received Packets Sets the Maximum Length Packet that can be received, in multiples of 16 bytes. LENGTH_MAX is compared directly against the extracted LENGTH field of the header (not the adjusted length). LENGTH_MAX=0 (default) is a special case that implies no limit. |
| 15-12 — | Reserved. |
| 11-0 WHITEN_SZ_T HR | Whitener Size Threshold Minimum Packet Length (extracted LENGTH field) required to enable whiten. Requires WHITEN_START=2 or 3 |

45.2.3.4.30 BIT RATE (BITRATE)

45.2.3.4.30.1 Address

| Register | Offset |
|----------|-----------|
| BITRATE | 4005F088h |

45.2.3.4.30.2 Diagram

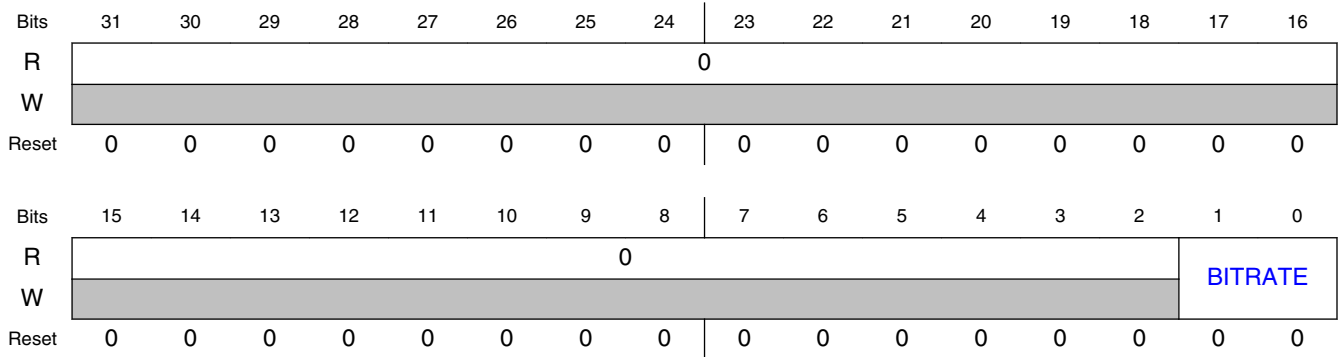

45.2.3.4.30.3 Fields

| Field | Function |
|------------------|--|
| 31-2 Reserved | Reserved. |
| 1-0 BITRATE | Bit Rate 00b - 1Mbit/sec 01b - 500Kbit/sec 10b - 250Kbit/sec (not supported if WHITEN_CFG[MANCHESTER_EN]=1) 11b - Reserved |

45.2.3.4.31 PACKET BUFFER PARTITION POINT (PB_PARTITION)

45.2.3.4.31.1 Address

| Register | Offset |
|--------------|-----------|
| PB_PARTITION | 4005F08Ch |

45.2.3.4.31.2 Diagram

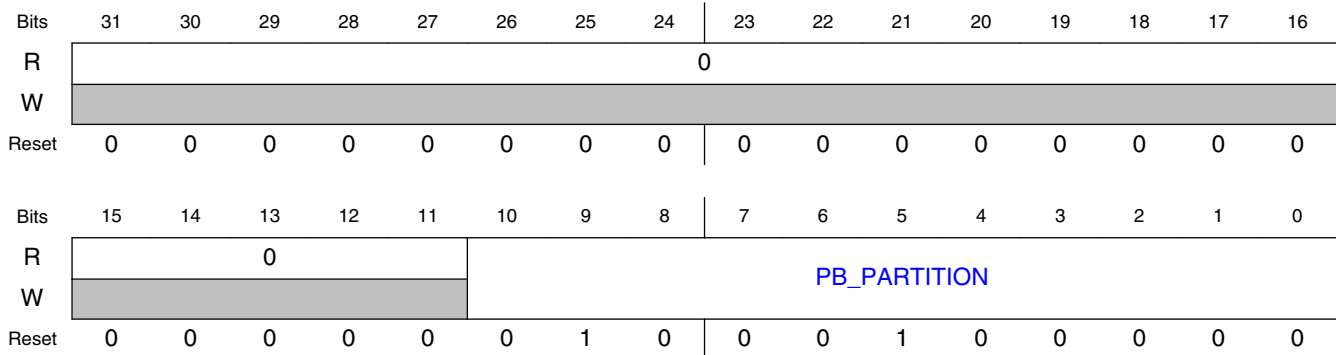

45.2.3.4.31.3 Fields

| Field | Function |
|----------------------|---|
| 31-11 Reserved | Reserved. |
| 10-0 PB_PARTITION | Packet Buffer Partition Point The Packet Buffer Partition Point defines the starting point for the RX segment of the Packet Buffer. The partitioning of the consolidated RAM between TX and RX is controlled by this configurable TX/RX Partition Point. PB_PARTITION can be programmed with any value between 0 (base of RAM0) and 1088 (after the last address of RAM1). The consolidated RAM is partitioned such that the TX buffer resides before the Partition Point (RAM entries 0 to (PB_PARTITION-1)), and the RX buffer resides after it (RAM entries PB_PARTITION to 1087). Programming the Partition Point register to 0 dedicates the entire consolidated RAM to RX; programming the Partition Point register to 1088 dedicates the entire consolidated RAM to TX; programming the Partition Point register to any value between 1 and 1087 yields a split TX/RX buffer. The TX segment (if any) is always first in the Packet Buffer, starting at Packet RAM address 0 of RAM0. Since the Packet Buffer RAM word-width is 2 bytes, the units for PB_PARTITION is "words". (Multiply by 2 to convert to byte addressing) |

45.2.3.4.32 PACKET BUFFER (PACKET_BUFFER_a)

45.2.3.4.32.1 Address

For a = 0 to 1087:

| Register | Offset |
|-----------------|----------------------|
| PACKET_BUFFER_a | 4005F700h + (a × 2h) |

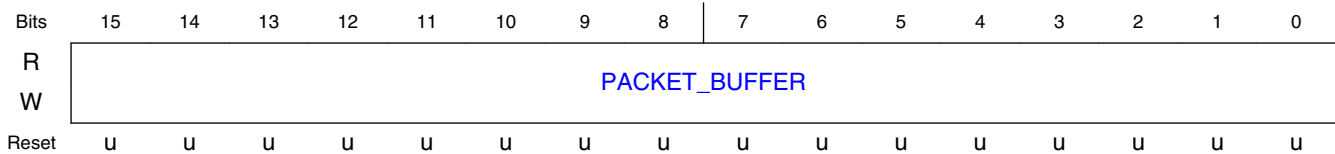
45.2.3.4.32.2 Diagram**45.2.3.4.32.3 Fields**

| Field | Function |
|---------------|--------------------------|
| 15-0 | PACKET BUFFER RAM |
| PACKET_BUFFER | Storage for packet data. |

45.3 Radio System Integration Module**45.3.1 Introduction**

The Radio System Integration Module (RSIM) provides support for the Radio specific System Integration requirements.

45.3.1.1 Features

The RSIM includes the following features:

- Status bit and enable of the BLE Ref Osc (Sysclk) Request
- Interrupt enable and flag for BLE Ref Osc (Sysclk) Request
- Power Mode specific enables for the RF Ref Osc
- Status bit and override control of the RF Ref Osc Ready signal
- Control of the SoC Platform Asynchronous Gasket Bypass
- Override control of the Stop Acknowledge signal from the Radio to the SoC
- Control bit to force BLE to exit deep sleep mode
- Control of the delay time for the BLE Active signal to the Flash
- Output enables for the two pad outputs of the BLE Active signal
- A 40-bit unique MAC address loaded from the SoC Flash IFR at Power On Reset
- SoC padding isolation controls for sensitive RF analog circuits

- Radio Reset blocking and a software Radio Reset control bit to support SoC and Radio concurrent testing
- Control 802.15.4/Generic FSK + DSM related.

45.3.1.2 Modes and Operations

The RSIM is always powered on, and is available for register reads and writes in any SoC mode where such are allowed.

The register values in the RSIM are powered by the 3v power domain, and will be maintained in all SoC low power modes except for a complete power down.

Any voltage isolation that is needed by the Radio to separate the 3v power domain from the 1.2v power domain is done in the RSIM.

In SoC test modes it is possible to isolate the Radio from the SoC to allow for concurrent testing of the two systems.

45.3.1.3 Radio Registers Access (CAUTION)

WARNING: If the Radio Register Clocks are not configured correctly before a Memory Access the SoC Core will halt. The descriptions below and the RSIM Register descriptions are intended to help avoid such a result.

45.3.1.3.1 BLE Link Layer Registers Access

The Radio Registers for the BLE Link Layer are accessed through an SoC Asynchronous Gasket in the Core Platform, and can only be accessed when the RF Ref Osc is Enabled and Ready, this is because the BLE Link Layer requires an accurate time-base clock for its time-keeping functions.

The BLE link layer will always exit reset by first Requesting the RF Ref Osc (Sysclk Req). By default, the BLE_RF_OSC_REQ_EN bit blocks that behavior to allow software to first configure the Radio and then enable the RF Ref Osc request. The status of the BLE RF Ref Osc request can be monitored using the BLE_RF_OSC_REQ_STAT bit.

Software can enable the BLE RF Ref Osc request to activate the RF Ref Osc, or it can use the RF_OSC_EN register to force the RF Ref Osc on. After the RF Ref Osc is enabled, software can monitor the RF_OSC_READY bit to determine when the RF Ref Osc is Enabled and Ready

WARNING: If the RF Ref Osc is not Enabled and Ready, and a BLE Link Layer Memory Access is attempted, then the SoC Asynchronous Gasket will block the SoC Core from proceeding as it waits for the Radio to send it the RF Ref Osc.

45.3.1.3.2 XCVR and 802.15.4 Registers Access

The Radio Registers for the XCVR and 802.15.4 are accessed through an SoC Asynchronous Gasket in the Core Platform, and they can be accessed with either the RF Ref Osc (Not Bypassed) or the SoC IPG clock (Bypassed).

The default behaviour of this Gasket is Not Bypassed, which means the Radio registers are accessed using the RF Ref Osc clock.

When the Gasket is Not Bypassed, the Radio sends the RF Ref Osc to the asynchronous gasket which then uses that clock for SoC register accesses of the Radio registers. This requires the RF Ref Osc to be Enabled and Ready.

If the RF Ref Osc is not Enabled and Ready, then the IPS Gasket can be overridden to be in Bypass Mode, which forces the use of the SoC IPG clock as the register access clock.

If the RF Ref Osc IS Enabled and Ready, then the IPS Gasket can be overridden to be in Bypass Mode, but this is an **ILLEGAL ACCESS** if the Radio is operational, **DO NOT** write Radio registers with the Asynchronous Gasket Bypassed when the Radio is Operating. Test mode access is allowed but glitches may occur.

WARNING: If the RF Ref Osc is not Enabled and Ready, and a XCVR or 802.15.4 Memory Access is attempted, then the SoC Asynchronous Gasket will block the SoC Core from proceeding as it waits for the Radio to send it the RF Ref Osc.

45.3.1.3.3 Asynchronous Gasket Bypass

The intent of Bypass Mode is to allow software to configure the Radio XCVR and 802.15.4 registers before the RF Ref Osc is Enabled and Ready.

The following table shows which clock is being used to access the Radio XCVR and 802.15.4 registers.

| Gasket Bypass Override Enable | Gasket Bypass Override | XCVR and 802.15.4 Register Clock |
|-------------------------------|------------------------|----------------------------------|
| 1 | 0 | RF Ref Osc Clock |
| 1 | 1 | SoC IPG Clock |
| 0 | x | RF Ref Osc Clock |

More details are available in the Radio Clocks diagram and in the Gasket Bypass Registers descriptions.

45.3.1.4 Interrupts

The RSIM module can generate two asynchronous interrupts:

- A 3 V interrupt that occurs on a rising edge of Link Layer Ref Osc (Sysclk) Request
- A 1.2 V interrupt that occurs on a rising edge of Link Layer Ref Osc (Sysclk) Request, or when Link Layers generates an interrupt

The 3 V interrupt is intended as an SoC Low Voltage Power Mode wakeup source.

The 1.2 V interrupt is intended as an asynchronous interrupt for the SoC core platform.

Both Interrupts are blocked if `BLOCK_RADIO_OUTPUTS` is set.

45.3.1.5 Block diagram

Radio System Integration Module

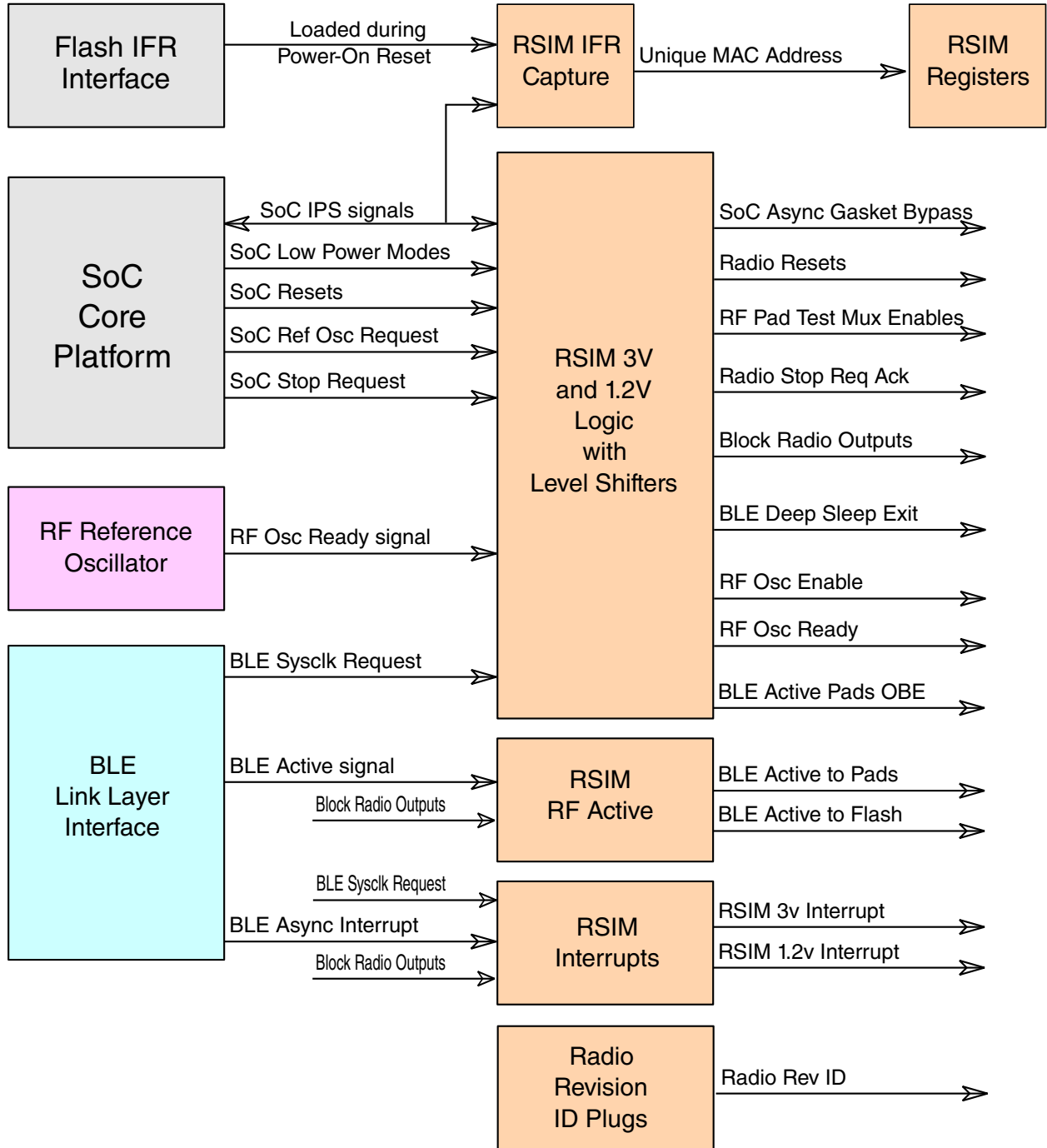

Figure 45-2. Block diagram

MKW41Z/31Z/21Z Reference Manual, Rev. 3, 03/2018

45.3.1.6 Radio Clocks diagram

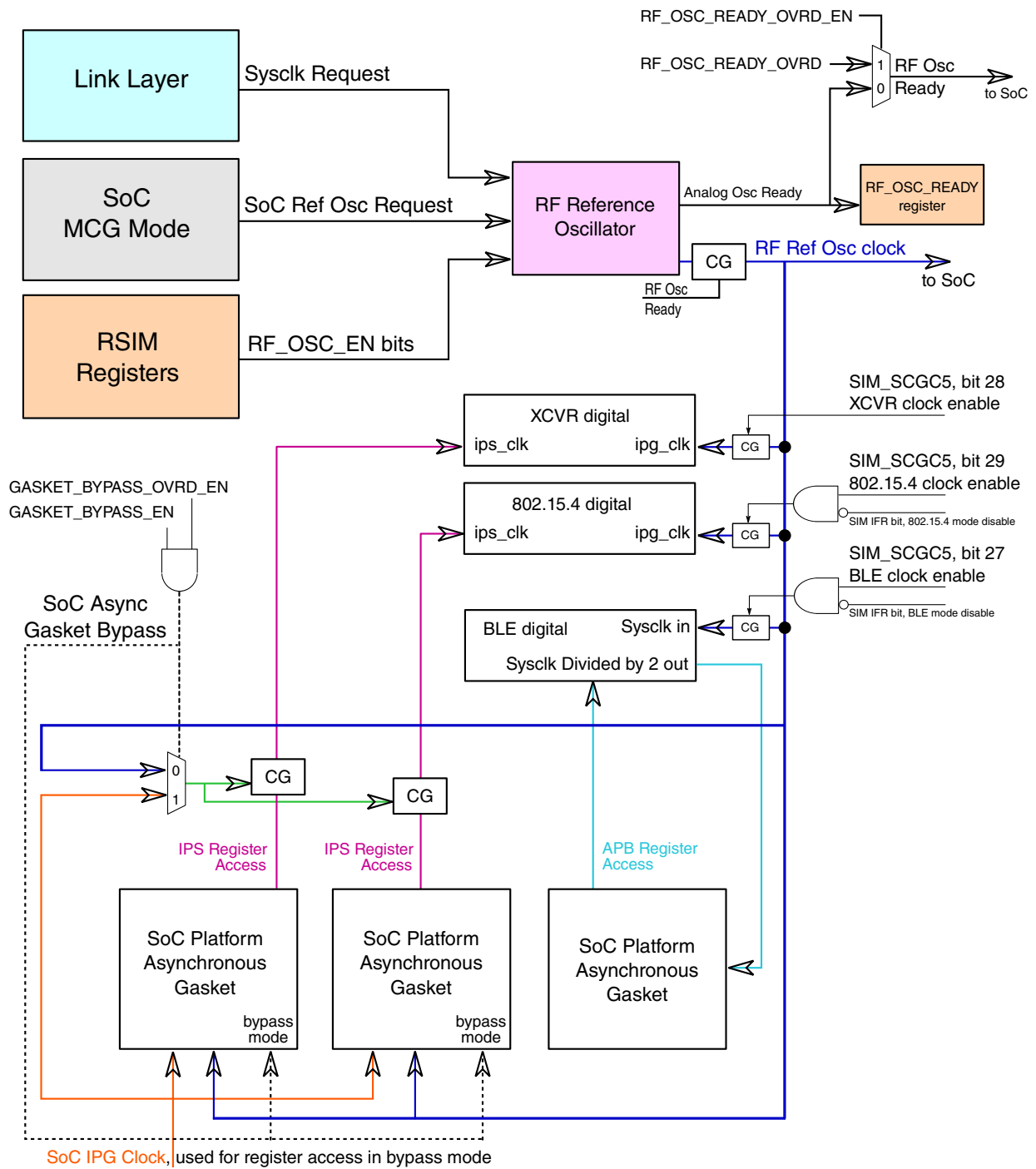

Figure 45-3. Radio Clocking Configuration

45.3.2 Memory Map and Register Definition

45.3.2.1 RSIM Register Descriptions

45.3.2.1.1 RSIM Memory Map

Base address: 40059000h

| Offset | Register | Width (In bits) | Access | Reset value |
|-----------|--|--------------------|--------|-------------|
| 40059000h | Radio System Control (CONTROL) | 32 | RW | 00C00002h |
| 40059004h | Radio Active Early Warning (ACTIVE_DELAY) | 32 | RW | 00000000h |
| 40059008h | Radio MAC Address (MAC_MSB) | 32 | RO | 00000000h |
| 4005900Ch | Radio MAC Address (MAC_LSB) | 32 | RO | 00000000h |
| 40059100h | Deep Sleep Timer (DSM_TIMER) | 32 | RO | 00000000h |
| 40059104h | Deep Sleep Timer Control (DSM_CONTROL) | 32 | RW | 00000000h |
| 40059108h | Deep Sleep Wakeup Time Offset (DSM_OSC_OFFSET) | 32 | RW | 00000000h |
| 40059114h | 802.15.4 Link Layer Sleep Time (ZIG_SLEEP) | 32 | RW | 00000000h |
| 40059118h | 802.15.4 Link Layer Wake Time (ZIG_WAKE) | 32 | RW | 00000000h |
| 4005911Ch | Generic FSK Link Layer Sleep Time (GEN_SLEEP) | 32 | RW | 00000000h |
| 40059120h | Generic FSK Link Layer Wake Time (GEN_WAKE) | 32 | RW | 00000000h |
| 40059124h | Radio Oscillator Control (RF_OSC_CTRL) | 32 | RW | A0203806h |
| 40059128h | Radio Analog Test Registers (ANA_TEST) | 32 | RW | 0000_0000h |
| 4005912Ch | Radio Analog Trim Registers (ANA_TRIM) | 32 | RW | 784B0000h |

45.3.2.1.2 Radio System Control (CONTROL)

45.3.2.1.2.1 Offset

| Register | Offset |
|----------|-----------|
| CONTROL | 40059000h |

45.3.2.1.2.2 Diagram

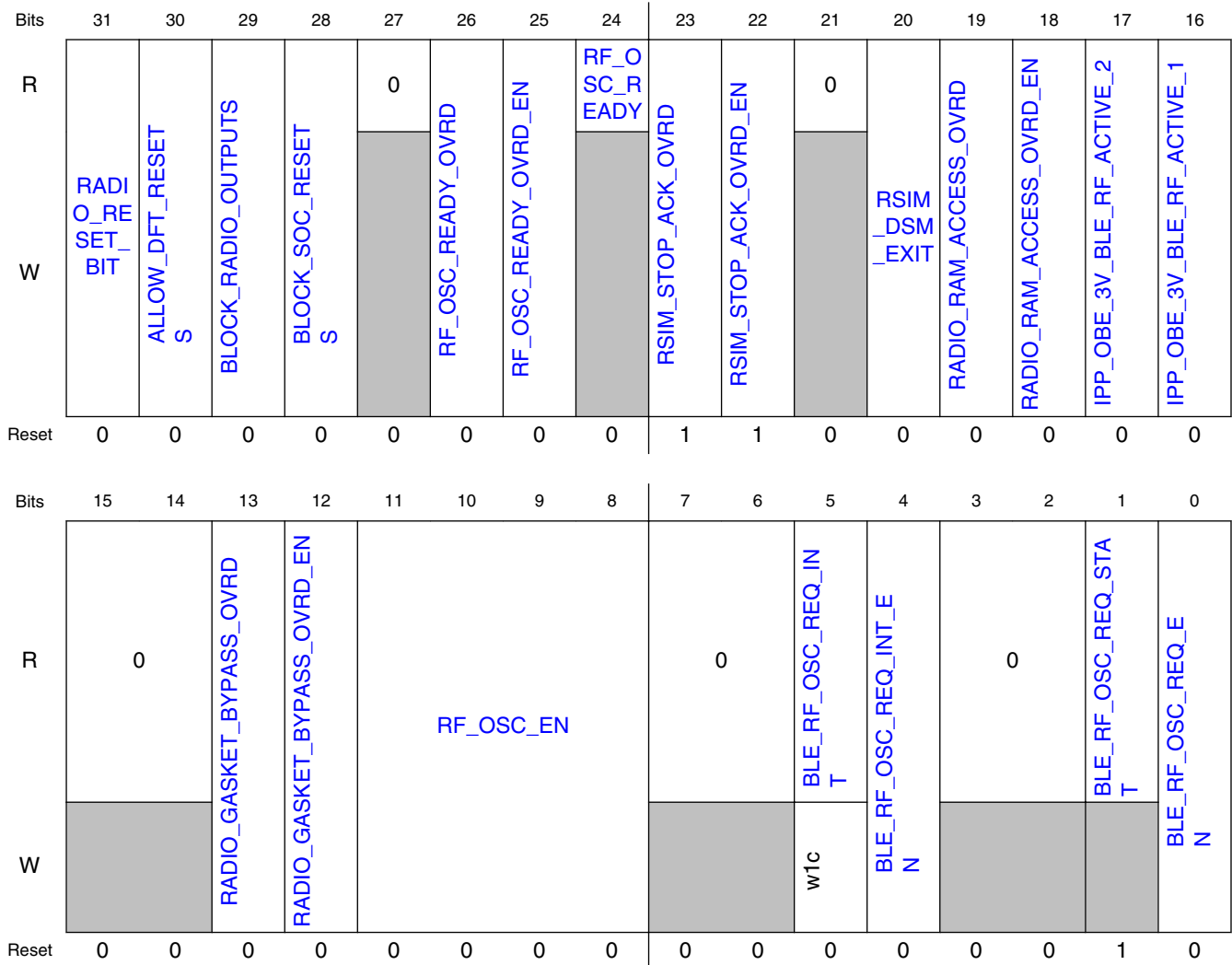

45.3.2.1.2.3 Fields

| Field | Function |
|---------------------------|---|
| 31 RADIO_RESET_BIT | Software Reset for the Radio This bit resets on POR only. When the Radio Resets are Blocked, setting this bit will reset all the radio logic until this bit is cleared. Note that due to internal Radio Reset Exit synchronizing logic there must be a second access to an RSIM register to clear this software reset, so please write this bit to 0 twice when clearing it. |
| 30 ALLOW_DFT_RESETS | Allow the DFT Reset Pin to Reset the Radio The Radio provides a port that can be connected to a test mode pin in order to provide a method of resetting the Radio independently from SoC resets. This bit enables that DFT functionality. |
| 29 BLOCK_RADIO_OUTPUTS | Block Radio Outputs |

Table continues on the next page...

Radio System Integration Module

| Field | Function |
|----------------------------------|--|
| | This bit resets on POR only. This bit is intended to allow the SoC to perform concurrent testing of various SoC logic while the Radio is operating independently. Any Radio output signals that go to the SoC will be blocked so as to not affect the SoC testing when this bit is set. |
| 28 BLOCK_SOC_RESETS | Block SoC Resets of the Radio This bit resets on POR only. This bit is intended to allow the SoC to perform concurrent testing of various SoC logic while the Radio is operating independently. Any SoC resets will be blocked and the Radio will not be affected by them when this bit is set. |
| 27 — | Reserved |
| 26 RF_OSC_READY_OVRD | RF Ref Osc Ready Override This bit directly controls the Radio RF Ref Osc Ready signal when the RF Ref Osc Ready Override is enabled. All Radio and SoC signals that are derived from the RF Ref Osc Ready signal can be overridden using this bit. |
| 25 RF_OSC_READY_OVRD_EN | RF Ref Osc Ready Override Enable This bit enables the RF Ref Osc Ready Override bit. |
| 24 RF_OSC_READY | RF Ref Osc Ready The RF Reference Oscillator has an internal counter that gates off the RF Ref Osc clock until the selected count is reached. This bit shows the status of the RF Ref Osc ready signal that comes from that counter. The RF Ref Osc Ready signal can be overridden using the RF_OSC_READY_OVRD bit. |
| 23 RSIM_STOP_ACK_OVRD | Stop Acknowledge Override This bit controls the Stop Acknowledge signal to the SoC Core Platform in Override mode. |
| 22 RSIM_STOP_ACK_OVRD_EN | Stop Acknowledge Override Enable This bit enables an override of the Stop Acknowledge signal. If not overwritten, Radio Stop Acknowledge is nominally based on the Deep Sleep Mode state of the Radio Link Layers and whether the Radio OSC is enabled by any means. |
| 21 — | Reserved |
| 20 RSIM_DSM_EXIT | BLE Force Deep Sleep Mode Exit This bit forces the BLE link layer to wakeup from Deep Sleep Mode. |
| 19 RADIO_RAM_ACCESS_OVRD | Radio RAM Access Override The Radio has two internal RAM blocks that are allowed to go into a low power state when they are not being used by a link layer. If this bit is set, then the RAMs are kept in an active power state to allow software to access them. |
| 18 RADIO_RAM_ACCESS_OVRD_EN | Radio RAM Access Override Enable This bit enables the Radio RAM Access Override bit. |
| 17 IPP_OBE_3V_BLE_RF_ACTIVE_2 | IPP_OBE_3V_BLE_ACTIVE_2 This bit enables the Output Driver (OBE) on the SoC port 2 that provides the BLE RF Active signal as a pad interface option. |
| 16 | IPP_OBE_3V_BLE_ACTIVE_1 |

Table continues on the next page...

| Field | Function |
|--|---|
| IPP_OBE_3V_BLE_RF_ACTIVE_1 | This bit enables the Output Driver (OBE) on the SoC port 1 that provides the BLE RF Active signal as a pad interface option. |
| 15-14 — | Reserved |
| 13 RADIO_GASKE_T_BYPASS_OVERRIDE | Radio Gasket Bypass Override This bit directly controls the SoC platform asynchronous gasket bypass signal when the Gasket Bypass Override is enabled. The default behavior of the SoC Asynchronous Gasket is Not Bypassed, which means the Radio registers are accessed using the RF Ref Osc clock. The Radio sends the RF Ref Osc to the asynchronous gasket which then uses that clock for SoC register accesses of the Radio registers. This requires the RF Ref Osc to be Enabled and Ready. If the RF Ref Osc is not Enabled and Ready, then the IPS Gasket can be overridden to be in Bypass Mode, which forces the use of the SoC IPG clock as the register access clock. If the RF Ref Osc Is Enabled and Ready, then the IPS Gasket can be overridden to be in Bypass Mode, but this is an ILLEGAL ACCESS if the Radio is operational, DO NOT write Radio registers with the Asynchronous Gasket Bypassed when the Radio is Operating. Test mode access is allowed but glitches may occur. The intent of Bypass Mode is to allow software to configure the Radio before the RF Ref Osc is Enabled and Ready. Note that the BLE Link Layer registers can only be accessed when the RF Ref Osc is Enabled and Ready. |
| 12 RADIO_GASKE_T_BYPASS_OVERRIDE_ENABLE | Radio Gasket Bypass Override Enable The SoC platform has an asynchronous gasket that allows register access for the Radio registers in all SoC clocking modes. This bit allows software to directly control the SoC platform asynchronous gasket bypass signal. |
| 11-8 RF_OSC_EN | RF Ref Osc Enable Select The RF Reference Oscillator can be enabled by a Radio link layer, by an internal SoC clock mode, by an External Pin request, or by these bits. If these bits are all cleared, 0000, then the RF Ref Osc will be controlled by the SoC, by an external pin request, or by a link layer. If any of these bits are set then the RF Ref Osc will be on in the SoC power modes as shown below. Note that the enables are additive; each bit adds another low power mode. 0000b - RF Ref Osc will be controlled by the SoC, external pin, or a link layer 0001b - RF Ref Osc on in Run/Wait 0011b - RF Ref Osc on in Stop 0111b - RF Ref Osc on in VLPR/VLPW 1111b - RF Ref Osc on in VLPS |
| 7-6 — | Reserved |
| 5 BLE_RF_OSC_REQ_INT | BLE Ref Osc (Sysclk) Request Interrupt Flag This bit is an interrupt flag that is set when the enabled version of the BLE Ref Osc (Sysclk) Request is asserted high. This interrupt flag is cleared by writing a 1 to it. |
| 4 BLE_RF_OSC_REQ_INT_EN | BLE Ref Osc (Sysclk) Request Interrupt Enable This bit enables an interrupt request when the enabled version of the BLE Ref Osc (Sysclk) Request is asserted high. |
| 3-2 — | Reserved |
| 1 BLE_RF_OSC_REQ_STAT | BLE Ref Osc (Sysclk) Request Status This bit indicates the current status of the BLE link layer request to turn on the RF Ref Oscillator (Sysclk Req). |
| 0 | BLE Ref Osc (Sysclk) Request Enable |

| Field | Function |
|-------------------|---|
| BLE_RF_OSC_REQ_EN | <p>This bit resets on POR only.</p> <p>If this bit is cleared (the default state), then all BLE link layer requests to turn on the RF Ref Oscillator (Sysclk Req) will be blocked and ignored.</p> <p>In BLE protocols the BLE link layer will always restart when exiting reset by first Requesting the RF Ref Osc (Sysclk Req), this bit blocks that behavior until software configures the Radio and enables the requests.</p> |

45.3.2.1.3 Radio Active Early Warning (ACTIVE_DELAY)

45.3.2.1.3.1 Offset

| Register | Offset |
|--------------|-----------|
| ACTIVE_DELAY | 40059004h |

45.3.2.1.3.2 Function

The RSIM BLE Active Delay register provides control bits to adjust the delay of the BLE Active signal that is presented to the SoC Flash System.

45.3.2.1.3.3 Diagram

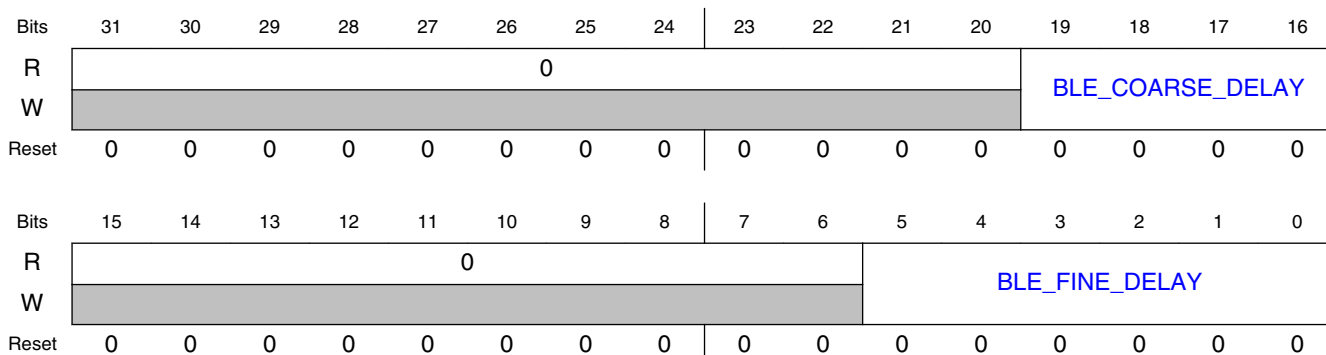

45.3.2.1.3.4 Fields

| Field | Function |
|-------|-------------------------|
| 31-20 | Reserved |
| — | |
| 19-16 | BLE Active Coarse Delay |

Table continues on the next page...

| Field | Function |
|-----------------------|--|
| BLE_COARSE_DELAY | The SoC Flash is presented with a BLE Active early warning signal to allow the Flash to complete any program or erase activities prior to a Radio communication event. This warning signal is delayed from the BLE Active signal provided by the BLE link layer. The timing of the Flash delay is calculated as follows: BLE Active link layer delay - (BLE Active Flash Fine Delay x 32 kHz clock period x 4) - (BLE Active Flash Coarse Delay x 32 kHz clock period x 64) |
| 15-6 — | Reserved |
| 5-0 BLE_FINE_DELAY | BLE Active Fine Delay The SoC Flash is presented with a BLE Active early warning signal to allow the Flash to complete any program or erase activities prior to a Radio communication event. This warning signal is delayed from the BLE Active signal provided by the BLE link layer. The amount of the delay from the BLE link layer is calculated as follows: BLE Active link layer delay - (BLE Active Flash Fine Delay x 32 kHz clock period x 4) - (BLE Active Flash Coarse Delay x 32 kHz clock period x 64) |

45.3.2.1.4 Radio MAC Address (MAC_MSB)

45.3.2.1.4.1 Offset

| Register | Offset |
|----------|-----------|
| MAC_MSB | 40059008h |

45.3.2.1.4.2 Function

The Radio MAC Address registers provide a unique ID that is stored in the Flash during factory test.

45.3.2.1.4.3 Diagram

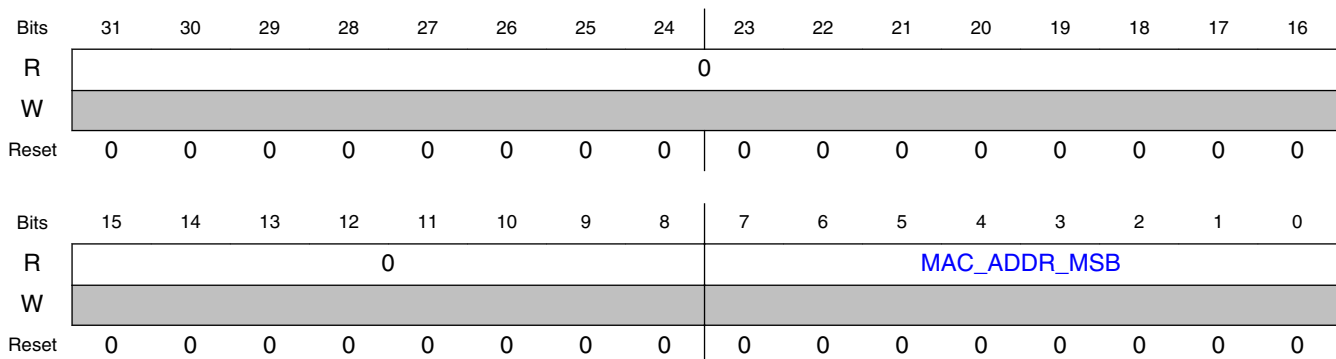

45.3.2.1.4.4 Fields

| Field | Function |
|---------------------|---|
| 31-8 Reserved | Reserved |
| 7-0 MAC_ADDR_MSB | Radio MAC Address MSB The Radio MAC Address is loaded from the Flash IFR during the SoC Power on Reset sequence. The MAC Address is a unique ID that is stored in the Flash during factory test. |

45.3.2.1.5 Radio MAC Address (MAC_LSB)

45.3.2.1.5.1 Offset

| Register | Offset |
|----------|-----------|
| MAC_LSB | 4005900Ch |

45.3.2.1.5.2 Function

The Radio MAC Address registers provide a unique ID that is stored in the Flash during factory test

45.3.2.1.5.3 Diagram

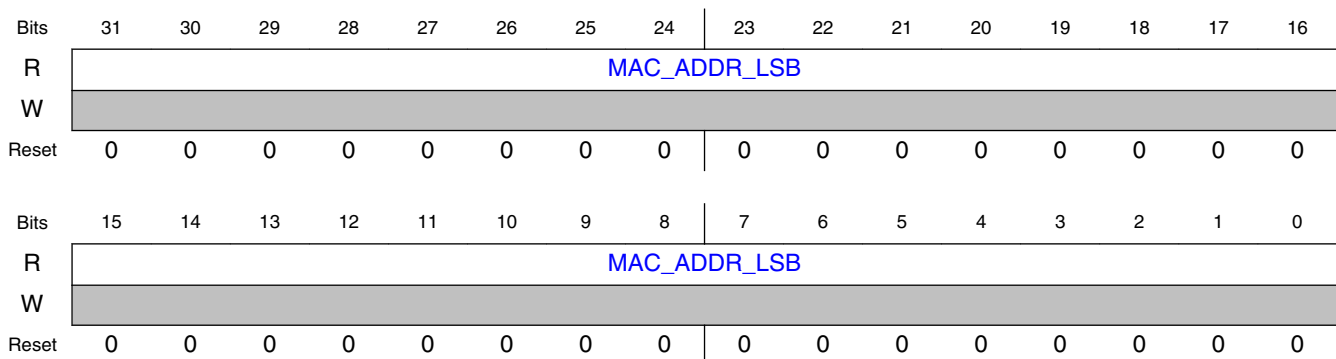

45.3.2.1.5.4 Fields

| Field | Function |
|----------------------|---|
| 31-0 MAC_ADDR_LSB | Radio MAC Address LSB The Radio MAC Address is loaded from the Flash IFR during the SoC Power on Reset sequence. The MAC Address is a unique ID that is stored in the Flash during factory test. |

45.3.2.1.6 Deep Sleep Timer (DSM_TIMER)

45.3.2.1.6.1 Offset

| Register | Offset |
|-----------|-----------|
| DSM_TIMER | 40059100h |

45.3.2.1.6.2 Diagram

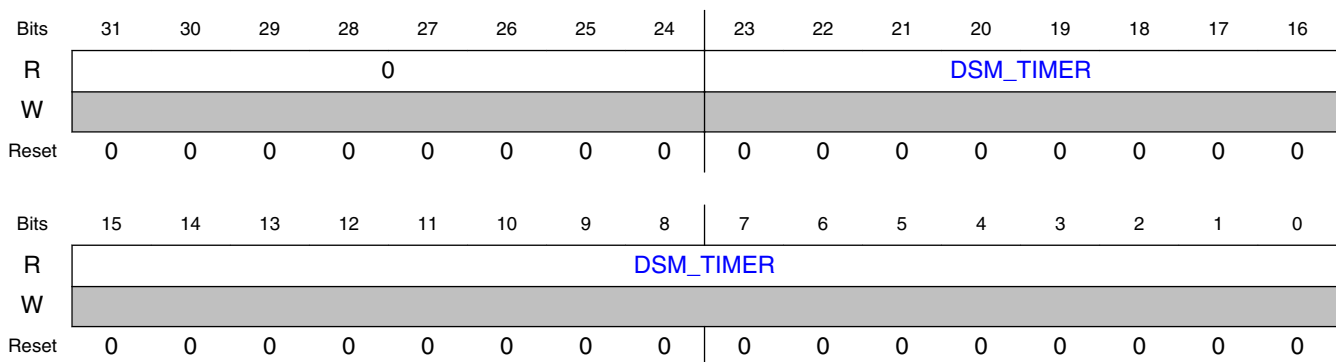

45.3.2.1.6.3 Fields

| Field | Function |
|-------------------|--|
| 31-24 — | Reserved |
| 23-0 DSM_TIMER | Deep Sleep Mode Timer This read only register shows the value of the Deep Sleep Timer. The timer counts clock cycles of the 32 kHz SoC oscillator whenever the DSM_TIMER_EN bit is set. The timer is reset to zero whenever the DSM_TIMER_CLR bit is set. |

45.3.2.1.7 Deep Sleep Timer Control (DSM_CONTROL)

45.3.2.1.7.1 Offset

| Register | Offset |
|-------------|-----------|
| DSM_CONTROL | 40059104h |

45.3.2.1.7.2 Diagram

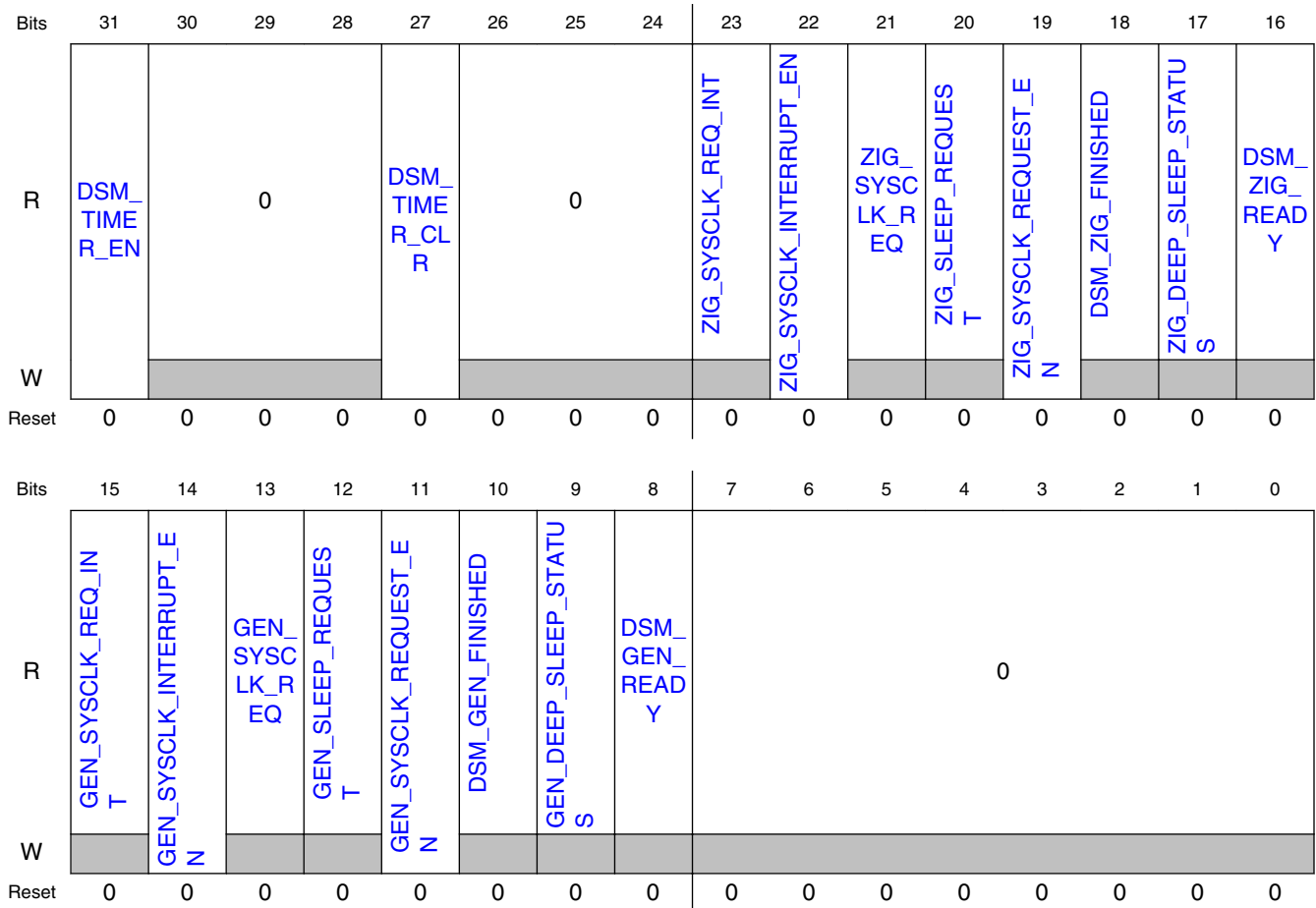

45.3.2.1.7.3 Fields

| Field | Function |
|---------------------|--|
| 31 DSM_TIMER_EN | Deep Sleep Mode Timer Enable Whenever this bit is set the Deep Sleep Mode Timer counts clock cycles of the 32 kHz SoC oscillator. |
| 30-28 — | Reserved |
| 27 DSM_TIMER_CLR | Deep Sleep Mode Timer Clear Whenever this bit is set the Deep Sleep Mode Timer is reset to zero. |
| 26-24 — | Reserved |
| 23 | Interrupt Flag from an 802.15.4 Link Layer RF OSC Request |

Table continues on the next page...

| Field | Function |
|-------------------------|---|
| ZIG_SYSCLK_REQ_INT | If the ZIG_SYSCLK_INTERRUPT_EN bit is set, then this flag indicates that an 802.15.4 RF OSC Request has occurred. The flag will persist until this bit is written with a 1 to clear it. |
| 22 | 802.15.4 Link Layer RF OSC Request Interrupt Enable |
| ZIG_SYSCLK_INTERRUPT_EN | If this bit is set, then a change from a 0 to a 1 on ZIG_SYSCLK_REQ will generate an interrupt which can be used by the SoC. |
| 21 | 802.15.4 Link Layer RF OSC Request Status |
| ZIG_SYSCLK_REQ | This bit shows the status of the 802.15.4 Link Layer Request for the RF OSC to be turned on. If the ZIG_SYSCLK_REQUEST_EN bit is set, then this signal is used by the RSIM to turn on the RF OSC if the RF OSC is not already turned on by another request source. |
| 20 | 802.15.4 Link Layer Deep Sleep Requested |
| ZIG_SLEEP_REQUEST | From the 802.15.4 Sleep Enable register. This enables a match of ZIG_SLEEP[23:0] to SLEEP_TMR[23:0]; when the match occurs Deep Sleep Mode is entered. |
| 19 | Enable 802.15.4 Link Layer to Request RF OSC |
| ZIG_SYSCLK_REQUEST_EN | This bit allows the 802.15.4 Link Layer to request turning on the RF OSC. |
| 18 | 802.15.4 Deep Sleep Time Finished |
| DSM_ZIG_FINISHED | This register is for debug purposes. This is the SLEEP_FINISHED state in the Deep Sleep Module State Machine, the state machine holds here until the Link Layer de-asserts the sleep_request. |
| 17 | 802.15.4 Link Layer Deep Sleep Mode Status |
| ZIG_DEEP_SLEEP_STATUS | This is the signal from the Deep Sleep Module State Machine telling the Link Layer to enter and exit Deep Sleep Mode. If this bit is set then the Link Layer is in Deep Sleep Mode. |
| 16 | 802.15.4 Ready for Deep Sleep Mode |
| DSM_ZIG_READY | This register is for debug purposes. This is the SLEEP_READY state in the Deep Sleep Module State Machine, the state machine holds here until the sleep time is reached on the 32 kHz clock counter (Deep Sleep Timer). |
| 15 | Interrupt Flag from an Generic FSK Link Layer RF OSC Request |
| GEN_SYSCLK_REQ_INT | If the GEN_SYSCLK_INTERRUPT_EN bit is set, then this flag indicates that an Generic FSK RF OSC Request has occurred. The flag will persist until this bit is written with a 1 to clear it. |
| 14 | Generic FSK Link Layer RF OSC Request Interrupt Enable |
| GEN_SYSCLK_INTERRUPT_EN | If this bit is set, then a change from a 0 to a 1 on GEN_SYSCLK_REQ will generate an interrupt which can be used by the SoC. |
| 13 | Generic FSK Link Layer RF OSC Request Status |
| GEN_SYSCLK_REQ | This bit shows the status of the Generic FSK Link Layer Request for the RF OSC to be turned on. If the GEN_SYSCLK_REQUEST_EN bit is set, then this signal is used by the RSIM to turn on the RF OSC if the RF OSC is not already turned on by another request source. |
| 12 | Generic FSK Link Layer Deep Sleep Requested |
| GEN_SLEEP_REQUEST | From the Generic FSK Sleep Enable register. This enables a match of GEN_SLEEP[23:0] to SLEEP_TMR[23:0]; when the match occurs Deep Sleep Mode is entered. |
| 11 | Enable Generic FSK Link Layer to Request RF OSC |
| GEN_SYSCLK_REQUEST_EN | This bit allows the Generic FSK Link Layer to request turning on the RF OSC. |
| 10 | Generic FSK Deep Sleep Time Finished |
| DSM_GEN_FINISHED | This register is for debug purposes. This is the SLEEP_FINISHED state in the Deep Sleep Module State Machine, the state machine holds here until the Link Layer de-asserts the sleep_request. |

Table continues on the next page...

Radio System Integration Module

| Field | Function |
|--------------------------------|--|
| 9 GEN_DEEP_SL EEP_STATUS | Generic FSK Link Layer Deep Sleep Mode Status This is the signal from the Deep Sleep Module State Machine telling the Link Layer to enter and exit Deep Sleep Mode. If this bit is set then the Link Layer is in Deep Sleep Mode. |
| 8 DSM_GEN_RE ADY | Generic FSK Ready for Deep Sleep Mode This register is for debug purposes. This is the SLEEP_READY state in the Deep Sleep Module State Machine, the state machine holds here until the sleep time is reached on the 32 kHz clock counter (Deep Sleep Timer). |
| 7-0 — | Reserved |

45.3.2.1.8 Deep Sleep Wakeup Time Offset (DSM_OSC_OFFSET)

45.3.2.1.8.1 Offset

| Register | Offset |
|----------------|-----------|
| DSM_OSC_OFFSET | 40059108h |

45.3.2.1.8.2 Diagram

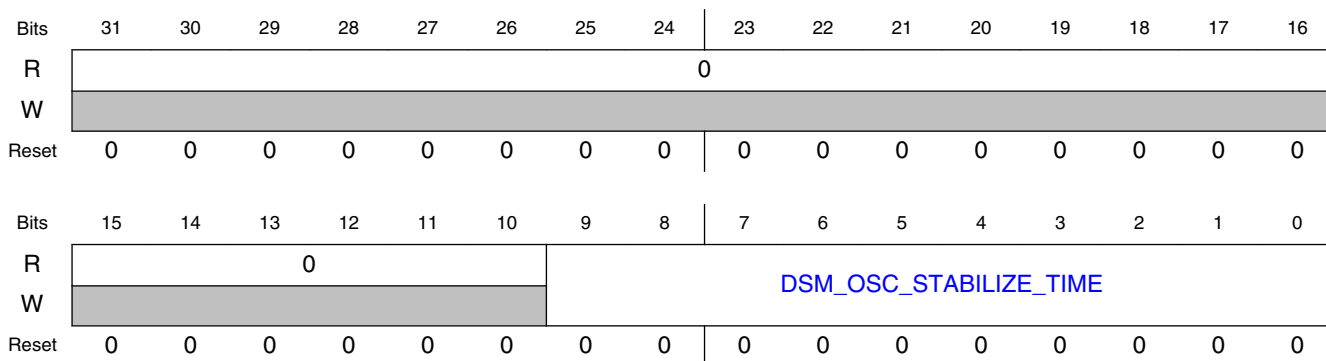

45.3.2.1.8.3 Fields

| Field | Function |
|-----------------------------------|--|
| 31-10 Reserved | Reserved |
| 9-0 DSM_OSC_STA BILIZE_TIME | Deep Sleep Wakeup RF OSC Stabilize Time This register should be programmed by software with the time needed for the RF OSC to stabilize to its specified accuracy after it is enabled. This time is represented by the number of clock cycles of the 32 |

| Field | Function |
|-------|---|
| | kHz SoC oscillator that should be counted before the link layer is allowed to exit Deep Sleep Mode on a wakeup event. This time offset will be used by the Deep Sleep State Machine to first turn on the RF OSC, then wait for it stabilize, and finally wakeup the link layer. |

45.3.2.1.9 802.15.4 Link Layer Sleep Time (ZIG_SLEEP)

45.3.2.1.9.1 Offset

| Register | Offset |
|-----------|-----------|
| ZIG_SLEEP | 40059114h |

45.3.2.1.9.2 Diagram

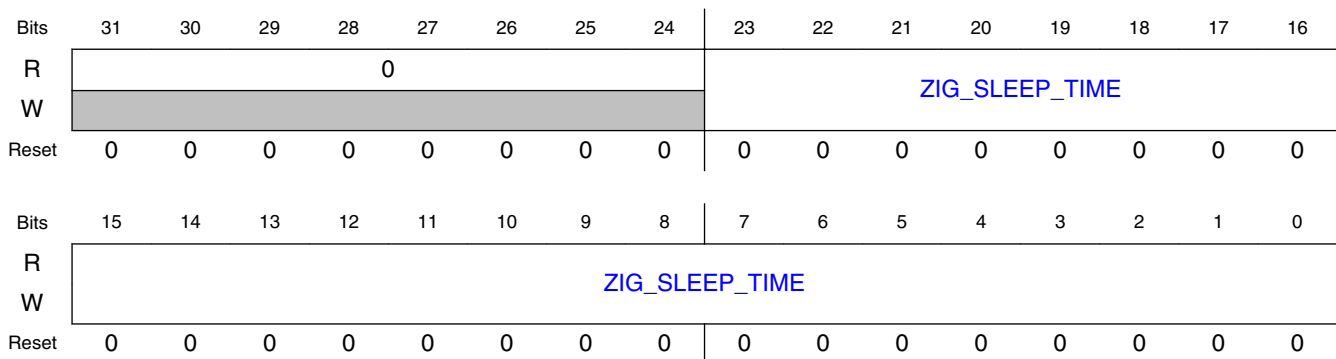

45.3.2.1.9.3 Fields

| Field | Function |
|------------------------|---|
| 31-24 — | Reserved |
| 23-0 ZIG_SLEEP_TIME | 802.15.4 Link Layer Sleep Time Software determines the future time at which it would like to enter Deep Sleep Mode by reading the DSM_TIMER, computing the number of 32 kHz clock cycles remaining until the desired DSM start-time, and writing that value into this register. The value programmed into this register should be no fewer than 4 clocks greater (in the future) than the current time as read from DSM_TIMER. |

45.3.2.1.10 802.15.4 Link Layer Wake Time (ZIG_WAKE)

45.3.2.1.10.1 Offset

| Register | Offset |
|----------|-----------|
| ZIG_WAKE | 40059118h |

45.3.2.1.10.2 Diagram

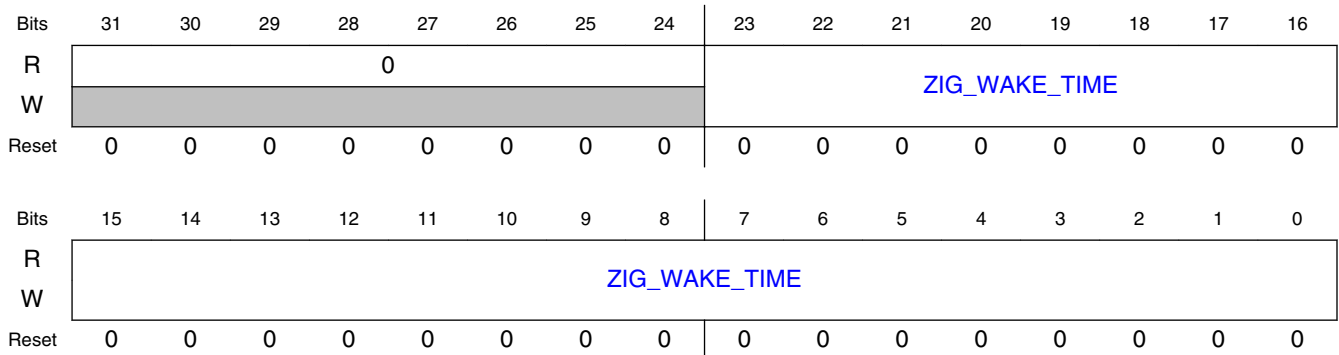

45.3.2.1.10.3 Fields

| Field | Function |
|-----------------------|---|
| 31-24 — | Reserved |
| 23-0 ZIG_WAKE_TIME | 802.15.4 Link Layer Wake Time Software determines the future time at which it would like to exit Deep Sleep Mode by reading the DSM_TIMER, computing the number of 32 kHz clock cycles remaining until the desired DSM exit time, and writing that value into this register. |

45.3.2.1.11 Generic FSK Link Layer Sleep Time (GEN_SLEEP)

45.3.2.1.11.1 Offset

| Register | Offset |
|-----------|-----------|
| GEN_SLEEP | 4005911Ch |

45.3.2.1.11.2 Diagram

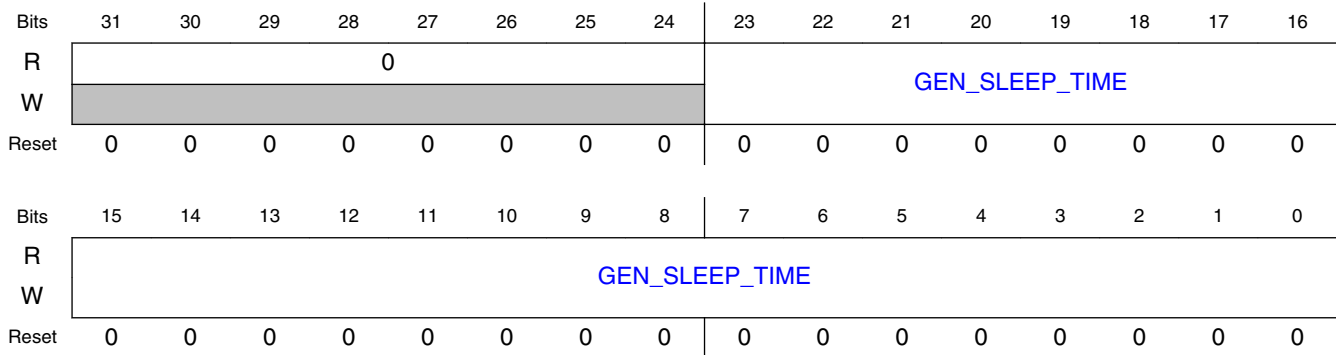

45.3.2.1.11.3 Fields

| Field | Function |
|------------------------|--|
| 31-24 — | Reserved |
| 23-0 GEN_SLEEP_TIME | Generic FSK Link Layer Sleep Time Software determines the future time at which it would like to enter Deep Sleep Mode by reading the DSM_TIMER, computing the number of 32 kHz clock cycles remaining until the desired DSM start-time, and writing that value into this register. The value programmed into this register should be no fewer than 4 clocks greater (in the future) than the current time as read from DSM_TIMER. |

45.3.2.1.12 Generic FSK Link Layer Wake Time (GEN_WAKE)

45.3.2.1.12.1 Offset

| Register | Offset |
|----------|-----------|
| GEN_WAKE | 40059120h |

45.3.2.1.12.2 Diagram

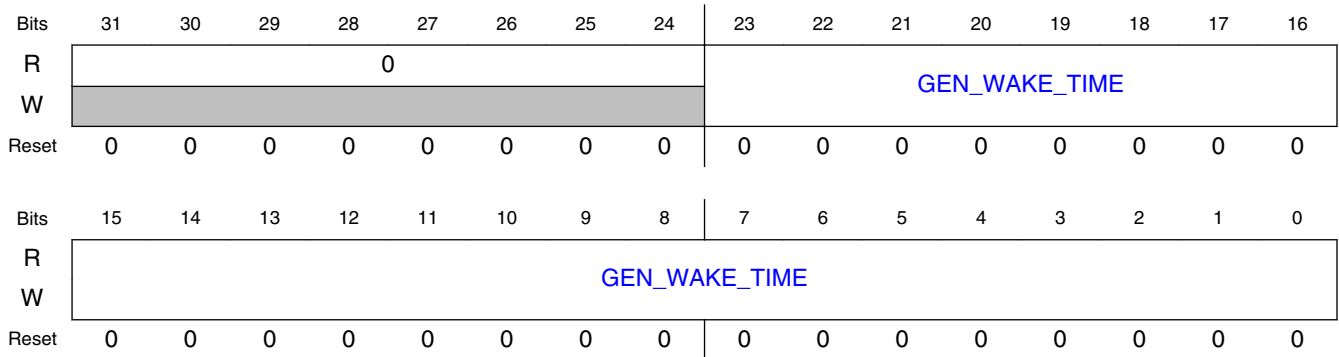

45.3.2.1.12.3 Fields

| Field | Function |
|-----------------------|--|
| 31-24 — | Reserved |
| 23-0 GEN_WAKE_TIME | Generic FSK Link Layer Wake Time Software determines the future time at which it would like to exit Deep Sleep Mode by reading the DSM_TIMER, computing the number of 32 kHz clock cycles remaining until the desired DSM exit time, and writing that value into this register. |

45.3.2.1.13 Radio Oscillator Control (RF_OSC_CTRL)

45.3.2.1.13.1 Offset

| Register | Offset |
|-------------|-----------|
| RF_OSC_CTRL | 40059124h |

45.3.2.1.13.2 Diagram

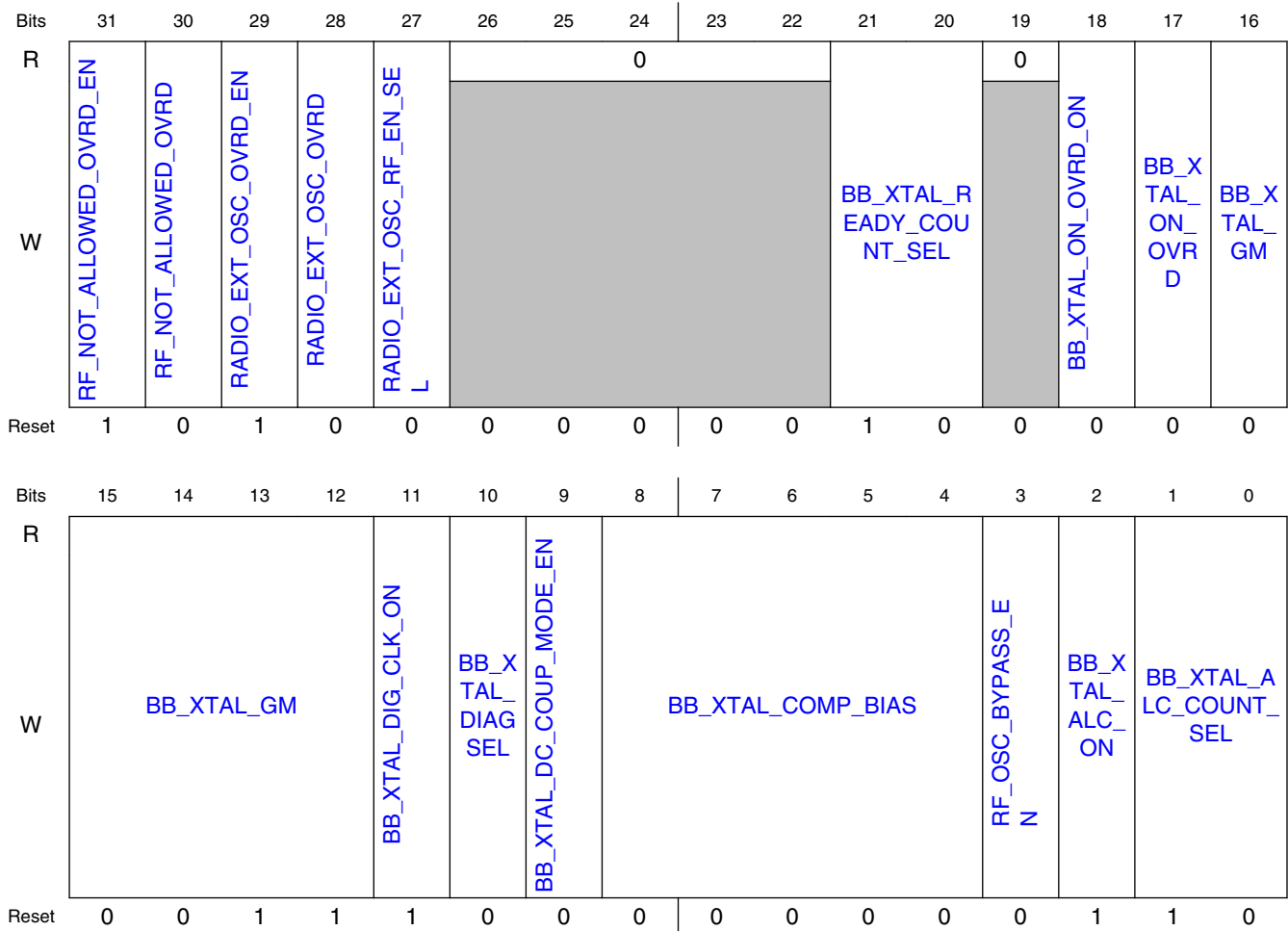

45.3.2.1.13.3 Fields

| Field | Function |
|------------------------------|--|
| 31 RF_NOT_ALLOWED_OVRD_EN | RF Not Allowed Override Enable This bit enables the RF Not Allowed Override bit. |
| 30 RF_NOT_ALLOWED_OVRD | RF Not Allowed Override The Radio has a pin which may be controlled by an external pad in the SoC in such a way as to allow an external device, such as another radio, to force this Radio to abort the current Radio Operation. This is intended to prevent two radios from interfering with each other. If the RF_NOT_ALLOWED_OVRD_EN bit is set, then this bit controls that RF Abort functionality. |
| 29 RADIO_EXT_OSC_OVRD_EN | Radio External Request for RF OSC Override Enable This bit enables the Radio External RF OSC Override bit. When RADIO_EXT_OSC_OVRD_EN=1, an external request through XTAL_OUT_EN pin will be ignored. |
| 28 | Radio External Request for RF OSC Override |

Table continues on the next page...

Radio System Integration Module

| Field | Function |
|---------------------------------|---|
| RADIO_EXT_O SC_OVRD | The Radio has two pins which may be controlled by external pads in the SoC in such a way as to allow an external device, such as another radio, to enable this Radio's RF Oscillator and provide the RF OSC clock to the external device using an external SoC pad. If the RADIO_EXT_OSC_OVRD_EN bit is set, then this bit controls that External RF OSC Request functionality. |
| 27 | Radio External Request for RF OSC Select |
| RADIO_EXT_O SC_RF_EN_SE L | The Radio has two pins which may be controlled by external pads in the SoC in such a way as to allow an external device, such as another radio, to enable this Radio's RF Oscillator. This bit selects which of the two pins has control of that external request. On KW41/KW31Z/KW21Z RADIO_EXT_OSC_RF_EN_SEL=0 maps to PTB0, RADIO_EXT_OSC_RF_EN_SEL=1 maps to PTC6. |
| 26-22 — | Reserved |
| 21-20 | rmap_bb_xtal_ready_count_sel_hv[1:0] |
| BB_XTAL_REA DY_COUNT_SE L | Program counter for xtal ready signal Sets up count value for XO startup time. 00 --> 1024 counts (32us @ 32MHz) 01 --> 2048 (64us @ 32MHz) 10 --> 4096 (128us @ 32MHz) 11 --> 8192 (256us @ 32MHz) |
| 19 — | Reserved |
| 18 | rmap_bb_xtal_on_ovrd_on_hv |
| BB_XTAL_ON_ OVRD_ON | Enable override XO enable bit Enable selector: 0 --> rfctrl_bb_xtal_on_hv is asserted 1 --> rfctrl_bb_xtal_on_ovrd_hv is asserted |
| 17 | rmap_bb_xtal_on_ovrd_hv |
| BB_XTAL_ON_ OVRD | Override XO enable |
| 16-12 | rmap_bb_xtal_gm_hv[4:0] |
| BB_XTAL_GM | Amplifier current bumps, bit [4] not used. Current values assume ALC is off Amplifier current bumps. bit [4] not used. Current values assume ALC is off 0 --> Min setting: 8 current sources on (TT27:60uA) ... 15 --> Max setting: 128 current sources on (TT27:960uA) |
| 11 | rmap_bb_xtal_dig_clk_on_hv |
| BB_XTAL_DIG_ CLK_ON | Enable digital clk output |
| 10 | rmap_bb_xtal_diagsel_hv |
| BB_XTAL_DIAG SEL | Enable diagnostics for XO block |
| 9 | rmap_bb_xtal_dc_coup_mode_en_hv |

Table continues on the next page...

| Field | Function |
|------------------------------|--|
| BB_XTAL_DC_COUP_MODE_EN | This bit enables the external dc coupled mode. This bit powers down the XO amplifier to enable DC coupled input. |
| 8-4 BB_XTAL_COM_P_BIAS | rmap_bb_xtal_comp_bias_hv[4:0] Not used. Spare for now. But future functionality is planned. |
| 3 RF_OSC_BYPASS_EN | RF Ref Osc Bypass Enable This bit engages the RF Ref Osc analog bypass circuit if the RF Ref Osc is enabled. When the RF Ref Osc is in bypass mode it passes the RF EXTAL clock as the RF Ref Osc clock. Note that the RF Ref Osc Ready signal functions normally in RF OSC Bypass mode, unless overridden with the RF_OSC_READY_OVRD_EN bit. |
| 2 BB_XTAL_ALC_ON | rmap_bb_xtal_alc_on_hv Enable ALC |
| 1-0 BB_XTAL_ALC_COUNT_SEL | rmap_bb_xtal_alc_count_sel_hv[1:0] Program counter for alc ready signal Sets up count value for fastcharge to turn off: 00 --> 2048 (64us @ 32MHz) 01 --> 4096 (128us @ 32MHz) 10 --> 8192 (256us @ 32MHz) 11 --> 16384 (512us @ 32MHz) |

45.3.2.1.14 Radio Analog Test Registers (ANA_TEST)

45.3.2.1.14.1 Offset

| Register | Offset |
|----------|-----------|
| ANA_TEST | 40059128h |

45.3.2.1.14.2 Diagram

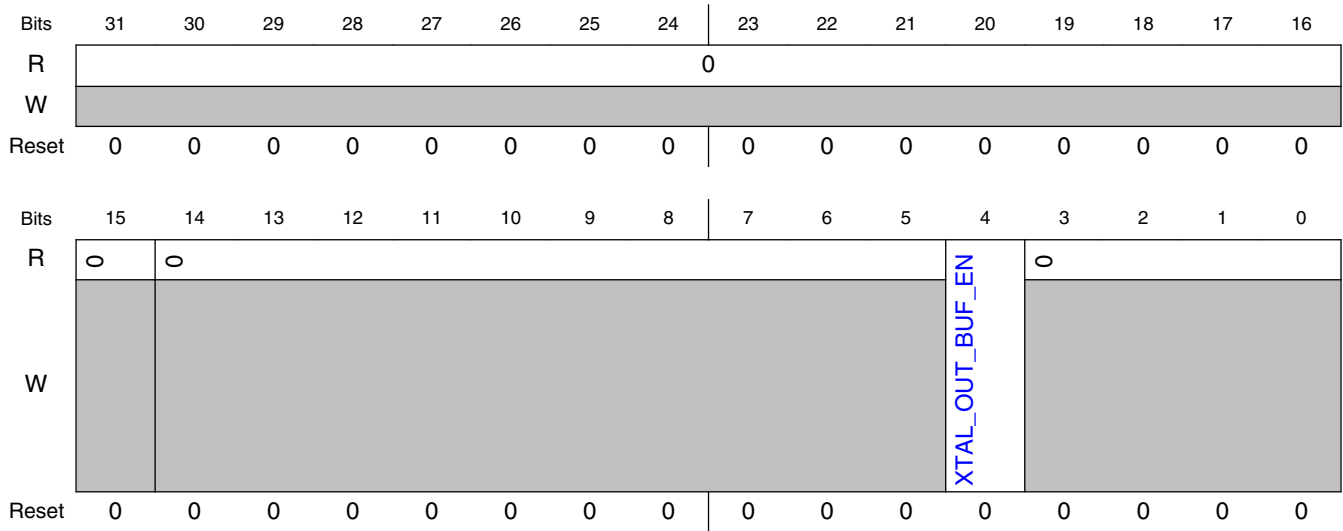

45.3.2.1.14.3 Fields

| Field | Function |
|----------------------|---|
| 31-15 — | Reserved |
| 14-5 — | Reserved. |
| 4 XTAL_OUT_BUF_EN | rmap_bb_xtal_test_en_hv The RF Analog Oscillator XTAL_OUT buffer for the XTAL_OUT SoC Pin is enabled when this bit is set. |
| 3-0 — | Reserved. |

45.3.2.1.15 Radio Analog Trim Registers (ANA_TRIM)

45.3.2.1.15.1 Offset

| Register | Offset |
|----------|-----------|
| ANA_TRIM | 4005912Ch |

45.3.2.1.15.2 Diagram

| | | | | | | | | | | | | | | | | |
|-------|------------------|----|----|----|----------------|----|----|----|-----------------|----|----------------|----|----|-----------------|----|----|
| Bits | 31 | 30 | 29 | 28 | 27 | 26 | 25 | 24 | 23 | 22 | 21 | 20 | 19 | 18 | 17 | 16 |
| R | BG_IBIAS_5U_TRIM | | | | BG_1V_TRIM | | | | BB_XTAL_TRIM | | | | | | | |
| W | | | | | | | | | | | | | | | | |
| Reset | 0 | 1 | 1 | 1 | 1 | 0 | 0 | 0 | 0 | 1 | 0 | 0 | 1 | 0 | 1 | 1 |
| Bits | 15 | 14 | 13 | 12 | 11 | 10 | 9 | 8 | 7 | 6 | 5 | 4 | 3 | 2 | 1 | 0 |
| R | BB_XTAL_SPARE | | | | BB_LDO_XO_TRIM | | | | BB_LDO_XO_SPARE | | BB_LDO_LS_TRIM | | 0 | BB_LDO_LS_SPARE | | |
| W | | | | | | | | | | | | | | | | |
| Reset | 0 | 0 | 0 | 0 | 0 | 0 | 0 | 0 | 0 | 0 | 0 | 0 | 0 | 0 | 0 | 0 |

45.3.2.1.15.3 Fields

| Field | Function |
|---------------------------|--|
| 31-28 BG_IBIAS_5U_TRIM | rmap_bg_ibias_5u_trim_hv[3:0] 5uA current trim bits. Default setting is 0111 Trim bits for VBG output current 0 -->3.55uA, 1 -->3.73uA, 2 -->4.04uA, 3 -->4.22uA, 4-->4.39uA, 5 -->4.57uA, 6 -->4.89uA, 7(Default) -->5.06uA , 8 -->5.23uA, 9 -->5.41uA, 10 --> 5.72uA, 11 --> 5.9uA, 12 --> 6.07uA, 13 --> 6.25uA, 14 --> 6.56uA, 15 --> 6.74uA |
| 27-24 BG_1V_TRIM | rmap_bg_1v_trim_hv[3:0] Trim bits for VBG output voltage Trim bits for VBG output voltage 0 -->954.14mV, 1 -->959.26mV, 2 -->964.38mV, |

Table continues on the next page...

Radio System Integration Module

| Field | Function |
|------------------------|---|
| | 3 -->969.5mV, 4-->974.6mV, 5 -->979.7mV, 6 -->984.8mV, 7 -->989.9mV, 8 (Default) -->995mV, 9 -->1V, 10 --> 1.005V, 11 --> 1.01V, 12 --> 1.015V, 13 --> 1.02V, 14 --> 1.025V, 15 --> 1.031V |
| 23-16 BB_XTAL_TRIM | rmap_bb_xtal_trim_hv[7:0] Bump XO load capacitor Load capacitor bumps. bit [7] not used. 0 --> Min C1: 5.7pF. Min C2: 7.1pF ... 127 --> Max C1: 22.6pF. Max C2: 28.2pF |
| 15-11 BB_XTAL_SPARE | rmap_bb_xtal_spare_hv[4:0] Bit 4: Force XTAL ready high Bit 4: Force XTAL ready high ; 0 --> Default functionality ; 1--> Force XTAL ready high Bit 3:0 are used for XO Output Driver Bit 3: XO output polarity invert bit; 0 --> No polarity inversion; 1 --> Polarity inverted Bit 2: Enable AuxPLL output instead of XO; 0 --> XO out; 1 --> AuxPLL out |
| 10-8 BB_LDO_XO_TRIM | rmap_bb_ldo_xo_trim_hv[2:0] Trim settings for LDO. Trim settings for LDO. 0 --> 1.20 V (Default) 1 --> 1.25 V 2 --> 1.28 V 3 --> 1.33 V 4 --> 1.40 V 5 --> 1.44 V 6 --> 1.50 V 7 --> 1.66 V |
| 7-6 BB_LDO_XO_SPARE | rmap_bb_ldo_xo_spare_hv[1:0] Spare bits for LDO, not used so far. |

Table continues on the next page...

| Field | Function |
|------------------------|---|
| 5-3 BB_LDO_LS_TRIM | rmap_bb_ldo_ls_trim_hv[2:0] Trim settings for LDO. Trim settings for LDO. 0 --> 1.20 V (Default) 1 --> 1.25 V 2 --> 1.28 V 3 --> 1.33 V 4 --> 1.40 V 5 --> 1.44 V 6 --> 1.50 V 7 --> 1.66 V |
| 2 — | Reserved |
| 1-0 BB_LDO_LS_SPARE | rmap_bb_ldo_ls_spare_hv[1:0] Spare bits. Not used so far. |

45.4 Transceiver Digital

45.4.1 Transmitter Digital Module

45.4.1.1 Introduction

The Transmitter Digital processes the Transmission Data from the RF Protocol Link Layers and presents the processed data to the PLL Frequency Synthesizer as the Baseband Frequency Word.

45.4.1.1.1 Block diagram

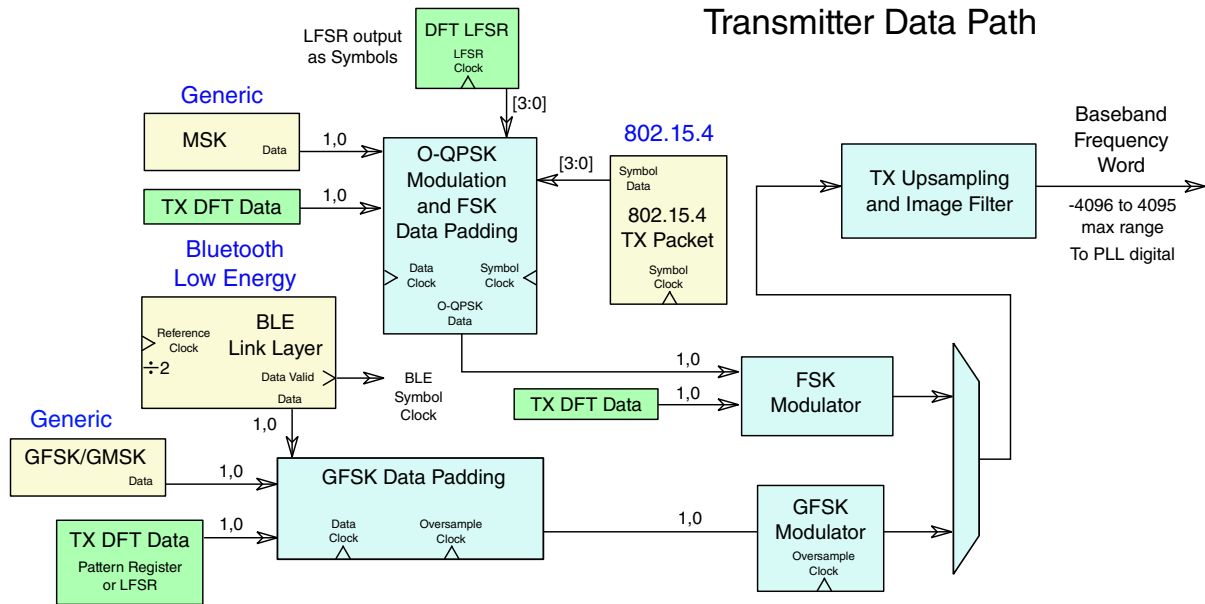

Figure 45-4. Transmitter Digital

45.4.1.1.2 Modulation Types

| Modulation Type ¹ | Data/Chip Rate (kbps) ² | BT Product ³ | Modulation Index ⁴ | Symbol Time (us) | Max Frequency Deviation (kHz) | Measured Channel BW (99.5% Power, kHz), no AFC | Spectral Efficiency (bits/Hz) ⁶ |
|----------------------------------|------------------------------------|-------------------------|-------------------------------|------------------|-------------------------------|--|--|
| IEEE 802.15.4 OQPSK ⁵ | 2000 | | 0.5 | 16 | 500 | 3205 | 0.623 ⁶ |
| GMSK/ GFSK, BT=0.5, h=0.5 | 1000 | 0.5 | 0.5 | 1 | 250 | 1105 | 0.905 |
| | 500 | 0.5 | 0.5 | 2 | 125 | 552.5 | 0.905 |
| | 250 | 0.5 | 0.5 | 4 | 62.5 | 276.25 | 0.905 |
| GFSK, BT=0.5, h=0.3 | 1000 | 0.5 | 0.32 | 1 | 160 | 988 | 1.012 |
| | 500 | 0.5 | 0.32 | 2 | 80 | 494 | 1.012 |
| | 250 | 0.5 | 0.32 | 4 | 40 | 247 | 1.012 |
| GFSK, BT=0.5, h=0.7 | 1000 | 0.5 | 0.7 | 1 | 350 | 1278 | 0.782 |
| | 500 | 0.5 | 0.7 | 2 | 175 | 639 | 0.782 |
| | 250 | 0.5 | 0.7 | 4 | 87.5 | 319.5 | 0.782 |
| GMSK, BT=0.3 | 1000 | 0.3 | 0.5 | 1 | 150 | 975 | 1.026 |
| | 500 | 0.3 | 0.5 | 2 | 75 | 487.5 | 1.026 |
| | 250 | 0.3 | 0.5 | 4 | 37.5 | 243.75 | 1.026 |
| GMSK, BT=0.7 | 1000 | 0.7 | 0.5 | 1 | 350 | 1167 | 0.857 |
| | 500 | 0.7 | 0.5 | 2 | 175 | 583.5 | 0.857 |

Table continues on the next page...

| | | | | | | | |
|-----|------|-----|-----|---|------|--------|-------|
| | 250 | 0.7 | 0.5 | 4 | 87.5 | 291.75 | 0.857 |
| MSK | 1000 | NA | 0.5 | 1 | 250 | 1605 | 0.623 |
| | 500 | NA | 0.5 | 2 | 125 | 802.5 | 0.623 |
| | 250 | NA | 0.5 | 4 | 62.5 | 401.25 | 0.623 |

1. Modulation Type is set using the PROTOCOL bits in the XCVR_CTRL register.
2. Data Rate is set using the BITRATE bits in the GENFSK register.
3. Bandwidth Time Product is changed by reprogramming the GFSK Gaussian Filter coefficients.
4. Modulation Index is set using the GFSK_MI register bits.
5. IEEE 802.15.4 uses O-QPSK modulation at a symbol rate of 62.5 ksp/s, which is spread to a chip rate of 2 Mbps.
6. For IEEE 802.15.4, the spectral efficiency is specified in Chips/Hz. The modulation uses PN spreading to achieve a robust transmission symbol rate of 62.5 kbps.

45.4.1.1.3 Data Rates

For BLE and 802.15.4 protocols the TX Data Rate is set automatically.

For other Radio protocols, the Transit Data Rate is set by the BITRATE bits in the GENFSK register.

The supported data rates are shown in the table below.

Table 45-1. Transmitter Data Rates

| GENFSK BITRATE[1:0] Register | TX Data Rate |
|------------------------------|---------------|
| 0 | 1000 kbit/sec |
| 1 | 500 kbit/sec |
| 2 | 250 kbit/sec |
| 3 | Reserved |

45.4.1.1.4 Over-Sampling

The TX Digital uses an Oversample Clock to process the transmission data.

The GFSK, GMSK, and MSK Oversample Ratios are summarized below.

Table 45-2. Oversample Ratios for GFSK, GMSK, and MSK Modulations

| TX Data Rate (kb/s) | Ref Clk Freq (MHz) | OSR Ref Clk Divider | OSR Clk Rate (MHz) | Data Oversample Rate |
|---------------------|--------------------|---------------------|--------------------|----------------------|
| 1000 | 32 | 4 | 8 | 8 |
| 500 | 32 | 8 | 4 | 8 |
| 250 | 32 | 16 | 2 | 8 |
| 1000 | 26 | 2 | 13 | 13 |
| 500 | 26 | 4 | 6.5 | 13 |
| 250 | 26 | 8 | 3.25 | 13 |

The 802.15.4 Oversample Ratios are summarized below.

Table 45-3. Oversample Ratios for IEEE 802.15.4 Modulations

| Symbol Rate (ksymbols/s) | Chip Rate (Mchip/s) | Ref Clk Freq (MHz) | OSR Ref Clk Divider | OSR Clk Rate (MHz) | Data Oversample Rate |
|--------------------------|---------------------|--------------------|---------------------|--------------------|----------------------|
| 62.5 | 2 | 32 | 2 | 16 | 8 |

45.4.1.1.5 Frequency Word Adjust

The Transmitter has a frequency adjustment register, `FREQ_WORD_ADJ`, which is used as a signed 9-bit number that is added to the TX Digital output before it is presented to the PLL as the baseband frequency word. This allows the baseband frequency word to be adjusted, or skewed, by a range of -512 to +511.

This frequency adjustment is applied to the final modulation word from any source (GFSK, FSK, DFT) and there is no protection from a math overflow. So the baseband frequency word range of -4096 to 4095 must be considered when adding this frequency word adjustment.

45.4.1.2 Data Pre-Processing

Before the Transmission Data is processed by the GFSK or FSK Modulators, it can be inverted, and it can also have additional preamble-like data pre-pended.

45.4.1.2.1 Data Polarity

The Transmission Data that is received by the TX Digital module is mapped to a positive frequency deviation if the data is a 1, and is mapped to a negative frequency deviation if the data is a 0

This mapping can be reversed by setting the `TX_CAPTURE_POL` register bit.

45.4.1.2.2 Data Padding

Transmission Data Padding is done to avoid abrupt steps in On-Air frequency modulation and thereby minimize spectral transients during the transition from a low Power Amplifier setting to a high Power Amplifier setting prior to protocol data packet transmission.

The abrupt step in modulation is avoided by pre-pending symbols of preamble-like modulation onto the front end of the actual preamble transmission. The Power Amplifier ramp-up is done while modulating these additional symbols, and then the modulating power ramp-up smoothly transitions into the packet transmission at the Target Power level.

Data padding is supported for all of the Radio Protocols packet preambles. For example, the BLE preamble is an alternating 1-0-1-0-1-0-1-0 or 0-1-0-1-0-1-0-1 pattern, depending on the first bit of the packet that follows. Data padding pre-pends the 1 or 0 pattern as required to match the preamble case.

The data padding pattern is programmed into two 8-bit register fields to allow for two padding choices as seen in the BLE example shown above. If 16 bits of padding is selected, the 8-bit register fields are used twice for each case.

The DATA_PADDING_EN bits in the XCVR_TSM_CTRL register enable data padding as follows:

Table 45-4. Data Padding Selection

| DATA_PADDING_EN[1:0] | Result |
|----------------------|-------------------------------|
| 00 | No Data Padding |
| 01 | 8 bits or symbols of padding |
| 10 | 16 bits or symbols of padding |
| 11 | Reserved |

45.4.1.2.3 Power Amplifier Ramping

The XCVR_TSM provides the TX Digital module with the ramp-up timing needed to adjust the data padding to match the time when the start of the protocol data packet transmission needs to go On-Air.

During ramp-down of the Power Amplifier the TX Digital holds the TX Modulation Data at the final value until power reaches the minimum level.

Please refer to the section Power Amplifier Ramping in the Radio Operations chapter for more details on the Power Ramping topic.

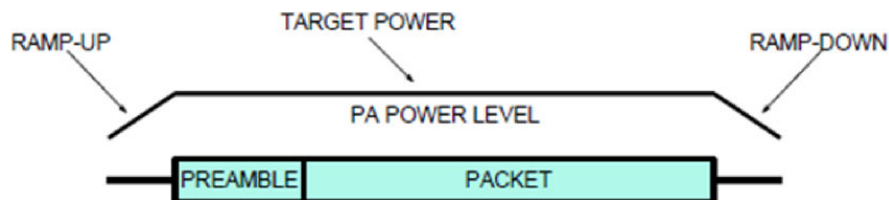

Figure 45-5. Power Amplifier Ramping

45.4.1.3 GFSK Modulator

45.4.1.3.1 Gaussian Filter

GFSK Modulation is implemented using a Gaussian filter and a lookup table to implement the various reference frequencies, data rates, and modulation index values.

The Gaussian filter is a symmetric 16-tap FIR filter with 11-bit quantized coefficients and supports reference frequencies of 32 and 26 MHz at oversampling ratios of 8 and 13 respectively. There are 2 sets of pre-programmed filter coefficients available as shown in the table below.

Table 45-5. Gaussian Filter Coefficients

| Filter OSR | 8 | 13 |
|-----------------|------------|------------|
| Tap Number(s) | 32 MHz Ref | 26 MHz Ref |
| 1 | 1 | 23 |
| 2 | 4 | 41 |
| 3 | 13 | 68 |
| 4 | 41 | 103 |
| 5 | 99 | 144 |
| 6 | 192 | 186 |
| 7 | 300 | 220 |
| 8 | 374 | 239 |
| 9 | 374 | 239 |
| 10 | 300 | 220 |
| 11 | 192 | 186 |
| 12 | 99 | 144 |
| 13 | 41 | 103 |
| 14 | 13 | 68 |
| 15 | 4 | 41 |
| 16 | 1 | 23 |
| Coefficient Sum | 2048 | 2048 |

The pre-programmed filter coefficients can be manually overridden using the GFSK_FLD bit to disable the GFSK Filter Lookup Table. In this case the filter coefficients will be taken from the TX GFSK Filter Coefficients register.

45.4.1.3.2 Multiplier

The GFSK Modulator has a multiplier in hardware that uses a lookup table to choose the correct value to multiply the output of the Gaussian filter by in order to get the correct frequency deviation range.

The lookup table value chosen is dependent upon the Reference Clock frequency, the Transmitter Data Rate, and the Modulation Index.

The GFSK Multiplier Lookup Table value can be overridden by setting the GFSK_MLD register bit and programming the GFSK_MULTIPLY_TABLE_MANUAL register to contain a valid integer, using bits [15:4], and a valid fraction, using bits [3:0].

45.4.1.3.3 Modulation Scaling

The GFSK modulator supports nominal modulation indices of 0.32, 0.5, 0.7 and 1.0. Transmit modulation scaling adds the capability to scale the GFSK modulated output up or down by a factor 1/32, 1/16 or 1/8. The scaling coefficients have been chosen so that the scaling can be realized without a multiplication.

The TX modulation scaling is equivalent to having some programmability on the nominal modulation index, which can be useful to alter the modulation bandwidth and/or effective frequency deviation of the TX modulation signal.

Transmit modulation scaling is applied to the Gaussian Filter output.

Table 45-6. Transmit Modulation Scaling Choices

| GFSK_MOD_INDEX_SCALING[2:0] | Modulation Scaling | Scaling of nominal modulation Index (%) |
|-----------------------------|--------------------|---|
| 0 | 1 | 0 |
| 1 | $1 + 1/32$ | +3.125 |
| 2 | $1 + 1/16$ | +6.25 |
| 3 | $1 + 1/8$ | +12.5 |
| 4 | $1 - 1/32$ | -3.125 |
| 5 | $1 - 1/16$ | -6.25 |
| 6 | $1 - 1/8$ | -12.5 |

45.4.1.4 FSK Modulator

45.4.1.4.1 FSK Modulation Word

The FSK modulation word presented to the PLL is a direct mapping of a data 1 to the signed value of the FSK_MODULATION_SCALE_1 register, and of a data 0 to the signed value of the FSK_MODULATION_SCALE_0 register. Note that a frequency inversion is allowed by inverting the values in these registers.

The default FSK Modulation mapping translates the chips/bits to a frequency modulation of +Frequency Deviation/PLL Minimum Modulation Step for a data 1, and -Frequency Deviation/PLL Minimum Modulation Step for a data 0.

For a 32 MHz reference clock with a PLL Minimum Modulation Step Size of 244.14 Hz, the default FSK Modulation mapping translates to a +/- 500 kHz peak Frequency Deviation, which is a PLL Baseband Frequency Word of +2047/-2047.

45.4.1.4.1.1 Half-Sine Pulse Shaping

The half-sine pulse shaping results from the inherent VCO reaction to the digital FSK modulation and the resulting modulation is as specified in IEEE 802.15.4 section 10.2.5, Figure 71, shown below.

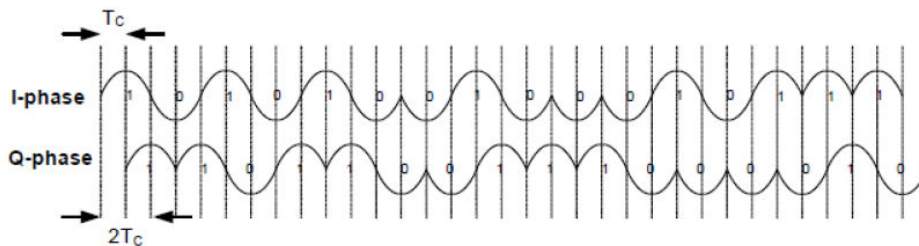

Figure 71—Sample baseband chip sequences with pulse shaping

Figure 45-6. Half-Sine Pulse Shaping

45.4.1.4.2 802.15.4 Modes

The 802.15.4 Modes implement the 802.15.4 Symbol to Chip data mapping and the Phase to Frequency Conversion.

Symbol data is received from the 802.15.4 PHY as 4-bit nibbles at a 62.5 kHz data rate. The symbols are mapped into a 32-chip PN sequence as specified in IEEE 802.15.4 section 10.2.4, Figure 73, shown below.

Table 73—Symbol-to-chip mapping for the 2450 MHz band

| Data symbol | Chip values (c_0 c_1 ... c_{30} c_{31}) |
|-------------|---|
| 0 | 1 1 0 1 1 0 0 1 1 1 0 0 0 0 1 1 0 1 0 1 0 0 1 0 0 0 1 0 1 1 1 0 |
| 1 | 1 1 1 0 1 1 0 1 1 0 0 1 1 1 0 0 0 0 1 1 0 1 0 1 0 0 1 0 0 0 1 0 |
| 2 | 0 0 1 0 1 1 1 0 1 1 0 1 1 0 0 1 1 1 0 0 0 0 1 1 0 1 0 1 0 0 1 0 |
| 3 | 0 0 1 0 0 0 1 0 1 1 1 0 1 1 0 1 1 0 0 1 1 1 0 0 0 0 1 1 0 1 0 1 |
| 4 | 0 1 0 1 0 0 1 0 0 0 1 0 1 1 1 0 1 1 0 1 1 0 0 1 1 1 0 0 0 0 1 1 |
| 5 | 0 0 1 1 0 1 0 1 0 0 1 0 0 0 1 0 1 1 1 0 1 1 0 1 1 0 0 1 1 1 0 0 |
| 6 | 1 1 0 0 0 0 1 1 0 1 0 1 0 0 1 0 0 0 1 0 1 1 1 0 1 1 0 1 1 0 0 1 |
| 7 | 1 0 0 1 1 1 0 0 0 0 1 1 0 1 0 1 0 0 1 0 0 0 1 0 1 1 1 0 1 1 0 1 |
| 8 | 1 0 0 0 1 1 0 0 1 0 0 1 0 1 1 0 0 0 0 0 0 1 1 1 0 1 1 1 1 0 1 1 |
| 9 | 1 0 1 1 1 0 0 0 1 1 0 0 1 0 0 1 0 1 1 0 0 0 0 0 0 1 1 1 0 1 1 1 |
| 10 | 0 1 1 1 1 0 1 1 1 0 0 0 1 1 0 0 1 0 0 1 0 1 1 0 0 0 0 0 0 1 1 1 |
| 11 | 0 1 1 1 0 1 1 1 1 0 1 1 1 0 0 0 1 1 0 0 1 0 0 1 0 1 1 0 0 0 0 0 |
| 12 | 0 0 0 0 0 1 1 1 0 1 1 1 1 0 1 1 1 0 0 0 1 1 0 0 1 0 0 1 0 1 1 0 |
| 13 | 0 1 1 0 0 0 0 0 0 1 1 1 0 1 1 1 1 0 1 1 1 0 0 0 1 1 0 0 1 0 0 1 |
| 14 | 1 0 0 1 0 1 1 0 0 0 0 0 0 1 1 1 0 1 1 1 1 0 1 1 1 0 0 0 1 1 0 0 |
| 15 | 1 1 0 0 1 0 0 1 0 1 1 0 0 0 0 0 0 1 1 1 0 1 1 1 1 0 1 1 1 0 0 0 |

Figure 45-7. Symbol to Chip mapping

The chip sequences representing each data symbol are modulated using O-QPSK as specified in IEEE 802.15.4 section 10.2.5, Figure 70, shown below.

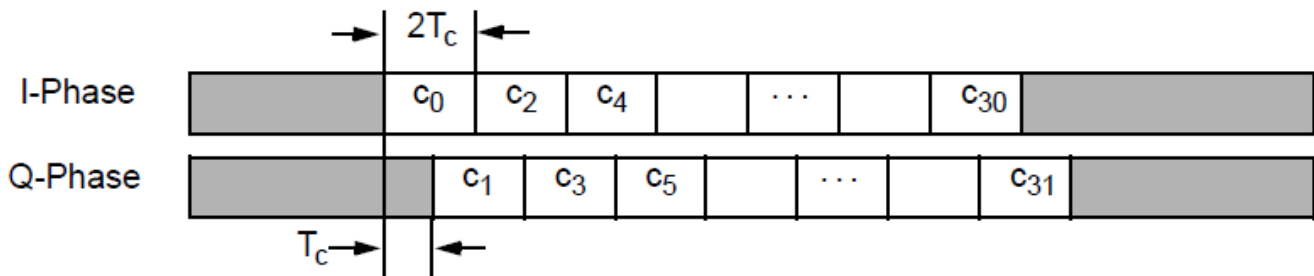

Figure 70—O-QPSK chip offsets

Figure 45-8. O-QPSK Digital Modulation

Even-indexed chips are modulated onto the in-phase (I), and odd-indexed chips are modulated onto the quadrature-phase (Q).

A phase to frequency conversion is done, and the modulated data is presented to the PLL as a stream of modulated bits at the chip/bit rate as selected by the 802.15.4 Link Layer.

45.4.1.4.3 MSK Modes

Minimum-shift keying (MSK) is a type of continuous-phase frequency-shift keying with a frequency separation of one-half the bit rate. MSK modulation construction is quite similar to O-QPSK; MSK is encoded with bits alternating between quadrature components, with the Q component delayed by half the symbol period.

However, instead of square pulses as used by ordinary O-QPSK, MSK encodes each bit as a half sinusoid, which is similar to IEEE 802.15.4 O-QPSK. This results in a constant-modulus signal (constant envelope signal), which reduces problems caused by non-linear distortion.

In MSK the difference between the higher and lower frequency is identical to half the bit rate. Consequently, the waveforms used to represent a 0 and a 1 bit differ by exactly half a carrier period.

Thus, the maximum frequency deviation is $\delta = 0.25 f_m$ where f_m is the maximum modulating frequency. As a result, the modulation index M is 0.5. This is the smallest FSK modulation index that can be chosen such that the waveforms for 0 and 1 are orthogonal.

As an example, 1 Mbps MSK would result in a frequency deviation of ± 250 kHz.

MSK data comes to the O-QPSK Modulator at the chip/data rate (no symbol to chip mapping is done), and the O-QPSK conversion is done on the data in the same manner as it is in IEEE 802.15.4 section 10.2.5, Figure 70, shown above.

45.4.1.5 Data Post-Processing

After the Transmission Data is processed by the GFSK or FSK Modulators, it can be post-processed to remove TX modulation images.

45.4.1.5.1 Sample/Hold Images

Power efficient constant envelope transmit modulation is done at a multiple of the symbol clock (Over-Sample Rate), which is chosen as a fraction of the RF Osc reference clock frequency. The transmit modulation signal is then converted to the reference clock rate, at which it is presented to the PLL as the modulation word. This sample/hold (or zero-order hold, ZOH) operation results in TX modulation images that repeat at the fractional reference clock rate at used.

These modulation images are automatically filtered by the sinc ZOH transfer function and the integration (i.e., 1/s) operation of the VCO. These inherent filtering operations result in these modulation images not violating any of the transmit modulation frequency mask. However, to provide additional spectral margin to support using an external power amplifier to boost the transmit power, an image suppression set of FIR filters has been included in the transmit path to suppress the transmit sample/hold images by at least an additional 20 dB.

The transmit image filters are enabled by default in GFSK and GMSK modes and not enabled in IEEE 802.15.4 and MSK modulation modes, but their usage can be overridden using the TX_IMAGE_FILTER_OVRD_EN bit.

45.4.1.5.2 Image Filters

The Transmitter uses up to three image filters, by default they are enabled based upon the modulation type and data rate as shown below:

Table 45-7. Default Transmit Image Filter Usage

| Modulation Type; Data Rate | TX Image Filter 2 | TX Image Filter 1 | TX Image Filter 0 |
|-------------------------------------|-------------------|-------------------|-------------------|
| OQPSK/FSK/MSK Modes; All data rates | 0 | 0 | 0 |
| GFSK/GMSK; 1000 kbps | 0 | 0 | 1 |
| GFSK/GMSK; 500 kbps | 0 | 1 | 1 |
| GFSK/GMSK; 250 kbps | 1 | 1 | 1 |

45.4.1.5.3 Image Filters Frequency Response

The frequency response of the TX image suppression filters and the reduction in the level of TX images for the 1 Mbps GMSK (BLE) with the FIR filter are demonstrated in the plots below.

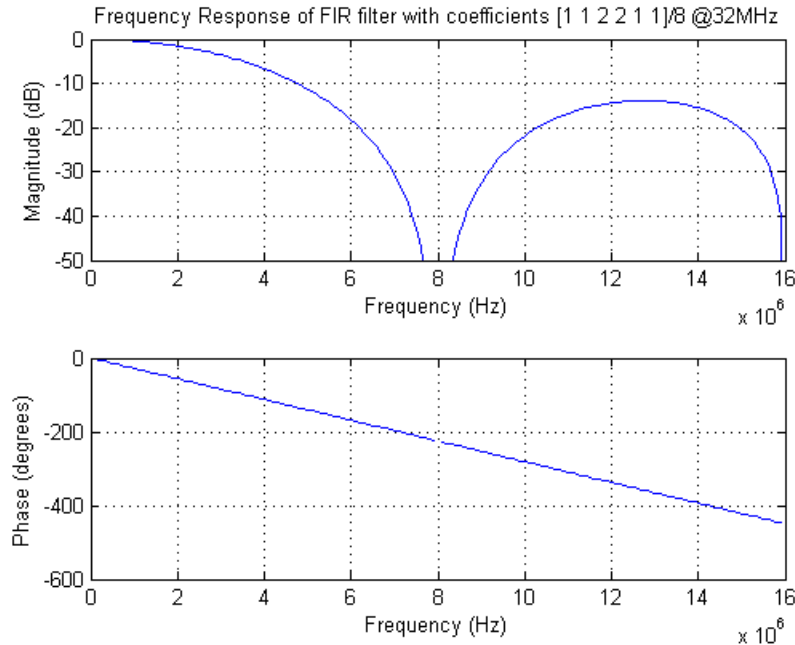

Figure 45-9. Frequency response of the 6-Tap FIR Transmit Image Suppression filter

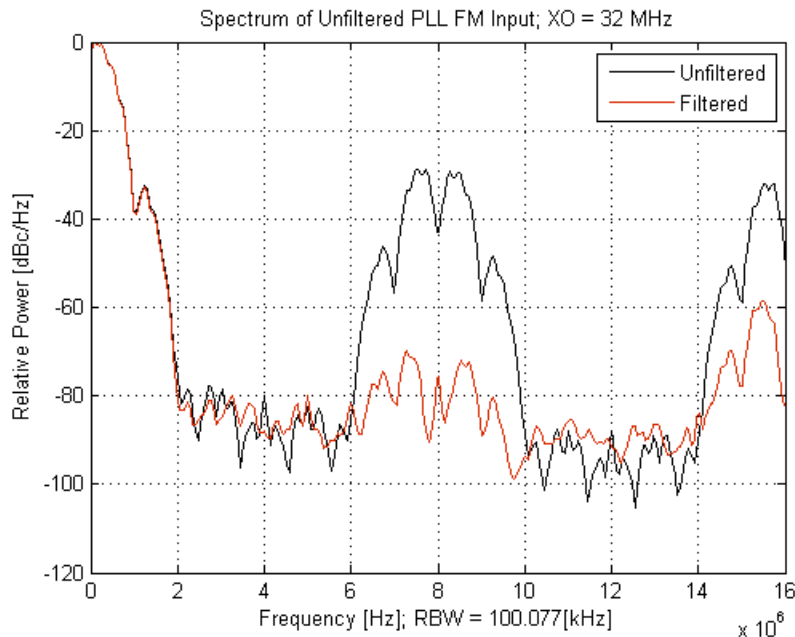

Figure 45-10. Comparison of Transmit Modulation Images at the PLL Input for BLE

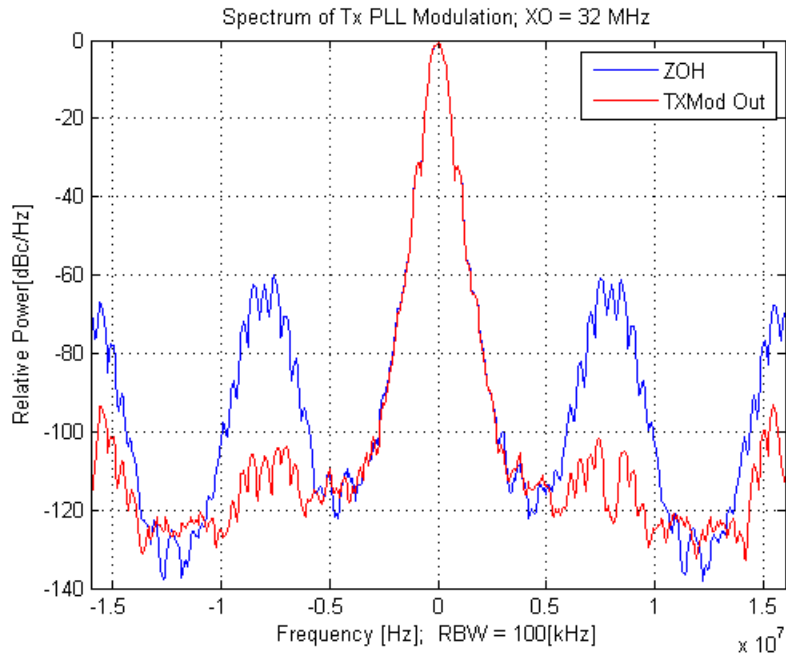

Figure 45-11. Comparison of Transmit Modulation Images at the PLL Output for BLE (1 Mbps GMSK)

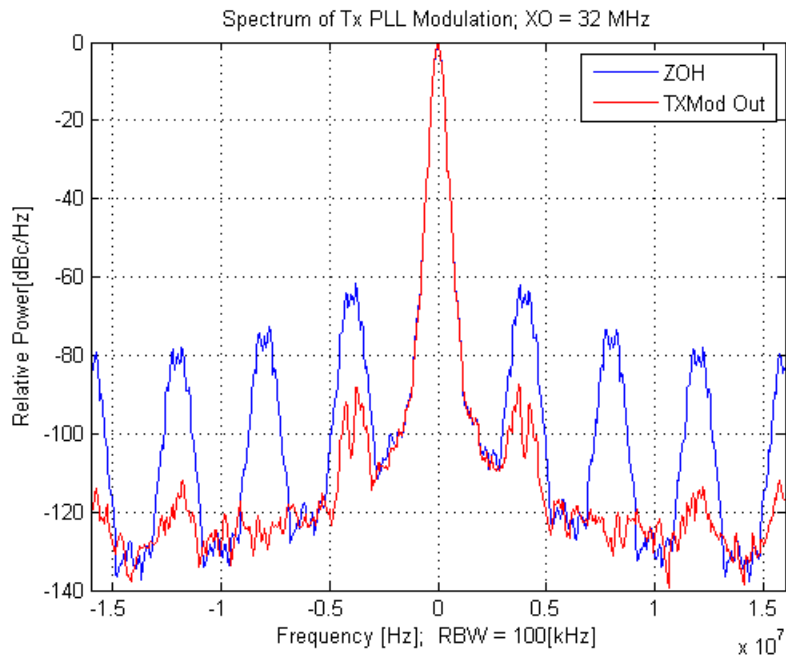

Figure 45-12. Comparison of Transmit Modulation Images at the PLL Output for 500 kbps GMSK

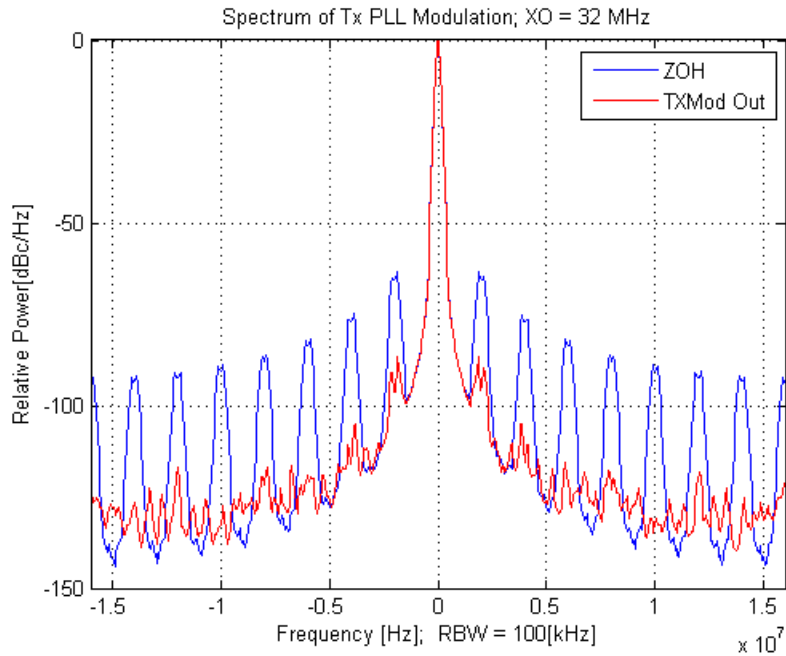

Figure 45-13. Comparison of Transmit Modulation Images at the PLL Output for 250 kbps GMSK

45.4.1.6 Memory Map and Register Definition

The Transmitter Digital memory map and detailed descriptions of all its registers are as follows.

45.4.1.6.1 XCVR_TX_DIG Register Descriptions

45.4.1.6.1.1 XCVR_TX_DIG_ADDR Memory Map

Base address: 4005C200h

| Offset | Register | Width (In bits) | Access | Reset value |
|-----------|---|--------------------|--------|-------------|
| 4005C200h | TX Digital Control (CTRL) | 32 | RW | 00000140h |
| 4005C204h | TX Data Padding (DATA_PADDING) | 32 | RW | 7FFF55AAh |
| 4005C208h | TX GFSK Modulator Control (GFSK_CTRL) | 32 | RW | 03014000h |
| 4005C20Ch | TX GFSK Filter Coefficients 2 (GFSK_COEFF2) | 32 | RW | C0630401h |
| 4005C210h | TX GFSK Filter Coefficients 1 (GFSK_COEFF1) | 32 | RW | BB29960Dh |
| 4005C214h | TX FSK Modulation Levels (FSK_SCALE) | 32 | RW | 08001800h |
| 4005C218h | TX DFT Modulation Pattern (DFT_PATTERN) | 32 | RW | 00000000h |

45.4.1.6.1.2 TX Digital Control (CTRL)

45.4.1.6.1.2.1 Address

| Register | Offset |
|----------|-----------|
| CTRL | 4005C200h |

45.4.1.6.1.2.2 Diagram

| | | | | | | | | | | | | | | | | |
|-------|---------------|--------------|----|-----------|----|-------------|----|----|---------|-------------|----|----|----------------|------|----|----|
| Bits | 31 | 30 | 29 | 28 | 27 | 26 | 25 | 24 | 23 | 22 | 21 | 20 | 19 | 18 | 17 | 16 |
| R | FREQ_WORD_ADJ | | | | | | | | | 0 | | | | TX_C | | |
| W | FREQ_WORD_ADJ | | | | | | | | | | | | | APTU | | |
| Reset | 0 | 0 | 0 | 0 | 0 | 0 | 0 | 0 | 0 | 0 | 0 | 0 | 0 | 0 | 0 | 0 |
| Bits | 15 | 14 | 13 | 12 | 11 | 10 | 9 | 8 | 7 | 6 | 5 | 4 | 3 | 2 | 1 | 0 |
| R | 0 | SOC_TEST_SEL | | TX_DFT_EN | | DFT_CLK_SEL | | | LFSR_EN | LFSR_LENGTH | | | RADIO_DFT_MODE | | | |
| W | | | | | | | | | | | | | | | | |
| Reset | 0 | 0 | 0 | 0 | 0 | 0 | 0 | 1 | 0 | 1 | 0 | 0 | 0 | 0 | 0 | 0 |

45.4.1.6.1.2.3 Fields

| Field | Function |
|------------------------|---|
| 31-22 FREQ_WORD_ADJ | Frequency Word Adjustment This register is a signed 9 bit number that is added to the TX Digital output before it is presented to the PLL as the baseband frequency word. This allows the baseband frequency word to be adjusted, or skewed, by a range of -512 to +511. This frequency adjustment is applied to the final modulation word from any source (GFSK, FSK, DFT) and there is no protection from a math overflow. So the baseband frequency word range of -4096 to 4095 must be considered when adding this frequency word adjustment. |
| 21-17 — | Reserved |
| 16 TX_CAPTURE_POL | Polarity of the Input Data for the Transmitter If this bit is set, the TX data presented to the Transmitter will be inverted before it is processed. |
| 15-14 — | Reserved |
| 13-12 | Radio Clock Selector for SoC RF Clock Tests This register selects the Radio clock source for the SoC Clock Tests Frequency Measurement. |

Table continues on the next page...

FSK Modulator

| Field | Function |
|-----------------------|--|
| SOC_TEST_SELECT | 00b - No Clock Selected 01b - PLL Sigma Delta Clock, divided by 2 10b - Auxiliary PLL Clock, divided by 2 11b - RF Ref Osc clock, divided by 2 |
| 11 TX_DFT_EN | DFT Modulation Enable If the Radio is in a DFT Pattern Register mode, then this bit is used to turn on and off the modulation that is shifted out from the pattern register. |
| 10-8 DFT_CLK_SEL | DFT Clock Selection This register selects the frequency of the DFT clock that is used to shift out the DFT Modulation Pattern in DFT Pattern Register modes, and the same frequency is also used to clock the LFSR and generate the pseudo-random modulation in DFT LFSR modes. 000b - 62.5 kHz 001b - 125 kHz 010b - 250 kHz 011b - 500 kHz 100b - 1 MHz 101b - 2 MHz 110b - 4 MHz 111b - RF OSC Clock |
| 7 LFSR_EN | LFSR Enable If the Radio is in a DFT LFSR mode, then this bit is used to turn on and off the LFSR that is used to generate the modulation. Note that the LFSR is clocked at the DFT Clock frequency. |
| 6-4 LFSR_LENGTH | LFSR Length This register selects the length of the DFT LFSR and the associated LFSR Tap Mask. The Mask is in the form of [MSB...LSB] 000b - LFSR 9, tap mask 100010000 001b - LFSR 10, tap mask 1001000000 010b - LFSR 11, tap mask 11101000000 011b - LFSR 13, tap mask 1101100000000 100b - LFSR 15, tap mask 111010000000000 101b - LFSR 17, tap mask 11110000000000000 110b - Reserved 111b - Reserved |
| 3-0 RADIO_DFT_MODE | Radio DFT Modes This register selects the Radio DFT mode as described below. In addition to setting the Radio DFT mode, the DFT LFSR needs to be configured, and the Radio Protocol needs to be chosen. For LFSR modes the LFSR_EN needs to be set to turn on the LFSR. 0000b - Normal Radio Operation, DFT not engaged. 0001b - Carrier Frequency Only 0010b - Pattern Register GFSK 0011b - LFSR GFSK 0100b - Pattern Register FSK 0101b - LFSR FSK 0110b - Pattern Register O-QPSK 0111b - LFSR O-QPSK 1000b - LFSR 802.15.4 Symbols 1001b - PLL Modulation from RAM |

| Field | Function |
|-------|---|
| | 1010b - PLL Coarse Tune BIST 1011b - PLL Frequency Synthesizer BIST 1100b - High Port DAC BIST 1101b - VCO Frequency Meter 1110b - Reserved 1111b - Reserved |

45.4.1.6.1.3 TX Data Padding (DATA_PADDING)

45.4.1.6.1.3.1 Address

| Register | Offset |
|--------------|-----------|
| DATA_PADDING | 4005C204h |

45.4.1.6.1.3.2 Diagram

| | | | | | | | | | | | | | | | | |
|-------|-----|----|----|----|----|----|----|----|--------------------|----|----|----|--------------------|----|----|----|
| Bits | 31 | 30 | 29 | 28 | 27 | 26 | 25 | 24 | 23 | 22 | 21 | 20 | 19 | 18 | 17 | 16 |
| R | | | | | | | | | DFT_LFSR_OUT | | | | | | | |
| W | LRM | | | | | | | | | | | | | | | |
| Reset | 0 | 1 | 1 | 1 | 1 | 1 | 1 | 1 | 1 | 1 | 1 | 1 | 1 | 1 | 1 | 1 |
| Bits | 15 | 14 | 13 | 12 | 11 | 10 | 9 | 8 | 7 | 6 | 5 | 4 | 3 | 2 | 1 | 0 |
| R | | | | | | | | | | | | | | | | |
| W | | | | | | | | | DATA_PADDING_PAT_1 | | | | DATA_PADDING_PAT_0 | | | |
| Reset | 0 | 1 | 0 | 1 | 0 | 1 | 0 | 1 | 1 | 0 | 1 | 0 | 1 | 0 | 1 | 0 |

45.4.1.6.1.3.3 Fields

| Field | Function |
|----------------------|--|
| 31 | LFSR Reset Mask |
| LRM | When this bit is set the DFT LFSR will not be reset when LFSR_EN is cleared and will instead continue to repeat its sequence as defined by the DFT_LFSR_LEN bits when LFSR_EN is next set. When this bit is cleared the DFT LFSR will reset every time LFSR_EN is cleared. |
| 30-16 | LFSR Output |
| DFT_LFSR_OUT | This register can be read to observe the current value of the DFT LFSR, only bits [14:0] are available. |
| 15-8 | Data Padding Pattern 1 |
| DATA_PADDING_G_PAT_1 | These bits are used for Data Padding when the first bit of the Preamble is 1; the LSB is the first bit shifted out as padding. |

Table continues on the next page...

FSK Modulator

| Field | Function |
|-------------------------------|--|
| 7-0 DATA_PADDIN G_PAT_0 | Data Padding Pattern 0 These bits are used for Data Padding when the first bit of the Preamble is 0; the LSB is the first bit shifted out as padding. |

45.4.1.6.1.4 TX GFSK Modulator Control (GFSK_CTRL)

45.4.1.6.1.4.1 Address

| Register | Offset |
|-----------|-----------|
| GFSK_CTRL | 4005C208h |

45.4.1.6.1.4.2 Diagram

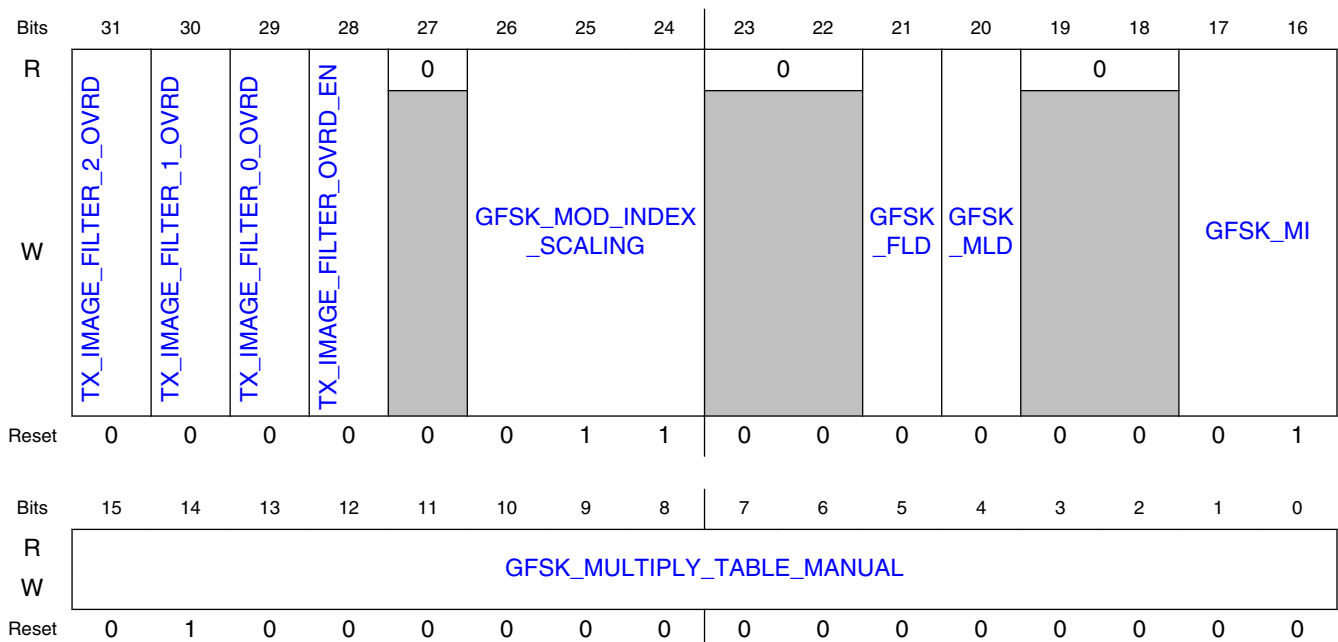

45.4.1.6.1.4.3 Fields

| Field | Function |
|------------------------------|---|
| 31 TX_IMAGE_FILTER_2_OVRD | TX Image Filter 2 Override Control If the TX_IMAGE_FILTER_OVRD_EN bit is set, then this bit turns on and off the Transmit Image Filter 2 |
| 30 | TX Image Filter 1 Override Control |

Table continues on the next page...

| Field | Function |
|------------------------------------|--|
| TX_IMAGE_FILTER_1_OVRD | If the TX_IMAGE_FILTER_OVRD_EN bit is set, then this bit turns on and off the Transmit Image Filter 1 |
| 29 TX_IMAGE_FILTER_0_OVRD | TX Image Filter 0 Override Control If the TX_IMAGE_FILTER_OVRD_EN bit is set, then this bit turns on and off the Transmit Image Filter 0 |
| 28 TX_IMAGE_FILTER_OVRD_EN | TX Image Filter Override Enable This bit enables the TX Image Filter Override Control bits. |
| 27 — | Reserved |
| 26-24 GFSK_MOD_INDEX_SCALING | GFSK Modulation Index Scaling Factor This register selects the amount to scale the Transmitter Modulation Word in GFSK Protocols. Transmit modulation scaling adds the capability to scale the GFSK modulated output up or down by a factor of 1/32, 1/16 or 1/8. This is equivalent to having some additional programmability of the modulation index. 000b - 1 001b - 1 + 1/32 010b - 1 + 1/16 011b - 1 + 1/8 100b - 1 - 1/32 101b - 1 - 1/16 110b - 1 - 1/8 111b - Reserved |
| 23-22 — | Reserved |
| 21 GFSK_FLD | Disable GFSK Filter Lookup Table If this bit is set, the internal GFSK filter coefficients that are normally derived from a lookup table based on the reference clock frequency, are disabled, and the coefficients are instead derived from the GFSK_FILTER_COEFF_MANUAL1 and GFSK_FILTER_COEFF_MANUAL2 registers. |
| 20 GFSK_MLD | Disable GFSK Multiply Lookup Table If this bit is set, the GFSK Multiply Lookup table is disabled and GFSK_MULTIPLY_TABLE_MANUAL is used instead. |
| 19-18 — | Reserved |
| 17-16 GFSK_MI | GFSK Modulation Index This register selects the GFSK Modulation Index which, together with the GFSK Symbol Rate, determines the Peak Modulation frequency. The formula used for the Peak Modulation is { Symbol Rate / (2 x 1/Modulation Index) } 00b - 0.32 01b - 0.50 10b - 0.70 11b - 1.00 |
| 15-0 GFSK_MULTIPLY_TABLE_MANUAL | Manual GFSK Multiply Lookup Table Value The GFSK Modulator Multiplier uses a lookup table to select the multiplicand representing the { Frequency Deviation divided by the Low Port Sigma Delta LSB resolution in Hz } for the Modulation requested based on the Modulation Index, the Symbol Rate, and the Reference Clock Frequency. |

FSK Modulator

| Field | Function |
|-------|---|
| | The lookup table value is overridden by this register if GFSK_MLD is set, and these bits should then contain a number that represents { FDev/SD_LSB integer[11:0] + FDev/SD_LSB fraction[3:0] } |

45.4.1.6.1.5 TX GFSK Filter Coefficients 2 (GFSK_COEFF2)

45.4.1.6.1.5.1 Address

| Register | Offset |
|-------------|-----------|
| GFSK_COEFF2 | 4005C20Ch |

45.4.1.6.1.5.2 Function

The two registers TX_GFSK_COEFF1 and TX_GFSK_COEFF2 form a 64-bit little endian register that is memory mapped internally as shown to override the GFSK Filter Coefficients.

In 64-bit they combine as {TX_GFSK_COEFF2[31:0],TX_GFSK_COEFF1[31:0]}

The resulting 64-bit value is the GFSK Manual Filter Coefficient [63:0]

45.4.1.6.1.5.3 Diagram

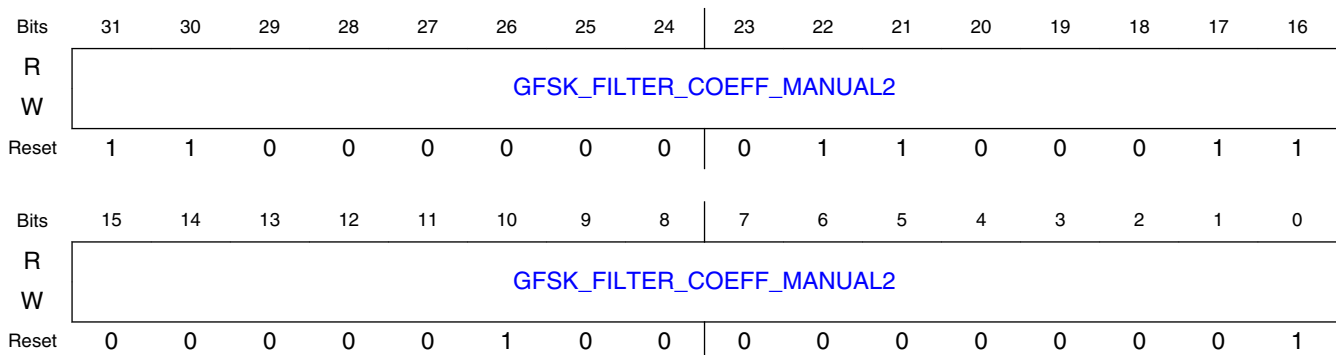

45.4.1.6.1.5.4 Fields

| Field | Function |
|---------------------------|--|
| 31-0 | GFSK Manual Filter Coefficients[63:32] |
| GFSK_FILTER_COEFF_MANUAL2 | If GFSK_FLD is set, the GFSK Filter Coefficients are overridden using the bits as described below, and since the filter is symmetrical each coefficient is used twice. |

| Field | Function | |
|-------|-------------|----------------------------|
| | Bits | Filter Coefficients |
| | [36:32] | Filter coeff 0 and 15 |
| | [45:40] | Filter coeff 1 and 14 |
| | [55:48] | Filter coeff 4 and 11 |
| | [63:56] | Filter coeff 5 and 10 |

45.4.1.6.1.6 TX GFSK Filter Coefficients 1 (GFSK_COEFF1)

45.4.1.6.1.6.1 Address

| Register | Offset |
|-------------|-----------|
| GFSK_COEFF1 | 4005C210h |

45.4.1.6.1.6.2 Function

The two registers TX_GFSK_COEFF1 and TX_GFSK_COEFF2 form a 64-bit little endian register that is memory mapped internally as shown to override the GFSK Filter Coefficients.

In 64-bit they combine as {TX_GFSK_COEFF2[31:0],TX_GFSK_COEFF1[31:0]}

The resulting 64-bit value is the GFSK Manual Filter Coefficient [63:0]

45.4.1.6.1.6.3 Diagram

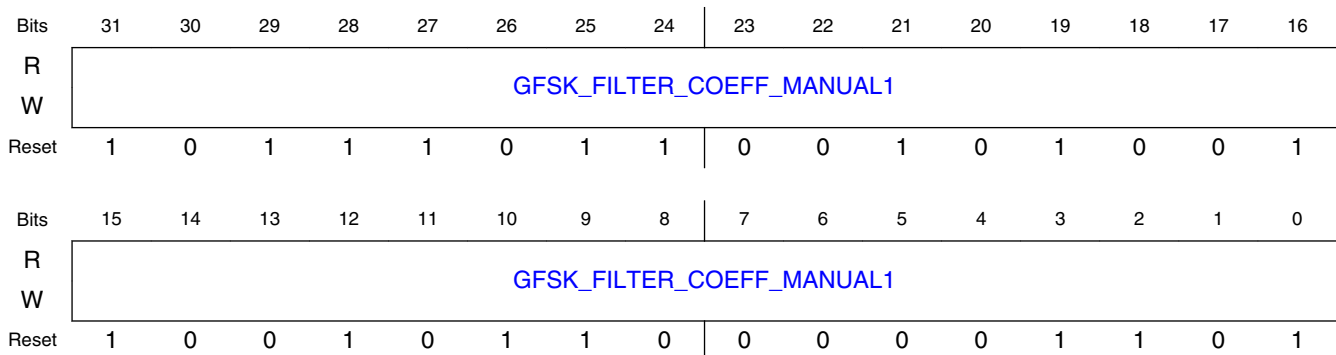

FSK Modulator

45.4.1.6.1.6.4 Fields

| Field | Function | | | | | | | | | | |
|---------------------------------------|--|------|-------------------------|-------|-----------------------|--------|----------------------|---------|-----------------------|---------|----------------------|
| 31-0 GFSK_FILTER_COEFF_MANU AL1 | GFSK Manual Filter Coefficient [31:0] If GFSK_FLD is set, the GFSK Filter Coefficients are overridden using the bits as described below, and since the filter is symmetrical each coefficient is used twice. | | | | | | | | | | |
| | <table border="1"> <thead> <tr> <th>Bits</th> <th>000 Filter Coefficients</th> </tr> </thead> <tbody> <tr> <td>[6:0]</td> <td>Filter coeff 2 and 13</td> </tr> <tr> <td>[15:7]</td> <td>Filter coeff 6 and 9</td> </tr> <tr> <td>[22:16]</td> <td>Filter coeff 3 and 12</td> </tr> <tr> <td>[31:23]</td> <td>Filter coeff 7 and 8</td> </tr> </tbody> </table> | Bits | 000 Filter Coefficients | [6:0] | Filter coeff 2 and 13 | [15:7] | Filter coeff 6 and 9 | [22:16] | Filter coeff 3 and 12 | [31:23] | Filter coeff 7 and 8 |
| Bits | 000 Filter Coefficients | | | | | | | | | | |
| [6:0] | Filter coeff 2 and 13 | | | | | | | | | | |
| [15:7] | Filter coeff 6 and 9 | | | | | | | | | | |
| [22:16] | Filter coeff 3 and 12 | | | | | | | | | | |
| [31:23] | Filter coeff 7 and 8 | | | | | | | | | | |

45.4.1.6.1.7 TX FSK Modulation Levels (FSK_SCALE)

45.4.1.6.1.7.1 Address

| Register | Offset |
|-----------|-----------|
| FSK_SCALE | 4005C214h |

45.4.1.6.1.7.2 Diagram

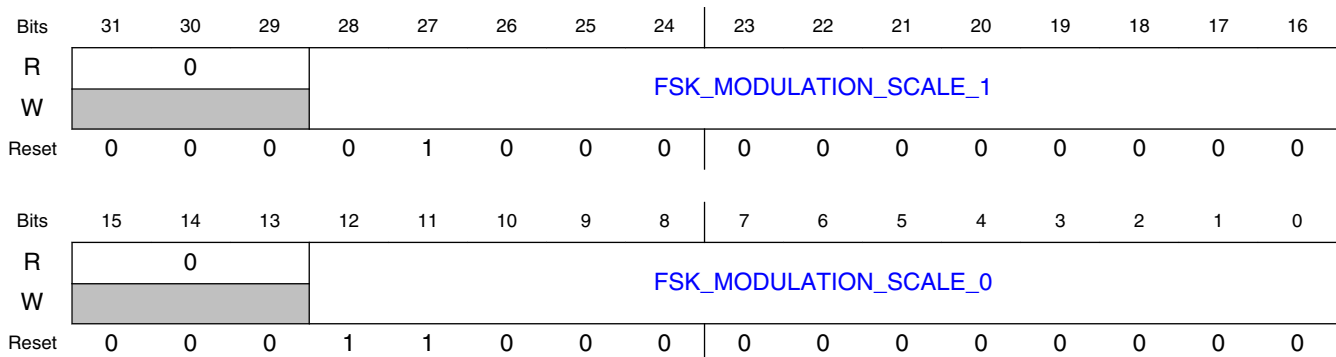

45.4.1.6.1.7.3 Fields

| Field | Function |
|-------|----------|
| 31-29 | Reserved |
| — | |

Table continues on the next page...

| Field | Function |
|---------------------------------|--|
| 28-16 FSK_MODULATION_SCALE_1 | FSK Modulation Scale for a data 1 This register is used to provide the modulation level for a data 1 in 802.15.4 Protocols. The signed 12 bit value that is represented by this register is presented to the PLL as the Baseband Frequency Word. The frequency result for this Modulation Scale will be the value of this register times the PLL Low Port Modulator Frequency Resolution; a typical value for the Frequency Resolution is 244.14 Hz. The range of signed values that this register supports is -4096 to 4095 |
| 15-13 — | Reserved |
| 12-0 FSK_MODULATION_SCALE_0 | FSK Modulation Scale for a data 0 This register is used to provide the modulation level for a data 0 in 802.15.4 Protocols. The signed 12 bit value that is represented by this register is presented to the PLL as the Baseband Frequency Word. The frequency result for this Modulation Scale will be the value of this register times the PLL Low Port Modulator Frequency Resolution; a typical value for the Frequency Resolution is 244.14 Hz. The range of signed values that this register supports is -4096 to 4095 |

45.4.1.6.1.8 TX DFT Modulation Pattern (DFT_PATTERN)

45.4.1.6.1.8.1 Address

| Register | Offset |
|-------------|-----------|
| DFT_PATTERN | 4005C218h |

45.4.1.6.1.8.2 Diagram

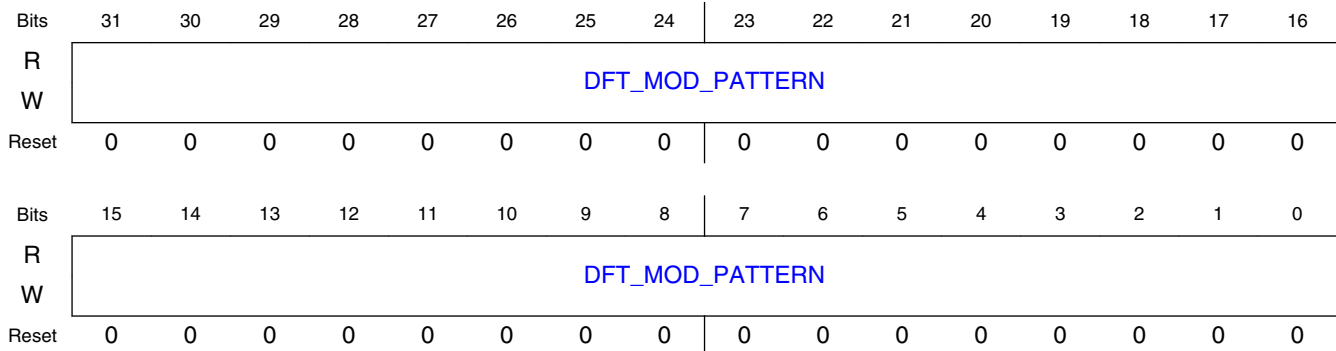

45.4.1.6.1.8.3 Fields

| Field | Function |
|-------|------------------------|
| 31-0 | DFT Modulation Pattern |

| Field | Function |
|-----------------|--|
| DFT_MOD_PATTERN | In TX DFT Pattern Register modes, if TX_DFT_EN is set, the bits in this register will be shifted out as the DFT Modulation Data in a repeating loop starting with bit [0]. |

45.4.2 PLL Frequency Synthesizer

45.4.2.1 About the PLL Frequency Synthesizer

45.4.2.1.1 Introduction

The PLL Frequency Synthesizer is a Digital Module that -

1. Selects the Radio Carrier Frequency
2. Coarse Tunes the VCO and Calibrates the High Port DAC
3. Controls the PLL Loop Divider value to lock the VCO at the Carrier Frequency
4. Applies the Baseband Frequency Word as High Port Modulation (HPM) to the VCO High Port DAC
5. Applies the Baseband Frequency Word as Low Port Modulation (LPM) to the PLL Loop Divider
6. Monitors the PLL lock status and flags unlocked conditions
7. Provides DFT features for evaluating the PLL Frequency Synthesizer during factory validation and testing

45.4.2.1.2 Block diagram

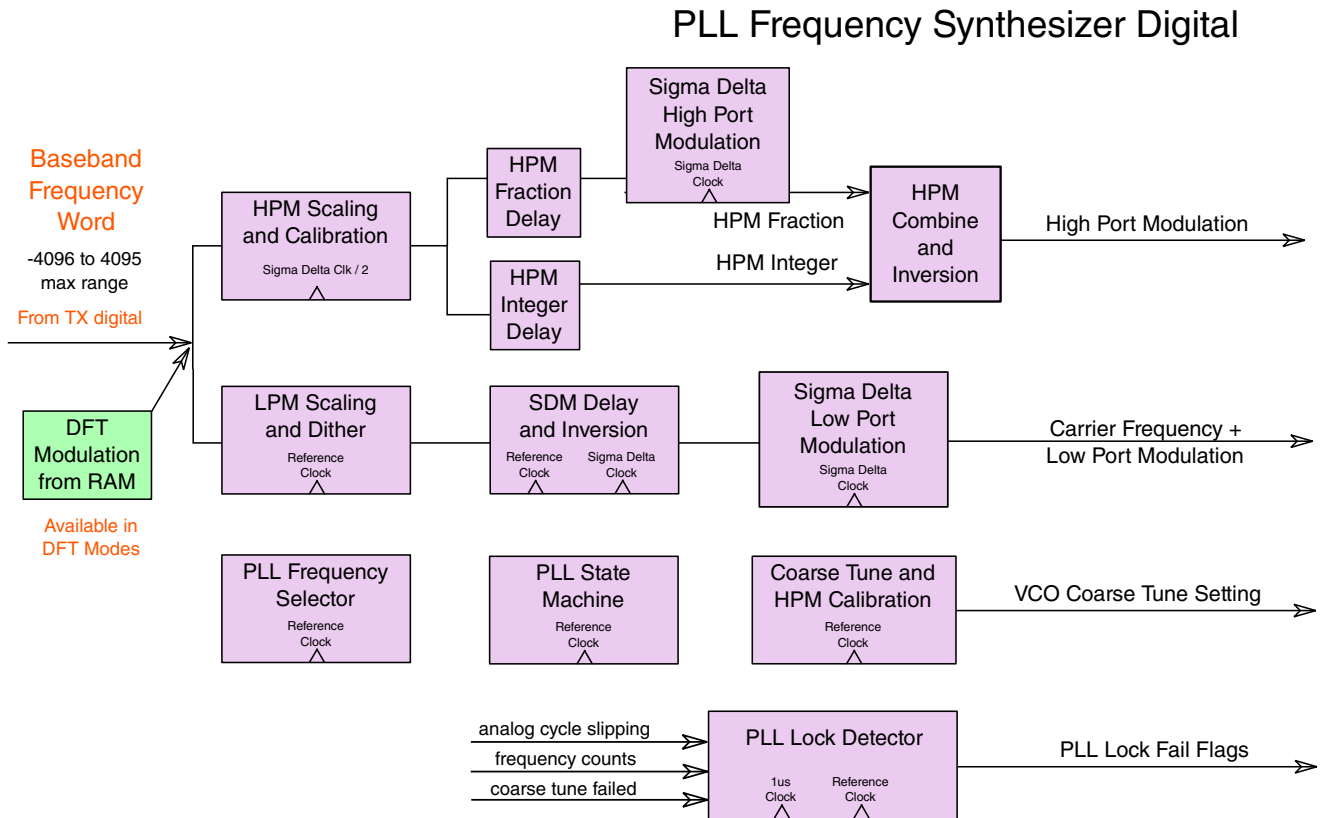

Figure 45-14. PLL Frequency Synthesizer

45.4.2.1.3 Baseband Frequency Word

The Transmitter Digital presents the PLL Frequency Synthesizer with a signed 13-bit Baseband Frequency word to modulate onto the RF Carrier Frequency. The Baseband Frequency Word range is -4096 to 4095, which provides a modulation range of +/- 1000 kHz when using a 32 MHz reference frequency with a PLL Minimum Frequency Step Size of 244.14 Hz.

45.4.2.1.3.1 Manual Frequency Word

The Baseband Frequency word can be overridden by software if the MOD_DISABLE bit is set. In this case the PLL Digital will use the MODULATION_WORD_MANUAL register as the source of the modulation.

Note that due to the speeds at which the High Port and Low Port react to changes in the modulation word, and the speed at which software is able to effect such changes, for all practical purposes this can only support low frequency modulation.

45.4.2.2 Carrier Frequency Tuning

45.4.2.2.1 Radio Frequency Selection

The PLL Digital has hardware support for 128 RF channels in 1 MHz increments spanning the range from 2.360 GHz to 2.487 GHz.

Each supported carrier frequency is derived by Fractional-N Frequency Synthesis using the Low Port Sigma Delta Modulator.

These 128 RF channels are mapped to the various supported RF Protocols through two lookup tables as shown in the figure below.

Radio Frequency Selection

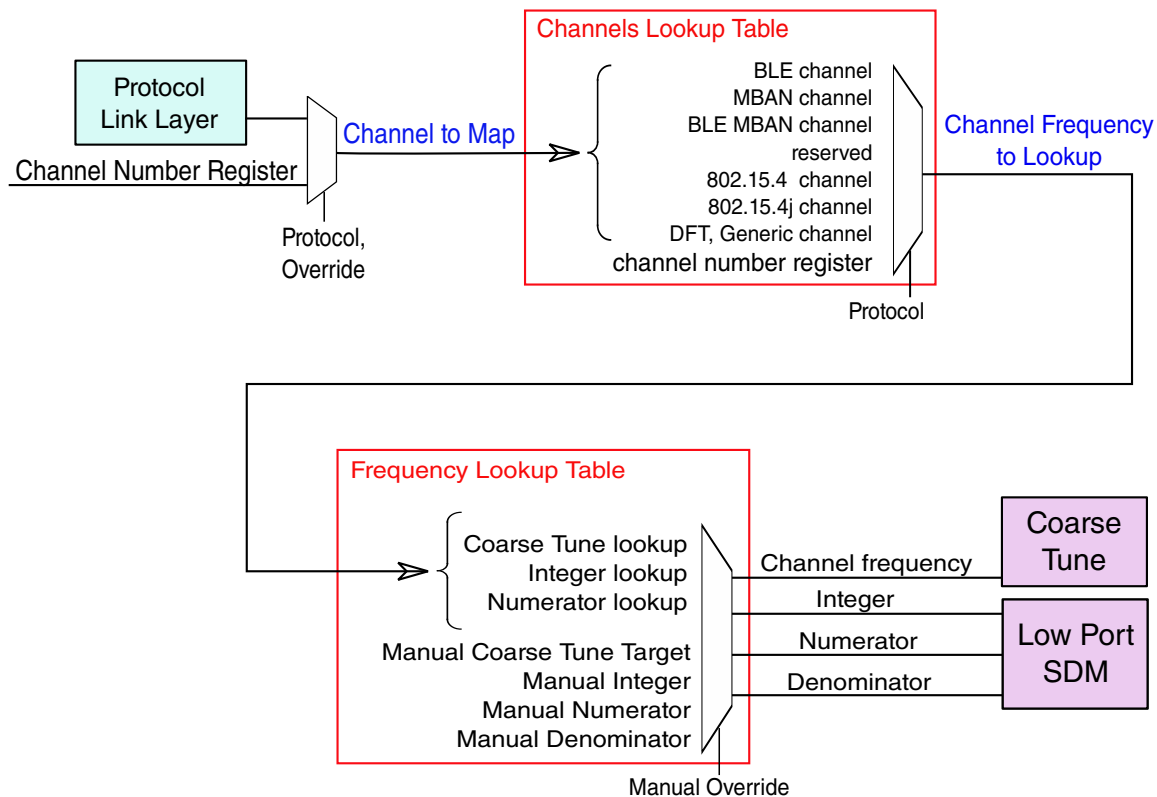

Figure 45-15. Radio Frequency Selection

45.4.2.2.2 RF Channels Supported

The channel frequencies for each protocol are shown in the tables below.

Table 45-8. Radio Protocols (1 to 5) Channel Frequencies

| Radio Protocols Supported, Channel Frequency in MHz | | | | | | | | | | | | | |
|---|-------|------|-------|----------|-------|----------|-------|------|-------|----------|-------|----------------|-------|
| BLE | | MBAN | | BLE/MBAN | | Reserved | | | | 802.15.4 | | 802.15.4j MBAN | |
| 0 | | 1 | | 2 | | 3 | | | | 4 | | 5 | |
| Chan | MHz | Chan | MHz | Chan | MHz | Chan | MHz | Chan | MHz | Chan | MHz | Chan | MHz |
| 0 | 2,402 | 0 | 2,360 | 0 | 2,402 | 0 | 2,400 | 43 | 2,443 | 11 | 2,405 | 0 | 2,363 |
| 1 | 2,404 | 1 | 2,361 | 1 | 2,404 | 1 | 2,401 | 44 | 2,444 | 12 | 2,410 | 1 | 2,368 |
| 2 | 2,406 | 2 | 2,362 | 2 | 2,406 | 2 | 2,402 | 45 | 2,445 | 13 | 2,415 | 2 | 2,373 |
| 3 | 2,408 | 3 | 2,363 | 3 | 2,408 | 3 | 2,403 | 46 | 2,446 | 14 | 2,420 | 3 | 2,378 |
| 4 | 2,410 | 4 | 2,364 | 4 | 2,410 | 4 | 2,404 | 47 | 2,447 | 15 | 2,425 | 4 | 2,383 |
| 5 | 2,412 | 5 | 2,365 | 5 | 2,412 | 5 | 2,405 | 48 | 2,448 | 16 | 2,430 | 5 | 2,388 |
| 6 | 2,414 | 6 | 2,366 | 6 | 2,414 | 6 | 2,406 | 49 | 2,449 | 17 | 2,435 | 6 | 2,393 |
| 7 | 2,416 | 7 | 2,367 | 7 | 2,416 | 7 | 2,407 | 50 | 2,450 | 18 | 2,440 | 7 | 2,397 |
| 8 | 2,418 | 8 | 2,368 | 8 | 2,418 | 8 | 2,408 | 51 | 2,451 | 19 | 2,445 | 8 | 2,399 |
| 9 | 2,420 | 9 | 2,369 | 9 | 2,420 | 9 | 2,409 | 52 | 2,452 | 20 | 2,450 | 9 | 2,401 |
| 10 | 2,422 | 10 | 2,370 | 10 | 2,422 | 10 | 2,410 | 53 | 2,453 | 21 | 2,455 | 10 | 2,403 |
| 11 | 2,424 | 11 | 2,371 | 11 | 2,424 | 11 | 2,411 | 54 | 2,454 | 22 | 2,460 | 11 | 2,405 |
| 12 | 2,426 | 12 | 2,372 | 12 | 2,426 | 12 | 2,412 | 55 | 2,455 | 23 | 2,465 | 12 | 2,407 |
| 13 | 2,428 | 13 | 2,373 | 13 | 2,428 | 13 | 2,413 | 56 | 2,456 | 24 | 2,470 | 13 | 2,409 |
| 14 | 2,430 | 14 | 2,374 | 14 | 2,430 | 14 | 2,414 | 57 | 2,457 | 25 | 2,475 | 14 | 2,411 |
| 15 | 2,432 | 15 | 2,375 | 15 | 2,432 | 15 | 2,415 | 58 | 2,458 | 26 | 2,480 | | |
| 16 | 2,434 | 16 | 2,376 | 16 | 2,434 | 16 | 2,416 | 59 | 2,459 | | | | |
| 17 | 2,436 | 17 | 2,377 | 17 | 2,436 | 17 | 2,417 | 60 | 2,460 | | | | |
| 18 | 2,438 | 18 | 2,378 | 18 | 2,438 | 18 | 2,418 | 61 | 2,461 | | | | |
| 19 | 2,440 | 19 | 2,379 | 19 | 2,440 | 19 | 2,419 | 62 | 2,462 | | | | |
| 20 | 2,442 | 20 | 2,380 | 20 | 2,442 | 20 | 2,420 | 63 | 2,463 | | | | |
| 21 | 2,444 | 21 | 2,381 | 21 | 2,444 | 21 | 2,421 | 64 | 2,464 | | | | |
| 22 | 2,446 | 22 | 2,382 | 22 | 2,446 | 22 | 2,422 | 65 | 2,465 | | | | |
| 23 | 2,448 | 23 | 2,383 | 23 | 2,448 | 23 | 2,423 | 66 | 2,466 | | | | |
| 24 | 2,450 | 24 | 2,384 | 24 | 2,450 | 24 | 2,424 | 67 | 2,467 | | | | |
| 25 | 2,452 | 25 | 2,385 | 25 | 2,452 | 25 | 2,425 | 68 | 2,468 | | | | |
| 26 | 2,454 | 26 | 2,386 | 26 | 2,454 | 26 | 2,426 | 69 | 2,469 | | | | |
| 27 | 2,456 | 27 | 2,387 | 27 | 2,456 | 27 | 2,427 | 70 | 2,470 | | | | |
| 28 | 2,458 | 28 | 2,388 | 28 | 2,458 | 28 | 2,428 | 71 | 2,471 | | | | |
| 29 | 2,460 | 29 | 2,389 | 29 | 2,460 | 29 | 2,429 | 72 | 2,472 | | | | |
| 30 | 2,462 | 30 | 2,390 | 30 | 2,390 | 30 | 2,430 | 73 | 2,473 | | | | |
| 31 | 2,464 | 31 | 2,391 | 31 | 2,391 | 31 | 2,431 | 74 | 2,474 | | | | |
| 32 | 2,466 | 32 | 2,392 | 32 | 2,392 | 32 | 2,432 | 75 | 2,475 | | | | |
| 33 | 2,468 | 33 | 2,393 | 33 | 2,393 | 33 | 2,433 | 76 | 2,476 | | | | |

Table continues on the next page...

Table 45-8. Radio Protocols (1 to 5) Channel Frequencies (continued)

| | | | | | | | | | | | | | |
|----|-------|----|-------|-----|-------|----|-------|----|-------|--|--|--|--|
| 34 | 2,470 | 34 | 2,394 | 34 | 2,394 | 34 | 2,434 | 77 | 2,477 | | | | |
| 35 | 2,472 | 35 | 2,395 | 35 | 2,395 | 35 | 2,435 | 78 | 2,478 | | | | |
| 36 | 2,474 | 36 | 2,396 | 36 | 2,396 | 36 | 2,436 | 79 | 2,479 | | | | |
| 37 | 2,476 | 37 | 2,397 | 37 | 2,397 | 37 | 2,437 | 80 | 2,480 | | | | |
| 38 | 2,478 | 38 | 2,398 | 38 | 2,398 | 38 | 2,438 | 81 | 2,481 | | | | |
| 39 | 2,480 | 39 | 2,399 | 39* | 2,480 | 39 | 2,439 | 82 | 2,482 | | | | |
| | | | | | | 40 | 2,440 | 83 | 2,483 | | | | |
| | | | | | | 41 | 2,441 | | | | | | |
| | | | | | | 42 | 2,442 | | | | | | |

* The BLE MBAN Channel Remap bit (BMR) controls the frequency mapping for channel 39 in BLE/MBAN, 2480 MHz is the default, but this channel can be remapped to 2399 MHz by setting BMR to a 1.

Table 45-9. Radio Protocols (6 to 9) Channel Frequencies

| Radio Protocols Supported, Channel Frequency in MHz | | | | | |
|---|-------|---------|-------|---------|-------|
| DFT, Generic | | | | | |
| 6,7,8,9 | | | | | |
| Channel | MHz | Channel | MHz | Channel | MHz |
| 0 | 2,360 | 43 | 2,403 | 86 | 2,446 |
| 1 | 2,361 | 44 | 2,404 | 87 | 2,447 |
| 2 | 2,362 | 45 | 2,405 | 88 | 2,448 |
| 3 | 2,363 | 46 | 2,406 | 89 | 2,449 |
| 4 | 2,364 | 47 | 2,407 | 90 | 2,450 |
| 5 | 2,365 | 48 | 2,408 | 91 | 2,451 |
| 6 | 2,366 | 49 | 2,409 | 92 | 2,452 |
| 7 | 2,367 | 50 | 2,410 | 93 | 2,453 |
| 8 | 2,368 | 51 | 2,411 | 94 | 2,454 |
| 9 | 2,369 | 52 | 2,412 | 95 | 2,455 |
| 10 | 2,370 | 53 | 2,413 | 96 | 2,456 |
| 11 | 2,371 | 54 | 2,414 | 97 | 2,457 |
| 12 | 2,372 | 55 | 2,415 | 98 | 2,458 |
| 13 | 2,373 | 56 | 2,416 | 99 | 2,459 |
| 14 | 2,374 | 57 | 2,417 | 100 | 2,460 |
| 15 | 2,375 | 58 | 2,418 | 101 | 2,461 |
| 16 | 2,376 | 59 | 2,419 | 102 | 2,462 |
| 17 | 2,377 | 60 | 2,420 | 103 | 2,463 |
| 18 | 2,378 | 61 | 2,421 | 104 | 2,464 |
| 19 | 2,379 | 62 | 2,422 | 105 | 2,465 |
| 20 | 2,380 | 63 | 2,423 | 106 | 2,466 |

Table continues on the next page...

Table 45-9. Radio Protocols (6 to 9) Channel Frequencies (continued)

| | | | | | |
|----|-------|----|-------|-----|-------|
| 21 | 2,381 | 64 | 2,424 | 107 | 2,467 |
| 22 | 2,382 | 65 | 2,425 | 108 | 2,468 |
| 23 | 2,383 | 66 | 2,426 | 109 | 2,469 |
| 24 | 2,384 | 67 | 2,427 | 110 | 2,470 |
| 25 | 2,385 | 68 | 2,428 | 111 | 2,471 |
| 26 | 2,386 | 69 | 2,429 | 112 | 2,472 |
| 27 | 2,387 | 70 | 2,430 | 113 | 2,473 |
| 28 | 2,388 | 71 | 2,431 | 114 | 2,474 |
| 29 | 2,389 | 72 | 2,432 | 115 | 2,475 |
| 30 | 2,390 | 73 | 2,433 | 116 | 2,476 |
| 31 | 2,391 | 74 | 2,434 | 117 | 2,477 |
| 32 | 2,392 | 75 | 2,435 | 118 | 2,478 |
| 33 | 2,393 | 76 | 2,436 | 119 | 2,479 |
| 34 | 2,394 | 77 | 2,437 | 120 | 2,480 |
| 35 | 2,395 | 78 | 2,438 | 121 | 2,481 |
| 36 | 2,396 | 79 | 2,439 | 122 | 2,482 |
| 37 | 2,397 | 80 | 2,440 | 123 | 2,483 |
| 38 | 2,398 | 81 | 2,441 | 124 | 2,484 |
| 39 | 2,399 | 82 | 2,442 | 125 | 2,485 |
| 40 | 2,400 | 83 | 2,443 | 126 | 2,486 |
| 41 | 2,401 | 84 | 2,444 | 127 | 2,487 |
| 42 | 2,402 | 85 | 2,445 | | |

45.4.2.2.3 Channel Selector

During typical Radio usage, the channel selection is done automatically by the Link Layer.

Channel selection can be overridden using the PLL_CHAN_MAP register bits BOC (BLE protocols 0 and 2) and ZOC (802.15.4 protocols 4 and 5). If these are set then the CHANNEL_NUM register selects the Radio Channel Number instead of the Link Layer.

45.4.2.2.4 Manual Carrier Frequency

The internal frequency mapping can be bypassed and software can directly control the Low Port Sigma Delta inputs to select any channel frequency in the VCO's range (in increments of the Low Port Minimum Frequency Step Size).

The Radio Channel Frequency override is manually selected by setting the SDM_MAP_DISABLE bit along with the LPM_INTG, LPM_NUM, and LPM_DENOM register values.

Any modulation from the TX Digital will be added to this manual frequency selection.

The Manual carrier frequency selected can be calculated using the formula below:

$$\text{Radio Carrier Frequency} = ((\text{Reference Clock Frequency} \times 2) \times (\text{LPM_INTG} + (\text{LPM_NUM} / \text{LPM_DENOM})))$$

WARNING : The fraction (LPM_NUM / LPM_DENOM) must be in the range of -0.55 to +0.55 for valid Sigma Delta Modulator operation.

45.4.2.3 VCO Calibration

45.4.2.3.1 Coarse Tune

The VCO Coarse Tune is carried out by a Successive Approximation Register method that computes the best coarse tune setting for the VCO in successive steps from MSB to LSB.

This SAR method uses a Frequency Meter count value that is successively compared to expected counts to determine the best coarse tune setting for the VCO.

The coarse tune setting can be overridden for test and validation purposes, and the individual frequency counts used at each successive step for the coarse tune setting are available for viewing in DTEST mode and also as register values in the PLL register space.

45.4.2.3.2 High Port DAC Calibration

The objective of the HPM DAC Calibration is to determine the DAC Step Size and estimate the ratio of this DAC unit step to the Low Port Minimum Frequency Step Size.

Once the step size of the High Port DAC is known, a scaling factor is applied to correctly map the baseband frequency word to the High Port modulation.

The length of the calibration time is set using the HPM_CAL_TIME register and the size of the DAC array used is selected using the HPM_CAL_ARRAY_SIZE register.

The register HPM_COUNT_ADJUST[3:0] provides a (-8/+7) range of adjustment to the HPM Calibration Count Difference for the HPM Calibration lookup table to allow for any count error bias that may be present. This adjusted Count Difference is used with a Lookup Table to choose the HPM Calibration Factor

45.4.2.3.2.1 HPM CAL Factor

The HPM_CAL_FACTOR register shows the value that is currently being used by High Port Modulation Multiplier. This value is from the most recent High Port calibration unless it is being overridden using the HP_CAL_DISABLE and HPM_CAL_FACTOR_MANUAL registers.

45.4.2.4 High Port Modulation

The High Port Modulator multiplies the HPM Calibration Factor and the PLL Baseband Frequency Word to get the High Port Modulation Word.

The High Port Modulation Word is represented by both an Integer and a Fractional portion. The Fraction is processed by the High Port Sigma Delta Modulator and the result is combined with the Integer and used to control the VCO High Port DAC.

45.4.2.4.1 High Port DAC

The High Port Digital to Analog Converter is designed to take the High Port Modulation Word and convert it to a control voltage that is applied as modulation to the VCO High Port.

45.4.2.4.1.1 HPM DAC Settings

The HPM DAC settings during calibration and normal operation are shown in the table below.

Warning : TX operation with On-Air modulation ranges greater than +/- 250 kHz (+/- 500 kHz at the VCO) require that the VCO Kvm be adjusted using the SY_VCO_KVM[2:0] register.

Table 45-10. Nominal HPM DAC parameters in various modes

| Radio TX Mode | DAC max swing (mV) | DAC output common mode (mV) | DAC swing during operation | Vcm (mV) / HPM_VC M | OPAMP gain setting (R2/R1) / HPM_FD B_RES | Common mode at varactor (mV) | Swing at Varactor input (mV) | Kvm (MHz/Kv) | Deviation at VCO (KHz) ¹ | |
|----------------------|--------------------|-----------------------------|----------------------------|---------------------|---|------------------------------|------------------------------|--------------|-------------------------------------|---------|
| 802.15.4/ 2000kHz | HPM calibration | +/-82 | 82 | +/-82 | 288 / 3'b001 | 2/ 2'b01 | 700 | +/-164 | 20 | +/-3280 |
| | TX operation | +/-82 | 82 | +/-51.2 | 391 / 3'b000 | 1/ 2'b00 | 700 | +/-51.2 | 20 | +/-1024 |
| BLE/ 1000kHz | HPM calibration | +/-82 | 82 | +/-82 | 288 / 3'b001 | 2 / 2'b01 | 700 | +/-164 | 10 | +/-1640 |

Table continues on the next page...

Table 45-10. Nominal HPM DAC parameters in various modes (continued)

| | | | | | | | | | | |
|--------|-----------------|-------|----|---------|--------------|----------|-----|--------|----|---------|
| | TX operation | +/-82 | 82 | +/-51.2 | 391 / 3'b000 | 1/ 2'b00 | 700 | +51.2 | 10 | +/-512 |
| 500kHz | HPM calibration | +/-82 | 82 | +/-82 | 288 / 3'b001 | 2/ 2'b01 | 700 | +/-164 | 10 | +/-1640 |
| | TX operation | +/-82 | 82 | +/-25.6 | 391 / 3'b000 | 1/ 2'b00 | 700 | +25.6 | 10 | +/-256 |
| 250kHz | HPM calibration | +/-82 | 82 | +/-82 | 288 / 3'b001 | 2/ 2'b01 | 700 | +/-164 | 10 | +/-1640 |
| | TX operation | +/-82 | 82 | +/-12.8 | 391 / 3'b000 | 1/ 2'b00 | 700 | +12.8 | 10 | +/-128 |

1. On-Air modulation frequency is a divide by 2 of the VCO frequency.

45.4.2.4.1.2 HPM DAC Bump

The HPM DAC Calibration is normally done at 2X the On-Air Modulation Range, this is accomplished by writing the PLL HPM Analog Bump Control (PLL_HPM_BUMP) register bits:

- HPM_VCM_CAL, value applied during HPM DAC Calibration
- HPM_FDB_RES_CAL, value applied during HPM DAC Calibration
- HPM_VCM_TX, value applied during Radio Transmissions
- HPM_FDB_RES_TX, value applied during Radio Transmissions

If the registers are written in such a way that the DAC range is not doubled, then the HPM_CAL_NOT_BUMPED bit must be set to change the math in the HPM Calibration.

45.4.2.4.1.3 HPM DAC 1 MHz Range

TX operation with On-Air modulation ranges greater than +/- 250 kHz (+/- 500 kHz at the VCO) require that the VCO Kvm be adjusted using the SY_VCO_KVM[2:0] register.

This VCO Kvm setting should be made prior to HPM DAC calibration.

45.4.2.4.2 High Port Sigma Delta

The High Port fractional modulation is implemented using a 2nd-order MASH Sigma Delta Modulator (SDM), which converts the 6-bit fractional portion of the high port modulation word to a 3-state thermometric code $\{-1,0,+1\}$. The resulting code is then added to the integer portion of the high port modulation word and the final result is applied to the HPM DAC.

45.4.2.4.2.1 HPM SDM Dither

In addition to the nominal SDM functionality, the HPM SDM design includes a zero-mean dithering to mitigate idle tones that can occur when modulating a string of ones or zeros.

The Dither is implemented using a Linear-Feedback Shift Register (LFSR) which provides a 1-bit pseudo-randomization that adds or subtracts 1-bit to the 6-bit fractional portion before it is processed by the Sigma Delta Modulator.

The length of the LFSR can be selected using the HPM_LFSR_SIZE register, and the scale can be changed using the HPM_DTH_SCL bit. The Dither can also be disabled by clearing the HPM_DTH_EN bit.

45.4.2.4.3 High Port Delay, Disable, Invert

The HPM Integer and Fraction portions each have an array of programmable delays available to allow the HPM modulations to be matched to each other and to the LPM modulation and the delay through the PLL Loop Divider and onto the VCO feedback loop.

The HPM delay steps are in increments of the PLL Sigma Delta Clock divided by 2, and the LPM SDM delay steps are in increments of the PLL Sigma Delta Clock. All three delay step settings are in the range of {0 to 15}.

There are several inversion bits that can be used if needed:

- HPM_CAL_INVERT, Invert the High Port Modulator during Calibration
- HPM_MOD_IN_INVERT, Invert the input word to the High Port Modulator
- HPM_INTEGER_INVERT, Invert the High Port Modulation Integer portion
- HPM_SDM_OUT_INVERT, Invert the HPM SDM Fractional Output

High Port Modulation can be disabled by setting the HPM_MOD_DISABLE bit, in this case the HPM_MOD_MANUAL register value is applied to the VCO High Port.

45.4.2.5 Low Port Modulation

The Low Port Modulator uses a 3rd order Sigma-Delta to produce a fractional division (Fractional-N Frequency Synthesis) to control the PLL Loop Divider and tune the VCO to the Radio Carrier Frequency.

The Low Port Baseband Frequency Word is added as modulation to the Sigma-Delta input.

45.4.2.5.1 Low Port Resolution

The table below shows the PLL Minimum Frequency Step Sizes for Modulation and Carrier Frequency tuning.

Note that the minimum step size for carrier frequency tuning is a divide by 512 of the modulation step sizes.

Table 45-11. PLL Minimum Frequency Step Size

| Ref Clk Freq (MHz) | 32 | 26 |
|---|--------|--------|
| PLL Minimum Modulation Step (Hz) | 244.14 | 198.36 |
| PLL Minimum Carrier Frequency Step (Hz) | 0.4768 | 0.3874 |

45.4.2.5.2 Low Port Sigma-Delta

The Integer, Numerator, and Denominator are presented at the input to the Sigma-Delta Modulator.

A 3-level quantized Sigma-Delta output signal $\{-1, 0, +1\}$ is generated and combined with the Integer divide value to produce the Modulus Divide Ratio for the PLL Loop Divider. The resulting RF Frequency can be calculated using the formula below:

$$\text{RF Frequency} = ((\text{Reference Clock Frequency} \times 2) \times (\text{LPM_INTG} + (\text{LPM_NUM} / \text{LPM_DENOM})))$$

WARNING : The fraction (LPM_NUM / LPM_DENOM) must be in the range of -0.55 to +0.55 for valid Sigma Delta Modulator operation.

45.4.2.5.2.1 LPM SDM Dither

While in Transmit mode the input to the SDM is naturally dithered by the Low Port modulation, which keeps the SDM from generating a pseudo-periodic output. However, in Receive mode, the SDM can potentially generate idle tones (dominant frequency modes at its output) when the input to the SDM is a constant. And in either Transmit or Receive mode the LPM SDM can generate idle tones if the Fraction is near zero.

To mitigate these impairments, the Numerator input to the SDM is dithered whenever the Numerator is in the near zero range $\{-64 \text{ to } 63\}$, or whenever the Radio is in Receive Mode.

This dither operation can also be overridden using the LPM_D_OVRD and LPM_D_CTRL bits.

45.4.2.5.3 Low Port Delay, Disable, Invert

The Low Port Modulator has an array of programmable delays available to allow the HPM modulation to be matched to the LPM modulation and the delay through the PLL Loop Divider and onto the VCO feedback loop.

The Low Port Modulation can be delayed at the PLL Loop Divider by delaying the input to the LPM SDM (LPM_SDM_DELAY).

There is an option to invert the Numerator (LPM_SDM_INV) before it is applied to the SDM in order to invert the sigma-delta modulation to the PLL.

The Low Port Modulation of the Loop Divider can be disabled by setting the LPM_DISABLE bit. When the modulation is disabled the LPM SDM will continue to tune the VCO to the Radio Carrier Frequency.

45.4.2.6 Lock Detector

The PLL Lock Detector has three methods to measure the stability of the PLL and check that it is tuned to the selected Radio Frequency.

The real-time results of the PLL Lock Detect module can be read as register bits, and flags are set and can be cleared to provide software long-term access to any PLL unlock events.

The TSM can be configured to choose any or all of the PLL Lock Detect module methods to generate an Abort and avoid violating any FCC On-Air or other radio requirements. This abort option is also a power saving feature and avoids continuing a radio operation that will be unsuccessful.

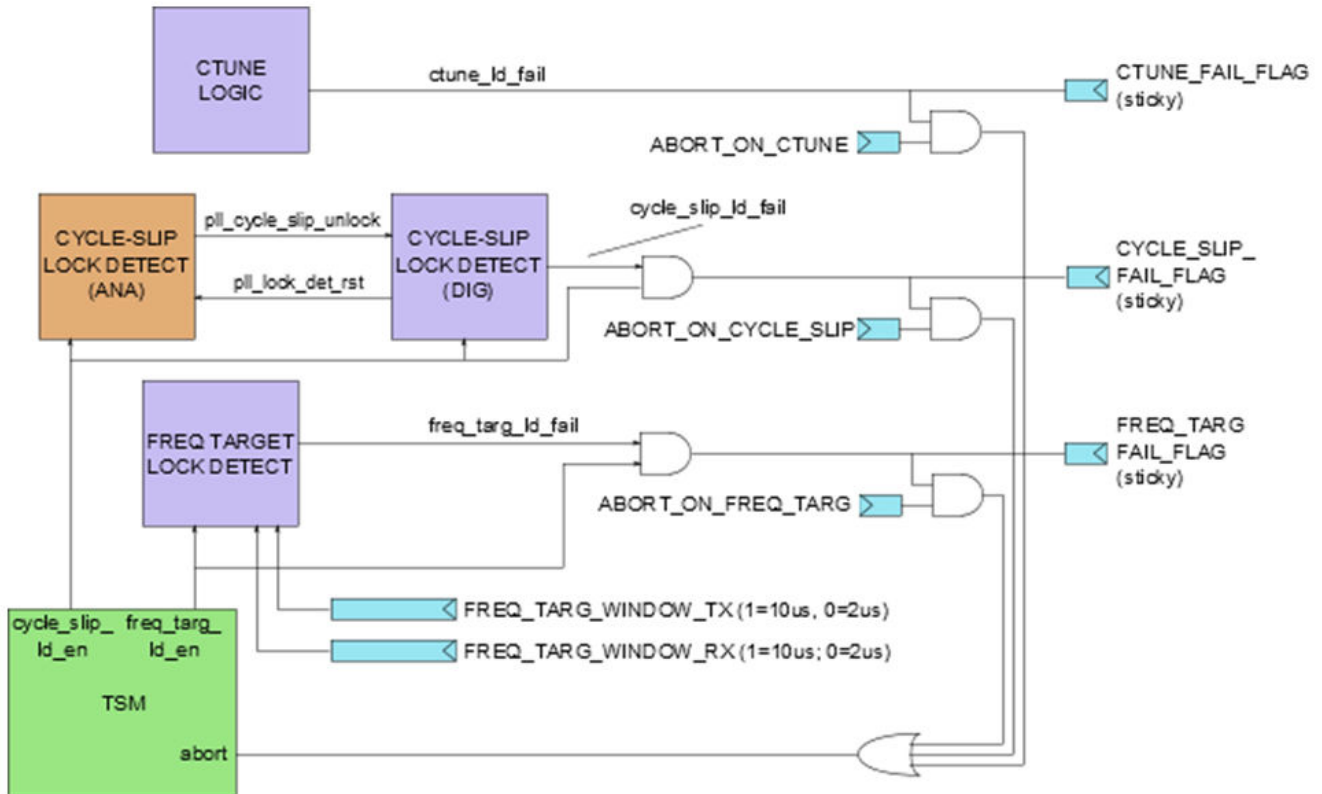

Figure 45-16. PLL Lock Detect Block Diagram

45.4.2.6.1 Coarse Tune Fail

During every Radio start-up sequence the PLL does a Coarse Tune Calibration to select a VCO setting that will allow the PLL to correctly tune and lock the VCO when the PLL/VCO loop is closed.

During the coarse tune calibration a count is maintained that indicates how close the coarse tune is to the targeted Radio Frequency, if this count is outside of the threshold selected by the Coarse Tune Lock Detect Fail Level register (`CTUNE_LDF_LEV`), then the Coarse Tune Failure Flag bit (`CTFF`) will be set and it can be used to abort the TSM sequence.

The `CTFF` bit is cleared by writing a 1 to it.

The `CT_FAIL` bit always shows the real time status of the latest Coarse Tune Calibration. If the absolute count difference was out of the range selected by `CTUNE_LDF_LEV`, then this bit will be set.

45.4.2.6.2 Fine Tune Fail

At the end of every Radio start-up sequence the PLL turns on the PLL Frequency Meter for a time that is requested by the Frequency Target Window time select register bits, separately selected for RX (FTW_RX) and TX (FTW_TX).

These bits select either a 4us or an 8us count period and if the frequency counter is outside of the threshold selected by the Frequency Target Fail Threshold registers, FTF_RX_THRSH and FTF_TX_THRSH, then the Frequency Target Fail Flag bit (FTFF) will be set and it can be used to abort the TSM sequence.

The FTFF bit is cleared by writing a 1 to it

The FT_FAIL bit always shows the real time status of the latest Fine Tune Frequency Measurement. If the absolute count difference was out of the range selected by Frequency Target Fail Threshold registers, then this bit will be set.

45.4.2.6.3 Cycle Slip Fail

During any radio sequence, the PLL can turn on an analog cycle slip detection circuit that measures the phase difference between the VCO and the reference clock. If the phase is not properly aligned the circuit will send a signal to the PLL Lock Detect digital circuit.

The PLL Lock Detect digital circuit evaluates the number and timing of the analog cycle slip events and can generate a Cycle Slip Fail Flag (CSFF).

There is a programmable state machine that controls the monitoring of Cycle Slip Events as shown in the figure below. The CS_FAIL bit always shows the real time status of the cycle slip state machine.

Cycle Slip Lock Detector Digital

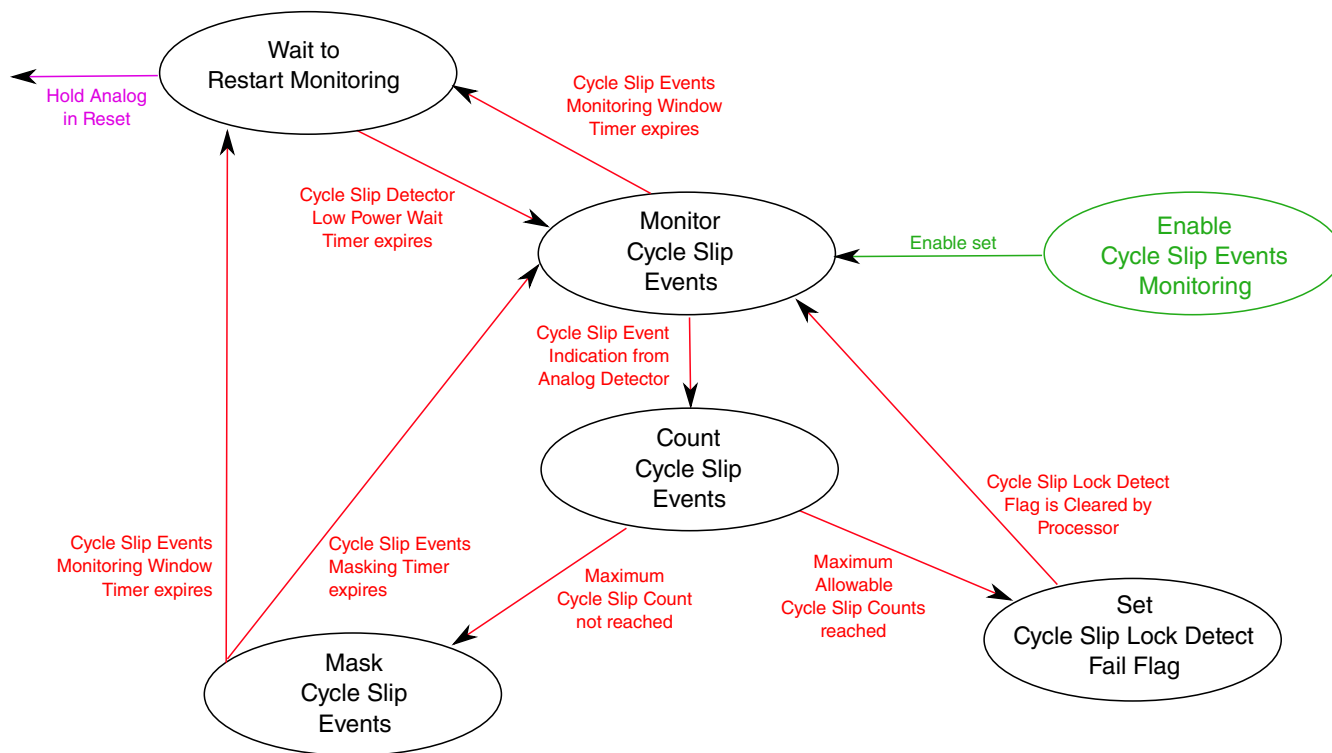

Figure 45-17. PLL Lock Detect State Machine

The following table below shows an example calculation of the time needed for the Cycle Slip Lock Detector to fail as a function of the number of cycle slip events and the VCO frequency error.

| Crystal frequency | 32 | MHz | | | | | | | |
|-----------------------|------------------------------|---------------------------------|----------------------|-----------------------------|-----------------------------|-----------------------------|-----------------------------|------------------------------|------------------------------|
| Reference Time Period | 31.25 | ns | | | | | | | |
| | | | | 3 | 4 | 5 | 8 | 10 | 15 |
| Frequency Error (kHz) | Loop Divider Time Period(ns) | Num cycles in 32MHz Time Period | Cycle-Slip Time (us) | Time for 3 cycle-slips (us) | Time for 4 cycle-slips (us) | Time for 5 cycle-slips (us) | Time for 8 cycle-slips (us) | Time for 10 cycle-slips (us) | Time for 15 cycle-slips (us) |
| -5000 | 37.04 | 5.400 | 0.169 | 0.506 | 1.519 | 4.556 | 13.669 | 41.006 | 123.019 |
| -2000 | 33.33 | 15.000 | 0.469 | 1.406 | 4.219 | 12.656 | 37.969 | 113.906 | 341.719 |
| -1000 | 32.26 | 31.000 | 0.969 | 2.906 | 8.719 | 26.156 | 78.469 | 235.406 | 706.219 |
| -500 | 31.75 | 63.000 | 1.969 | 5.906 | 17.719 | 53.156 | 159.469 | 478.406 | 1435.219 |
| -200 | 31.45 | 159.000 | 4.969 | 14.906 | 44.719 | 134.156 | 402.469 | 1207.406 | 3622.219 |
| 150 | 31.10 | 214.333 | 6.698 | 20.094 | 60.281 | 180.844 | 542.531 | 1627.594 | 4882.781 |
| -100 | 31.35 | 319.000 | 9.969 | 29.906 | 89.719 | 269.156 | 807.469 | 2422.406 | 7267.219 |
| 0 | 31.25 | | | | | | | | |
| 100 | 31.15 | 321.000 | 10.031 | 30.094 | 90.281 | 270.844 | 812.531 | 2437.594 | 7312.781 |
| 150 | 31.10 | 214.333 | 6.698 | 20.094 | 60.281 | 180.844 | 542.531 | 1627.594 | 4882.781 |
| 200 | 31.06 | 161.000 | 5.031 | 15.094 | 45.281 | 135.844 | 407.531 | 1222.594 | 3667.781 |
| 500 | 30.77 | 65.000 | 2.031 | 6.094 | 18.281 | 54.844 | 164.531 | 493.594 | 1480.781 |
| 1000 | 30.30 | 33.000 | 1.031 | 3.094 | 9.281 | 27.844 | 83.531 | 250.594 | 751.781 |
| 2000 | 29.41 | 17.000 | 0.531 | 1.594 | 4.781 | 14.344 | 43.031 | 129.094 | 387.281 |
| 5000 | 27.03 | 7.400 | 0.231 | 0.694 | 2.081 | 6.244 | 18.731 | 56.194 | 168.581 |
| 10000 | 23.81 | 4.200 | 0.131 | 0.394 | 1.181 | 3.544 | 10.631 | 31.894 | 95.681 |
| 20000 | 19.23 | 2.600 | 0.081 | 0.244 | 0.731 | 2.194 | 6.581 | 19.744 | 59.231 |
| 50000 | 12.20 | 1.640 | 0.051 | 0.154 | 0.461 | 1.384 | 4.151 | 12.454 | 37.361 |

Figure 45-18. Cycle Slip Monitoring Window as a function of frequency error and number of cycle slip events

A PLL Cycle Slip Fail example is shown in the figure below.

Cycle Slip Lock Detector - unlocked example

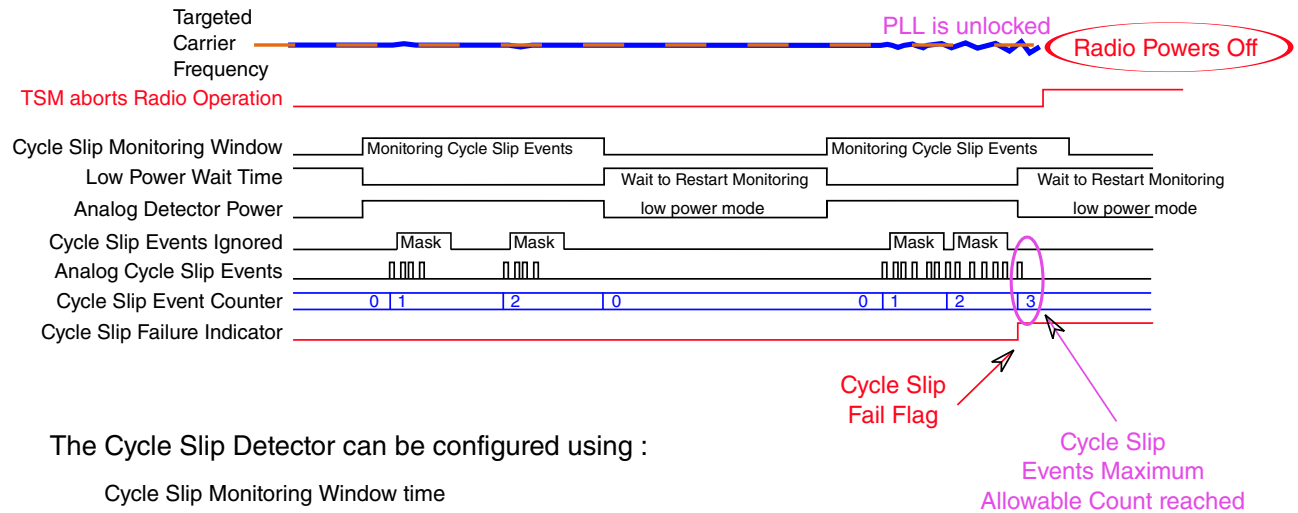

The Cycle Slip Detector can be configured using :

- Cycle Slip Monitoring Window time
- Cycle Slip Detector Low Power Wait time
- Cycle Slip Events Masking time
- Maximum Allowable Counted Cycle Slip Events

Figure 45-19. PLL Unlock Example

45.4.2.6.3.1 Cycle Slip Events Monitor Window

The Cycle Slip Events Monitoring Window Timer selects the time in microseconds that the Cycle Slip Lock Detector will monitor Cycle Slip Events.

If the Cycle Slip Events Monitoring Window Timer expires before the Cycle Slip Events Count is reached, then the Events Counter will be reset and the Events Counting sequence can restart after the Cycle Slip Detector Low Power Wait Time if the Cycle Slip Recycle bit is set.

The following selections are to be supported for the Cycle Slip Events Monitoring Window Time:

Table 45-12. Cycle Slip Events Monitoring Window Times

| CS_FW[2:0], Cycle Slip Monitor Time | Monitor Time (us) |
|-------------------------------------|-------------------|
| 0 | 8 |
| 1 | 16 |
| 2 | 24 |
| 3 | 32 |
| 4 | 64 |

Table continues on the next page...

Table 45-12. Cycle Slip Events Monitoring Window Times (continued)

| | |
|---|-----|
| 5 | 96 |
| 6 | 128 |
| 7 | 256 |

45.4.2.6.3.2 Cycle Slip Detector Low Power Wait Timer

The Cycle Slip Detector Low Power Wait Timer is a method for saving power by turning off the analog cycle slip detector circuit for a programmable period of time. If the Cycle Slip Recycle bit is set when the Cycle Slip Events Monitoring Window Timer expires, then the Events Counter will be reset and the Events Counting sequence will restart after the Cycle Slip Detector Low Power Wait Time expires.

The following selections are to be supported for the Low Power Wait Time:

Table 45-13. Cycle Slip Detector Low Power Wait Times

| CS_WT[2:0], Cycle Slip Wait Time | Wait Time (us) |
|----------------------------------|----------------|
| 0 | 128 |
| 1 | 256 |
| 2 | 384 |
| 3 | 512 |
| 4 | 640 |
| 5 | 768 |
| 6 | 896 |
| 7 | 1024 |

45.4.2.6.3.3 Cycle Slip Events Masking Timer

The Cycle Slip Events Masking Timer selects the number of nanoseconds that the Cycle Slip Lock Detector will wait before counting the next Cycle Slip Event. This allows time for the PLL to try to regain lock on the VCO.

The following selections are to be supported for the Cycle Slip Events Masking time after an analog cycle slip event:

Table 45-14. Cycle Slip Events Masking Times

| CS_FT[4:0], Cycle Slips Masking Time | Wait Time (ns), 26 MHz | Wait Time (ns), 32 MHz |
|--------------------------------------|------------------------|------------------------|
| 0 | 38 | 31 |

Table continues on the next page...

Table 45-14. Cycle Slip Events Masking Times (continued)

| | | |
|----|------|------|
| 1 | 77 | 63 |
| 2 | 115 | 94 |
| 3 | 154 | 125 |
| 4 | 192 | 156 |
| 5 | 231 | 188 |
| 6 | 269 | 219 |
| 7 | 308 | 250 |
| 8 | 346 | 281 |
| 9 | 385 | 313 |
| 10 | 423 | 344 |
| 11 | 462 | 375 |
| 12 | 500 | 406 |
| 13 | 538 | 438 |
| 14 | 577 | 469 |
| 15 | 615 | 500 |
| 16 | 654 | 531 |
| 17 | 692 | 563 |
| 18 | 731 | 594 |
| 19 | 769 | 625 |
| 20 | 808 | 656 |
| 21 | 846 | 688 |
| 22 | 885 | 719 |
| 23 | 923 | 750 |
| 24 | 962 | 781 |
| 25 | 1000 | 813 |
| 26 | 1038 | 844 |
| 27 | 1077 | 875 |
| 28 | 1115 | 906 |
| 29 | 1154 | 938 |
| 30 | 1192 | 969 |
| 31 | 1231 | 1000 |

45.4.2.6.3.4 Cycle Slip Events Count

The Cycle Slip Events Count (CS_FCNT) determines the number of Cycle Slip Events that will cause a Cycle Slip Fail Flag to be set.

The range of Cycle Slip Events Counted that will cause a Fail Flag shall be from 1 to 15.

45.4.2.7 Memory Map and Register Definition

The PLL Digital memory map and detailed descriptions of all its registers are as follows.

45.4.2.7.1 XCVR_PLL_DIG Register Descriptions

45.4.2.7.1.1 XCVR_PLL_DIG_ADDR Memory Map

Base address: 4005C224h

| Offset | Register | Width (In bits) | Access | Reset value |
|-----------|--|--------------------|--------|-------------|
| 4005C224h | PLL HPM Analog Bump Control (HPM_BUMP) | 32 | RW | 00001010h |
| 4005C228h | PLL Modulation Control (MOD_CTRL) | 32 | RW | 00000000h |
| 4005C22Ch | PLL Channel Mapping (CHAN_MAP) | 32 | RW | 00000200h |
| 4005C230h | PLL Lock Detect Control (LOCK_DETECT) | 32 | RW | 00606800h |
| 4005C234h | PLL High Port Modulator Control (HPM_CTRL) | 32 | RW | 90840000h |
| 4005C244h | PLL High Port Sigma Delta Results (HPM_SDM_RES) | 32 | RW | 01000000h |
| 4005C248h | PLL Low Port Modulator Control (LPM_CTRL) | 32 | RW | 08080000h |
| 4005C24Ch | PLL Low Port Sigma Delta Control 1 (LPM_SDM_CTRL1) | 32 | RW | 00260026h |
| 4005C250h | PLL Low Port Sigma Delta Control 2 (LPM_SDM_CTRL2) | 32 | RW | 02000000h |
| 4005C254h | PLL Low Port Sigma Delta Control 3 (LPM_SDM_CTRL3) | 32 | RW | 04000000h |
| 4005C258h | PLL Low Port Sigma Delta Result 1 (LPM_SDM_RES1) | 32 | RO | 0E200000h |
| 4005C25Ch | PLL Low Port Sigma Delta Result 2 (LPM_SDM_RES2) | 32 | RO | 04000000h |
| 4005C260h | PLL Delay Matching (DELAY_MATCH) | 32 | RW | 00000204h |
| 4005C264h | PLL Coarse Tune Control (CTUNE_CTRL) | 32 | RW | 00000000h |
| 4005C278h | PLL Coarse Tune Results (CTUNE_RES) | 32 | RO | 09620040h |

45.4.2.7.1.2 PLL HPM Analog Bump Control (HPM_BUMP)

45.4.2.7.1.2.1 Address

| Register | Offset |
|----------|-----------|
| HPM_BUMP | 4005C224h |

FSK Modulator

45.4.2.7.1.2.2 Diagram

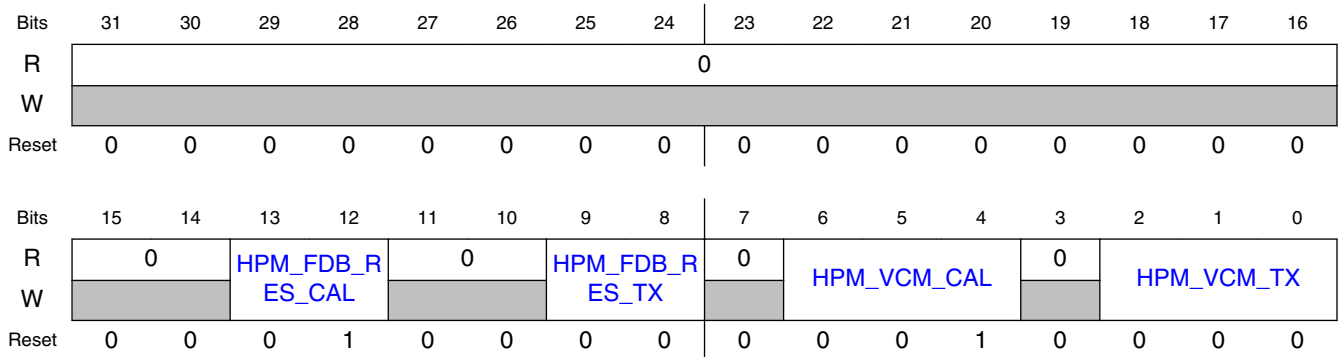

45.4.2.7.1.2.3 Fields

| Field | Function |
|------------------------------|--|
| 31-14 Reserved | Reserved |
| 13-12 HPM_FDB_RES _CAL | rfctrl_tx_dac_bump_fdb_res[1:0] during Calibration This is the value applied to the rfctrl_tx_dac_bump_fdb_res[1:0] port during High Port Calibration. This register sets the HPM DAC feedback resistor to increase the modulation gain during calibration. 00b - 29 kohms 01b - 58 kohms(gain of 2) 10b - 13 kohms 11b - 23.7 kohms |
| 11-10 — | Reserved |
| 9-8 HPM_FDB_RES _TX | rfctrl_tx_dac_bump_fdb_res[1:0] during Transmission This is the value applied to the rfctrl_tx_dac_bump_fdb_res[1:0] port during Radio Transmissions. This register sets the HPM DAC feedback resistor during transmissions. 00b - 29 kohms 01b - 58 kohms(gain of 2) 10b - 13 kohms 11b - 23.7 kohms |
| 7 — | Reserved |
| 6-4 HPM_VCM_CA L | rfctrl_tx_dac_bump_vcm[2:0] during Calibration This is the value applied to the rfctrl_tx_dac_bump_vcm[2:0] port during High Port Calibration. This register sets the HPM DAC Op-Amp reference voltage during calibration. 000b - 432 mV 001b - 328 mV 010b - 456 mV 011b - 473 mV 100b - 488 mV 101b - 408 mV |

Table continues on the next page...

| Field | Function |
|-------------------|---|
| | 110b - 392 mV 111b - 376 mV |
| 3 — | Reserved |
| 2-0 HPM_VCM_TX | rfctrl_tx_dac_bump_vcm[2:0] during Transmission This is the value applied to the rfctrl_tx_dac_bump_vcm[2:0] port during Radio Transmissions. This register sets the HPM DAC Op-Amp reference voltage during transmissions. 000b - 432 mV 001b - 328 mV 010b - 456 mV 011b - 473 mV 100b - 488 mV 101b - 408 mV 110b - 392 mV 111b - 376 mV |

45.4.2.7.1.3 PLL Modulation Control (MOD_CTRL)

45.4.2.7.1.3.1 Address

| Register | Offset |
|----------|-----------|
| MOD_CTRL | 4005C228h |

45.4.2.7.1.3.2 Diagram

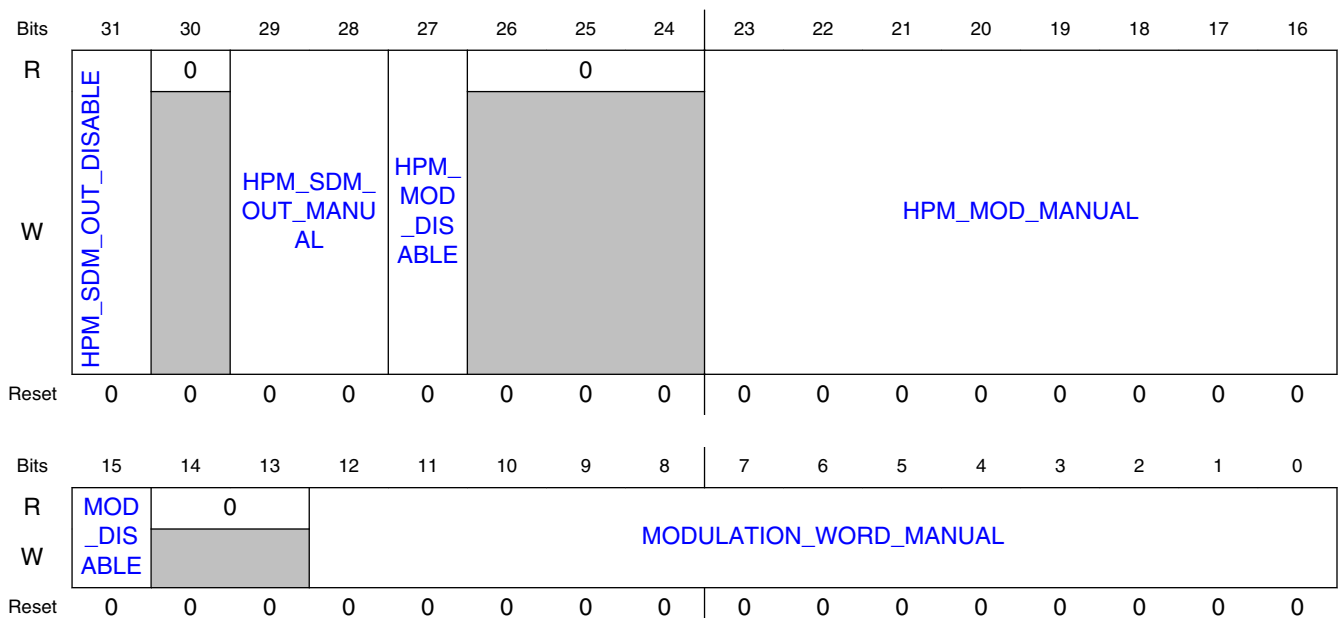

45.4.2.7.1.3.3 Fields

| Field | Function |
|--------------------------------|--|
| 31 HPM_SDM_OUT_DISABLE | Disable HPM SDM out If this bit is set, the High Port Sigma Delta Modulator output is disabled, and the High Port Fractional value applied to the VCO comes from the HPM_SDM_OUT_MANUAL register. |
| 30 — | Reserved |
| 29-28 HPM_SDM_OUT_MANUAL | Manual HPM SDM out If HPM_SDM_OUT_DISABLE is set, this register is the Fractional value that is applied to the VCO High Port. |
| 27 HPM_MOD_DISABLE | Disable HPM Modulation If this bit is set, the High Port Modulation is disabled, and the High Port Modulation value applied to the VCO comes from the HPM_MOD_MANUAL register. |
| 26-24 — | Reserved |
| 23-16 HPM_MOD_MANUAL | Manual HPM Modulation If HPM_MOD_DISABLE is set, this register is the modulation value that is applied to the VCO High Port. |
| 15 MOD_DISABLE | Disable Modulation Word If this bit is set, any modulation from the TX Digital is disabled and the source of the Baseband Frequency Word is the MODULATION_WORD_MANUAL register. |
| 14-13 — | Reserved |
| 12-0 MODULATION_WORD_MANUAL | Manual Modulation Word If MOD_DISABLE is set, the signed 12 bit value that is represented by this register is the Baseband Frequency Word. |

45.4.2.7.1.4 PLL Channel Mapping (CHAN_MAP)

45.4.2.7.1.4.1 Address

| Register | Offset |
|----------|-----------|
| CHAN_MAP | 4005C22Ch |

45.4.2.7.1.4.2 Diagram

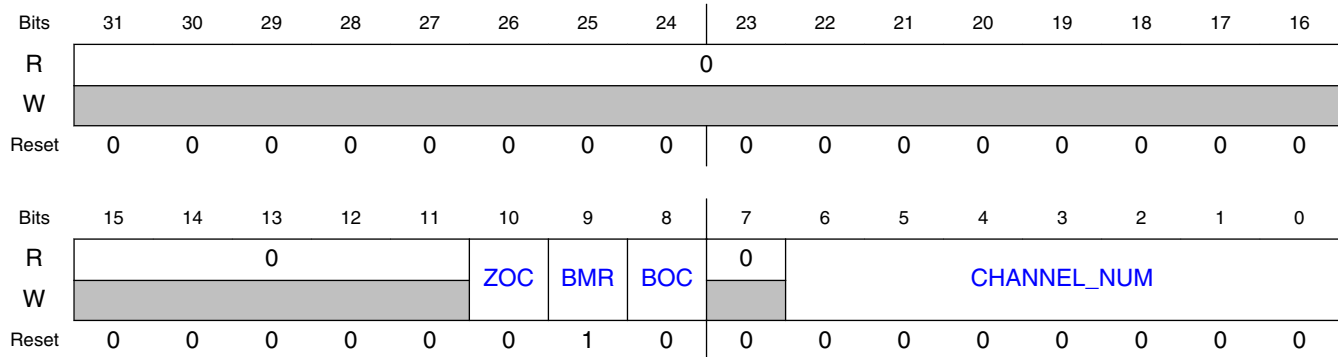

45.4.2.7.1.4.3 Fields

| Field | Function |
|--------------------|---|
| 31-11 Reserved | Reserved |
| 10 ZOC | 802.15.4 Channel Number Override This bit controls the source of the 802.15.4 channel selection. 0b - 802.15.4 channel number comes from the 802.15.4 Link Layer. 1b - 802.15.4 channel number comes from the CHANNEL_NUM register (802.15.4 protocols 4 and 5) |
| 9 BMR | BLE MBAN Channel Remap This bit controls the mapping of BLE channel 39 in Radio Protocol 2, BLE overlap MBAN mode. 0b - BLE channel 39 is mapped to BLE channel 39, 2.480 GHz 1b - BLE channel 39 is mapped to MBAN channel 39, 2.399 GHz |
| 8 BOC | BLE Channel Number Override This bit controls the source of the BLE channel selection. 0b - BLE channel number comes from the BLE Link Layer 1b - BLE channel number comes from the CHANNEL_NUM register (BLE protocols 0 and 2) |
| 7 — | Reserved |
| 6-0 CHANNEL_NUM | Protocol specific Channel Number for PLL Frequency Mapping When this register is active, it can be used to directly select a Protocol specific Channel Number, which is mapped internally to the correct Radio Carrier Frequency for PLL tuning. The internal mapping is detailed in the table below. This register is active when BOC or ZOC are set along with their corresponding Radio Protocols, and this register is also active in protocols 1, 6 and 7. The Radio Channel Frequency can also be selected by setting the SDM_MAP_DISABLE bit in the PLL_LPM_SDM_CTRL1 register along with the LPM_INTG, LPM_NUM, and LPM_DENOM registers to get a frequency that equals ((Reference Clock Frequency x 2) x (LPM_INTG + (LPM_NUM / LPM_DENOM)) This table shows the internal mapping by Protocol of the Channel Numbers to the Radio Carrier Frequency (MHz). |

| Field | Function | | | | | | | | | |
|-------|---|-------|------|-------|------------------|-------|----------|-------|----------------|-------|
| | Radio Protocols Supported, Channel Frequency in MHz | | | | | | | | | |
| | BLE | | MBAN | | BLE Overlap MBAN | | 802.15.4 | | 802.15.4j MBAN | |
| | 0 | | 1 | | 2 | | 3 | | 4 | |
| | Chan | MHz | Chan | MHz | Chan | MHz | Chan | MHz | Chan | MHz |
| | 0 | 2,402 | 0 | 2,360 | 0 | 2,402 | 11 | 2,405 | 0 | 2,363 |
| | 1 | 2,404 | 1 | 2,361 | 1 | 2,404 | 12 | 2,410 | 1 | 2,368 |
| | 2 | 2,406 | 2 | 2,362 | 2 | 2,406 | 13 | 2,415 | 2 | 2,373 |
| | 3 | 2,408 | 3 | 2,363 | 3 | 2,408 | 14 | 2,420 | 3 | 2,378 |
| | 4 | 2,410 | 4 | 2,364 | 4 | 2,410 | 15 | 2,425 | 4 | 2,383 |
| | 5 | 2,412 | 5 | 2,365 | 5 | 2,412 | 16 | 2,430 | 5 | 2,388 |
| | 6 | 2,414 | 6 | 2,366 | 6 | 2,414 | 17 | 2,435 | 6 | 2,393 |
| | 7 | 2,416 | 7 | 2,367 | 7 | 2,416 | 18 | 2,440 | 7 | 2,367 |
| | 8 | 2,418 | 8 | 2,368 | 8 | 2,418 | 19 | 2,445 | 8 | 2,372 |
| | 9 | 2,420 | 9 | 2,369 | 9 | 2,420 | 20 | 2,450 | 9 | 2,377 |
| | 10 | 2,422 | 10 | 2,370 | 10 | 2,422 | 21 | 2,455 | 10 | 2,382 |
| | 11 | 2,424 | 11 | 2,371 | 11 | 2,424 | 22 | 2,460 | 11 | 2,387 |
| | 12 | 2,426 | 12 | 2,372 | 12 | 2,426 | 23 | 2,465 | 12 | 2,392 |
| | 13 | 2,428 | 13 | 2,373 | 13 | 2,428 | 24 | 2,470 | 13 | 2,397 |
| | 14 | 2,430 | 14 | 2,374 | 14 | 2,430 | 25 | 2,475 | 14 | 2,395 |
| | 15 | 2,432 | 15 | 2,375 | 15 | 2,432 | 26 | 2,480 | | |
| | 16 | 2,434 | 16 | 2,376 | 16 | 2,434 | | | | |
| | 17 | 2,436 | 17 | 2,377 | 17 | 2,436 | | | | |
| | 18 | 2,438 | 18 | 2,378 | 18 | 2,438 | | | | |
| | 19 | 2,440 | 19 | 2,379 | 19 | 2,440 | | | | |
| | 20 | 2,442 | 20 | 2,380 | 20 | 2,442 | | | | |
| | 21 | 2,444 | 21 | 2,381 | 21 | 2,444 | | | | |
| | 22 | 2,446 | 22 | 2,382 | 22 | 2,446 | | | | |
| | 23 | 2,448 | 23 | 2,383 | 23 | 2,448 | | | | |
| | 24 | 2,450 | 24 | 2,384 | 24 | 2,450 | | | | |
| | 25 | 2,452 | 25 | 2,385 | 25 | 2,452 | | | | |
| | 26 | 2,454 | 26 | 2,386 | 26 | 2,454 | | | | |
| | 27 | 2,456 | 27 | 2,387 | 27 | 2,456 | | | | |
| | 28 | 2,458 | 28 | 2,388 | 28 | 2,458 | | | | |
| | 29 | 2,460 | 29 | 2,389 | 29 | 2,460 | | | | |
| | 30 | 2,462 | 30 | 2,390 | 30 | 2,390 | | | | |
| | 31 | 2,464 | 31 | 2,391 | 31 | 2,391 | | | | |
| | 32 | 2,466 | 32 | 2,392 | 32 | 2,392 | | | | |
| | 33 | 2,468 | 33 | 2,393 | 33 | 2,393 | | | | |
| | 34 | 2,470 | 34 | 2,394 | 34 | 2,394 | | | | |
| | 35 | 2,472 | 35 | 2,395 | 35 | 2,395 | | | | |
| | 36 | 2,474 | 36 | 2,396 | 36 | 2,396 | | | | |

| Field | Function | | | | | | | | | |
|---|----------|-------|---------|-------|---------|-------|--|--|--|--|
| | 37 | 2,476 | 37 | 2,397 | 37 | 2,397 | | | | |
| | 38 | 2,478 | 38 | 2,398 | 38 | 2,398 | | | | |
| | 39 | 2,480 | 39 | 2,399 | 39* | 2,480 | | | | |
| * The BLE MBAN Channel Remap bit, BMR, controls the frequency mapping in this case. | | | | | | | | | | |
| Radio Protocols Supported, Channel Frequency in MHz | | | | | | | | | | |
| DFT, Generic | | | | | | | | | | |
| 6,7,8,9 | | | | | | | | | | |
| | Channel | MHz | Channel | MHz | Channel | MHz | | | | |
| | 0 | 2,360 | 43 | 2,403 | 86 | 2,446 | | | | |
| | 1 | 2,361 | 44 | 2,404 | 87 | 2,447 | | | | |
| | 2 | 2,362 | 45 | 2,405 | 88 | 2,448 | | | | |
| | 3 | 2,363 | 46 | 2,406 | 89 | 2,449 | | | | |
| | 4 | 2,364 | 47 | 2,407 | 90 | 2,450 | | | | |
| | 5 | 2,365 | 48 | 2,408 | 91 | 2,451 | | | | |
| | 6 | 2,366 | 49 | 2,409 | 92 | 2,452 | | | | |
| | 7 | 2,367 | 50 | 2,410 | 93 | 2,453 | | | | |
| | 8 | 2,368 | 51 | 2,411 | 94 | 2,454 | | | | |
| | 9 | 2,369 | 52 | 2,412 | 95 | 2,455 | | | | |
| | 10 | 2,370 | 53 | 2,413 | 96 | 2,456 | | | | |
| | 11 | 2,371 | 54 | 2,414 | 97 | 2,457 | | | | |
| | 12 | 2,372 | 55 | 2,415 | 98 | 2,458 | | | | |
| | 13 | 2,373 | 56 | 2,416 | 99 | 2,459 | | | | |
| | 14 | 2,374 | 57 | 2,417 | 100 | 2,460 | | | | |
| | 15 | 2,375 | 58 | 2,418 | 101 | 2,461 | | | | |
| | 16 | 2,376 | 59 | 2,419 | 102 | 2,462 | | | | |
| | 17 | 2,377 | 60 | 2,420 | 103 | 2,463 | | | | |
| | 18 | 2,378 | 61 | 2,421 | 104 | 2,464 | | | | |
| | 19 | 2,379 | 62 | 2,422 | 105 | 2,465 | | | | |
| | 20 | 2,380 | 63 | 2,423 | 106 | 2,466 | | | | |
| | 21 | 2,381 | 64 | 2,424 | 107 | 2,467 | | | | |
| | 22 | 2,382 | 65 | 2,425 | 108 | 2,468 | | | | |
| | 23 | 2,383 | 66 | 2,426 | 109 | 2,469 | | | | |
| | 24 | 2,384 | 67 | 2,427 | 110 | 2,470 | | | | |
| | 25 | 2,385 | 68 | 2,428 | 111 | 2,471 | | | | |
| | 26 | 2,386 | 69 | 2,429 | 112 | 2,472 | | | | |
| | 27 | 2,387 | 70 | 2,430 | 113 | 2,473 | | | | |
| | 28 | 2,388 | 71 | 2,431 | 114 | 2,474 | | | | |
| | 29 | 2,389 | 72 | 2,432 | 115 | 2,475 | | | | |

| Field | Function | | | | | |
|-------|----------|-------|----|-------|-----|-------|
| | 30 | 2,390 | 73 | 2,433 | 116 | 2,476 |
| | 31 | 2,391 | 74 | 2,434 | 117 | 2,477 |
| | 32 | 2,392 | 75 | 2,435 | 118 | 2,478 |
| | 33 | 2,393 | 76 | 2,436 | 119 | 2,479 |
| | 34 | 2,394 | 77 | 2,437 | 120 | 2,480 |
| | 35 | 2,395 | 78 | 2,438 | 121 | 2,481 |
| | 36 | 2,396 | 79 | 2,439 | 122 | 2,482 |
| | 37 | 2,397 | 80 | 2,440 | 123 | 2,483 |
| | 38 | 2,398 | 81 | 2,441 | 124 | 2,484 |
| | 39 | 2,399 | 82 | 2,442 | 125 | 2,485 |
| | 40 | 2,400 | 83 | 2,443 | 126 | 2,486 |
| | 41 | 2,401 | 84 | 2,444 | 127 | 2,487 |
| | 42 | 2,402 | 85 | 2,445 | | |

45.4.2.7.1.5 PLL Lock Detect Control (LOCK_DETECT)

45.4.2.7.1.5.1 Address

| Register | Offset |
|-------------|-----------|
| LOCK_DETECT | 4005C230h |

45.4.2.7.1.5.2 Diagram

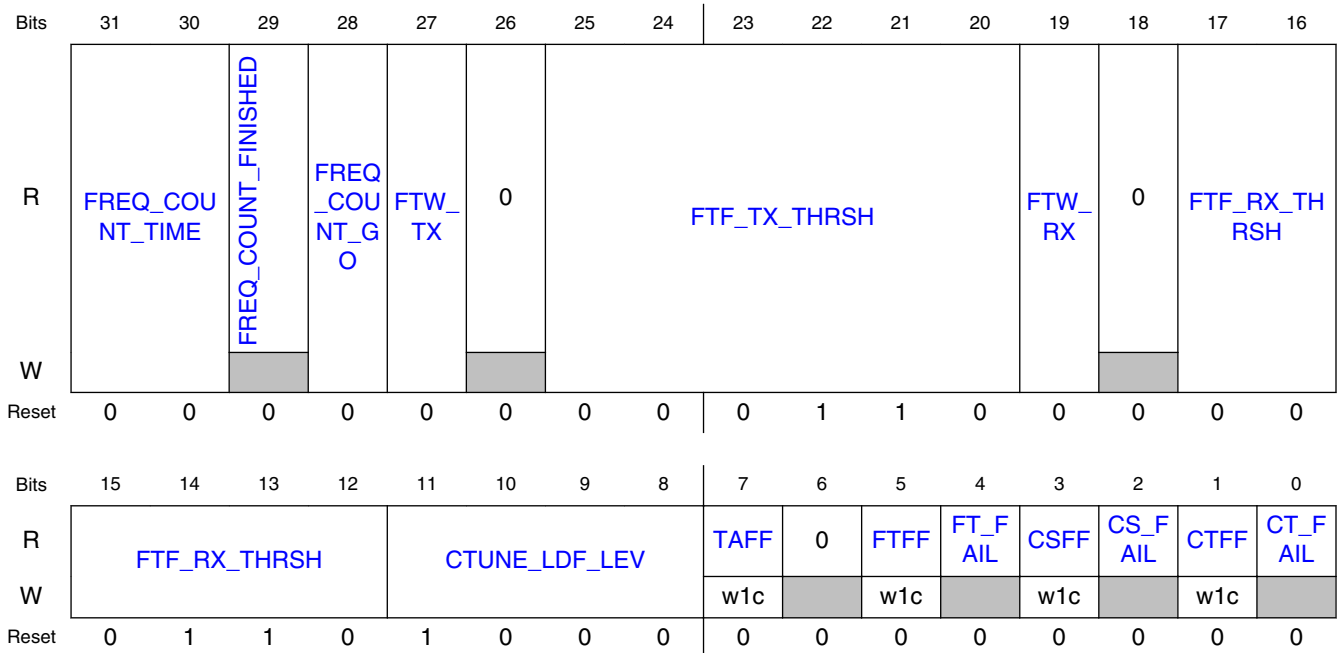

45.4.2.7.1.5.3 Fields

| Field | Function |
|---------------------------|---|
| 31-30 FREQ_COUNT_TIME | Frequency Meter Count Time This is the length of time that the Frequency Meter will count VCO clocks. 00b - 10 us 01b - 25 us 10b - 50 us 11b - 100 us |
| 29 FREQ_COUNT_FINISHED | Frequency Meter has finished the Count Time This bit is set when the FREQ_COUNT_TIME value is reached, it is cleared when FREQ_COUNT_GO is cleared. |
| 28 FREQ_COUNT_GO | Start the Frequency Meter The Frequency Meter starts when this bit is set and runs until the FREQ_COUNT_TIME value is reached. The bit should not be cleared until after the counting is finished. After the Counting Time finishes, the FREQ_COUNT_FINISHED bit will read as a one. Then the measured frequency can be calculated by reading the frequency counts in the DFT_FREQ_COUNTER register (in the XCVR_ANALOG register space) and dividing by the FREQ_COUNT_TIME. Note that the counting is done at the VCO frequency which is 2X the Carrier Frequency |
| 27 FTW_TX | TX Frequency Target Window time select In Radio Transmit Mode, this bit selects the length of time to count for the estimation of PLL lock frequency, which is compared with the Frequency Target Window, set by FTF_TX. 0b - 4 us 1b - 8 us |
| 26 | Reserved |

Table continues on the next page...

FSK Modulator

| Field | Function |
|---------------------------|---|
| — | |
| 25-20 FTF_TX_THRS H | TX Frequency Target Fail Threshold In Radio Transmit Mode, the FT_FAIL and FTFF bits will be set after the Frequency Target Count completes if the absolute value of the count difference from the frequency target count is greater than this register value. |
| 19 FTW_RX | RX Frequency Target Window time select In Radio Receive Mode, this bit selects the length of time to count for the estimation of PLL lock frequency, which is compared with the Frequency Target Window, set by FTF_RX. 0b - 4 us 1b - 8 us |
| 18 — | Reserved |
| 17-12 FTF_RX_THRS H | RX Frequency Target Fail Threshold In Radio Receive Mode, the FT_FAIL and FTFF bits will be set after the Frequency Target Count completes if the absolute value of the count difference from the frequency target count is greater than this register value. |
| 11-8 CTUNE_LDF_L EV | CTUNE Lock Detect Fail Level The CT_FAIL and CTFF bits will be set after Coarse Tune Calibration completes if the absolute value of the Coarse Tune best count difference (CTUNE_BEST_DIFF in the PLL_CTUNE_RESULTS register) is greater than this register value. |
| 7 TAFF | TSM Abort Failure Flag This bit is set if the TSM Sequence Aborts, and this bit is cleared by writing a 1 to it. |
| 6 — | Reserved |
| 5 FTFF | Frequency Target Failure Flag This bit is set when FT_FAIL is first set, and this bit is cleared by writing a 1 to it. |
| 4 FT_FAIL | Real time status of Frequency Target Failure If the Frequency Target Count has completed and the count was out of the range selected by FTW_TX or FTW_RX, then this bit will be set. |
| 3 CSFF | Cycle Slip Failure Flag, held until cleared This bit is set when CS_FAIL is first set, and this bit is cleared by writing a 1 to it. |
| 2 CS_FAIL | Real time status of Cycle Slip circuit This bit shows the real-time status of the Cycle Slip State Machine Interrupt which is configured using the control bits in the PLL_HPM_CAL1 and PLL_HPM_CAL2 registers. |
| 1 CTFF | CTUNE Failure Flag, held until cleared This bit is set when CT_FAIL is first set, and this bit is cleared by writing a 1 to it. |
| 0 CT_FAIL | Real time status of Coarse Tune Fail signal If the Coarse Tune Calibration has completed and the best count difference is out of the range selected by CTUNE_LDF_LEV, then this bit will be set. |

45.4.2.7.1.6 PLL High Port Modulator Control (HPM_CTRL)

45.4.2.7.1.6.1 Address

| Register | Offset |
|----------|-----------|
| HPM_CTRL | 4005C234h |

45.4.2.7.1.6.2 Diagram

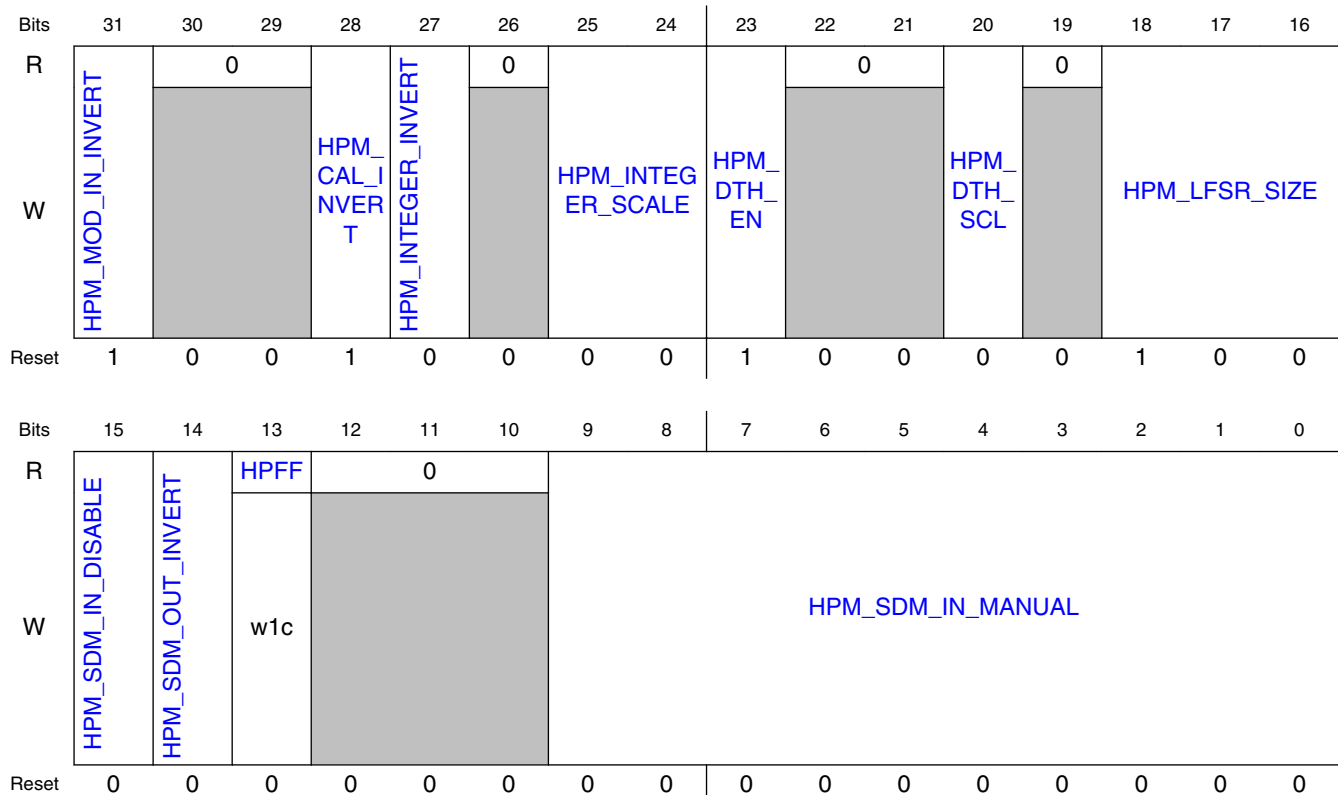

45.4.2.7.1.6.3 Fields

| Field | Function |
|-------------------|---|
| 31 | Invert High Port Modulation |
| HPM_MOD_IN_INVERT | If this bit is set then the High Port Modulation Word is inverted before it is multiplied and split into Integer and Fractional values. |
| 30-29 | Reserved |
| — | |
| 28 | Invert High Port Modulator Calibration |
| HPM_CAL_INVERT | If this bit is set then the order of the High Port Calibration is reversed in order to get a positive count difference between the Maximum and Minimum settings of the HPM DAC. |
| 27 | Invert High Port Modulation Integer |

Table continues on the next page...

FSK Modulator

| Field | Function |
|-----------------------------|--|
| HPM_INTEGER_INVERT | If this bit is set then the High Port Modulation Integer value, after the multiply and split into Integer and Fractional values, will be inverted before it is applied to the VCO High Port DAC Array. |
| 26 — | Reserved |
| 25-24 HPM_INTEGER_SCALE | High Port Modulation Integer Scale This register controls the scaling of the High Port Modulation Integer Value applied to the VCO High Port DAC Array. 00b - No Scaling 01b - Multiply by 2 10b - Divide by 2 11b - Reserved |
| 23 HPM_DTH_EN | Dither Enable for HPM LFSR If this bit is set, the High Port Fraction will be Dithered by the High Port LFSR before it is applied to the High Port SDM. |
| 22-21 — | Reserved |
| 20 HPM_DTH_SCL | HPM Dither Scale If this bit is set, the LFSR dithering of the High Port Fraction will be multiplied by 2. |
| 19 — | Reserved |
| 18-16 HPM_LFSR_SIZE | HPM LFSR Length This register selects the length of the HPM LFSR and the associated LFSR Tap Mask 000b - LFSR 9, tap mask 100010000 001b - LFSR 10, tap mask 1001000000 010b - LFSR 11, tap mask 11101000000 011b - LFSR 13, tap mask 1101100000000 100b - LFSR 15, tap mask 11101000000000 101b - LFSR 17, tap mask 1111000000000000 110b - Reserved 111b - Reserved |
| 15 HPM_SDM_IN_DISABLE | Disable HPM SDM Input If this bit is set, the Fractional portion of the High Port Modulation to the High Port SDM is disabled, and the High Port SDM input comes from the HPM_SDM_IN_MANUAL register. |
| 14 HPM_SDM_OUTPUT_INVERT | Invert HPM SDM Output If this bit is set the High Port SDM result will be Inverted before it is applied to the VCO High Port DAC Array. |
| 13 HPFF | HPM SDM Invalid Flag This bit is set if the High Port Sigma Delta Modulator output is invalid due to an error in the fraction applied, and this bit is cleared by writing a 1 to it. |
| 12-10 — | Reserved |
| 9-0 HPM_SDM_IN_MANUAL | Manual High Port SDM Fractional value If HPM_SDM_IN_DISABLE is set, this register is the value that is applied as the Fractional value to the input of the High Port SDM. |

45.4.2.7.1.7 PLL High Port Sigma Delta Results (HPM_SDM_RES)

45.4.2.7.1.7.1 Address

| Register | Offset |
|-------------|-----------|
| HPM_SDM_RES | 4005C244h |

45.4.2.7.1.7.2 Diagram

| | | | | | | | | | | | | | | | | |
|-------|------------------|----|----|----|------------------|----|-----------|----|----|----|----|----|----|----|----|----|
| Bits | 31 | 30 | 29 | 28 | 27 | 26 | 25 | 24 | 23 | 22 | 21 | 20 | 19 | 18 | 17 | 16 |
| R | HPM_COUNT_ADJUST | | | | 0 | | HPM_DENOM | | | | | | | | | |
| W | | | | | | | | | | | | | | | | |
| Reset | 0 | 0 | 0 | 0 | 0 | 0 | 0 | 1 | 0 | 0 | 0 | 0 | 0 | 0 | 0 | 0 |
| Bits | 15 | 14 | 13 | 12 | 11 | 10 | 9 | 8 | 7 | 6 | 5 | 4 | 3 | 2 | 1 | 0 |
| R | 0 | | | | HPM_NUM_SELECTED | | | | | | | | | | | |
| W | | | | | | | | | | | | | | | | |
| Reset | 0 | 0 | 0 | 0 | 0 | 0 | 0 | 0 | 0 | 0 | 0 | 0 | 0 | 0 | 0 | 0 |

45.4.2.7.1.7.3 Fields

| Field | Function |
|------------------|---|
| 31-28 | HPM_COUNT_ADJUST |
| HPM_COUNT_ADJUST | This register represents a signed three bit value that is used to adjust the High Port Calibration Frequency Count Difference. The range of adjustment is -8 to +7, applied to the difference between Count 1 and Count 2. |
| 27-26 | Reserved |
| — | |
| 25-16 | High Port Modulator SDM Denominator |
| HPM_DENOM | This is the denominator that is currently being applied to the High Port Sigma Delta Modulator, for valid Sigma Delta operation the resulting fraction NUM/DENOM must be in the range -0.6 to +0.6 |
| 15-10 | Reserved |
| — | |
| 9-0 | High Port Modulator SDM Numerator |
| HPM_NUM_SELECTED | This is the numerator that is currently being applied to the High Port Sigma Delta Modulator, for valid Sigma Delta operation the resulting fraction NUM/DENOM must be in the range -0.6 to +0.6 |

45.4.2.7.1.8 PLL Low Port Modulator Control (LPM_CTRL)

FSK Modulator

45.4.2.7.1.8.1 Address

| Register | Offset |
|----------|-----------|
| LPM_CTRL | 4005C248h |

45.4.2.7.1.8.2 Diagram

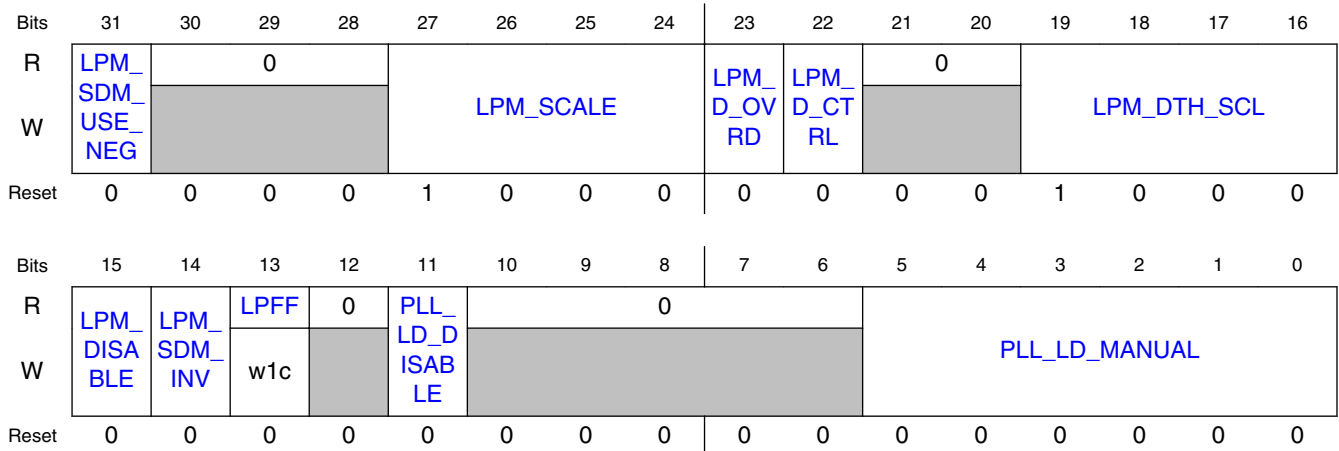

45.4.2.7.1.8.3 Fields

| Field | Function |
|--------------------|--|
| 31 | Use the Negedge of the Sigma Delta clock |
| LPM_SDM_USE_NEG | If this bit is set then the negative edge of the Sigma Delta clock is used to launch the Low Port Modulation word to the VCO Loop Divider. |
| 30-28 — | Reserved |
| 27-24 LPM_SCALE | <p>LPM Scale Factor</p> <p>This register controls the scaling of the Baseband Frequency Word and is used to match the Modulation Frequency Deviation required to the Low Port Sigma Delta Modulator LSB size in Hz.</p> <ul style="list-style-type: none"> 0000b - No Scaling 0001b - Multiply by 2 0010b - Multiply by 4 0011b - Multiply by 8 0100b - Multiply by 16 0101b - Multiply by 32 0110b - Multiply by 64 0111b - Multiply by 128 1000b - Multiply by 256 1001b - Multiply by 512 1010b - Multiply by 1024 1011b - Multiply by 2048 1100b - Reserved 1101b - Reserved |

Table continues on the next page...

| Field | Function |
|----------------------|---|
| | 1110b - Reserved 1111b - Reserved |
| 23 LPM_D_OVRD | LPM Dither Override Mode Select When this bit is set, the Scaled Baseband Frequency Word applied to the Low Port Sigma Delta Modulator will be dithered if LPM_D_CTRL is set, and not dithered if LPM_D_CTRL is cleared. If this bit is cleared, then the LPM Numerator will be dithered in Radio Receive mode, and also in Radio Transmit mode when the LPM Numerator approaches an Integer value in order to preserve the validity of the Sigma Delta Modulator output. |
| 22 LPM_D_CTRL | LPM Dither Control in Override Mode If LPM_D_OVRD is set, this bit turns LPM Dithering on and off. |
| 21-20 — | Reserved |
| 19-16 LPM_DTH_SCL | LPM Dither Scale This register controls the scale of the Dithering added to the Scaled Baseband Frequency Word before it is applied to the Low Port Sigma Delta Modulator as the LPM Numerator. The unit for the ranges shown below is the LP SDM LSB in Hz. 0000b - Reserved 0001b - Reserved 0010b - Reserved 0011b - Reserved 0100b - Reserved 0101b - -128 to 96 0110b - -256 to 192 0111b - -512 to 384 1000b - -1024 to 768 1001b - -2048 to 1536 1010b - -4096 to 3072 1011b - -8192 to 6144 1100b - Reserved 1101b - Reserved 1110b - Reserved 1111b - Reserved |
| 15 LPM_DISABLE | Disable LPM SDM This bit controls the Modulation of the Low Port Sigma Delta. If this bit is set, the Low Port Sigma Delta Modulator will be active and control the PLL to maintain a steady frequency based on the current Integer, Numerator, and Denominator values that are being applied. No Modulation or Dithering will be added to the steady frequency result. |
| 14 LPM_SDM_INV | Invert LPM SDM If this bit is set the Scaled Baseband Frequency Word, including any Dithering, will be Inverted before it is applied to the Low Port Sigma Delta Modulator. |
| 13 LPFF | LPM SDM Invalid Flag This bit is set if the Low Port Sigma Delta Modulator output is invalid due to an error in the fraction applied, and this bit is cleared by writing a 1 to it. |
| 12 — | Reserved |
| 11 | Disable PLL Loop Divider |

Table continues on the next page...

FSK Modulator

| Field | Function |
|----------------------|---|
| PLL_LD_DISABLE | If this bit is set, the Low Port Sigma Delta Modulator output is disabled, and the PLL Loop Divider value applied to the PLL comes from the PLL_LD_MANUAL register. |
| 10-6 — | Reserved |
| 5-0 PLL_LD_MANUAL | Manual PLL Loop Divider value If PLL_LD_DISABLE is set, this register is the value that is applied to the PLL Loop Divider. |

45.4.2.7.1.9 PLL Low Port Sigma Delta Control 1 (LPM_SDM_CTRL1)

45.4.2.7.1.9.1 Address

| Register | Offset |
|---------------|-----------|
| LPM_SDM_CTRL1 | 4005C24Ch |

45.4.2.7.1.9.2 Diagram

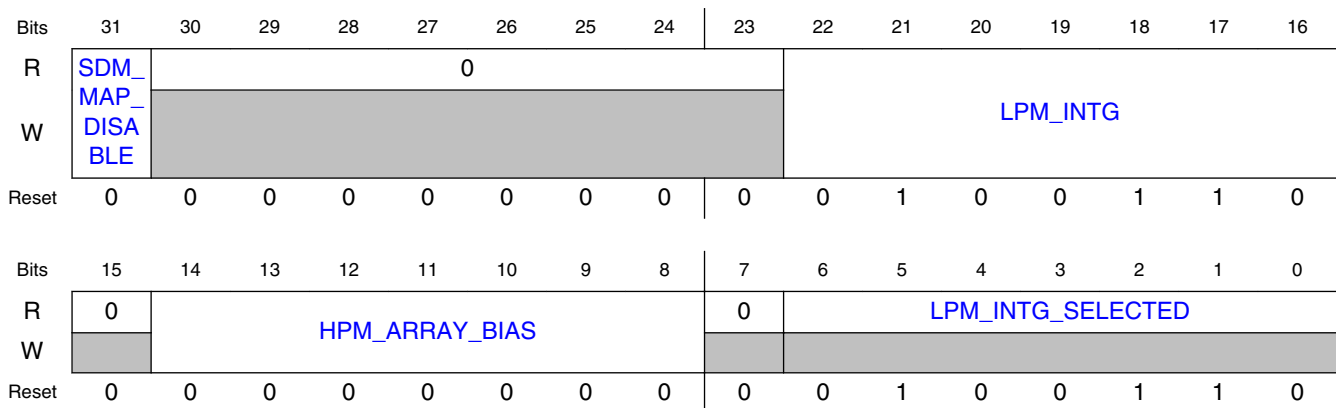

45.4.2.7.1.9.3 Fields

| Field | Function |
|-----------------------|--|
| 31 SDM_MAP_DISABLE | Disable SDM Mapping If this bit is set, the Low Port Sigma Delta Modulator internal frequency mapping based on Protocol specific channel numbers is disabled, and the Radio Channel Frequency is selected by setting the LPM_INTG, LPM_NUM, and LPM_DENOM registers to get a frequency that equals : $((\text{Reference Clock Frequency} \times 2) \times (\text{LPM_INTG} + (\text{LPM_NUM} / \text{LPM_DENOM})))$ |
| 30-23 | Reserved |

Table continues on the next page...

| Field | Function |
|--------------------------|--|
| — | |
| 22-16 LPM_INTG | Manual Low Port Modulation Integer Value If SDM_MAP_DISABLE is set, this register is the value that is applied to the Low Port Sigma Delta Modulator for the Integer, the nominal range is 36 to 39 in decimal. |
| 15 — | Reserved |
| 14-8 HPM_ARRAY_BIAS | Bias value for High Port DAC Array Midpoint The value of this register represents a signed six bit value that can be used to adjust the midpoint of the High Port Modulator DAC. The range of adjustment is -64 to +63, and the adjustment is made to the High Port Modulation Word before the multiply, and before the split into Integer and Fractional values. The range of adjustment in Hz is approximately +/- 62.5 kHz |
| 7 — | Reserved |
| 6-0 LPM_INTG_SELECTED | Low Port Modulation Integer Value Selected This shows the Integer value that is currently being applied to the Low Port Sigma Delta Modulator. |

45.4.2.7.1.10 PLL Low Port Sigma Delta Control 2 (LPM_SDM_CTRL2)

45.4.2.7.1.10.1 Address

| Register | Offset |
|---------------|-----------|
| LPM_SDM_CTRL2 | 4005C250h |

45.4.2.7.1.10.2 Diagram

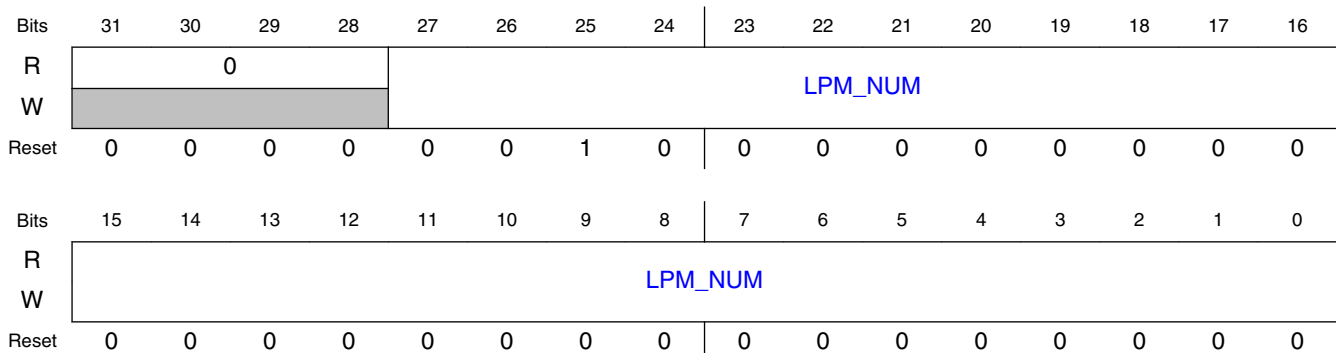

45.4.2.7.1.10.3 Fields

| Field | Function |
|-----------------|--|
| 31-28 — | Reserved |
| 27-0 LPM_NUM | Low Port Modulation Numerator If SDM_MAP_DISABLE is set, this register is the signed 27 bit value that is applied to the Low Port Sigma Delta Modulator for the Numerator. For valid Sigma Delta operation the resulting fraction NUM/DENOM must be in the range -0.6 to +0.6 |

45.4.2.7.1.11 PLL Low Port Sigma Delta Control 3 (LPM_SDM_CTRL3)

45.4.2.7.1.11.1 Address

| Register | Offset |
|---------------|-----------|
| LPM_SDM_CTRL3 | 4005C254h |

45.4.2.7.1.11.2 Diagram

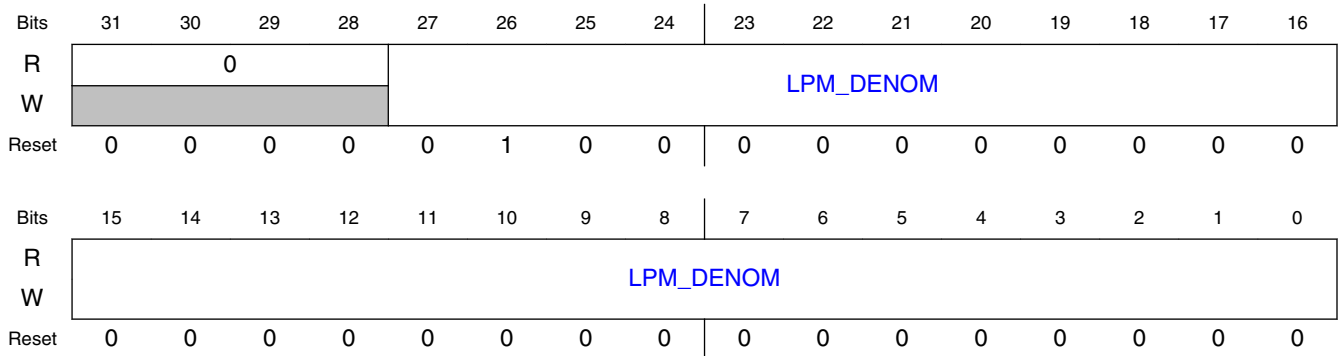

45.4.2.7.1.11.3 Fields

| Field | Function |
|-------------------|--|
| 31-28 — | Reserved |
| 27-0 LPM_DENOM | Low Port Modulation Denominator If SDM_MAP_DISABLE is set, this register is the signed 27 bit value that is applied to the Low Port Sigma Delta Modulator for the Denominator. For valid Sigma Delta operation the resulting fraction NUM/DENOM must be in the range -0.6 to +0.6 |

45.4.2.7.1.12 PLL Low Port Sigma Delta Result 1 (LPM_SDM_RES1)

45.4.2.7.1.12.1 Address

| Register | Offset |
|--------------|-----------|
| LPM_SDM_RES1 | 4005C258h |

45.4.2.7.1.12.2 Diagram

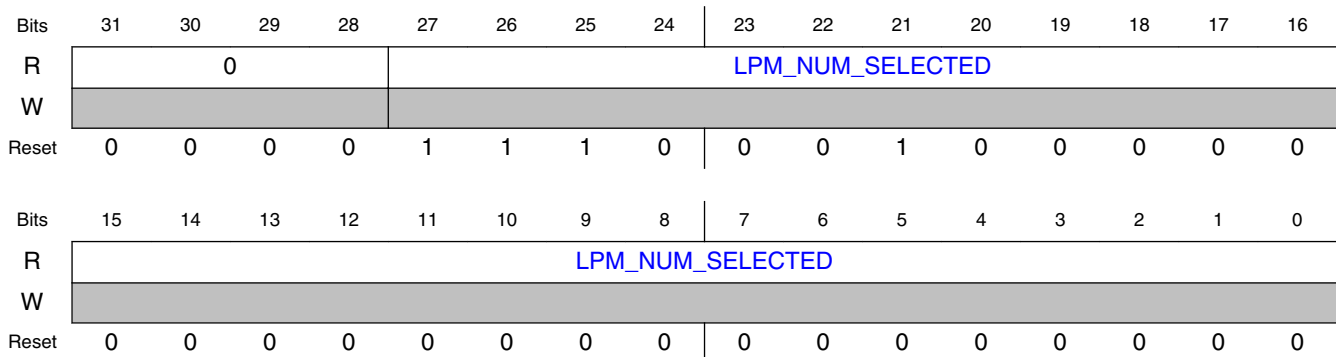

45.4.2.7.1.12.3 Fields

| Field | Function |
|--------------------------|--|
| 31-28 — | Reserved |
| 27-0 LPM_NUM_SELECTED | Low Port Modulation Numerator Applied This is the value that is currently being applied to the Low Port Sigma Delta Modulator, for valid Sigma Delta operation the resulting fraction NUM/DENOM must be in the range -0.6 to +0.6 |

45.4.2.7.1.13 PLL Low Port Sigma Delta Result 2 (LPM_SDM_RES2)

45.4.2.7.1.13.1 Address

| Register | Offset |
|--------------|-----------|
| LPM_SDM_RES2 | 4005C25Ch |

FSK Modulator

45.4.2.7.1.13.2 Diagram

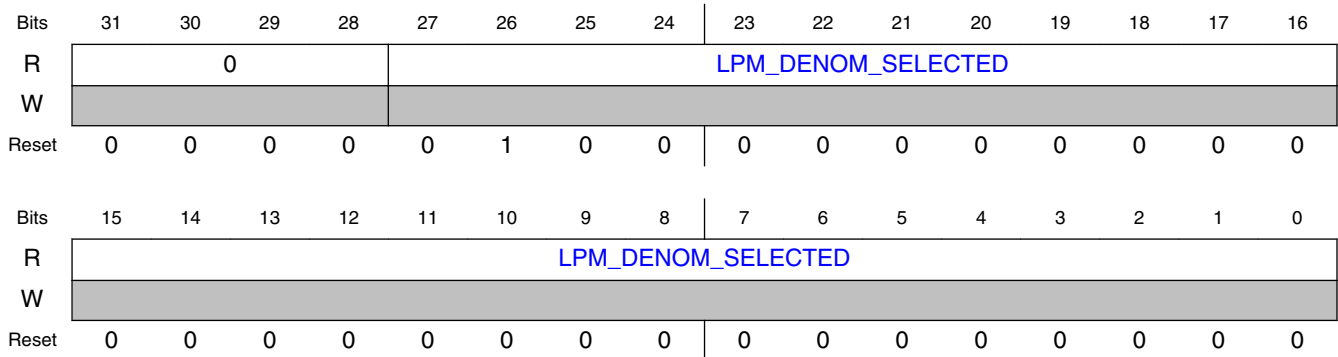

45.4.2.7.1.13.3 Fields

| Field | Function |
|----------------------------|---|
| 31-28 — | Reserved |
| 27-0 LPM_DENOM_SELECTED | Low Port Modulation Denominator Selected This is the value that is currently being applied to the Low Port Sigma Delta Modulator, for valid Sigma Delta operation the resulting fraction NUM/DENOM must be in the range -0.6 to +0.6 |

45.4.2.7.1.14 PLL Delay Matching (DELAY_MATCH)

45.4.2.7.1.14.1 Address

| Register | Offset |
|-------------|-----------|
| DELAY_MATCH | 4005C260h |

45.4.2.7.1.14.2 Diagram

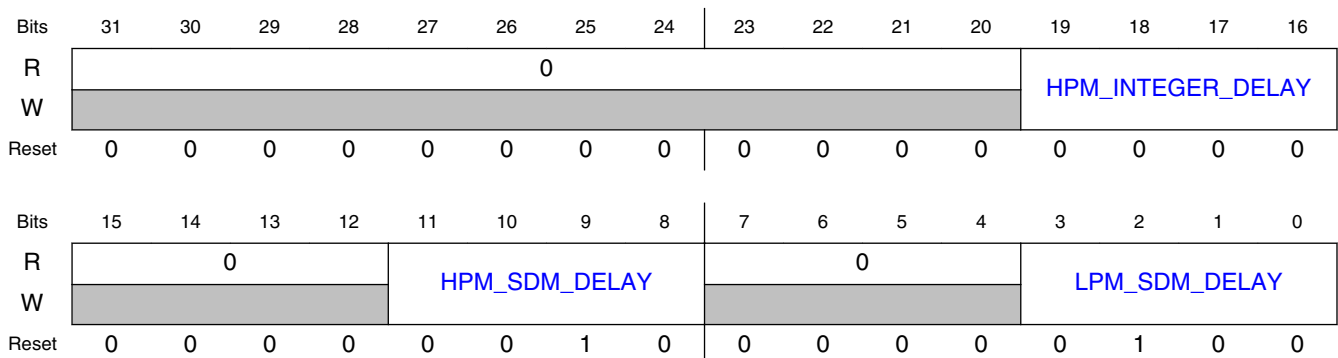

45.4.2.7.1.14.3 Fields

| Field | Function |
|--------------------------------|--|
| 31-20 — | Reserved |
| 19-16 HPM_INTEGER _DELAY | High Port Integer Delay Matching This register selects the number of clock cycles of the PLL Sigma Delta Clock divided by 2 to delay the High Port Integer modulation of the VCO High Port DAC Array. |
| 15-12 — | Reserved |
| 11-8 HPM_SDM_DE LAY | High Port SDM Delay Matching This register selects the number of clock cycles of the PLL Sigma Delta Clock divided by 2 to delay the High Port Sigma Delta modulation of the VCO High Port Fraction. Note that the High Port SDM is clocked by the PLL Sigma Delta Clock but the modulation is based on a divide by 2 version of this same clock. |
| 7-4 — | Reserved |
| 3-0 LPM_SDM_DE LAY | Low Port SDM Delay Matching This register selects the number of clock cycles of the PLL Sigma Delta Clock to delay the Low Port Sigma Delta modulation of the PLL Loop Divider. |

45.4.2.7.1.15 PLL Coarse Tune Control (CTUNE_CTRL)

45.4.2.7.1.15.1 Address

| Register | Offset |
|------------|-----------|
| CTUNE_CTRL | 4005C264h |

FSK Modulator

45.4.2.7.1.15.2 Diagram

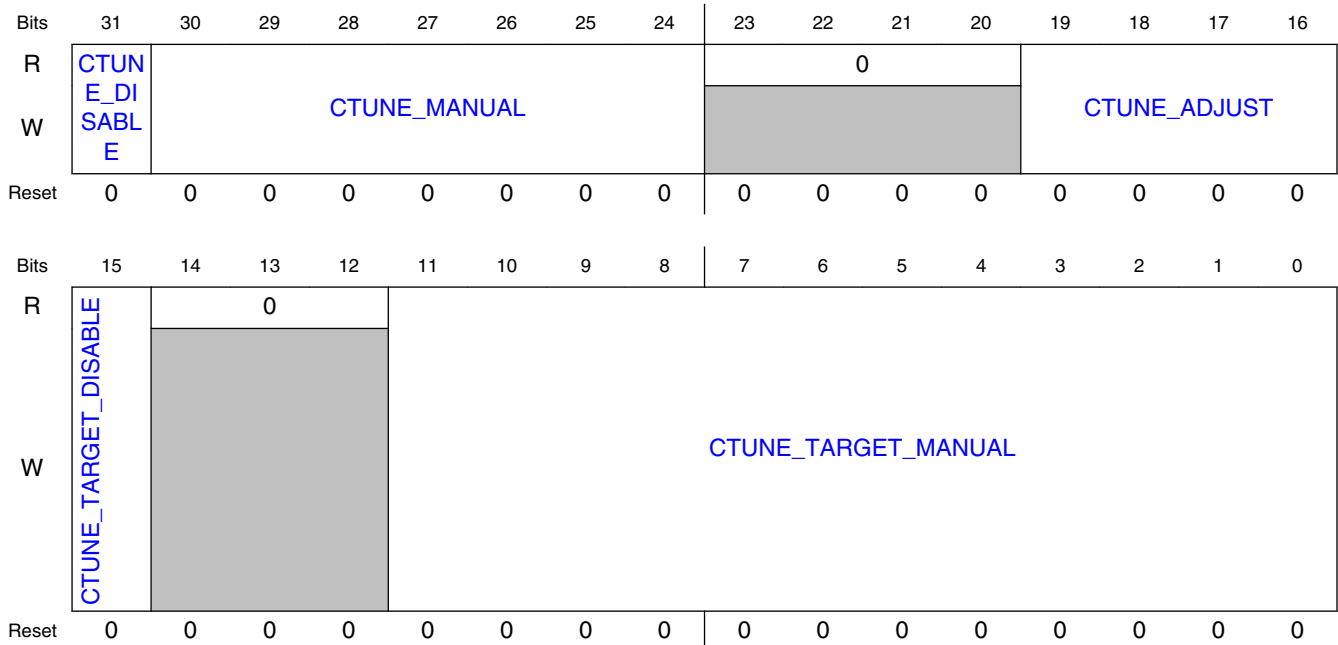

45.4.2.7.1.15.3 Fields

| Field | Function |
|-----------------------------|--|
| 31 CTUNE_DISABLE | Coarse Tune Disable If this bit is set, the Coarse Tune Setting applied to the VCO comes from the CTUNE_MANUAL register. |
| 30-24 CTUNE_MANUAL | Manual Coarse Tune Setting If CTUNE_DISABLE is set, this register is the value that is applied to the VCO as the Coarse Tune Setting. |
| 23-20 — | Reserved |
| 19-16 CTUNE_ADJUST | Coarse Tune Count Adjustment This register is a signed three bit value that adjusts the PLL Frequency Meter count used in the Coarse Tune Calibration. The range of adjustment is -8 to +7, and the adjustment is only made to the PLL Frequency count used by the Coarse Tune Calibration sequence. |
| 15 CTUNE_TARGET_DISABLE | Disable Coarse Tune Target If this bit is set, the Frequency Target presented to the Coarse Tune Calibrator comes from the CTUNE_TARGET_MANUAL register. |
| 14-12 — | Reserved |
| 11-0 CTUNE_TARGET_MANUAL | Manual Coarse Tune Target If CTUNE_TD is set, this register is the value that is presented to the Coarse Tune Calibrator as the Frequency Target in MHz. The nominal range of this target is from 2360 to 2487 in decimal. |

45.4.2.7.1.16 PLL Coarse Tune Results (CTUNE_RES)

45.4.2.7.1.16.1 Address

| Register | Offset |
|-----------|-----------|
| CTUNE_RES | 4005C278h |

45.4.2.7.1.16.2 Diagram

| | | | | | | | | | | | | | | | | |
|-------|-----------------|----|----|----|---------------------|----|----|----|----|----------------|----|----|----|----|----|----|
| Bits | 31 | 30 | 29 | 28 | 27 | 26 | 25 | 24 | 23 | 22 | 21 | 20 | 19 | 18 | 17 | 16 |
| R | 0 | | | | CTUNE_FREQ_SELECTED | | | | | | | | | | | |
| W | — | | | | | | | | | | | | | | | |
| Reset | 0 | 0 | 0 | 0 | 1 | 0 | 0 | 1 | 0 | 1 | 1 | 0 | 0 | 0 | 1 | 0 |
| Bits | 15 | 14 | 13 | 12 | 11 | 10 | 9 | 8 | 7 | 6 | 5 | 4 | 3 | 2 | 1 | 0 |
| R | CTUNE_BEST_DIFF | | | | | | | | 0 | CTUNE_SELECTED | | | | | | |
| W | — | | | | | | | | | | | | | | | |
| Reset | 0 | 0 | 0 | 0 | 0 | 0 | 0 | 0 | 0 | 1 | 0 | 0 | 0 | 0 | 0 | 0 |

45.4.2.7.1.16.3 Fields

| Field | Function |
|------------------------------|---|
| 31-28 — | Reserved |
| 27-16 CTUNE_FREQ_SELECTED | Coarse Tune Frequency Selected This is the Frequency Target in MHz that is currently being presented to the Coarse Tune Calibrator. |
| 15-8 CTUNE_BEST_DIFF | Coarse Tune Absolute Best Difference This is the absolute value of the best difference found during Coarse Tune between the targeted frequency count and the actual frequency count. |
| 7 — | Reserved |
| 6-0 CTUNE_SELECTED | Coarse Tune Setting to VCO This is the current VCO Coarse Tune setting, it is the result of the Coarse Tune Calibration, unless overridden using CTUNE_DISABLE. |

45.4.3 Receiver Digital Module

45.4.3.1 Introduction

The RX DIG module for Radio 2p0 implements the receive digital signal processing functions common to BTLE, 802.15.4, and Generic Link Layer modes. Generally this includes conditioning the input samples from the ADC and produces a data output for the PHY and an RSSI/LQI for the Link Layers.

45.4.3.1.1 Features

The rx_dig module includes the following features:

- Decimation Filter
- I/Q Mismatch Correction
- DC Offset Calibration, Estimation and Correction
- Channel Filter
- Sample Rate Converter
- DC Residual Correction
- AGC & RSSI
- Normalizer
- RC Calibration
- AuxPLL Frequency Calibration

45.4.3.1.2 Modes and operations

The rx_dig module supports BTLE, 802.15.4, and Generic Link Layer modes of operation through use of programmable values such as the oversampling rate, channel filter coefficients, etc. Another configuration is possible to simply pass the values received from the ADC.

The table below shows the data rates supported by RX DIG. Note that the ADC is clocked at twice the reference clock frequency, so ADC clock of 64Mhz corresponds to a 32MHz reference clock, and an ADC clock of 52MHz corresponds to a 26MHz reference clock.

Table 45-15. RX Digital Modes and Rates

| ADC clock (MHz) | Decimator OSR | Decimation Filter Output Rate(MHz) | SRC conversion factor | SRC Output Rate (MHz) | Use-Case |
|-----------------|---------------|------------------------------------|-----------------------|-----------------------|----------|
| | | | | | |

Table continues on the next page...

Table 45-15. RX Digital Modes and Rates (continued)

| | | | | | |
|----|----|-------|------------|---|---|
| 64 | 8 | 8 | bypass | 8 | BTLE, Generic FSK at 1Mbps |
| | 16 | 4 | bypass | 4 | IEEE 802.15.4, Generic FSK at 500 kbps |
| | 32 | 2 | bypass | 2 | Generic FSK at 250 kbps |
| 52 | 4 | 13 | FOH; 8/13 | 8 | BTLE, Generic FSK at 1Mbps (default) |
| | 6 | 8.67 | ZOH; 12/13 | 8 | BTLE, Generic FSK at 1Mbps (improved blocker rejection but reduced sensitivity) |
| | 8 | 6.5 | FOH; 8/13 | 4 | Generic FSK at 500 kbps(default) |
| | 12 | 4.33 | ZOH; 12/13 | 4 | Generic FSK at 500 kbps (with improved blocker rejection at 3MHz) |
| | 16 | 3.25 | FOH 8/13 | 2 | Generic FSK at 250 kbps |
| | 24 | 2.167 | ZOH; 12/13 | 2 | Generic FSK at 250 kbps |

45.4.3.1.3 Block diagram

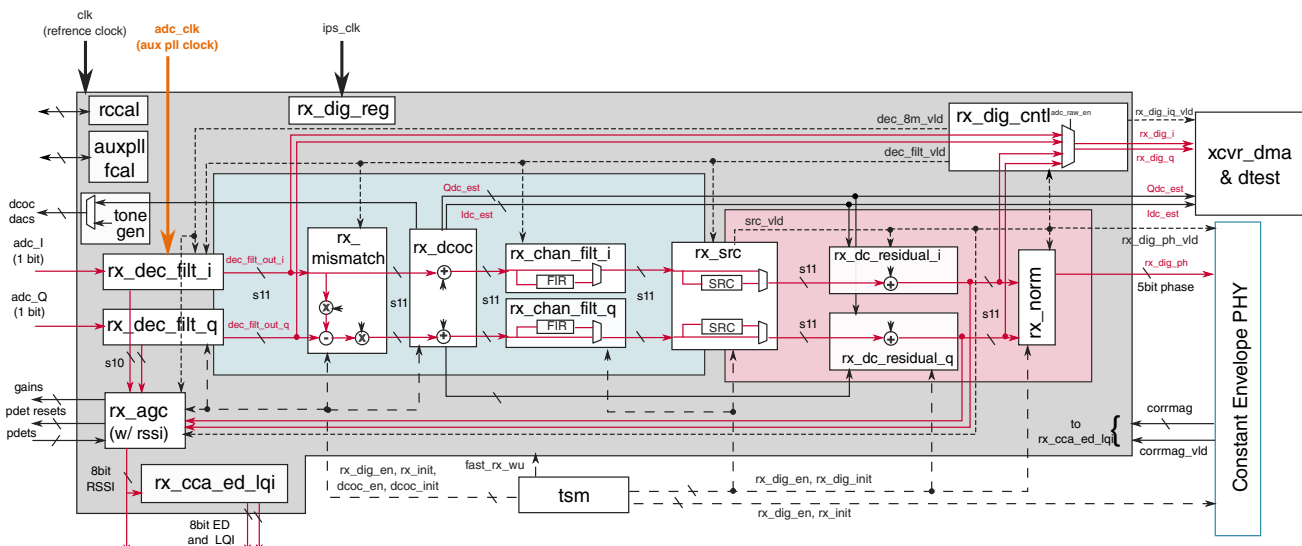

Figure 45-20. RX DIG Block diagram

45.4.3.2 Functional description

The following sections describe functional details of the RX_DIG module.

The RX_DIG module has two overall functions. Samples from the ADC are computed to usable formats for the demodulator. Additionally, the module conditions the received sample in various ways, including sending feedback to the analog circuitry.

45.4.3.2.1 Decimation Filter

The decimation filter is a 4th order Cascaded Integrator Comb (CIC) filter. Its frequency response comprises a 4th order sinc filter that supports oversampling ratios (OSR) of 4, 6, 8, 12, 16, 24 and 32 . There are two decimation filters: one for the I channel and one for the Q channel. The decimators consume the sigma-delta modulated output from the ADCs at the Aux PLL frequency clock rate (2x reference clock rate) and output samples at the decimation rate in the reference clock domain which used by the rest of the logic in RX DIG. Refer to [Table 45-15](#) for information on the supported decimation rates.

A block diagram of the decimation filter is shown below.

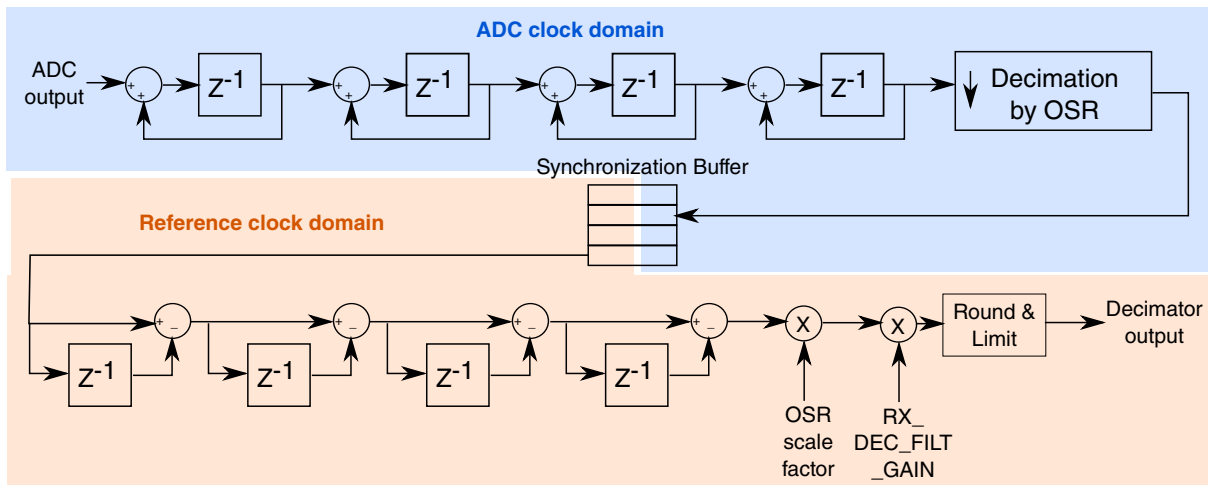

Figure 45-21. Decimation Filter Block Diagram

The decimator output scaling is dependant on the OSR scale factor (fixed in hardware, depends on the programmed OSR) and the programmable RX_DEC_FILT_GAIN. The RX_DEC_FILT_GAIN is intended to be programmed based on the maximum signal level at the ADC input, the ADC gain (1code/1.7V), and the OSR scale factor so that the maximum signal range (+2047/-2048) can be realized in the decimator output. An example of RX_DEC_FILT_GAIN programming is shown in the table below for the case where the maximum input signal level to the ADC is 1.0V. The "Maximum Decimator Output" column is computed as

$$\text{Maximum Decimator Output} = 1.0V * (1\text{code}/1.7V) * \text{OSR}^4 * \text{OSR_scale_factor} * \text{RX_DEC_FILT_GAIN} / 2$$

Table 45-16. Decimation Filter Gain Table Example, ADC input 1.0V

| OSR | Gain at output of 4th order CIC (OSR ⁴) | OSR scale factor | RX_DEC_FILT_GAIN | Maximum Decimator Output |
|-----|---|------------------|-----------------------|--------------------------|
| 4 | 256 | 2 ⁴ | 1+1/2+1/8+1/16=1.6875 | 2033 |

Table continues on the next page...

Table 45-16. Decimation Filter Gain Table Example, ADC input 1.0V (continued)

| OSR | Gain at output of 4th order CIC (OSR ⁴) | OSR scale factor | RX_DEC_FILT_GAIN | Maximum Decimator Output |
|-----|---|------------------|------------------------------|---------------------------------|
| 6 | 1296 | 2 ² | $1+1/4+1/16+1/32=1.343$ 8 | 2049 (saturated to +2047/-2048) |
| 8 | 4096 | 2 ⁰ | $1+1/2+1/8+1/16=1.6875$ | 2033 |
| 12 | 20736 | 2 ⁻² | $1+1/4+1/16+1/32=1.343$ 8 | 2049 (saturated to +2047/-2048) |
| 16 | 65536 | 2 ⁻⁴ | $1+1/2+1/8+1/16=1.6875$ | 2033 |
| 24 | 331776 | 2 ⁻⁶ | $1+1/4+1/16+1/32=1.343$ 8 | 2049 (saturated to +2047/-2048) |
| 32 | 1048576 | 2 ⁻⁸ | $1+1/2+1/8+1/16=1.6875$ | 2033 |

The decimator is controlled via several programmable bitfields, and there are also a few status bits , as noted below:

- The OSR is programmed using RX_DEC_FILT_OSR
- The decimation output is scaled based on the OSR and a programmable fractional gain (RX_DEC_FILT_GAIN), as described above. After decimation, the samples are output at the appropriate lower rate in 12-bit signed format.
- The decimator outputs RX_DEC_FILT_SAT_I and RX_DEC_FILT_SAT_Q flags to indicate if the decimator output has saturated during an RX burst
- The single-bit ADC samples can be sampled on either the posedge (default, RX_ADC_NEGEDGE=0) or negedge (RX_ADC_NEGEDGE=1) of the adc_clk.
- The single-bit ADC samples can be mapped as 1'b1->+1, 1'b0->-1 (default, RX_ADC_POL=0) or as 1'b0->+1, 1'b1->-1 (RX_ADC_POL=1).
- The decimator includes a sample buffer to handle the synchronization between the ADC output (adc_clk) clock domain and decimator output (clk) clock domains.
 - The decimator outputs a flag (RX_DEC_FILT_HAZARD) to indicate if a hazard condition has been detected (write and read pointers match) .

For an ADC clocked at a 64 MHz reference clock, an OSR of 8 is used for BTLE and an OSR of 16 is used for IEEE 802.15.4 mode. The frequency response of the decimation filter for these two cases is shown in the figures below.

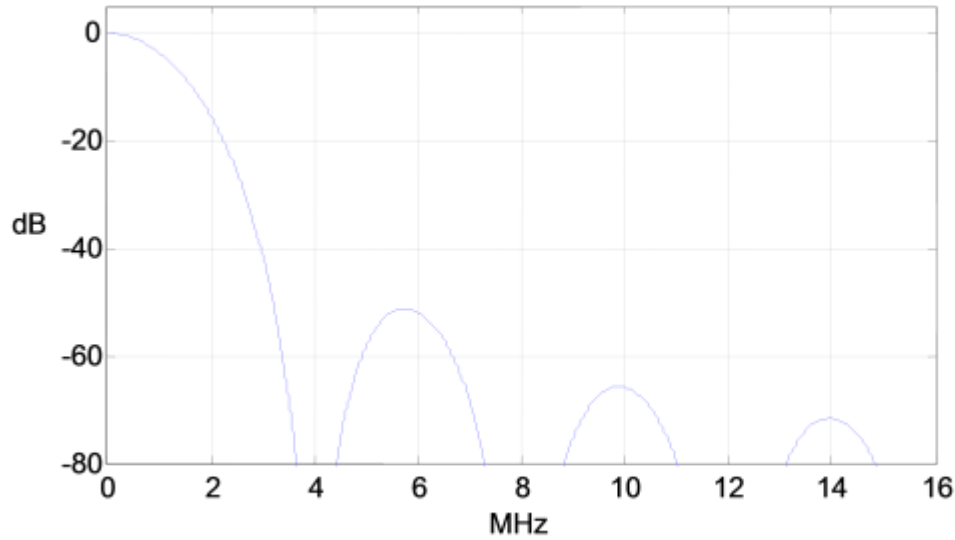

Figure 45-22. 4th order CIC (OSR=8) Decimation Filter Frequency Response

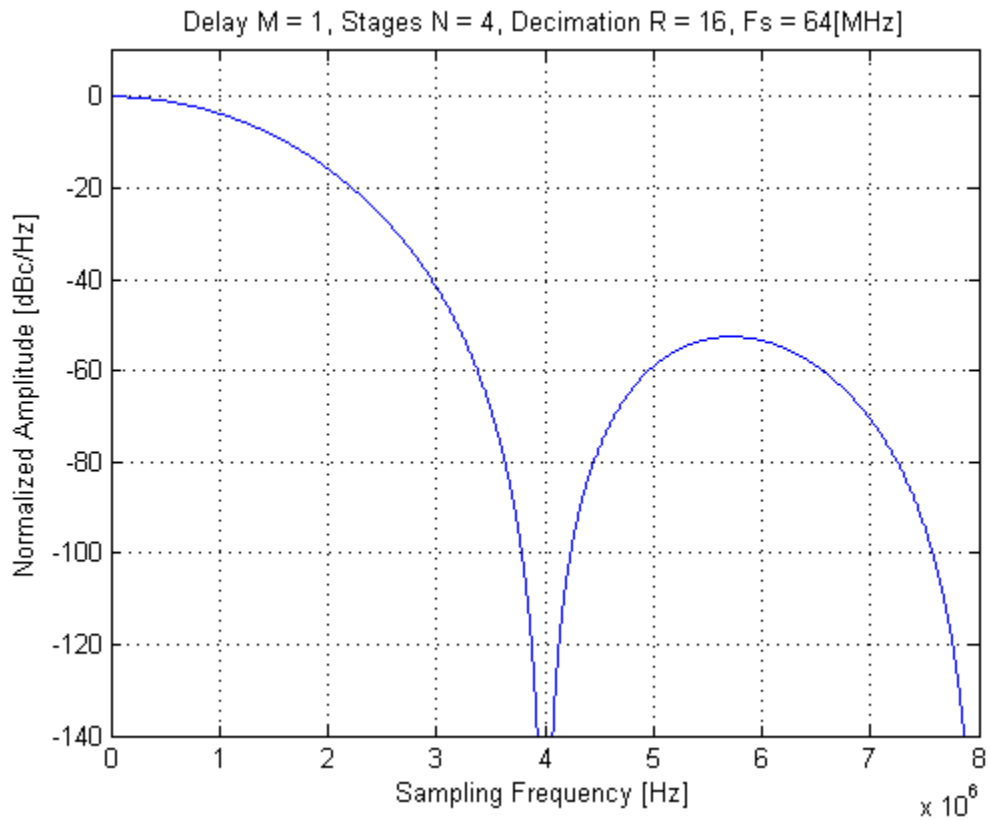

Figure 45-23. 4th order CIC (OSR=16) Decimation Filter Frequency Response

The decimator block provides a separate output for wide-band RSSI measurement that is used by the AGC algorithm and CCA1/CCA3/ED/LQI. This output is at 8MHz (32MHz reference clock) or 8.667MHz (26MHz reference clock). As the objective of the wide-band RSSI measurement is to compute a dBVrms value of the ADC output stream with minimal delay, a 2nd order CIC configuration is used. This 2nd order CIC shares the first two CIC integrators with the main datapath, but uses 2 dedicated difference stages.

The decimator for wide-band RSSI measurements is controlled via several programmable bitfields, and there are also a few status bits, as noted below:

- The decimation ratio is determined by XCVR_CTRL[REF_CLK_FREQ]. For a 32MHz reference clock, the decimation ratio is 8 so the decimator output is 8MHz; for a 26MHz reference clock, the decimation ratio is 6 so the decimation output rate is 8.667MHz
- After decimation, the samples are output at the appropriate lower rate in 10-bit signed format. The decimation output is scaled based on the OSR so that the maximum signal level is +/-576 codes.
- The decimator includes a buffer to handle the synchronization between the ADC output (adc_clk) clock domain and decimator output (clk) clock domains.
 - The wideband RSSI decimator outputs a flag (RX_RSSI_FILT_HAZARD) to indicate if a hazard condition has been detected (write and read pointers match)

45.4.3.2.2 AGC & RSSI

The AGC & RSSI module has two main functions. It estimates the energy of an incoming signal (RSSI) and it executes the Automatic Gain Control (AGC) by varying the front-end analog gain. These two functions are designed into the same block and the AGC operation relies, at times, on the estimates provided by the RSSI estimator.

45.4.3.2.2.1 RSSI estimator

The role of the RSSI (Received Signal Strength Indication) estimator is to measure the energy of an incoming signal. The estimator:

- provides a wideband ADC signal level measurement for AGC operation using a decimated version of the ADC output (*RSSI_adc*);
- provides an inband received energy estimate using the "Gain adjustment" block in [Figure 45-27](#);
- targets RSSI accuracy with tunable gains and coefficients.

RSSI accuracy is better than +/- 3dB for input signals in the range of -50dBm to 0dBm. This is the intended operating range for the AGC system. RSSI accuracy is better than +/- 6dB for all input signals below -50dBm.

RSSI estimation is performed using the binary samples output by the ADC. After this operation the signal is filtered using a second order CIC and rate reduction (to 8 MHz if 32 MHz crystal is used or to 8.66MHz for a crystal frequency of 26 MHz). The signal magnitude is then estimated with an L1-norm approach as follows:

$$\text{Magnitude}(i) = \max(|I_i|, |Q_i|) + \frac{3}{8} * \min(|I_i|, |Q_i|)$$

The estimated magnitude is then passed through a smoothing, low-pass single-tap IIR filter with the transfer function (update factor is α in [Figure 45-27](#)):

$$y[n] = (1-\alpha)y[n-1] + \alpha*x[n]$$

In order to reduce the filter settling duration, when *cca1_ed_trig* is asserted, the α IIR output is seeded with the first value of the estimated magnitude. Configuration of this filter is described in [Table 45-19](#), parameter *rss_iir_weight*. Then a down-sampler is used to reduce the sampling rate (8 MHz or 8.66 MHz) to a lower rate. A down-sampling cycle is as follows: N samples are accumulated, then the results is divided by N , division result is output (at a rate N times smaller than the input signal) and the internal accumulator is reset to 0.

Following the smoothing filter and down-sampler, the RSSI estimator converts the approximated magnitude to dB. This conversion is achieved using a look-up table ("ln2dB" block) that approximates:

$$RSSI_adc = 20 * \log_{10}(\text{approx. magnitude} / \text{ADC full scale})$$

The computed value *RSSI_adc* is intended to be used by the AGC mechanism.

RSSI_adc estimate is converted to an estimate for the signal strength at the antenna, in the "Gain Adjustment" block, using parameters as follows:

$$RSSI = RSSI_adc - \text{lnm_gain} - \text{bbf_gain} + \text{rss_adj} + 13$$

where *rss_adj* is described in [Table 45-19](#) and represents a constant value which allows taking into account different adjustments needed. The adjustment which accounts for scaled dBVrms to dBm conversion is considered using the constant 13. *lnm_gain* and *bbf_gain* values have resolution of a quarter dB.

The rest of the blocks in [Figure 45-27](#) are used for CCA1, CCA3 and ED. In order to obtain these measurements an averager is used ("RSSI Averager") which essentially is another down-sampler with a factor M . This block functions in the same manner as the N

order down-sampler. In the wideband mode context, the block "RSSI Averager" and the sub-subsequent blocks are enabled only if a CCA/ED measurement is in progress or if the test mode is enabled.

45.4.3.2.2.2 AGC

The Automatic Gain Control (AGC) system is designed to ensure that the received signal does not become distorted because of clipping in the analog receive chain, while attempting to maintain an optimal signal level for demodulation. There are two locations where gain may be adjusted: analog BBA, and analog LNA. The AGC system manipulates these gains to maintain a targeted ADC input signal level. The targeted ADC signal level is chosen as a compromise between receiver linearity, blocker headroom requirements and the goal to maximize the digital signal SNR that is provided to the protocol-specific PHY demodulators.

Additionally, the AGC system may be manually controlled by setting the `USER_BBA_GAIN_EN` and `USER_LNA_GAIN_EN` bits. If these bits are set, the gains selected in `BBA_USER_GAIN` and `LNA_USER_GAIN` will be applied.

The key components of the AGC system are: peak detectors in the analog front end, gain control, RSSI estimation, and a state machine. Additionally, the AGC system has appropriate interaction with the DCOC block to maintain a coherent state of the gains.

If the manual control of the gains is not enabled, and the AGC system is enabled, the system will automatically control the gains based on peak detector states and/or RSSI measurements.

The AGC system operated with a state machine that is depicted in [Figure 45-24](#) and has the following significant modes:

- **IDLE:** No actions are taken. The system waits for either `rx_init` (for normal receive operation) or `cal_init` (for DC calibration).
- **DC Calibration:** When `cal_init` is observed while in IDLE, the AGC enters the DC Calibration state. According to values programmed in `DCOC_CAL_GAIN`, gains will be applied for DC CAL 1, 2, 3 phases and the DCOC block can take measurements of the DC level with those gains applied. During DC Calibration, the AGC system takes no other action.
- **FAST AGC:** When `rx_init` is observed while in IDLE, the system advances to FAST AGC. Maximum gain is applied immediately. While in FAST AGC, the high level peak detectors are observed to see if clipping is occurring in the analog. If a high peak detector becomes set, a gain adjustment is applied based on the settings `AGC_DOWN_LNA_STEP_SZ`, `AGC_DOWN_BBA_STEP_SZ`, and `AGC_GAIN_TBL`. Depending on which of the two peak detectors is set, the corresponding step is taken in the gain table. When a change is made, a timer

prevents further changes until the gain change has had time to settle. This time is defined by the settings `LNA_GAIN_SETTLE_TIME` and `BBA_GAIN_SETTLE_TIME`. This time is also utilized to reset the state of the peak detectors. FAST AGC can be exited by reaching the minimum possible gain setting, or if the `fast_expire` timer expires. This time is configured with the `AGC_FAST_EXPIRE` setting.

- **SLOW AGC:** The SLOW AGC state allows for observation of RSSI, while still monitoring the peak detectors. Alternatively, RSSI can be ignored and the low peak detectors can be used to take upward gain steps. These steps are smaller than the steps taken in FAST AGC. Before entering SLOW AGC, there is a PRESLOW state where headroom is quickly checked. If there is not enough ADC headroom, a small downward gain step is taken, and then the system proceeds to SLOW AGC. Similar to FAST AGC, SLOW AGC will allow for a gain settling time whenever an adjustment is made. SLOW AGC can be exited because of several conditions. If a high peak detector indicates clipping, the system immediately moves to the FAST AGC state. If a drastic change in measured RSSI occurs, the system will similarly transition to the FAST AGC state. Finally, if the `slow_expire` timer (`ipr_agc_fast_expire` when in slow mode) reaches the pre-determined time, the system will move to HOLD AGC.
- **HOLD:** The AGC HOLD state will not take any actions unless a high peak detector is set, a large RSSI change is experienced, or the `hold_expire` timer expires. These conditions cause transitions into appropriate states to take action. The expiration of the `hold_timer` moves the system back to SLOW AGC, where monitoring of the RSSI can be done and gain increases can happen, if appropriate.

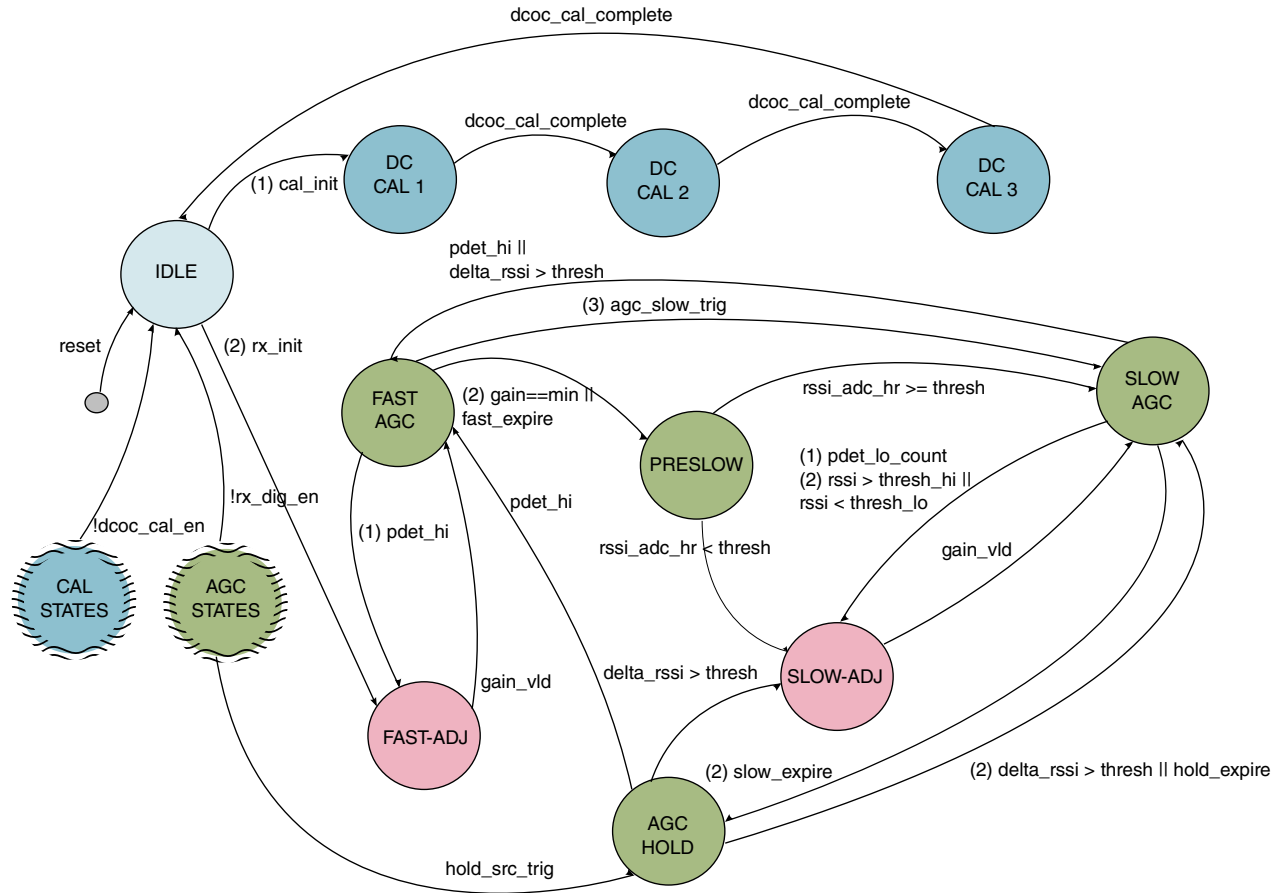

(n) indicates the priority of transition

Figure 45-24. AGC State Machine

As previously mentioned, gain steps are performed by striding through the user programmed gain table. There are 27 entries in the table, and each entry contains an index for LNA gain and an index for BBA gain. The mapping of these indices to codes and nominal gains is described in Table 45-17 and Table 45-18. These values can also be overridden manually and an alternate code can be used for debug purposes. Entry 0 is interpreted as the lowest possible gain setting, and entry 26 the highest.

Table 45-17. LNA Gains

| Ina_gain (AGC_GAIN_TBL) | LNA Gain (dB) | Ina_gain code |
|-------------------------|---------------|---------------|
| 0 | -8.6 | 01 |
| 1 | -3.5 | 02 |
| 2 | 2.2 | 03 |
| 3 | 13.9 | 04 |
| 4 | 19.8 | 08 |

Table continues on the next page...

Table 45-17. LNA Gains (continued)

| Ina_gain (AGC_GAIN_TBL) | LNA Gain (dB) | Ina_gain code |
|-------------------------|---------------|-------------------|
| 5 | 22.7 | 0C |
| 6 | 28.6 | 18 |
| 7 | 34.4 | 30 |
| 8 | 39.9 | 9C |
| 9 | 45.4 | FC |
| F | -- | LNA_ALT_CODE[7:0] |

Table 45-18. BBA Gains

| bba_gain (AGC_GAIN_TBL) | BBA Gain (dB) | bba_res_tune code |
|-------------------------|---------------|-------------------|
| 0 | 0 | A |
| 1 | 3 | 9 |
| 2 | 6 | 8 |
| 3 | 9 | 7 |
| 4 | 12 | 6 |
| 5 | 15 | 5 |
| 6 | 18 | 4 |
| 7 | 21 | 3 |
| 8 | 24 | 2 |
| 9 | 27 | 1 |
| A | 30 | 0 |
| F | -- | BBA_ALT_CODE[3:0] |

45.4.3.2.3 RSSI, Energy Detection, CCA1 and LQI module

There are two modules that achieve RSSI, Energy Detection, CCA, and LQI: rx_agc_rssi_est and rx_cca_ed_lqi.

See the AGC section for additional RSSI details.

The RSSI module is responsible with the generation of estimates used for AGC and RSSI or required by the upper layers of the protocols stack. Two modes are defined:

- **Wideband mode**, which uses as input the samples from the output of the ADC decimator (signals *dec_8m_out_i[10:0]* and *dec_8m_out_q[10:0]*). In this mode the incoming samples have sampling frequency of either 8 MHz (if 32 MHz crystal is used) or 8.66 MHz (if 26 MHz crystal is used).
- **Narrowband mode**, which uses as input the samples from the output of the min-max residual DC offset compensator (signals *narrow_band_out_i[11:0]* and *narrow_band_out_q[11:0]*). In this mode, the incoming samples have sampling frequency of either 2, 4 or 8 MHz depending on PHY configuration.

The *cca_ed_lqi* module uses *rsi* outputs from the *rsi_est* module.

Table 45-19. Parameters

| Parameter | Notes | |
|---------------------------|--|----------------------------------|
| meas_trans_to_idle | Flag establishing the state machine (see Figure 45-26) transition following an LQI or CCA1/ED measurement. | |
| | Value | Behaviour |
| | 0 | Module transitions to RSSI state |
| | 1 | Module transitions to IDLE state |
| cca1_thresh[7:0] | Threshold used for CCA1 channel state determination expressed in dBm. <i>cca1_thresh</i> is not programmed in <i>RX_DIG</i> , it is programmed in the 802.15.4 link layer. | |
| rsi_iir_weight[3:0] | Update factor used for IIR filtering of L1 magnitude and noise (α in Figure 45-27 and Figure 45-28). | |
| | Bit-field value | α |
| | 0 (<i>bypass</i>) | 1 |
| | 1 | 1/2 |
| | 2 | 1/4 |
| | 3 | 1/8 |
| | 4 | 1/16 |
| | 5 | 1/32 |
| | 6-15 | Reserved |
| rsi_n_window_avg[1:0] | Downsampling factor for filtered magnitude (<i>N</i> in Figure 45-27 and Figure 45-28). | |
| | Bit-field value | N |
| | 0 (<i>bypass</i>) | 1 |
| | 1 | 2 |
| | 3 | 8 |
| rsi_noise_avg_factor[2:0] | Factor used for RSSI and SNR averaging (<i>M</i> in Figure 45-27 and Figure 45-28). | |

Table continues on the next page...

Table 45-19. Parameters (continued)

| Parameter | Notes | |
|----------------------------|--|-----|
| | Bit-field value | M |
| | 0 (<i>bypass</i>) | 1 |
| | 1 | 64 |
| | 2 | 70 |
| | 3 | 128 |
| | 4 | 139 |
| | 5 | 256 |
| | 6 | 277 |
| | 7 | 512 |
| rss_i_noise_avg_delay[5:0] | Programmable delay used to delay the enable of averagers "RSSI Averager" and "Noise Averager" after a <i>cca1_ed_trig</i> assertion (in wideband mode) or after a <i>aa_sfd_matched</i> assertion (in narrowband mode). The delay is expressed in ticks of frequency F_s/N , where F_s is the ADC decimator output sampling frequency in wideband mode or the base-band sampling frequency in the narrowband mode. | |
| lqi_corr_thresh[7:0] | Threshold used to compare <i>corr_mag</i> (see Figure 45-28). | |
| corr_cnt_thresh[7:0] | Threshold used to compare the counted correlation magnitudes exceeding <i>lqi_corr_thresh</i> (see Figure 45-28). | |
| lqi_rssi_sens[3:0] | Unsigned integer used for calculation of LQI <i>Sensitivity</i> , through relation: $Sensitivity = -103 + lqi_rssi_sens$. | |
| lqi_rssi_weight[2:0] | RSSI weight used for LQI calculation, w_{RSSI} . | |
| | | |
| | | |
| | | |
| | | |
| | | |
| | | |
| | | |
| | | |
| rss_i_adj[7:0] | RSSI calculation adjustment (8-bit signed with quarter dB resolution). | |
| snr_lqi_weight[3:0] | SNR weight used for LQI calculation, w_{SNR} . | |
| | | |
| | | |
| | | |
| | | |

Table continues on the next page...

Table 45-19. Parameters (continued)

| Parameter | Notes | | |
|-----------|-----------------|--|--|
| | Bit-field value | W_{SNR} | |
| | 3 | 1.250 | |
| | 4 | 1.375 | |
| | 5 | 1.500 | |
| | 6 | 1.625 | |
| | 7 | 1.750 | |
| | 8 | 1.875 | |
| | 9 | 2.000 | |
| | 10 | 2.125 | |
| | 11 | 2.250 | |
| | 12 | 2.375 | |
| | 13 | 2.500 | |
| | 14 | 2.625 | |
| | 15 | 2.750 | |
| | lqi_bias[3:0] | Bias used for LQI calculation, LQI_{bias} using formula: $LQI_{bias} = -36 + 3 * lqi_bias$. | |

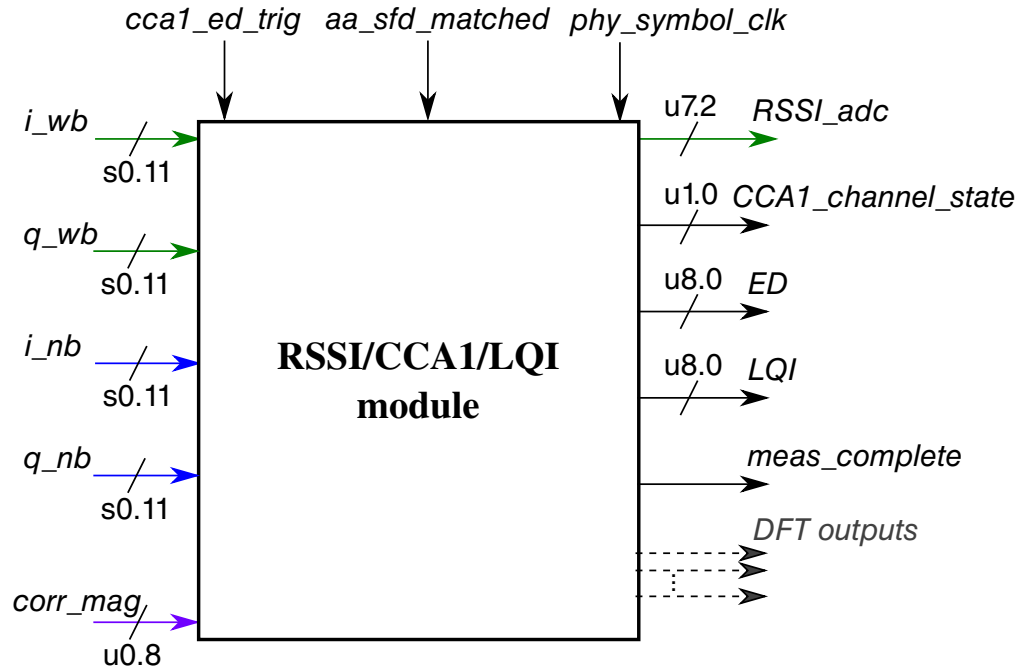

LEGEND:

- I/O signals at decimator output sampling rate (8.66/8 MHz)
- I/O signals at base-band sampling rate (8/4/2 MHz)
- I/O signals at symbol rate (2000/1000/500/250/62.5 kHz)
- I/O signals provided once per measurement

Figure 45-25. Top level view of the block diagram

Following table is showing the valid configurations and the valid outputs thereto.

Table 45-20. Valid configurations and corresponding outputs

| <i>cca1_ed_trig</i> | <i>sfd_aa_match</i> | State | Valid outputs |
|---------------------|---------------------|---------------------|--|
| 0 | 0 | RSSI | <i>RSSI_adc</i> |
| 1 | 0 | CCA1/ED measurement | <i>RSSI_adc</i> <i>zb_cca1_channel_state</i> <i>zb_cca3_channel_state</i> <i>ED</i> |
| 0 | 1 | LQI measurement | <i>LQI</i> |
| 1 | 1 | LQI measurement | <i>LQI</i> |

Following figure describes the state machine of the module.

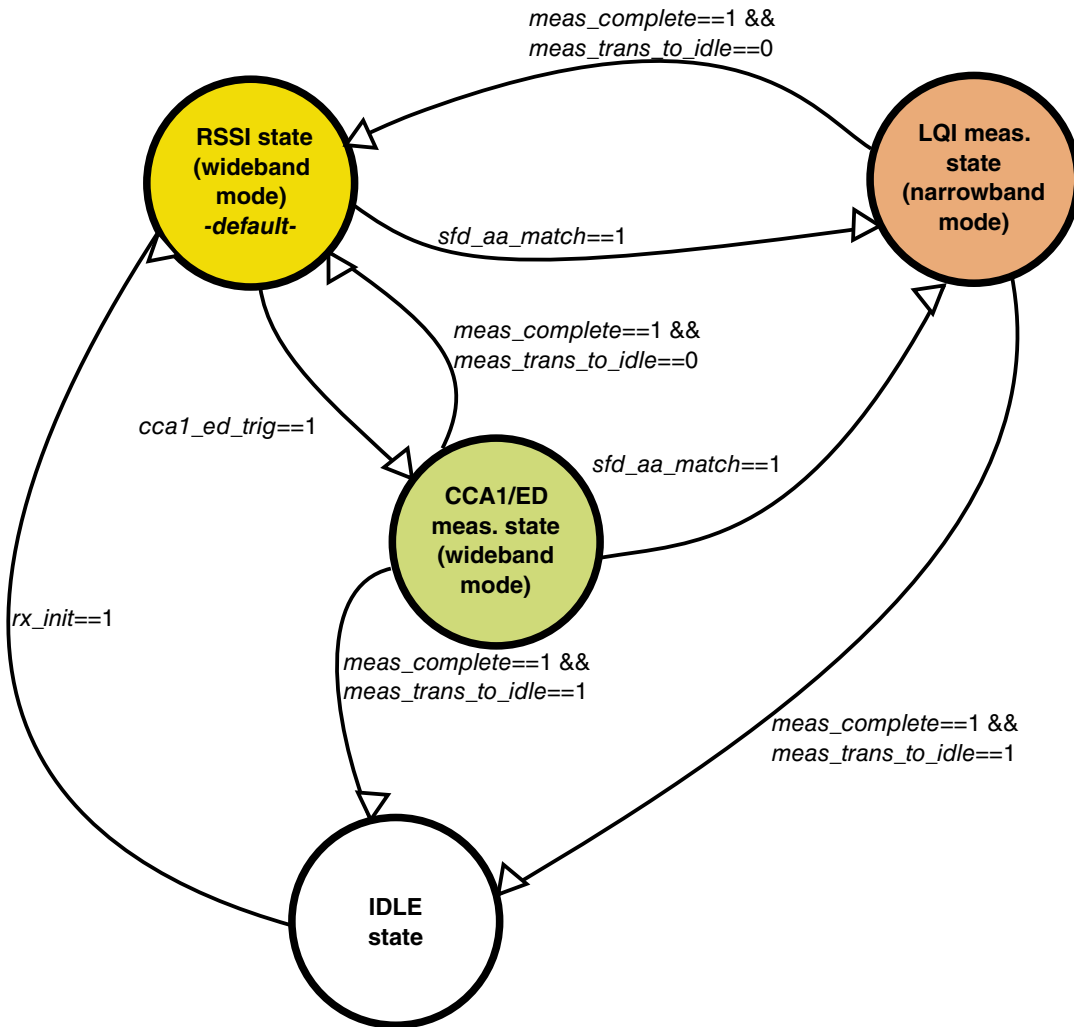

Figure 45-26. Module state machine

45.4.3.2.3.1 Wideband mode

The instantiation of the block diagram corresponding to wideband mode is illustrated in Figure 45-27. Blocks drawn using dashed lines are shared between the wideband and narrowband modes. Following functions are intended in the wideband mode (as described in Table 45-20):

- Estimation of RSSI at the output of the ADC decimator (*RSSI_adc*) used for AGC and of received inband RSSI;
- Energy detection (*ED*), required by the upper layers, which is an 8 bits value achieved through measuring the energy of the channel;
- Clear Channel Assessment Mode 1 (*zb_cca1_channel_state*), required by the upper layers, which is a flag indicating whether the channel is busy or idle.

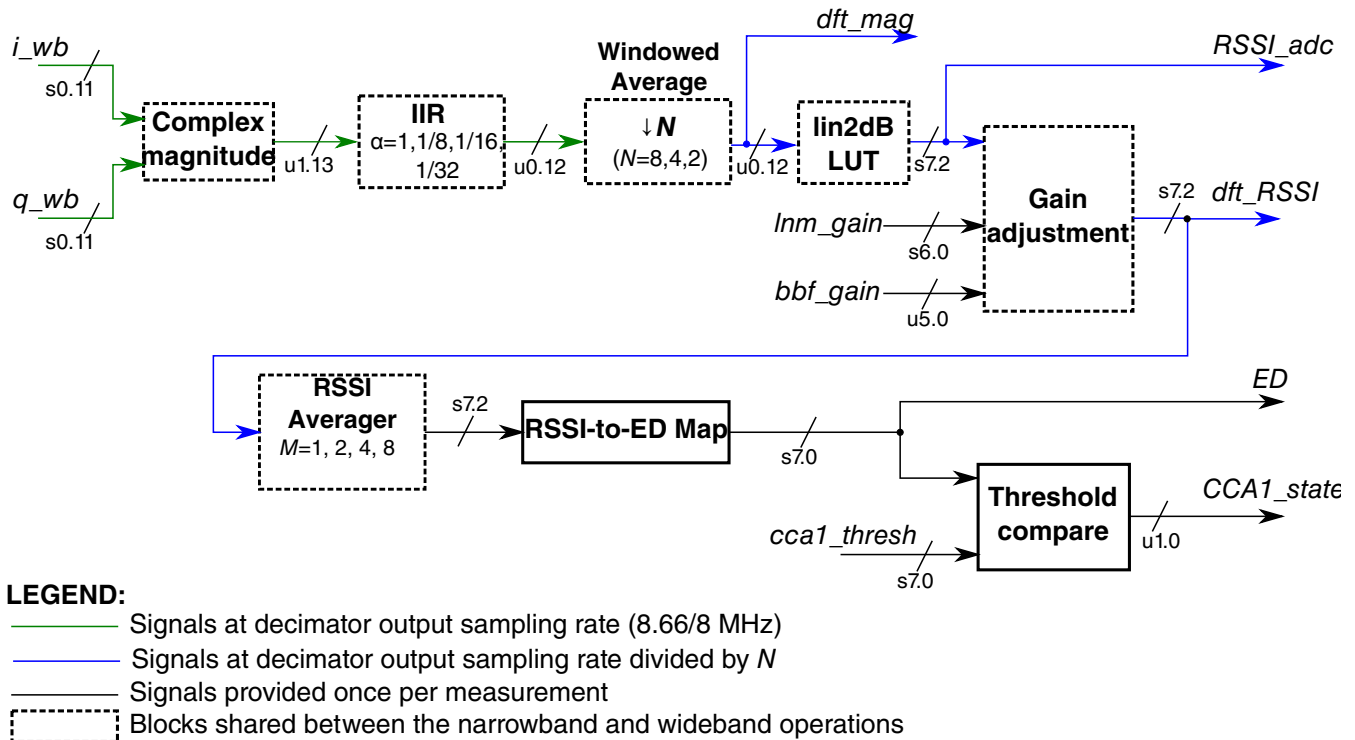

Figure 45-27. Block diagram instantiated for wideband mode

45.4.3.2.3.1.1 ED and CCA1

Module transitions to CCA1/ED measurement state and ED and CCA1 operations start based on a command signal *cca1_ed_trig* (configuration described in [Table 45-20](#)). When this signal is asserted, signal *meas_complete* is forced to low state.

When a *cca1_ed_trig* command is asserted, "RSSI averager" is enabled after a programmable delay in order to take into consideration the settling time of the IIRs (programmable delay is configured via parameter *rss_i_noise_avg_delay*). After a result is produced by the "RSSI averager" block (i.e. after $M*N$ samples have been input to the RSSI/CCA/ED/LQI module since "RSSI averager" has been enabled) in [Figure 45-27](#) signal *meas_complete* is asserted. This signal is intended to let know the external modules consuming the outputs that ED, CCA1 and CCA3 values are ready. In a non-test mode, the module returns to RSSI state after asserting *meas_complete* signal, if parameter *meas_trans_to_idle* is 0 or it transitions to IDLE state if parameter *meas_trans_to_idle* is 1 (see [Table 45-19](#)). The measured values of ED, CCA1 and CCA3 are stored until the next deassertion of signal *meas_complete*.

However, the module may be configured to remain in CCA1/ED measurement state for an arbitrary period of time in a test scenario.

Table 45-21. Typical CCA/ED measurement window values and corresponding configuration

| Crystal frequency [MHz] | ADC decimator output sampling frequency [MHz] | <i>N</i> | <i>M</i> | Approximative duration [μs] |
|-------------------------|---|----------|----------|-----------------------------|
| 32 | 8 | 16 | 64 | 128 |
| 26 | 8.66 | 16 | 70 | 128 |
| 32 | 8 | 8 | 128 | 128 |
| 26 | 8.66 | 8 | 139 | 128 |
| 32 | 8 | 8 | 64 | 64 |
| 26 | 8.66 | 8 | 70 | 64 |
| 32 | 8 | 4 | 64 | 32 |
| 26 | 8.66 | 4 | 70 | 32 |

Based on computed value *RSSI* an energy detection value *ED* is computed, expressed in dBm. This value is obtained by rounding the output of the "RSSI Averager" block to 8 signed bits by using block "RSSI-to-ED Map" in [Figure 45-27](#).

Assessment of the channel's state is by comparing value *ED* with threshold *cca1_thresh*. If the threshold is exceeded at the end of the measurement then *zb_cca1_channel_state* is put to '1'. Otherwise it is put to '0'.

The CCA3 estimation *zb_cca3_channel_state* is realized by combining *zb_cca1_channel_state* and *zb_cca2_channel_state*. This is handled outside RX_DIG.

45.4.3.2.3.2 Narrowband mode

The instantiation of the block diagram corresponding to narrowband mode is illustrated in [Figure 45-28](#). Blocks drawn using dashed lines are shared between the wideband and narrowband modes. Following functions are intended for this mode (as described in [Table 45-20](#)):

- Link Quality Indication determination (*LQI*), required by the upper layers. LQI is an 8 bits value obtained by combining inband RSSI (corresponding to channel filtered samples), SNR (signal-to-noise ratio) and correlation magnitudes;

LQI is computed in three steps:

- RSSI (using narrow band I/Q samples) and SNR estimation;
- Correlation flag determination, used to determine whether receiver is at the sensitivity boundary or not;
- LQI calculation which represents a linear combination of RSSI, SNR and correlation flag.

An LQI measurement is triggered by the assertion of *aa_sfd_matched* signal. Following this event, the module transitions to LQI measurement state. When *aa_sfd_matched* is asserted the signal *meas_complete* is deasserted (i.e. forced to low state). The blocks "RSSI averager" and "Noise averager" are enabled after a programmable delay in order to take into consideration the settling time of the IIRs (programmable delay is configured via parameter *rssi_noise_avg_delay*). Values *N* and *M* (configured through parameters *mag_downsamp_factor* and *rssi_noise_avg_factor* respectively), and the base-band sampling frequency *F_s*, directly determine the LQI measurement window duration. At the end of this window *meas_complete* is asserted and measured value *LQI* is provided, after a result is produced by the "RSSI averager" block (i.e. after *M*N* samples have been input to the RSSI/CCA/ED/LQI module since "RSSI averager" has been enabled in [Figure 45-27](#)). This signal is intended to let know the external modules consuming the outputs that LQI value is ready. The measured value of LQI is stored until the next deassertion of signal *meas_complete*. In a non-test mode, the module returns to RSSI state after asserting *meas_complete* signal, if parameter *meas_trans_to_idle* is 0 or it transitions to IDLE state if parameter *meas_trans_to_idle* is 1 (see [Table 45-19](#)).

However, the module may be configured to remain in LQI measurement state for an arbitrary period of time in a test scenario.

Table 45-22. Examples of configuration of LQI block

| Protocol | <i>N</i> | <i>M</i> | <i>F_s</i> [MHz] | Window duration [μs] |
|---------------|----------|----------|----------------------------|----------------------|
| IEEE 802.15.4 | 4 | 128 | 4 | 128 |
| BLE | 8 | 32 | 8 | 32 |
| BLE | 8 | 64 | 8 | 64 |
| FSK-500kbps | 4 | 64 | 2 | 128 |
| FSK- 250kbps | 4 | 64 | 2 | 128 |

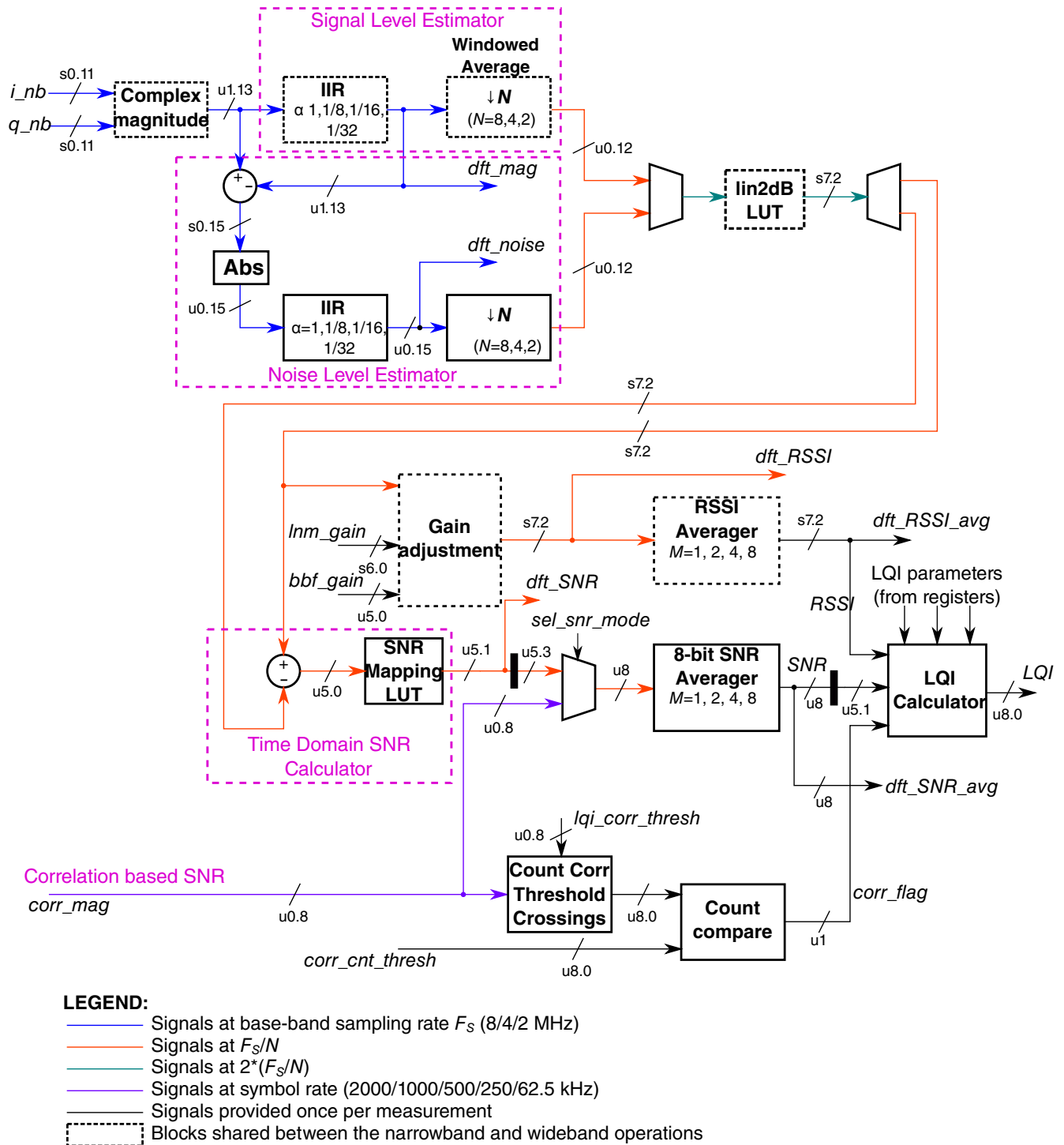

Figure 45-28. Block diagram instantiated for narrowband mode

45.4.3.2.3.2.1 RSSI and SNR estimation

RSSI is estimated in a similar manner as described in [RSSI estimator](#). The downsampling with N block is basically an accumulator. At the end of N accumulated values, it divides the result by N , outputs the result and resets the internal accumulator to 0. In the same manner function the blocks "RSSI Averager" and "SNR Averager" in [Figure 45-28](#).

In order to estimate the SNR, a noise standard deviation estimation is needed. Noise is estimated after taking the absolute value of the subtraction of smoothed magnitude from the magnitude samples. After IIR and downsampling by N of magnitude and noise, conversion from linear domain to dBm is needed. In order to save die-size, "lin2dB" block is shared between the two processing paths by using a synchronous pair MUX/DEMUX. The sampling rate at the input of the "lin2dB" block is doubled due to muxing.

The signal magnitude and noise processing paths are outputting estimates of magnitude and noise respectively, expressed in dBm. The SNR is estimated by subtracting noise from signal. However, an estimation error is present due to the fact that signal and noise are estimated by averaging L1 magnitude samples and not energy values. In order to compensate for this error a non-linear SNR mapping look-up table (block "SNR Mapping LUT") is used in order to map measured SNR to more accurate SNR values. LUT values are specified in [Table 45-23](#). These values have 0.5 dB resolution.

Table 45-23. SNR mapping LUT

| Input value (format (u,5,0)) | Output value (format (u, 5,1)) | Input value (format (u,5,0)) | Output value (format (u, 5,1)) |
|------------------------------|--------------------------------|------------------------------|--------------------------------|
| {0,1,2,...,8} | 0 | 17 | 12 |
| 9 | 1 | 18 | 13.5 |
| 10 | 3 | 19 | 15 |
| 11 | 4.5 | 20 | 16 |
| 12 | 6 | 21 | 17.5 |
| 13 | 7.5 | 22 | 19.5 |
| 14 | 8.5 | 23 | 21.5 |
| 15 | 10 | 24 | 25 |
| 16 | 11 | {25,26,27,...,31} | 26.5 |

After estimating RSSI and SNR the two quantities are passed through the "RSSI Averager" and "SNR Averager" blocks respectively.

45.4.3.2.3.2.2 Correlation flag determination

During the LQI measurement window, a counter is used to count how many times the correlation products, provided at symbol rate, exceed the correlation threshold lqi_corr_thresh . The count is compared with threshold $corr_cnt_thresh$. $corr_cnt_thresh$ takes values between 0 and the maximum number of symbols which can be received within the measurement window.

Table 45-24. Examples of maximum number of symbols in the measurement window

| Protocol | Symbol rate [kHz] | Window duration [μ s] | Maximum $corr_cnt_thresh$ |
|---------------|-------------------|----------------------------|-----------------------------|
| IEEE 802.15.4 | 62.5 | 128 | 8 |
| BLE | 1000 | 32 | 32 |
| FSK-500kbps | 500 | 64 | 32 |

The output of the comparator, $corr_flag$, will take value 0 if $corr_cnt_thresh$ is exceeded and 1 otherwise.

45.4.3.2.3.2.3 LQI calculator

Based on narrow band $RSSI$ (expressed in dBm), SNR (dB) and $corr_flag$, LQI_raw is computed as described in following formula:

$$LQI_raw = (RSSI - Sensitivity) * w_{RSSI} + SNR * w_{SNR} - corr_flag * w_{CorrFlag} + LQI_{bias}$$

Configuration of parameters $Sensitivity$, w_{RSSI} , w_{SNR} and LQI_{bias} is described in [Table 45-19](#). $w_{CorrFlag}$ is a constant and takes value 200.

After computing LQI_raw , the obtained value is saturated to interval [0,255] and then quantized using 8 integer bits. Thus LQI is determined.

45.4.3.2.4 I/Q Mismatch Correction

The I/Q mismatch block corrects for I/Q gain and phase mismatch. It can correct up to +/- 9 degrees of phase mismatch and +/- 4 dB of gain mismatch. After correction, phase mismatch is reduced to less than 0.5 degree and gain mismatch less than 0.3 dB.

During factory calibration, the I/Q phase adjustment coefficient ($iqmc_phase_adj$) and the I/Q gain adjustment coefficient ($iqmc_gain_adj$) are determined. Calibration is enabled by setting the $iqmc_cal_en$ bit. The following values should be used for calibration: $iqmc_num_iter=0x80$, and $rx_dec_filt_osr=2$ (OSR of 16). The $IQMC_CAL$ register should be set to its default value $0x0000_0400$. A CW input with a 250 kHz (+/-75 kHz) offset and -2 dBm (+/- 6 dBm) level at the ADC I channel input is required

for calibration, though the calibration should also work with lower signal levels down to -18 dBm. With the standard number of iterations (`iqmc_num_iter=0x80`), calibration takes approximately 2 ms. After calibration is completed the IQMC_CAL register is updated and the `iqmc_cal_en` bit is cleared automatically. The gain calibration and phase calibration loops are shown in the figures below.

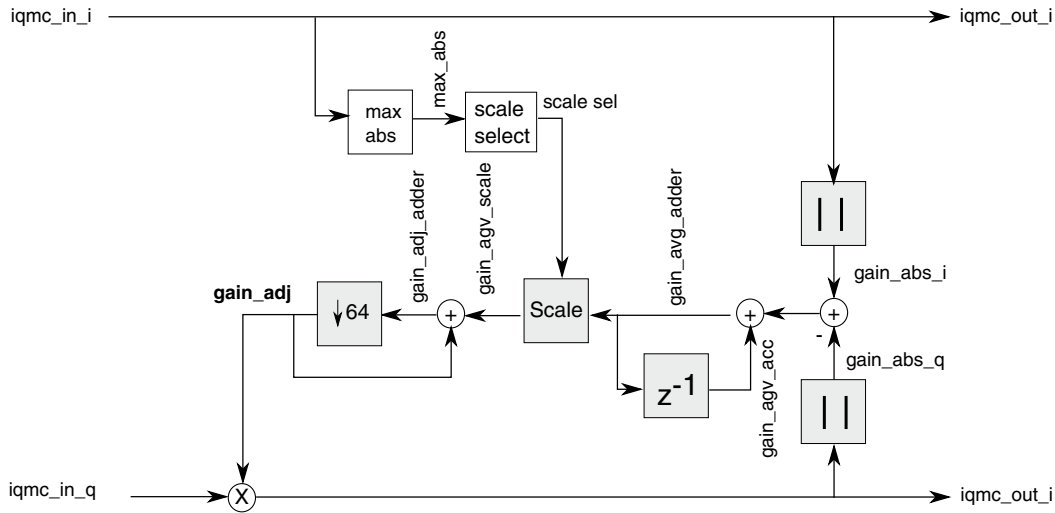

Figure 45-29. I/Q Gain Mismatch Calibration Block Diagram

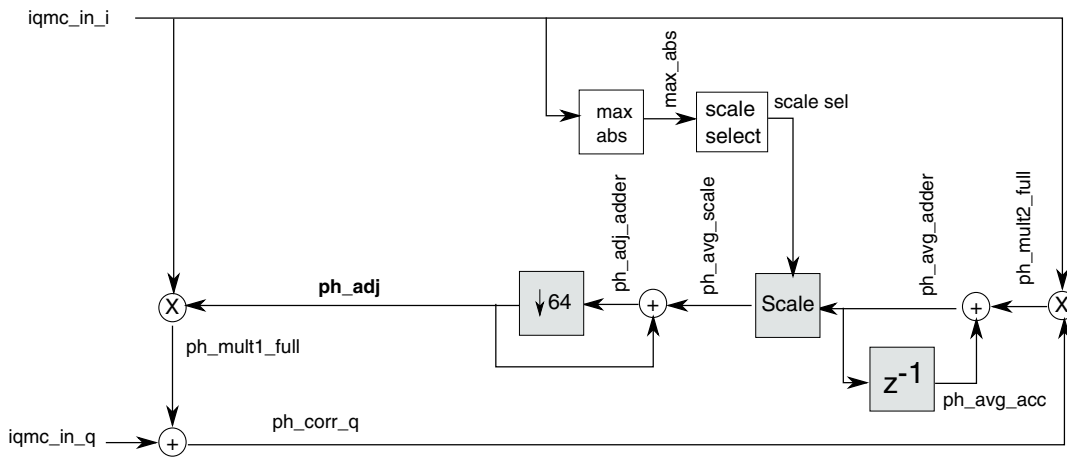

Figure 45-30. I/Q Phase Mismatch Calibration Block Diagram

When the receiver is enabled for packet reception, the calibration loops are disabled and the corrections are static. For gain correction, the Q channel is scaled by the gain adjustment coefficient. For phase correction, the I channel is scaled by the phase

adjustment coefficient and subtracted from the Q channel. The gain and phase correction values are stored in programming model registers and may be stored in flash to eliminate the need to run I/Q mismatch calibration after each reset.

There is also a separate gain adjustment coefficient (`iqmc_dc_gain_adj`) which is used only during DCOC calibration; that is, during the period after the TSM `dcoc_en` is asserted but before the TSM `rx_dig_en` is asserted. The applied phase adjustment coefficient is 0 during this time. There is no hardware calibration support to determine `iqmc_dc_gain_adj`.

The gain and phase corrections are illustrated in the figure below.

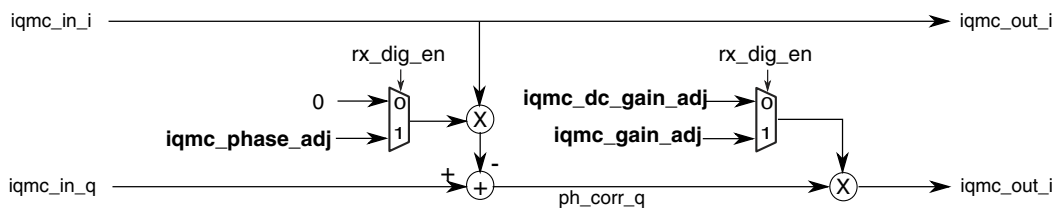

Figure 45-31. I/Q Mismatch Correction Block Diagram

45.4.3.2.5 DC Offset Correction

DC offsets in a direct conversion receiver can originate in RF (e.g., LO leakage, IP2, etc.), baseband (e.g., operational amplifier offsets, mismatches, etc.) and interfaces (due to DC level mismatches between various RF/analog circuits).

The DC (or origin) offset estimation and correction loop comprises of two distinct DC estimators. One of the estimators is used during wake-up calibration of DC offsets, while a second adaptive estimator is used during normal receiver operation. Both DC estimates are computed on the Rx I/Q data after the decimation stage. In the receiver, there are three distinct DC offset correction points, which are at the TZA output, BBA output (after first BBA active filter stage) and in the digital domain after the decimation filter. The DC estimation and correction systems operate as follows:

- A DC offset calibration is carried out at receiver warm-up to compute independent I/Q DC offsets at three distinct RX gain points.
- A DC correction is then estimated for all the entries in the AGC gain table using the 3 calibration estimates. Note that only TZA and BBA DC corrections are stored in the AGC gain lookup table.
- During AGC, the system applies a DC offset correction corresponding to the {LNA, BBA} gain combination that is applied.
- DC tracking estimates are reset upon a gain change and the algorithm is seeded with the calibrated DC estimates corresponding to the active gain setting

- Once AGC gain is settled, DC offset tracking estimation continues for a programmed amount of time
- After a pre-programmed interval expires, the tracked DC offset is sampled and a DC offset correction is estimated and applied
- Based on configuration, the DC offset tracking update can be applied once or iterated upon a programmable number of times.

A block diagram of the RX digital DCOC is shown in the figure below.

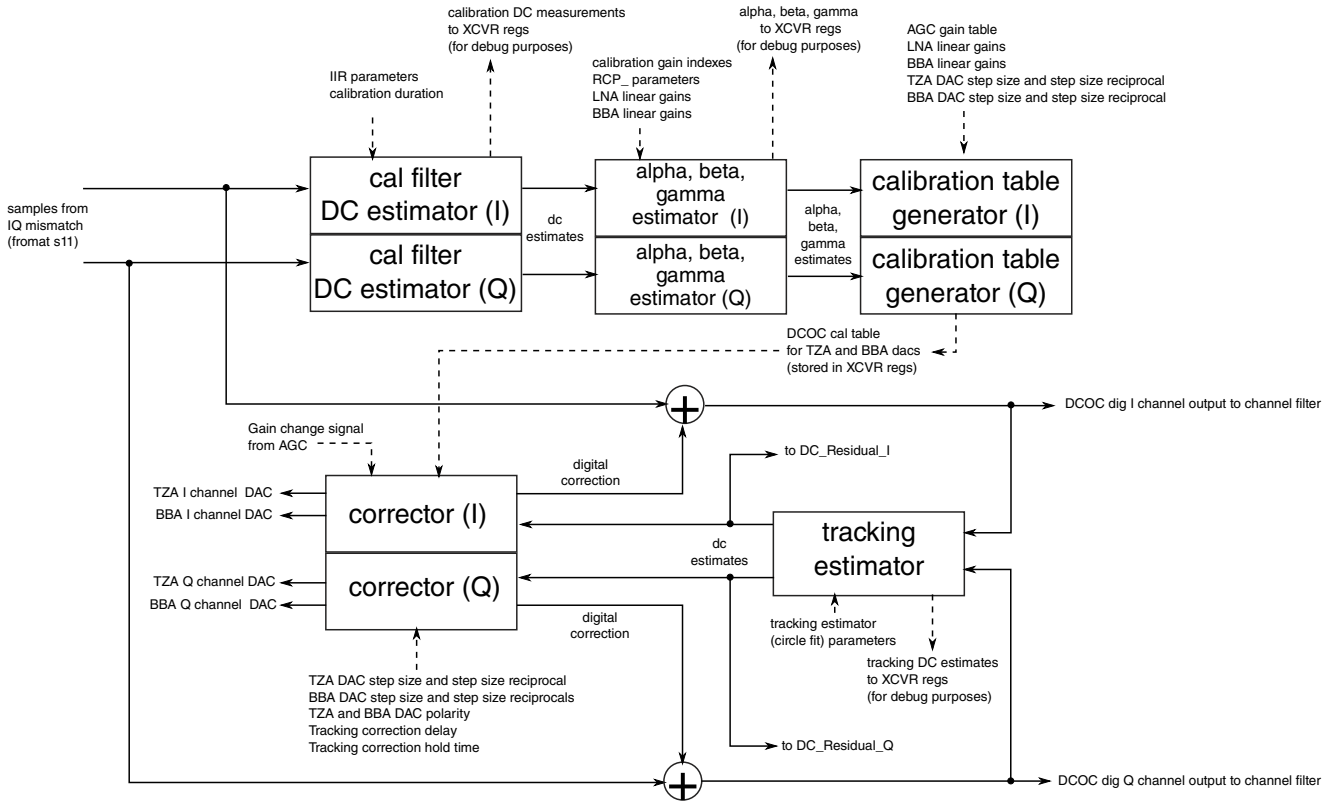

Figure 45-32. RX_DIG DCOC Block Diagram

45.4.3.2.5.1 Operating Modes

The DCOC supports several programmable bits to control the DCOC behavior. The combinations of these control bits which are supported are described in the table below.

Table 45-25. DCOC Operating Modes

| Mode | RX_DCOC_EN | RX_DCOC_CAL_EN | CORRECT_EN | CORRECT_SRC | TRK_FROM_0 | TRK_EST_OVR | MAN |
|-------------------------------------|------------|----------------|------------|-------------|------------|-------------|-----|
| Calibrate and Correct with Tracking | 1 | 1 | 1 | 1 | 0 or 1 | 0 or 1 | 0 |

Table continues on the next page...

Table 45-25. DCOC Operating Modes (continued)

| Mode | RX_ DCOC_EN | RX_DCOC _CAL_EN | CORRECT _EN | CORRECT _SRC | TRK_ FROM_0 | TRK_EST _OVR | MAN |
|--|----------------|--------------------|----------------|-----------------|----------------|-----------------|-----|
| Calibrate and Correct without Tracking | 1 | 1 | 1 | 0 | X | 0 or 1 | 0 |
| Correct with Tracking (no calibration) | 1 | 0 | 1 | 1 | 0 or 1 | 0 or 1 | 0 |
| Correct without Tracking (no calibration) | 1 | 0 | 1 | 0 | X | 0 or 1 | 0 |
| Debug: Calibration only (no correction, no tracking). | 1 | 1 | 0 | X | X | 0 or 1 | 0 |
| Debug: Manual mode (manual DAC values and DCOC_DIG_MAN corrections applied). No calibration, no correction | X | 0 | X | X | X | X | 1 |
| Debug: Tracking estimator enabled; manual DAC values applied. No calibration, no correction | 1 | 0 | 0 | X | 0 or 1 | 1 | 0 |
| DCOC disabled. Manual DAC values applied. No calibration, no correction | 0 | 0 | X | X | X | X | 0 |

45.4.3.2.5.2 DCOC State Diagram

The main states of the DCOC are described in the bullet list and figure below.

- **WAIT (IDLE)**
- **CALIBRATION**. State where DCOC is performing calibration measurements, estimating alpha/beta/gamma, and starts writing the DCOC OFFSET table
- **APPLY_IDX_CAPT**. This state is also associated with calibration. DCOC transitions to this state from CALIBRATION when the table index matches the AGC's starting index. The DCOC values matching this index are applied to the DCOC DACs, and DCOC then finishes writing the rest of the DCOC OFFSET table
- **NO_CAL_INIT**. State where no calibration is performed, but correction is enabled. In this state, the DCOC will output the DCOC DAC values from the DCOC OFFSET table corresponding to the AGC's starting index.
- **CORRECT**. State where the AGC is enabled and DCOC changes the DCOC DAC values when AGC gain changes by reading from the DCOC OFFSET table.
- **CORRECT_AND_TRACK**. Similar to CORRECT state, but the DCOC tracking estimator is also activated, to further refine the DCOC DAC values after an AGC gain change, and also to apply a digital correction to the DCOC output.

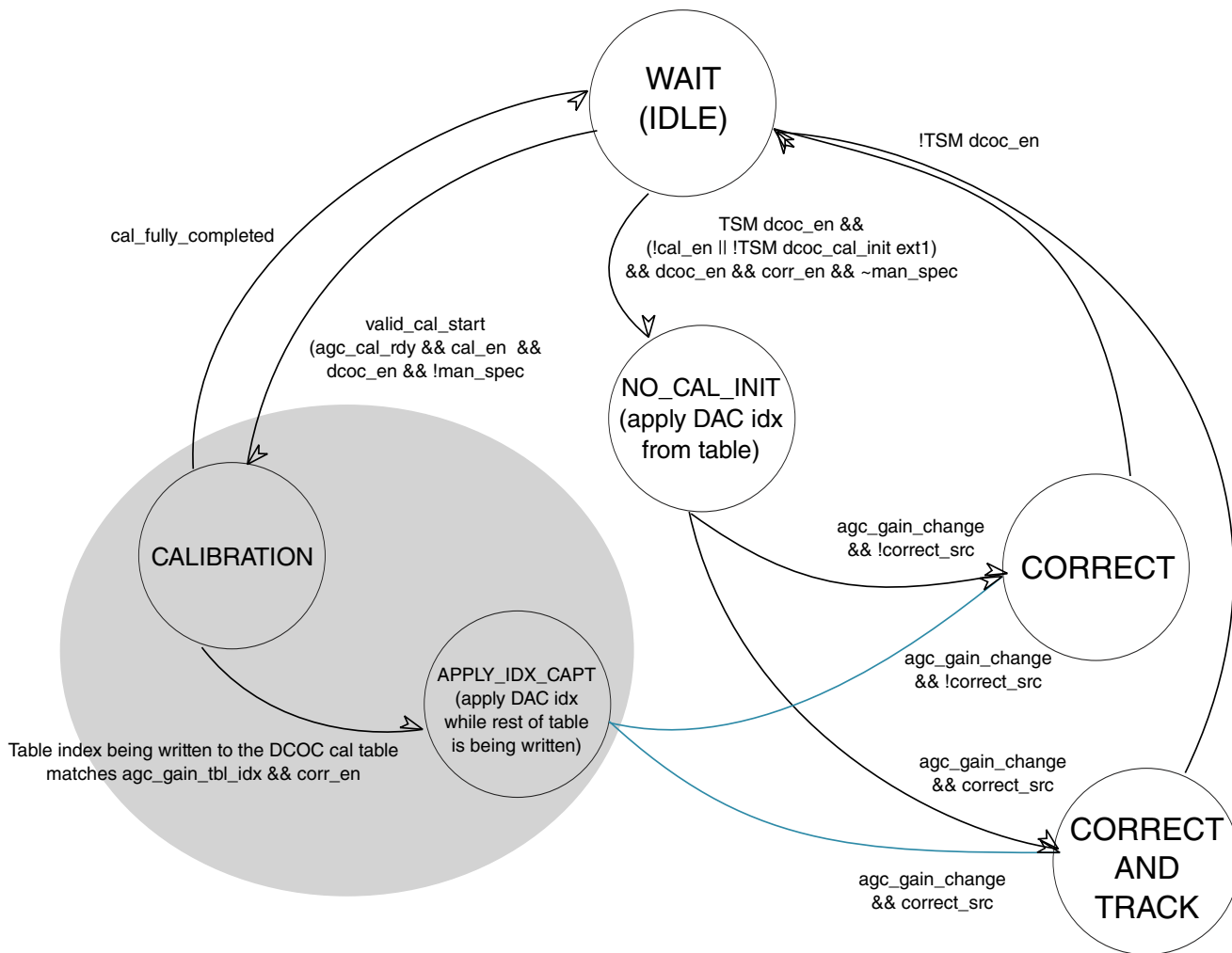

Figure 45-33. DCOC State Diagram

45.4.3.2.5.3 DC Offset Calibration

If the `RX_DIG_CTRL[RX_DCOC_EN]` and `RX_DIG_CTRL[RX_DCOC_CAL_EN]` bits are set, the direct conversion receiver will perform a DC offset calibration for I/Q receive data paths at every RX warm-up. The calibration will compute a table of DC correction values (`DCOC_OFFSET_n` registers) for each of the 27 AGC gain table entries.

The calibration starts when the TSM `DCOC_INIT` signal pulses high then low. The total calibration time includes the time for each of three DC estimates (`DCOC_CAL_DURATION`) and overhead to compute the `DCOC_OFFSET_n` table :

$$\text{calibration time (in } \mu\text{s)} = \frac{3 \cdot \text{DCOC_CTRL}_0[\text{DCOC_CAL_DURATION}] + (4 \cdot 27 + 15)}{\text{reference_clock_frequency}}$$

A value of `DCOC_CAL_DURATION=19` and a reference clock frequency of 32MHz results in a calibration time of 60.8us. The system will operate correctly as long as the calibration completes before the 1us TSM `RX_INIT` pulse completes.

The figure below illustrates the DC Offset Calibration timing. To allow as much time as possible for the DACs to settle before the AGC is enabled, the DCOC will initialize the DACs as soon as it calculates the DCOC table entry corresponding to the initial AGC table index. Normally, the AGC table index begins at 26 (as shown in the figure below), so the DCOC always calculates and writes the DCOC calibration table from index 26 to index 0.

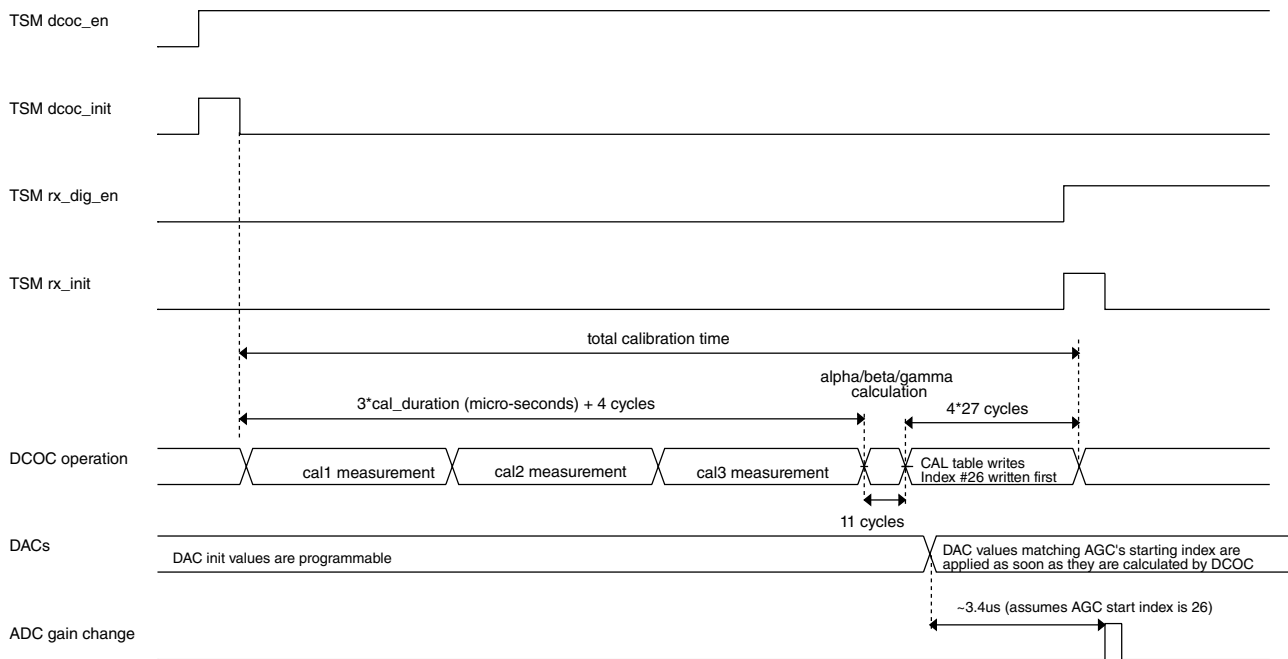

Figure 45-34. DCOC Calibration Timing Diagram

45.4.3.2.5.3.1 DC Offset Estimation during Calibration Phase

During the calibration phase, the DCOC makes DC offset estimates at three distinct RX LNA/BBA gain points. The three gain points are programmed in the `DCOC_CAL_GAIN` register, and are described more in the next section. The duration of the DC offset estimate for each of the 3 gain points is programmable up to 31us as defined by `DCOC_CTRL_0[DCOC_CAL_DURATION]`.

DC offset estimation during calibration is carried out by using a cascade of 3 single-tap IIR filters of the type

$$y_k[n] = (1 - \alpha_k) y_k[n-1] + \alpha_k x_k[n]$$

where α_i are programmable co-efficients assuming values shown below as programmed in the DCOC_CAL_IIR register:

- α_1 : {1, 1/4, 1/8, 1/16}
- α_2 : {1, 1/4, 1/8, 1/16}
- α_3 : {1/4, 1/8, 1/16, 1/32}

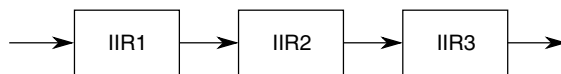

Figure 45-35. DC Offset Estimation using a filter bank during calibration

Using a cascade of 3 IIR filters as shown with $\alpha_1=1/16$; $\alpha_2=1/16$; $\alpha_3=1/16$, the transfer function of the cascaded filter is a narrowband filter with a 3dB bandwidth of approximately 170kHz and a settling time of $< 18\mu\text{s}$.

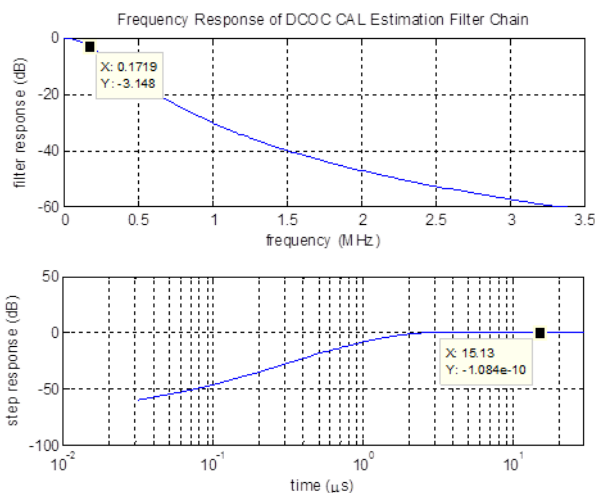

Figure 45-36. Magnitude and Step response of DC Offset Calibration Estimator

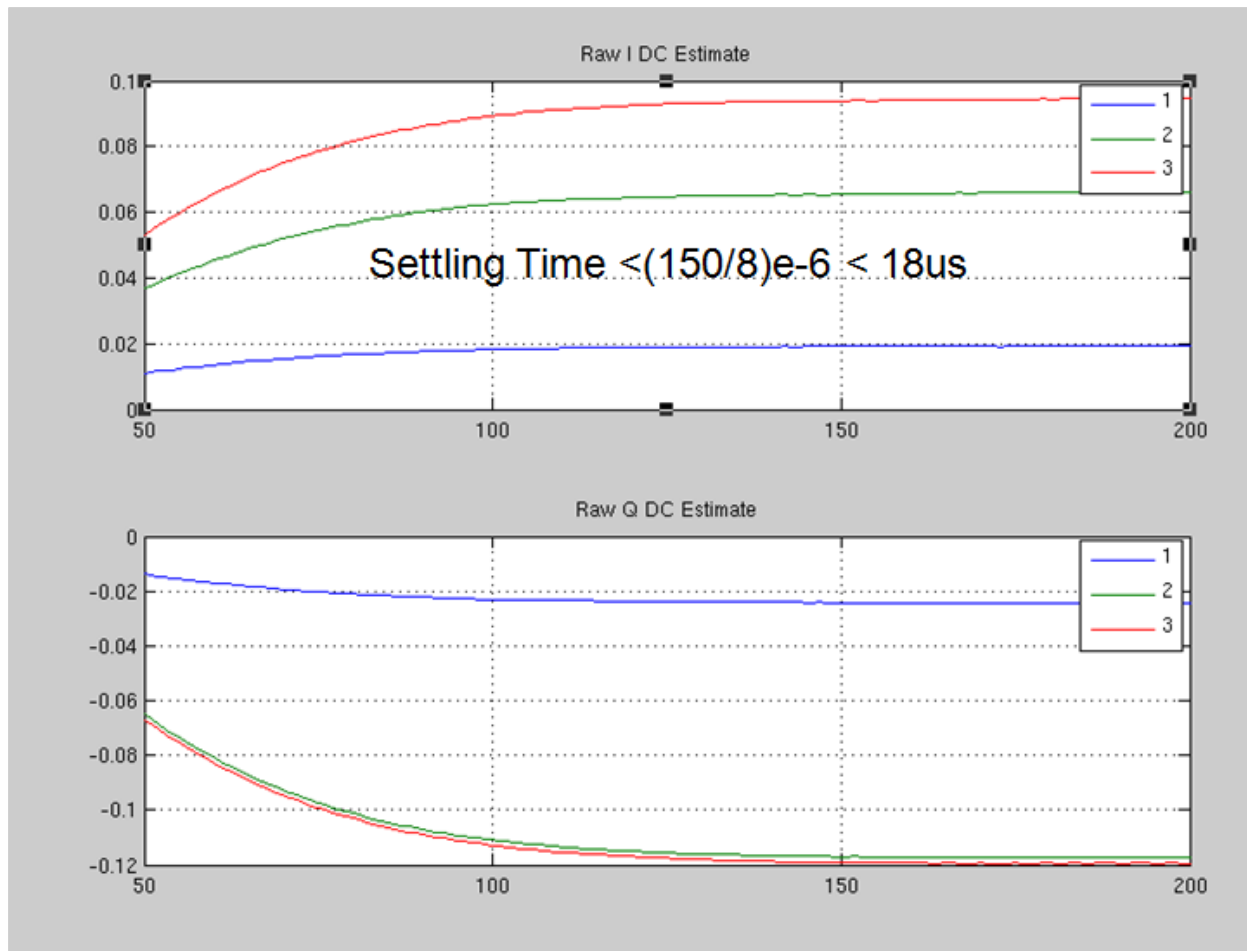

Figure 45-37. 3-step {I,Q} DC estimation during calibration

For debug, the DC offset estimates for the three gain points can be read after calibration from the DCOC_CAL1, DCOC_CAL2, and DCOC_CAL3 registers.

The DCOC operates on the decimated output of the ADC. As BTLE and 802.15.4 have different oversample rates, different IIR filter settings are expected to be used assuming a settling time of 20 μ s is desired. The table below shows sets of IIR1/2/3 parameters for BTLE and 802.15.4 :

- BTLE: $\alpha_1 = 1/8$, $\alpha_2 = 1/16$, $\alpha_3 = 1/16$
- 802.15.4: $\alpha_1 = 1/4$, $\alpha_2 = 1/8$, $\alpha_3 = 1/8$

45.4.3.2.5.3.2 DC Estimation at 3 operation gain points of the receiver

The ZIF receiver performs a 3 point DC Offset calibration. The calculations shown below are shown for one branch of Rx (I or Q) only. In hardware the calculations are carried out independently for both I and Q branches and stored independently in the AGC/DCOC lookup table

The DC offset calibration scheme approximates the DC offset behavior of the system observed at three distinct gain settings by calculating the DC offset for the three gain points, and decomposing the correction into 3 DC components, which are

- α - An RF component (such as LO feed through), which scales with both LNA and BBA gains
- β - A TZA DC offset which scales with BBA gains
- γ - represents an un-scaled DC offset at the ADC input

These DC components are illustrated in the figure below.

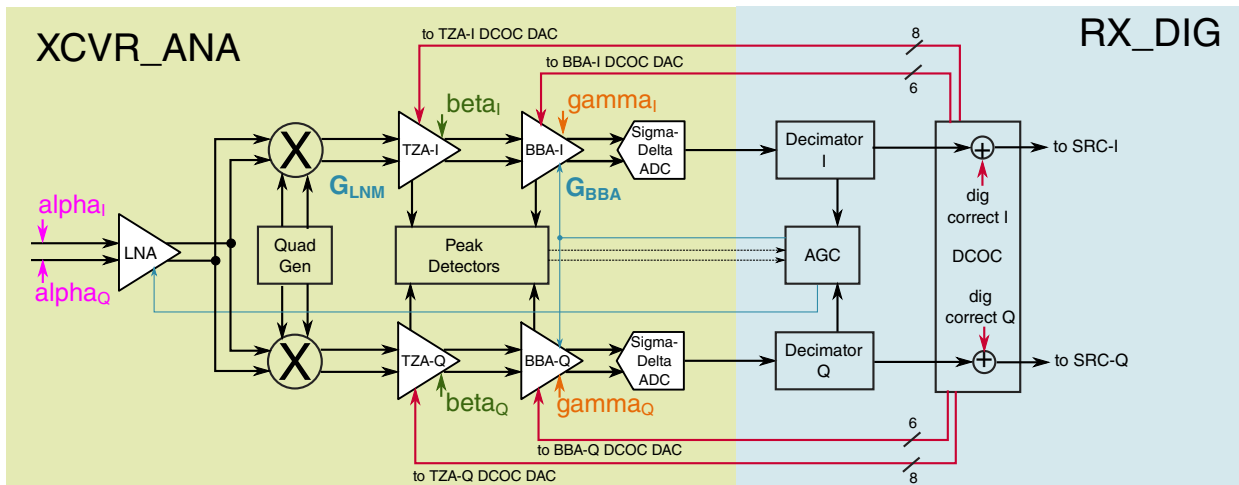

Figure 45-38. Receiver model showing three contributors of DC offset

The DC offset correction after calibration is applied at 2 points in the receiver, which are at

- the TZA output using an 8-bit DAC with $LSB = 1.2V/2^7 * (22.9k\Omega/34k\Omega) = 6.31mV$
- the BBA output using a 6-bit DACs with $LSB = 1.2V/2^5 * (63.44k\Omega/120k\Omega) = 19.83mV$

Calibration is performed open-loop. During calibration, the DCOC normally measures the DC values while the DACs are set to apply an offset of 0V. However, other DAC values can be used during calibration by using the TZA_DCOC_INIT_Q/I and BBA_DCOC_INIT_Q/I bitfields.

NOTE

The equations below are for the case when the TZA_DCOC_INIT_Q/I and BBA_DCOC_INIT_Q/I use their default reset values (which represent DAC values of 0). The $\hat{\alpha}$ / $\hat{\beta}$ / $\hat{\gamma}$ calculations in the RTL also support the scenario where non-default values are used; in that case, the $\hat{\alpha}$ -

$\hat{\alpha}/\hat{\beta}/\hat{\gamma}$ are calculated such they should yield the same estimates as if DAC values of 0 were used.

The equations below provide the calculations from 3 distinct DC offset measurements to the estimation of the three decomposed DC offset components.

At any given time, the total DC offsets observed at ADC input would follow the formula

$$\text{RxDcOC_pre_ADC} \cong (\alpha * G_L + \beta) * G_B + \gamma$$

where

- G_L – Voltage gain of the LNA stage (in linear domain)
- G_B – Voltage gain of the BBA stage (in linear domain)

The ADC has an effective gain of 1code/1.7V. In the decimator, there is a decimation-rate-dependent gain factor, and also a programmable gain factor as described in [Decimation Filter](#). Let ADC_gain represent the combined gain through the ADC and decimator in terms of codes/mV:

$$\text{ADC_gain} = 1/1700\text{mV} * (\text{OSR}^4) * (\text{OSR_scale_factor}) * \text{RX_DEC_FILT_GAIN} / 2$$

For example, if OSR is 8 (OSR_scale_factor is therefore 2^0 as shown in [Table 45-16](#)) and RX_DEC_FILT_GAIN is programmed for a gain of 1.6875, ADC_gain is 2.033codes/mV.

Note that the ADC_gain factor is a component of the value programmed for the BBA_DCOC_STEP, BBA_DCOC_STEP_RECIP, DCOC_TZA_STEP_GAIN, and DCOC_TZA_STEP_RECIP bitfields.

NOTE

The DCOC calibration actually performs slightly better when the ADC_gain factor shown above is multiplied by a scaling factor of ~0.96; this is due to the fixed point arithmetic implementation of the calibration algorithm. The scaling factor effectively causes the calibration algorithm to compute slightly larger TDAC and BDAC values (see below) than it would otherwise calculate.

The total DC offset observed at the RxDcOC is

$$\text{RxDcOC_post_ADC} \cong \text{ADC_gain} * ((\alpha * G_L + \beta) * G_B + \gamma)$$

The DC offset calibration is carried at three distinct {LNA, BBA} gain settings, as summarized below.

Table 45-26. DC offset calibration at selected {LNA,BBA} gain settings

| DCOC_CAL | LNA linear gain (V/V) | BBA linear gain (V/V) | DC offset Measured at ADC input |
|----------|-----------------------|-----------------------|---|
| DCOC[1] | G_{L_LO} | G_{B_LO} | $ADC_gain * ((\alpha * G_{L_LO} + \beta) * G_{B_LO} + \gamma)$ |
| DCOC[2] | G_{L_HI} | G_{B_LO} | $ADC_gain * ((\alpha * G_{L_HI} + \beta) * G_{B_LO} + \gamma)$ |
| DCOC[3] | G_{L_LO} | G_{B_HI} | $ADC_gain * ((\alpha * G_{L_LO} + \beta) * G_{B_HI} + \gamma)$ |

The three gain point settings are defined by programming the DCOC_CAL_GAIN register. Here is an example:

Table 45-27. Example DCOC_CAL_GAIN programming

| DCOC_CAL | DCOC LNA CAL GAIN index | DCOC BBA CAL GAIN index |
|----------|--|---|
| DCOC[1] | 3 (corresponds to G_{L_LO} of 15dB) | 5 (corresponds to G_{B_LO} of 15dB) |
| DCOC[2] | 6 (corresponds to G_{L_HI} of 33dB) | 5 (corresponds to G_{B_LO} of 15dB) |
| DCOC[3] | 3 (corresponds to G_{L_LO} of 15dB) | 10 (corresponds to G_{B_HI} of 30dB) |

Calculations of estimates for α , β and γ are carried out post ADC, i.e., ADC_gain is used implicitly in calculations.

Using [1] & [2]

$$\hat{\alpha} = \alpha * ADC_gain = (DCOC[2] - DCOC[1]) * [1.0 / ((G_{L_HI} - G_{L_LO}) * G_{B_LO})] \quad [4]$$

Using eq. [1] & eq. [3]

$$\begin{aligned} DCOC_tmp &= (\hat{\alpha} * G_{L_LO} + \hat{\beta}) * ADC_gain \\ &= (DCOC[3] - DCOC[1]) * [1.0 / (G_{B_HI} - G_{B_LO})] \end{aligned} \quad [5]$$

Normally, the TZA_DCOC_INIT bitfield is left at its default value of 0x80 in which case the TZA DCOC DAC applies an offset of 0V. In this case, using eq. [4] & eq. [5]

$$\hat{\beta} = \beta * ADC_gain = [5] - [4] * G_{L_LO} \quad [6]$$

To account for scenarios where TZA_DCOC_INIT is not 0x80, equation [6] can be generalized as shown below to subtract the contribution from the TZA DCOC DAC. In equation [6a], "tza_dac_sign" is +1 if DCOC_CTRL_0[TZA_CORR_POL] is clear, and -1 if it is set.

$$\hat{\beta} = \beta * ADC_gain = [5] - [4] * G_{L_LO} - (TZA_DCOC_INIT - 0x80) * TZA_dcoc_step_norm * tza_dac_sign \quad [6a]$$

Likewise, the BBA_DCOC_INIT bitfield is normally left at its default value of 0x20 in which case the BBA DCOC DAC applies an offset of 0V. In this case using eq. [5] & eq. [3]

$$\hat{\gamma} = \gamma * ADC_gain = [3] - [5] * G_{B_HI} \quad [7]$$

To account for where scenarios where BBA_DCOC_INIT is not 0x20, equation [7] can be generalized as shown below to subtract the contribution from the BBA DCOC DAC. In equation [7a], "bba_dac_sign" is +1 if DCOC_CTRL_0[BBA_CORR_POL] is clear, and -1 if it is set.

$$\gamma\text{-hat} = \gamma * \text{ADC_gain} = [3] - [5] * G_{B_HI} - (\text{BBA_DCOC_INIT} - 0x20) * \text{BBA_dcoc_step} * \text{bba_dac_sign} \quad [7a]$$

After calibration, $\alpha\text{-hat}$, $\beta\text{-hat}$, and $\gamma\text{-hat}$ can be read from the DCOC_CAL_ALPHA, DCOC_CAL_BETA, and DCOC_CAL_GAMMA registers, respectively for debug purposes.

To perform the $\alpha\text{-hat}/\beta\text{-hat}/\gamma\text{-hat}$ calculations, the DCOC also uses the following register bitfields:

- DCOC_CAL_RCP[ALPHA_CALC_RECIP]. This is the $1.0/((G_{L_HI} - G_{L_LO}) * G_{B_LO})$ factor from equation [4] above.
- DCOC_CAL_RCP[DCOC_TMP_CALC_RECIP]. This is the $1.0/(G_{B_HI} - G_{B_LO})$ factor from equation [5] above.
- LNA_GAIN_LIN_VAL_x (LNA_GAIN_LIN_VAL_x_y registers). The G_{L_LO} and G_{L_HI} gains are found from the appropriate index into this table.
- BBA_RES_TUNE_LIN_VAL_x (BBA_RES_TUNE_LIN_VAL_x_y registers). The G_{B_LO} and G_{B_HI} gains are found from the appropriate index into this table.
- DCOC_CTRL_0[TZA_CORR_POL] bit determines the polarity of the TZA DCOC DAC value applied during calibration.
- DCOC_CTRL_0[BBA_CORR_POL] bit determines the polarity of the BBA DCOC INIT DAC value applied during calibration.

45.4.3.2.5.3.3 Calculation of DC Offset Table

Once the estimates for α , β and γ , that is, $\alpha\text{-hat}$, $\beta\text{-hat}$ and $\gamma\text{-hat}$ are computed, the calibrated DC offset correction values for the 27 entries in the AGC gain table (AGC_GAIN_TBL_xx_yy registers) can be calculated and stored (in the DCOC_OFFSET_n registers).

The calculations are independently carried out for both the I/Q branches of the transceiver but only one branch is shown below. The computations are as follows for all $k=26, 25, \dots, 0$ entries of the AGC_GAIN_TBL, and where TDAC_k and BDAC_k represent the TZA and BBA DAC values:

$$\begin{aligned} \text{DCOC_TZA_TOTAL} &= \alpha\text{-hat} * G_{Lk} + \beta\text{-hat} \\ \text{TDAC}_k &= \text{round}(\text{DCOC_TZA_TOTAL} * [1.0/\text{TZA_dcoc_step_norm}]) \\ \text{DCOC_TZA_RESIDUAL} &= \text{DCOC_TZA_TOTAL} - \text{TDAC}_k * \text{TZA_dcoc_step_norm} \\ \text{DCOC_BBA_TOTAL} &= \text{DCOC_TZA_RESIDUAL} * G_{Bk} + \gamma\text{-hat} \\ \text{BDAC}_k &= \text{round}(\text{DCOC_BBA_TOTAL} * [1.0/\text{BBA_dcoc_step}]) \end{aligned}$$

| Information derived from the programmable AGC_GAIN_TBL_xx_yy registers | | Computed and stored in the DCOC_OFFSET_n registers | | | |
|--|-----------------------|--|---------------------|---------------------|---------------------|
| LNA linear gain (V/V) | BBA linear gain (V/V) | TZA-I DAC code | BBA-I DAC Code | TZA-Q DAC code | BBA-Q DAC Code |
| G_{L26} | G_{B26} | TDAC _{I26} | BDAC _{I26} | TDAC _{Q26} | BDAC _{Q26} |
| ... | ... | ... | ... | ... | ... |
| G_{L0} | G_{B0} | TDAC _{I0} | BDAC _{I0} | TDAC _{Q0} | BDAC _{Q0} |

Note that the values stored in the DCOC_OFFSET_n table represent the DC offset at the DAC. Normally the DCOC will then apply the negative of this DC offset to the DAC when it applies the correction, but this depends on the DCOC_CTRL_0[TZA_CORR_POL] and DCOC_CTRL_0[BBA_CORR_POL] bits. Also, note that the DAC code values themselves (which are reflected in the DCOC_STAT register) include a bias offset of 0x80 for the TZA DACs and 0x20 for the BBA DACs.

To compute the TDAC and BDAC values for the DCOC_OFFSET_n registers, the DCOC uses the following register bitfields:

- DCOC_BBA_STEP[BBA_DCOC_STEP_RECIP]. This is the 1.0/BBA_dcoc_step referred to above.
- DCOC_TZA_STEP_0[DCOC_TZA_STEP_RCP]. This is the 1.0/TZA_dcoc_step_norm referred to above.
- DCOC_TZA_STEP_0[DCOC_TZA_STEP]. This is the TZA_dcoc_step_norm referred to above.
- LNA_GAIN_LIN_VAL_x (LNA_GAIN_LIN_VAL_x_y registers). This is used for the G_{Lk} referred to above
- BBA_RES_TUNE_LIN_VAL_x (BBA_RES_TUNE_LIN_VAL_x_y registers). This is used for the G_{Bk} referred to above
- RF_TZA[RX_TZA_SPARE]. The RX_TZA_SPARE[2] bit specifies the allowed range of values for the TZA DCOC DAC.

45.4.3.2.5.3.4 Use of DC offset Table After Calibration

After calibration, when the TSM_RX_DIG_EN is asserted, if the DCOC_CTRL_0[DCOC_CORRECT_EN] bit is 1, the DCOC will apply the value stored in the DCOC_OFFSET_n table on each AGC gain change. As indicated previously, the value stored in the DCOC_OFFSET_n register represents the DAC value of the DC offset.

If the DCOC_CTRL_0[TZA_CORR_POL] bit is clear (normal polarity), the DCOC will subtract the TDAC value from the TZA DAC zero bias value of 0x80. If the TZA_CORR_POL bit is set, the DCOC will add the TDAC value to the TZA DAC zero bias value.

If the DCOC_CTRL_0[BBA_CORR_POL] bit is clear (normal polarity), the DCOC will subtract the BDAC value from the BBA DAC zero bias value of 0x20. If the BBA_CORR_POL bit is set, the DCOC will add the BDAC value to the BBA DAC zero bias value.

The DCOC also allows software to write to the DCOC_OFFSET_n table. In this case, the RX_DIG_CTRL[RX_DCOC_CAL_EN] bit should be cleared so that the DCOC will not overwrite the DCOC_OFFSET_n table, but DCOC_CTRL_0[DCOC_CORRECT_EN] bit should still be set.

45.4.3.2.5.4 DC Offset Tracking

The DCOC also supports a closed-loop DC tracking estimator which can be used with or without DC Offset calibration. The tracking estimator applies a DAC correction and also applies a digital correction to the downsampled output of the ADC.

The tracker is used if the DCOC_CTRL_0[DCOC_CORRECT_SRC] bit is programmed to 1 (RX_DIG_CTRL[RX_DCOC_EN] and DCOC_CTRL_0[DCOC_CORRECT_EN] should also be programmed to 1). The tracking estimator operation is as follows:

- On every AGC gain change, the DCOC will apply the DC offset correction to the DACs from the DCOC_OFFSET_n table, and resets the digital correction to zero.
- If the AGC gain table index is larger than or equal to DCOC_CTRL_1[DCOC_TRK_MIN_AGC_IDX], then...
 - After the AGC gain settles (refer to AGC_CTRL_1[LNA_GAIN_SETTLE_TIME] and AGC_CTRL_2[BBA_GAIN_SETTLE_TIME] bitfields) , the tracker's estimate is reset to either 0 or the current I/Q sample, depending on programming of the DCOC_CTRL_0[TRACK_FROM_ZERO] bit.
 - The DCOC will periodically adjust the DACs and digital correction at intervals defined by the DCOC_CTRL_0[DCOC_CORR_DLY] bitfield until a timeout defined by the DCOC_CTRL_0[DCOC_CORR_HOLD_TIME] bitfield is reached.
 - The tracking estimator supports two set of parameters so that estimator can be gearshifted from a high bandwidth to a narrow bandwidth configuration after a

- number of update corrections defined by DCOC_CTRL_1[DCOC_TRK_EST_GS_CNT].
- If the DCOC_CTRL_0[DCOC_MIDPWR_TRK_DIS] bit is set, the tracking corrections are disabled if either the TZA or BBA lo peak detector asserts. This is implemented by resetting the counters associated with DCOC_CORR_DLY and DCOC_HOLD_TIME, so if the lo peak detectors stop asserting, then tracking corrections would be resumed. The counter associated with DCOC_TRK_EST_GS_CNT is not affected by the DCOC_MIDPWR_TRK_DIS bit.
- If the AGC gain table index is smaller than DCOC_CTRL_1[DCOC_TRK_MIN_AGC_IDX], then tracking is not activated for this gain setting.

The figure below illustrates the timing behavior during DC offset tracking correction after an AGC gain change. If the DCOC_CTRL_0[DCOC_CORRECT_SRC] bit were programmed to 0 instead of 1, only the DCOC DAC change at agc_gain_chng pulse would occur and the digital correction applies to the signal through the DCOC would remain at 0. The figure shows an example where DCOC_TRK_EST_GS_CNT=2, so the tracking estimator changes its parameters after 2 update correction periods.

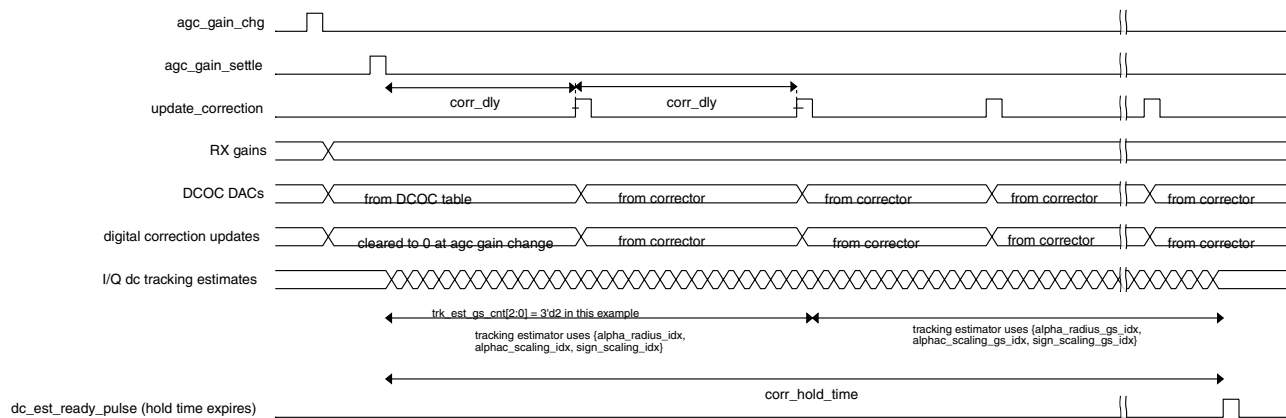

Figure 45-39. DC Offset Tracking Correction Timing

45.4.3.2.5.4.1 DC Offset Estimation during Tracking Phase

There are two distinct DC offset estimators: the one use during calibration described previously, and one used for DC tracking during normal receiver operation.

DC Offset estimation during normal receiver operation requires estimation of DC signal in the presence of a constant envelope modulation signal. A circle-fit type of algorithm is used for DC estimation in the presence of desired as well as interfering signals.

The circle-fit algorithm relies on the programmable bitfields shown in the list below. Note that there are two sets of `alpha_radius`, `alphac_scale`, and `sign_scale` parameters, which allows the algorithm to gearshift from a high-bandwidth configuration {`alpha_radius_idx`, `alphac_scale_idx`, `sign_scale_idx`} to a low-bandwidth configuration {`alpha_radius_gs_idx`, `alphac_scale_gs_idx`, `sign_scale_gs_idx`} after the number of update corrections defined by `DCOC_TRK_EST_GS_CNT`.

- `DCOC_CTRL_1[DCOC_ALPHA_RADIUS_IDX]` and `DCOC_CTRL_1[DCOC_ALPHA_RADIUS_GS_IDX]`. Step size for radius, assumes values of {1, 1/2, 1/4, 1/8, 1/16, 1/32, or 1/64}. In pseudo-code below, this is referred to as "alpha_radius".
- `DCOC_CTRL_1[DCOC_ALPHAC_SCALE_IDX]` and `DCOC_CTRL_1[DCOC_ALPHAC_SCALE_GS_IDX]`. Step size for I/Q center, assumes values of {1/2, 1/4, 1/8, 1/16, 1/32 or 1/64}. In pseudo-code below, this value times the "alpha_radius" value is referred to as "alpha_center"
- `DCOC_CTRL_1[DCOC_SIGN_SCALE_IDX]` and `DCOC_CTRL_1[DCOC_SIGN_SCALE_GS_IDX]`. `sign_scaling`. Scaling factor for `sign()` based correction of the I/Q center, assumes values of {1/8, 1/16, 1/32, or 1/64}. In psuedo-code below, this is referred to as "sign_scaling".
- `DCOC_CTRL_1[DCOC_TRK_EST_GS_CNT]`. If this is 0, then the algorithm only uses the {`alpha_radius_idx`, `alphac_scale_idx`, `sign_scale_idx`} parameters above. Otherwise, the algorithm begins with the {`alpha_radius_idx`, `alphac_scale_idx`, `sign_scale_idx`} parameters after each AGC gain change, but then switches to the 2nd parameter set {`alpha_radius_gs_idx`, `alphac_scale_gs_idx`, `sign_scale_gs_idx`} after `DCOC_TRK_EST_GS_CNT` number of update correction periods.
- `DCOC_CTRL_0[TRACK_FROM_ZERO]`. This control bit determines the initial value used by the tracking estimator on each AGC gain change. If `TRACK_FROM_ZERO=1`, the tracking estimate starts from `I/Qcenter=0`; if `TRACK_FROM_ZERO=0`, the tracking estimator starts from I/Qcenter using the current I/Q sample. `TRACK_FROM_ZERO=1` can be used in conjunction with calibration, whereas `TRACK_FROM_ZERO=0` can be used with or without calibration and also works well at a wider range of RSSI levels.

Pseudo-code for the circle-fit algorithm in the tracking estimator is as follows:

```

epsilon_I = I - Icenter;
epsilon_Q = Q - Qcenter;
i_abs = abs(epsilon_I);
q_abs = abs(epsilon_Q);
delta_radius = max(i_abs,q_abs)+min(i_abs,q_abs)*3/8;
delta_Icenter = I - Radius*sign(epsilon_I)*sign_scaling;
delta_Qcenter = Q - Radius*sign(epsilon_Q)*sign_scaling;
Icenter = alpha_center*delta_Icenter + (1 - alpha_center)*Icenter;
Qcenter = alpha_center*delta_Qcenter + (1 - alpha_center)*Qcenter;
Radius = alpha_radius*delta_radius + (1 - alpha_radius)*Radius;

```

For debug, the tracker's DC estimate (`Icenter`, `Qcenter`) can be read from the `DCOC_DC_EST` register.

The DC correction applied by the tracking algorithm makes use of the following register bitfields:

- DCOC_BBA_STEP[BBA_DCOC_STEP].
- DCOC_BBA_STEP[BBA_DCOC_STEP_RECIP].
- DCOC_TZA_STEPn[TZA_DCOC_STEP], where n=0..10.
- DCOC_TZA_STEPn[TZA_DCOC_STEP_RECIP], where n=0..10.
- DCOC_CTRL_0[TZA_CORR_POL]
- DCOC_CTRL_0[BBA_CORR_POL]
- RF_TZA[RX_TZA_SPARE]. The RX_TZA_SPARE[2] bit specifies the allowed range of values for the TZA DCOC DAC.

Normally, the tracking estimator is only enabled when it is needed by the corrector. However, by setting the DCOC_CTRL_0[TRK_EST_OVR] bit, the tracking estimator can be enabled continuously while the DCOC is active.

45.4.3.2.5.5 DC Offset Manual Mode

For debug purposes, the DCOC supports a manual mode. This mode is enabled when the DCOC_CTRL_0[DCOC_MAN] bit is set, which overrides all other DCOC programmable control bits. In this mode, the DCOC DAC values are applied from DCOC_DAC_INIT[TZA_DCOC_INIT_Q], DCOC_DAC_INIT[TZA_DCOC_INIT_I], DCOC_DAC_INIT[BBA_DCOC_INIT_Q], and DCOC_DAC_INIT[BBA_DCOC_INIT_I], and the digital correction is applied from DCOC_DIG_MAN[DIG_DCOC_INIT_Q] and DCOC_DIG_MAN[DIG_DCOC_INIT_I].

45.4.3.2.6 Channel Filter

The channel filter is a programmable, 24 tap symmetric FIR filter with 6-bit to 10-bit coefficients. It operates at the decimated sample rate on the output from the DCOC. The coefficient values are programmable and should be configured for the mode of operation (BTLE, 802.15.4, Generic LL). The filter output is scaled by 1/256; the sum of the 12 coefficients programmed is expected to be ≤ 256 in order to avoid saturation. A few example coefficient filter sets are given in the table below.

Table 45-28. Channel Filter Coefficients for 32MHz XO

| Coefficient Register | Format | BTLE | 802.15.4 |
|----------------------|--------|------|----------|
| RX_CHF_COEF0 | s5 | 4 | 3 |
| RX_CHF_COEF1 | s5 | 5 | 10 |
| RX_CHF_COEF2 | s6 | 2 | -16 |
| RX_CHF_COEF3 | s6 | -6 | -9 |

Table continues on the next page...

Table 45-28. Channel Filter Coefficients for 32MHz XO (continued)

| Coefficient Register | Format | BTLE | 802.15.4 |
|----------------------|--------|------|----------|
| RX_CHF_COEF4 | s6 | -17 | 37 |
| RX_CHF_COEF5 | s6 | -26 | -12 |
| RX_CHF_COEF6 | s7 | -25 | -57 |
| RX_CHF_COEF7 | s7 | -8 | 61 |
| RX_CHF_COEF8 | s8 | 24 | 63 |
| RX_CHF_COEF9 | s8 | 66 | -156 |
| RX_CHF_COEF10 | s9 | 105 | -54 |
| RX_CHF_COEF11 | s9 | 129 | 385 |

45.4.3.2.7 Sample Rate Conversion (SRC) Filter

The sample rate conversion block is used for a fractional clock rate conversion of the sampled decimated signal, when 26MHz reference clock is used. In this mode, the ADC is clocked at $2 \times F_{ref}$ or 52 MHz. For the 2.4GHz targeted modulations, the PHY data rate is always 8x the symbol rate (of 1Mbps, 500kbps or 250kbps) for (G)FSK modes and 4x the 2Mchips/sec rate for IEEE 802.15.4. These desired frequencies are not related to the ADC clock rate by an integer factor, which necessitates the need for a fractional sample rate conversion that is performed by SRC. For a complete list of the fractional conversion modes, Refer to [Table 45-15](#). The SRC is enabled by setting `RX_DIG_CTRL[RX_SRC_EN]` to 1, and the conversion factor is selected by `RX_DIG_CTRL[RX_SRC_RATE]` as described below.

45.4.3.2.7.1 Sample Rate Conversion by a factor of 8/13

If `RX_DIG_CTRL[RX_SRC_RATE] = 0`, the SRC block is configured to perform a data rate conversion by a factor of 8/13, i.e., for every 13 input samples, the SRC block generates 8 output samples at a reduced data rate. A linearly interpolated first order hold (FOH) resampler is used for implementation as it provides significant better anti-aliasing as compared to a zero order hold (ZOH).

45.4.3.2.7.2 Sample Rate Conversion by a factor of 12/13

If `RX_DIG_CTRL[RX_SRC_RATE] = 1`, the SRC block is configuration a zero-order hold sample rate conversion is used. This mode is realized by skipping one out of every 13 input samples.

45.4.3.2.8 DC Residual Correction

This block is used to compensate for the DC offset which is still present after AGC and DCOC calibration/tracking has completed. It estimates the DC offset by measuring the minimum and maximum value and then applies an additive correction factor to the I and Q channels. This block does not change the value of the DCOC DACs.

The DC offset is compensated independently on I and Q channels. The correction loop determines the minimum and maximum values over a specified window of samples (N_{win}) which are then averaged and used (with an update parameter $Alpha$) to create the DC estimate. This DC estimate is then subtracted from the input samples. The applied DC estimate continues to be updated every $NWIN$ samples until IT_FREEZE of these windows have elapsed, at which time the DC estimate is frozen.

Multiple modes of operations can be identified for residual DC offset compensation block. They are presented in table below.

Table 45-29. Residual DC offset compensation operational modes

| Mode | Description | DC_RESID_EN | EXT_DC_EN | IT_FREEZE | DLY | NWIN, ALPHA |
|---------------|--|-------------|-----------|-----------|-----|-------------------|
| Bypass | The DC residual is disabled. The input I and Q samples to the DC Residual block are passed directly to the DC Residual output without any modifications. | 0 | - | - | - | - |
| Mode 1 | In this mode, DC residual has the role of calculating and applying a DC offset without use of an initial estimate from the DCOC. The DC residual processing is restarted at every AGC gain change This mode is suitable for use when an AGC gain change occurs which is not followed by DCOC tracking. | 1 | 0 | >1 | >0 | program as needed |
| Mode 2 | In this mode, DC residual has the role of refining the DC offset estimate provided by the DCOC at the end of the DCOC tracking after the last DCOC DAC update. The DC residual processing is restarted whenever DCOC's tracking hold timer expires. | 1 | 1 | >1 | - | program as needed |

Table continues on the next page...

Table 45-29. Residual DC offset compensation operational modes (continued)

| | | | | | | |
|---------------|---|---|---|---|---|---|
| | This mode is suitable after AGC gain change followed by DCOC tracking. | | | | | |
| Mode 3 | <p>In this mode, DC residual has the role of applying a correction based on the DC offset estimate provided by the DCOC at the end of the DCOC tracking after the last DCOC DAC update.</p> <p>The DC residual processing is restarted whenever DCOC's tracking hold timer expires.</p> <p>This mode is suitable after AGC gain change and DCOC tracking when no further refining is desired.</p> | 1 | 1 | 1 | - | - |

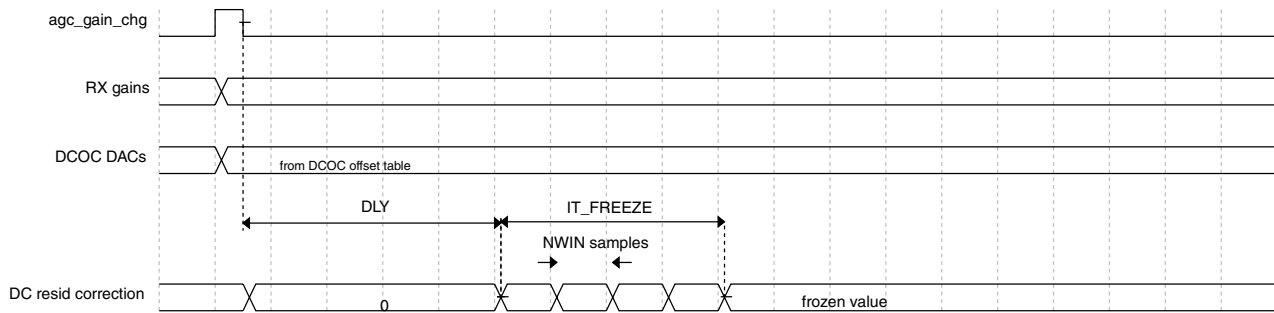

Figure 45-40. DC residual mode 1 timing

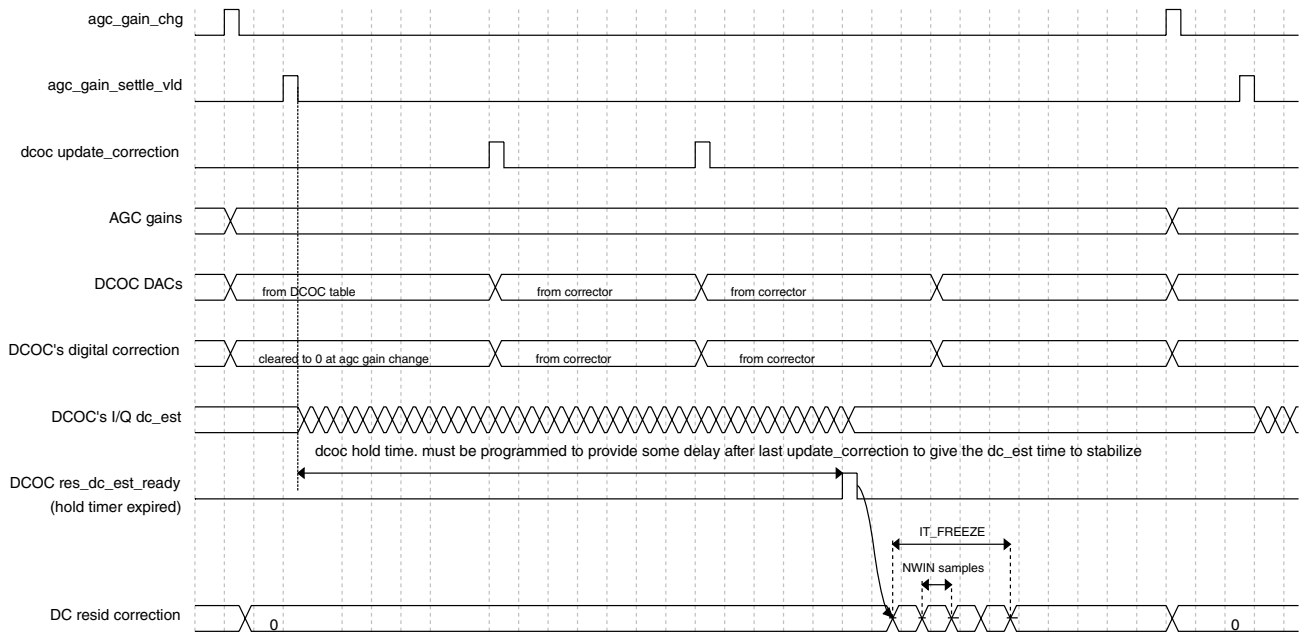

Figure 45-41. DC residual mode 2 timing

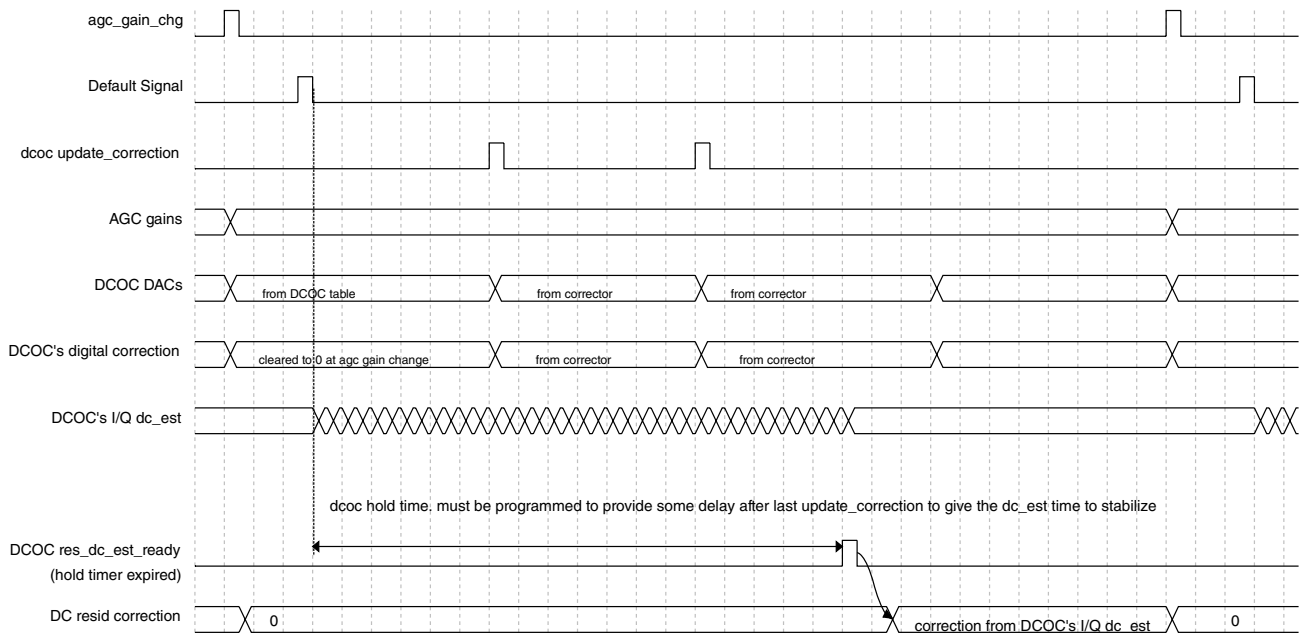

Figure 45-42. DC residual mode 3 timing

The behavior of the Residual DC block is also dependent on the AGC index and the values programmed for DC_RESID's MIN_AGC_IDX and the DCOC's DCOC_CTRL_1[DCOC_TRK_MIN_AGC_IDX]. This behavior is defined in the table below, which assumes DC_RESID_EN=1.

Table 45-30. Residual DC offset compensation operation dependency on AGC table index

| EXT_DC_EN | MIN_AGC_IDX | DCOC_TRK_MIN_AGC_IDX | Behavior |
|-----------|------------------------|---------------------------------|--|
| - | AGC_IDX < MIN_AGC_IDX | - | DC residual is disabled |
| 0 | AGC_IDX >= MIN_AGC_IDX | - | DC residual operates in Mode 1 (it does not use an initial estimate from the DCOC) |
| 1 | AGC_IDX >= MIN_AGC_IDX | AGC_IDX >= DCOC_TRK_MIN_AGC_IDX | DC residual operates in Mode 2 or 3 (It uses the estimate from the DCOC) |
| | | AGC_IDX < DCOC_TRK_MIN_AGC_IDX | DC residual operates in Mode 1. it does not use the estimate from the DCOC, since the DCOC's tracker is disabled for this AGC gain index |

45.4.3.2.9 Normalizer

The normalizer block converts the 12-bit I/Q input signal into a normalized 5-bit I/Q output and a 5-bit phase output as shown in the block diagram below.

NOTE

The normalizer's 5-bit I/Q output is currently not used.

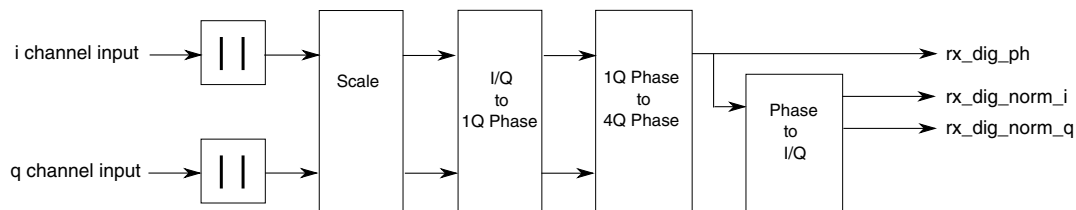

Normalizer Block Diagram

Figure 45-43. Normalizer Block Diagram

The absolute value of each component of the I/Q input is taken and shifted by a common factor to yield the largest 5-bit values which have a zero MSB for both I and Q. This is followed by rounding that yields I and Q values between 0 and 16 decimal. The scaled I/Q values are used as inputs to a one quadrant phase lookup table. The one quadrant table output is converted to a 4 quadrant 5-bit phase value based on the input sign bits.

The 5-bit I/Q output is generated by another lookup table. The normalizer has a maximum quantization error of 8.9 degrees and a RMS error of 3.5 degrees for a random input.

45.4.3.2.10 AuxPLL Frequency Calibration

The AuxPLL Frequency Calibration module finds the best calibration code associated with the AuxPLL. Calibration is initiated using a TSM control signal, and it is expected that this calibration will be performed on each RX warmup. Features of the module include the following:

- Supports two different calibration run window lengths: 64 reference clock cycles, and 128 reference clock cycles. For a 32Mhz reference clock, the overall calibration time is <17us for a run window of 64 reference clock cycles, and <31us for a run window of 128 reference clock cycles.
- Calibration logic can be disabled and a manual calibration value can be applied
- The clk cycle at which the fcal_count[9:0] input from the analog is sampled is programmable.

The module uses a binary search to find the best 7bit calibration code (auxpll_fco_dac_cal_adjust[6:0]). At the end of each calibration stage, the auxpll_fcal_count[9:0] value output from the analog (which counts the number of positive and negative edges of the auxpll clock during the run window) is sampled and compared against the expected count (256 for a run window length of 64 clk cycles, 512 for a run window length of 128 clk cycles), and a decision is made whether the appropriate auxpll_vco_dac_cal_adjust[6:0] bit should be set or cleared. The decision logic is programmable:

- AUXPLL_FCAL_CTRL[FCAL_COMP_INV]=1'b0 (default behavior): if the fcal_count is larger than or equal to the expected count, the cal_adjust bit remains set.
- AUXPLL_FCAL_CTRL[FCAL_COMP_INV]=1'b1: if the fcal_count is less than or equal to the expected count, the cal_adjust bit remains set.

After each of the seven calibration cycles, the current count error is compared to the best (smallest absolute) count error found so far, and after the binary search is complete, the module outputs the calibration code associated with the smallest absolute count error which was found.

Debug features include the following:

- Count value for each of the several calibration stages are saved to registers
- The best absolute count error found during calibration is saved to a register
- Calibration logic can be disabled and a manual calibration value can be applied

The figure below shows the beginning of the AuxPLL calibration timing. For a run window length of 64 clk cycles (which is the configuration expected to be used) each of the 7 calibration stages requires ~76clks, with total calibration time of ~532 clks, which is <17us at 32MHz. Only the 1st (and the beginning of the 2nd) of the 7 calibration stages are shown in the figure.

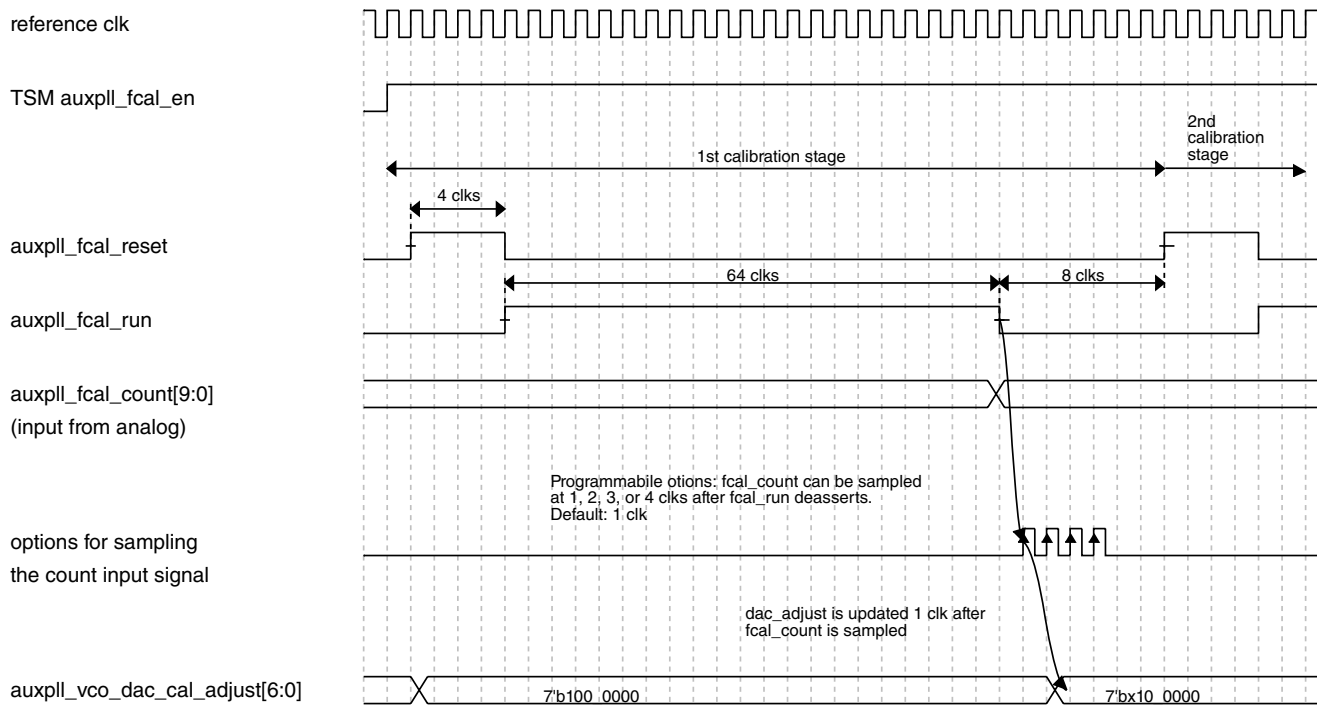

Figure 45-44. RX AuxPLL FCAL timing

45.4.3.2.11 RX RC Calibration

The RX RC Calibration module finds the best 5bit calibration code for the RC calibration circuit in the analog. From the resulting RC calibration code, separate 5bit codes are derived for each of the following analog circuits: TZA, BBA, BBA2, and ADC. The calibration sequence is initiated by a TSM control signal, and it is expected that this calibration will be performed on each RX warmup.

Features of the module include the following:

- The run window length for each of the five calibration stages is fixed at 4us. The total calibration time is $1\mu\text{s} + 5 \cdot (4\mu\text{s} + 10\text{clks} + \text{ipr_rccal_smp1_dly}[1:0] \text{ clks}) - 1 \text{ clk}$.
 - For a 32MHz clk, this is $\leq 23\mu\text{s}$ for all values of ipr_rccal_smp1_dly[1:0]
 - For a 26MHz, this is $\leq 23\mu\text{s}$ for ipr_rccal_smp1_dly[1:0] = 2'b0, and $\leq 24\mu\text{s}$ for other values.

- The four (TZA, BBA, BBA2, and ADC) calibration codes are derived from the RC calibration code by adding signed 4bit programmable offsets. Each of TZA, BBA, BBA2 and ADC have their own programmable offset with saturation detection.
- The comparator output (rccal_comp_out in figure below) from the analog can be programmably inverted.
- The clk cycle at which the comp_out input from the analog is sampled is programmable.
- The output for each of the individual calibration codes (TZA, BBA, BBA2, and ADC) can be applied manually from a register

The module uses a binary search to find the best 5bit calibration code (rccal_code[4:0]). At the end of each calibration stage, the comp_out value output from the analog is sampled, optionally inverted, and used to determine whether the appropriate rccal_code[4:0] bit should be set or cleared.

The figure below illustrates the RC calibration timing. There is a 1us initialization after the calibration circuit is enabled, and then each of the 5 calibration stages requires 5us, for a total of 26us for the entire calibration sequence. Only the inialization 1us and the 1st calibration stage are shown in the figure. The rccal_comp_out signal level at end the end of the calibration stage is used to determine whether the appropriate rccal_code[4:0] will be set or cleared.

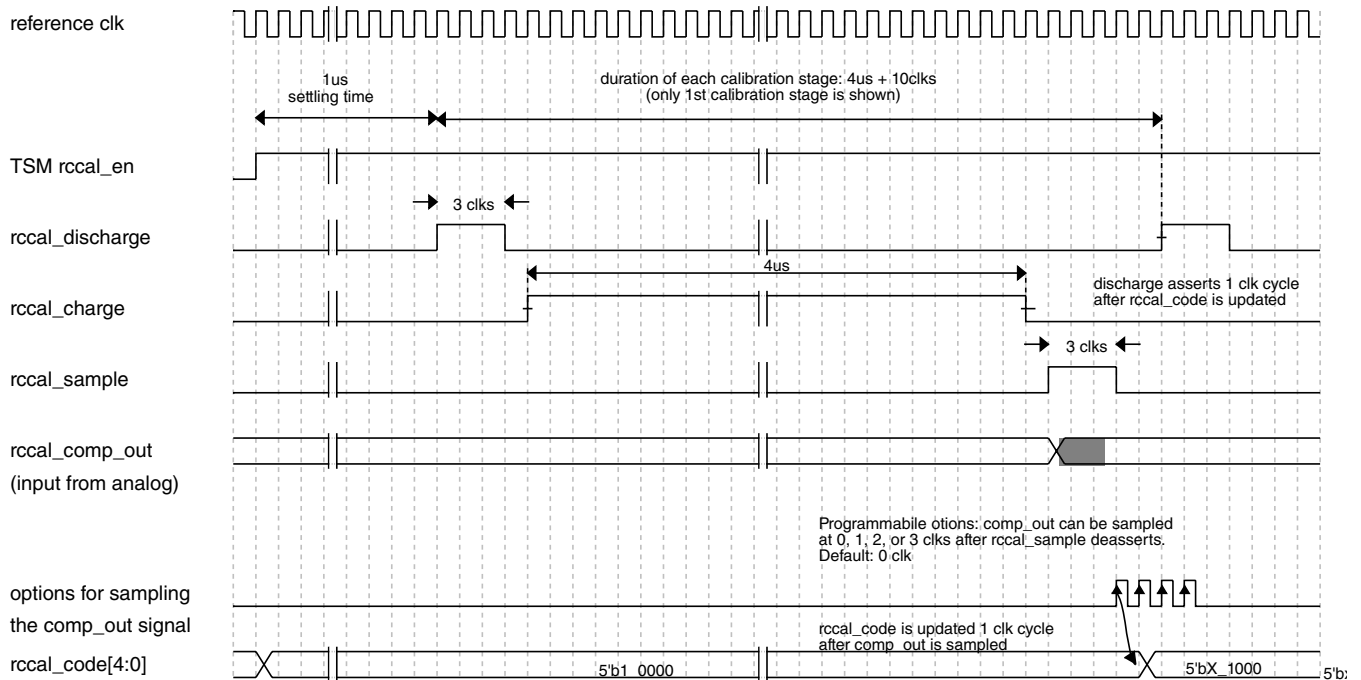

Figure 45-45. RX RCCAL timing

45.4.3.3 Memory Map and register definition

The rx_dig memory map and description of the rx_dig registers is included in the following register section.

45.4.3.3.1 XCVR_RX_DIG Register Descriptions

45.4.3.3.1.1 XCVR_RX_DIG_ADDR Memory Map

Base address: 4005C000h

| Offset | Register | Width (In bits) | Access | Reset value |
|-----------|--|--------------------|--------|-------------|
| 4005C000h | RX Digital Control (RX_DIG_CTRL) | 32 | RW | 00000000h |
| 4005C004h | AGC Control 0 (AGC_CTRL_0) | 32 | RW | 00000000h |
| 4005C008h | AGC Control 1 (AGC_CTRL_1) | 32 | RW | 00000000h |
| 4005C00Ch | AGC Control 2 (AGC_CTRL_2) | 32 | RW | 00A69000h |
| 4005C010h | AGC Control 3 (AGC_CTRL_3) | 32 | RW | 00000000h |
| 4005C014h | AGC Status (AGC_STAT) | 32 | RO | 00000000h |
| 4005C018h | RSSI Control 0 (RSSI_CTRL_0) | 32 | RW | 00300000h |
| 4005C01Ch | RSSI Control 1 (RSSI_CTRL_1) | 32 | RO | 00000000h |
| 4005C024h | DCOC Control 0 (DCOC_CTRL_0) | 32 | RW | 00000000h |
| 4005C028h | DCOC Control 1 (DCOC_CTRL_1) | 32 | RW | 00000000h |
| 4005C02Ch | DCOC DAC Initialization (DCOC_DAC_INIT) | 32 | RW | 80802020h |
| 4005C030h | DCOC Digital Correction Manual Override (DCOC_DIG_MAN) | 32 | RW | 00000000h |
| 4005C034h | DCOC Calibration Gain (DCOC_CAL_GAIN) | 32 | RW | 00000000h |
| 4005C038h | DCOC Status (DCOC_STAT) | 32 | RO | 80802020h |
| 4005C03Ch | DCOC DC Estimate (DCOC_DC_EST) | 32 | RO | 00000000h |
| 4005C040h | DCOC Calibration Reciprocals (DCOC_CAL_RCP) | 32 | RW | 00000000h |
| 4005C048h | IQMC Control (IQMC_CTRL) | 32 | RW | 04008000h |
| 4005C04Ch | IQMC Calibration (IQMC_CAL) | 32 | RW | 00000400h |
| 4005C050h | LNA_GAIN Step Values 3..0 (LNA_GAIN_VAL_3_0) | 32 | RW | 3809321Dh |
| 4005C054h | LNA_GAIN Step Values 7..4 (LNA_GAIN_VAL_7_4) | 32 | RW | 8B745D4Fh |
| 4005C058h | LNA_GAIN Step Values 8 (LNA_GAIN_VAL_8) | 32 | RW | 0000B6A1h |
| 4005C05Ch | BBA Resistor Tune Values 7..0 (BBA_RES_TUNE_VAL_7_0) | 32 | RW | 00000000h |
| 4005C060h | BBA Resistor Tune Values 10..8 (BBA_RES_TUNE_VAL_10_8) | 32 | RW | 00000000h |
| 4005C064h | LNA Linear Gain Values 2..0 (LNA_GAIN_LIN_VAL_2_0) | 32 | RW | 00000000h |
| 4005C068h | LNA Linear Gain Values 5..3 (LNA_GAIN_LIN_VAL_5_3) | 32 | RW | 00000000h |
| 4005C06Ch | LNA Linear Gain Values 8..6 (LNA_GAIN_LIN_VAL_8_6) | 32 | RW | 00000000h |

Table continues on the next page...

FSK Modulator

| Offset | Register | Width (In bits) | Access | Reset value |
|--------------------------|--|--------------------|--------|-------------|
| 4005C070h | LNA Linear Gain Values 9 (LNA_GAIN_LIN_VAL_9) | 32 | RW | 00000000h |
| 4005C074h | BBA Resistor Tune Values 3..0 (BBA_RES_TUNE_LIN_VAL_3_0) | 32 | RW | 00000000h |
| 4005C078h | BBA Resistor Tune Values 7..4 (BBA_RES_TUNE_LIN_VAL_7_4) | 32 | RW | 00000000h |
| 4005C07Ch | BBA Resistor Tune Values 10..8 (BBA_RES_TUNE_LIN_VAL_10_8) | 32 | RW | 00000000h |
| 4005C080h | AGC Gain Tables Step 03..00 (AGC_GAIN_TBL_03_00) | 32 | RW | 00000000h |
| 4005C084h | AGC Gain Tables Step 07..04 (AGC_GAIN_TBL_07_04) | 32 | RW | 00000000h |
| 4005C088h | AGC Gain Tables Step 11..08 (AGC_GAIN_TBL_11_08) | 32 | RW | 00000000h |
| 4005C08Ch | AGC Gain Tables Step 15..12 (AGC_GAIN_TBL_15_12) | 32 | RW | 00000000h |
| 4005C090h | AGC Gain Tables Step 19..16 (AGC_GAIN_TBL_19_16) | 32 | RW | 00000000h |
| 4005C094h | AGC Gain Tables Step 23..20 (AGC_GAIN_TBL_23_20) | 32 | RW | 00000000h |
| 4005C098h | AGC Gain Tables Step 26..24 (AGC_GAIN_TBL_26_24) | 32 | RW | 00000000h |
| 4005C0A0h - 4005C108h | DCOC Offset (DCOC_OFFSET_0 - DCOC_OFFSET_26) | 32 | RW | 00000000h |
| 4005C10Ch | DCOC BBA DAC Step (DCOC_BBA_STEP) | 32 | RW | 00000000h |
| 4005C110h | DCOC TZA DAC Step 0 (DCOC_TZA_STEP_0) | 32 | RW | 00000000h |
| 4005C114h | DCOC TZA DAC Step 1 (DCOC_TZA_STEP_1) | 32 | RW | 00000000h |
| 4005C118h | DCOC TZA DAC Step 2 (DCOC_TZA_STEP_2) | 32 | RW | 00000000h |
| 4005C11Ch | DCOC TZA DAC Step 3 (DCOC_TZA_STEP_3) | 32 | RW | 00000000h |
| 4005C120h | DCOC TZA DAC Step 4 (DCOC_TZA_STEP_4) | 32 | RW | 00000000h |
| 4005C124h | DCOC TZA DAC Step 5 (DCOC_TZA_STEP_5) | 32 | RW | 00000000h |
| 4005C128h | DCOC TZA DAC Step 6 (DCOC_TZA_STEP_6) | 32 | RW | 00000000h |
| 4005C12Ch | DCOC TZA DAC Step 7 (DCOC_TZA_STEP_7) | 32 | RW | 00000000h |
| 4005C130h | DCOC TZA DAC Step 8 (DCOC_TZA_STEP_8) | 32 | RW | 00000000h |
| 4005C134h | DCOC TZA DAC Step 9 (DCOC_TZA_STEP_9) | 32 | RW | 00000000h |
| 4005C138h | DCOC TZA DAC Step 10 (DCOC_TZA_STEP_10) | 32 | RW | 00000000h |
| 4005C168h | DCOC Calibration Alpha (DCOC_CAL_ALPHA) | 32 | RO | 00000000h |
| 4005C16Ch | DCOC Calibration Beta Q (DCOC_CAL_BETA_Q) | 32 | RO | 00000000h |
| 4005C170h | DCOC Calibration Beta I (DCOC_CAL_BETA_I) | 32 | RO | 00000000h |
| 4005C174h | DCOC Calibration Gamma (DCOC_CAL_GAMMA) | 32 | RO | 00000000h |
| 4005C178h | DCOC Calibration IIR (DCOC_CAL_IIR) | 32 | RW | 00000000h |
| 4005C180h - 4005C188h | DCOC Calibration Result (DCOC_CAL1 - DCOC_CAL3) | 32 | RO | 00000000h |
| 4005C190h | RX_DIG CCA ED LQI Control Register 0 (CCA_ED_LQI_CTRL_0) | 32 | RW | 00000000h |
| 4005C194h | RX_DIG CCA ED LQI Control Register 1 (CCA_ED_LQI_CTRL_1) | 32 | RW | 00000000h |
| 4005C198h | RX_DIG CCA ED LQI Status Register 0 (CCA_ED_LQI_STAT_0) | 32 | RO | 00000000h |
| 4005C1A0h | Receive Channel Filter Coefficient 0 (RX_CHF_COEF_0) | 32 | RW | 00000000h |
| 4005C1A4h | Receive Channel Filter Coefficient 1 (RX_CHF_COEF_1) | 32 | RW | 00000000h |
| 4005C1A8h | Receive Channel Filter Coefficient 2 (RX_CHF_COEF_2) | 32 | RW | 00000000h |
| 4005C1ACh | Receive Channel Filter Coefficient 3 (RX_CHF_COEF_3) | 32 | RW | 00000000h |
| 4005C1B0h | Receive Channel Filter Coefficient 4 (RX_CHF_COEF_4) | 32 | RW | 00000000h |

Table continues on the next page...

| Offset | Register | Width (In bits) | Access | Reset value |
|-----------|--|--------------------|--------|-------------|
| 4005C1B4h | Receive Channel Filter Coefficient 5 (RX_CHF_COEF_5) | 32 | RW | 00000000h |
| 4005C1B8h | Receive Channel Filter Coefficient 6 (RX_CHF_COEF_6) | 32 | RW | 00000000h |
| 4005C1BCh | Receive Channel Filter Coefficient 7 (RX_CHF_COEF_7) | 32 | RW | 00000000h |
| 4005C1C0h | Receive Channel Filter Coefficient 8 (RX_CHF_COEF_8) | 32 | RW | 00000000h |
| 4005C1C4h | Receive Channel Filter Coefficient 9 (RX_CHF_COEF_9) | 32 | RW | 00000000h |
| 4005C1C8h | Receive Channel Filter Coefficient 10 (RX_CHF_COEF_10) | 32 | RW | 00000000h |
| 4005C1CCh | Receive Channel Filter Coefficient 11 (RX_CHF_COEF_11) | 32 | RW | 00000000h |
| 4005C1D0h | AGC Manual AGC Index (AGC_MAN_AGC_IDX) | 32 | RW | 00000000h |
| 4005C1D4h | DC Residual Control (DC_RESID_CTRL) | 32 | RW | 00000000h |
| 4005C1D8h | DC Residual Estimate (DC_RESID_EST) | 32 | RO | 00000000h |
| 4005C1DCh | RX RC Calibration Control0 (RX_RCCAL_CTRL0) | 32 | RW | 00000000h |
| 4005C1E0h | RX RC Calibration Control1 (RX_RCCAL_CTRL1) | 32 | RW | 00000000h |
| 4005C1E4h | RX RC Calibration Status (RX_RCCAL_STAT) | 32 | RO | 02104210h |
| 4005C1E8h | Aux PLL Frequency Calibration Control (AUXPLL_FCAL_CTRL) | 32 | RW | 00400000h |
| 4005C1ECh | Aux PLL Frequency Calibration Count 6 (AUXPLL_FCAL_CNT6) | 32 | RO | 00000000h |
| 4005C1F0h | Aux PLL Frequency Calibration Count 5 and 4 (AUXPLL_FCAL_CNT5_4) | 32 | RO | 00000000h |
| 4005C1F4h | Aux PLL Frequency Calibration Count 3 and 2 (AUXPLL_FCAL_CNT3_2) | 32 | RO | 00000000h |
| 4005C1F8h | Aux PLL Frequency Calibration Count 1 and 0 (AUXPLL_FCAL_CNT1_0) | 32 | RO | 00000000h |

45.4.3.3.1.2 RX Digital Control (RX_DIG_CTRL)

45.4.3.3.1.2.1 Offset

| Register | Offset |
|-------------|-----------|
| RX_DIG_CTRL | 4005C000h |

45.4.3.3.1.2.2 Diagram

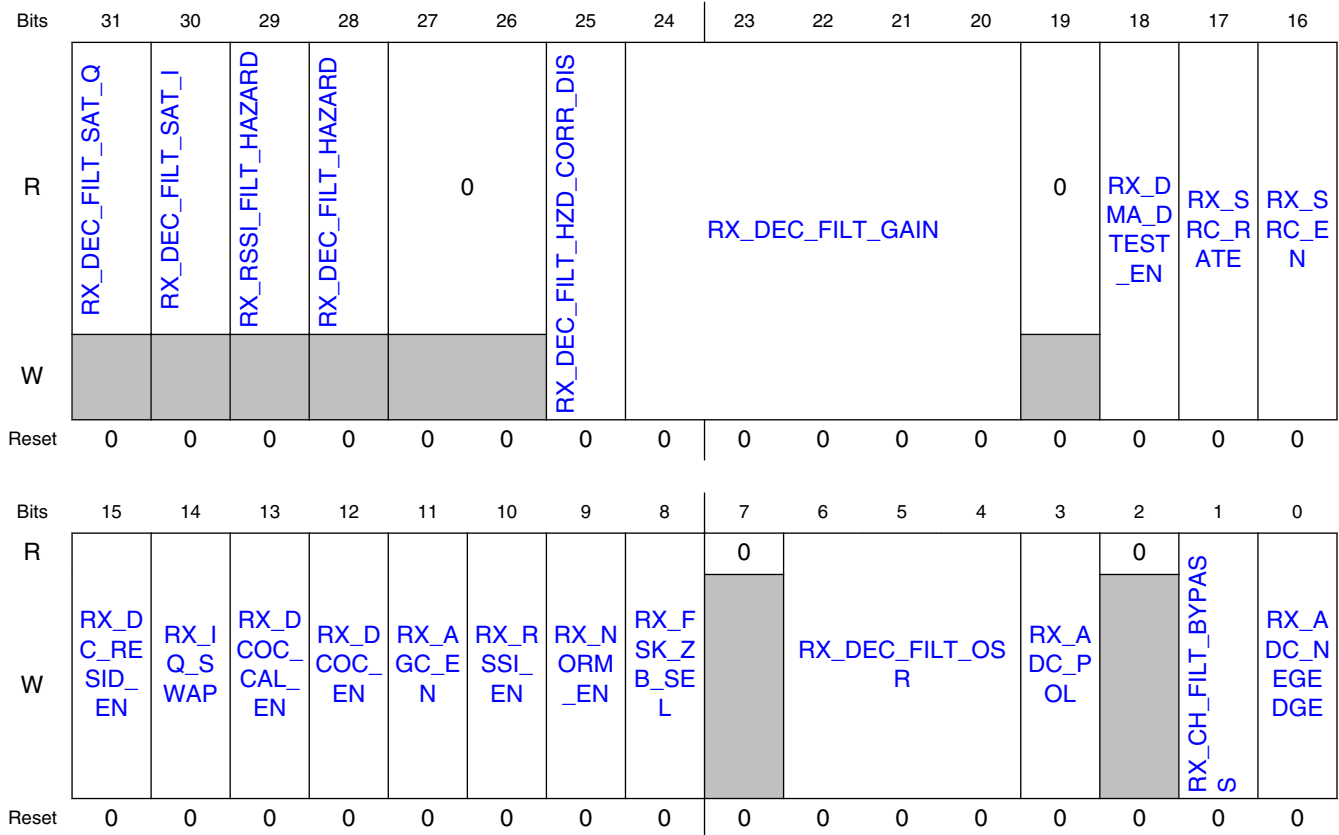

45.4.3.3.1.2.3 Fields

| Field | Function |
|---------------------------|--|
| 31 RX_DEC_FILT_SAT_Q | Decimator output, saturation detected for Q channel This bit will be set if a saturation condition is detected in the decimator filter Q channel. This bit is cleared by tsm_rx_dcoc_init and rx_init. 0b - A saturation condition has not occurred. 1b - A saturation condition has occurred. |
| 30 RX_DEC_FILT_SAT_I | Decimator output, saturation detected for I channel This bit will be set if a saturation condition is detected in the decimator filter I channel. This bit is cleared by tsm_rx_dcoc_init and rx_init. 0b - A saturation condition has not occurred. 1b - A saturation condition has occurred. |
| 29 RX_RSSI_FILT_HAZARD | Decimator output for RSSI, hazard condition detected This bit will be set if a hazard condition is detected in either the I or Q decimator filter related to the wideband RSSI measurement. This does not indicate that a data corruption has occurred, only that the conditions associated with data corruption were detected. This bit is cleared by rx_init. 0b - A hazard condition has not been detected 1b - A hazard condition has been detected |
| 28 | Decimator output, hazard condition detected |

Table continues on the next page...

| Field | Function |
|--------------------------------|---|
| RX_DEC_FILT_HAZARD | This bit will be set if a hazard condition is detected in either the I or Q decimator filter. This does not indicate that a data corruption has occurred, only that the conditions associated with data corruption were detected. This bit is cleared by rx_init. 0b - A hazard condition has not been detected 1b - A hazard condition has been detected |
| 27-26 — | Reserved. |
| 25 RX_DEC_FILT_HZD_CORR_DIS | Decimator filter hazard correction disable This bit should be set for normal operation. |
| 24-20 RX_DEC_FILT_GAIN | Decimation Filter Fractional Gain Defines the fractional gain which is applied at the decimator output. The format is u0.5. The gain applied is $1 + \text{RX_DEC_FILT_GAIN}/32$, so e.g. if RX_DEC_FILT_GAIN is 5'b10110=5'd22, the gain is $1 + 22/32 = 1.6875$. The nominal gain through the ADC is 2048codes/1.7V; the combined gain through the ADC and decimator would therefore be $2048\text{codes}/1.7\text{e}3\text{mV} * 1.6875 = 2.03\text{codes}/\text{mV}$ for the example RX_DEC_FILT_GAIN=5'b10110. |
| 19 — | Reserved. |
| 18 RX_DMA_DTTEST_EN | RX DMA and DTEST enable This bit should be set to ensure that all of the rx_dig outputs related to DMA or DTEST are enabled. In mission mode this bit is intended to be cleared to reduce switching power. |
| 17 RX_SRC_RATE | RX Sample Rate Converter Rate Selections 0b - SRC is configured for a First Order Hold rate of 8/13. 1b - SRC is configured for a Zero Order Hold rate of 12/13. |
| 16 RX_SRC_EN | RX Sample Rate Converter Enable 0b - SRC is disabled. 1b - SRC is enabled. |
| 15 RX_DC_RESID_EN | DC Residual Enable Enables DC Residual block 0b - DC Residual block is disabled. 1b - DC Residual block is enabled. |
| 14 RX_IQ_SWAP | RX IQ Swap Enable swap of I/Q channels (does not affect ADC raw mode). 0b - IQ swap is disabled. 1b - IQ swap is enabled. |
| 13 RX_DCOC_CAL_EN | DCOC Calibration Enable Enable DCOC warm-up calibration in receiver. 0b - DCOC calibration is disabled. 1b - DCOC calibration is enabled. |
| 12 RX_DCOC_EN | DCOC Enable Enables DCO calculation and application of corrections. 0b - DCOC is disabled. 1b - DCOC is enabled. |
| 11 RX_AGC_EN | AGC Global Enable Does NOT affect user gains (user gain programming has priority). 0b - AGC is disabled. |

Table continues on the next page...

FSK Modulator

| Field | Function |
|------------------------|---|
| | 1b - AGC is enabled. |
| 10 RX_RSSI_EN | RSSI Measurement Enable 0b - RSSI measurement is disabled. 1b - RSSI measurement is enabled. |
| 9 RX_NORM_EN | Normalizer Enable 0b - Normalizer is disabled. 1b - Normalizer is enabled. |
| 8 RX_FSK_ZB_SEL | FSK / 802.15.4 demodulator select Select between FSK and 802.15.4 demodulator. This is used in the RSSI and AGC to select trigger source input signals. 0b - FSK demodulator. 1b - 802.15.4 demodulator. |
| 7 — | Reserved. |
| 6-4 RX_DEC_FILT_OSR | Decimation Filter Oversampling NOTE: All undocumented values are Reserved. 000b - OSR 4 001b - OSR 8 010b - OSR 16 100b - OSR 32 011b - OSR 6 101b - OSR 12 110b - OSR 24 |
| 3 RX_ADC_POL | Receive ADC Polarity Selects polarity of the ADC data 0b - ADC output of 1'b0 maps to -1, 1'b1 maps to +1 (default) 1b - ADC output of 1'b0 maps to +1, 1'b1 maps to -1 |
| 2 — | Reserved. |
| 1 RX_CH_FILT_BYPASS | Receive Channel Filter Bypass Selects whether to disable and bypass channel filter. 0b - Channel filter is enabled. 1b - Disable and bypass channel filter. |
| 0 RX_ADC_NEGEDGE | Receive ADC Negative Edge Selection Selects which edge of the clock the ADC data is registered. 0b - Register ADC data on positive edge of clock 1b - Register ADC data on negative edge of clock |

45.4.3.3.1.3 AGC Control 0 (AGC_CTRL_0)

45.4.3.3.1.3.1 Offset

| Register | Offset |
|------------|-----------|
| AGC_CTRL_0 | 4005C004h |

45.4.3.3.1.3.2 Diagram

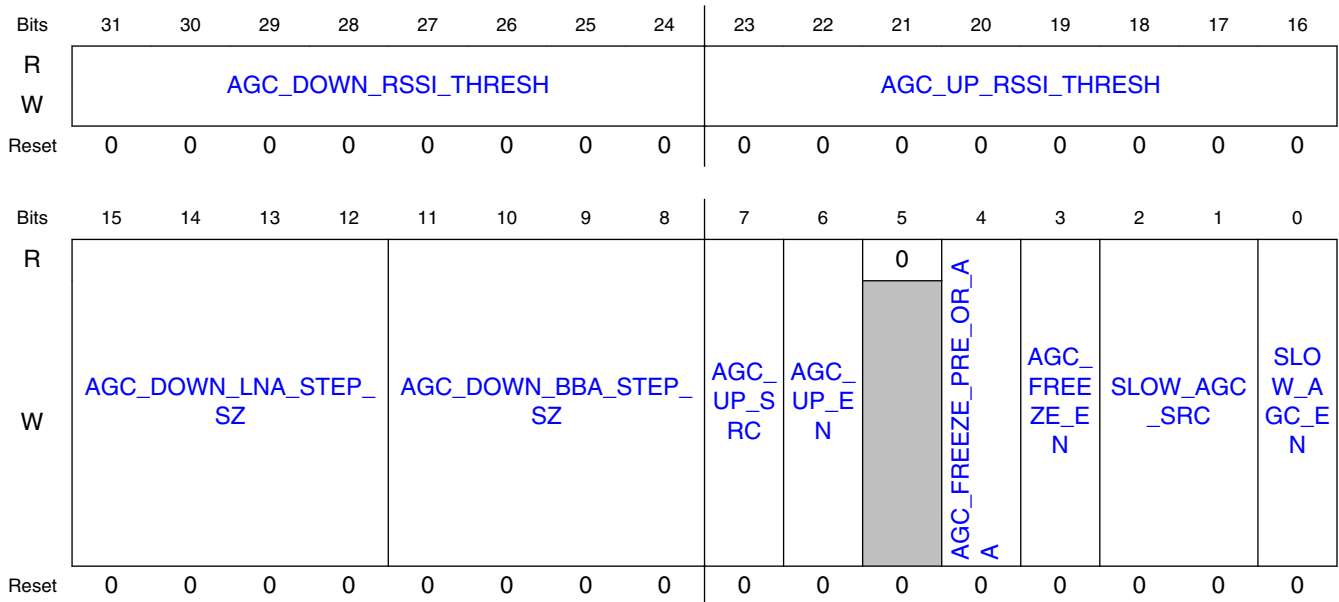

45.4.3.3.1.3.3 Fields

| Field | Function |
|-------------------------------|---|
| 31-24 AGC_DOWN_RSSI_THRESH | AGC DOWN RSSI Threshold ADC RSSI threshold to take downward step (AGC slow). If the ADC RSSI measurement is higher than this threshold, a downward gain step can be taken. The ADC RSSI is measured directly from the ADC input and does not have any adjustment applied for gain settings, etc. In other words, it is a measurement of how saturated the digital bus is, similar to a dBFS measurement. |
| 23-16 AGC_UP_RSSI_THRESH | AGC UP RSSI Threshold ADC RSSI threshold to take upward step (AGC slow). If the ADC RSSI measurement is below this threshold, an upward gain step can be taken. The ADC RSSI is measured directly from the ADC input and does not have any adjustment applied for gain settings, etc. In other words, it is a measurement of how saturated the digital bus is, similar to a dBFS measurement. |
| 15-12 AGC_DOWN_LNA_STEP_SZ | AGC_DOWN_LNA_STEP_SZ Number of table steps for downward step (LNA) in AGC fast. |
| 11-8 AGC_DOWN_BBA_STEP_SZ | AGC_DOWN_BBA_STEP_SZ Number of table steps for downward step (BBA) in AGC fast. |
| 7 AGC_UP_SRC | AGC Up Source Criterion to use for upward AGC steps in SLOW state. For pdet_lo, a timing window is observed for no assertions of the LO peak detectors and then an upward step is made. If RSSI is selected, the current RSSI measurement is compared with the UP threshold to determine if an upward step is due. 0b - PDET LO 1b - RSSI |
| 6 | AGC Up Enable |

Table continues on the next page...

FSK Modulator

| Field | Function |
|-------------------------------|--|
| AGC_UP_EN | Allow AGC to take upward steps in the gain table in slow mode. |
| 5 — | Reserved. |
| 4 AGC_FREEZE_ PRE_OR_AA | AGC Freeze Source Selection Select trigger source for entering freeze AGC (HOLD state). 0b - Access Address match (for active protocol) 1b - Preamble Detect (for active protocol) |
| 3 AGC_FREEZE_ EN | AGC Freeze Enable Allow AGC to freeze (ie enter HOLD state). AGC can still go to hold mode if timer expires (same as fast expire) from slow mode. |
| 2-1 SLOW_AGC_S RC | Slow AGC Source Selection Select trigger source for entering slow AGC. For address match and preamble detect, the trigger is generated by the PHY. If the Fast AGC expire timer is selected, when the timer expires, the AGC state machine will transition into SLOW. 00b - Access Address match (for active protocol) 01b - Preamble Detect (for active protocol) 10b - Fast AGC expire timer 11b - Reserved |
| 0 SLOW_AGC_E N | Slow AGC Enable Allow AGC to enter into slow mode. |

45.4.3.3.1.4 AGC Control 1 (AGC_CTRL_1)

45.4.3.3.1.4.1 Offset

| Register | Offset |
|------------|-----------|
| AGC_CTRL_1 | 4005C008h |

45.4.3.3.1.4.2 Diagram

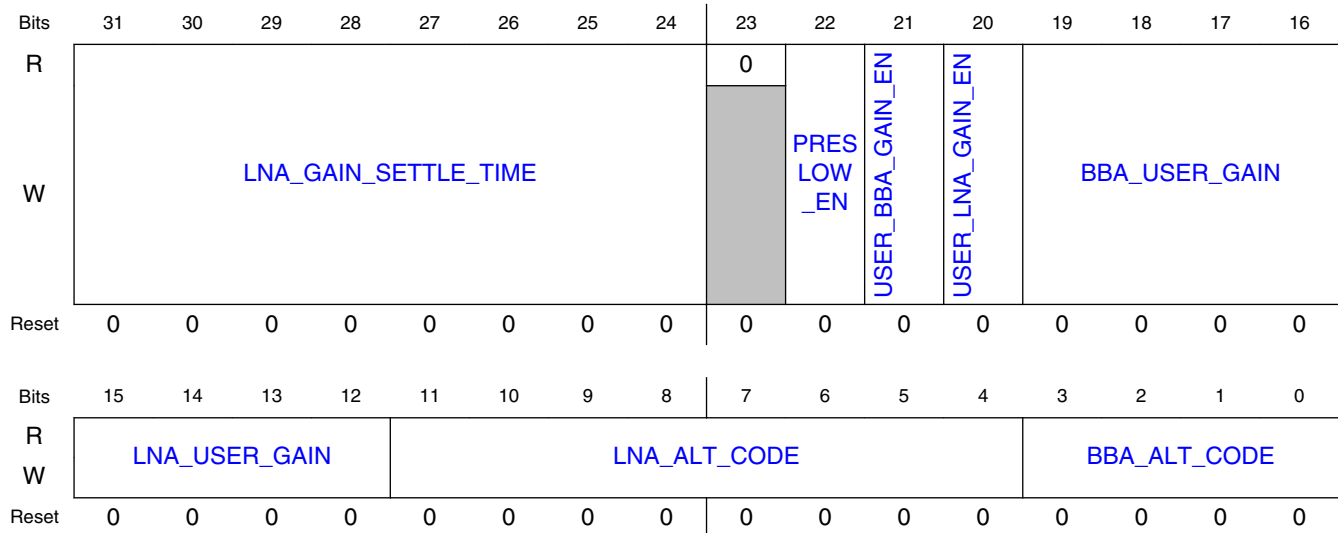

45.4.3.3.1.4.3 Fields

| Field | Function |
|-------------------------------|---|
| 31-24 LNA_GAIN_SETTLE_TIME | LNA_GAIN_SETTLE_TIME At LNA gain change, number of clocks to assert TZA peak detector reset (for automatic control). Should be programmed greater than zero. |
| 23 — | Reserved. |
| 22 PRESLOW_EN | Pre-slow Enable Enable the pre-slow state where signal headroom is checked before entering SLOW. 0b - Pre-slow is disabled. 1b - Pre-slow is enabled. |
| 21 USER_BBA_GAIN_EN | User BBA Gain Enable Enable user defined BBA gain (no AGC). |
| 20 USER_LNA_GAIN_EN | User LNA Gain Enable Enable user defined LNA gain (no AGC). |
| 19-16 BBA_USER_GAIN_IN | BBA_USER_GAIN User defined BBA gain index if user_bba_gain_en =1 |
| 15-12 LNA_USER_GAIN_IN | LNA_USER_GAIN User defined LNA gain index if user_lna_gain_en =1. |
| 11-4 LNA_ALT_CODE | LNA_ALT_CODE Alternate LNA gain code selected when lna_gain_xx=F |

Table continues on the next page...

FSK Modulator

| Field | Function |
|--------------------------|--|
| 3-0 BBA_ALT_CODE E | BBA_ALT_CODE Alternate BBA gain code selected when bba_gain_xx=0xF. |

45.4.3.3.1.5 AGC Control 2 (AGC_CTRL_2)

45.4.3.3.1.5.1 Offset

| Register | Offset |
|------------|-----------|
| AGC_CTRL_2 | 4005C00Ch |

45.4.3.3.1.5.2 Diagram

| | | | | | | | | | | | | | | | | |
|-------|-----------------|-----------------|-----------------|----------------------|----|----|----|----|-----------------|----|----|-----------------|--------------|-----------------|--------------|----|
| Bits | 31 | 30 | 29 | 28 | 27 | 26 | 25 | 24 | 23 | 22 | 21 | 20 | 19 | 18 | 17 | 16 |
| R | LNA_HG_ON_OVR | LNA_LG_ON_OVR | AGC_FAST_EXPIRE | | | | | | TZA_PDET_SEL_HI | | | TZA_PDET_SEL_LO | | BBA_PDET_SEL_HI | | |
| W | | | | | | | | | | | | | | | | |
| Reset | 0 | 0 | 0 | 0 | 0 | 0 | 0 | 0 | 1 | 0 | 1 | 0 | 0 | 1 | 1 | 0 |
| Bits | 15 | 14 | 13 | 12 | 11 | 10 | 9 | 8 | 7 | 6 | 5 | 4 | 3 | 2 | 1 | 0 |
| R | BBA_PDET_SEL_HI | BBA_PDET_SEL_LO | | BBA_GAIN_SETTLE_TIME | | | | | | | | 0 | MAN_PDET_RST | TZA_PDET_RST | BBA_PDET_RST | |
| W | | | | | | | | | | | | | | | | |
| Reset | 1 | 0 | 0 | 1 | 0 | 0 | 0 | 0 | 0 | 0 | 0 | 0 | 0 | 0 | 0 | 0 |

45.4.3.3.1.5.3 Fields

| Field | Function |
|--------------------------|--|
| 31 LNA_HG_ON_OVR | LNA_HG_ON override If set, the Ina high gain "on" signal is always asserted. Otherwise, this signal is asserted automatically based on the LNA_GAIN code. |
| 30 LNA_LG_ON_OVR | LNA_LG_ON override If set, the Ina low gain "on" signal is always asserted. Otherwise, this signal is asserted automatically based on the LNA_GAIN code. |
| 29-24 AGC_FAST_EXPIRE | AGC Fast Expire Expire time (uS) for fast AGC (1-63uS). |

Table continues on the next page...

| Field | Function |
|----------------------------------|---|
| 23-21 TZA_PDET_SE L_HI | TZA PDET Threshold High TZA peak detect HI threshold. 000b - 0.60V 001b - 0.63V 010b - 0.66V 011b - 0.69V 100b - 0.72V 101b - 0.75V 110b - 0.78V 111b - 0.81V |
| 20-18 TZA_PDET_SE L_LO | TZA PDET Threshold Low TZA peak detect LO threshold. 000b - 0.600V 001b - 0.615V 010b - 0.630V 011b - 0.645V 100b - 0.660V 101b - 0.675V 110b - 0.690V 111b - 0.705V |
| 17-15 BBA_PDET_SE L_HI | BBA PDET Threshold High BBA peak detect HI threshold. 000b - 0.600V 001b - 0.795V 010b - 0.900V 011b - 0.945V 100b - 1.005V 101b - 1.050V 110b - 1.095V 111b - 1.155V |
| 14-12 BBA_PDET_SE L_LO | BBA PDET Threshold Low BBA peak detect LO threshold. 000b - 0.600V 001b - 0.615V 010b - 0.630V 011b - 0.645V 100b - 0.660V 101b - 0.675V 110b - 0.690V 111b - 0.705V |
| 11-4 BBA_GAIN_SE TTLE_TIME | BBA Gain Settle Time Number of clocks to assert BBA peak detector reset (for automatic control). Should be programmed greater than zero. |
| 3 — | Reserved. |
| 2 MAN_PDET_RST | MAN PDET Reset 0b - The peak detector reset signals are controlled automatically by the AGC. 1b - The BBA_PDET_RST and TZA_PDET_RST are used to manually control the peak detector reset signals. |
| 1 | TZA PDET Reset TZA peak detector reset, manual control. |

Table continues on the next page...

FSK Modulator

| Field | Function |
|--------------|--|
| TZA_PDET_RST | |
| 0 | BBA PDET Reset |
| BBA_PDET_RST | BBA peak detector reset, manual control. |

45.4.3.3.1.6 AGC Control 3 (AGC_CTRL_3)

45.4.3.3.1.6.1 Offset

| Register | Offset |
|------------|-----------|
| AGC_CTRL_3 | 4005C010h |

45.4.3.3.1.6.2 Diagram

| | | | | | | | | | | | | | | | | |
|-------|-----------------|----|----|-------------------|-----------------|----|----|----|-------------------|----|----|----|----|----|----|----|
| Bits | 31 | 30 | 29 | 28 | 27 | 26 | 25 | 24 | 23 | 22 | 21 | 20 | 19 | 18 | 17 | 16 |
| R | AGC_UP_STEP_SZ | | | | AGC_H2S_STEP_SZ | | | | AGC_RSSI_DELT_H2S | | | | | | | |
| W | AGC_UP_STEP_SZ | | | | AGC_H2S_STEP_SZ | | | | AGC_RSSI_DELT_H2S | | | | | | | |
| Reset | 0 | 0 | 0 | 0 | 0 | 0 | 0 | 0 | 0 | 0 | 0 | 0 | 0 | 0 | 0 | 0 |
| Bits | 15 | 14 | 13 | 12 | 11 | 10 | 9 | 8 | 7 | 6 | 5 | 4 | 3 | 2 | 1 | 0 |
| R | AGC_PDET_LO_DLY | | | AGC_UNFREEZE_TIME | | | | | | | | | | | | |
| W | AGC_PDET_LO_DLY | | | AGC_UNFREEZE_TIME | | | | | | | | | | | | |
| Reset | 0 | 0 | 0 | 0 | 0 | 0 | 0 | 0 | 0 | 0 | 0 | 0 | 0 | 0 | 0 | 0 |

45.4.3.3.1.6.3 Fields

| Field | Function |
|-------------------|---|
| 31-28 | AGC Up Step Size |
| AGC_UP_STEP_SZ | Number of AGC gain table steps for upward step |
| 27-23 | AGC_H2S_STEP_SZ |
| AGC_H2S_STEP_SZ | AGC gain table step size for hold to slow jump. |
| 22-16 | AGC_RSSI_DELT_H2S |
| AGC_RSSI_DELT_H2S | RSSI delta that causes hold to slow transition. This delta is observed from a previous RSSI measurement to a current measurement. |
| 15-13 | AGC Peak Detect Low Delay |

Table continues on the next page...

| Field | Function |
|-------------------|---|
| AGC_PDET_LO_DLY | Time (uS) to wait for pdet low to assert (1-7uS). |
| 12-0 | AGC Unfreeze Time |
| AGC_UNFREEZE_TIME | Time (uS) for AGC to unfreeze (1-8191uS) from HOLD and re-enter SLOW state. |

45.4.3.3.1.7 AGC Status (AGC_STAT)

45.4.3.3.1.7.1 Offset

| Register | Offset |
|----------|-----------|
| AGC_STAT | 4005C014h |

45.4.3.3.1.7.2 Diagram

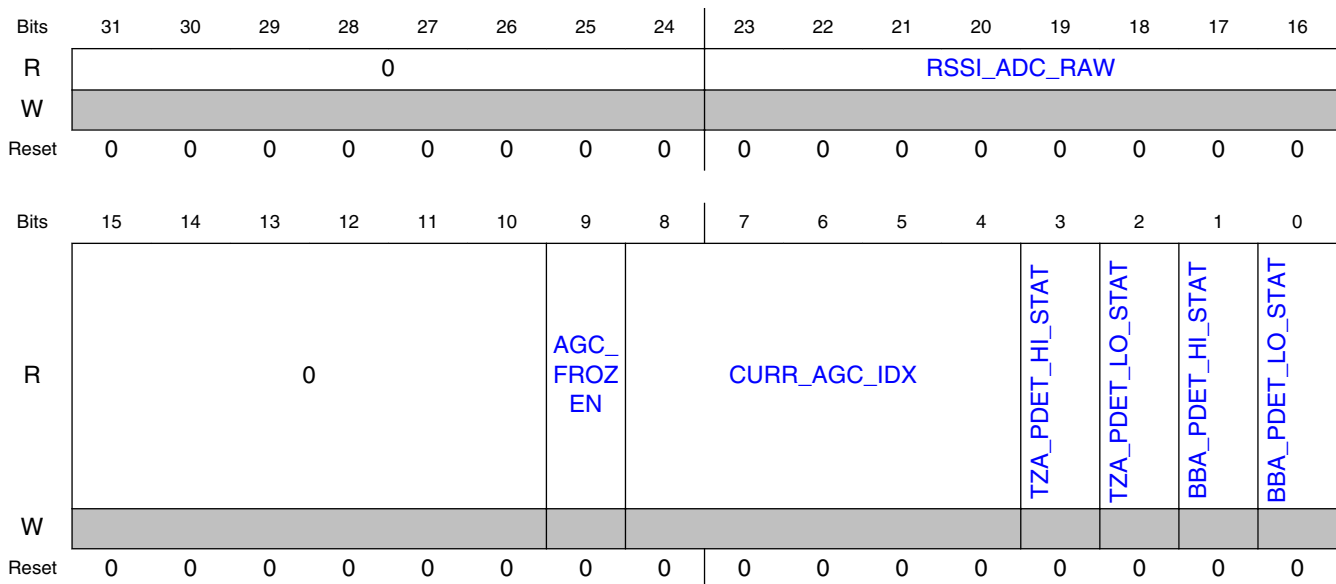

45.4.3.3.1.7.3 Fields

| Field | Function |
|-------|--|
| 31-24 | Reserved. |
| — | |
| 23-16 | ADC RAW RSSI Reading Reading of ADC rssi (before adjustments) |

Table continues on the next page...

FSK Modulator

| Field | Function |
|---------------------------|--|
| RSSI_ADC_RA W | |
| 15-10 — | Reserved. |
| 9 AGC_FROZEN | AGC Frozen Status Status of AGC freeze. 0b - AGC is not frozen. 1b - AGC is frozen. |
| 8-4 CURR_AGC_ID X | Current AGC Gain Index Current AGC gain table index |
| 3 TZA_PDET_HI_ STAT | TZA Peak Detector High Status Status of TZA peak detector HI flag (1=set) |
| 2 TZA_PDET_LO _STAT | TZA Peak Detector Low Status Status of TZA peak detector LO flag (1=set) |
| 1 BBA_PDET_HI_ STAT | BBA Peak Detector High Status Status of BBA peak detector HI flag (1=set) |
| 0 BBA_PDET_LO _STAT | BBA Peak Detector Low Status Status of BBA peak detector LO flag (1=set) |

45.4.3.3.1.8 RSSI Control 0 (RSSI_CTRL_0)

45.4.3.3.1.8.1 Offset

| Register | Offset |
|-------------|-----------|
| RSSI_CTRL_0 | 4005C018h |

45.4.3.3.1.8.2 Diagram

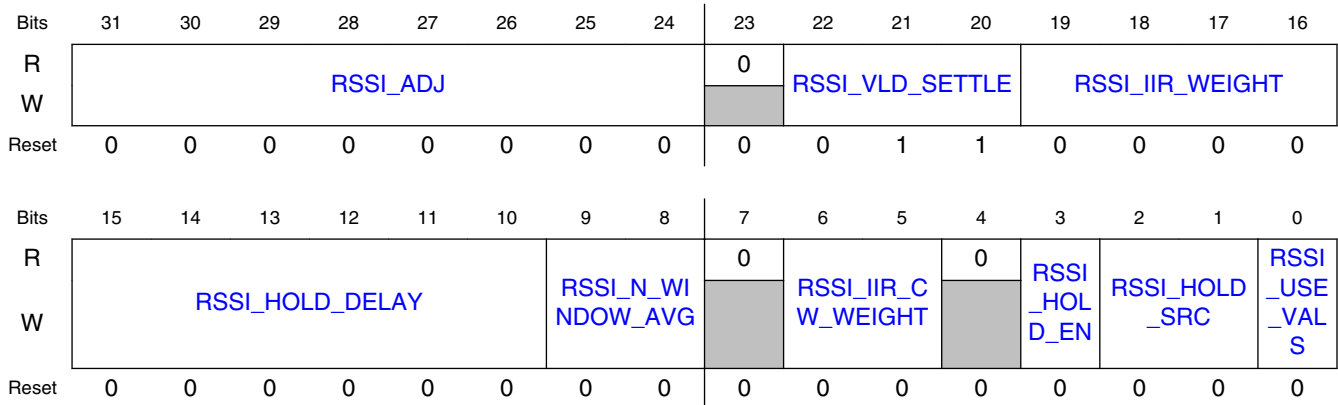

45.4.3.3.1.8.3 Fields

| Field | Function |
|------------------------------|--|
| 31-24 RSSI_ADJ | RSSI Adjustment RSSI calculation adjustment (8-bit signed 1/4 dB). |
| 23 — | Reserved. |
| 22-20 RSSI_VLD_SET TLE | RSSI Valid Settle Sets number of us (times 8) that RSSI will be considered invalid after certain events. |
| 19-16 RSSI_IIR_WEIG HT | RSSI IIR Weighting IIR filter weight for RSSI filtering. NOTE: All undocumented values are Reserved. 0000b - Bypass 0001b - 1/2 0010b - 1/4 0011b - 1/8 0100b - 1/16 0101b - 1/32 |
| 15-10 RSSI_HOLD_D ELAY | RSSI Hold Delay Sets number of us (times 8) that RSSI will run after a hold event before the value is frozen. |
| 9-8 RSSI_N_WIND OW_AVG | RSSI N Window Average Selects Averaging window length for RSSI. 00b - No averaging 01b - Averaging window length is 2 samples 10b - Averaging window length is 4 samples 11b - Averaging window length is 8 samples |
| 7 — | Reserved. |
| 6-5 | RSSI IIR CW Weighting |

Table continues on the next page...

FSK Modulator

| Field | Function |
|----------------------|--|
| RSSI_IIR_CW_WEIGHT | IIR filter weight for RSSI filtering of a CW input. 00b - Bypass 01b - 1/8 10b - 1/16 11b - 1/32 |
| 4 — | Reserved. |
| 3 RSSI_HOLD_EN | RSSI Hold Enable Enable RSSI to freeze after hold criterion met. RSSI will still be briefly held when a gain change occurs. |
| 2-1 RSSI_HOLD_SRC | RSSI Hold Source Selection Select trigger source for freezing RSSI measurement. 00b - Access Address match 01b - Preamble Detect 10b - Reserved 11b - 802.15.4 LQI done (1=freeze, 0=run AGC) |
| 0 RSSI_USE_VALS | RSSI Values Selection Enable use of LNA and BBA gain values programmed in registers for calculation. |

45.4.3.3.1.9 RSSI Control 1 (RSSI_CTRL_1)

45.4.3.3.1.9.1 Offset

| Register | Offset |
|-------------|-----------|
| RSSI_CTRL_1 | 4005C01Ch |

45.4.3.3.1.9.2 Diagram

| | | | | | | | | | | | | | | | | |
|-------|----------|----|----|----|----|----|----|----|----|----|----|----|----|----|----|----|
| Bits | 31 | 30 | 29 | 28 | 27 | 26 | 25 | 24 | 23 | 22 | 21 | 20 | 19 | 18 | 17 | 16 |
| R | RSSI_OUT | | | | | | | | 0 | | | | | | | |
| W | [Shaded] | | | | | | | | | | | | | | | |
| Reset | 0 | 0 | 0 | 0 | 0 | 0 | 0 | 0 | 0 | 0 | 0 | 0 | 0 | 0 | 0 | 0 |
| Bits | 15 | 14 | 13 | 12 | 11 | 10 | 9 | 8 | 7 | 6 | 5 | 4 | 3 | 2 | 1 | 0 |
| R | 0 | | | | | | | | | | | | | | | |
| W | [Shaded] | | | | | | | | | | | | | | | |
| Reset | 0 | 0 | 0 | 0 | 0 | 0 | 0 | 0 | 0 | 0 | 0 | 0 | 0 | 0 | 0 | 0 |

45.4.3.3.1.9.3 Fields

| Field | Function |
|-------------------|---|
| 31-24 RSSI_OUT | RSSI Reading RSSI output (8-bit signed). |
| 23-0 Reserved | Reserved. |

45.4.3.3.1.10 DCOC Control 0 (DCOC_CTRL_0)

45.4.3.3.1.10.1 Offset

| Register | Offset |
|-------------|-----------|
| DCOC_CTRL_0 | 4005C024h |

45.4.3.3.1.10.2 Diagram

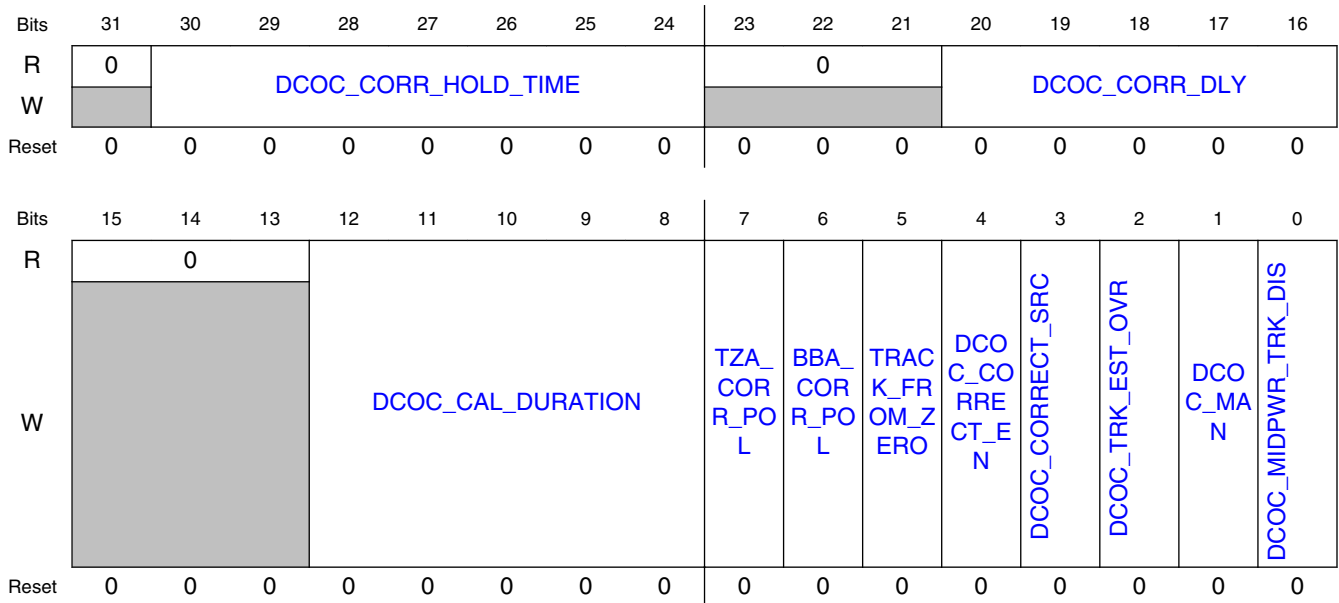

45.4.3.3.1.10.3 Fields

| Field | Function |
|-------|-----------|
| 31 | Reserved. |
| — | |

Table continues on the next page...

FSK Modulator

| Field | Function |
|------------------------------|---|
| 30-24 DCOC_CORR_HOLD_TIME | DCOC Correction Hold Time Delay from last gain change to freezing the DC correction. 000000b - Reserved 0000001-1111110b - For a 32MHz reference clock, this is the delay in microseconds; for other reference clock frequencies, the delay is scaled accordingly. 1111111b - The DC correction is not frozen. |
| 23-21 — | Reserved. |
| 20-16 DCOC_CORR_DLY | DCOC Correction Delay Wait time between corrections. 00000b - Reserved 00001-11111b - For a 32MHz reference clock, this is the wait time in microseconds; for other reference clock frequencies, the delay is scaled accordingly. |
| 15-13 — | Reserved. |
| 12-8 DCOC_CAL_DURATION | DCOC Calibration Duration 00000b - Reserved 00001-11111b - For a 32MHz reference clock, this is the calibration duration in microseconds; for other reference clock frequencies, the delay is scaled accordingly. |
| 7 TZA_CORR_POL | TZA Correction Polarity Selects polarity of TZA corrections. 0b - Normal polarity. 1b - Negative polarity. This should be set if the ADC output is inverted, or if the TZA DACs were implemented with negative polarity. |
| 6 BBA_CORR_POL | BBA Correction Polarity Selects polarity of BBA corrections. 0b - Normal polarity. 1b - Negative polarity. This should be set if the ADC output is inverted, or if the BBA DACs were implemented with negative polarity. |
| 5 TRACK_FROM_ZERO | Track from Zero Selects whether the tracking estimator resets its DC estimate on every AGC gain change to zero or uses the current I/Q sample. 0b - Track from current I/Q sample. 1b - Track from zero. |
| 4 DCOC_CORRECT_EN | DCOC Correction Enable 0b - Correction disabled. The DCOC will not correct the DC offset. 1b - Correction enabled. The DCOC will use the TZA and BBA DACs, and apply digital corrections (if DCOC_CORRECT_SRC=1) to correct the DC offset. |
| 3 DCOC_CORRECT_SRC | DCOC Corrector Source If not set, the corrector uses only the DCOC calibration table to apply corrections to the DCOC DACs. 0b - If correction is enabled, the DCOC will use only the DCOC calibration table to correct the DC offset. 1b - If correction is enabled, the DCOC will use the DCOC calibration table and then the tracking estimator to correct the DC offset. |
| 2 DCOC_TRK_EST_OVR | Override for the DCOC tracking estimator 0b - The tracking estimator is enabled only as needed by the corrector 1b - The tracking estimator remains enabled whenever the DCOC is active |
| 1 | DCOC Manual Override |

Table continues on the next page...

| Field | Function |
|-------------------------|---|
| DCOC_MAN | If the manual override bit is set, it forces the DCOC to use the DAC and digital correction values from registers DCOC_DAC_INIT and DCOC_DIG_MAN, respectively. |
| 0 | DCOC Mid Power Tracking Disable |
| DCOC_MIDPW R_TRK_DIS | Disables tracking correction at mid power levels, as indicated by the TZA and BBA lo peak detectors. This is implemented by resetting the counters associated with DCOC_CORR_DLY and DCOC_CORR_HOLD_TIME, so if the lo peak detectors do not continue to assert, tracking corrections would resume operation. The tracking estimator is not disabled and the counter associated with DCOC_TRK_EST_GS_CNT is not reset when this condition occurs. 0b - Tracking corrections are enabled as determined by DCOC_CORRECT_SRC and DCOC_TRK_MIN_AGC_IDX. 1b - Tracking corrections are disabled when either the TZA or BBA lo peak detector asserts. |

45.4.3.3.1.11 DCOC Control 1 (DCOC_CTRL_1)

45.4.3.3.1.11.1 Offset

| Register | Offset |
|-------------|-----------|
| DCOC_CTRL_1 | 4005C028h |

45.4.3.3.1.11.2 Diagram

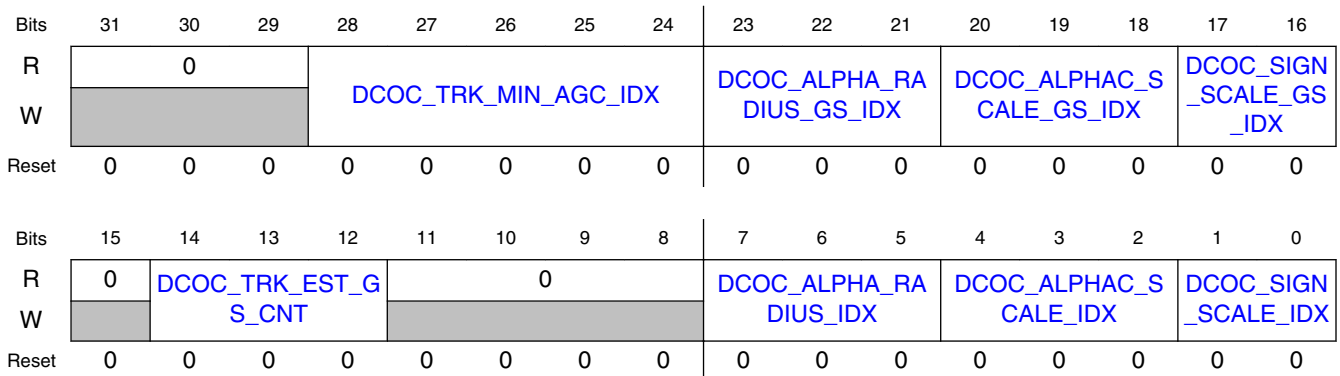

45.4.3.3.1.11.3 Fields

| Field | Function |
|--------------------------|--|
| 31-29 | Reserved. |
| — | |
| 28-24 | DCOC Tracking Minimum AGC Table Index |
| DCOC_TRK_MI N_AGC_IDX | Specifies the minimum AGC table index value at which tracking is enabled. E.g., if this is 5'd0, then tracking is enabled for all AGC gain table indexes (assuming DCOC_CORRECT_SRC is set) if this is |

Table continues on the next page...

FSK Modulator

| Field | Function |
|------------------------------------|---|
| | 5'd20, then tracking is enabled for AGC gain table indexes 20-26 (assuming DCOC_CORRECT_SRC is set). |
| 23-21 DCOC_ALPHA_RADIUS_GS_IDX | Alpha-R Scaling for Gearshift DCOC Alpha-R Scaling for Gearshift. Radius stepsize used in the DCOC tracking estimator after the gearshift counter has expired. Used when DCOC_CORRECT_SRC=1. 000b - 1 001b - 1/2 010b - 1/4 011b - 1/8 100b - 1/16 101b - 1/32 110b - 1/64 111b - Reserved |
| 20-18 DCOC_ALPHA_C_SCALE_GS_IDX | DCOC Alpha-C Scaling for Gearshift DCOC Alpha-C Scaling for Gearshift. I/Q center stepsize used in the DCOC tracking estimator after the gearshift counter has expired. Used when DCOC_CORRECT_SRC=1. 000b - 1/2 001b - 1/4 010b - 1/8 011b - 1/16 100b - 1/32 101b - 1/64 110b - Reserved 111b - Reserved |
| 17-16 DCOC_SIGN_SCALE_GS_IDX | DCOC Sign Scaling for Gearshift DCOC Sign Scaling for Gearshift. Sign()-based scaling factor used in the DCOC tracking estimator after the gearshift counter has expired. Used when DCOC_CORRECT_SRC=1. 00b - 1/8 01b - 1/16 10b - 1/32 11b - 1/64 |
| 15 — | Reserved. |
| 14-12 DCOC_TRK_EST_GS_CNT | DCOC Tracking Estimator Gearshift Count Specifies the number of corrections (periods of DCOC_CORR_DLY) before the tracking estimator switches from using the set of parameters {DCOC_ALPHA_RADIUS_IDX, DCOC_ALPHAC_SCALE_IDX, DCOC_SIGN_SCALE_IDX} to the set of gearshift parameters {DCOC_ALPHA_RADIUS_GS_IDX, DCOC_ALPHAC_SCALE_GS_IDX, DCOC_SIGN_SCALE_GS_IDX}. If the value is 0, the set of gearshift parameters are not used. |
| 11-8 — | Reserved. |
| 7-5 DCOC_ALPHA_RADIUS_IDX | Alpha-R Scaling DCOC Alpha-R Scaling. Radius stepsize used in the DCOC tracking estimator. Used when DCOC_CORRECT_SRC=1. 000b - 1 001b - 1/2 010b - 1/4 011b - 1/8 100b - 1/16 101b - 1/32 110b - 1/64 |

Table continues on the next page...

| Field | Function |
|-------------------------------|---|
| | 111b - Reserved |
| 4-2 DCOC_ALPHA_C_SCALE_IDX | DCOC Alpha-C Scaling DCOC Alpha-C Scaling. I/Q center stepsize used in the DCOC tracking estimator. Used when DCOC_CORRECT_SRC=1. 000b - 1/2 001b - 1/4 010b - 1/8 011b - 1/16 100b - 1/32 101b - 1/64 110b - Reserved 111b - Reserved |
| 1-0 DCOC_SIGN_SCALE_IDX | DCOC Sign Scaling DCOC Sign Scaling. Sign()-based scaling factor used in the DCOC tracking estimator. Used when DCOC_CORRECT_SRC=1. 00b - 1/8 01b - 1/16 10b - 1/32 11b - 1/64 |

45.4.3.3.1.12 DCOC DAC Initialization (DCOC_DAC_INIT)

45.4.3.3.1.12.1 Offset

| Register | Offset |
|---------------|-----------|
| DCOC_DAC_INIT | 4005C02Ch |

45.4.3.3.1.12.2 Diagram

| | | | | | | | | | | | | | | | | |
|-------|-----------------|----|-----------------|----|----|----|----|----|-----------------|----|-----------------|----|----|----|----|----|
| Bits | 31 | 30 | 29 | 28 | 27 | 26 | 25 | 24 | 23 | 22 | 21 | 20 | 19 | 18 | 17 | 16 |
| R | TZA_DCOC_INIT_Q | | | | | | | | TZA_DCOC_INIT_I | | | | | | | |
| W | TZA_DCOC_INIT_Q | | | | | | | | TZA_DCOC_INIT_I | | | | | | | |
| Reset | 1 | 0 | 0 | 0 | 0 | 0 | 0 | 0 | 1 | 0 | 0 | 0 | 0 | 0 | 0 | 0 |
| Bits | 15 | 14 | 13 | 12 | 11 | 10 | 9 | 8 | 7 | 6 | 5 | 4 | 3 | 2 | 1 | 0 |
| R | 0 | | BBA_DCOC_INIT_Q | | | | | | 0 | | BBA_DCOC_INIT_I | | | | | |
| W | 0 | | BBA_DCOC_INIT_Q | | | | | | 0 | | BBA_DCOC_INIT_I | | | | | |
| Reset | 0 | 0 | 1 | 0 | 0 | 0 | 0 | 0 | 0 | 0 | 1 | 0 | 0 | 0 | 0 | 0 |

45.4.3.3.1.12.3 Fields

| Field | Function |
|------------------------------|--|
| 31-24 TZA_DCOC_INI T_Q | DCOC TZA Init Q Value used for DCOC TZA Q channel DAC during calibration and for manual override. |
| 23-16 TZA_DCOC_INI T_I | DCOC TZA Init I Value used for DCOC TZA I channel DAC during calibration and for manual override. |
| 15-14 — | Reserved. |
| 13-8 BBA_DCOC_INI T_Q | DCOC BBA Init Q Value used for DCOC BBA Q channel DAC during calibration and for manual override. |
| 7-6 — | Reserved. |
| 5-0 BBA_DCOC_INI T_I | DCOC BBA Init I Value used for DCOC BBA I channel DAC during calibration and for manual override. |

45.4.3.3.1.13 DCOC Digital Correction Manual Override (DCOC_DIG_MAN)

45.4.3.3.1.13.1 Offset

| Register | Offset |
|--------------|-----------|
| DCOC_DIG_MAN | 4005C030h |

45.4.3.3.1.13.2 Diagram

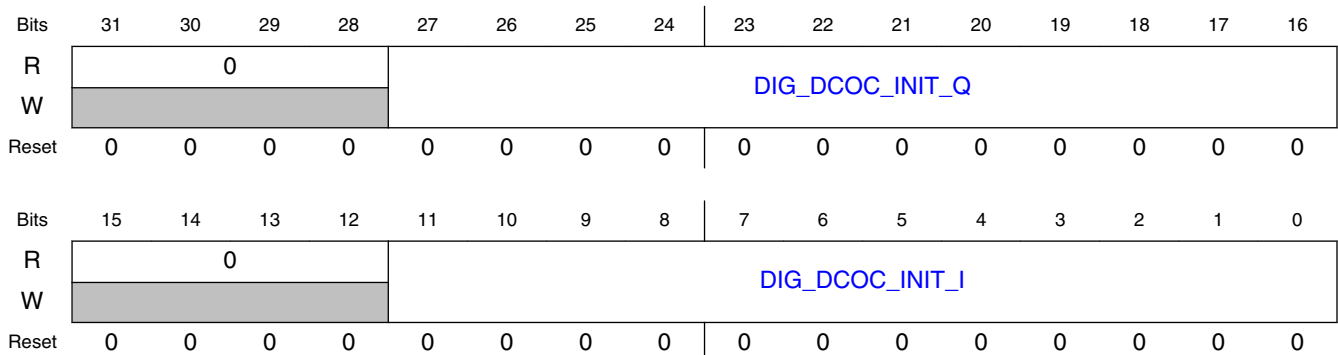

45.4.3.3.1.13.3 Fields

| Field | Function |
|------------------------------|--|
| 31-28 — | Reserved. |
| 27-16 DIG_DCOC_INI T_Q | DCOC DIG Init Q Manual override for DCOC DIG Q channel correction. Value to be subtracted from downsampled Q channel. Used when DCOC_MAN=1. |
| 15-12 — | Reserved. |
| 11-0 DIG_DCOC_INI T_I | DCOC DIG Init I Manual override for DCOC DIG I channel correction. Value to be subtracted from downsampled I channel. Used when DCOC_MAN=1. |

45.4.3.3.1.14 DCOC Calibration Gain (DCOC_CAL_GAIN)

45.4.3.3.1.14.1 Offset

| Register | Offset |
|---------------|-----------|
| DCOC_CAL_GAIN | 4005C034h |

45.4.3.3.1.14.2 Diagram

| | | | | | | | | | | | | | | | | |
|-------|--------------------|----|----|----|--------------------|----|----|----|--------------------|----|----|----|--------------------|----|----|----|
| Bits | 31 | 30 | 29 | 28 | 27 | 26 | 25 | 24 | 23 | 22 | 21 | 20 | 19 | 18 | 17 | 16 |
| R | DCOC_LNA_CAL_GAIN3 | | | | DCOC_BBA_CAL_GAIN3 | | | | DCOC_LNA_CAL_GAIN2 | | | | DCOC_BBA_CAL_GAIN2 | | | |
| W | DCOC_LNA_CAL_GAIN3 | | | | DCOC_BBA_CAL_GAIN3 | | | | DCOC_LNA_CAL_GAIN2 | | | | DCOC_BBA_CAL_GAIN2 | | | |
| Reset | 0 | 0 | 0 | 0 | 0 | 0 | 0 | 0 | 0 | 0 | 0 | 0 | 0 | 0 | 0 | 0 |
| Bits | 15 | 14 | 13 | 12 | 11 | 10 | 9 | 8 | 7 | 6 | 5 | 4 | 3 | 2 | 1 | 0 |
| R | DCOC_LNA_CAL_GAIN1 | | | | DCOC_BBA_CAL_GAIN1 | | | | 0 | | | | | | | |
| W | DCOC_LNA_CAL_GAIN1 | | | | DCOC_BBA_CAL_GAIN1 | | | | 0 | | | | | | | |
| Reset | 0 | 0 | 0 | 0 | 0 | 0 | 0 | 0 | 0 | 0 | 0 | 0 | 0 | 0 | 0 | 0 |

45.4.3.3.1.14.3 Fields

| Field | Function |
|-----------------------------|--|
| 31-28 DCOC_LNA_CAL_GAIN3 | DCOC LNA Calibration Gain 3 The LNA gain index used for the 3rd DCOC calibration point. Used when RX_DCOC_CAL_EN=1. |

Table continues on the next page...

FSK Modulator

| Field | Function |
|-----------------------------|--|
| 27-24 DCOC_BBA_CAL_GAIN3 | DCOC BBA Calibration Gain 3 The BBA gain index used for the 3rd DCOC calibration point. Used when RX_DCOC_CAL_EN=1. |
| 23-20 DCOC_LNA_CAL_GAIN2 | DCOC LNA Calibration Gain 2 The LNA gain index used for the 2nd DCOC calibration point. Used when RX_DCOC_CAL_EN=1. |
| 19-16 DCOC_BBA_CAL_GAIN2 | DCOC BBA Calibration Gain 2 The BBA gain index used for the 2nd DCOC calibration point. Used when RX_DCOC_CAL_EN=1. |
| 15-12 DCOC_LNA_CAL_GAIN1 | DCOC LNA Calibration Gain 1 The LNA gain index used for the 1st DCOC calibration point. Used when RX_DCOC_CAL_EN=1. |
| 11-8 DCOC_BBA_CAL_GAIN1 | DCOC BBA Calibration Gain 1 The BBA gain index used for the 1st DCOC calibration point. Used when RX_DCOC_CAL_EN=1. |
| 7-0 — | Reserved. |

45.4.3.3.1.15 DCOC Status (DCOC_STAT)

45.4.3.3.1.15.1 Offset

| Register | Offset |
|-----------|-----------|
| DCOC_STAT | 4005C038h |

45.4.3.3.1.15.2 Diagram

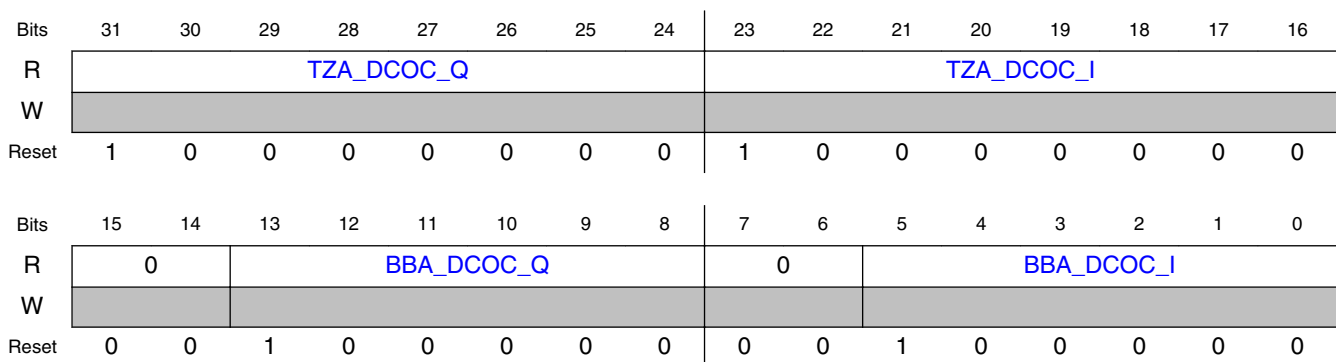

45.4.3.3.1.15.3 Fields

| Field | Function |
|---------------------|--|
| 31-24 TZA_DCOC_Q | DCOC TZA DAC Q Current TZA DAC setting for Q channel. Note that the TZA DACs have a bias of 0x80; 0x0 represents the most negative DC offset, 0x80 represents a DC offset of 0, and 0xFF represents the most positive DC offset. This is provided for debug and characterization purposes only. |
| 23-16 TZA_DCOC_I | DCOC TZA DAC I Current TZA DAC setting for I channel. Note that the TZA DACs have a bias of 0x80; 0x0 represents the most negative DC offset, 0x80 represents a DC offset of 0, and 0xFF represents the most positive DC offset. This is provided for debug and characterization purposes only. |
| 15-14 — | Reserved. |
| 13-8 BBA_DCOC_Q | DCOC BBA DAC Q Current BBA DAC setting for Q channel. Note that the BBA DACs have a bias of 0x20; 0x0 represents the most negative DC offset, 0x20 represents a DC offset of 0, and 0x3F represents the most positive DC offset. This is provided for debug and characterization purposes only. |
| 7-6 — | Reserved. |
| 5-0 BBA_DCOC_I | DCOC BBA DAC I Current BBA DAC setting for I channel. Note that the BBA DACs have a bias of 0x20; 0x0 represents the most negative DC offset, 0x20 represents a DC offset of 0, and 0x3F represents the most positive DC offset. This is provided for debug and characterization purposes only. |

45.4.3.3.1.16 DCOC DC Estimate (DCOC_DC_EST)

45.4.3.3.1.16.1 Offset

| Register | Offset |
|-------------|-----------|
| DCOC_DC_EST | 4005C03Ch |

45.4.3.3.1.16.2 Diagram

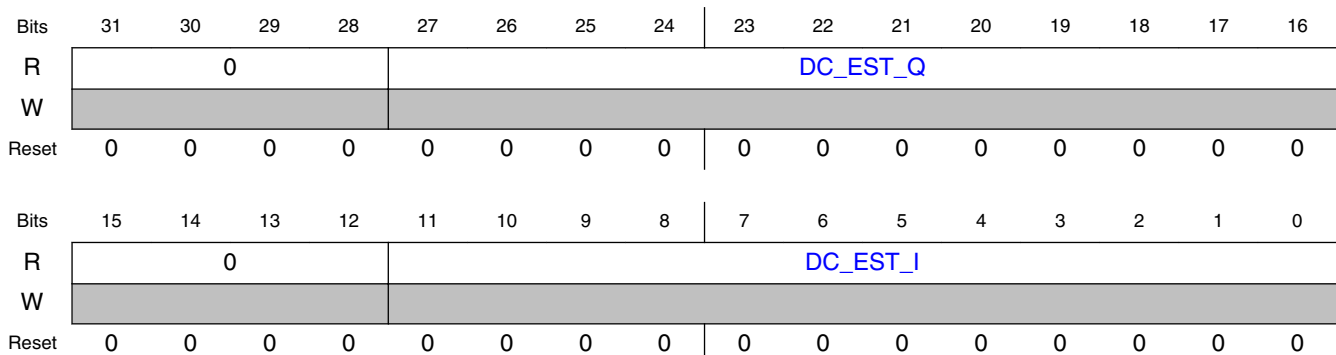

45.4.3.3.1.16.3 Fields

| Field | Function |
|-------------------|--|
| 31-28 — | Reserved. |
| 27-16 DC_EST_Q | DCOC DC Estimate Q Reflects the current DCOC DC tracking estimate for Q channel. Format s11. Used when DCOC_CORRECT_SRC=1. This is provided for debug and characterization purposes only. |
| 15-12 — | Reserved. |
| 11-0 DC_EST_I | DCOC DC Estimate I Reflects the current DCOC DC tracking estimate for I channel. Format s11. Used when DCOC_CORRECT_SRC=1. This is provided for debug and characterization purposes only. |

45.4.3.3.1.17 DCOC Calibration Reciprocals (DCOC_CAL_RCP)

45.4.3.3.1.17.1 Offset

| Register | Offset |
|--------------|-----------|
| DCOC_CAL_RCP | 4005C040h |

45.4.3.3.1.17.2 Diagram

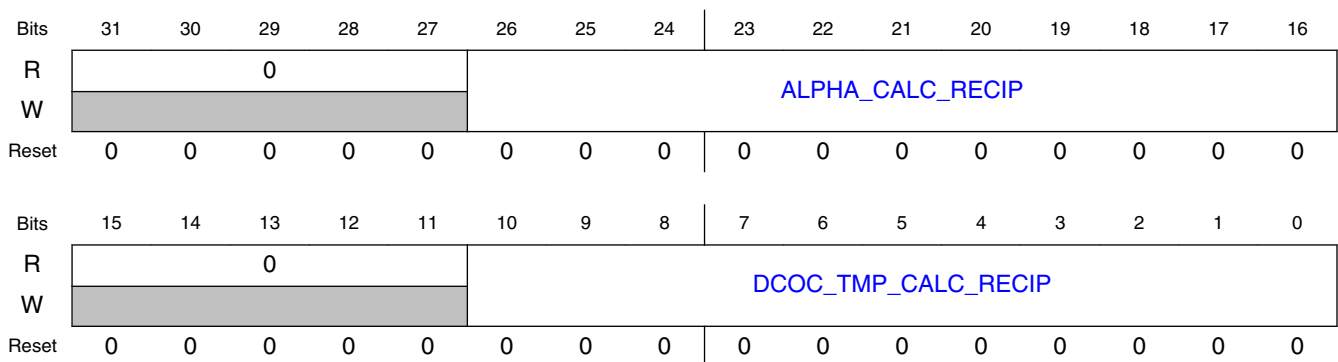

45.4.3.3.1.17.3 Fields

| Field | Function |
|-------|-----------|
| 31-27 | Reserved. |

Table continues on the next page...

| Field | Function |
|---------------------------------|---|
| — | |
| 26-16 ALPHA_CALC_ RECIP | Alpha Calculation Reciprocal DCOC Alpha calculation reciprocal (format: u.11). This is used in DCOC calibration calculation of the alpha DC component. It is defined as: $1.0/((G_{L_HI} - G_{L_LO}) * G_{B_LO})$ This is stored as with 11 fractional bits, so program the value $\text{round}([1.0/((G_{L_HI} - G_{L_LO}) * G_{B_LO})] * 2^{11})$. |
| 15-11 — | Reserved. |
| 10-0 DCOC_TMP_C ALC_RECIP | DCOC Calculation Reciprocal DCOC_tmp calculation reciprocal (format: u1.10). This is used in DCDC calibration calculation. It is defined as $1.0/(G_{B_HI} - G_{B_LO})$ This is stored with 10 fractional bits, so program the value $\text{round}([1.0/(G_{B_HI} - G_{B_LO})] * 2^{10})$. |

45.4.3.3.1.18 IQMC Control (IQMC_CTRL)

45.4.3.3.1.18.1 Offset

| Register | Offset |
|-----------|-----------|
| IQMC_CTRL | 4005C048h |

45.4.3.3.1.18.2 Function

IQMC Control register. This register can only be accessed when the radio oscillator clock is active.

45.4.3.3.1.18.3 Diagram

| | | | | | | | | | | | | | | | | |
|-------|---------------|----|----|----|----|------------------|----|----|----------|----|----|----|----|----|----|-------------|
| Bits | 31 | 30 | 29 | 28 | 27 | 26 | 25 | 24 | 23 | 22 | 21 | 20 | 19 | 18 | 17 | 16 |
| R | 0 | | | | | IQMC_DC_GAIN_ADJ | | | | | | | | | | |
| W | [Shaded] | | | | | [Shaded] | | | | | | | | | | |
| Reset | 0 | 0 | 0 | 0 | 0 | 1 | 0 | 0 | 0 | 0 | 0 | 0 | 0 | 0 | 0 | 0 |
| Bits | 15 | 14 | 13 | 12 | 11 | 10 | 9 | 8 | 7 | 6 | 5 | 4 | 3 | 2 | 1 | 0 |
| R | IQMC_NUM_ITER | | | | | | | | 0 | | | | | | | IQMC_CAL_EN |
| W | [Shaded] | | | | | | | | [Shaded] | | | | | | | [Shaded] |
| Reset | 1 | 0 | 0 | 0 | 0 | 0 | 0 | 0 | 0 | 0 | 0 | 0 | 0 | 0 | 0 | 0 |

45.4.3.3.1.18.4 Fields

| Field | Function |
|---------------------------|---|
| 31-27 — | Reserved. |
| 26-16 IQMC_DC_GAIN_ADJ | IQ Mismatch Correction DC Gain Coeff I/Q mismatch correction DC gain coefficient. This gain value is used only during DCOC calibration. It is not calculated during the IQMC calibration sequence, so it must be written by software. The format is u1.10; the reset value of 0x400 corresponds to a DC gain coefficient of 1.0. |
| 15-8 IQMC_NUM_ITER | IQ Mismatch Cal Num Iter Number of iterations for IQ Mismatch Calibration. |
| 7-1 — | Reserved. |
| 0 IQMC_CAL_EN | IQ Mismatch Cal Enable Enables IQ mismatch calibration. This bit is self-clearing; it will clear automatically at the end of the calibration sequence. |

45.4.3.3.1.19 IQMC Calibration (IQMC_CAL)

45.4.3.3.1.19.1 Offset

| Register | Offset |
|----------|-----------|
| IQMC_CAL | 4005C04Ch |

45.4.3.3.1.19.2 Function

IQMC Calibration register. This register can only be accessed when the radio oscillator clock is active.

45.4.3.3.1.19.3 Diagram

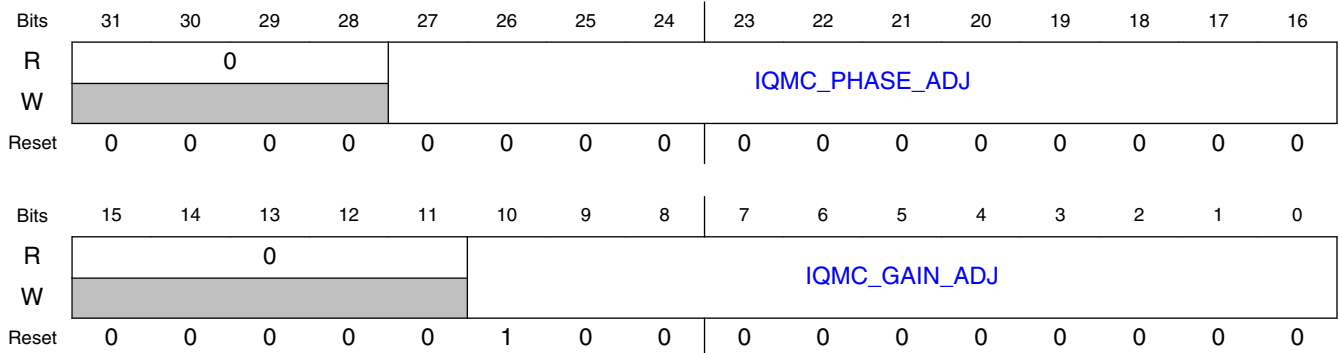

45.4.3.3.1.19.4 Fields

| Field | Function |
|-------------------------|--|
| 31-28 — | Reserved. |
| 27-16 IQMC_PHASE_ADJ | IQ Mismatch Correction Phase Coeff I/Q mismatch correction phase coefficient. This value is updated automatically at the end of the IQMC calibration sequence. It can also be written by software. The format is signed, with the maximum positive value 0x7ff corresponding to a phase coefficient of 0.25, and the maximum negative value 0x800 corresponding to -0.25. The reset value of 0x000 corresponds to a phase coefficient of 0. |
| 15-11 — | Reserved. |
| 10-0 IQMC_GAIN_ADJ | IQ Mismatch Correction Gain Coeff I/Q mismatch correction gain coefficient. This value is updated automatically at the end of the IQMC calibration sequence. It can also be written by software. The format is u1.10. The reset value of 0x400 corresponds to a gain coefficient of 1.0. |

45.4.3.3.1.20 LNA_GAIN Step Values 3..0 (LNA_GAIN_VAL_3_0)

45.4.3.3.1.20.1 Offset

| Register | Offset |
|------------------|-----------|
| LNA_GAIN_VAL_3_0 | 4005C050h |

45.4.3.3.1.20.2 Diagram

| | | | | | | | | | | | | | | | | |
|-------|----------------|----|----|----|----|----|----|----|----------------|----|----|----|----|----|----|----|
| Bits | 31 | 30 | 29 | 28 | 27 | 26 | 25 | 24 | 23 | 22 | 21 | 20 | 19 | 18 | 17 | 16 |
| R | LNA_GAIN_VAL_3 | | | | | | | | LNA_GAIN_VAL_2 | | | | | | | |
| W | | | | | | | | | | | | | | | | |
| Reset | 0 | 0 | 1 | 1 | 1 | 0 | 0 | 0 | 0 | 0 | 0 | 0 | 1 | 0 | 0 | 1 |
| Bits | 15 | 14 | 13 | 12 | 11 | 10 | 9 | 8 | 7 | 6 | 5 | 4 | 3 | 2 | 1 | 0 |
| R | LNA_GAIN_VAL_1 | | | | | | | | LNA_GAIN_VAL_0 | | | | | | | |
| W | | | | | | | | | | | | | | | | |
| Reset | 0 | 0 | 1 | 1 | 0 | 0 | 1 | 0 | 0 | 0 | 0 | 1 | 1 | 1 | 0 | 1 |

45.4.3.3.1.20.3 Fields

| Field | Function |
|-------------------------|---|
| 31-24 LNA_GAIN_VAL_3 | LNA_GAIN step 3 Gain for LNA gain Step 3, used in RSSI calculation. Unsigned, 4*(measured_gain_dB). |
| 23-16 LNA_GAIN_VAL_2 | LNA_GAIN step 2 Gain for LNA gain Step 2, used in RSSI calculation. Unsigned, 4*(measured_gain_dB). |
| 15-8 LNA_GAIN_VAL_1 | LNA_GAIN step 1 Gain for LNA gain Step 1, used in RSSI calculation. Unsigned, 4*(measured_gain_dB+16). |
| 7-0 LNA_GAIN_VAL_0 | LNA_GAIN step 0 Gain for LNA gain Step 0, used in RSSI calculation. Unsigned, 4*(measured_gain_dB+16). |

45.4.3.3.1.21 LNA_GAIN Step Values 7..4 (LNA_GAIN_VAL_7_4)

45.4.3.3.1.21.1 Offset

| Register | Offset |
|------------------|-----------|
| LNA_GAIN_VAL_7_4 | 4005C054h |

45.4.3.3.1.21.2 Diagram

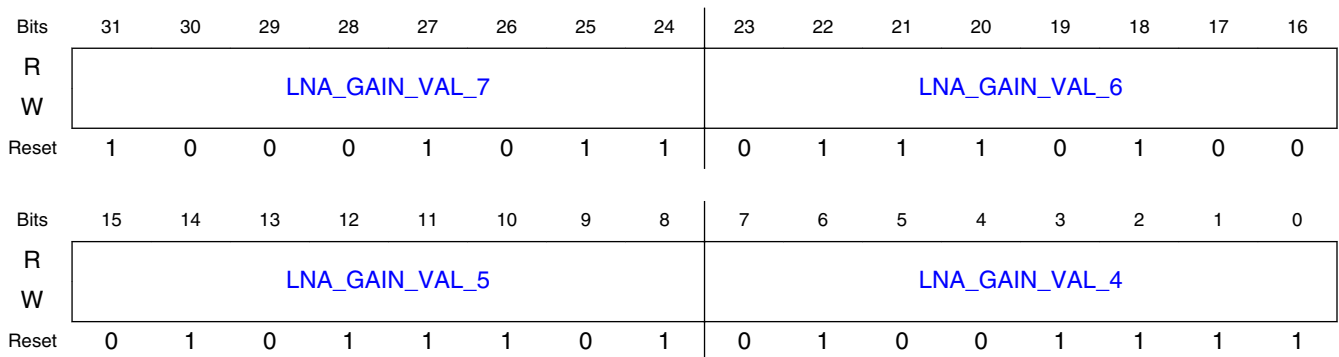

45.4.3.3.1.21.3 Fields

| Field | Function |
|-------|--|
| 31-24 | LNA_GAIN step 7 Gain for LNA gain Step 7, used in RSSI calculation. Unsigned, 4*(measured_gain_dB). |

Table continues on the next page...

| Field | Function |
|----------------|---|
| LNA_GAIN_VAL_7 | |
| 23-16 | LNA_GAIN step 6 |
| LNA_GAIN_VAL_6 | Gain for LNA gain Step 6, used in RSSI calculation. Unsigned, 4*(measured_gain_dB). |
| 15-8 | LNA_GAIN step 5 |
| LNA_GAIN_VAL_5 | Gain for LNA gain Step 5, used in RSSI calculation. Unsigned, 4*(measured_gain_dB). |
| 7-0 | LNA_GAIN step 4 |
| LNA_GAIN_VAL_4 | Gain for LNA gain Step 4, used in RSSI calculation. Unsigned, 4*(measured_gain_dB). |

45.4.3.3.1.22 LNA_GAIN Step Values 8 (LNA_GAIN_VAL_8)

45.4.3.3.1.22.1 Offset

| Register | Offset |
|----------------|-----------|
| LNA_GAIN_VAL_8 | 4005C058h |

45.4.3.3.1.22.2 Diagram

| | | | | | | | | | | | | | | | | |
|-------|----------------|----|----|----|----|----|----|----|----------------|----|----|----|----|----|----|----|
| Bits | 31 | 30 | 29 | 28 | 27 | 26 | 25 | 24 | 23 | 22 | 21 | 20 | 19 | 18 | 17 | 16 |
| R | 0 | | | | | | | | | | | | | | | |
| W | | | | | | | | | | | | | | | | |
| Reset | 0 | 0 | 0 | 0 | 0 | 0 | 0 | 0 | 0 | 0 | 0 | 0 | 0 | 0 | 0 | 0 |
| Bits | 15 | 14 | 13 | 12 | 11 | 10 | 9 | 8 | 7 | 6 | 5 | 4 | 3 | 2 | 1 | 0 |
| R | LNA_GAIN_VAL_9 | | | | | | | | LNA_GAIN_VAL_8 | | | | | | | |
| W | | | | | | | | | | | | | | | | |
| Reset | 1 | 0 | 1 | 1 | 0 | 1 | 1 | 0 | 1 | 0 | 1 | 0 | 0 | 0 | 0 | 1 |

45.4.3.3.1.22.3 Fields

| Field | Function |
|-------|--|
| 31-16 | Reserved. |
| — | |
| 15-8 | LNA_GAIN step 9 Gain for LNA gain Step 9, used in RSSI calculation. Unsigned, 4*(measured_gain_dB). |

Table continues on the next page...

FSK Modulator

| Field | Function |
|----------------|---|
| LNA_GAIN_VAL_9 | |
| 7-0 | LNA_GAIN step 8 |
| LNA_GAIN_VAL_8 | Gain for LNA gain Step 8, used in RSSI calculation. Unsigned, 4*(measured_gain_dB). |

45.4.3.3.1.23 BBA Resistor Tune Values 7..0 (BBA_RES_TUNE_VAL_7_0)

45.4.3.3.1.23.1 Offset

| Register | Offset |
|----------------------|-----------|
| BBA_RES_TUNE_VAL_7_0 | 4005C05Ch |

45.4.3.3.1.23.2 Diagram

| | | | | | | | | | | | | | | | | |
|-------|--------------------|----|----|----|--------------------|----|----|----|--------------------|----|----|----|--------------------|----|----|----|
| Bits | 31 | 30 | 29 | 28 | 27 | 26 | 25 | 24 | 23 | 22 | 21 | 20 | 19 | 18 | 17 | 16 |
| R | BBA_RES_TUNE_VAL_7 | | | | BBA_RES_TUNE_VAL_6 | | | | BBA_RES_TUNE_VAL_5 | | | | BBA_RES_TUNE_VAL_4 | | | |
| W | BBA_RES_TUNE_VAL_7 | | | | BBA_RES_TUNE_VAL_6 | | | | BBA_RES_TUNE_VAL_5 | | | | BBA_RES_TUNE_VAL_4 | | | |
| Reset | 0 | 0 | 0 | 0 | 0 | 0 | 0 | 0 | 0 | 0 | 0 | 0 | 0 | 0 | 0 | 0 |
| Bits | 15 | 14 | 13 | 12 | 11 | 10 | 9 | 8 | 7 | 6 | 5 | 4 | 3 | 2 | 1 | 0 |
| R | BBA_RES_TUNE_VAL_3 | | | | BBA_RES_TUNE_VAL_2 | | | | BBA_RES_TUNE_VAL_1 | | | | BBA_RES_TUNE_VAL_0 | | | |
| W | BBA_RES_TUNE_VAL_3 | | | | BBA_RES_TUNE_VAL_2 | | | | BBA_RES_TUNE_VAL_1 | | | | BBA_RES_TUNE_VAL_0 | | | |
| Reset | 0 | 0 | 0 | 0 | 0 | 0 | 0 | 0 | 0 | 0 | 0 | 0 | 0 | 0 | 0 | 0 |

45.4.3.3.1.23.3 Fields

| Field | Function |
|--------------------|---|
| 31-28 | BBA Resistor Tune Step 7 |
| BBA_RES_TUNE_VAL_7 | Gain offset for BBA gain Step 7, used in RSSI calculation. Signed, 2*(measured_gain_dB - spec_gain_dB). |
| 27-24 | BBA Resistor Tune Step 6 |
| BBA_RES_TUNE_VAL_6 | Gain offset for BBA gain Step 6, used in RSSI calculation. Signed, 2*(measured_gain_dB - spec_gain_dB). |
| 23-20 | BBA Resistor Tune Step 5 |
| BBA_RES_TUNE_VAL_5 | Gain offset for BBA gain Step 5, used in RSSI calculation. Signed, 2*(measured_gain_dB - spec_gain_dB). |

Table continues on the next page...

| Field | Function |
|---------------------------------|--|
| 19-16 BBA_RES_TUN E_VAL_4 | BBA Resistor Tune Step 4 Gain offset for BBA gain Step 4, used in RSSI calculation. Signed, $2*(\text{measured_gain_dB} - \text{spec_gain_dB})$. |
| 15-12 BBA_RES_TUN E_VAL_3 | BBA Resistor Tune Step 3 Gain offset for BBA gain Step 3, used in RSSI calculation. Signed, $2*(\text{measured_gain_dB} - \text{spec_gain_dB})$. |
| 11-8 BBA_RES_TUN E_VAL_2 | BBA Resistor Tune Step 2 Gain offset for BBA gain Step 2, used in RSSI calculation. Signed, $2*(\text{measured_gain_dB} - \text{spec_gain_dB})$. |
| 7-4 BBA_RES_TUN E_VAL_1 | BBA Resistor Tune Step 1 Gain offset for BBA gain Step 1, used in RSSI calculation. Signed, $2*(\text{measured_gain_dB} - \text{spec_gain_dB})$. |
| 3-0 BBA_RES_TUN E_VAL_0 | BBA Resistor Tune Step 0 Gain offset for BBA gain Step 0, used in RSSI calculation. Signed, $2*(\text{measured_gain_dB} - \text{spec_gain_dB})$. |

45.4.3.3.1.24 BBA Resistor Tune Values 10..8 (BBA_RES_TUNE_VAL_10_8)

45.4.3.3.1.24.1 Offset

| Register | Offset |
|-----------------------|-----------|
| BBA_RES_TUNE_VAL_10_8 | 4005C060h |

45.4.3.3.1.24.2 Diagram

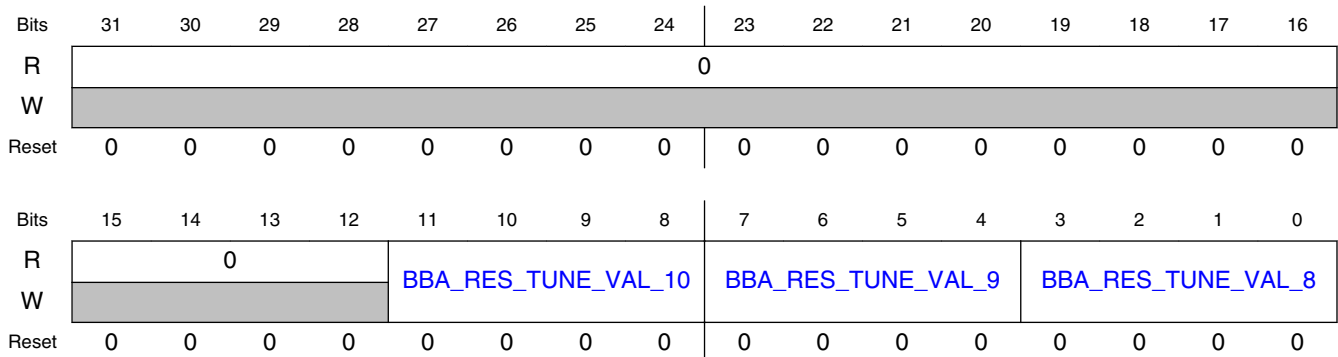

45.4.3.3.1.24.3 Fields

| Field | Function |
|---------------------------------|---|
| 31-12 Reserved | Reserved. |
| 11-8 BBA_RES_TUN E_VAL_10 | BBA Resistor Tune Step 10 Gain offset for BBA gain Step 10, used in RSSI calculation. Signed, 2*(measured_gain_dB - spec_gain_dB). |
| 7-4 BBA_RES_TUN E_VAL_9 | BBA Resistor Tune Step 9 Gain offset for BBA gain Step 9, used in RSSI calculation. Signed, 2*(measured_gain_dB - spec_gain_dB). |
| 3-0 BBA_RES_TUN E_VAL_8 | BBA Resistor Tune Step 8 Gain offset for BBA gain Step 8, used in RSSI calculation. Signed, 2*(measured_gain_dB - spec_gain_dB). |

45.4.3.3.1.25 LNA Linear Gain Values 2..0 (LNA_GAIN_LIN_VAL_2_0)

45.4.3.3.1.25.1 Offset

| Register | Offset |
|----------------------|-----------|
| LNA_GAIN_LIN_VAL_2_0 | 4005C064h |

45.4.3.3.1.25.2 Diagram

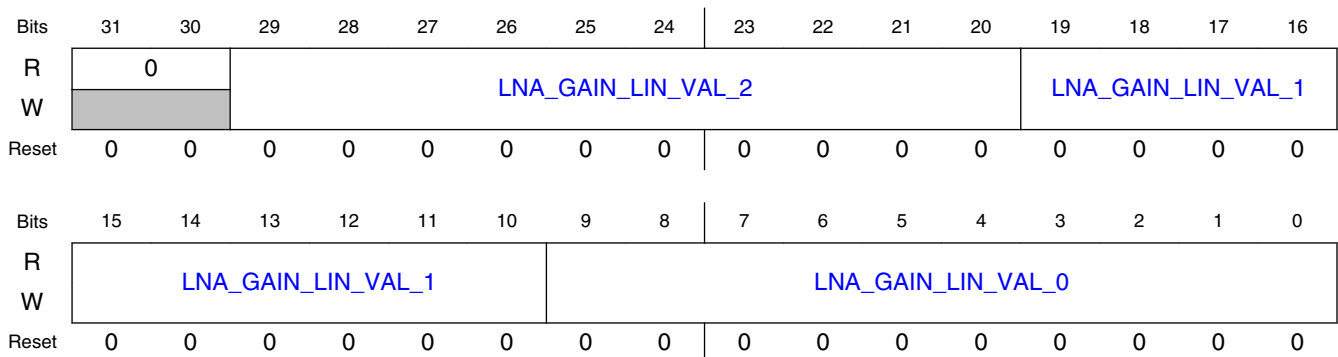

45.4.3.3.1.25.3 Fields

| Field | Function |
|-------|-----------|
| 31-30 | Reserved. |

Table continues on the next page...

| Field | Function |
|-----------------------------|---|
| — | |
| 29-20 LNA_GAIN_LIN_VAL_2 | LNA Linear Gain Step 2 LNA linear gain value for index 2, e.g. nominal value is $10^{(2.2/20)}$. Stored with 2 fractional bits, e.g. $\text{round}([10^{(2.2/20)}] * 2^2) = 5$ decimal. Format (8.2). |
| 19-10 LNA_GAIN_LIN_VAL_1 | LNA Linear Gain Step 1 LNA linear gain value for index 1, e.g. nominal value is $10^{(-3.5/20)}$. Stored with 2 fractional bits, e.g. $\text{round}([10^{(-3.5/20)}] * 2^2) = 3$ decimal. Format (8.2). |
| 9-0 LNA_GAIN_LIN_VAL_0 | LNA Linear Gain Step 0 LNA linear gain value for index 0, e.g. nominal value is $10^{(-8.6/20)}$. Stored with 2 fractional bits, e.g. $\text{round}([10^{(-8.6/20)}] * 2^2) = 1$ decimal. Format (8.2). |

45.4.3.3.1.26 LNA Linear Gain Values 5..3 (LNA_GAIN_LIN_VAL_5_3)

45.4.3.3.1.26.1 Offset

| Register | Offset |
|----------------------|-----------|
| LNA_GAIN_LIN_VAL_5_3 | 4005C068h |

45.4.3.3.1.26.2 Diagram

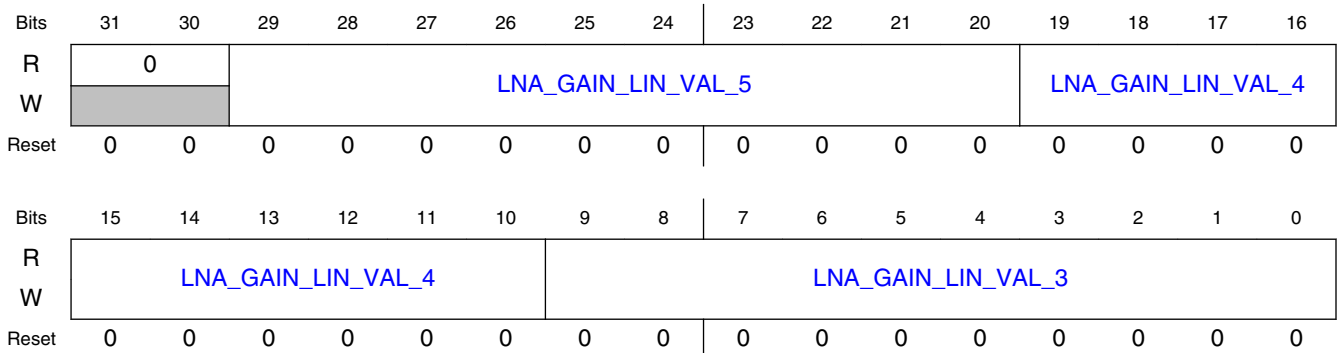

45.4.3.3.1.26.3 Fields

| Field | Function |
|-------|------------------------|
| 31-30 | Reserved. |
| — | |
| 29-20 | LNA Linear Gain Step 5 |

Table continues on the next page...

FSK Modulator

| Field | Function |
|--------------------|--|
| LNA_GAIN_LIN_VAL_5 | LNA linear gain value for index 5, e.g. nominal value is $10^{(22.7/20)}$. Stored with 2 fractional bits, e.g. $\text{round}([10^{(22.7/20)}] * 2^2) = 55$ decimal. Format (8.2). |
| 19-10 | LNA Linear Gain Step 4 |
| LNA_GAIN_LIN_VAL_4 | LNA linear gain value for index 4, e.g. nominal value is $10^{(19.8/20)}$. Stored with 2 fractional bits, e.g. $\text{round}([10^{(19.8/20)}] * 2^2) = 39$ decimal. Format (8.2). |
| 9-0 | LNA Linear Gain Step 3 |
| LNA_GAIN_LIN_VAL_3 | LNA linear gain value for index 3, e.g. nominal value is $10^{(13.9/20)}$. Stored with 2 fractional bits, e.g. $\text{round}([10^{(13.9/20)}] * 2^2) = 20$ decimal. Format (8.2). |

45.4.3.3.1.27 LNA Linear Gain Values 8..6 (LNA_GAIN_LIN_VAL_8_6)

45.4.3.3.1.27.1 Offset

| Register | Offset |
|----------------------|-----------|
| LNA_GAIN_LIN_VAL_8_6 | 4005C06Ch |

45.4.3.3.1.27.2 Diagram



45.4.3.3.1.27.3 Fields

| Field | Function |
|--------------------|---|
| 31-30 — | Reserved. |
| 29-20 | LNA Linear Gain Step 8 |
| LNA_GAIN_LIN_VAL_8 | LNA linear gain value for index 8, e.g. nominal value is $10^{(39.9/20)}$. Stored with 2 fractional bits, e.g. $\text{round}([10^{(39.9/20)}] * 2^2) = 396$ decimal. Format (8.2). |
| 19-10 | LNA Linear Gain Step 7 |

Table continues on the next page...

| Field | Function |
|--------------------|---|
| LNA_GAIN_LIN_VAL_7 | LNA linear gain value for index 7, e.g. nominal value is $10^{(34.4/20)}$. Stored with 2 fractional bits, e.g. $\text{round}([10^{(34.4/20)}] * 2^2) = 210$ decimal. Format (8.2). |
| 9-0 | LNA Linear Gain Step 6 |
| LNA_GAIN_LIN_VAL_6 | LNA linear gain value for index 6, e.g. nominal value is $10^{(28.6/20)}$. Stored with 2 fractional bits, e.g. $\text{round}([10^{(28.6/20)}] * 2^2) = 108$ decimal. Format (8.2). |

45.4.3.3.1.28 LNA Linear Gain Values 9 (LNA_GAIN_LIN_VAL_9)

45.4.3.3.1.28.1 Offset

| Register | Offset |
|--------------------|-----------|
| LNA_GAIN_LIN_VAL_9 | 4005C070h |

45.4.3.3.1.28.2 Diagram

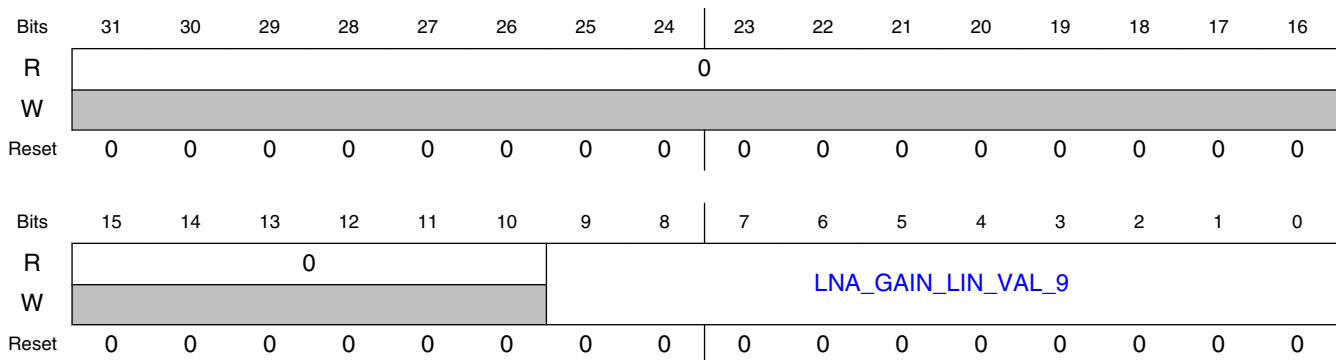

45.4.3.3.1.28.3 Fields

| Field | Function |
|--------------------|---|
| 31-10 Reserved | Reserved. |
| 9-0 | LNA Linear Gain Step 9 |
| LNA_GAIN_LIN_VAL_9 | LNA linear gain value for index 9, e.g. nominal value is $10^{(45.4/20)}$. Stored with 2 fractional bits, e.g. $\text{round}([10^{(45.4/20)}] * 2^2) = 744$ decimal. Format (8.2). |

45.4.3.3.1.29 BBA Resistor Tune Values 3..0 (BBA_RES_TUNE_LIN_VAL_3_0)

45.4.3.3.1.29.1 Offset

| Register | Offset |
|--------------------------|-----------|
| BBA_RES_TUNE_LIN_VAL_3_0 | 4005C074h |

45.4.3.3.1.29.2 Diagram

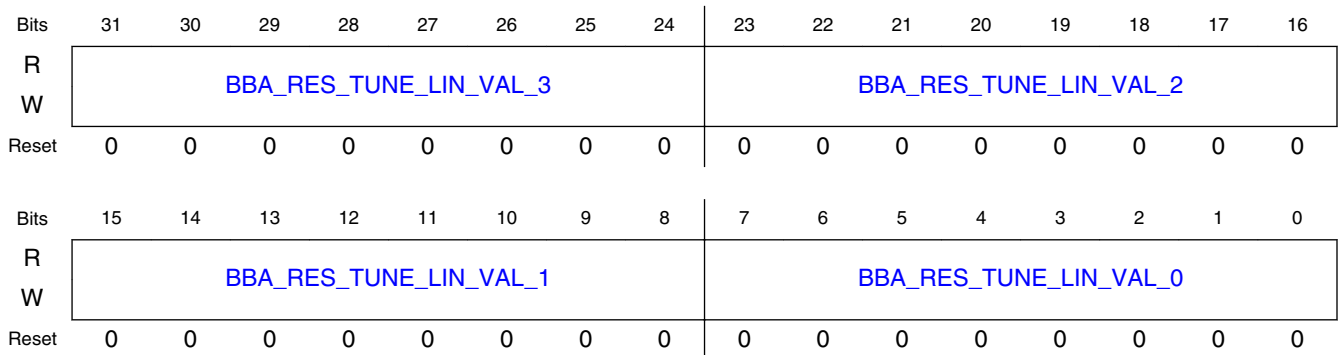

45.4.3.3.1.29.3 Fields

| Field | Function |
|---------------------------------|---|
| 31-24 BBA_RES_TUNE_LIN_VAL_3 | BBA Resistor Tune Linear Gain Step 3 BBA linear gain value for index 3 (format: u5.3). Nominal value is $10^{(9/20)}$. Stored with 3 fractional bits, e.g. $\text{round}([10^{(9/20)}] * 2^3) = 23$ decimal |
| 23-16 BBA_RES_TUNE_LIN_VAL_2 | BBA Resistor Tune Linear Gain Step 2 BBA linear gain value for index 2 (format: u5.3). Nominal value is $10^{(6/20)}$. Stored with 3 fractional bits, e.g. $\text{round}([10^{(6/20)}] * 2^3) = 16$ decimal |
| 15-8 BBA_RES_TUNE_LIN_VAL_1 | BBA Resistor Tune Linear Gain Step 1 BBA linear gain value for index 1 (format: u5.3). Nominal value is $10^{(3/20)}$. Stored with 3 fractional bits, e.g. $\text{round}([10^{(3/20)}] * 2^3) = 11$ decimal |
| 7-0 BBA_RES_TUNE_LIN_VAL_0 | BBA Resistor Tune Linear Gain Step 0 BBA linear gain value for index 0 (format: u5.3). Nominal value is $10^{(0/20)}$. Stored with 3 fractional bits, e.g. $\text{round}([10^{(0/20)}] * 2^3) = 8$ decimal |

45.4.3.3.1.30 BBA Resistor Tune Values 7..4 (BBA_RES_TUNE_LIN_VAL_7_4)

45.4.3.3.1.30.1 Offset

| Register | Offset |
|--------------------------|-----------|
| BBA_RES_TUNE_LIN_VAL_7_4 | 4005C078h |

45.4.3.3.1.30.2 Diagram

| | | | | | | | | | | | | | | | | |
|-------|------------------------|----|----|----|----|----|----|----|------------------------|----|----|----|----|----|----|----|
| Bits | 31 | 30 | 29 | 28 | 27 | 26 | 25 | 24 | 23 | 22 | 21 | 20 | 19 | 18 | 17 | 16 |
| R | BBA_RES_TUNE_LIN_VAL_7 | | | | | | | | BBA_RES_TUNE_LIN_VAL_6 | | | | | | | |
| W | | | | | | | | | | | | | | | | |
| Reset | 0 | 0 | 0 | 0 | 0 | 0 | 0 | 0 | 0 | 0 | 0 | 0 | 0 | 0 | 0 | 0 |
| Bits | 15 | 14 | 13 | 12 | 11 | 10 | 9 | 8 | 7 | 6 | 5 | 4 | 3 | 2 | 1 | 0 |
| R | BBA_RES_TUNE_LIN_VAL_5 | | | | | | | | BBA_RES_TUNE_LIN_VAL_4 | | | | | | | |
| W | | | | | | | | | | | | | | | | |
| Reset | 0 | 0 | 0 | 0 | 0 | 0 | 0 | 0 | 0 | 0 | 0 | 0 | 0 | 0 | 0 | 0 |

45.4.3.3.1.30.3 Fields

| Field | Function |
|-------------------------------------|---|
| 31-24 BBA_RES_TUN E_LIN_VAL_7 | BBA Resistor Tune Linear Gain Step 7 BBA linear gain value for index 7 (format: u6.2). Nominal value is $10^{(21/20)}$. Stored with 2 fractional bits, e.g. $\text{round}([10^{(21/20)}] * 2^2) = 45$ decimal |
| 23-16 BBA_RES_TUN E_LIN_VAL_6 | BBA Resistor Tune Linear Gain Step 6 BBA linear gain value for index 6 (format: u5.3). Nominal value is $10^{(18/20)}$. Stored with 3 fractional bits, e.g. $\text{round}([10^{(18/20)}] * 2^3) = 64$ decimal |
| 15-8 BBA_RES_TUN E_LIN_VAL_5 | BBA Resistor Tune Linear Gain Step 5 BBA linear gain value for index 5 (format: u5.3). Nominal value is $10^{(15/20)}$. Stored with 3 fractional bits, e.g. $\text{round}([10^{(15/20)}] * 2^3) = 45$ decimal |
| 7-0 BBA_RES_TUN E_LIN_VAL_4 | BBA Resistor Tune Linear Gain Step 4 BBA linear gain value for index 4 (format: u5.3). Nominal value is $10^{(12/20)}$. Stored with 3 fractional bits, e.g. $\text{round}([10^{(12/20)}] * 2^3) = 32$ decimal |

45.4.3.3.1.31 BBA Resistor Tune Values 10..8 (BBA_RES_TUNE_LIN_VAL_10_8)

45.4.3.3.1.31.1 Offset

| Register | Offset |
|---------------------------|-----------|
| BBA_RES_TUNE_LIN_VAL_10_8 | 4005C07Ch |

45.4.3.3.1.31.2 Diagram

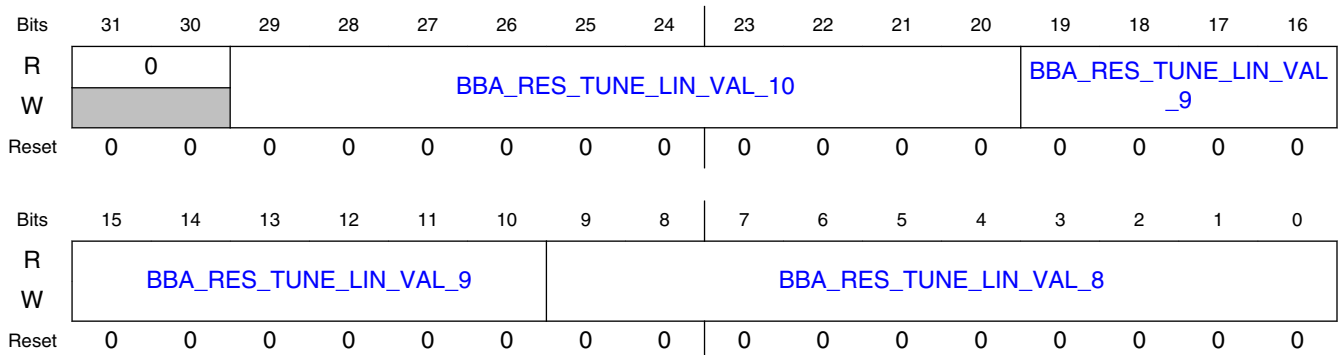

45.4.3.3.1.31.3 Fields

| Field | Function |
|----------------------------------|---|
| 31-30 — | Reserved. |
| 29-20 BBA_RES_TUNE_LIN_VAL_10 | BBA Resistor Tune Linear Gain Step 10 BBA linear gain value for index 10 (format: u7.3). Nominal value is 10 ^(30/20) . Stored with 3 fractional bits, e.g. round([10 ^(30/20)]*2 ³) = 253decimal |
| 19-10 BBA_RES_TUNE_LIN_VAL_9 | BBA Resistor Tune Linear Gain Step 9 BBA linear gain value for index 9 (format: u7.3). Nominal value is 10 ^(27/20) . Stored with 3 fractional bits, e.g. round([10 ^(27/20)]*2 ³) = 179decimal |
| 9-0 BBA_RES_TUNE_LIN_VAL_8 | BBA Resistor Tune Linear Gain Step 8 BBA linear gain value for index 8 (format: u7.3). Nominal value is 10 ^(24/20) . Stored with 3 fractional bits, e.g. round([10 ^(24/20)]*2 ³) = 127decimal |

45.4.3.3.1.32 AGC Gain Tables Step 03..00 (AGC_GAIN_TBL_03_00)

45.4.3.3.1.32.1 Offset

| Register | Offset |
|--------------------|-----------|
| AGC_GAIN_TBL_03_00 | 4005C080h |

45.4.3.3.1.32.2 *Diagram*

| | | | | | | | | | | | | | | | | |
|-------|-------------|----|----|----|-------------|----|----|----|-------------|----|----|----|-------------|----|----|----|
| Bits | 31 | 30 | 29 | 28 | 27 | 26 | 25 | 24 | 23 | 22 | 21 | 20 | 19 | 18 | 17 | 16 |
| R | LNA_GAIN_03 | | | | BBA_GAIN_03 | | | | LNA_GAIN_02 | | | | BBA_GAIN_02 | | | |
| W | LNA_GAIN_03 | | | | BBA_GAIN_03 | | | | LNA_GAIN_02 | | | | BBA_GAIN_02 | | | |
| Reset | 0 | 0 | 0 | 0 | 0 | 0 | 0 | 0 | 0 | 0 | 0 | 0 | 0 | 0 | 0 | 0 |
| Bits | 15 | 14 | 13 | 12 | 11 | 10 | 9 | 8 | 7 | 6 | 5 | 4 | 3 | 2 | 1 | 0 |
| R | LNA_GAIN_01 | | | | BBA_GAIN_01 | | | | LNA_GAIN_00 | | | | BBA_GAIN_00 | | | |
| W | LNA_GAIN_01 | | | | BBA_GAIN_01 | | | | LNA_GAIN_00 | | | | BBA_GAIN_00 | | | |
| Reset | 0 | 0 | 0 | 0 | 0 | 0 | 0 | 0 | 0 | 0 | 0 | 0 | 0 | 0 | 0 | 0 |

45.4.3.3.1.32.3 *Fields*

| Field | Function |
|----------------------|--|
| 31-28 LNA_GAIN_03 | LNA Gain 03 LNA GAIN. See Table 45-17 for the mapping of LNA gain indexes to gain values. |
| 27-24 BBA_GAIN_03 | BBA Gain 03 BBA GAIN 0=0 dB, 1=3 dB, 2=6 dB ... A=30 dB. |
| 23-20 LNA_GAIN_02 | LNA Gain 02 LNA GAIN. See Table 45-17 for the mapping of LNA gain indexes to gain values. |
| 19-16 BBA_GAIN_02 | BBA Gain 02 BBA GAIN 0=0 dB, 1=3 dB, 2=6 dB ... A=30 dB. |
| 15-12 LNA_GAIN_01 | LNA Gain 01 LNA GAIN. See Table 45-17 for the mapping of LNA gain indexes to gain values. |
| 11-8 BBA_GAIN_01 | BBA Gain 01 BBA GAIN 0=0 dB, 1=3 dB, 2=6 dB ... A=30 dB. |
| 7-4 LNA_GAIN_00 | LNA Gain 00 LNA GAIN. See Table 45-17 for the mapping of LNA gain indexes to gain values. |
| 3-0 BBA_GAIN_00 | BBA Gain 00 BBA GAIN. |

45.4.3.3.1.33 **AGC Gain Tables Step 07..04 (AGC_GAIN_TBL_07_04)**45.4.3.3.1.33.1 *Offset*

| Register | Offset |
|--------------------|-----------|
| AGC_GAIN_TBL_07_04 | 4005C084h |

45.4.3.3.1.33.2 Diagram

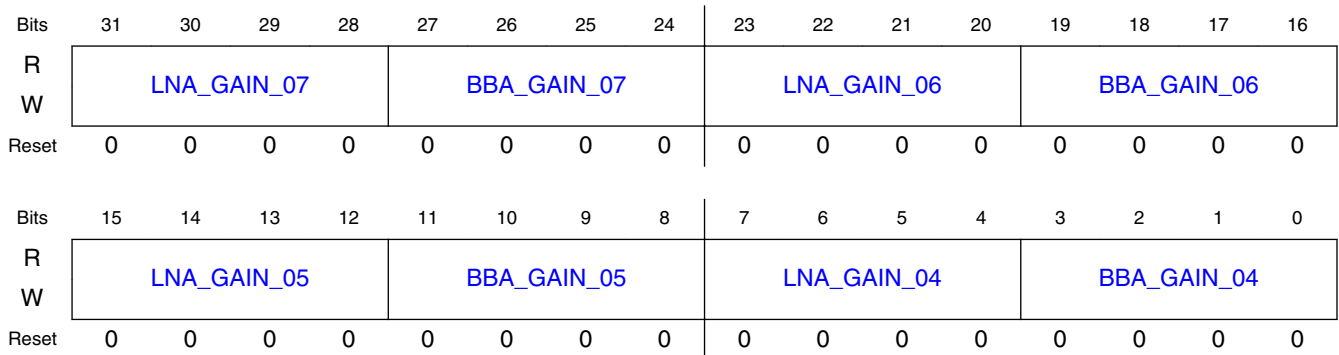

45.4.3.3.1.33.3 Fields

| Field | Function |
|----------------------|--|
| 31-28 LNA_GAIN_07 | LNA Gain 07 LNA GAIN. See Table 45-17 for the mapping of LNA gain indexes to gain values. |
| 27-24 BBA_GAIN_07 | BBA Gain 07 BBA GAIN 0=0 dB, 1=3 dB, 2=6 dB ... A=30 dB. |
| 23-20 LNA_GAIN_06 | LNA Gain 06 LNA GAIN. See Table 45-17 for the mapping of LNA gain indexes to gain values. |
| 19-16 BBA_GAIN_06 | BBA Gain 06 BBA GAIN 0=0 dB, 1=3 dB, 2=6 dB ... A=30 dB. |
| 15-12 LNA_GAIN_05 | LNA Gain 05 LNA GAIN. See Table 45-17 for the mapping of LNA gain indexes to gain values. |
| 11-8 BBA_GAIN_05 | BBA Gain 05 BBA GAIN 0=0 dB, 1=3 dB, 2=6 dB ... A=30 dB. |
| 7-4 LNA_GAIN_04 | LNA Gain 04 LNA GAIN. See Table 45-17 for the mapping of LNA gain indexes to gain values. |
| 3-0 BBA_GAIN_04 | BBA Gain 04 BBA GAIN 0=0 dB, 1=3 dB, 2=6 dB ... A=30 dB. |

45.4.3.3.1.34 AGC Gain Tables Step 11..08 (AGC_GAIN_TBL_11_08)

45.4.3.3.1.34.1 Offset

| Register | Offset |
|--------------------|-----------|
| AGC_GAIN_TBL_11_08 | 4005C088h |

45.4.3.3.1.34.2 *Diagram*

| | | | | | | | | | | | | | | | | |
|-------|-------------|----|----|----|-------------|----|----|----|-------------|----|----|----|-------------|----|----|----|
| Bits | 31 | 30 | 29 | 28 | 27 | 26 | 25 | 24 | 23 | 22 | 21 | 20 | 19 | 18 | 17 | 16 |
| R | LNA_GAIN_11 | | | | BBA_GAIN_11 | | | | LNA_GAIN_10 | | | | BBA_GAIN_10 | | | |
| W | LNA_GAIN_11 | | | | BBA_GAIN_11 | | | | LNA_GAIN_10 | | | | BBA_GAIN_10 | | | |
| Reset | 0 | 0 | 0 | 0 | 0 | 0 | 0 | 0 | 0 | 0 | 0 | 0 | 0 | 0 | 0 | 0 |
| Bits | 15 | 14 | 13 | 12 | 11 | 10 | 9 | 8 | 7 | 6 | 5 | 4 | 3 | 2 | 1 | 0 |
| R | LNA_GAIN_09 | | | | BBA_GAIN_09 | | | | LNA_GAIN_08 | | | | BBA_GAIN_08 | | | |
| W | LNA_GAIN_09 | | | | BBA_GAIN_09 | | | | LNA_GAIN_08 | | | | BBA_GAIN_08 | | | |
| Reset | 0 | 0 | 0 | 0 | 0 | 0 | 0 | 0 | 0 | 0 | 0 | 0 | 0 | 0 | 0 | 0 |

45.4.3.3.1.34.3 *Fields*

| Field | Function |
|----------------------|--|
| 31-28 LNA_GAIN_11 | LNA Gain 11 LNA GAIN. See Table 45-17 for the mapping of LNA gain indexes to gain values. |
| 27-24 BBA_GAIN_11 | BBA Gain 11 BBA GAIN 0=0 dB, 1=3 dB, 2=6 dB ... A=30 dB. |
| 23-20 LNA_GAIN_10 | LNA Gain 10 LNA GAIN. See Table 45-17 for the mapping of LNA gain indexes to gain values. |
| 19-16 BBA_GAIN_10 | BBA Gain 10 BBA GAIN 0=0 dB, 1=3 dB, 2=6 dB ... A=30 dB. |
| 15-12 LNA_GAIN_09 | LNA Gain 09 LNA GAIN. See Table 45-17 for the mapping of LNA gain indexes to gain values. |
| 11-8 BBA_GAIN_09 | BBA Gain 09 BBA GAIN 0=0 dB, 1=3 dB, 2=6 dB ... A=30 dB. |
| 7-4 LNA_GAIN_08 | LNA Gain 08 LNA GAIN. See Table 45-17 for the mapping of LNA gain indexes to gain values. |
| 3-0 BBA_GAIN_08 | BBA Gain 08 BBA GAIN 0=0 dB, 1=3 dB, 2=6 dB ... A=30 dB. |

45.4.3.3.1.35 **AGC Gain Tables Step 15..12 (AGC_GAIN_TBL_15_12)**45.4.3.3.1.35.1 *Offset*

| Register | Offset |
|--------------------|-----------|
| AGC_GAIN_TBL_15_12 | 4005C08Ch |

45.4.3.3.1.35.2 Diagram

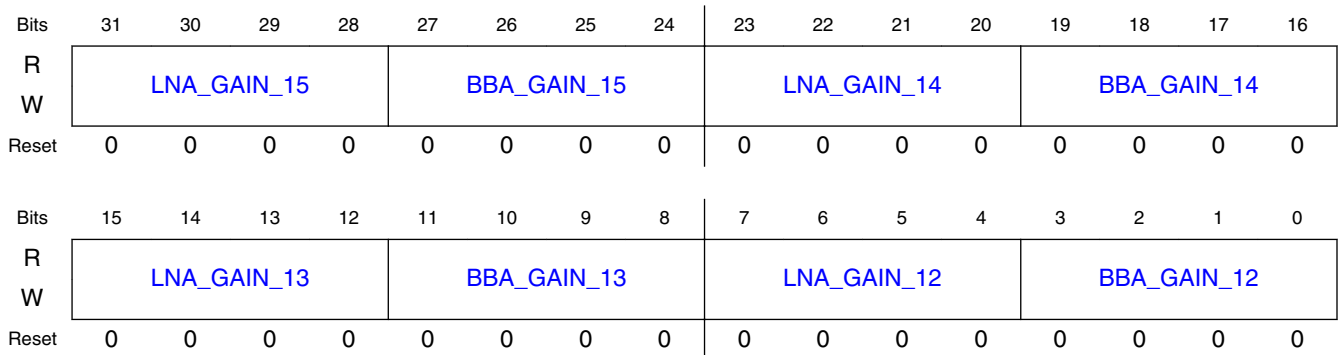

45.4.3.3.1.35.3 Fields

| Field | Function |
|----------------------|--|
| 31-28 LNA_GAIN_15 | LNA Gain 15 LNA GAIN. See Table 45-17 for the mapping of LNA gain indexes to gain values. |
| 27-24 BBA_GAIN_15 | BBA Gain 15 BBA GAIN 0=0 dB, 1=3 dB, 2=6 dB ... A=30 dB. |
| 23-20 LNA_GAIN_14 | LNA Gain 14 LNA GAIN. See Table 45-17 for the mapping of LNA gain indexes to gain values. |
| 19-16 BBA_GAIN_14 | BBA Gain 14 BBA GAIN 0=0 dB, 1=3 dB, 2=6 dB ... A=30 dB. |
| 15-12 LNA_GAIN_13 | LNA Gain 13 LNA GAIN. See Table 45-17 for the mapping of LNA gain indexes to gain values. |
| 11-8 BBA_GAIN_13 | BBA Gain 13 BBA GAIN 0=0 dB, 1=3 dB, 2=6 dB ... A=30 dB. |
| 7-4 LNA_GAIN_12 | LNA Gain 12 LNA GAIN. See Table 45-17 for the mapping of LNA gain indexes to gain values. |
| 3-0 BBA_GAIN_12 | BBA Gain 12 BBA GAIN 0=0 dB, 1=3 dB, 2=6 dB ... A=30 dB. |

45.4.3.3.1.36 AGC Gain Tables Step 19..16 (AGC_GAIN_TBL_19_16)

45.4.3.3.1.36.1 Offset

| Register | Offset |
|--------------------|-----------|
| AGC_GAIN_TBL_19_16 | 4005C090h |

45.4.3.3.1.36.2 *Diagram*

| | | | | | | | | | | | | | | | | |
|-------|-------------|----|----|----|-------------|----|----|----|-------------|----|----|----|-------------|----|----|----|
| Bits | 31 | 30 | 29 | 28 | 27 | 26 | 25 | 24 | 23 | 22 | 21 | 20 | 19 | 18 | 17 | 16 |
| R | LNA_GAIN_19 | | | | BBA_GAIN_19 | | | | LNA_GAIN_18 | | | | BBA_GAIN_18 | | | |
| W | LNA_GAIN_19 | | | | BBA_GAIN_19 | | | | LNA_GAIN_18 | | | | BBA_GAIN_18 | | | |
| Reset | 0 | 0 | 0 | 0 | 0 | 0 | 0 | 0 | 0 | 0 | 0 | 0 | 0 | 0 | 0 | 0 |
| Bits | 15 | 14 | 13 | 12 | 11 | 10 | 9 | 8 | 7 | 6 | 5 | 4 | 3 | 2 | 1 | 0 |
| R | LNA_GAIN_17 | | | | BBA_GAIN_17 | | | | LNA_GAIN_16 | | | | BBA_GAIN_16 | | | |
| W | LNA_GAIN_17 | | | | BBA_GAIN_17 | | | | LNA_GAIN_16 | | | | BBA_GAIN_16 | | | |
| Reset | 0 | 0 | 0 | 0 | 0 | 0 | 0 | 0 | 0 | 0 | 0 | 0 | 0 | 0 | 0 | 0 |

45.4.3.3.1.36.3 *Fields*

| Field | Function |
|----------------------|--|
| 31-28 LNA_GAIN_19 | LNA Gain 19 LNA GAIN. See Table 45-17 for the mapping of LNA gain indexes to gain values. |
| 27-24 BBA_GAIN_19 | BBA Gain 193 BBA GAIN 0=0 dB, 1=3 dB, 2=6 dB ... A=30 dB. |
| 23-20 LNA_GAIN_18 | LNA Gain 18 LNA GAIN. See Table 45-17 for the mapping of LNA gain indexes to gain values. |
| 19-16 BBA_GAIN_18 | BBA Gain 18 BBA GAIN 0=0 dB, 1=3 dB, 2=6 dB ... A=30 dB. |
| 15-12 LNA_GAIN_17 | LNA Gain 17 LNA GAIN. See Table 45-17 for the mapping of LNA gain indexes to gain values. |
| 11-8 BBA_GAIN_17 | BBA Gain 17 BBA GAIN 0=0 dB, 1=3 dB, 2=6 dB ... A=30 dB. |
| 7-4 LNA_GAIN_16 | LNA Gain 16 LNA GAIN. See Table 45-17 for the mapping of LNA gain indexes to gain values. |
| 3-0 BBA_GAIN_16 | BBA Gain 16 BBA GAIN 0=0 dB, 1=3 dB, 2=6 dB ... A=30 dB. |

45.4.3.3.1.37 **AGC Gain Tables Step 23..20 (AGC_GAIN_TBL_23_20)**45.4.3.3.1.37.1 *Offset*

| Register | Offset |
|--------------------|-----------|
| AGC_GAIN_TBL_23_20 | 4005C094h |

45.4.3.3.1.37.2 *Diagram*

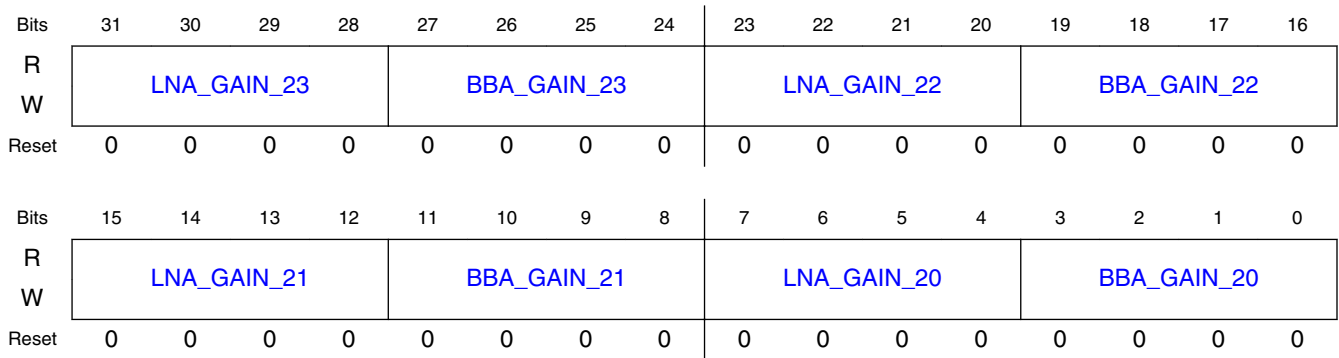

45.4.3.3.1.37.3 *Fields*

| Field | Function |
|----------------------|--|
| 31-28 LNA_GAIN_23 | LNA Gain 23 LNA GAIN. See Table 45-17 for the mapping of LNA gain indexes to gain values. |
| 27-24 BBA_GAIN_23 | BBA Gain 23 BBA GAIN 0=0 dB, 1=3 dB, 2=6 dB ... A=30 dB. |
| 23-20 LNA_GAIN_22 | LNA Gain 22 LNA GAIN. See Table 45-17 for the mapping of LNA gain indexes to gain values. |
| 19-16 BBA_GAIN_22 | BBA Gain 22 BBA GAIN 0=0 dB, 1=3 dB, 2=6 dB ... A=30 dB. |
| 15-12 LNA_GAIN_21 | LNA Gain 21 LNA GAIN. See Table 45-17 for the mapping of LNA gain indexes to gain values. |
| 11-8 BBA_GAIN_21 | BBA Gain 21 BBA GAIN 0=0 dB, 1=3 dB, 2=6 dB ... A=30 dB. |
| 7-4 LNA_GAIN_20 | LNA Gain 20 LNA GAIN. See Table 45-17 for the mapping of LNA gain indexes to gain values. |
| 3-0 BBA_GAIN_20 | BBA Gain 20 BBA GAIN 0=0 dB, 1=3 dB, 2=6 dB ... A=30 dB. |

45.4.3.3.1.38 **AGC Gain Tables Step 26..24 (AGC_GAIN_TBL_26_24)**

45.4.3.3.1.38.1 *Offset*

| Register | Offset |
|--------------------|-----------|
| AGC_GAIN_TBL_26_24 | 4005C098h |

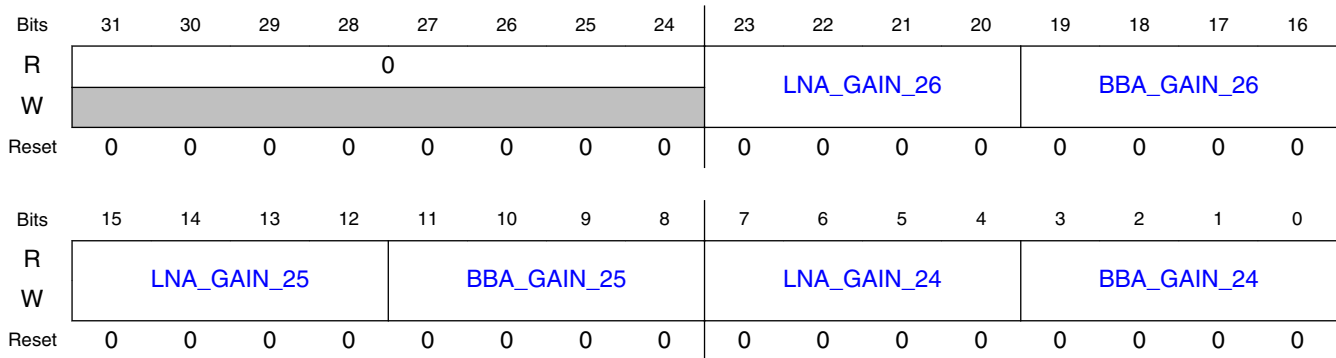
45.4.3.3.1.38.2 *Diagram*45.4.3.3.1.38.3 *Fields*

| Field | Function |
|----------------------|--|
| 31-24 — | Reserved. |
| 23-20 LNA_GAIN_26 | LNA Gain 26 LNA GAIN. See Table 45-17 for the mapping of LNA gain indexes to gain values. |
| 19-16 BBA_GAIN_26 | BBA Gain 26 BBA GAIN 0=0 dB, 1=3 dB, 2=6 dB ... A=30 dB. |
| 15-12 LNA_GAIN_25 | LNA Gain 25 LNA GAIN. See Table 45-17 for the mapping of LNA gain indexes to gain values. |
| 11-8 BBA_GAIN_25 | BBA Gain 25 BBA GAIN 0=0 dB, 1=3 dB, 2=6 dB ... A=30 dB. |
| 7-4 LNA_GAIN_24 | LNA Gain 24 LNA GAIN. See Table 45-17 for the mapping of LNA gain indexes to gain values. |
| 3-0 BBA_GAIN_24 | BBA Gain 24 BBA GAIN 0=0 dB, 1=3 dB, 2=6 dB ... A=30 dB. |

45.4.3.3.1.39 **DCOC Offset (DCOC_OFFSET_a)**45.4.3.3.1.39.1 *Offset*

For a = 0 to 26:

| Register | Offset |
|---------------|----------------------|
| DCOC_OFFSET_a | 4005C0A0h + (a × 4h) |

45.4.3.3.1.39.2 *Function*

DCOC Offset Registers. These registers can only be accessed when the radio oscillator clock is active.

45.4.3.3.1.39.3 *Diagram*

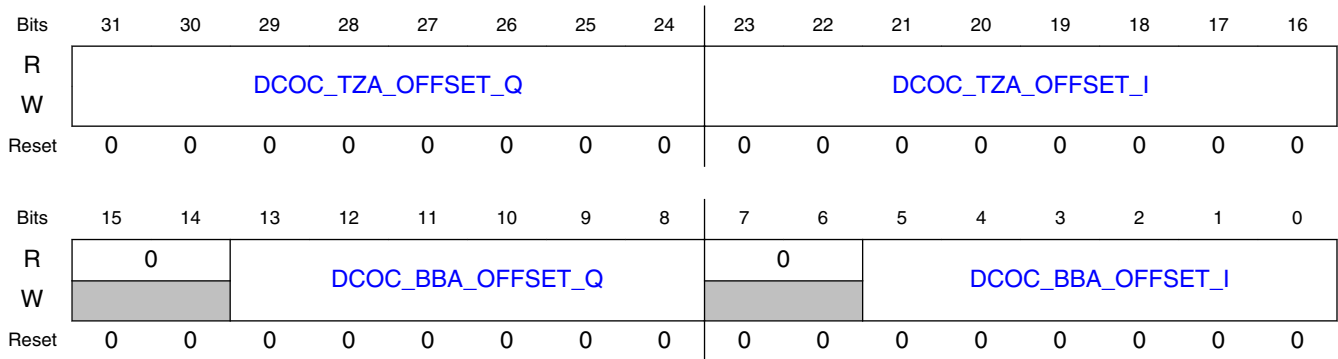

45.4.3.3.1.39.4 *Fields*

| Field | Function |
|--------------------------------|---|
| 31-24 DCOC_TZA_OF FSET_Q | DCOC TZA Q-channel offset DCOC TZA Q-channel offset. When RX_DCOC_CAL_EN=1, this table is generated by the DCOC during calibration. When RX_DCOC_CAL_EN=0, this table may optionally be written by software. |
| 23-16 DCOC_TZA_OF FSET_I | DCOC TZA I-channel offset DCOC TZA I-channel offset. When RX_DCOC_CAL_EN=1, this table is generated by the DCOC during calibration. When RX_DCOC_CAL_EN=0, this table may optionally be written by software. |
| 15-14 — | Reserved. |
| 13-8 DCOC_BBA_OF FSET_Q | DCOC BBA Q-channel offset DCOC BBA Q-channel offset. When RX_DCOC_CAL_EN=1, this table is generated by the DCOC during calibration. When RX_DCOC_CAL_EN=0, this table may optionally be written by software. |
| 7-6 — | Reserved. |
| 5-0 DCOC_BBA_OF FSET_I | DCOC BBA I-channel offset DCOC BBA I-channel offset. When RX_DCOC_CAL_EN=1, this table is generated by the DCOC during calibration. When RX_DCOC_CAL_EN=0, this table may optionally be written by software. |

45.4.3.3.1.40 **DCOC BBA DAC Step (DCOC_BBA_STEP)**

45.4.3.3.1.40.1 Offset

| Register | Offset |
|---------------|-----------|
| DCOC_BBA_STEP | 4005C10Ch |

45.4.3.3.1.40.2 Diagram

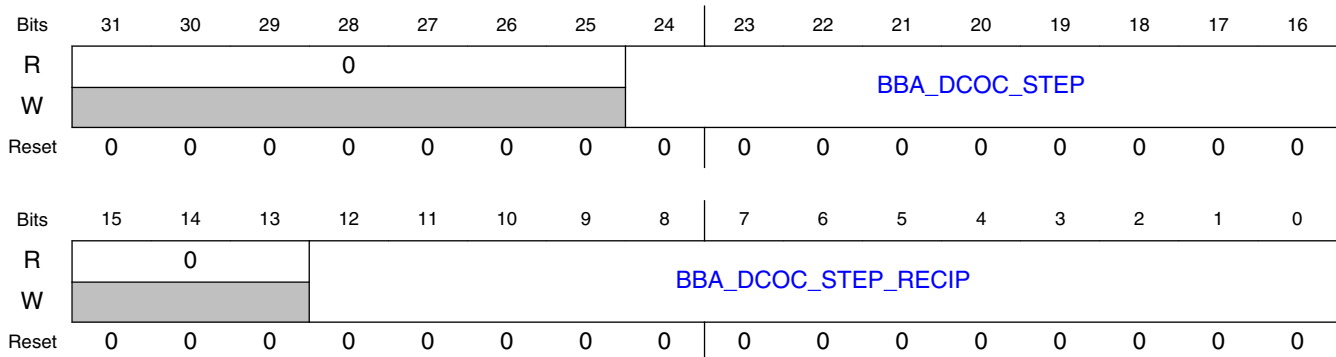

45.4.3.3.1.40.3 Fields

| Field | Function |
|-----------------------------|--|
| 31-25 — | Reserved. |
| 24-16 BBA_DCOC_STEP | DCOC BBA Step Size DCOC BBA Step Size (format: u6.3). This is the BBA DAC resolution in mV ($1.2e3/32*63.44/120 = 19.83\text{mV}$) times the ADC/decimator gain. This value is stored in the register with 3 fractional bits. |
| 15-13 — | Reserved. |
| 12-0 BBA_DCOC_STEP_RECIP | DCOC BBA Reciprocal of Step Size DCOC BBA Reciprocal of Step Size (format: u.[00]13). This the reciprocal of the BBA DCOC STEP value. This value is stored as a 15 bit fraction (though only 13 bits are programmed). |

45.4.3.3.1.41 DCOC TZA DAC Step 0 (DCOC_TZA_STEP_0)

45.4.3.3.1.41.1 Offset

| Register | Offset |
|-----------------|-----------|
| DCOC_TZA_STEP_0 | 4005C110h |

FSK Modulator

45.4.3.3.1.41.2 Diagram

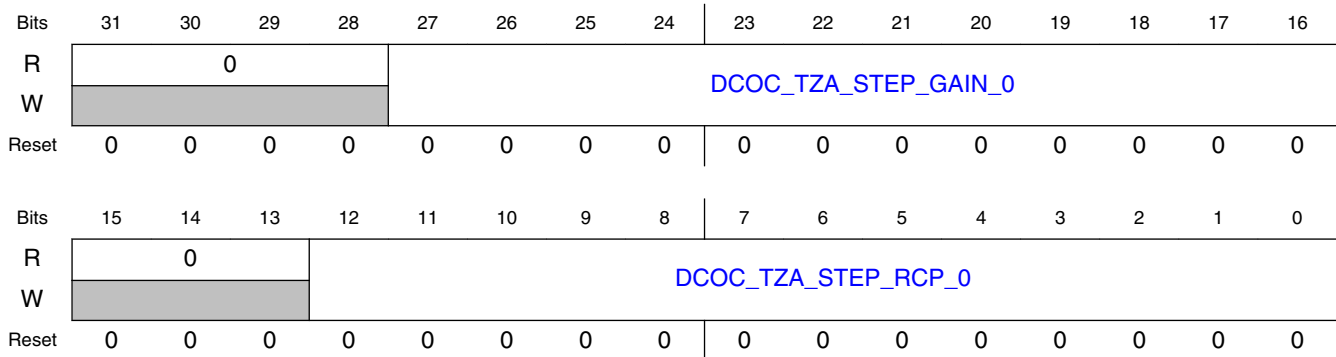

45.4.3.3.1.41.3 Fields

| Field | Function |
|-------------------------------|---|
| 31-28 — | Reserved. |
| 27-16 DCOC_TZA_STEP_GAIN_0 | DCOC TZA Step Size 0 with gain (format u9.3). This is the TZA DAC resolution in mV ($1.2e3/128*22.9/34 = 6.31mV$) times the ADC/decimator gain times BBA gain for BBA index 0. This value is stored in the register with 3 fractional bits. |
| 15-13 — | Reserved. |
| 12-0 DCOC_TZA_STEP_RCP_0 | DCOC TZA Reciprocal of Step Size 0, (format: u.[00]13). This the reciprocal of the DCOC_TZA_STEP_GAIN_0. The value is stored as a 15bit fractional value (though only 13 bits are programmed). |

45.4.3.3.1.42 DCOC TZA DAC Step 1 (DCOC_TZA_STEP_1)

45.4.3.3.1.42.1 Offset

| Register | Offset |
|-----------------|-----------|
| DCOC_TZA_STEP_1 | 4005C114h |

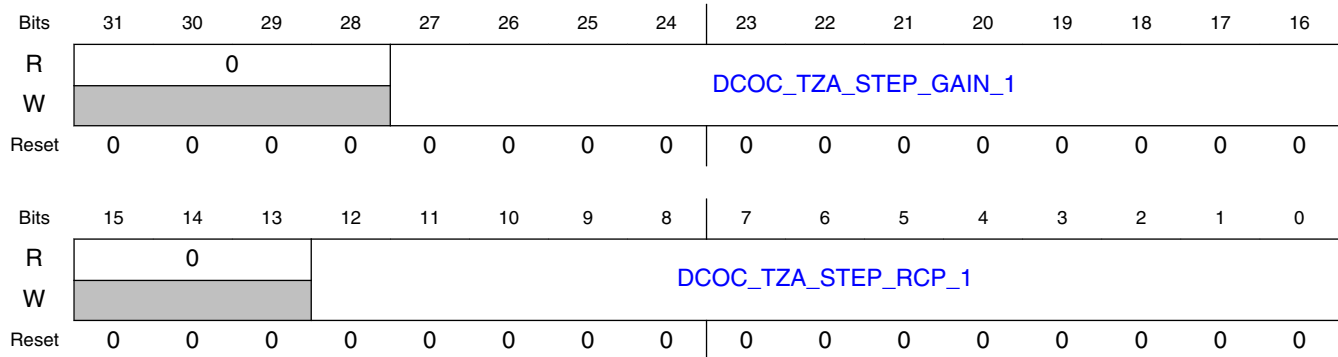
45.4.3.3.1.42.2 *Diagram*45.4.3.3.1.42.3 *Fields*

| Field | Function |
|-------------------------------|---|
| 31-28 — | Reserved. |
| 27-16 DCOC_TZA_STEP_GAIN_1 | DCOC TZA Step Size 1 with gain (format u9.3). This is the TZA DAC resolution in mV ($1.2e3/128*22.9/34 = 6.31mV$) times the ADC/decimator gain times BBA gain for BBA index 1. This value is stored in the register with 3 fractional bits. |
| 15-13 — | Reserved. |
| 12-0 DCOC_TZA_STEP_RCP_1 | DCOC TZA Reciprocal of Step Size 1, (format: u.[00]13). This is the reciprocal of the DCOC_TZA_STEP_GAIN_1. The value is stored as a 15bit fractional value (though only 13 bits are programmed). |

45.4.3.3.1.43 **DCOC TZA DAC Step 2 (DCOC_TZA_STEP_2)**45.4.3.3.1.43.1 *Offset*

| Register | Offset |
|-----------------|-----------|
| DCOC_TZA_STEP_2 | 4005C118h |

FSK Modulator

45.4.3.3.1.43.2 Diagram

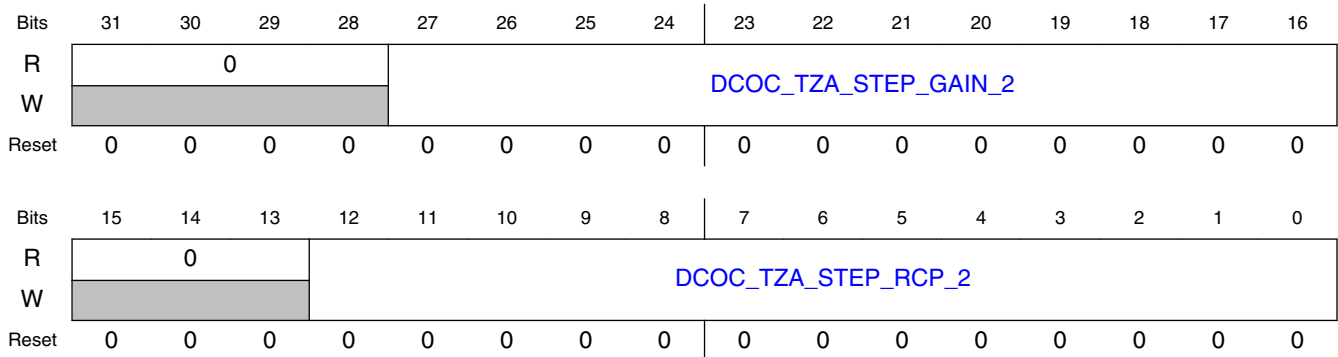

45.4.3.3.1.43.3 Fields

| Field | Function |
|-------------------------------|---|
| 31-28 — | Reserved. |
| 27-16 DCOC_TZA_STEP_GAIN_2 | DCOC TZA Step Size 2 with gain (format u9.3). This is the TZA DAC resolution in mV ($1.2e3/128*22.9/34 = 6.31mV$) times the ADC/decimator gain times BBA gain for BBA index 2. This value is stored in the register with 3 fractional bits. |
| 15-13 — | Reserved. |
| 12-0 DCOC_TZA_STEP_RCP_2 | DCOC TZA Reciprocal of Step Size 2, (format: u.[00]13). This the reciprocal of the DCOC_TZA_STEP_GAIN_2. The value is stored as a 15bit fractional value (though only 13 bits are programmed). |

45.4.3.3.1.44 DCOC TZA DAC Step 3 (DCOC_TZA_STEP_3)

45.4.3.3.1.44.1 Offset

| Register | Offset |
|-----------------|-----------|
| DCOC_TZA_STEP_3 | 4005C11Ch |

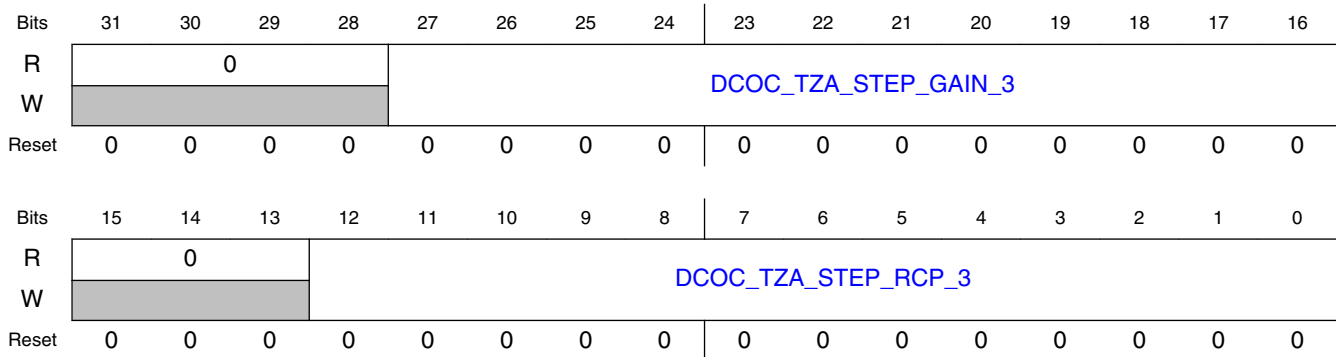
45.4.3.3.1.44.2 *Diagram*45.4.3.3.1.44.3 *Fields*

| Field | Function |
|-------------------------------|---|
| 31-28 — | Reserved. |
| 27-16 DCOC_TZA_STEP_GAIN_3 | DCOC TZA Step Size 3 with gain (format u9.3). This is the TZA DAC resolution in mV ($1.2e3/128*22.9/34 = 6.31mV$) times the ADC/decimator gain times BBA gain for BBA index 3. This value is stored in the register with 3 fractional bits. |
| 15-13 — | Reserved. |
| 12-0 DCOC_TZA_STEP_RCP_3 | DCOC TZA Reciprocal of Step Size 3, (format: u.[00]13). This is the reciprocal of the DCOC_TZA_STEP_GAIN_3. The value is stored as a 15bit fractional value (though only 13 bits are programmed). |

45.4.3.3.1.45 **DCOC TZA DAC Step 4 (DCOC_TZA_STEP_4)**45.4.3.3.1.45.1 *Offset*

| Register | Offset |
|-----------------|-----------|
| DCOC_TZA_STEP_4 | 4005C120h |

FSK Modulator

45.4.3.3.1.45.2 Diagram

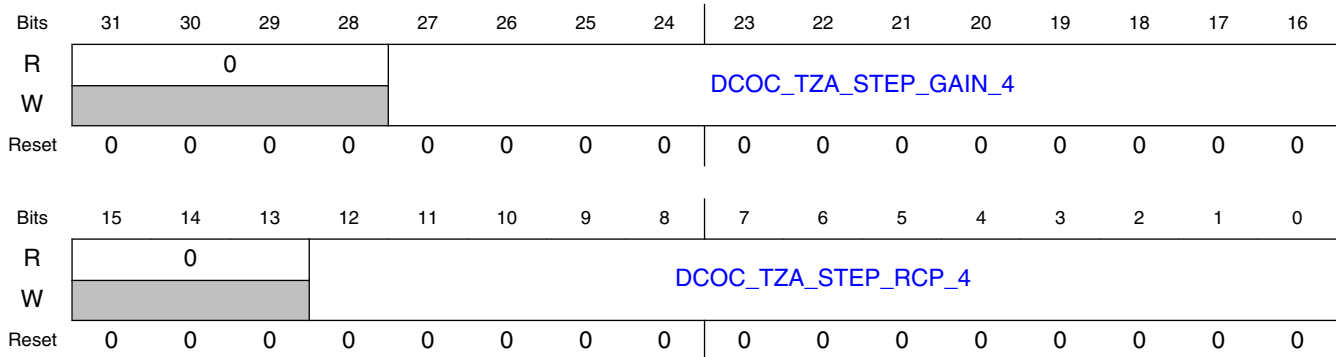

45.4.3.3.1.45.3 Fields

| Field | Function |
|-------------------------------|---|
| 31-28 — | Reserved. |
| 27-16 DCOC_TZA_STEP_GAIN_4 | DCOC TZA Step Size 4 with gain (format u9.3). This is the TZA DAC resolution in mV ($1.2e3/128*22.9/34 = 6.31mV$) times the ADC/decimator gain times BBA gain for BBA index 4. This value is stored in the register with 3 fractional bits. |
| 15-13 — | Reserved. |
| 12-0 DCOC_TZA_STEP_RCP_4 | DCOC TZA Reciprocal of Step Size 4, (format: u.[00]13). This is the reciprocal of the DCOC_TZA_STEP_GAIN_4. The value is stored as a 15bit fractional value (though only 13 bits are programmed). |

45.4.3.3.1.46 DCOC TZA DAC Step 5 (DCOC_TZA_STEP_5)

45.4.3.3.1.46.1 Offset

| Register | Offset |
|-----------------|-----------|
| DCOC_TZA_STEP_5 | 4005C124h |

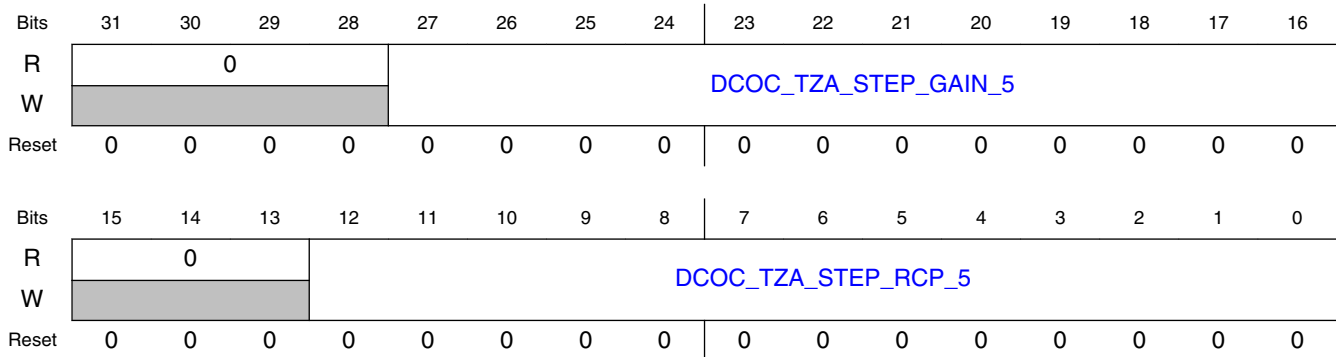
45.4.3.3.1.46.2 *Diagram*45.4.3.3.1.46.3 *Fields*

| Field | Function |
|-------------------------------|---|
| 31-28 — | Reserved. |
| 27-16 DCOC_TZA_STEP_GAIN_5 | DCOC TZA Step Size 5 with gain (format u9.3). This is the TZA DAC resolution in mV ($1.2e3/128*22.9/34 = 6.31mV$) times the ADC/decimator gain times BBA gain for BBA index 5. This value is stored in the register with 3 fractional bits. |
| 15-13 — | Reserved. |
| 12-0 DCOC_TZA_STEP_RCP_5 | DCOC TZA Reciprocal of Step Size 5, (format: u.[00]13). This is the reciprocal of the DCOC_TZA_STEP_GAIN_5. The value is stored as a 15bit fractional value (though only 13 bits are programmed). |

45.4.3.3.1.47 **DCOC TZA DAC Step 6 (DCOC_TZA_STEP_6)**45.4.3.3.1.47.1 *Offset*

| Register | Offset |
|-----------------|-----------|
| DCOC_TZA_STEP_6 | 4005C128h |

FSK Modulator

45.4.3.3.1.47.2 Diagram

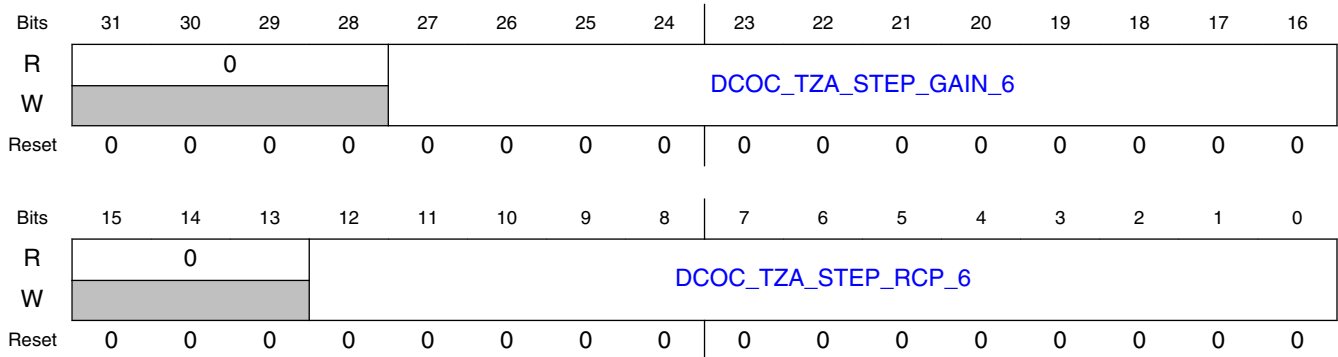

45.4.3.3.1.47.3 Fields

| Field | Function |
|-------------------------------|---|
| 31-28 — | Reserved. |
| 27-16 DCOC_TZA_STEP_GAIN_6 | DCOC TZA Step Size 6 with gain (format u9.3). This is the TZA DAC resolution in mV ($1.2e3/128*22.9/34 = 6.31mV$) times the ADC/decimator gain times BBA gain for BBA index 6. This value is stored in the register with 3 fractional bits. |
| 15-13 — | Reserved. |
| 12-0 DCOC_TZA_STEP_RCP_6 | DCOC TZA Reciprocal of Step Size 6, (format: u.[00]13). This the reciprocal of the DCOC_TZA_STEP_GAIN_6. The value is stored as a 15bit fractional value (though only 13 bits are programmed). |

45.4.3.3.1.48 DCOC TZA DAC Step 7 (DCOC_TZA_STEP_7)

45.4.3.3.1.48.1 Offset

| Register | Offset |
|-----------------|-----------|
| DCOC_TZA_STEP_7 | 4005C12Ch |

45.4.3.3.1.48.2 Diagram

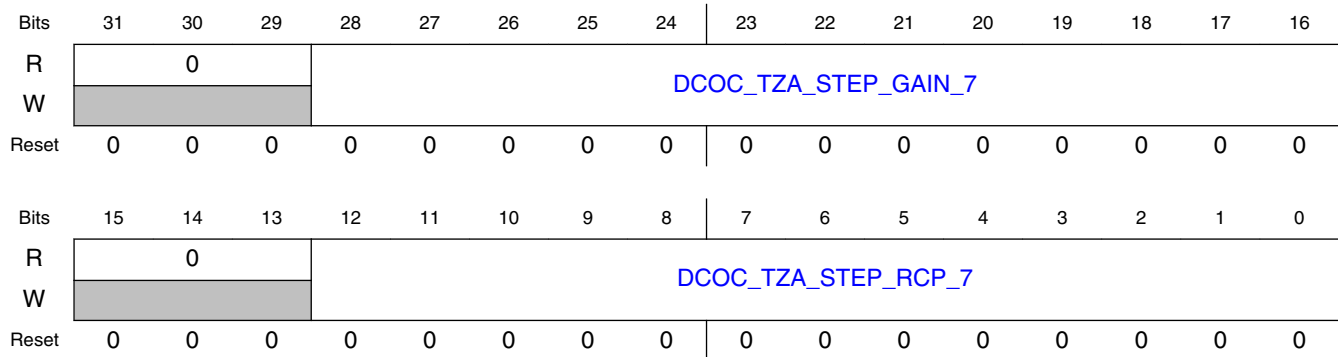

45.4.3.3.1.48.3 Fields

| Field | Function |
|-------------------------------|---|
| 31-29 — | Reserved. |
| 28-16 DCOC_TZA_STEP_GAIN_7 | DCOC_TZA_STEP_GAIN_7 DCOC TZA Step Size 7 with gain (format u10.3). This is the TZA DAC resolution in mV ($1.2e3/128*22.9/34 = 6.31\text{mV}$) times the ADC/decimator gain times BBA gain for BBA index 7. This value is stored in the register with 3 fractional bits. |
| 15-13 — | Reserved. |
| 12-0 DCOC_TZA_STEP_RCP_7 | DCOC_TZA_STEP_RCP_7 DCOC TZA Reciprocal of Step Size 7, (format: u.[00]13). This the reciprocal of the DCOC_TZA_STEP_GAIN_7. The value is stored as a 15bit fractional value (though only 13 bits are programmed). |

45.4.3.3.1.49 DCOC TZA DAC Step 5 (DCOC_TZA_STEP_8)

45.4.3.3.1.49.1 Offset

| Register | Offset |
|-----------------|-----------|
| DCOC_TZA_STEP_8 | 4005C130h |

FSK Modulator

45.4.3.3.1.49.2 Diagram

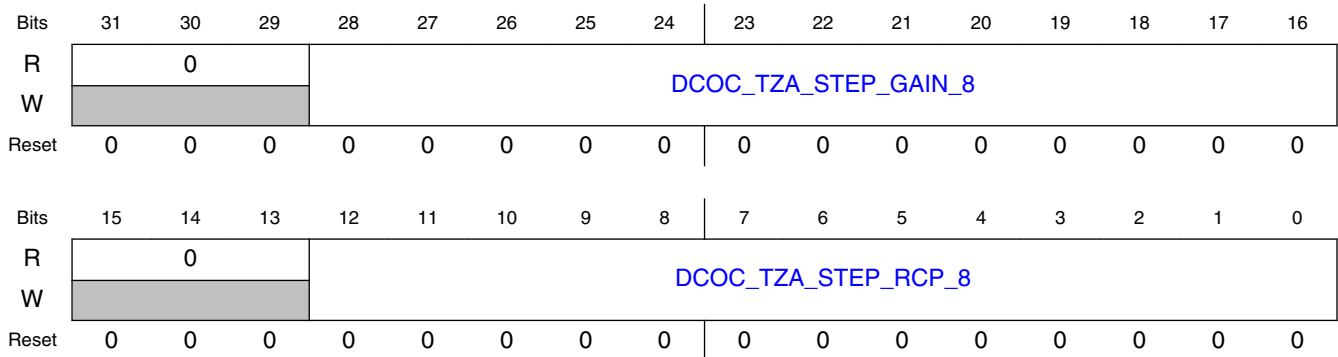

45.4.3.3.1.49.3 Fields

| Field | Function |
|-------------------------------|---|
| 31-29 — | Reserved. |
| 28-16 DCOC_TZA_STEP_GAIN_8 | DCOC TZA Step Size 8 with gain (format u10.3). This is the TZA DAC resolution in mV ($1.2e3/128*22.9/34 = 6.31\text{mV}$) times the ADC/decimator gain times BBA gain for BBA index 8. This value is stored in the register with 3 fractional bits. |
| 15-13 — | Reserved. |
| 12-0 DCOC_TZA_STEP_RCP_8 | DCOC TZA Reciprocal of Step Size 8, (format: u.[00]13). This the reciprocal of the DCOC_TZA_STEP_GAIN_8. The value is stored as a 15bit fractional value (though only 13 bits are programmed). |

45.4.3.3.1.50 DCOC TZA DAC Step 9 (DCOC_TZA_STEP_9)

45.4.3.3.1.50.1 Offset

| Register | Offset |
|-----------------|-----------|
| DCOC_TZA_STEP_9 | 4005C134h |

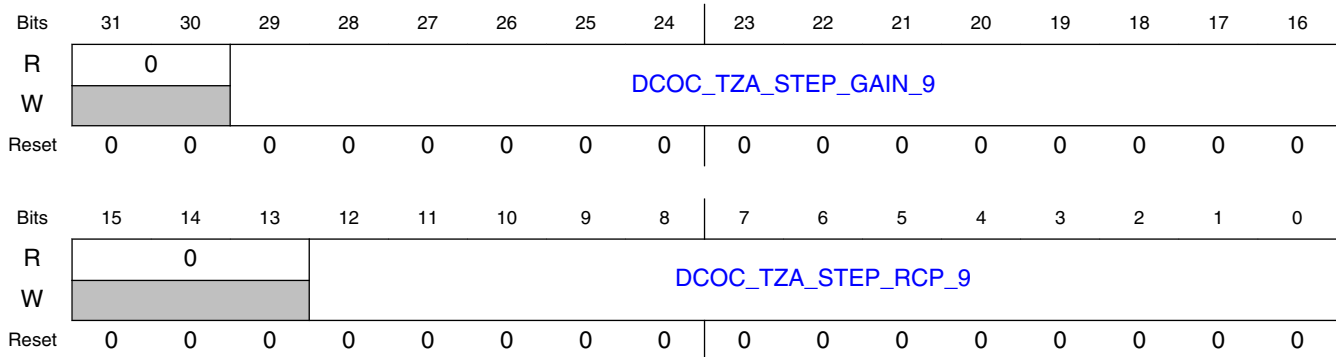
45.4.3.3.1.50.2 *Diagram*45.4.3.3.1.50.3 *Fields*

| Field | Function |
|-------------------------------|---|
| 31-30 — | Reserved. |
| 29-16 DCOC_TZA_STEP_GAIN_9 | DCOC_TZA_STEP_GAIN_9 DCOC TZA Step Size 9 with gain (format u11.3). This is the TZA DAC resolution in mV ($1.2e3/128*22.9/34 = 6.31\text{mV}$) times the ADC/decimator gain times BBA gain for BBA index 9. This value is stored in the register with 3 fractional bits. |
| 15-13 — | Reserved. |
| 12-0 DCOC_TZA_STEP_RCP_9 | DCOC_TZA_STEP_RCP_9 DCOC TZA Reciprocal of Step Size 9, (format: u.[00]13). This the reciprocal of the DCOC_TZA_STEP_GAIN_9. The value is stored as a 15bit fractional value (though only 13 bits are programmed). |

45.4.3.3.1.51 **DCOC TZA DAC Step 10 (DCOC_TZA_STEP_10)**45.4.3.3.1.51.1 *Offset*

| Register | Offset |
|------------------|-----------|
| DCOC_TZA_STEP_10 | 4005C138h |

FSK Modulator

45.4.3.3.1.51.2 Diagram

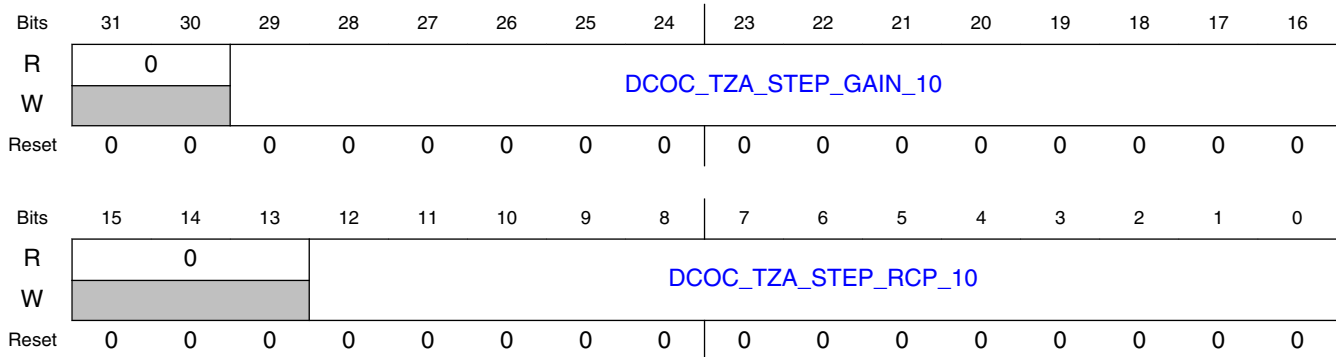

45.4.3.3.1.51.3 Fields

| Field | Function |
|--------------------------------|---|
| 31-30 — | Reserved. |
| 29-16 DCOC_TZA_STEP_GAIN_10 | DCOC TZA Step Size 10 with gain (format u11.3). This is the TZA DAC resolution in mV ($1.2e3/128*22.9/34 = 6.31\text{mV}$) times the ADC/decimator gain times BBA gain for BBA index 10. This value is stored in the register with 3 fractional bits. |
| 15-13 — | Reserved. |
| 12-0 DCOC_TZA_STEP_RCP_10 | DCOC TZA Reciprocal of Step Size 10, (format: u.[00]13). This is the reciprocal of the DCOC_TZA_STEP_GAIN_10. The value is stored as a 15bit fractional value (though only 13 bits are programmed). |

45.4.3.3.1.52 DCOC Calibration Alpha (DCOC_CAL_ALPHA)

45.4.3.3.1.52.1 Offset

| Register | Offset |
|----------------|-----------|
| DCOC_CAL_ALPHA | 4005C168h |

45.4.3.3.1.52.2 *Diagram*

| | | | | | | | | | | | | | | | | |
|-------|----|----|----|----|----|------------------|----|----|----|----|----|----|----|----|----|----|
| Bits | 31 | 30 | 29 | 28 | 27 | 26 | 25 | 24 | 23 | 22 | 21 | 20 | 19 | 18 | 17 | 16 |
| R | 0 | | | | | DCOC_CAL_ALPHA_Q | | | | | | | | | | |
| W | | | | | | | | | | | | | | | | |
| Reset | 0 | 0 | 0 | 0 | 0 | 0 | 0 | 0 | 0 | 0 | 0 | 0 | 0 | 0 | 0 | 0 |
| Bits | 15 | 14 | 13 | 12 | 11 | 10 | 9 | 8 | 7 | 6 | 5 | 4 | 3 | 2 | 1 | 0 |
| R | 0 | | | | | DCOC_CAL_ALPHA_I | | | | | | | | | | |
| W | | | | | | | | | | | | | | | | |
| Reset | 0 | 0 | 0 | 0 | 0 | 0 | 0 | 0 | 0 | 0 | 0 | 0 | 0 | 0 | 0 | 0 |

45.4.3.3.1.52.3 *Fields*

| Field | Function |
|---------------------------|--|
| 31-27 — | Reserved. |
| 26-16 DCOC_CAL_ALPHA_Q | DCOC Calibration Q-channel ALPHA. This read-only value represents the Q channel estimate of the ALPHA DC component calculated in DCOC calibration. Format s4.6. This is provided for debug/characterization purposes. |
| 15-11 — | Reserved. |
| 10-0 DCOC_CAL_ALPHA_I | DCOC Calibration I-channel ALPHA constant DCOC Calibration I-channel ALPHA. This read-only value represents the I channel estimate of the ALPHA DC component calculated in DCOC calibration. Format s4.6. This is provided for debug/characterization purposes. |

45.4.3.3.1.53 **DCOC Calibration Beta Q (DCOC_CAL_BETA_Q)**45.4.3.3.1.53.1 *Offset*

| Register | Offset |
|-----------------|-----------|
| DCOC_CAL_BETA_Q | 4005C16Ch |

FSK Modulator

45.4.3.3.1.53.2 Diagram

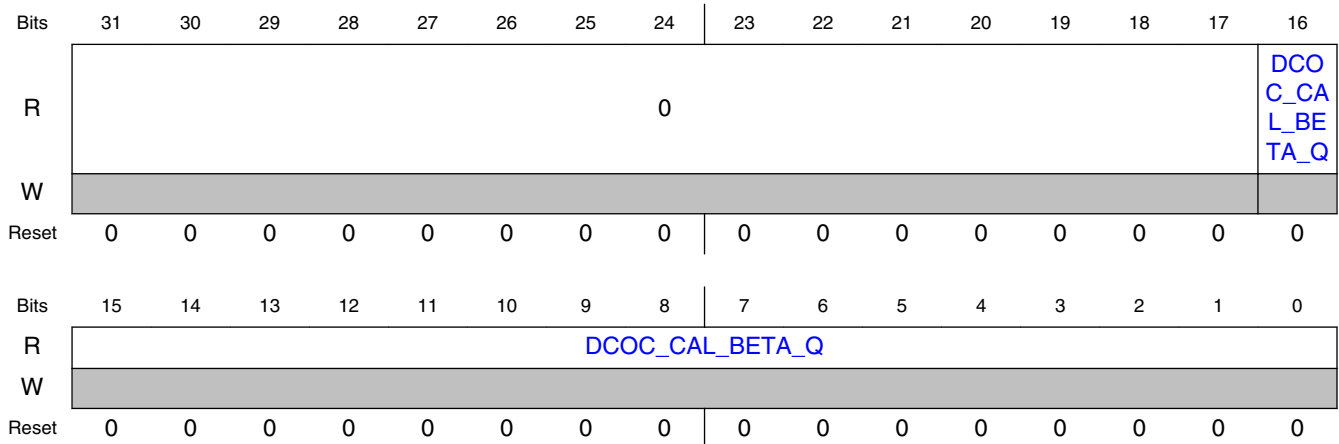

45.4.3.3.1.53.3 Fields

| Field | Function |
|--|---|
| 31-17 — | Reserved. |
| 16-0 DCOC_CAL_BETA_Q DCOC_CAL_BETA_Q | DCOC_CAL_BETA_Q DCOC Calibration Q-channel BETA. This read-only value represents the Q channel estimate of the BETA DC component calculated in DCOC calibration. Format s11.5. This is provided for debug/characterization purposes. |

45.4.3.3.1.54 DCOC Calibration Beta I (DCOC_CAL_BETA_I)

45.4.3.3.1.54.1 Offset

| Register | Offset |
|-----------------|-----------|
| DCOC_CAL_BETA_I | 4005C170h |

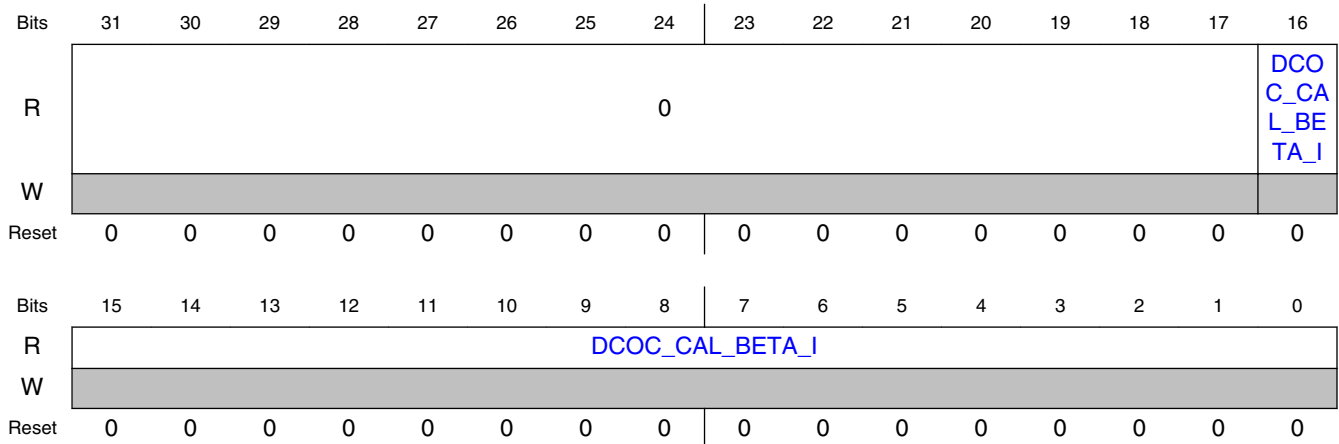
45.4.3.3.1.54.2 *Diagram*45.4.3.3.1.54.3 *Fields*

| Field | Function |
|-------------------------|---|
| 31-17 — | Reserved. |
| 16-0 DCOC_CAL_BETA_I | DCOC_CAL_BETA_I DCOC Calibration I-channel BETA. This read-only value represents the I channel estimate of the BETA DC component calculated in DCOC calibration. Format s11.5. This is provided for debug/characterization purposes. |

45.4.3.3.1.55 **DCOC Calibration Gamma (DCOC_CAL_GAMMA)**45.4.3.3.1.55.1 *Offset*

| Register | Offset |
|----------------|-----------|
| DCOC_CAL_GAMMA | 4005C174h |

FSK Modulator

45.4.3.3.1.55.2 Diagram

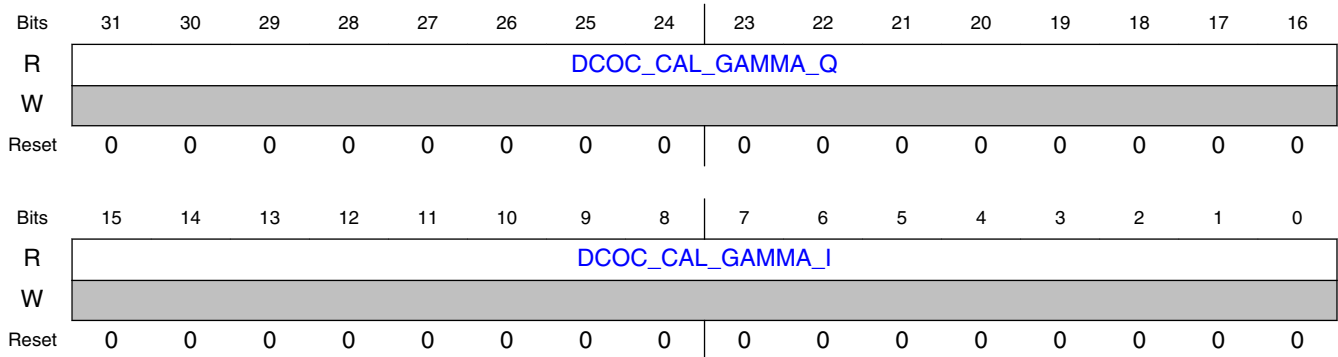

45.4.3.3.1.55.3 Fields

| Field | Function |
|---------------------------|--|
| 31-16 DCOC_CAL_GAMMA_Q | DCOC_CAL_GAMMA_Q DCOC Calibration Q-channel GAMMA. This read-only value represents the Q channel estimate of the GAMMA DC component calculated in DCOC calibration. Format s11.4. This is provided for debug/characterization purposes. |
| 15-0 DCOC_CAL_GAMMA_I | DCOC_CAL_GAMMA_I DCOC Calibration I-channel GAMMA. This read-only value represents the I channel estimate of the GAMMA DC component calculated in DCOC calibration. Format s11.4. This is provided for debug/characterization purposes. |

45.4.3.3.1.56 DCOC Calibration IIR (DCOC_CAL_IIR)

45.4.3.3.1.56.1 Offset

| Register | Offset |
|--------------|-----------|
| DCOC_CAL_IIR | 4005C178h |

45.4.3.3.1.56.2 *Diagram*

| | | | | | | | | | | | | | | | | |
|-------|----|----|----|----|----|----|----|----|----|----|--------------------|--------------------|--------------------|----|----|----|
| Bits | 31 | 30 | 29 | 28 | 27 | 26 | 25 | 24 | 23 | 22 | 21 | 20 | 19 | 18 | 17 | 16 |
| R | 0 | | | | | | | | | | | | | | | |
| W | | | | | | | | | | | | | | | | |
| Reset | 0 | 0 | 0 | 0 | 0 | 0 | 0 | 0 | 0 | 0 | 0 | 0 | 0 | 0 | 0 | 0 |
| Bits | 15 | 14 | 13 | 12 | 11 | 10 | 9 | 8 | 7 | 6 | 5 | 4 | 3 | 2 | 1 | 0 |
| R | 0 | | | | | | | | | | DCOC_CAL_IIR3A_IDX | DCOC_CAL_IIR2A_IDX | DCOC_CAL_IIR1A_IDX | | | |
| W | | | | | | | | | | | | | | | | |
| Reset | 0 | 0 | 0 | 0 | 0 | 0 | 0 | 0 | 0 | 0 | 0 | 0 | 0 | 0 | 0 | 0 |

45.4.3.3.1.56.3 *Fields*

| Field | Function |
|---------------------------|---|
| 31-6 Reserved | Reserved. |
| 5-4 DCOC_CAL_IIR3A_IDX | DCOC Calibration IIR 3A Index DCOC Calibration IIR 3A Index. Defines the filter coefficient use for the 3rd IIR filter in the DCOC calibration DC estimator. 00b - 1/4 01b - 1/8 10b - 1/16 11b - 1/32 |
| 3-2 DCOC_CAL_IIR2A_IDX | DCOC Calibration IIR 2A Index DCOC Calibration IIR 2A Index. Defines the filter coefficient use for the 2nd IIR filter in the DCOC calibration DC estimator. 00b - 1/1 01b - 1/4 10b - 1/8 11b - 1/16 |
| 1-0 DCOC_CAL_IIR1A_IDX | DCOC Calibration IIR 1A Index DCOC Calibration IIR 1A Index. Defines the filter coefficient use for the 1st IIR filter in the DCOC calibration DC estimator. 00b - 1/1 01b - 1/4 10b - 1/8 11b - 1/16 |

45.4.3.3.1.57 **DCOC Calibration Result (DCOC_CALa)**

FSK Modulator

45.4.3.3.1.57.1 Offset

| Register | Offset |
|-----------|-----------|
| DCOC_CAL1 | 4005C180h |
| DCOC_CAL2 | 4005C184h |
| DCOC_CAL3 | 4005C188h |

45.4.3.3.1.57.2 Function

Result of one of the calibration iterations.

45.4.3.3.1.57.3 Diagram

| | | | | | | | | | | | | | | | | |
|-------|--------------|----|----|----|----------------|----|----|----|----|----|----|----|----|----|----|----|
| Bits | 31 | 30 | 29 | 28 | 27 | 26 | 25 | 24 | 23 | 22 | 21 | 20 | 19 | 18 | 17 | 16 |
| R | 0 | | | | DCOC_CAL_RES_Q | | | | | | | | | | | |
| W | [Greyed out] | | | | | | | | | | | | | | | |
| Reset | 0 | 0 | 0 | 0 | 0 | 0 | 0 | 0 | 0 | 0 | 0 | 0 | 0 | 0 | 0 | 0 |
| Bits | 15 | 14 | 13 | 12 | 11 | 10 | 9 | 8 | 7 | 6 | 5 | 4 | 3 | 2 | 1 | 0 |
| R | 0 | | | | DCOC_CAL_RES_I | | | | | | | | | | | |
| W | [Greyed out] | | | | | | | | | | | | | | | |
| Reset | 0 | 0 | 0 | 0 | 0 | 0 | 0 | 0 | 0 | 0 | 0 | 0 | 0 | 0 | 0 | 0 |

45.4.3.3.1.57.4 Fields

| Field | Function |
|-----------------------------|--|
| 31-28 — | Reserved. |
| 27-16 DCOC_CAL_RE S_Q | DCOC Calibration Result - Q Channel Q channel DCOC calibration result. This value represents the DCOC's Q channel DC estimate for the nth calibration gain setting. Format s11. This is provided for debug/chacterization purposes. |
| 15-12 — | Reserved. |
| 11-0 DCOC_CAL_RE S_I | DCOC Calibration Result - I Channel I channel DCOC calibration result. This value represents the DCOC's I channel DC estimate for the nth calibration gain setting. Format s11. This is provided for debug/chacterization purposes. |

45.4.3.3.1.58 RX_DIG CCA ED LQI Control Register 0 (CCA_ED_LQI_CTRL_0)

45.4.3.3.1.58.1 *Offset*

| Register | Offset |
|-------------------|-----------|
| CCA_ED_LQI_CTRL_0 | 4005C190h |

45.4.3.3.1.58.2 *Diagram*

| | | | | | | | | | | | | | | | | |
|-------|------------------|----|----|----|----|----|----|----|-----------------|----|----|----|----|----|----|----|
| Bits | 31 | 30 | 29 | 28 | 27 | 26 | 25 | 24 | 23 | 22 | 21 | 20 | 19 | 18 | 17 | 16 |
| R | 0 | | | | | | | | LQI_CNTR | | | | | | | |
| W | | | | | | | | | | | | | | | | |
| Reset | 0 | 0 | 0 | 0 | 0 | 0 | 0 | 0 | 0 | 0 | 0 | 0 | 0 | 0 | 0 | 0 |
| Bits | 15 | 14 | 13 | 12 | 11 | 10 | 9 | 8 | 7 | 6 | 5 | 4 | 3 | 2 | 1 | 0 |
| R | CORR_CNTR_THRESH | | | | | | | | LQI_CORR_THRESH | | | | | | | |
| W | | | | | | | | | | | | | | | | |
| Reset | 0 | 0 | 0 | 0 | 0 | 0 | 0 | 0 | 0 | 0 | 0 | 0 | 0 | 0 | 0 | 0 |

45.4.3.3.1.58.3 *Fields*

| Field | Function |
|--------------------------|--|
| 31-24 — | Reserved. |
| 23-16 LQI_CNTR | LQI Counter Duration of LQI in uS. |
| 15-8 CORR_CNTR_THRESH | Correlation Count Threshold Threshold used to compare the counted correlation magnitudes exceeding LQI_CORR_THRESH. |
| 7-0 LQI_CORR_THRESH | LQI Correlation Threshold Threshold used to compare correlation magnitude values from the PHY |

45.4.3.3.1.59 **RX_DIG CCA ED LQI Control Register 1 (CCA_ED_LQI_CTRL_1)**45.4.3.3.1.59.1 *Offset*

| Register | Offset |
|-------------------|-----------|
| CCA_ED_LQI_CTRL_1 | 4005C194h |

45.4.3.3.1.59.2 Diagram

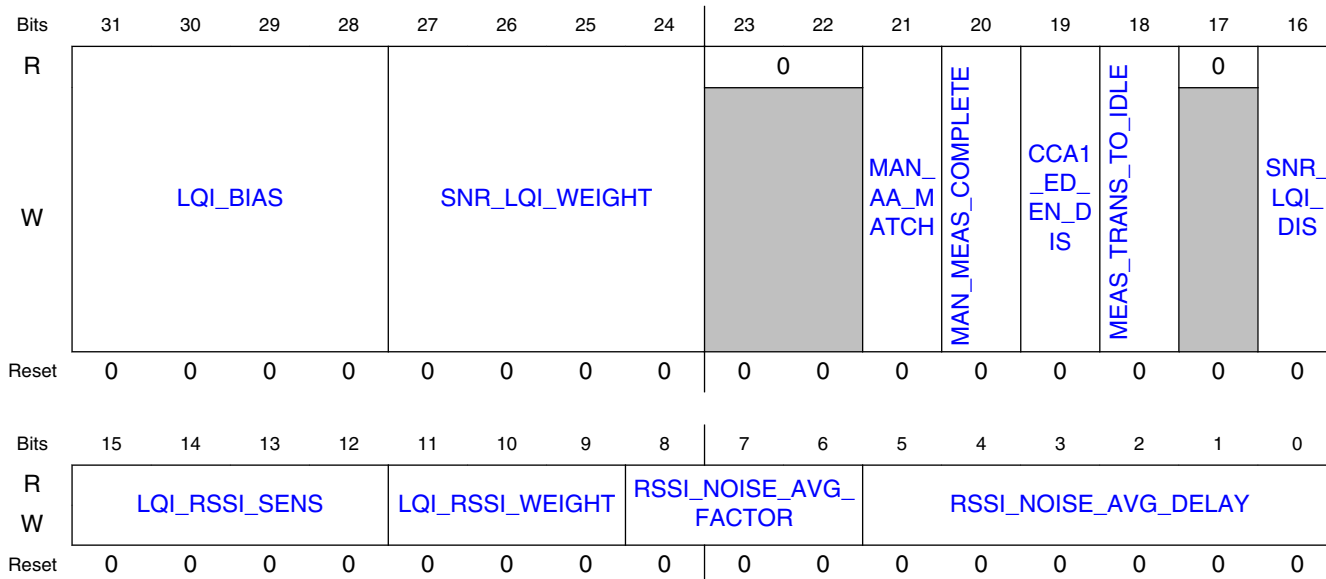

45.4.3.3.1.59.3 Fields

| Field | Function |
|-------------------------|---|
| 31-28 LQI_BIAS | LQI Bias. Bias used for LQI calculation. Applied bias = $-36 + 2 * LQI_BIAS$. |
| 27-24 SNR_LQI_WEIGHT | SNR LQI Weight SNR weight used for LQI calculation 0000b - 0.0 0001b - 1.0 0010b - 1.125 0011b - 1.25 0100b - 1.375 0101b - 1.5 0110b - 1.625 0111b - 1.75 1000b - 1.875 1001b - 2.0 1010b - 2.125 1011b - 2.25 1100b - 2.375 1101b - 2.5 1110b - 2.625 1111b - 2.75 |
| 23-22 — | Reserved. |
| 21 MAN_AA_MATCH | Manual AA Match When set, this causes an AA match condition. Intended to be used only for debug. 0b - Normal operation |

Table continues on the next page...

| Field | Function |
|----------------------------------|--|
| | 1b - Manually asserts the AA match signal for the RX_DIG CCA/ED/LQI and AGC blocks. Intended to be used only for debug. |
| 20 MAN_MEAS_C COMPLETE | Manual measurement complete 0b - Normal operation 1b - Manually asserts the measurement complete signal for the RX_DIG CCA/ED/LQI blocks. Intended to be used only for debug. |
| 19 CCA1_ED_EN_ DIS | CCA1_ED_EN Disable 0b - Normal operation 1b - CCA1_ED_EN input is disabled |
| 18 MEAS_TRANS_ TO_IDLE | Measurement Transition to IDLE Establishes the state machine transition following an LQI or CCA1/ED measurement 0b - Module transitions to RSSI state 1b - Module transitions to IDLE state |
| 17 — | Reserved. |
| 16 SNR_LQI_DIS | SNR LQI Disable 0b - Normal operation. 1b - The RX_DIG CCA/ED/LQI block ignores the AA match input which starts an LQI measurement. |
| 15-12 LQI_RSSI_SEN S | LQI RSSI Sensitivity Unsigned integer used for calculation of LQI sensitivity. Sensitivity = $-103 + \text{LQI_RSSI_SENS}$. |
| 11-9 LQI_RSSI_WEI GHT | LQI RSSI Weight RSSI weight used for LQI calculation 000b - 2.0 001b - 2.125 010b - 2.25 011b - 2.375 100b - 2.5 101b - 2.625 110b - 2.75 111b - 2.875 |
| 8-6 RSSI_NOISE_A VG_FACTOR | RSSI Noise Averaging Factor Factor used for RSSI and SNR averaging. 000b - 1 001b - 64 010b - 70 011b - 128 100b - 139 101b - 256 110b - 277 111b - 512 |
| 5-0 RSSI_NOISE_A VG_DELAY | RSSI Noise Averaging Delay Programmable delay used to delay the enable of averagers "RSSI Averager" and "Noise Averager" after a cca1_ed_trig assertion (in wideband mode) or after a aa_sfd_matched assertion (in narrowband mode). The delay is expressed in ticks of frequency F_s/N , where F_s is the ADC decimator output sampling frequency in wideband mode or the base-band sampling frequency in the narrowband mode. |

45.4.3.3.1.60 RX_DIG CCA ED LQI Status Register 0 (CCA_ED_LQI_STAT_0)

45.4.3.3.1.60.1 Offset

| Register | Offset |
|-------------------|-----------|
| CCA_ED_LQI_STAT_0 | 4005C198h |

45.4.3.3.1.60.2 Diagram

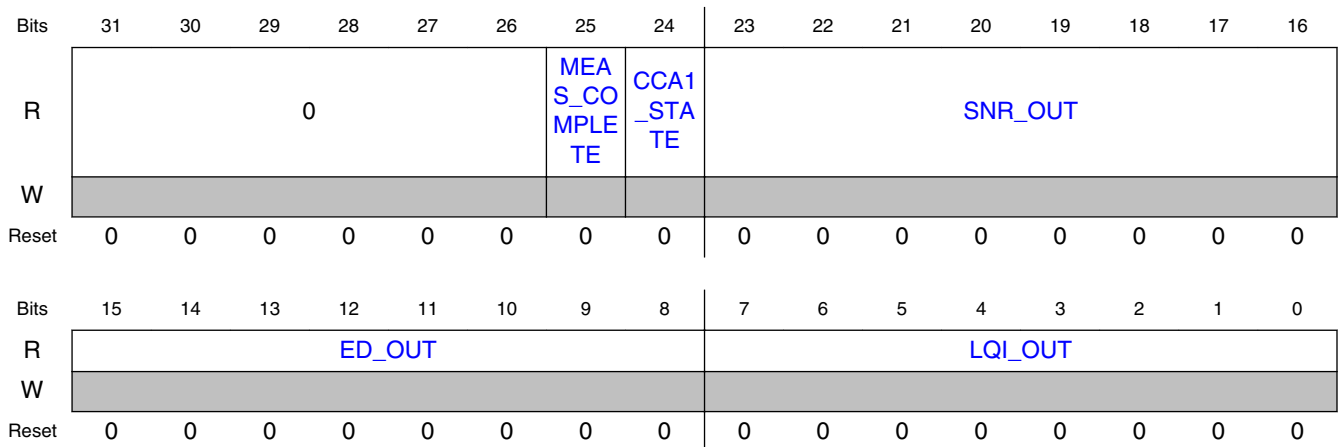

45.4.3.3.1.60.3 Fields

| Field | Function |
|-------------------------|---|
| 31-26 — | Reserved. |
| 25 MEAS_COMPL ETE | Measurement Complete Set upon measurement complete |
| 24 CCA1_STATE | CCA1 State Reflects the state of CCA1 channel state |
| 23-16 SNR_OUT | SNR output Reflects the SNR measurement value. |
| 15-8 ED_OUT | ED output Reflects the Energy Detect (DC) measurement value. |
| 7-0 LQI_OUT | LQI output Reflects the LQI measurement value. |

45.4.3.3.1.61 Receive Channel Filter Coefficient 0 (RX_CHF_COEF_0)

45.4.3.3.1.61.1 Offset

| Register | Offset |
|---------------|-----------|
| RX_CHF_COEF_0 | 4005C1A0h |

45.4.3.3.1.61.2 Diagram

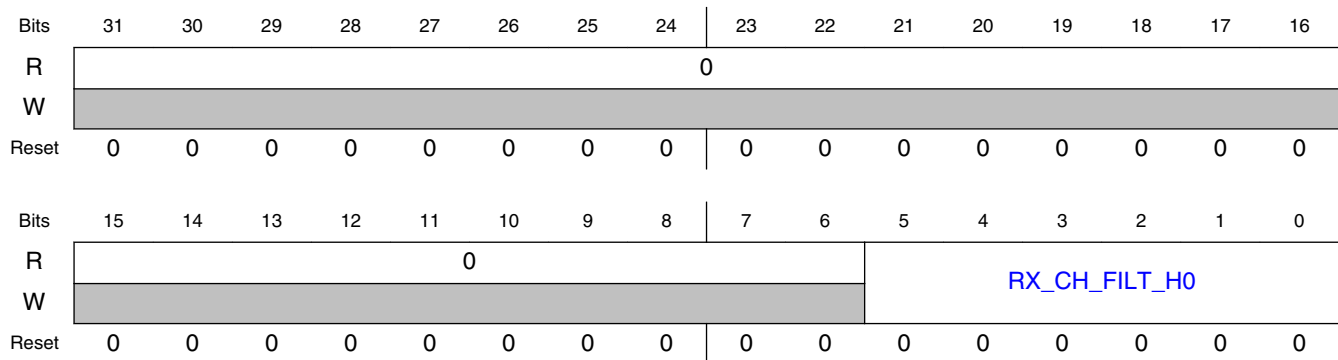

45.4.3.3.1.61.3 Fields

| Field | Function |
|----------------------|---|
| 31-6 Reserved | Reserved. |
| 5-0 RX_CH_FILT_H0 | RX Channel Filter Coefficient 0 RX Channel Filter Coefficient 0, 6-bit signed fractional |

45.4.3.3.1.62 Receive Channel Filter Coefficient 1 (RX_CHF_COEF_1)

45.4.3.3.1.62.1 Offset

| Register | Offset |
|---------------|-----------|
| RX_CHF_COEF_1 | 4005C1A4h |

FSK Modulator

45.4.3.3.1.62.2 Diagram

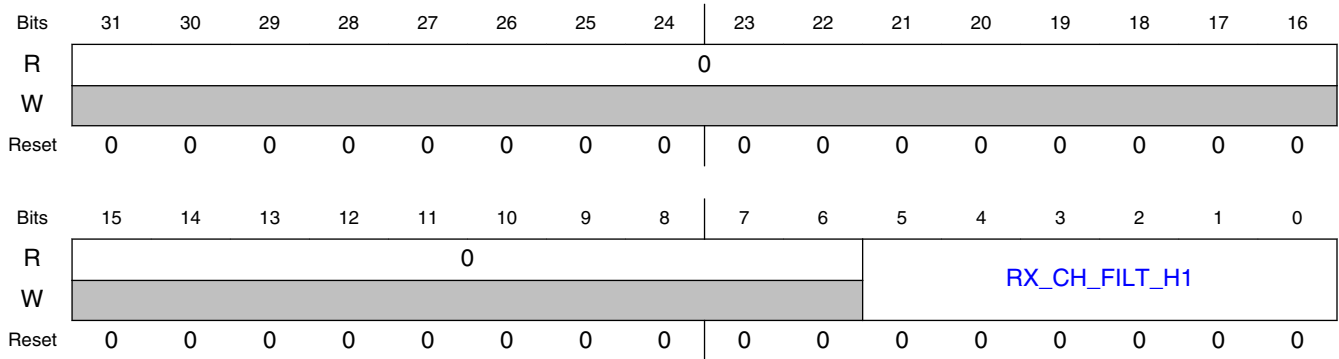

45.4.3.3.1.62.3 Fields

| Field | Function |
|----------------------|---|
| 31-6 Reserved | Reserved. |
| 5-0 RX_CH_FILT_H1 | RX Channel Filter Coefficient 1 RX Channel Filter Coefficient 1, 6-bit signed fractional |

45.4.3.3.1.63 Receive Channel Filter Coefficient 2 (RX_CHF_COEF_2)

45.4.3.3.1.63.1 Offset

| Register | Offset |
|---------------|-----------|
| RX_CHF_COEF_2 | 4005C1A8h |

45.4.3.3.1.63.2 Diagram

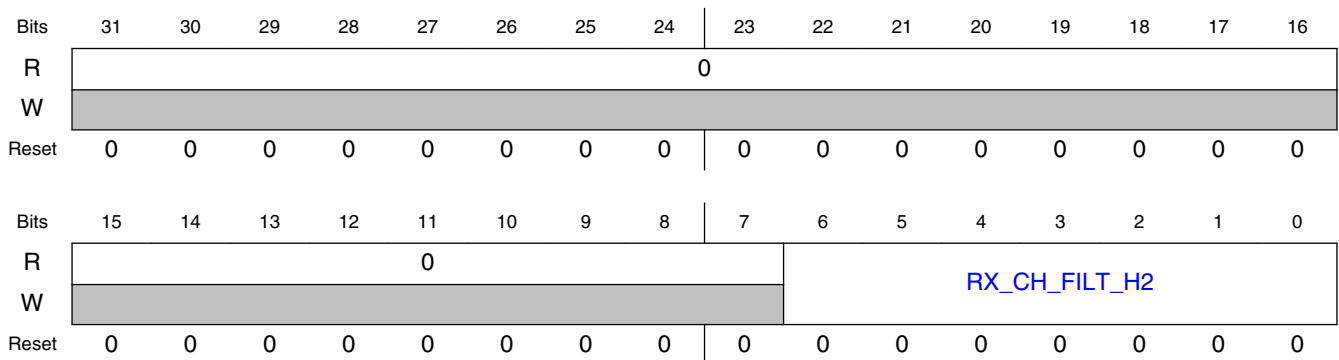

45.4.3.3.1.63.3 *Fields*

| Field | Function |
|--------------------------|---|
| 31-7 Reserved | Reserved. |
| 6-0 RX_CH_FILT_H 2 | RX Channel Filter Coefficient 2 RX Channel Filter Coefficient 2, 7-bit signed fractional |

45.4.3.3.1.64 **Receive Channel Filter Coefficient 3 (RX_CHF_COEF_3)**45.4.3.3.1.64.1 *Offset*

| Register | Offset |
|---------------|-----------|
| RX_CHF_COEF_3 | 4005C1ACh |

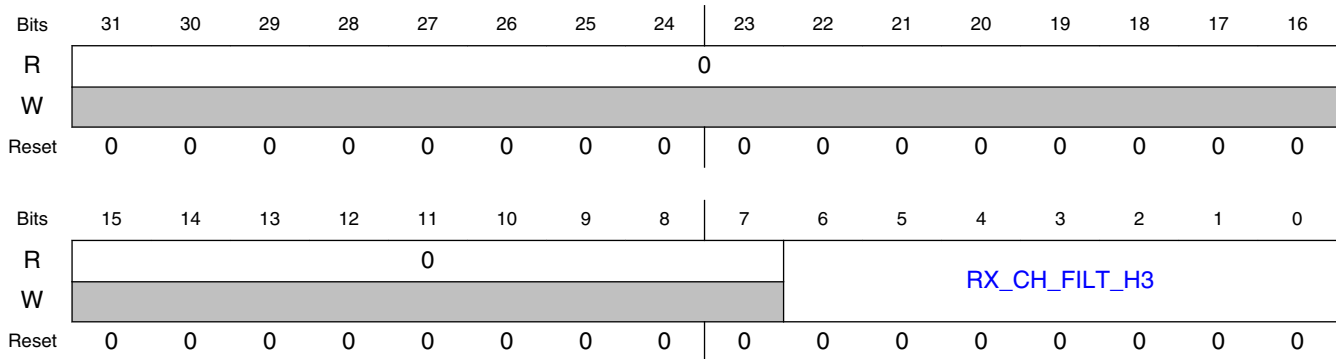
45.4.3.3.1.64.2 *Diagram*45.4.3.3.1.64.3 *Fields*

| Field | Function |
|--------------------------|---|
| 31-7 Reserved | Reserved. |
| 6-0 RX_CH_FILT_H 3 | RX Channel Filter Coefficient 3 RX Channel Filter Coefficient 3, 7-bit signed fractional |

45.4.3.3.1.65 Receive Channel Filter Coefficient 4 (RX_CHF_COEF_4)

45.4.3.3.1.65.1 Offset

| Register | Offset |
|---------------|-----------|
| RX_CHF_COEF_4 | 4005C1B0h |

45.4.3.3.1.65.2 Diagram

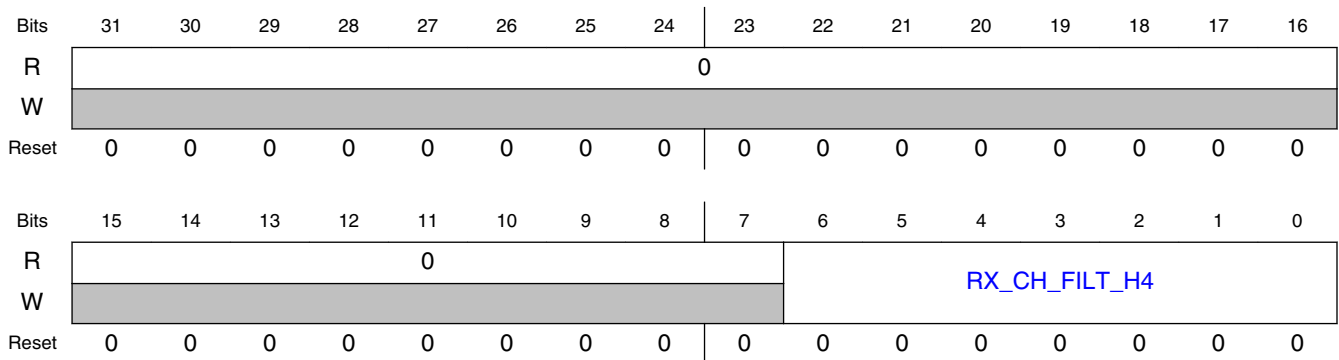

45.4.3.3.1.65.3 Fields

| Field | Function |
|--------------------------|---|
| 31-7 Reserved | Reserved. |
| 6-0 RX_CH_FILT_H 4 | RX Channel Filter Coefficient 4 RX Channel Filter Coefficient 4, 7-bit signed fractional |

45.4.3.3.1.66 Receive Channel Filter Coefficient 5 (RX_CHF_COEF_5)

45.4.3.3.1.66.1 Offset

| Register | Offset |
|---------------|-----------|
| RX_CHF_COEF_5 | 4005C1B4h |

45.4.3.3.1.66.2 Diagram

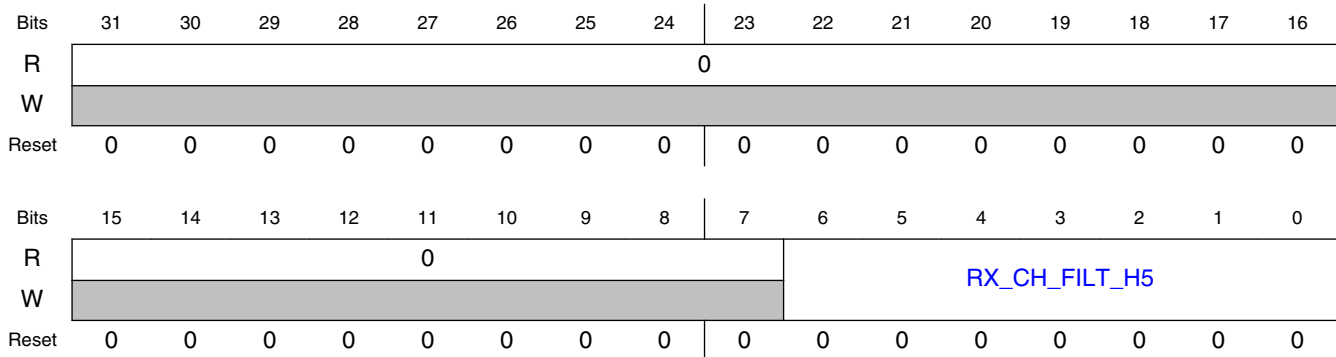

45.4.3.3.1.66.3 Fields

| Field | Function |
|--------------------------|---|
| 31-7 Reserved | Reserved. |
| 6-0 RX_CH_FILT_H 5 | RX Channel Filter Coefficient 5 RX Channel Filter Coefficient 5, 7-bit signed fractional |

45.4.3.3.1.67 Receive Channel Filter Coefficient 6 (RX_CHF_COEF_6)

45.4.3.3.1.67.1 Offset

| Register | Offset |
|---------------|-----------|
| RX_CHF_COEF_6 | 4005C1B8h |

45.4.3.3.1.67.2 Diagram

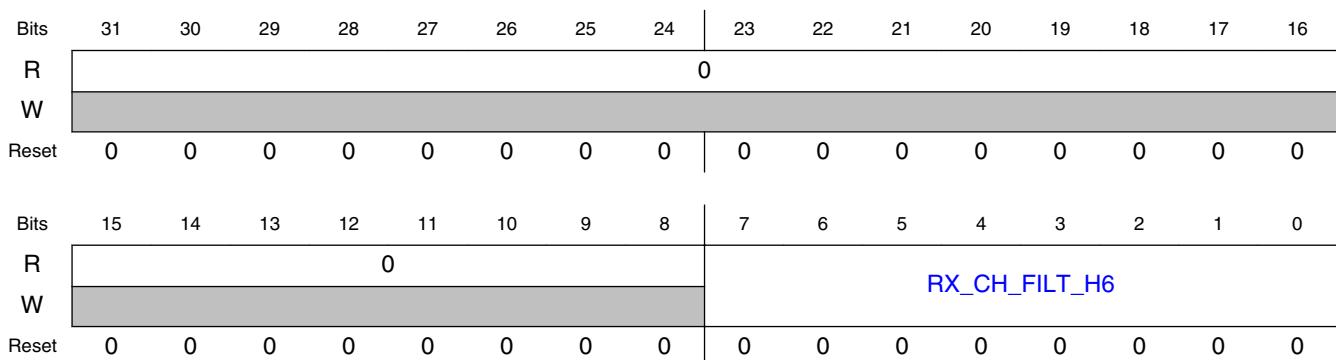

45.4.3.3.1.67.3 Fields

| Field | Function |
|--------------------------|---|
| 31-8 Reserved | Reserved. |
| 7-0 RX_CH_FILT_H 6 | RX Channel Filter Coefficient 6 RX Channel Filter Coefficient 6, 8-bit signed fractional |

45.4.3.3.1.68 Receive Channel Filter Coefficient 7 (RX_CHF_COEF_7)

45.4.3.3.1.68.1 Offset

| Register | Offset |
|---------------|-----------|
| RX_CHF_COEF_7 | 4005C1BCh |

45.4.3.3.1.68.2 Diagram

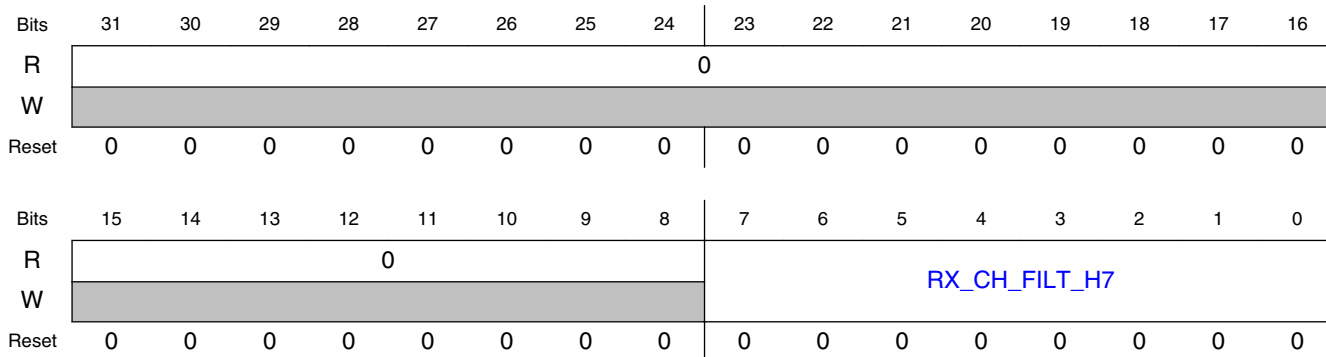

45.4.3.3.1.68.3 Fields

| Field | Function |
|--------------------------|---|
| 31-8 Reserved | Reserved. |
| 7-0 RX_CH_FILT_H 7 | RX Channel Filter Coefficient 7 RX Channel Filter Coefficient 7, 8-bit signed fractional |

45.4.3.3.1.69 Receive Channel Filter Coefficient 8 (RX_CHF_COEF_8)

45.4.3.3.1.69.1 Offset

| Register | Offset |
|---------------|-----------|
| RX_CHF_COEF_8 | 4005C1C0h |

45.4.3.3.1.69.2 Diagram

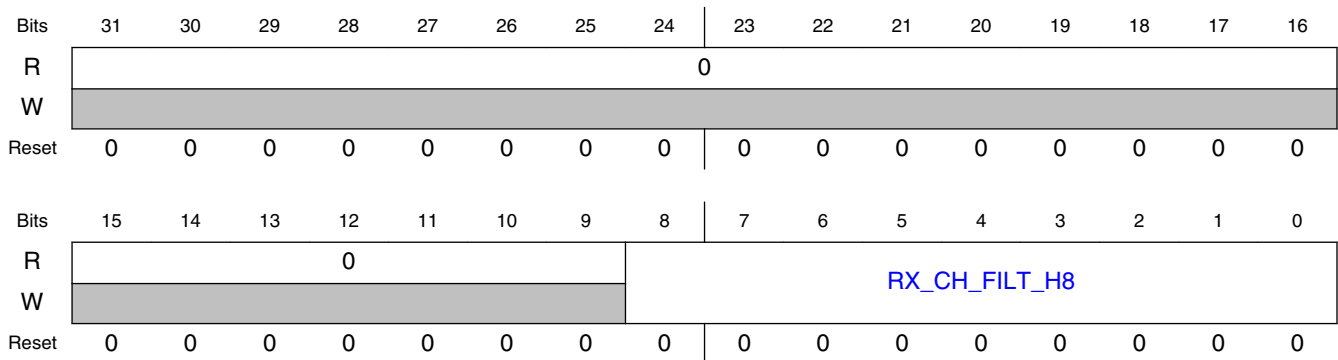

45.4.3.3.1.69.3 Fields

| Field | Function |
|--------------------------|---|
| 31-9 Reserved | Reserved. |
| 8-0 RX_CH_FILT_H 8 | RX Channel Filter Coefficient 8 RX Channel Filter Coefficient 8, 9-bit signed fractional |

45.4.3.3.1.70 Receive Channel Filter Coefficient 9 (RX_CHF_COEF_9)

45.4.3.3.1.70.1 Offset

| Register | Offset |
|---------------|-----------|
| RX_CHF_COEF_9 | 4005C1C4h |

FSK Modulator

45.4.3.3.1.70.2 Diagram

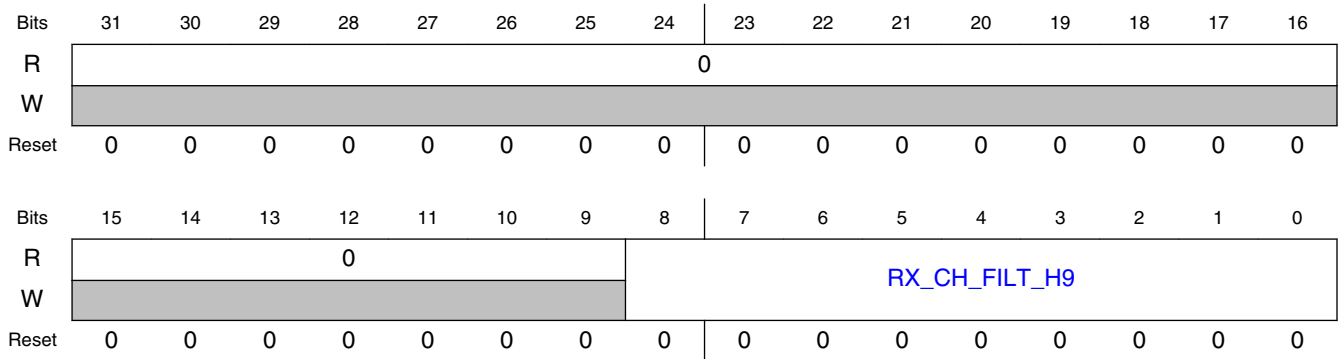

45.4.3.3.1.70.3 Fields

| Field | Function |
|----------------------|---|
| 31-9 Reserved | Reserved. |
| 8-0 RX_CH_FILT_H9 | RX Channel Filter Coefficient 9 RX Channel Filter Coefficient 9, 9-bit signed fractional |

45.4.3.3.1.71 Receive Channel Filter Coefficient 10 (RX_CHF_COEF_10)

45.4.3.3.1.71.1 Offset

| Register | Offset |
|----------------|-----------|
| RX_CHF_COEF_10 | 4005C1C8h |

45.4.3.3.1.71.2 Diagram

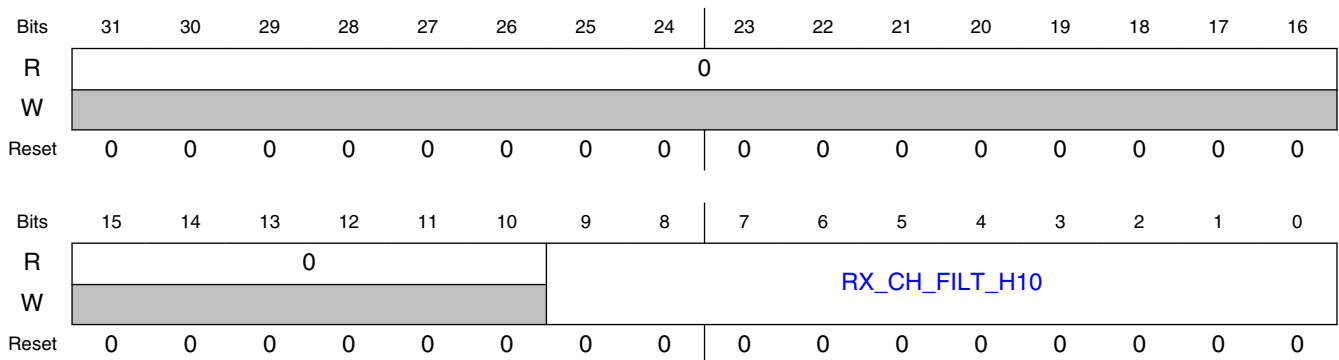

45.4.3.3.1.71.3 Fields

| Field | Function |
|---------------------------|--|
| 31-10 Reserved | Reserved. |
| 9-0 RX_CH_FILT_H 10 | RX Channel Filter Coefficient 10 RX Channel Filter Coefficient 10, 10-bit signed fractional |

45.4.3.3.1.72 Receive Channel Filter Coefficient 11 (RX_CHF_COEF_11)

45.4.3.3.1.72.1 Offset

| Register | Offset |
|----------------|-----------|
| RX_CHF_COEF_11 | 4005C1CCh |

45.4.3.3.1.72.2 Diagram

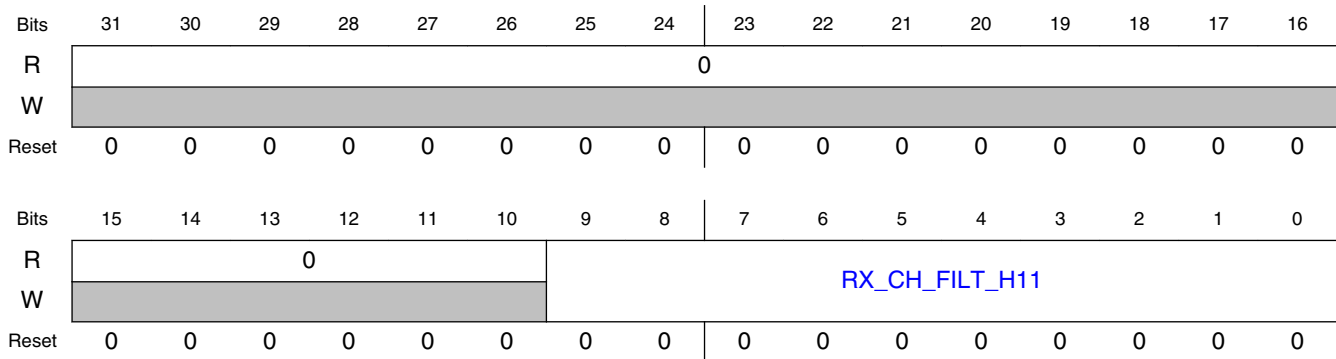

45.4.3.3.1.72.3 Fields

| Field | Function |
|---------------------------|--|
| 31-10 Reserved | Reserved. |
| 9-0 RX_CH_FILT_H 11 | RX Channel Filter Coefficient 11 RX Channel Filter Coefficient 11, 10-bit signed fractional |

45.4.3.3.1.73 AGC Manual AGC Index (AGC_MAN_AGC_IDX)

45.4.3.3.1.73.1 Offset

| Register | Offset |
|-----------------|-----------|
| AGC_MAN_AGC_IDX | 4005C1D0h |

45.4.3.3.1.73.2 Diagram

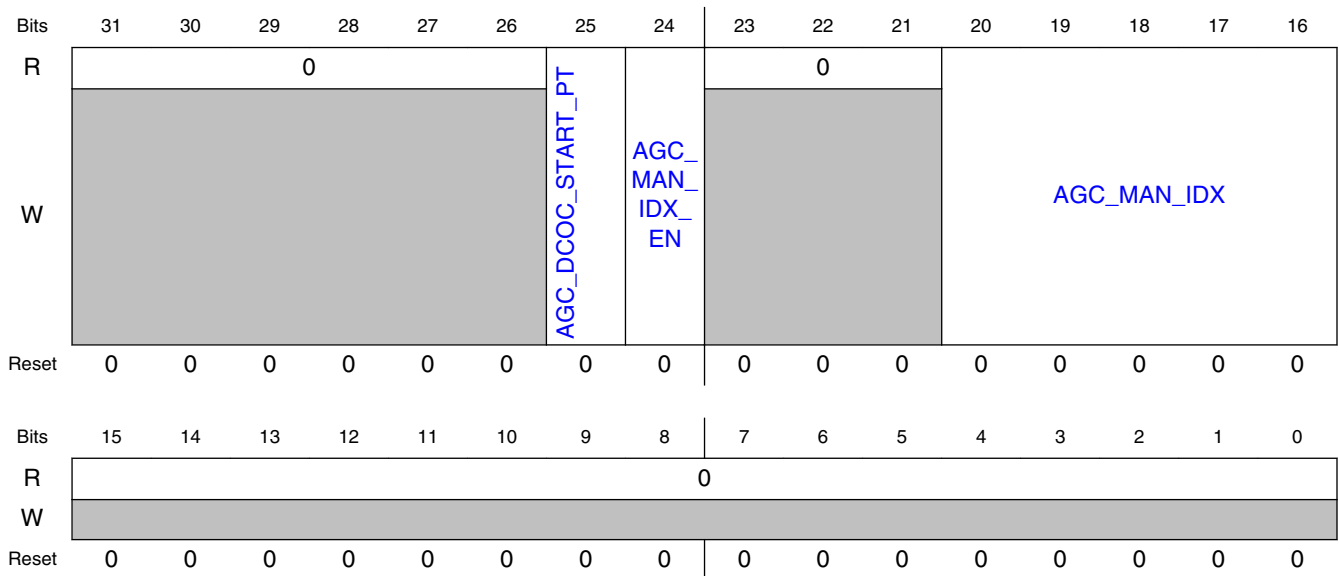

45.4.3.3.1.73.3 Fields

| Field | Function |
|-----------------------------|--|
| 31-26 — | Reserved. |
| 25 AGC_DCOC_S TART_PT | AGC DCOC Start Point When set, the starting value for the AGC gain table index after DCOC calibration will be AGC_MAN_IDX instead of index 26. |
| 24 AGC_MAN_IDX _EN | AGC Manual Index Enable When set, the AGC gain table index is overridden using AGC_MAN_IDX. |
| 23-21 — | Reserved. |
| 20-16 AGC_MAN_IDX | AGC Manual Index AGC gain table index override value (when AGC_MAN_IDX_EN is set), or AGC gain table index starting point after DCOC calibration (when AGC_DCOC_START_PT is set). |

Table continues on the next page...

| Field | Function |
|-----------|-----------|
| 15-0 — | Reserved. |

45.4.3.3.1.74 DC Residual Control (DC_RESID_CTRL)

45.4.3.3.1.74.1 Offset

| Register | Offset |
|---------------|-----------|
| DC_RESID_CTRL | 4005C1D4h |

45.4.3.3.1.74.2 Diagram

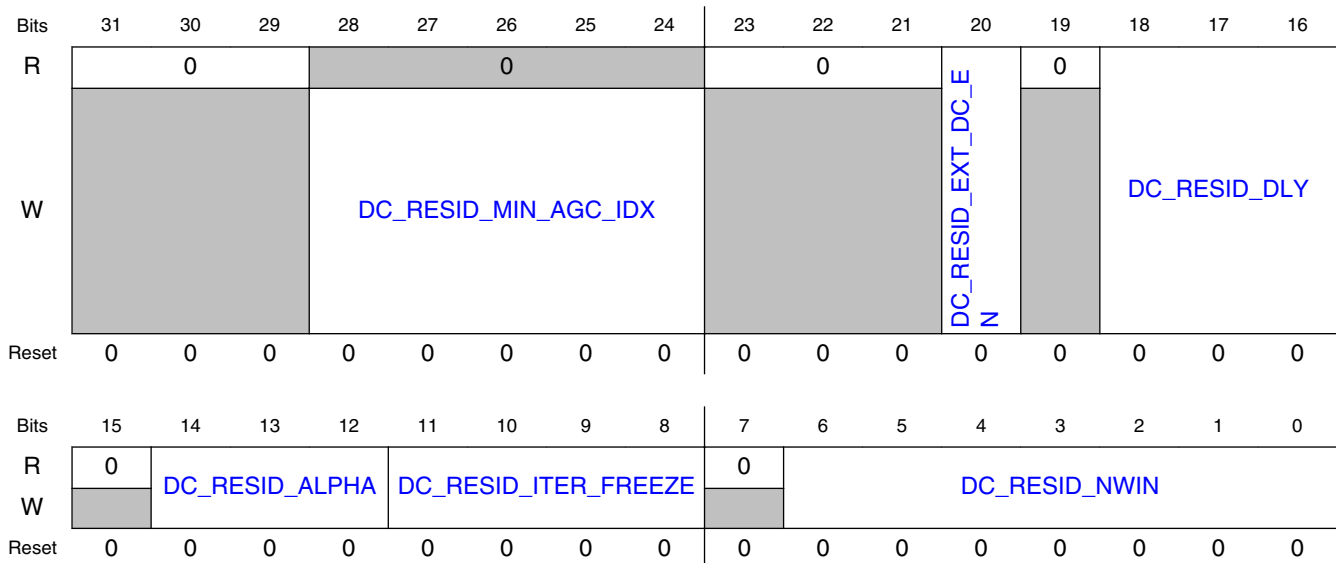

45.4.3.3.1.74.3 Fields

| Field | Function |
|-------------------------------|--|
| 31-29 — | Reserved. |
| 28-24 DC_RESID_MIN_AGC_IDX | DC Residual Minimum AGC Table Index Specifies the minimum AGC table index value at which DC residual can be enabled. E.g., if this is 5'd0, then the DC residual is enabled for all AGC gain table indexes (assuming RX_DC_RESID_EN is set) if this is 5'd20, then tracking is enabled for AGC gain table indexes 20-26 (assuming RX_DC_RESID_EN is set). |

Table continues on the next page...

FSK Modulator

| Field | Function |
|----------------------------------|--|
| 23-21 — | Reserved. |
| 20 DC_RESID_EX T_DC_EN | DC Residual External DC Enable 0b - External DC disable. The DC Residual activates at a delay specified by DC_RESID_DLY after an AGC gain change pulse. The DC Residual is initialized with a DC offset of 0. 1b - External DC enable. The DC residual activates after the DCOC's tracking hold timer expires. The DC Residual is initialized with the DC estimate from the DCOC tracking estimator. |
| 19 — | Reserved. |
| 18-16 DC_RESID_DL Y | DC Residual Delay The delay from activation of the DC residual block to the time when it starts processing. For a 32MHz reference clock, the delay in microseconds matches the value programmed. For other clock frequencies, the delay is scaled based on the clock period. Supported values: 0-7. This delay is only used when EXT_DC_EN=0. |
| 15 — | Reserved. |
| 14-12 DC_RESID_AL PHA | DC Residual Alpha The Alpha parameter controls the rate at which the DC estimate is updated. The update factor is $2^{(-\text{Alpha})}$. |
| 11-8 DC_RESID_ITE R_FREEZE | DC Residual Iteration Freeze Number of windows of DC_RESID_NWIN samples before the DC is frozen. Supported values: 1-8 |
| 7 — | Reserved. |
| 6-0 DC_RESID_NW IN | DC Residual NWIN Number of samples in a window. |

45.4.3.3.1.75 DC Residual Estimate (DC_RESID_EST)

45.4.3.3.1.75.1 Offset

| Register | Offset |
|--------------|-----------|
| DC_RESID_EST | 4005C1D8h |

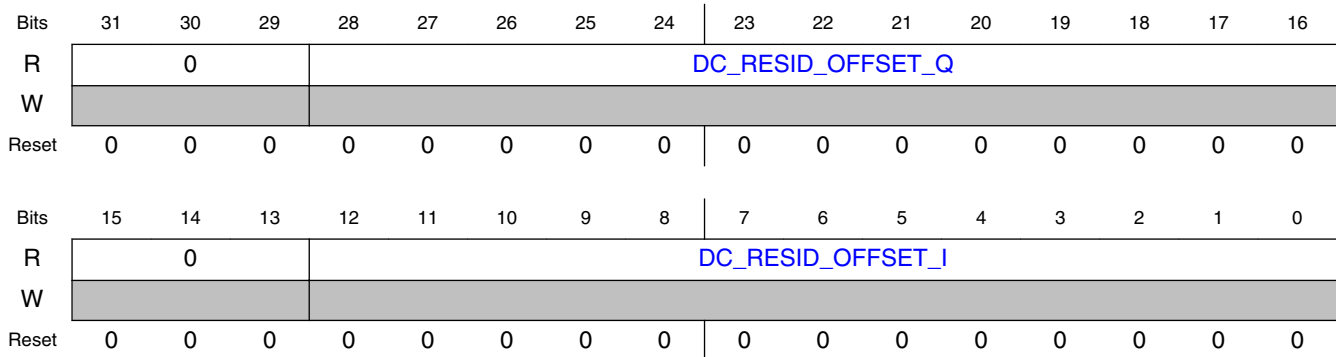
45.4.3.3.1.75.2 *Diagram*45.4.3.3.1.75.3 *Fields*

| Field | Function |
|--------------------------------|---|
| 31-29 — | Reserved. |
| 28-16 DC_RESID_OF FSET_Q | DC Residual Offset Q Reflects the current DC residual offset estimate for Q channel. Format is s11.1. This is provided for debug and characterization purposes only. |
| 15-13 — | Reserved. |
| 12-0 DC_RESID_OF FSET_I | DC Residual Offset I Reflects the current DC residual offset estimate for I channel. Format is s11.1. This is provided for debug and characterization purposes only. |

45.4.3.3.1.76 **RX RC Calibration Control0 (RX_RCCAL_CTRL0)**45.4.3.3.1.76.1 *Offset*

| Register | Offset |
|----------------|-----------|
| RX_RCCAL_CTRL0 | 4005C1DCh |

45.4.3.3.1.76.2 Diagram

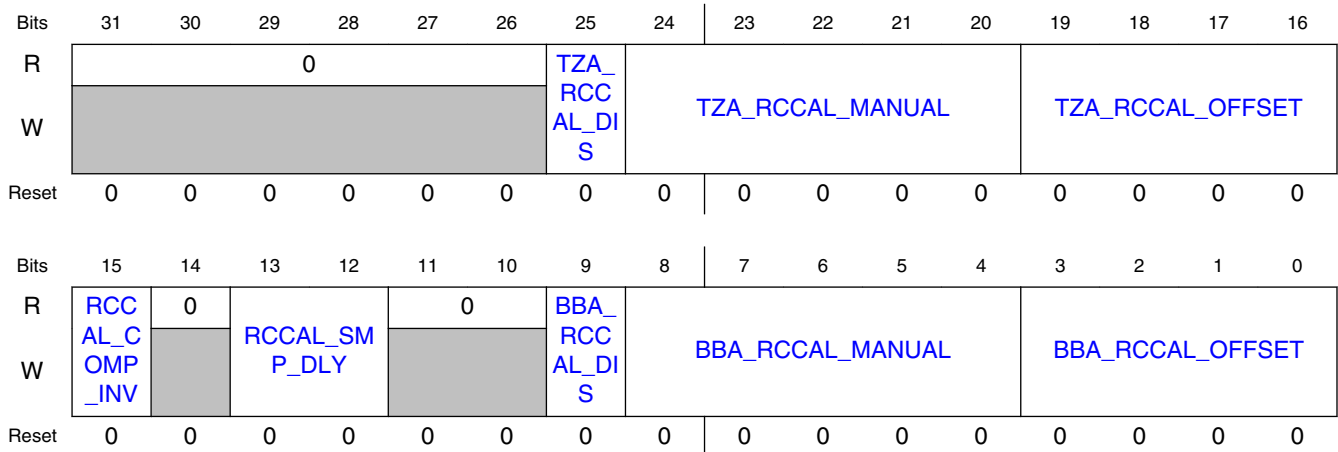

45.4.3.3.1.76.3 Fields

| Field | Function |
|---------------------------|---|
| 31-26 — | Reserved. |
| 25 TZA_RCCAL_DIS | TZA RC Calibration Disable 0b - TZA RC Calibration is enabled 1b - TZA RC Calibration is disabled |
| 24-20 TZA_RCCAL_MANUAL | TZA RC Calibration manual value If TZA_RCCAL_DIS bit is set, this value is used for the TZA calibration. |
| 19-16 TZA_RCCAL_OFFSET | TZA RC Calibration value offset Offset added to the RC Calibration code to determine the calibration value used for the TZA. Format is s3. |
| 15 RCCAL_COMP_INV | RC Calibration comp_out Invert 0b - The comp_out signal polarity is NOT inverted 1b - The comp_out signal polarity is inverted |
| 14 — | Reserved. |
| 13-12 RCCAL_SMP_DLY | RC Calibration Sample Delay 00b - The comp_out signal is sampled 0 clk cycle after sample signal is deasserted 01b - The comp_out signal is sampled 1 clk cycle after sample signal is deasserted 10b - The comp_out signal is sampled 2 clk cycle after sample signal is deasserted 11b - The comp_out signal is sampled 3 clk cycle after sample signal is deasserted |
| 11-10 — | Reserved. |
| 9 BBA_RCCAL_DIS | BBA RC Calibration Disable 0b - BBA RC Calibration is enabled 1b - BBA RC Calibration is disabled |

Table continues on the next page...

| Field | Function |
|-----------------------------|---|
| 8-4 BBA_RCCAL_M ANUAL | BBA RC Calibration manual value If BBA_RCCAL_DIS bit is set, this value is used for the BBA calibration. |
| 3-0 BBA_RCCAL_O FFSET | BBA RC Calibration value offset Offset added to the RC Calibration code to determine the calibration value used for the BBA. Format is s3. |

45.4.3.3.1.77 RX RC Calibration Control1 (RX_RCCAL_CTRL1)

45.4.3.3.1.77.1 Offset

| Register | Offset |
|----------------|-----------|
| RX_RCCAL_CTRL1 | 4005C1E0h |

45.4.3.3.1.77.2 Diagram

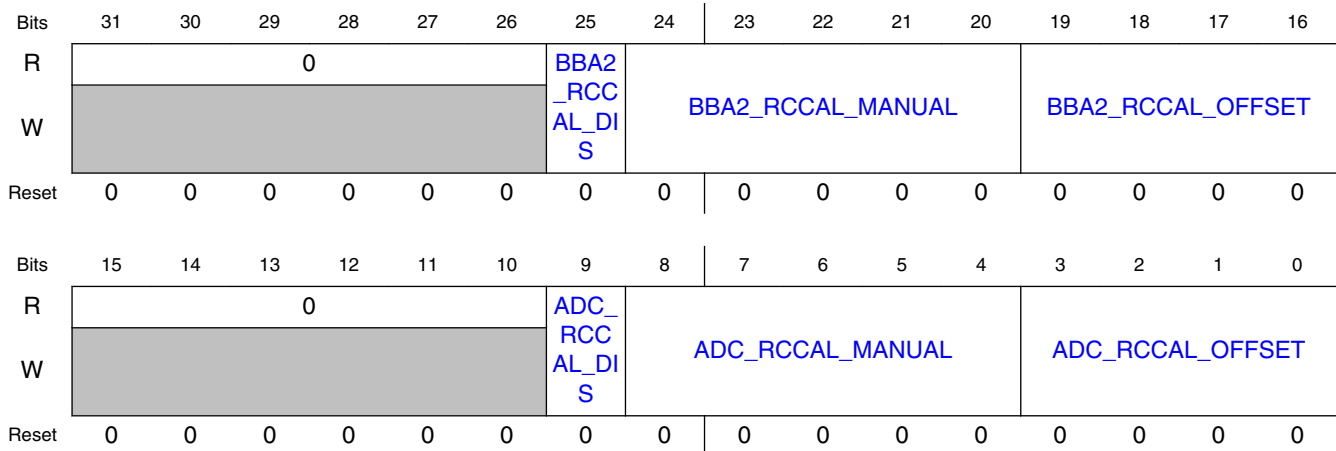

45.4.3.3.1.77.3 Fields

| Field | Function |
|--------------------------|--|
| 31-26 — | Reserved. |
| 25 BBA2_RCCAL_ DIS | BBA2 RC Calibration Disable 0b - BBA2 RC Calibration is enabled 1b - BBA2 RC Calibration is disabled |
| 24-20 | BBA2 RC Calibration manual value |

Table continues on the next page...

FSK Modulator

| Field | Function |
|-------------------|---|
| BBA2_RCCAL_MANUAL | If BBA2_RCCAL_DIS bit is set, this value is used for the BBA2 calibration. |
| 19-16 | BBA2 RC Calibration value offset |
| BBA2_RCCAL_OFFSET | Offset added to the RC Calibration code to determine the calibration value used for the BBA2. Format is s3. |
| 15-10 — | Reserved. |
| 9 | ADC RC Calibration Disable 0b - ADC RC Calibration is enabled 1b - ADC RC Calibration is disabled |
| ADC_RCCAL_DIS | |
| 8-4 | ADC RC Calibration manual value |
| ADC_RCCAL_MANUAL | If ADC_RCCAL_DIS bit is set, this value is used for the ADC calibration. |
| 3-0 | ADC RC Calibration value offset |
| ADC_RCCAL_OFFSET | Offset added to the RC Calibration code to determine the calibration value used for the ADC. Format is s3. |

45.4.3.3.1.78 RX RC Calibration Status (RX_RCCAL_STAT)

45.4.3.3.1.78.1 Offset

| Register | Offset |
|---------------|-----------|
| RX_RCCAL_STAT | 4005C1E4h |

45.4.3.3.1.78.2 Diagram

| | | | | | | | | | | | | | | | | | |
|-------|----|------------|----|----|----|----|-----------|-----------|----|----|----|----|-----------|------------|----|----|--|
| Bits | 31 | 30 | 29 | 28 | 27 | 26 | 25 | 24 | 23 | 22 | 21 | 20 | 19 | 18 | 17 | 16 | |
| R | 0 | | | | | | TZA_RCCAL | | | | | | BBA_RCCAL | | | | |
| W | — | | | | | | | | | | | | | | | | |
| Reset | 0 | 0 | 0 | 0 | 0 | 0 | 1 | 0 | 0 | 0 | 0 | 1 | 0 | 0 | 0 | 0 | |
| Bits | 15 | 14 | 13 | 12 | 11 | 10 | 9 | 8 | 7 | 6 | 5 | 4 | 3 | 2 | 1 | 0 | |
| R | 0 | BBA2_RCCAL | | | | | | ADC_RCCAL | | | | | | RCCAL_CODE | | | |
| W | — | | | | | | | | | | | | | | | | |
| Reset | 0 | 1 | 0 | 0 | 0 | 0 | 1 | 0 | 0 | 0 | 0 | 1 | 0 | 0 | 0 | 0 | |

45.4.3.3.1.78.3 *Fields*

| Field | Function |
|---------------------|---|
| 31-26 — | Reserved. |
| 25-21 TZA_RCCAL | TZA RC Calibration The RC Calibration value used for TZA |
| 20-16 BBA_RCCAL | BBA RC Calibration The RC Calibration value used for BBA |
| 15 — | Reserved. |
| 14-10 BBA2_RCCAL | BBA2 RC Calibration The RC Calibration value used for BBA2 |
| 9-5 ADC_RCCAL | ADC RC Calibration The RC Calibration value used for ADC |
| 4-0 RCCAL_CODE | RC Calibration code The RC Calibration code currently applied to the calibration circuit |

45.4.3.3.1.79 **Aux PLL Frequency Calibration Control (AUXPLL_FCAL_CTRL)**45.4.3.3.1.79.1 *Offset*

| Register | Offset |
|------------------|-----------|
| AUXPLL_FCAL_CTRL | 4005C1E8h |

45.4.3.3.1.79.2 Diagram

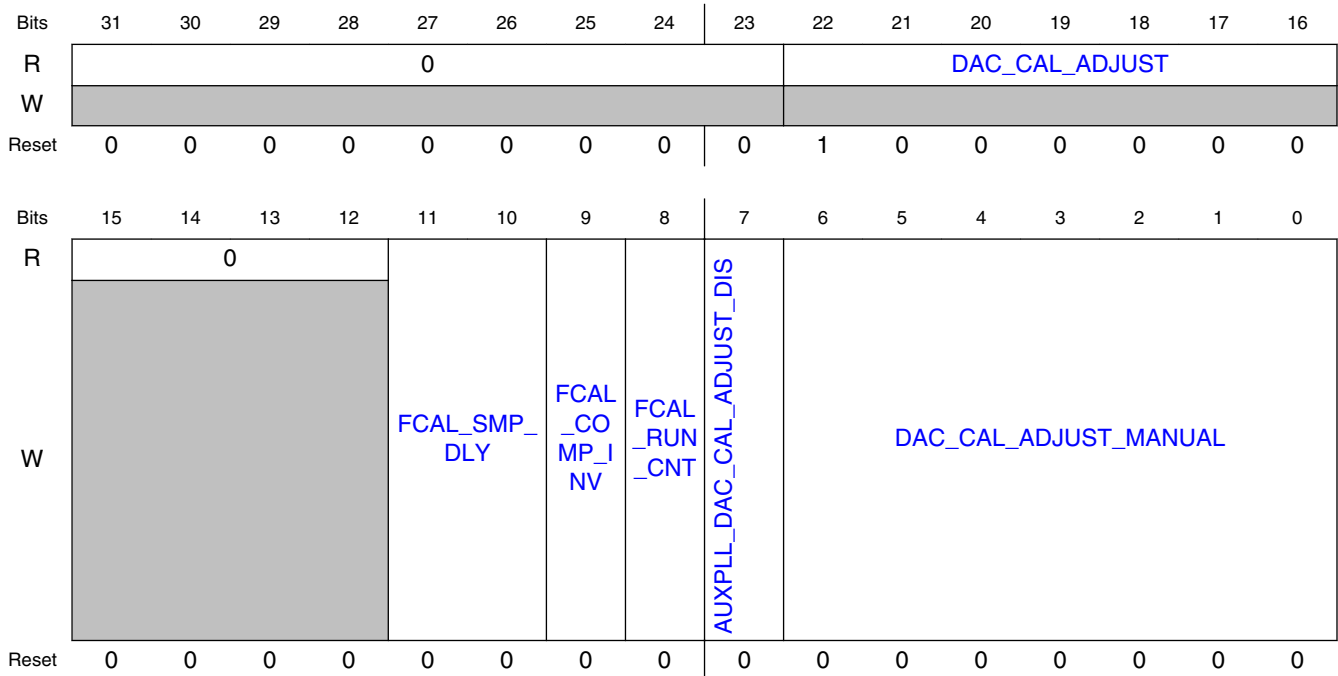

45.4.3.3.1.79.3 Fields

| Field | Function |
|-------------------------|--|
| 31-23 — | Reserved. |
| 22-16 DAC_CAL_ADJUST | Aux PLL DAC Calibration Adjust value The DAC calibration adjust value applied to the calibration circuit. |
| 15-12 — | Reserved. |
| 11-10 FCAL_SMP_DLY | Aux PLL Frequency Calibration Sample Delay 00b - The count signal is sampled 1 clk cycle after fcal_run signal is deasserted 01b - The count signal is sampled 2 clk cycle after fcal_run signal is deasserted 10b - The count signal is sampled 3 clk cycle after fcal_run signal is deasserted 11b - The count signal is sampled 4 clk cycle after fcal_run signal is deasserted |
| 9 FCAL_COMP_INV | Aux PLL Frequency Calibration Comparison Invert 0b - (Default) The comparison associated with the count is not inverted. 1b - The comparison associated with the count is inverted |
| 8 FCAL_RUN_CNT | Aux PLL Frequency Calibration Run Count 0b - Run count is 256 clock cycles 1b - Run count is 512 clock cycles |
| 7 | Aux PLL Frequency Calibration Disable 0b - Calibration is enabled 1b - Calibration is disabled |

Table continues on the next page...

| Field | Function |
|---------------------------|---|
| AUXPLL_DAC_CAL_ADJUST_DIS | |
| 6-0 | Aux PLL Frequency DAC Calibration Adjust Manual value |
| DAC_CAL_ADJUST_MANUAL | If AUXPLL_DAC_CAL_ADJUST_DIS bit is set, this DAC calibration adjust value is applied to the calibration circuit. |

45.4.3.3.1.80 Aux PLL Frequency Calibration Count 6 (AUXPLL_FCAL_CNT6)

45.4.3.3.1.80.1 Offset

| Register | Offset |
|------------------|-----------|
| AUXPLL_FCAL_CNT6 | 4005C1ECh |

45.4.3.3.1.80.2 Diagram

| | | | | | | | | | | | | | | | | |
|-------|----------|----|----|----|----|----|----|---------------|----|----|----|----|----|----|----|----|
| Bits | 31 | 30 | 29 | 28 | 27 | 26 | 25 | 24 | 23 | 22 | 21 | 20 | 19 | 18 | 17 | 16 |
| R | 0 | | | | | | | FCAL_BESTDIFF | | | | | | | | |
| W | [Shaded] | | | | | | | | | | | | | | | |
| Reset | 0 | 0 | 0 | 0 | 0 | 0 | 0 | 0 | 0 | 0 | 0 | 0 | 0 | 0 | 0 | 0 |
| Bits | 15 | 14 | 13 | 12 | 11 | 10 | 9 | 8 | 7 | 6 | 5 | 4 | 3 | 2 | 1 | 0 |
| R | 0 | | | | | | | FCAL_COUNT_6 | | | | | | | | |
| W | [Shaded] | | | | | | | | | | | | | | | |
| Reset | 0 | 0 | 0 | 0 | 0 | 0 | 0 | 0 | 0 | 0 | 0 | 0 | 0 | 0 | 0 | 0 |

45.4.3.3.1.80.3 Fields

| Field | Function |
|------------------------|---|
| 31-26 — | Reserved. |
| 25-16 FCAL_BESTDIFF | Aux PLL Frequency Calibration Best Difference The smallest absolute difference between the count value output by the calibration circuit and the expected count value found during the calibration sequence. |
| 15-10 — | Reserved. |
| 9-0 FCAL_COUNT_6 | Aux PLL Frequency Calibration Count 6 The count value output by the calibration circuit for calibration phase 6. |

45.4.3.3.1.81 Aux PLL Frequency Calibration Count 5 and 4 (AUXPLL_FCAL_CNT5_4)

45.4.3.3.1.81.1 Offset

| Register | Offset |
|--------------------|-----------|
| AUXPLL_FCAL_CNT5_4 | 4005C1F0h |

45.4.3.3.1.81.2 Diagram

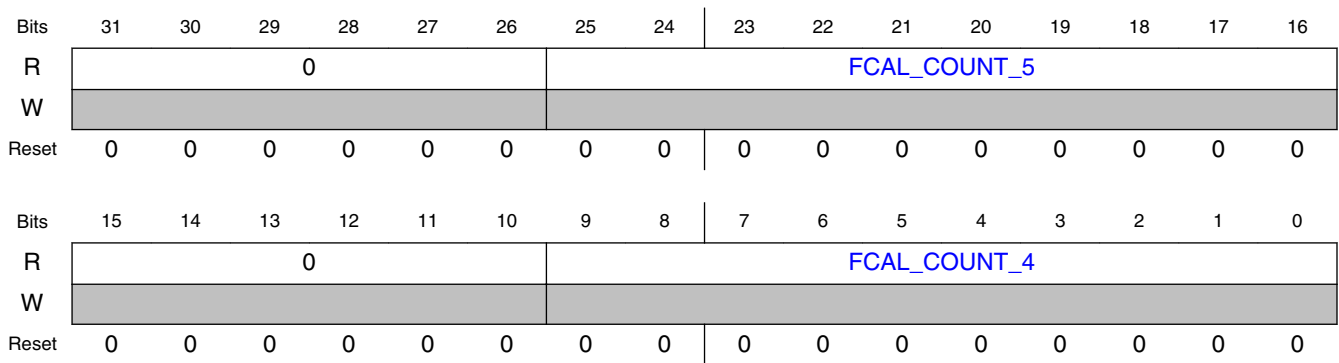

45.4.3.3.1.81.3 Fields

| Field | Function |
|-----------------------|---|
| 31-26 — | Reserved. |
| 25-16 FCAL_COUNT_5 | Aux PLL Frequency Calibration Count 5 The count value output by the calibration circuit for calibration phase 5. |
| 15-10 — | Reserved. |
| 9-0 FCAL_COUNT_4 | Aux PLL Frequency Calibration Count 4 The count value output by the calibration circuit for calibration phase 4. |

45.4.3.3.1.82 Aux PLL Frequency Calibration Count 3 and 2 (AUXPLL_FCAL_CNT3_2)

45.4.3.3.1.82.1 Offset

| Register | Offset |
|--------------------|-----------|
| AUXPLL_FCAL_CNT3_2 | 4005C1F4h |

45.4.3.3.1.82.2 Diagram

| | | | | | | | | | | | | | | | | |
|-------|--------------|----|----|----|----|----|----|----|--------------|----|----|----|----|----|----|----|
| Bits | 31 | 30 | 29 | 28 | 27 | 26 | 25 | 24 | 23 | 22 | 21 | 20 | 19 | 18 | 17 | 16 |
| R | 0 | | | | | | | | FCAL_COUNT_3 | | | | | | | |
| W | [Greyed out] | | | | | | | | | | | | | | | |
| Reset | 0 | 0 | 0 | 0 | 0 | 0 | 0 | 0 | 0 | 0 | 0 | 0 | 0 | 0 | 0 | 0 |
| Bits | 15 | 14 | 13 | 12 | 11 | 10 | 9 | 8 | 7 | 6 | 5 | 4 | 3 | 2 | 1 | 0 |
| R | 0 | | | | | | | | FCAL_COUNT_2 | | | | | | | |
| W | [Greyed out] | | | | | | | | | | | | | | | |
| Reset | 0 | 0 | 0 | 0 | 0 | 0 | 0 | 0 | 0 | 0 | 0 | 0 | 0 | 0 | 0 | 0 |

45.4.3.3.1.82.3 Fields

| Field | Function |
|-----------------------|---|
| 31-26 — | Reserved. |
| 25-16 FCAL_COUNT_3 | Aux PLL Frequency Calibration Count 3 The count value output by the calibration circuit for calibration phase 3. |
| 15-10 — | Reserved. |
| 9-0 FCAL_COUNT_2 | Aux PLL Frequency Calibration Count 2 The count value output by the calibration circuit for calibration phase 2. |

45.4.3.3.1.83 Aux PLL Frequency Calibration Count 1 and 0 (AUXPLL_FCAL_CNT1_0)

45.4.3.3.1.83.1 Offset

| Register | Offset |
|--------------------|-----------|
| AUXPLL_FCAL_CNT1_0 | 4005C1F8h |

45.4.3.3.1.83.2 Diagram

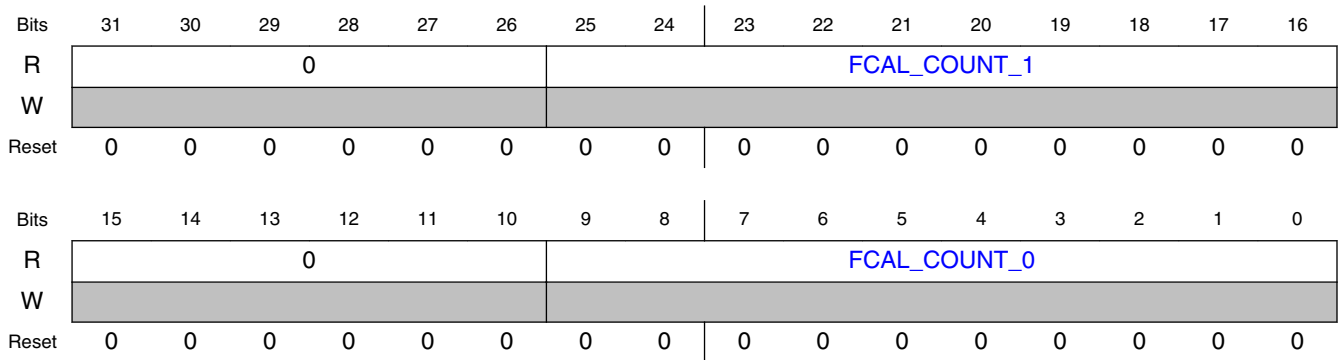

45.4.3.3.1.83.3 Fields

| Field | Function |
|-----------------------|---|
| 31-26 — | Reserved. |
| 25-16 FCAL_COUNT_1 | Frequency Calibration Count 1 The count value output by the calibration circuit for calibration phase 1. |
| 15-10 — | Reserved. |
| 9-0 FCAL_COUNT_0 | Frequency Calibration Count 0 The count value output by the calibration circuit for calibration phase 0. |

45.4.4 Bit Streaming Mode

45.4.4.1 Introduction

The 2.4GHz Radio features a Bit Streaming Mode for BLE. When activated, this feature allows all received BLE packet data, to be serialized and shifted out to external hardware for further processing.

45.4.4.1.1 Overview

Bit Streaming Mode (BSM) allows all received BLE packet data, to be serialized and shifted out to external hardware for further processing. A simple development system can be crafted to consume the BSM outputs and generate packet trace data for all BLE traffic appearing on a network, within range of the receiving device. This enables network-level monitoring and debugging. BSM-for-BLE uses a simple, synchronous 3-wire interface, consisting of BSM_CLK, BSM_DATA, and BSM_FRAME outputs. Packet data is shifted out serially, at the BLE bit rate (1MHz). Signalling is provided on BSM_FRAME to indicate the start of reception. BSM_DATA and BSM_FRAME are synchronous to BSM_CLK. BSM_DATA and BSM_FRAME are valid at rising BSM_CLK, and are intended to be captured on that edge. A single control bit activates or deactivates BSM. Aside from controlling this bit, BSM requires no software support from the host processor. The SoC's BSM outputs are multiplexed with GPIO, so that the pins are available for general purpose use when BSM is disabled. BSM does not interfere with BLE packet processing in any way; it is merely a passive monitoring and debugging tool. BSM, when engaged, will not measurably increase current consumption, since the BSM module operates at a 1MHz clock rate. Only received packets are made available to BSM; packets transmitted by the device do not appear on the BSM interface.

This BSM implementation features some new automation not included in previous BSM versions. Access Address checking is now done in hardware, not software. No protocol engine (link layer) is engaged, so software communicates directly with the transceiver (PHY), reducing initialization overhead. And there are no "blind spots" due to link layer SCAN_INTERVAL timeouts. Packets can be received at any time under direct software control.

45.4.4.1.2 Features

- Enables monitoring and debugging of all network traffic within range of the device
- Simple, synchronous 3-wire interface facilitates external hardware development
- Low power consumption
- Non-intrusive design
- Minimal software support required
- Hardware Access Address Correlation
- No Link Layer Overhead

45.4.4.1.3 Block Diagram

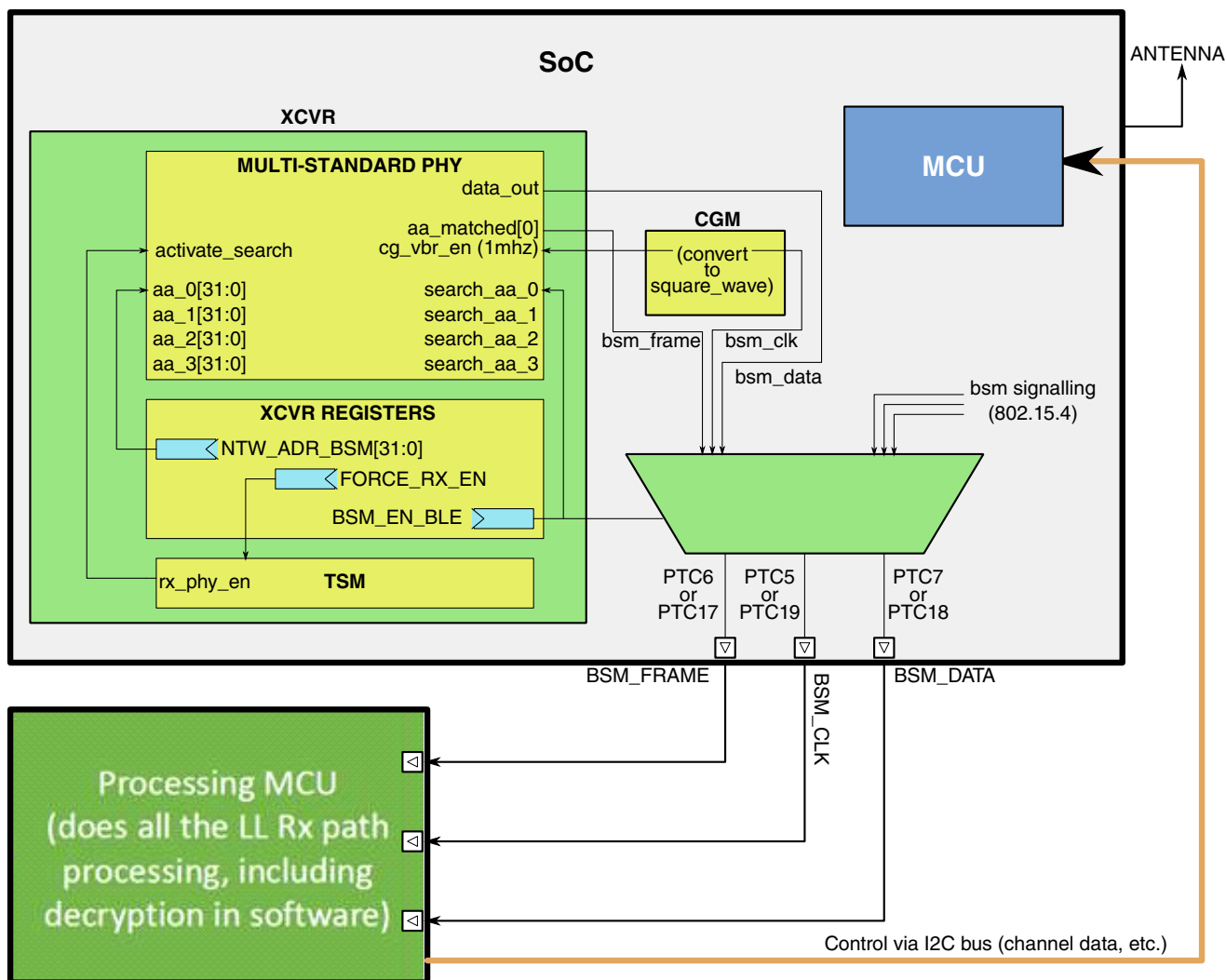

Figure 45-46. BSM Block Diagram

45.4.4.2 External Signal Descriptions

| Name | Direction | Size | Description |
|-----------|-----------|------|--|
| BSM_DATA | output | 1 | Serial BLE packet bit stream, LSB-first. Valid on rising edge of BSM_CLK |
| BSM_FRAME | output | 1 | Framing signal to indicate the start of reception. Active high |
| BSM_CLK | output | 1 | 1MHz bit-rate clock. BSM_DATA and BSM_FRAME are |

| Name | Direction | Size | Description |
|------|-----------|------|--|
| | | | synchronized to BSM_CLK. External device should capture BSM_FRAME and BSM_DATA on rising edge of BSM_CLK |

45.4.4.3 Memory Map and Register Definition

BSM-for-BLE is enabled by a single register bit. The bit is BSM_EN_BLE. This bit resides in the PHY_CFG1 register of XCVR address space. Several other programmable configuration parameters pertaining to BSM mode are listed in the table below.

| Register | Address | Field | Bit(s) | Description |
|-------------|-------------------|----------------------|---------|---|
| PHY_CFG1 | XCVR_BASE + 0x420 | BSM_EN_BLE | [5] | 1: enable BSM (bit streaming mode) for BLE 0:disable BSM When enabled, the 3 BSM outputs (BSM_DATA, BSM_FRAME, and BSM_BLK) appear on the BSM interface pins of the SoC. At the SoC level, these are alternate, muxed-GPIO pins, so the appropriate port programming is required. |
| NTW_ADR_BSM | XCVR_BASE + 0x42C | NTW_ADR_BSM[31:0] | [31:0] | PHY will search for this Access Address when BSM_EN_BLE=1 |
| PHY_CFG1 | XCVR_BASE + 0x420 | BLE_NTW_ADR_THR[2:0] | [30:28] | PHY will tolerate this many bit errors in its search for NTW_ADR_BSM |
| TSM_CTRL | XCVR_BASE + 0x2C0 | FORCE_RX_EN | [3] | Software will set FORCE_RX_EN=1 to launch an RX sequence in search of a packet with an Access Address equal to NTW_ADR_BSM. Software will clear FORCE_RX_EN=0 after the last bit of the packet has been received and processed |

| Register | Address | Field | Bit(s) | Description |
|----------|---------|-------|--------|---|
| | | | | by the application. Clearing this bit ends the RX sequence. |

45.4.4.4 Functional Description

The BSM implementation configures the device to enter receive mode and search the airwaves for BLE packets bearing an Access Address matching the one programmed by the application. In this mode, the application communicates directly with the Multi-standard PHY, and no link layers are engaged. Once configured and enabled for searching, BLE packets with an Access Address match will appear at the BSM pins of the device. An Access Address match will result in the device asserting `BSM_FRAME=1`. At this point, the device will begin shifting out the packet bits serially, LSB first, starting with the packet header (preamble and Access Address will *not* appear on the BSM pins). The BSM pins are a synchronous interface to an external MCU. `BSM_FRAME` and `BSM_DATA` bits change on the falling edge of `BSM_CLK`. The external device must capture `BSM_FRAME` and `BSM_DATA` on the rising edge. The application is responsible for all packet processing after the AA match (`BSM_FRAME=1`), including header parsing and CRC checking. The application terminates the receive operation once the last bit of the packet has been received and processed by the application. The number of bit errors tolerated by the PHY in its correlation of Access Address is programmable, with a default setting of 1 bit error tolerated. The BSM hardware on the device has no knowledge of Bluetooth Low Energy states, so it is up to the application to track BLE state (e.g., Advertising, Initiating), and configure the Access Address accordingly.

The following steps can be used to receive a BLE packet in BSM mode:

1. Configure the RX digital for BLE protocol
2. Configure the PHY for BLE protocol
3. Set `PHY_CFG1[BSM_EN_BLE]=1` to enable BSM feature
4. Program the desired Access Address into the `NTW_ADR_BSM` register
5. Program the desired maximum number of tolerated bit errors into `PHY_CFG1[BTLE_NTW_ADR_THR]`
6. Set `TSM_CTRL[FORCE_RX_EN]=1` to initiate the RX sequence
7. Monitor the BSM interface for `BSM_FRAME=1` (Access Address match)
8. After `BSM_FRAME=1`, use each rising edge of `BSM_CLK` to capture the next bit of `BSM_DATA`
9. Shift in and parse the incoming packet on the fly, using the header to determine packet length

10. After the last bit of CRC, terminate the RX sequence by clearing TSM_CTRL[FORCE_RX_EN]=0.

The following diagram depicts the occurrence of a BLE packet which matches the programmed Access Address at the BSM interface:

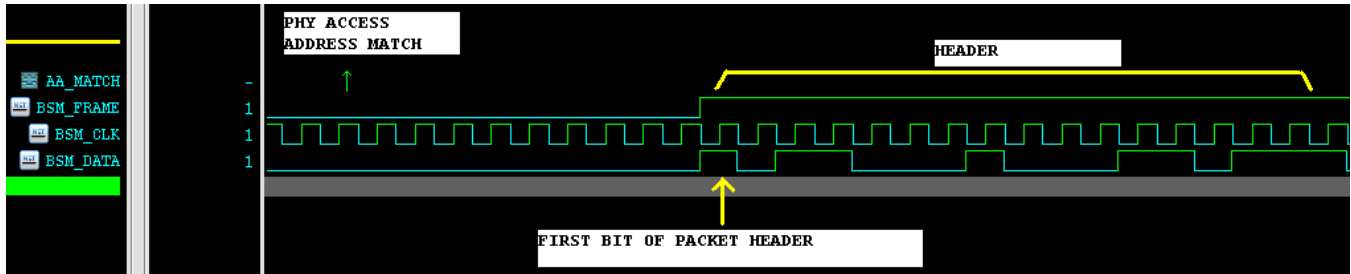

Figure 45-47. BSM Timing Diagram

The following sequence of events is depicted in the diagram

1. AA match occurs internally in the PHY
2. A delay of several microseconds after internal PHY AA match (transparent to application)
3. BSM_FRAME is asserted
4. At the next rising edge of BSM_CLK, first bit of packet header (LSB) is valid
5. Subsequent header bits are shifted out LSB-first on BSM_DATA, valid at each rising edge of BSM_CLK
6. Payload and CRC bits follow the header

The PHY_STATUS register (XCVR_BASE + 0x430) contains several fields which may assist software monitoring the BSM interface:

| Field | Bit(s) | Description |
|----------------|--------|--|
| PREAMBLE_FOUND | [0] | PHY has detected a BLE preamble. This should not be relied on by the application but it may be useful for debug. In the hardware, preamble detection is a prerequisite for Access Address correlation. |
| AA_SFD_MATCHED | [1] | PHY has detected an Access Address match. After a delay of several microseconds, BSM_FRAME will be asserted and packet data bit shifting will commence. |
| AA_MATCHED[0] | [4] | Indicates that the Access Address match occurred on the PHY's Network Address 0 input. This will always be the case for BLE. |

Software could elect to poll the AA_SFD_MATCHED bit, to determine when to start monitoring the BSM_FRAME, since AA_SFD_MATCHED will transition high several microseconds before BSM_FRAME=1. A procedure for polling AA_SFD_MATCHED as a prerequisite to the monitoring of the BSM interface pins, is as follows:

1. Ascertain the length of the RX Warmup by reading the third byte of the END_OF_SEQ register in XCVR space
2. Set variable **end_of_rx_wu** to this value: **end_of_seq** = (r32(END_OF_SEQ) & 0xFF0000) >> 16
3. Set TSM_CTRL[FORCE_RX_EN]=1 to initiate the RX sequence. (AA_SFD_MATCHED may still be asserted here from the previous packet reception)
4. Poll XCVR_STATUS register in XCVR space to determine when RX Warmup is complete. Set variable **tsm_count** to the LS byte of XCVR_STATUS
5. while (**tsm_count** < **end_of_rx_wu**) {**tsm_count** = (r32(XCVR_STATUS) & 0xFF);}
6. When the while() loop exits, the RX Warmup is complete. BSM_FRAME will assert soon
7. Begin monitoring the BSM pins for incoming BLE packet

45.4.5 Transceiver Sequence Manager

45.4.5.1 Introduction

The TSM is a fully-programmable, multi-protocol transceiver sequence manager, which supports Bluetooth Low Energy, 802.15.4, and other 2.4GHz transceivers.

45.4.5.1.1 Overview

The Transceiver Sequence Manager controls the warmup and warmdown processes for all radio sequences. The TSM provides for a TX sequence, and an RX sequence. For both TX and RX, a warmup and a warmdown sequence is supported. The length of each sequence is programmable, from 1 – 254us. The resolution of the TSM is 1us. Controls for all analog and digital transceiver blocks are provided. The TSM has 67 outputs with which to control the warmup and warmdown processes. Each TSM output enables, or otherwise provides control for, a transceiver-related block. Each TSM output (or group of

outputs) has 4 8-bit registers, with which to control the point at which the output asserts during the warmup (1 register for TX, 1 for RX), and the point at which it deasserts (1 register for TX, 1 for RX). Some TSM outputs, which are known in advance to require identical timing, are “ganged together”, to reduce area and required programming. For DFT, and non-mission-mode validation, each TSM output can be put under direct software control, using register overrides. Any sequence can be optionally aborted by software, or by a PLL unlock condition. And, any sequence can be temporarily halted, by setting an optional, programmable breakpoint.

45.4.5.1.2 Features

The TSM includes the following features:

- TX warmup and warmdown sequence and RX warmup and warmdown sequence sequence for every controllable output.
- Programmable sequence length from 1 to 254 microseconds for each sequence in 1 microsecond increments.
- 67 total outputs.
- Multi-protocol
- PA Target Power Selection
- PA Ramping
- Ability to place TSM outputs under software control for test and non-mission mode validation.
- Ability to abort sequences upon PLL unlock condition.
- Fast Warmup Capability for TX and RX
- LPPS Support
- Programmable breakpoint capability to halt any sequence temporarily.

45.4.5.1.3 Block diagram

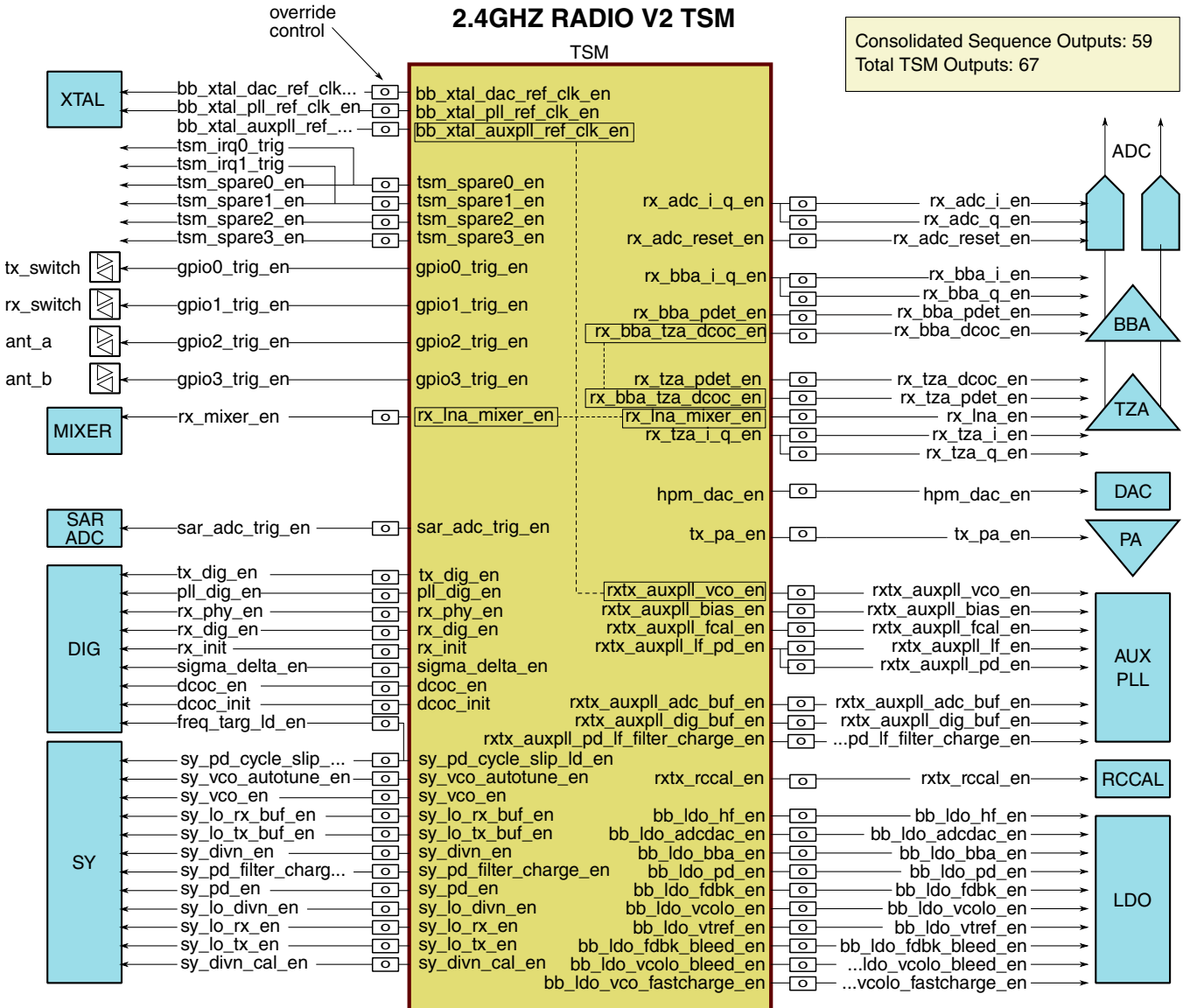

Figure 45-48. Block diagram

45.4.5.2 Functional description

45.4.5.2.1 Sequence Counter

The TSM supports 1 TX and 1 RX sequence. Each sequence consists of 3 phases:

1. WARMUP phase
2. ON phase
3. WARMDOWN phase

The central element of the TSM is an 8-bit counter. The counter is held at 0 during the idle state. From idle state, any sequence can be launched, by an initiating event. (See Section “Sequence Initiation”). At an initiating event, the TSM counter counts up from 0 to a programmed stop point during the WARMUP phase, determined by the `END_OF_TX_WU` or `END_OF_RX_WU` register, depending on whether the sequence is TX or RX. At the end-of-warmup “stop point”, the TSM counter holds its count, and the TSM sequence enters the ON phase. The TSM counter will remain in the ON phase, and hold its count, until the initiating event deasserts, or an abort occurs (See Section “Sequence Termination”). When either of these conditions occurs during the ON phase, the TSM will resume counting from the point it was holding during the ON phase, and the sequence will enter the WARMDOWN phase. The counter will continue counting until a programmed stop point is reached. This stop point is determined by the `END_OF_TX_WD` or `END_OF_RX_WD` register, depending on whether the sequence is TX or RX. Once this point is reached, the sequence returns to idle, and the TSM counter returns to 0.

The 4 8-bit registers which control the duration of the WARMUP phase (`END_OF_TX_WU[7:0]` and `END_OF_RX_WU[7:0]`), and the duration of the WARMDOWN phase (`END_OF_TX_WD[7:0]` and `END_OF_RX_WD[7:0]`), reside in the `END_OF_SEQ` register.

All TSM-controlled outputs are active-high. Any TSM-controlled output can be asserted once during a sequence (either TX or RX sequence), and then deasserted once. Or, the output can be held in a deasserted state for the duration of the sequence. The precise timing for the assertion and deassertion of each TSM-controlled output, for both TX and RX sequences, is determined by 4 8-bit registers assigned to that output (see Section [TSM-Controlled Outputs](#)). The TSM resolution is 1 μ s. This is the update rate for the TSM counter, and sets the granularity with which warmup and warmdown processes can be controlled.

45.4.5.2.2 TSM-Controlled Outputs

The TSM has 67 timing-controlled outputs, for enabling and control of the various transceiver blocks. The outputs are shown in the following diagram.

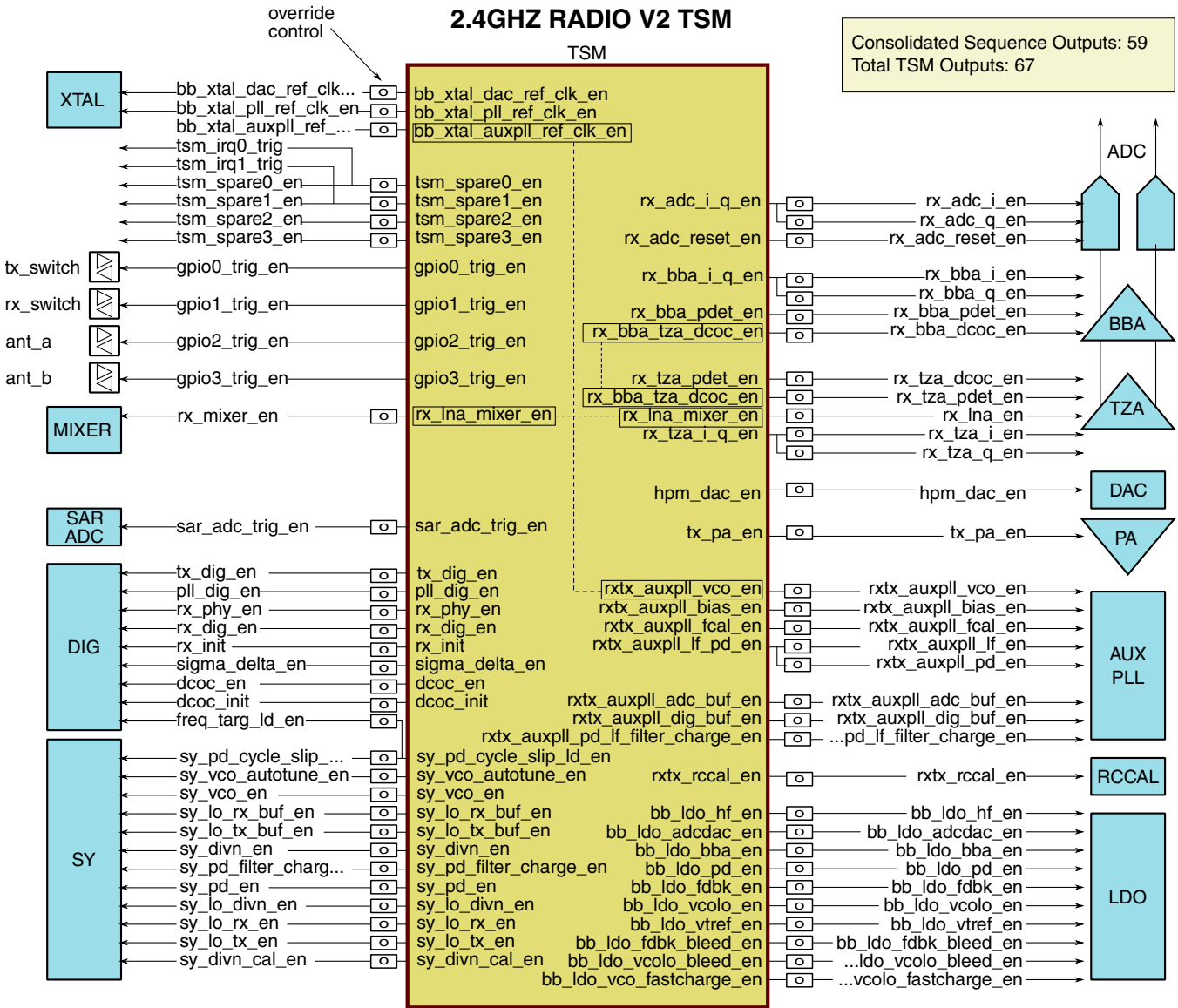

Figure 45-49. 2.4GHZ RADIO TSM

In some cases, some of the 67 outputs are grouped together, for outputs which need identical timing. For example, rx_bba_i_en and rx_bba_q_en. These groupings save area, because only 1 set of timing registers is needed to control timing for the entire group. Groupings also reduce the amount of required TSM programming. In all cases, even for grouped outputs, each output has an individual override control, to allow software to take command of any of the 67 TSM-controlled outputs at any time. As a consequence of the groupings, there are only 59 sets of timing registers, to control the 67 outputs. The table below, lists the 67 TSM-controlled outputs, and for the grouped outputs, indicates the signal which controls the timing for the entire group.

| Signal Index | 67 TSM-CONTROLLED OUTPUTS | SIGNAL CONTROLLING GROUP TIMING |
|--------------|----------------------------|---------------------------------|
| 0 | bb_ldo_hf_en | bb_ldo_hf_en |
| 1 | bb_ldo_adcdac_en | bb_ldo_adcdac_en |
| 2 | bb_ldo_bba_en | bb_ldo_bba_en |
| 3 | bb_ldo_pd_en | bb_ldo_pd_en |
| 4 | bb_ldo_fdbk_en | bb_ldo_fdbk_en |
| 5 | bb_ldo_vcolo_en | bb_ldo_vcolo_en |
| 6 | bb_ldo_vtref_en | bb_ldo_vtref_en |
| 7 | bb_ldo_fdbk_bleed_en | bb_ldo_fdbk_bleed_en |
| 8 | bb_ldo_vcolo_bleed_en | bb_ldo_vcolo_bleed_en |
| 9 | bb_ldo_vcolo_fastcharge_en | bb_ldo_vcolo_fastcharge_en |
| 10 | bb_xtal_pll_ref_clk_en | bb_xtal_pll_ref_clk_en |
| 11 | bb_xtal_dac_ref_clk_en | bb_xtal_dac_ref_clk_en |
| 12 | bb_xtal_auxpll_ref_clk_en | rxtx_auxpll_vco_ref_clk_en |
| 13 | sy_vco_autotune_en | sy_vco_autotune_en |
| 14 | sy_pd_cycle_slip_ld_en | sy_pd_cycle_slip_ld_ft_en |
| 15 | sy_vco_en | sy_vco_en |
| 16 | sy_lo_rx_buf_en | sy_lo_rx_buf_en |
| 17 | sy_lo_tx_buf_en | sy_lo_tx_buf_en |
| 18 | sy_divn_en | sy_divn_en |
| 19 | sy_pd_filter_charge_en | sy_pd_filter_charge_en |
| 20 | sy_pd_en | sy_pd_en |
| 21 | sy_lo_divn_en | sy_lo_divn_en |
| 22 | sy_lo_rx_en | sy_lo_rx_en |
| 23 | sy_lo_tx_en | sy_lo_tx_en |
| 24 | sy_divn_cal_en | sy_divn_cal_en |
| 25 | rx_mixer_en | rx_lna_mixer_en |
| 26 | tx_pa_en | tx_pa_en |
| 27 | rx_adc_i_en | rx_adc_i_q_en |
| 28 | rx_adc_q_en | rx_adc_i_q_en |
| 29 | rx_adc_reset_en | rx_adc_reset_en |
| 30 | rx_bba_i_en | rx_bba_i_q_en |
| 31 | rx_bba_q_en | rx_bba_i_q_en |
| 32 | rx_bba_pdet_en | rx_bba_pdet_en |
| 33 | rx_bba_dcoc_en | rx_bba_tza_dcoc_en |
| 34 | rx_lna_en | rx_lna_mixer_en |
| 35 | rx_tza_i_en | rx_tza_i_q_en |
| 36 | rx_tza_q_en | rx_tza_i_q_en |
| 37 | rx_tza_pdet_en | rx_tza_pdet_en |
| 38 | rx_tza_dcoc_en | rx_bba_tza_dcoc_en |
| 39 | pll_dig_en | pll_dig_en |

Table continues on the next page...

| Signal Index | 67 TSM-CONTROLLED OUTPUTS | SIGNAL CONTROLLING GROUP TIMING |
|--------------|------------------------------------|------------------------------------|
| 40 | tx_dig_en | tx_dig_en |
| 41 | rx_dig_en | rx_dig_en |
| 42 | rx_init | rx_init |
| 43 | sigma_delta_en | sigma_delta_en |
| 44 | rx_phy_en | rx_phy_en |
| 45 | dcoc_en | dcoc_en |
| 46 | dcoc_init | dcoc_init |
| 47 | freq_targ_ld_en | sy_pd_cycle_slip_ld_ft_en |
| 48 | sar_adc_trig_en | sar_adc_trig_en |
| 49 | tsm_spare0_en | tsm_spare0_en |
| 50 | tsm_spare1_en | tsm_spare1_en |
| 51 | tsm_spare2_en | tsm_spare2_en |
| 52 | tsm_spare3_en | tsm_spare3_en |
| 53 | gpio0_trig_en | gpio0_trig_en |
| 54 | gpio1_trig_en | gpio1_trig_en |
| 55 | gpio2_trig_en | gpio2_trig_en |
| 56 | gpio3_trig_en | gpio3_trig_en |
| 57 | rxtx_auxpll_bias_en | rxtx_auxpll_bias_en |
| 58 | rxtx_auxpll_vco_en | rxtx_auxpll_vco_ref_clk_en |
| 59 | rxtx_auxpll_fcal_en | rxtx_auxpll_fcal_en |
| 60 | rxtx_auxpll_lf_en | rxtx_auxpll_lf_pd_en |
| 61 | rxtx_auxpll_pd_en | rxtx_auxpll_lf_pd_en |
| 62 | rxtx_auxpll_pd_lf_filter_charge_en | rxtx_auxpll_pd_lf_filter_charge_en |
| 63 | rxtx_auxpll_adc_buf_en | rxtx_auxpll_adc_buf_en |
| 64 | rxtx_auxpll_dig_buf_en | rxtx_auxpll_dig_buf_en |
| 65 | rxtx_rccal_en | rxtx_rccal_en |
| 66 | tx_hpm_dac_en | tx_hpm_dac_en |

For example, TSM-controlled outputs rx_bba_i_en, and rx_bba_q_en, are both members of the same group. The timing registers to program the timing on these outputs (RX_BBA_I_Q_TX_HI, RX_BBA_I_Q_TX_LO, RX_BBA_I_Q_RX_HI, RX_BBA_I_Q_RX_LO), control the timing for both members of the group. Each member of the group, however, has an independent software override.

During the WARMUP and WARMDOWN phases of any sequence, any TSM-controlled output can be programmed to assert once and then deassert once, by programming the timing registers associated with the output. Each output has 4 8-bit timing registers associated with it. The name of the register matches the name of the output:

OUTPUTNAME_TX_HI[7:0]
OUTPUTNAME_TX_LO[7:0]

OUTPUTNAME_RX_HI[7:0]
OUTPUTNAME_RX_LO[7:0]

In the case of grouped outputs, the timing registers associated with the signal controlling the group, control timing for the entire group.

During the WARMUP phase of a TX sequence, as the 8-bit TSM counter increments, once the TSM counter equals or exceeds the programmed value of *OUTPUTNAME_TX_HI*[7:0], but is less than the programmed value of *OUTPUTNAME_TX_LO*[7:0], the corresponding TSM output will transition high. During the WARMUP or WARMDOWN phase of the TX sequence, once the TSM counter equals or exceeds the programmed value of *OUTPUTNAME_TX_LO*[7:0], the TSM output will transition low. If the programmed value of *OUTPUTNAME_TX_HI*[7:0], is greater than the length of the TX sequence (set by register *END_OF_TX_WD*[7:0]), then that signal will never transition high during the TX sequence. A convenient way of ensuring a signal does not assert during a TX sequence, is to set its *OUTPUTNAME_TX_HI*[7:0]=255.

During the WARMUP phase of a RX sequence, as the 8-bit TSM counter increments, once the TSM counter equals or exceeds the programmed value of *OUTPUTNAME_RX_HI*[7:0], but is less than the programmed value of *OUTPUTNAME_RX_LO*[7:0], the corresponding TSM output will transition high. During the WARMUP or WARMDOWN phase of the RX sequence, once the TSM counter equals or exceeds the programmed value of *OUTPUTNAME_RX_LO*[7:0], the TSM output will transition low. If the programmed value of *OUTPUTNAME_RX_HI*[7:0], is greater than the length of the RX sequence (set by register *END_OF_RX_WD*[7:0]), then that signal will never transition high during the RX sequence. A convenient way of assuring a signal does not assert during a RX sequence, is to set its *OUTPUTNAME_RX_HI*[7:0]=255.

The following diagram depicts the TSM counter, and the control logic used to assert and deassert the TSM-controlled outputs. For clarity, logic for only 2 of the 67 outputs is shown.

TSM BLOCK DIAGRAM

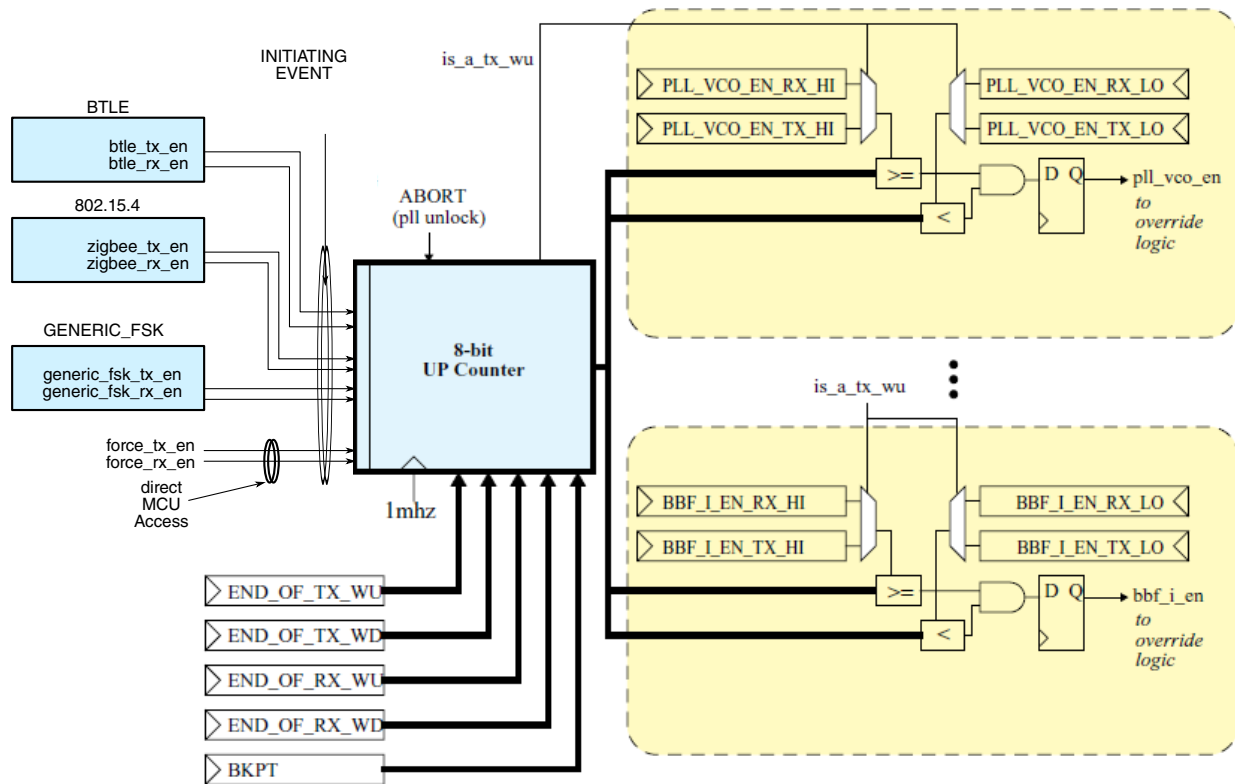

Figure 45-50. 2.4GHZ RADIO TSM BLOCK DIAGRAM

45.4.5.2.3 Timing Registers

There are 59 sets of timing registers for the TSM, one set for each TSM-controlled output (or, for the signal controlling the group for the “grouped” outputs). Each register set consists of 4 registers: one to control the assertion time of the output for TX sequences, one to control the assertion time for RX sequence, one to control the deassertion time for TX sequences, and one to control the deassertion time for RX sequences. For TSM-controlled outputs that are grouped, one set of timing registers controls the timing for all members of the group. For each of these 59 sets, the following table lists the register name (TSM_TIMING00 – TSM_TIMING58), and 4 timing register names associated with each.

| REGISTER NAME | BITS [31:24] | BITS [23:16] | BITS [15:8] | BITS [7:0] |
|---------------|-----------------------------|-----------------------------|-----------------------------|-----------------------------|
| TSM_TIMING00 | BB_LDO_HF_EN_RX_LO[7:0] | BB_LDO_HF_EN_RX_HI[7:0] | BB_LDO_HF_EN_TX_LO[7:0] | BB_LDO_HF_EN_TX_HI[7:0] |
| TSM_TIMING01 | BB_LDO_ADCDAC_EN_RX_LO[7:0] | BB_LDO_ADCDAC_EN_RX_HI[7:0] | BB_LDO_ADCDAC_EN_TX_LO[7:0] | BB_LDO_ADCDAC_EN_TX_HI[7:0] |

Table continues on the next page...

| REGISTER NAME | BITS [31:24] | BITS [23:16] | BITS [15:8] | BITS [7:0] |
|---------------|---------------------------------------|---------------------------------------|---------------------------------------|---------------------------------------|
| TSM_TIMING02 | BB_LDO_BBA_EN_RX_LO[7:0] | BB_LDO_BBA_EN_RX_HI[7:0] | n/a | n/a |
| TSM_TIMING03 | BB_LDO_PD_EN_RX_LO[7:0] | BB_LDO_PD_EN_RX_HI[7:0] | BB_LDO_PD_EN_TX_LO[7:0] | BB_LDO_PD_EN_TX_HI[7:0] |
| TSM_TIMING04 | BB_LDO_FDBK_EN_RX_LO[7:0] | BB_LDO_FDBK_EN_RX_HI[7:0] | BB_LDO_FDBK_EN_TX_LO[7:0] | BB_LDO_FDBK_EN_TX_HI[7:0] |
| TSM_TIMING05 | BB_LDO_VCOLO_EN_RX_LO[7:0] | BB_LDO_VCOLO_EN_RX_HI[7:0] | BB_LDO_VCOLO_EN_TX_LO[7:0] | BB_LDO_VCOLO_EN_TX_HI[7:0] |
| TSM_TIMING06 | BB_LDO_VTREF_EN_RX_LO[7:0] | BB_LDO_VTREF_EN_RX_HI[7:0] | BB_LDO_VTREF_EN_TX_LO[7:0] | BB_LDO_VTREF_EN_TX_HI[7:0] |
| TSM_TIMING07 | BB_LDO_FDBK_BLEED_EN_RX_LO[7:0] | BB_LDO_FDBK_BLEED_EN_RX_HI[7:0] | BB_LDO_FDBK_BLEED_EN_TX_LO[7:0] | BB_LDO_FDBK_BLEED_EN_TX_HI[7:0] |
| TSM_TIMING08 | BB_LDO_VCOLO_BLEED_EN_RX_LO[7:0] | BB_LDO_VCOLO_BLEED_EN_RX_HI[7:0] | BB_LDO_VCOLO_BLEED_EN_TX_LO[7:0] | BB_LDO_VCOLO_BLEED_EN_TX_HI[7:0] |
| TSM_TIMING09 | BB_LDO_VCOLO_FASTCHARGE_EN_RX_LO[7:0] | BB_LDO_VCOLO_FASTCHARGE_EN_RX_HI[7:0] | BB_LDO_VCOLO_FASTCHARGE_EN_TX_LO[7:0] | BB_LDO_VCOLO_FASTCHARGE_EN_TX_HI[7:0] |
| TSM_TIMING10 | BB_XTAL_PLL_REF_CLK_EN_RX_LO[7:0] | BB_XTAL_PLL_REF_CLK_EN_RX_HI[7:0] | BB_XTAL_PLL_REF_CLK_EN_TX_LO[7:0] | BB_XTAL_PLL_REF_CLK_EN_TX_HI[7:0] |
| TSM_TIMING11 | n/a | n/a | BB_XTAL_DAC_REF_CLK_EN_TX_LO[7:0] | BB_XTAL_DAC_REF_CLK_EN_TX_HI[7:0] |
| TSM_TIMING12 | RXTX_AUXPLL_VCO_REF_CLK_EN_RX_LO[7:0] | RXTX_AUXPLL_VCO_REF_CLK_EN_RX_HI[7:0] | n/a | n/a |
| TSM_TIMING13 | SY_VCO_AUTOTUNE_EN_RX_LO[7:0] | SY_VCO_AUTOTUNE_EN_RX_HI[7:0] | SY_VCO_AUTOTUNE_EN_TX_LO[7:0] | SY_VCO_AUTOTUNE_EN_TX_HI[7:0] |
| TSM_TIMING14 | SY_PD_CYCLE_SLIP_LD_FT_EN_RX_LO[7:0] | SY_PD_CYCLE_SLIP_LD_FT_EN_RX_HI[7:0] | SY_PD_CYCLE_SLIP_LD_FT_EN_TX_LO[7:0] | SY_PD_CYCLE_SLIP_LD_FT_EN_TX_HI[7:0] |
| TSM_TIMING15 | SY_VCO_EN_RX_LO[7:0] | SY_VCO_EN_RX_HI[7:0] | SY_VCO_EN_TX_LO[7:0] | SY_VCO_EN_TX_HI[7:0] |
| TSM_TIMING16 | SY_LO_RX_BUF_EN_RX_LO[7:0] | SY_LO_RX_BUF_EN_RX_HI[7:0] | n/a | n/a |
| TSM_TIMING17 | n/a | n/a | SY_LO_TX_BUF_EN_TX_LO[7:0] | SY_LO_TX_BUF_EN_TX_HI[7:0] |
| TSM_TIMING18 | SY_DIVN_EN_RX_LO[7:0] | SY_DIVN_EN_RX_HI[7:0] | SY_DIVN_EN_TX_LO[7:0] | SY_DIVN_EN_TX_HI[7:0] |
| TSM_TIMING19 | SY_PD_FILTER_CHARGE_EN_RX_LO[7:0] | SY_PD_FILTER_CHARGE_EN_RX_HI[7:0] | SY_PD_FILTER_CHARGE_EN_TX_LO[7:0] | SY_PD_FILTER_CHARGE_EN_TX_HI[7:0] |
| TSM_TIMING20 | SY_PD_EN_RX_LO[7:0] | SY_PD_EN_RX_HI[7:0] | SY_PD_EN_TX_LO[7:0] | SY_PD_EN_TX_HI[7:0] |
| TSM_TIMING21 | SY_LO_DIVN_EN_RX_LO[7:0] | SY_LO_DIVN_EN_RX_HI[7:0] | SY_LO_DIVN_EN_TX_LO[7:0] | SY_LO_DIVN_EN_TX_HI[7:0] |
| TSM_TIMING22 | SY_LO_RX_EN_RX_LO[7:0] | SY_LO_RX_EN_RX_HI[7:0] | n/a | n/a |
| TSM_TIMING23 | n/a | n/a | SY_LO_TX_EN_TX_LO[7:0] | SY_LO_TX_EN_TX_HI[7:0] |

Table continues on the next page...

FSK Modulator

| REGISTER NAME | BITS [31:24] | BITS [23:16] | BITS [15:8] | BITS [7:0] |
|---------------|-------------------------------|-------------------------------|----------------------------|----------------------------|
| TSM_TIMING24 | SY_DIVN_CAL_EN_RX_LO[7:0] | SY_DIVN_CAL_EN_RX_HI[7:0] | SY_DIVN_CAL_EN_TX_LO[7:0] | SY_DIVN_CAL_EN_TX_HI[7:0] |
| TSM_TIMING25 | RX_LNA_MIXER_EN_RX_LO[7:0] | RX_LNA_MIXER_EN_RX_HI[7:0] | n/a | n/a |
| TSM_TIMING26 | n/a | n/a | TX_PA_EN_TX_LO[7:0] | TX_PA_EN_TX_HI[7:0] |
| TSM_TIMING27 | RX_ADC_I_Q_EN_RX_LO[7:0] | RX_ADC_I_Q_EN_RX_HI[7:0] | n/a | n/a |
| TSM_TIMING28 | RX_ADC_RESET_EN_RX_LO[7:0] | RX_ADC_RESET_EN_RX_HI[7:0] | n/a | n/a |
| TSM_TIMING29 | RX_BBA_I_Q_EN_RX_LO[7:0] | RX_BBA_I_Q_EN_RX_HI[7:0] | n/a | n/a |
| TSM_TIMING30 | RX_BBA_PDET_EN_RX_LO[7:0] | RX_BBA_PDET_EN_RX_HI[7:0] | n/a | n/a |
| TSM_TIMING31 | RX_BBA_TZA_DCOC_EN_RX_LO[7:0] | RX_BBA_TZA_DCOC_EN_RX_HI[7:0] | n/a | n/a |
| TSM_TIMING32 | RX_TZA_I_Q_EN_RX_LO[7:0] | RX_TZA_I_Q_EN_RX_HI[7:0] | n/a | n/a |
| TSM_TIMING33 | RX_TZA_PDET_EN_RX_LO[7:0] | RX_TZA_PDET_EN_RX_HI[7:0] | n/a | n/a |
| TSM_TIMING34 | PLL_DIG_EN_RX_LO[7:0] | PLL_DIG_EN_RX_HI[7:0] | PLL_DIG_EN_TX_LO[7:0] | PLL_DIG_EN_TX_HI[7:0] |
| TSM_TIMING35 | n/a | n/a | TX_DIG_EN_TX_LO[7:0] | TX_DIG_EN_TX_HI[7:0] |
| TSM_TIMING36 | RX_DIG_EN_RX_LO[7:0] | RX_DIG_EN_RX_HI[7:0] | n/a | n/a |
| TSM_TIMING37 | RX_INIT_RX_LO[7:0] | RX_INIT_RX_HI[7:0] | n/a | n/a |
| TSM_TIMING38 | SIGMA_DELTA_EN_RX_LO[7:0] | SIGMA_DELTA_EN_RX_HI[7:0] | SIGMA_DELTA_EN_TX_LO[7:0] | SIGMA_DELTA_EN_TX_HI[7:0] |
| TSM_TIMING39 | RX_PHY_EN_RX_LO[7:0] | RX_PHY_EN_RX_HI[7:0] | n/a | n/a |
| TSM_TIMING40 | DCOC_EN_RX_LO[7:0] | DCOC_EN_RX_HI[7:0] | n/a | n/a |
| TSM_TIMING41 | DCOC_INIT_RX_LO[7:0] | DCOC_INIT_RX_HI[7:0] | n/a | n/a |
| TSM_TIMING42 | SAR_ADC_TRIG_EN_RX_LO[7:0] | SAR_ADC_TRIG_EN_RX_HI[7:0] | SAR_ADC_TRIG_EN_TX_LO[7:0] | SAR_ADC_TRIG_EN_TX_HI[7:0] |
| TSM_TIMING43 | TSM_SPARE0_EN_RX_LO[7:0] | TSM_SPARE0_EN_RX_HI[7:0] | TSM_SPARE0_EN_TX_LO[7:0] | TSM_SPARE0_EN_TX_HI[7:0] |
| TSM_TIMING44 | TSM_SPARE1_EN_RX_LO[7:0] | TSM_SPARE1_EN_RX_HI[7:0] | TSM_SPARE1_EN_TX_LO[7:0] | TSM_SPARE1_EN_TX_HI[7:0] |
| TSM_TIMING45 | TSM_SPARE2_EN_RX_LO[7:0] | TSM_SPARE2_EN_RX_HI[7:0] | TSM_SPARE2_EN_TX_LO[7:0] | TSM_SPARE2_EN_TX_HI[7:0] |
| TSM_TIMING46 | TSM_SPARE3_EN_RX_LO[7:0] | TSM_SPARE3_EN_RX_HI[7:0] | TSM_SPARE3_EN_TX_LO[7:0] | TSM_SPARE3_EN_TX_HI[7:0] |
| TSM_TIMING47 | GPIO0_TRIG_EN_RX_LO[7:0] | GPIO0_TRIG_EN_RX_HI[7:0] | GPIO0_TRIG_EN_TX_LO[7:0] | GPIO0_TRIG_EN_TX_HI[7:0] |

Table continues on the next page...

| REGISTER NAME | BITS [31:24] | BITS [23:16] | BITS [15:8] | BITS [7:0] |
|---------------|---|---|--------------------------|--------------------------|
| TSM_TIMING48 | GPIO1_TRIG_EN_RX_LO[7:0] | GPIO1_TRIG_EN_RX_HI[7:0] | GPIO1_TRIG_EN_TX_LO[7:0] | GPIO1_TRIG_EN_TX_HI[7:0] |
| TSM_TIMING49 | GPIO2_TRIG_EN_RX_LO[7:0] | GPIO2_TRIG_EN_RX_HI[7:0] | GPIO2_TRIG_EN_TX_LO[7:0] | GPIO2_TRIG_EN_TX_HI[7:0] |
| TSM_TIMING50 | GPIO3_TRIG_EN_RX_LO[7:0] | GPIO3_TRIG_EN_RX_HI[7:0] | GPIO3_TRIG_EN_TX_LO[7:0] | GPIO3_TRIG_EN_TX_HI[7:0] |
| TSM_TIMING51 | RXTX_AUXPLL_BIAS_EN_RX_LO[7:0] | RXTX_AUXPLL_BIAS_EN_RX_HI[7:0] | n/a | n/a |
| TSM_TIMING52 | RXTX_AUXPLL_FCAL_EN_RX_LO[7:0] | RXTX_AUXPLL_FCAL_EN_RX_HI[7:0] | n/a | n/a |
| TSM_TIMING53 | RXTX_AUXPLL_LF_PD_EN_RX_LO[7:0] | RXTX_AUXPLL_LF_PD_EN_RX_HI[7:0] | n/a | n/a |
| TSM_TIMING54 | RXTX_AUXPLL_PD_LF_FILTER_CHARGE_EN_RX_LO[7:0] | RXTX_AUXPLL_PD_LF_FILTER_CHARGE_EN_RX_HI[7:0] | n/a | n/a |
| TSM_TIMING55 | RXTX_AUXPLL_ADC_BUF_EN_RX_LO[7:0] | RXTX_AUXPLL_ADC_BUF_EN_RX_HI[7:0] | n/a | n/a |
| TSM_TIMING56 | RXTX_AUXPLL_DIG_BUF_EN_RX_LO[7:0] | RXTX_AUXPLL_DIG_BUF_EN_RX_HI[7:0] | n/a | n/a |
| TSM_TIMING57 | RXTX_RCCAL_EN_RX_LO[7:0] | RXTX_RCCAL_EN_RX_HI[7:0] | n/a | n/a |
| TSM_TIMING58 | n/a | n/a | TX_HPM_DAC_EN_TX_LO[7:0] | TX_HPM_DAC_EN_TX_HI[7:0] |

Some of the TSM outputs have relevance for TX sequences only. For those, timing registers are only provided for TX assertion and deassertion times. For such outputs, the RX timing registers are shown as “n/a” in the table above. The RX timings for such outputs are essentially hardwired to 255, meaning there will be no signal assertion during RX sequences.

Some of the TSM outputs have relevance for RX sequences only. For those, timing registers are only provided for RX assertion and deassertion times. For such outputs, the TX timing registers are shown as “n/a” in the table above. The TX timings for such outputs are essentially hardwired to 255, meaning there will be no signal assertion during TX sequences.

45.4.5.2.4 Sequence Initiation

The SoC will include one or more protocol engines. Any of the protocol engines, can launch a TSM sequence. Each protocol engine will have an initiating signal for a TX sequence, and another for an RX sequence. In lieu of a protocol engine, the SoC host can launch a TSM sequence directly. The following table lists the initiating sources supported by the TSM, and the name of the sequence launching signal (TSM input):

| Initiating Source | Initiating Signal Names |
|-------------------|------------------------------|
| BTLE | btle_tx_en, btle_rx_en |
| 802.15.4 | zigbee_tx_en, zigbee_rx_en |
| Generic FSK | generic_tx_en, generic_rx_en |
| MCU/Host | force_tx_en, force_rx_en |

For direct software control, the MCU/Host can initiate a TX sequence warmup directly, by setting the `FORCE_TX_EN` bit, and later initiate a TX sequence warmdown by clearing the bit. The MCU/Host can initiate a RX sequence warmup directly, by setting the `FORCE_RX_EN` bit, and later initiate a RX sequence warmdown by clearing the bit. These bits reside in the `TSM_CTRL` register.

From idle state, the asserting of any initiating event (`source_tx_en` or `source_rx_en`), will begin the TSM WARMUP phase and begin incrementing the TSM counter from 0. The initiating source needs to hold the initiating signal asserted (high) through the course of the WARMUP, and then for the duration of the desired ON phase. Deasserting the initiating signal transitions the TSM to the WARMDOWN phase (see Section “Sequence Termination”).

Needless to say, from idle state, a TX-initiating event (assertion of any TSM `source_tx_en` input) will launch a TX sequence. The TSM output `tx_mode` will go high to indicate a TX sequence is underway. Also, from idle state, an RX-initiating event (assertion of any TSM `source_rx_en` input) will launch an RX sequence. The TSM output `rx_mode` will go high to indicate a RX sequence is underway.

Only 1 initiating source can be allowed to assert at any given time. Under no circumstances should a TX and RX initiating source be asserted simultaneously.

Once a TSM sequence has been launched, the WARMUP phase is entered and TSM counter incrementing will commence. Up-counting will continue until one of the following conditions is met:

1. Deassertion of the initiating event. TSM will transition to WARMDOWN phase
2. Abort. TSM will transition to WARMDOWN phase
3. `tsm_count=END_OF_SEQ_WU`, where `SEQ=TX` or `RX`. TSM will transition to ON phase
4. Breakpoint. TSM stay in its current phase and hold its count

A transition from WARMUP to ON phase means TSM will hold its count at `END_OF_SEQ_WU`, where `SEQ=TX` or `RX`.

A transition from ON to WARMDOWN phase means TSM will cease its hold, and resume counting at `END_OF_SEQ_WU+1`, where `SEQ = TX` or `RX`. (see Section “Sequence Termination”).

A transition from WARMUP to WARMDOWN phase means the `tsm_count` will jump to `END_OF_SEQ_WU+1` (where `SEQ = TX` or `RX`), and resume counting from there. (see Section “Sequence Termination”).

The 4 8-bit registers which control the duration of the WARMUP phase (`END_OF_TX_WU[7:0]` and `END_OF_RX_WU[7:0]`), and the duration of the WARMDOWN phase (`END_OF_TX_WD[7:0]` and `END_OF_RX_WD[7:0]`), reside in the `END_OF_SEQ` register.

45.4.5.2.5 Sequence Termination

A sequence may be terminated during the WARMUP or ON phase. A sequence will be terminated when one of the following conditions is met:

1. Deassertion of the initiating event. TSM will transition to WARMDOWN phase
2. Abort. TSM will transition to WARMDOWN phase

Deassertion of the initiating event (`source_tx_en` or `source_rx_en`), will cause a transition to WARMDOWN phase, at which point the TSM counter will resume counting from `END_OF_SEQ_WU+1` (where `SEQ=TX` or `RX`).

An abort is caused by a PLL unlock event. An unlock abort will cause a transition to WARMDOWN phase, at which point the TSM counter will resume counting from `END_OF_SEQ_WU+1` (where `SEQ = TX` or `RX`). See Section “TSM Aborting”.

During the WARMDOWN phase, whether caused by a deassertion of the initiating event, or a PLL unlock, subsequent aborts (PLL unlock events) will not be recognized by the TSM.

45.4.5.2.6 Overrides

Each of the 67 TSM-controlled outputs has independent override control, except for the 4 GPIO triggers, and the `SAR_ADC_TRIG` output. In addition, two special TSM outputs, `tx_mode` and `rx_mode`, also have their own override controls, for a total of $67 - 5 + 2 = 64$ overrides.

Two register bits are assigned to each output, to implement the override function. The bits are named:

`OUTPUTNAME_OVRD_EN`
`OUTPUTNAME_OVRD`

Setting the `OUTPUTNAME_OVRD_EN=1`, allows the `OUTPUTNAME_OVRD` bit to directly control the state of the output. Clearing `OUTPUTNAME_OVRD_EN=0` returns control of the output to the TSM.

The 64 override bit-pairs, reside in the TSM_OVRD0, TSM_OVRD1, TSM_OVRD2, and TSM_OVRD3 registers.

Overrides have no effect on TSM operation, TSM counting, sequence initiation, or sequence termination. Overrides may be engaged at any time, during any TSM phase, including during idle state.

45.4.5.2.7 Breakpoint

Breakpoint can be used to temporarily suspend a TSM sequence. A breakpoint can be set during the WARMUP or WARMDOWN phase of any TSM sequence. An 8-bit BKPT[7:0] register field resides in the TSM_CTRL register. During a TSM sequence, when the TSM counter matches the BKPT register value, counting stops and the counter holds in its current state. Aborts (PLL unlocks) will be ignored while holding at a breakpoint. Deassertion of the initiating event will also be ignored during the breakpoint. The breakpoint can be lifted by modifying the BKPT[7:0] register. Once the breakpoint is lifted, the TSM proceeds in the phase it was in prior to the breakpoint match, and the TSM counter begins incrementing again from the point at which the breakpoint occurred. Aborts (PLL unlocks) and deassertion of the initiating event, will then be recognized and handled as per the description in the “Sequence Termination” section. The default value for BKPT[7:0] is 255, which is greater than the length of any allowed sequence, so a breakpoint will not trigger during a sequence, unless a lower value is programmed.

45.4.5.2.8 TSM Aborting

The TSM can be enabled to abort any sequence on a PLL unlock condition. There are 3 mechanisms available for detecting PLL unlock. These are:

1. Coarse Tune Unlock
2. Frequency Target Unlock
3. Cycle Slip Unlock

Any of these mechanisms, or any combination of them, can be enabled to cause a TSM abort. Each of these mechanisms has a “_FAIL_FLAG” flag in the PLL_LOCK_DETECT register. On an unlock detection by any of these mechanisms, the corresponding “_FAIL_FLAG” flag (sticky bit) will become set, regardless of whether the mechanism is enabled to abort the TSM sequence. The “_FAIL_FLAG” flags are type “write-1-to-clear”.

An overview of the 3 PLL unlock mechanism is shown below

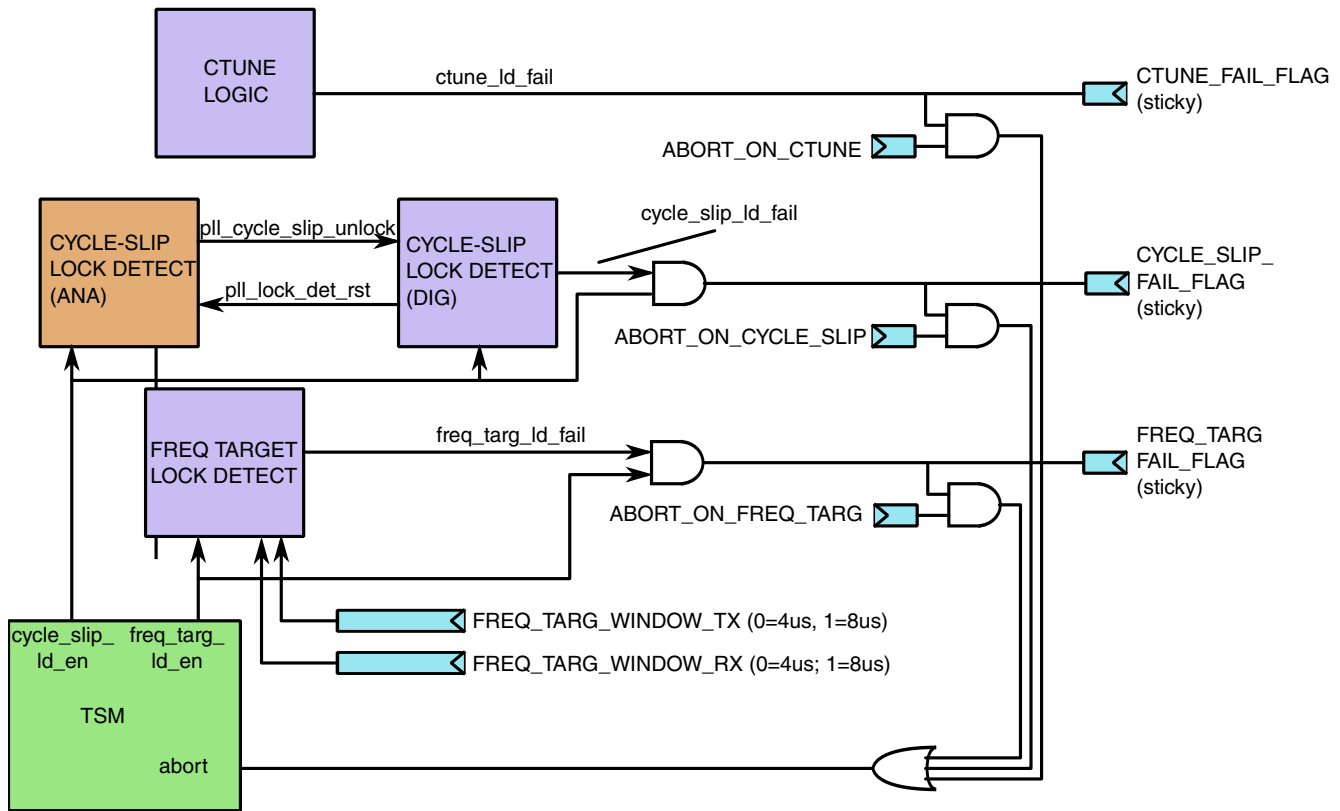

Figure 45-51. PLL UNLOCK MONITORING AND ABORT LOGIC

Each of the 3 PLL unlock mechanisms has an “ABORT_ON_” bit, to enable or disable that mechanism from aborting any TSM sequence. Any combination of “ABORT_ON_” bits can be configured.

In addition, the TSM directly controls the timing for 2 of the 3 unlock detect mechanisms: the Cycle Slip Lock Detect and the Frequency Target Lock Detect. (The timing for Coarse Tune Lock Detect mechanism is indirectly controlled by TSM via the pll_dig_en output; the PLL digital state machine is triggered by this signal and directly controls Coarse Tune). Enabling a lock detection mechanism via TSM programming allows an unlock condition to set the respective “_FAIL_FLAG” flag bit; To allow an unlock condition to cause an abort requires the respective “ABORT_ON_” bit to be set.

For each PLL unlock detect mechanism, the table below summarizes the TSM controlling signal for the mechanism, the timing register associated with that signal, and the default timing for the assertion of the controlling signal for both TX and RX sequences.

| Lock Detect Mechanism | TSM Controlling Signal | Associated TSM Timing Register | Controlling Signal Assertion Time(TX) | Controlling Signal Assertion Time(RX) |
|-----------------------|------------------------|--------------------------------|---------------------------------------|---------------------------------------|
| Coarse Tune | pll_dig_en (indirect) | TSM_TIMING34 | 7us | 7us |
| Freq. Target | freq_targ_id_en | TSM_TIMING14 | 97us | 49us |
| Cycle Slip | pll_cycle_slip_id_en | TSM_TIMING14 | 97us | 49us |

For each PLL unlock detect mechanism, the table below indicates the TSM controlling signal, the name of the “_FAIL_FLAG” flag bit, and the name of the “ABORT_ON_” enable bit to allow TSM aborting:

| Lock Detect Mechanism | TSM Controlling Signal | Lock Detect Fail Flag (PLL_LOCK_DETECT register) | Abort Enable Bit (TSM_CTRL register) |
|-----------------------|------------------------|--|--------------------------------------|
| Coarse Tune | pll_dig_en (indirect) | CTUNE_FAIL_FLAG | ABORT_ON_CTUNE |
| Freq. Target | freq_targ_ld_en | FREQ_TARG_FAIL_FLAG | ABORT_ON_FREQ_TARG |
| Cycle Slip | pll_cycle_slip_ld_en | CYCLE_SLIP_FAIL_FLAG | ABORT_ON_CYCLE_SLIP |

All “_FAIL_FLAG” flag bits all reside in the PLL_LOCK_DETECT register; All “ABORT_ON_” bits reside in the TSM_CTRL register.

In addition to the controls listed above associated with each unlock source, there are 2 controls to allow TSM aborting to be disabled based on sequence type (TX or RX), instead of unlock source. When TX_ABORT_DIS is set to 1, TX sequences cannot be aborted, regardless of the state of the “ABORT_ON_” bits or any unlock condition. Likewise, when RX_ABORT_DIS is set to 1, RX sequences cannot be aborted, regardless of the state of the “ABORT_ON_” bits or any unlock condition. The TX_ABORT_DIS and RX_ABORT_DIS bits reside in the TSM_CTRL register. The TX_ABORT_DIS and RX_ABORT_DIS bits have no effect on the setting of the “_FAIL_FLAG” bits on any unlock condition; the TX_ABORT_DIS and RX_ABORT_DIS only affect aborting.

45.4.5.2.9 Special Handling for 802.15.4 Autosequences

Any of the 3 unlock detect mechanisms can be used to abort a 802.15.4 autosequence. However the method for aborting a 802.15.4 autosequence is different than a non-802.15.4 abort. For 802.15.4, the unlock condition does not abort the sequence directly. There is a higher-level 802.15.4 Sequence Manager, which handles unlock aborts. For 802.15.4, the unlock condition is blocked from aborting the TSM as shown in the following diagram

802.15.4 PLL UNLOCK HANDLING

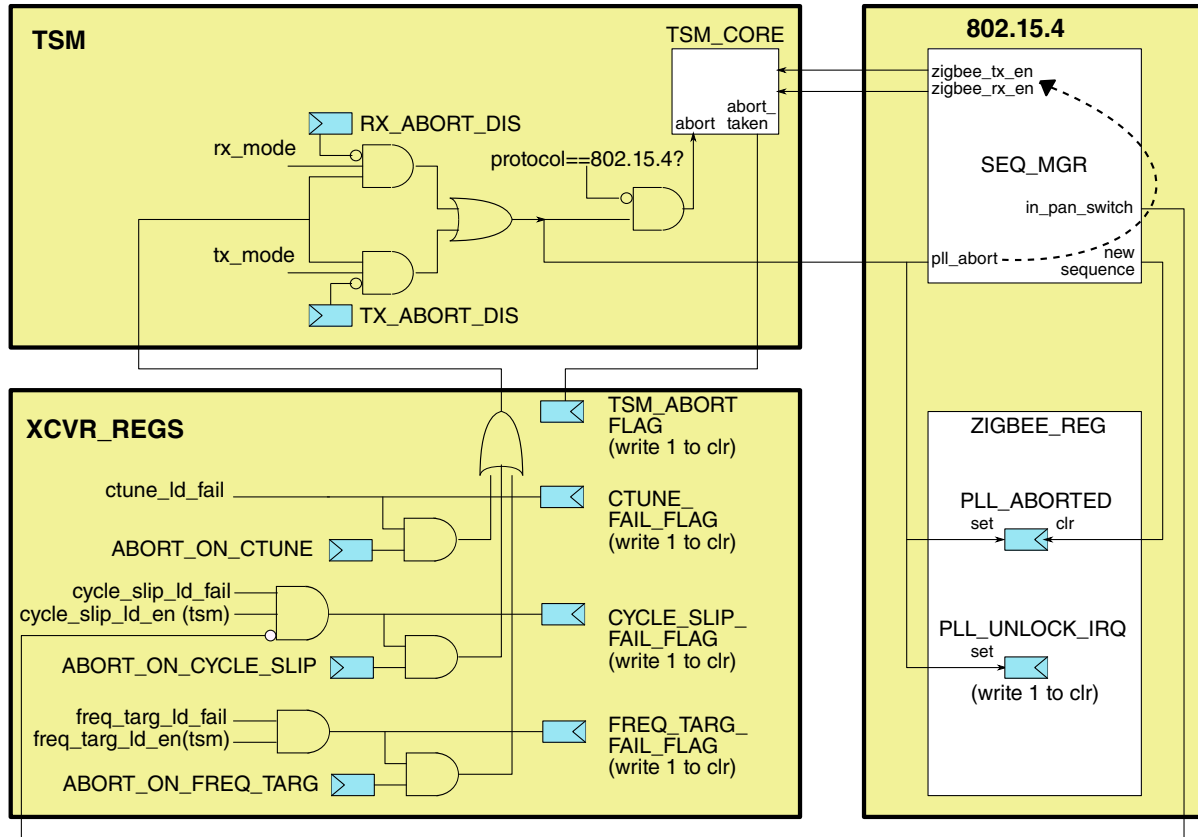

Figure 45-52. 802.15.4 PLL UNLOCK HANDLING

The combined-abort signal is blocked from reaching the TSM, and instead is routed to the 802.15.4 Sequence Manager (ZSM). This is due to the fact that the ZSM already includes abort-handling logic, which is being re-used from previous Freescale 802.15.4 products. Keeping the unlock handling intact, facilitates the porting of software from one Freescale 802.15.4 product to the next.

For 802.15.4, the logic which determines which ZSM states allow aborting, is designed into the ZSM state machine. Not all states require an abort-on-unlock. When an unlock event occurs during a ZSM state that requires an abort, the ZSM will deassert its initiating signal to TSM (`zigbee_tx_en` or `zigbee_rx_en`), which results in a de facto abort, similar to a TSM-generated abort. For a ZSM abort, the `PLL_UNLOCK_IRQ` bit will become set, as will the `PLL_ABORTED` bit. The `PLL_UNLOCK_IRQ` bit is of type write-1-to-clear, and resides in the `IRQSTS1` register of 802.15.4 space. The `PLL_ABORTED` bit is a read-only bit, and resides in the `ABORT_STS` register of 802.15.4 space; it will self-clear at the start of the next autosequence.

For 802.15.4, the `TX_ABORT_DIS` and `RX_ABORT_DIS` control bits are still available, and allow/disallow aborting during the TX portions of any autosequence (`TX_ABORT_DIS`), or the RX portions of any autosequences (`RX_ABORT_DIS`). The

802.15.4 autosequences are concatenations of TX and RX operations, under the control of the 802.15.4 Sequence Manager. The ZSM engages the TSM when needed, to perform a TX or RX warmup or warmdown, by asserting or deasserting `zigbee_tx_en` or `zigbee_rx_en`.

See the ZSM Block Guide, section [ZSM/TSM Interaction](#).

As mentioned previously, for 802.15.4 the `PLL_UNLOCK_IRQ` will become set to indicate a PLL unlock event has caused an 802.15.4 autosequence to be aborted. When 802.15.4 is not in use, another bit is provided to indicate a non-802.15.4 unlock abort (a TSM abort) has occurred. This bit is `TSM_ABORT_FLAG`. This bit is of type write-1-to-clear, and resides in the `PLL_LOCK_DETECT` register of transceiver space. This bit will not be set for an 802.15.4 abort (use `PLL_UNLOCK_FLAG` or `PLL_ABORTED` instead).

45.4.5.2.10 Special Handling for Generic_FSK Sequences

The Generic_FSK Link Layer Controllers already have built-in handling for PLL unlock conditions, and interrupt status bits to notify on such an event. Similar to 802.15.4, the combined-abort signal is blocked from reaching the TSM, and instead is routed to the Generic_FSK Command Decoder. The Command Decoder state machine handles the unlock event by deasserting the TX or RX command signal to the TSM (e.g., `generic_fsk_tx_en`), causing a TSM warmdown to occur. The Generic controller will also set the `PLL_UNLOCK_IRQ` interrupt status bit in its address space. The diagram below shows the Generic_FSK Link Layer handling of the PLL unlock event.

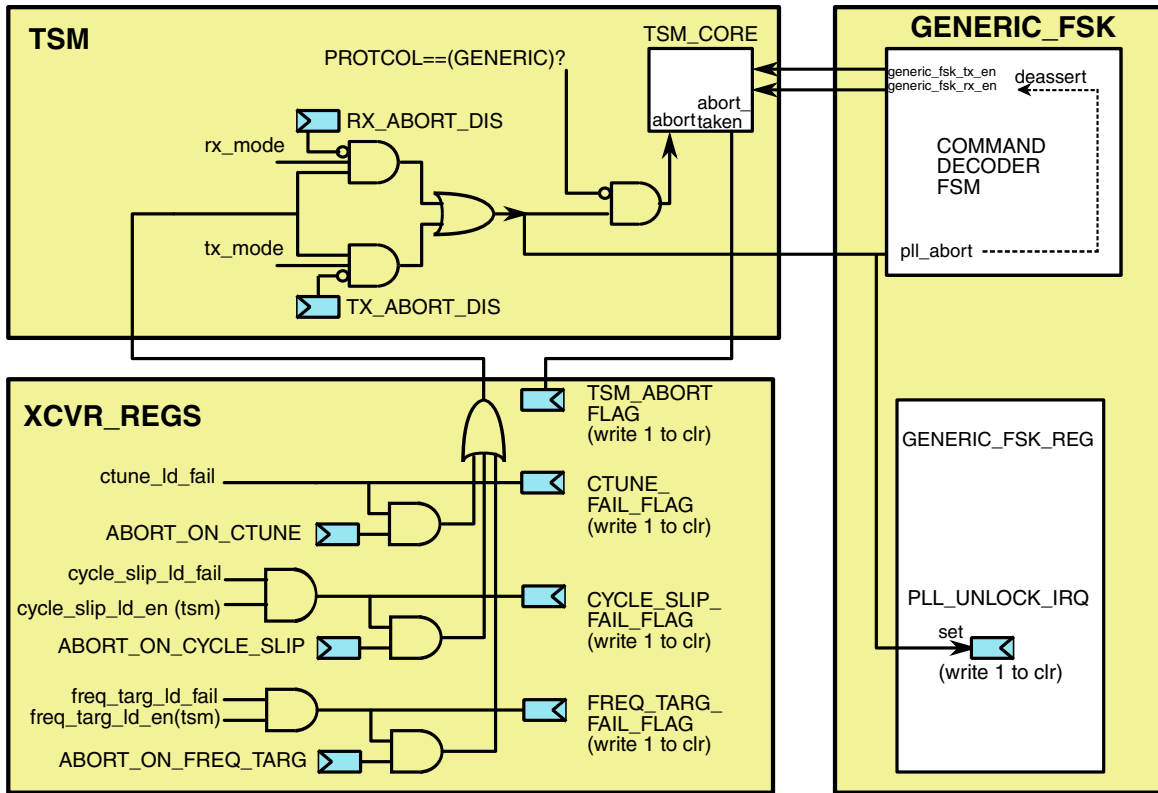

Figure 45-53. GENERIC_FSK PLL UNLOCK HANDLING

For Generic_FSK, the TX_ABORT_DIS and RX_ABORT_DIS control bits are still available, and selectively allow/disallow aborting during the TX sequences (TX_ABORT_DIS), or the RX sequences (RX_ABORT_DIS).

45.4.5.2.11 PA Target Power

The TSM controls the power level that is sent to the PA. Target power level is the power level that is used during packet transmission. Nominally, power level is constant over the course of the packet.

During a packet transmission sequence, prior to the start of preamble, while the PA is being turned on, power level must be ramped up gradually, to prevent unwanted spectral effects. After the packet is complete, and the PA is being turned off, power level must be ramped down slowly for the same reason.

The TSM controls power level to the PA during these 3 phases, as shown below:

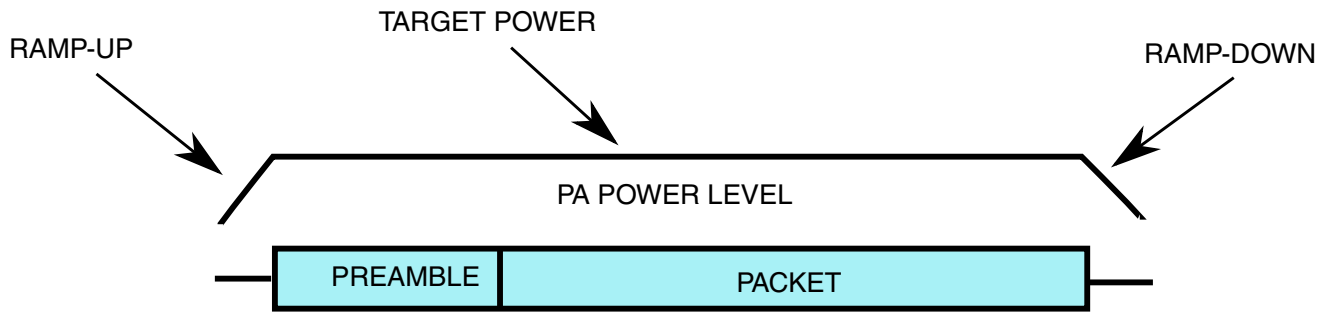

Figure 45-54. PA Target Power

Target power, the steady-state power level that is used to transmit the packet, can be selected from one of 5 sources:

1. PA_POWER[5:0] register in XCVR address space
2. BTLE Link Layer (2 different power levels possible, for Advertising and Connection Packets)
3. 802.15.4 Link Layer (PA_PWR[5:0] register in 802.15.4 address space)
4. Generic_FSK Link Layer (TX_POWER[5:0] register in GENERIC address space)

The following diagram depicts target power selection.

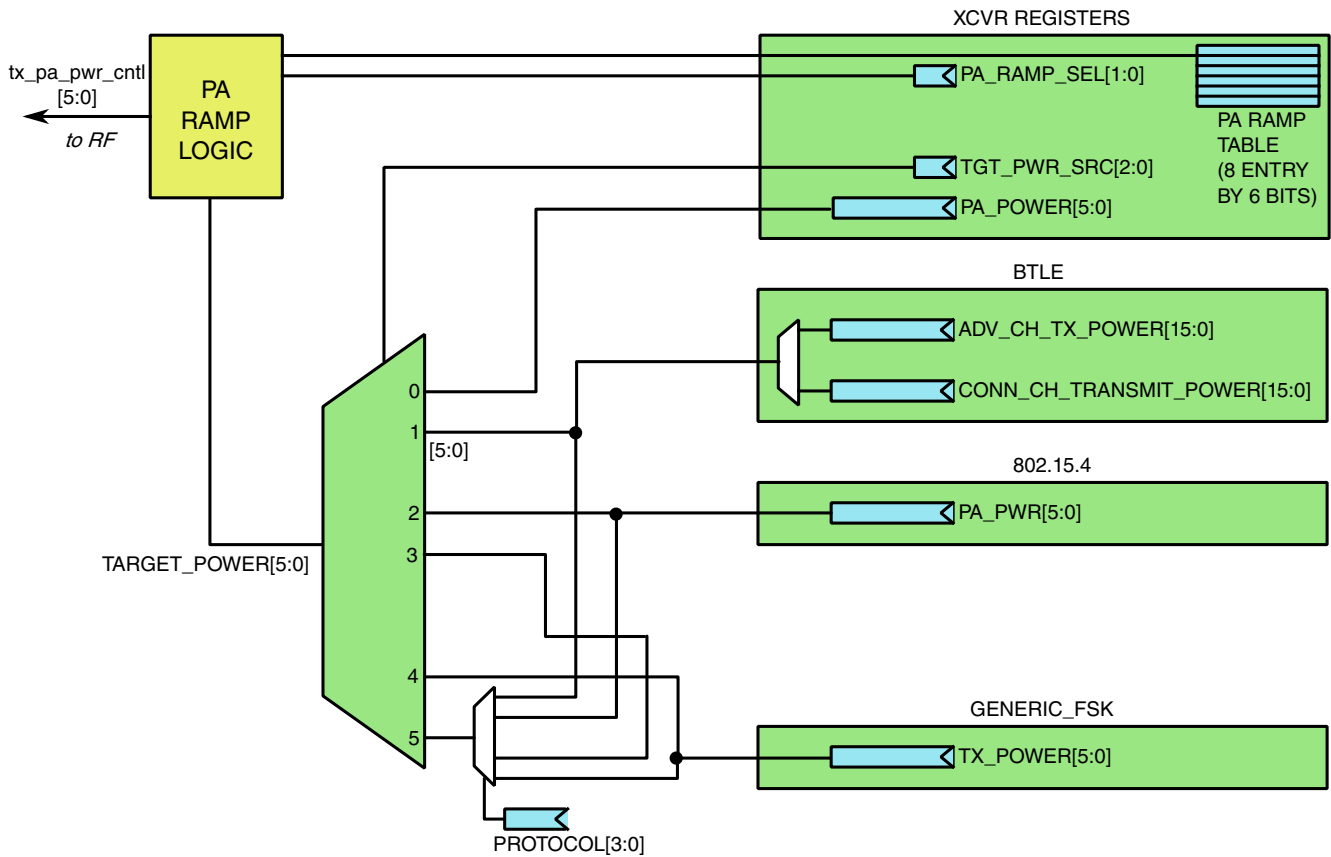

Figure 45-55. PA Target Power Selection

The XCVR register TGT_PWR_SRC[2:0], control target power selection, according to the following table.

| TGT_PWR_SRC[2:0] | TARGET POWER SOURCE |
|------------------|--|
| 000 | PA_POWER[5:0] register (XCVR space) |
| 001 | BTLE Link Layer |
| 010 | 802.15.4 Link Layer (PA_PWR[5:0] register in 802.15.4 space) |
| 011 | Reserved |
| 100 | Generic_FSK Link Layer (TX_POWER[5:0] register in GENERIC space) |
| 101 | Reserved |
| 110 | Reserved |
| 111 | PROTOCOL[3:0] bits select target power source |

These bits reside in the XCVR_CTRL register in XCVR address space.

See Section “BTLE Radio Operation” for a description of how the BTLE Link Layer controls target power.

The TSM provides power control information to the PA as a 6-bit output: `tx_pa_pwr_ctrl[5:0]`.

45.4.5.2.12 PA Ramping

PA ramping is included in the TSM, to prevent abrupt transitions in PA (power amplifier) power, that could cause unwanted spectral transients. During a TX sequence, PA ramping gradually ramps up PA power, between a programmable minimum, and the TX target power. The trajectory of the ramp is programmable, and ramping takes place over the course of 2, 4, or 8 μ s (programmable).

During a TX sequence, PA ramping, if enabled, is triggered by a low-to-high transition on the TSM output `tx_pa_en`, which is also the enable for the PA (tx buffer). At assertion of `tx_pa_en` during the TX sequence with ramping enabled, the TSM will enable the PA, with a minimum power level determined by the register `PA_RAMP0[5:0]`. After that, power level will increment according to a 8-deep pre-programmed register table (PA_RAMP Table). Incrementing will occur at a programmable rate. At each ramp step, PA power level will be taken from the next entry in the PA_RAMP Table, from 0-7. After the eighth and final ramp step, PA power level will be the selected target power. The target power will remain in place for the duration of the packet transmission, i.e., the “ON” phase of the TSM sequence.

The ramp trajectory is determined by the contents of the PA_RAMP Table. The PA_RAMP table contains register fields `PA_RAMP0[5:0]` ... `PA_RAMP7[5:0]`. These register fields can be found in the `PA_RAMP_TBL0` and `PA_RAMP_TBL1` registers in XCVR address space. The contents of the PA_RAMP table are as shown:

| PA_RAMP Table |
|----------------------------|
| <code>PA_RAMP0[5:0]</code> |
| <code>PA_RAMP1[5:0]</code> |
| <code>PA_RAMP2[5:0]</code> |
| <code>PA_RAMP3[5:0]</code> |
| <code>PA_RAMP4[5:0]</code> |
| <code>PA_RAMP5[5:0]</code> |
| <code>PA_RAMP6[5:0]</code> |
| <code>PA_RAMP7[5:0]</code> |

At each step of the ramp-up, the selected entry of the PA_RAMP Table is compared against `target_power`. The lesser of the two becomes the output power for that ramp step. This allows the same PA_RAMP table to be used for various `target_power` levels, without re-programming the table.

The ramp rate is controlled by the register bit PA_RAMP_SEL[1:0] bits of the TSM_CTRL register in XCVR address space. For each setting, the table below describes the total ramp duration, and the duration of each ramp step.

| PA_RAMP_SEL[1:0] | TOTAL RAMP DURATION | DURATION OF EACH RAMP STEP |
|------------------|---------------------|----------------------------|
| 00 | No ramp | No ramp |
| 01 | 2us | 0.25us |
| 10 | 4us | 0.5us |
| 11 | 8us | 1us |

When PA_RAMP_SEL[1:0] is set to 0, there is no ramping, and tx_pa_pwr_ctrl[5:0] tracks the selected Target Power at all time (see Section [PA Target Power](#) of this Block Guide).

When PA_RAMP_SEL[1:0] is set to 1, a 2us ramp is enabled, as shown:

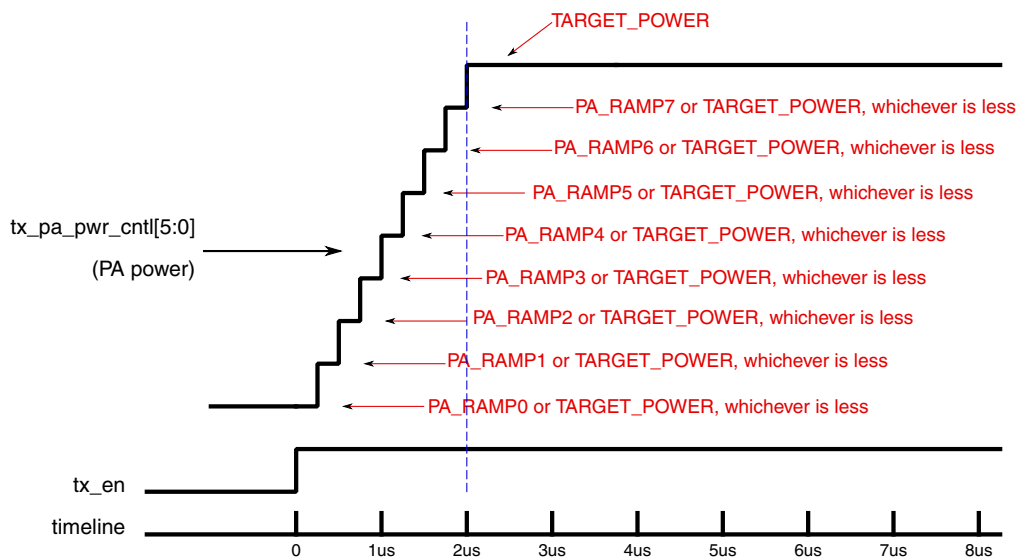

Figure 45-56. PA RAMP UP(2us)

When PA_RAMP_SEL[1:0] is set to 2, a 4us ramp is enabled as shown:

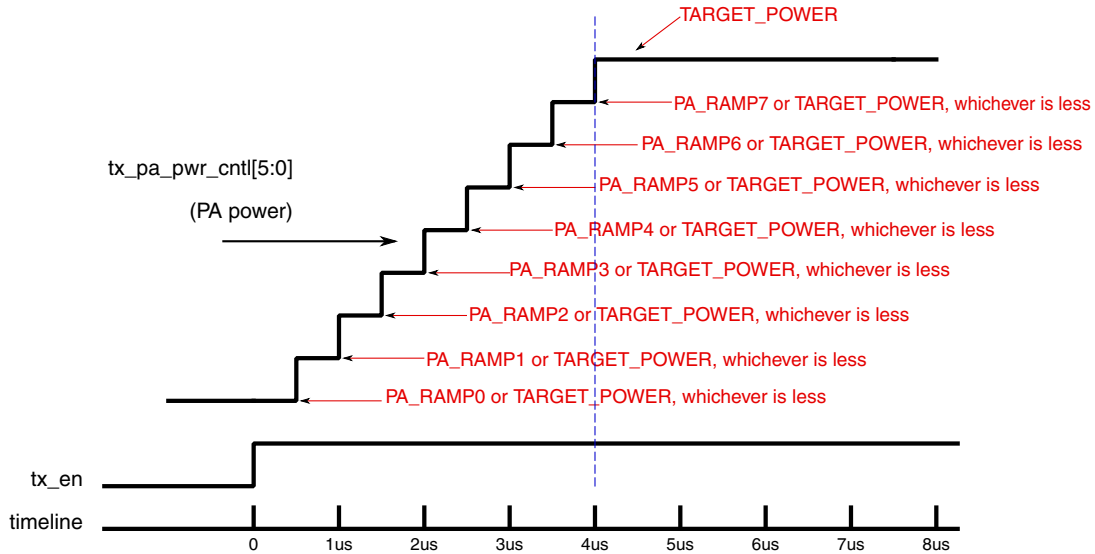

Figure 45-57. PA RAMP UP(4us)

When PA_RAMP_SEL[1:0] is set to 3, a 8us ramp is enabled as shown:

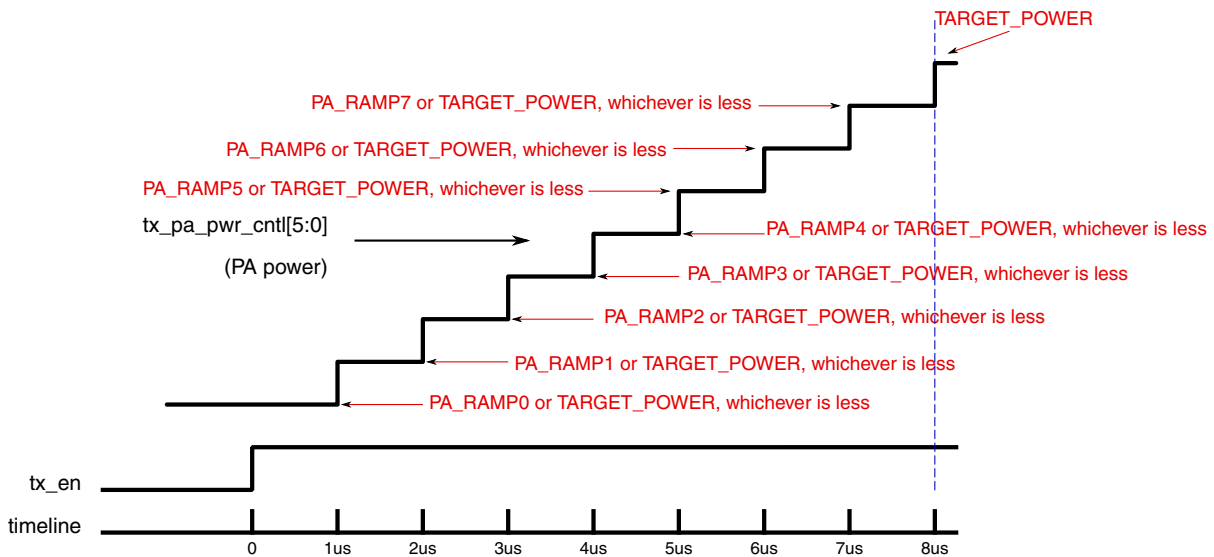

Figure 45-58. PA RAMP UP(8us)

PA ramp-down is the mirror image of ramp-up. Ramp-down is triggered by the deassertion of the sequence-initiating event (e.g., btle_tx_en, zigbee_tx_en, or force_tx_en). At deassertion of the initiating event, output power will hold at target_power for 1us. Then, output power will step through the PA_RAMP Table in reverse order, starting at PA_RAMP7, and ending at PA_RAMP0. At each step of the ramp-down, the selected entry of the PA_RAMP Table is compared against target_power. The lesser of the two becomes the output power. The

PA_RAMP_SEL[1:0] register controls the ramp-down rate in the same manner that it controls the ramp-up rate. After the last step of the ramp-down (PA_RAMPO level), tx_pa_en deasserts to disable the PA.

45.4.5.2.13 Low Power Preamble Search (LPPS)

To reduce power consumption during 802.15.4 preamble-search receive state, a low-power-preamble-search (LPPS) mode can be optionally enabled. When engaged, the correlators are disabled approximately 50% of the time during preamble search. The same signal used to dynamically enable/disable the correlators, can be used to enable/disable selected analog and RF blocks in tandem, to further reduce power consumption. The LPPS_CTRL register in XCVR space, has one bit to master-enable LPPS mode (LPPS_ENABLE), and several other bits to allow selected analog and RF blocks to be “duty-cycled” in sync with the correlators.

By default, LPPS mode is not enabled.

During LPPS mode, correlators and RF blocks are duty-cycled with timing controlled by the LPPS signal **lpps_lp_en**, which is a single-wire output from the 802.15.4 demodulator. In general, eligible blocks will be powered off when **lpps_lp_en** is high, and perform normal operation when **lpps_lp_en** is low. Transitions on **lpps_lp_en** will be handled by the TSM in the following ways:

lpps_lp_en 1 → 0:

1. TSM outputs which are programmed to be eligible for LPPS duty-cycling (e.g, those associated with TZA, BBA, ADC) shall be reasserted at this point.
2. TSM shall recycle to a programmable point in the RX warmup. The TSM RECYCLE_COUNT2[7:0] register selects the TSM_COUNT to recycle to.
3. After jumping to the TSM_COUNT indicated in RECYCLE_COUNT2, TSM shall from this point forward execute a Fast RX Warmup (see Section FAST TSM Fast Warmups later in this chapter). For the Fast RX Warmup, the registers LPPS_START_RX[7:0] and LPPS_DEST_RX[7:0] shall be used to program the TSM "jump" start and end points, as defined in the Fast RX Warmup section. The LPPS_START_RX and LPPS_DEST_RX registers reside in the LPPS_CTRL register. These registers are specific to LPPS fast warmups, and do not apply to non-LPPS fast warmups.

lpps_lp_en 0 → 1:

1. TSM outputs which are programmed to be eligible for LPPS duty-cycling (e.g, those associated with TZA, BBA, ADC) shall be deasserted at this point.
2. TSM outputs which are not eligible for LPPS duty-cycling shall remain asserted.

Note that the penalty for the reduced power consumption in LPPS mode during preamble search, is a slight degradation in receiver sensitivity. Note also that the TSM override bits, also override LPPS functionality. The override bits provide ultimate control over all TSM outputs.

Programming control for LPPS, includes a master-enable register bit for the LPPS state-machine, as well as individual control bits to enable selected analog and digital blocks to be turned on-and-off during LPPS operation. The following table lists the LPPS register bits, and the TSM outputs controlled by each.

Table 45-31. LPPS Register Controls

| LPPS Register Bit | Description |
|----------------------|--|
| LPPS_ENABLE | Master enable for LPPS mode. Allows correlators to be duty-cycled during Preamble Search, and selected analog and digital blocks to be duty-cycled simultaneously. |
| LPPS_TZA_ALLOW | When set to one, allows the following TSM outputs to be controlled by the LPPS state machine: rx_lna_en, rx_tza_i_en, rx_tza_q_en |
| LPPS_BBA_ALLOW | When set to one, allows the following TSM outputs to be controlled by the LPPS state machine: rx_bba_i_en, rx_bba_q_en |
| LPPS_ADC_ALLOW | When set to one, allows the following TSM outputs to be controlled by the LPPS state machine: rx_adc_en, rx_adc_i_en, rx_adc_q_en |
| LPPS_DCOC_ALLOW | When set to one, allows the following TSM outputs to be controlled by the LPPS state machine: rx_bba_dcoc_en, rx_tza_dcoc_en |
| LPPS_PDET_ALLOW | When set to one, allows the following TSM outputs to be controlled by the LPPS state machine: rx_bba_pdet_en, rx_tza_pdet_en |
| LPPS_SY_LO_ALLOW | When set to one, allows the following TSM outputs to be controlled by the LPPS state machine: sy_lo_rx_en |
| LPPS_SY_LO_BUF_ALLOW | When set to one, allows the following TSM outputs to be controlled by the LPPS state machine: sy_lo_rx_buf_en |
| LPPS_RX_DIG_ALLOW | When set to one, allows the following TSM outputs to be controlled by the LPPS state machine: rx_dig_en |
| LPPS_DCOC_DIG_ALLOW | When set to one, allows the following TSM outputs to be controlled by the LPPS state machine: dcoc_en |

45.4.5.2.14 TSM Fast Warmups

The previous sections illustrate the detailed control and timing generated by the TSM, operating in nominal-timing mode. There are situations that allow for the possibility to streamline and shorten the TSM warmup sequences. These situations arise when the transceiver is operating on the same RF channel for many consecutive transmit and/or

receive operations. Multiple closely-spaced TX operations on the same channel allow the HPM calibration to be skipped, after such a calibration is performed once on a given RF channel; similarly, multiple closely spaced RX operations on the same channel allow DC offset calibration to be skipped, after such a calibration is performed once on a given RF channel.

Fast TSM warmups have been devised to accomplish this streamlining. There is one fast warmup defined for TX, and one for RX. Once engaged, during a fast warmup, a portion of the nominal, programmed warmup is bypassed, or skipped over, by instructing the TSM counter to jump, once it reaches a certain count, to a new count that is not just an increment-by-one. The starting point for the “jump” as well as the destination count, or end point for the “jump”, are TSM programmable registers. There are one pair of start/destination registers for TX, and another for RX, allowing one such jump per sequence. In addition, enable bits provide software with fine control over precisely when fast warmups are allowed, versus nominal warmups.

Interaction with other blocks is required to support TSM fast warmup capability. The PLL digital block is responsible for selecting the correct frequency for RF operations, and will keep track of whether consecutive warmup operations utilize the same channel or not; it will signal this information to the TSM. The PLL digital block maintains such tracking separately for TX and RX warmups. The TSM will then signal back to the PLL digital block when a TX warmup is actually “fast” or not; the PLL digital block will use this information to instruct its state machine to skip HPM calibration. For RX warmups, the TSM will signal to the RX digital block, when to skip DC calibration, and instead use stored values.

For BLE protocol, the Advertising Channels are exempt from fast warmups. When the Advertising Channels are used to transmit and receive, there is potentially a long interval between warmups, so it has been deemed necessary to perform a full HPM calibration for TX warmups, and a DC calibration for RX warmups, when transmitting or receiving on any advertising channel, regardless of whether the channel has actually changed or not since the last warmup, and regardless of how much time has elapsed since then. The BLE Advertising channels are Channels 37, 38, and 39. BLE uses the advertising channels in the Advertising, Scanning, and Initiating states. In the Connection state, Data Channels are used and Fast TX and RX warmups are allowed.

For non-BLE protocols, channel selection is a purely software function. For these protocols (802.15.4, and GENERIC_FSK), a CHANNEL_NUM register is programmed to select the RF channel for the next TX or RX warmup. For these protocols, any change to the respective CHANNEL_NUM register will erase the “channel memory” that the PLL Digital block keeps track of determine whether the next TSM warmup is allowed to be a fast, rather than a normal warmup. Any write to CHANNEL_NUM will force the next TX warmup to be normal (not fast), regardless of whether the *previous* TX warmup

was on the same channel or not. Similarly, any write to CHANNEL_NUM will force the next RX warmup to be normal (not fast), regardless of whether the *previous* RX warmup was on the same channel or not.

The inter-block signaling to support fast TSM warmups is illustrated in the following diagram, followed by a table which describes the signals.

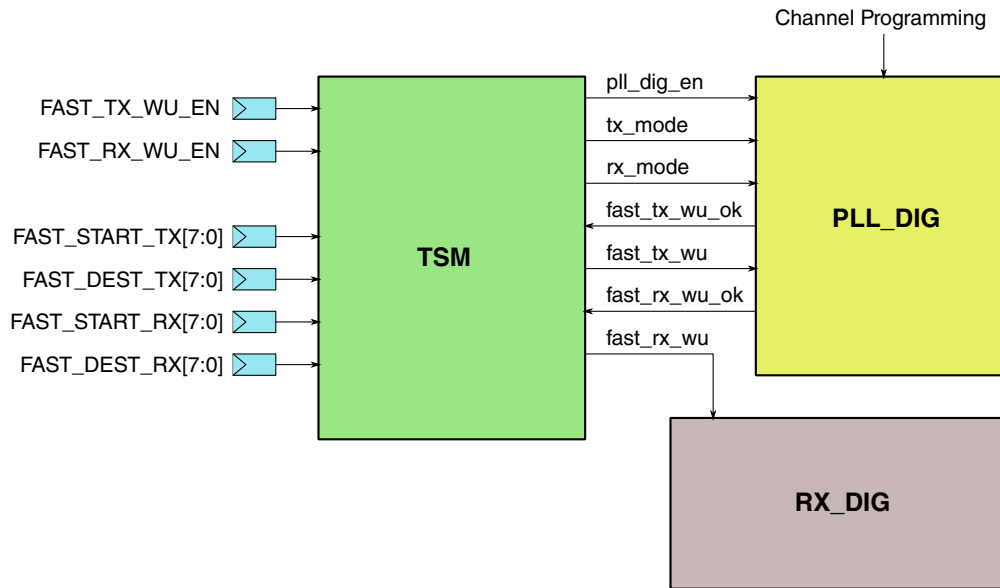

Figure 45-59. Transceiver Signalling To Support TSM Fast Warmups

| “Fast Warmup” Signal | Source | Destination | Description |
|----------------------|-------------|-------------|--|
| pll_dig_en | TSM | PLL Digital | Rising edge of this signal used by PLL_DIG to capture the Channel Programming for the current warmup |
| tx_mode | TSM | PLL Digital | Used in conjunction with pll_dig_en to capture the Channel Programming for TX sequences |
| rx_mode | TSM | PLL Digital | Used in conjunction with pll_dig_en to capture the Channel Programming for RX sequences |
| fast_tx_wu_ok | PLL Digital | TSM | Indicates that the Channel Programming on the <i>current</i> TX warmup has not changed since the <i>last</i> TX warmup |
| fast_tx_wu | TSM | PLL Digital | This is a fast TX warmup. PLL_DIG should skip HPM Cal. |

Table continues on the next page...

| "Fast Warmup" Signal | Source | Destination | Description |
|----------------------|-------------|-------------|--|
| fast_rx_wu_ok | PLL Digital | TSM | Indicates that the Channel Programming on the <i>current</i> RX warmup has not changed since the <i>last</i> RX warmup |
| fast_rx_wu | TSM | RX Digital | This is a fast RX warmup. RX Dig should skip DCOC Cal. |

TSM Registers to support Fast TSM Warmups are described in the following table.

| Field | R/W | Description |
|--------------------|-----|--|
| FAST_TX_WU_EN | rw | 1: Enable Fast TX Warmup (if fast_tx_wu_ok asserted by PLL_DIG) 0: Disable Fast TX Warmups |
| FAST_RX_WU_EN | rw | 1: Enable Fast RX Warmup (if fast_rx_wu_ok asserted by PLL_DIG) 0: Disable Fast RX Warmups |
| FAST_WU_CLEAR | rw | Erase the "channel memory" in the PLL Digital Block, forcing the next TX warmup and RX warmup to be normal warmups (not fast). This bit is not self-clearing. Write a '1' to the bit, followed by '0', to erase channel history. |
| FAST_START_TX[7:0] | rw | During a Fast TX Warmup, this value represents the starting TSM count for the portion of the warmup that is to be skipped over. If Fast TX Warmups are enabled, this count will never be reached; its place in the TSM warmup will be replaced by the contents of FAST_DEST_TX[7:0], thereby executing the jump. |
| FAST_DEST_TX[7:0] | rw | During a Fast TX Warmup, this value represents the ending TSM count for the portion of the warmup that is to be skipped over. If Fast TX Warmups are enabled, FAST_START_TX[7:0] will never be reached and will instead be replaced by the contents of this register, thereby executing the jump. Example: FAST_START_TX = 10 FAST_DEST_TX = 15 The TSM will count as follows: ... 7,8,9,15,16,17 ... |
| FAST_START_RX[7:0] | rw | During a Fast RX Warmup, this value represents the starting TSM count for the portion of the warmup that is to be skipped over. If Fast RX Warmups are |

Table continues on the next page...

| Field | R/W | Description |
|-------------------|-----|---|
| | | enabled, this count will never be reached; its place in the TSM warmup will be replaced by the contents of FAST_DEST_RX[7:0], thereby executing the jump. |
| FAST_DEST_RX[7:0] | rw | <p>During a Fast RX Warmup, this value represents the ending TSM count for the portion of the warmup that is to be skipped over. If Fast RX Warmups are enabled, FAST_START_RX[7:0] will never be reached and will instead be replaced by the contents of this register, thereby executing the jump.</p> <p>Example:</p> <pre>FAST_START_TX = 10 FAST_DEST_TX = 15</pre> <p>The TSM will count as follows: ... 7,8,9,15,16,17 ...</p> |

Software running on the various protocol engines which utilize the TSM to provide access to the channel, need not be aware that the total warmup time has been reduced, when the TSM executes a fast warmup, as opposed to a nominal warmup. Link Layer software expects TSM warmup times to be a fixed constant, actually 2 fixed constants, one for TX warmups and one for RX warmups. Software must account for these TX and RX warmup times when they are scheduling transceiver operations, so that the first symbol of preamble is transmitted at the correct instant for transmit operations, and that the receiver is ready to receive the first symbol of preamble at the correct instant for receive operations. Software views these warmup times as fixed lead times that must be accounted for in advance of a transceiver operation.

In order to make the fast warmup time reduction transparent to software, when a Fast TSM warmup is executed, the TSM will delay the start of the warmup, by the amount of time skipped by the jump. That keeps the total elapsed time, from the instant the software launches the TSM sequence, to the point at which the warmup completes, identical for fast and nominal warmups.

The following diagram illustrates how the TSM delays the start of the Fast TX sequence, relative to the nominal TX sequence, so that the delta time between `btle_tx_en` (TSM launch signal), and the transmission of the first bit of preamble, is the same in either case.

NOMINAL TX WARMUP

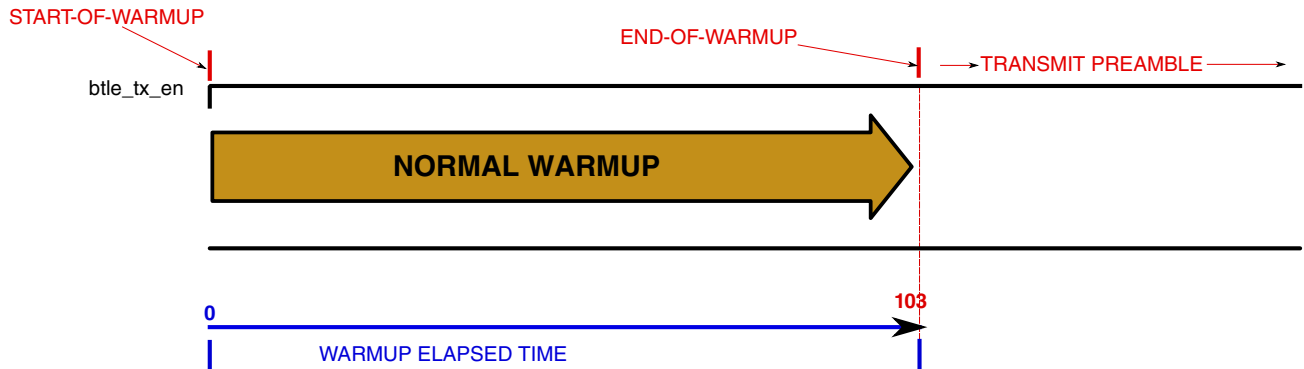

FAST TX WARMUP

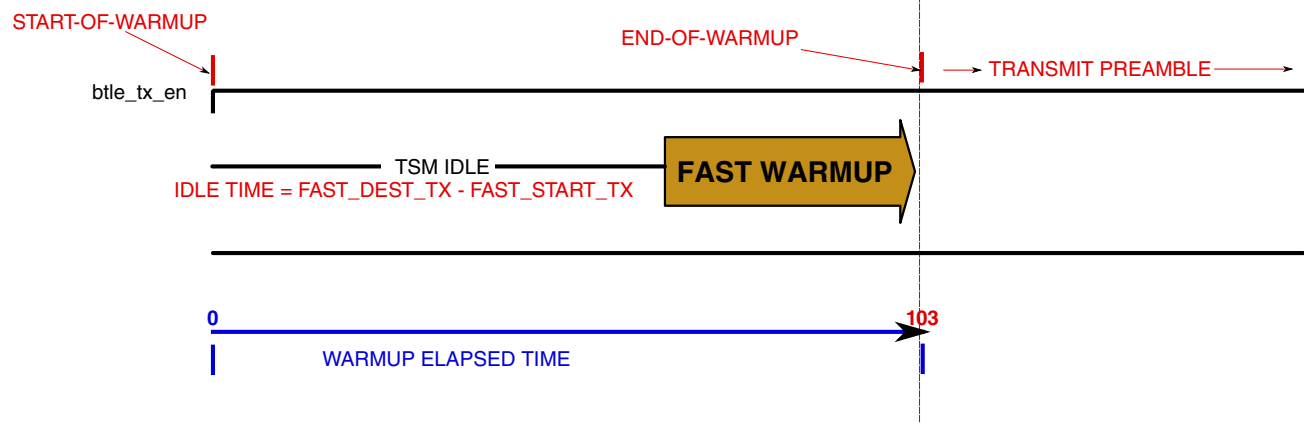
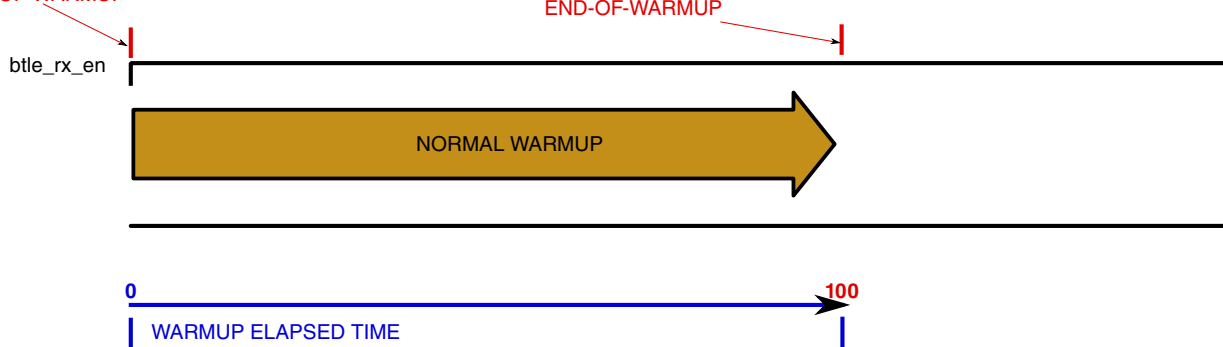

Figure 45-60. Nominal vs. Fast TX Warmups

The following diagram illustrates how the TSM delays the start of the Fast RX sequence, relative to the nominal RX sequence, so that the delta time between `btle_rx_en` (TSM launch signal), and the ability to receive first bit of preamble, is the same in either case.

NOMINAL RX WARMUP

START-OF-WARMUP

**FAST RX WARMUP**

START-OF-WARMUP

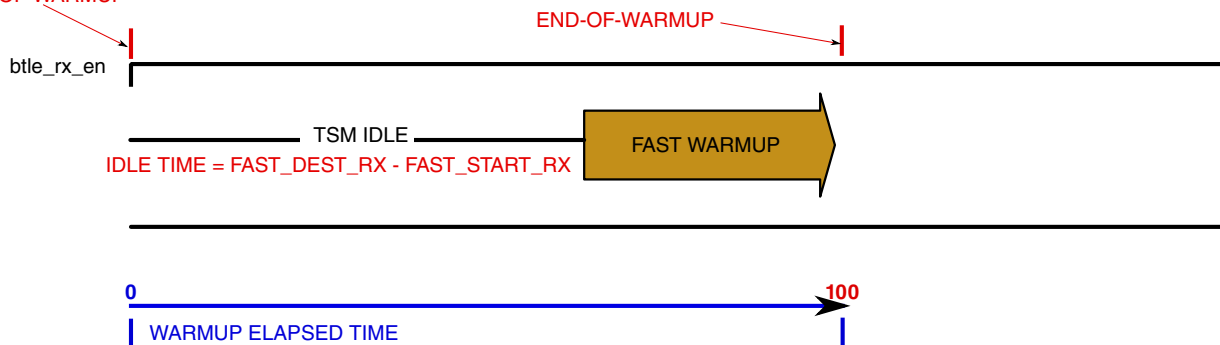
**Figure 45-61. Nominal vs. Fast RX Warmups**

In the previous examples, a BLE-triggered warmup is shown for TX and RX. However the same concept applies to all protocols which use the TSM to access the RF channel (e.g., 802.15.4, and GENERIC_FSK). The diagrams show a 103us TX warmup and a 100us RX warmup. The actual length-of-warmup is programmable, determined by the END_OF_SEQ register.

45.4.5.2.15 Programming Restrictions

The following restrictions are imposed on TSM programming. Violating the restrictions may result in unpredictable behavior.

1. The maximum value for END_OF_TX_WU[7:0] is 253
2. The maximum value for END_OF_RX_WU[7:0] is 253
3. The maximum value for END_OF_TX_WD[7:0] is 254
4. The maximum value for END_OF_RX_WD[7:0] is 254
5. $END_OF_TX_WD[7:0] - END_OF_TX_WU[7:0] \geq 1$
6. $END_OF_RX_WD[7:0] - END_OF_RX_WU[7:0] \geq 1$
7. $BKPT[7:0] \neq END_OF_TX_WD[7:0]$
8. $BKPT[7:0] \neq END_OF_RX_WD[7:0]$

9. For any TSM output: $\text{OUTPUTNAME_TX_HI}[7:0] \leq \text{OUTPUTNAME_TX_LO}[7:0]$
10. For any TSM output: $\text{OUTPUTNAME_RX_HI}[7:0] \leq \text{OUTPUTNAME_RX_LO}[7:0]$

Restrictions 9 and 10 above, if violated, will result in the TSM-controlled output held in a deasserted state throughout the sequence.

To guarantee non-assertion of a particular TSM-controlled output throughout the course of a sequence, simply program its $\text{OUTPUTNAME_SEQ_HI} = \text{OUTPUTNAME_SEQ_LO} = 255$ (where $\text{SEQ} = \text{TX}$ or RX).

45.4.5.2.16 Timing Diagrams

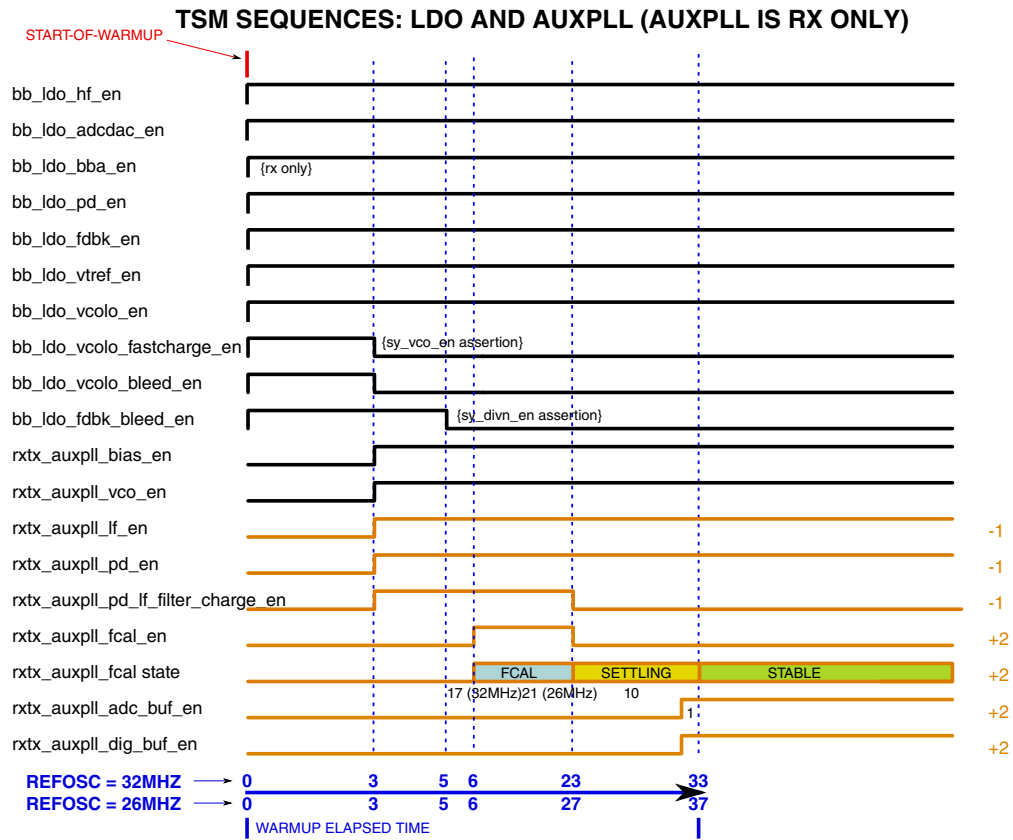

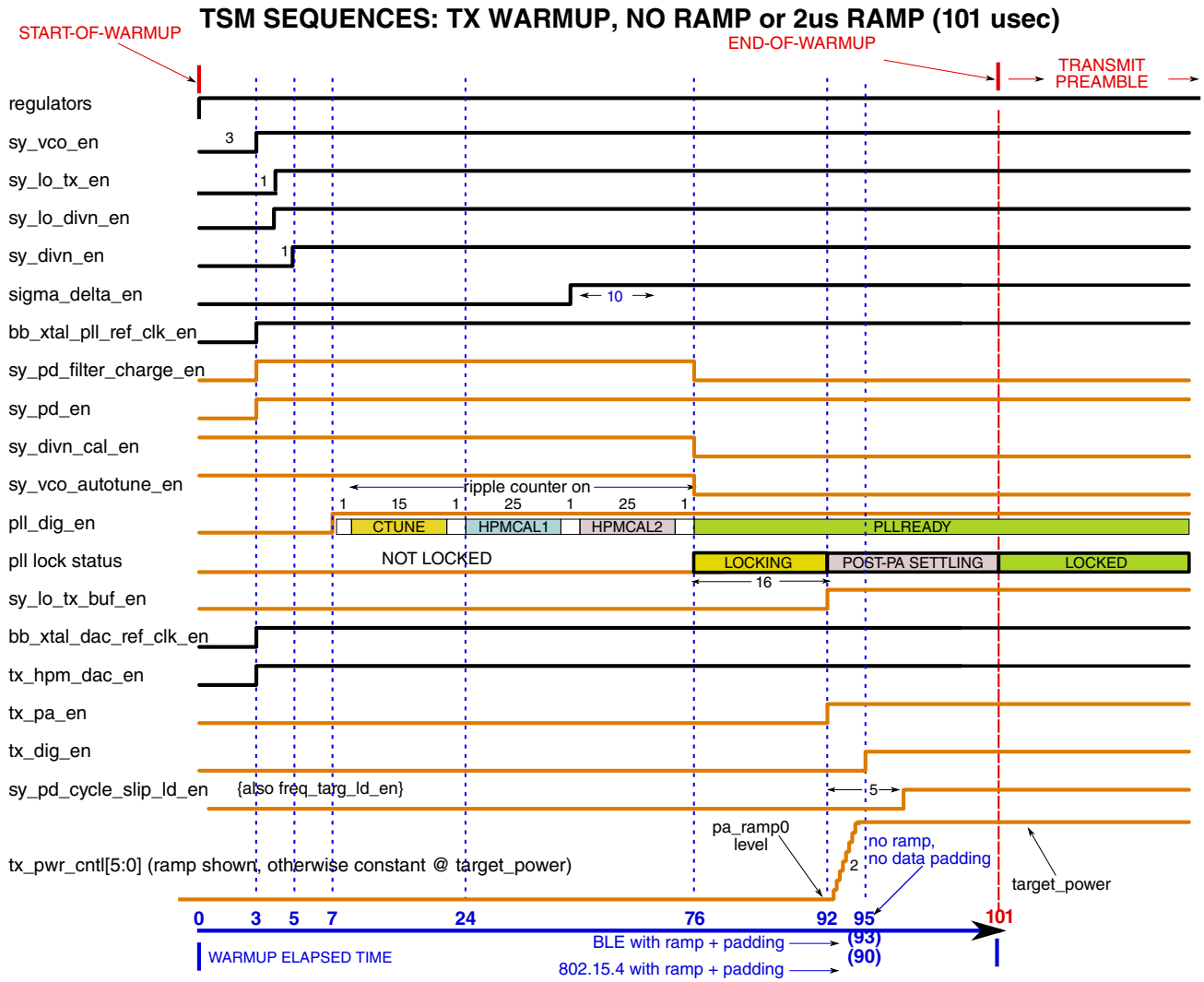

TSM SEQUENCES: TX WARMDOWN, 2us RAMP

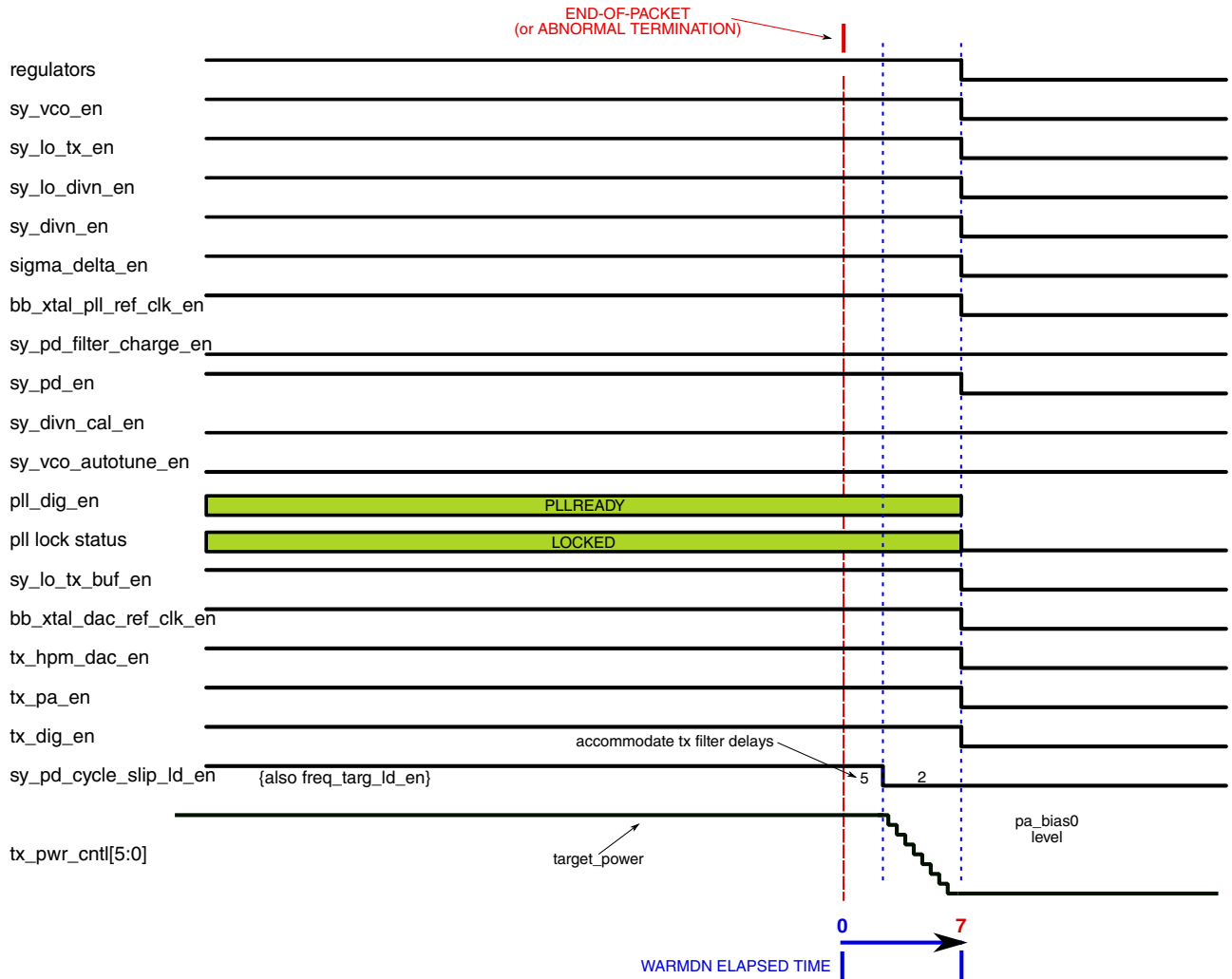

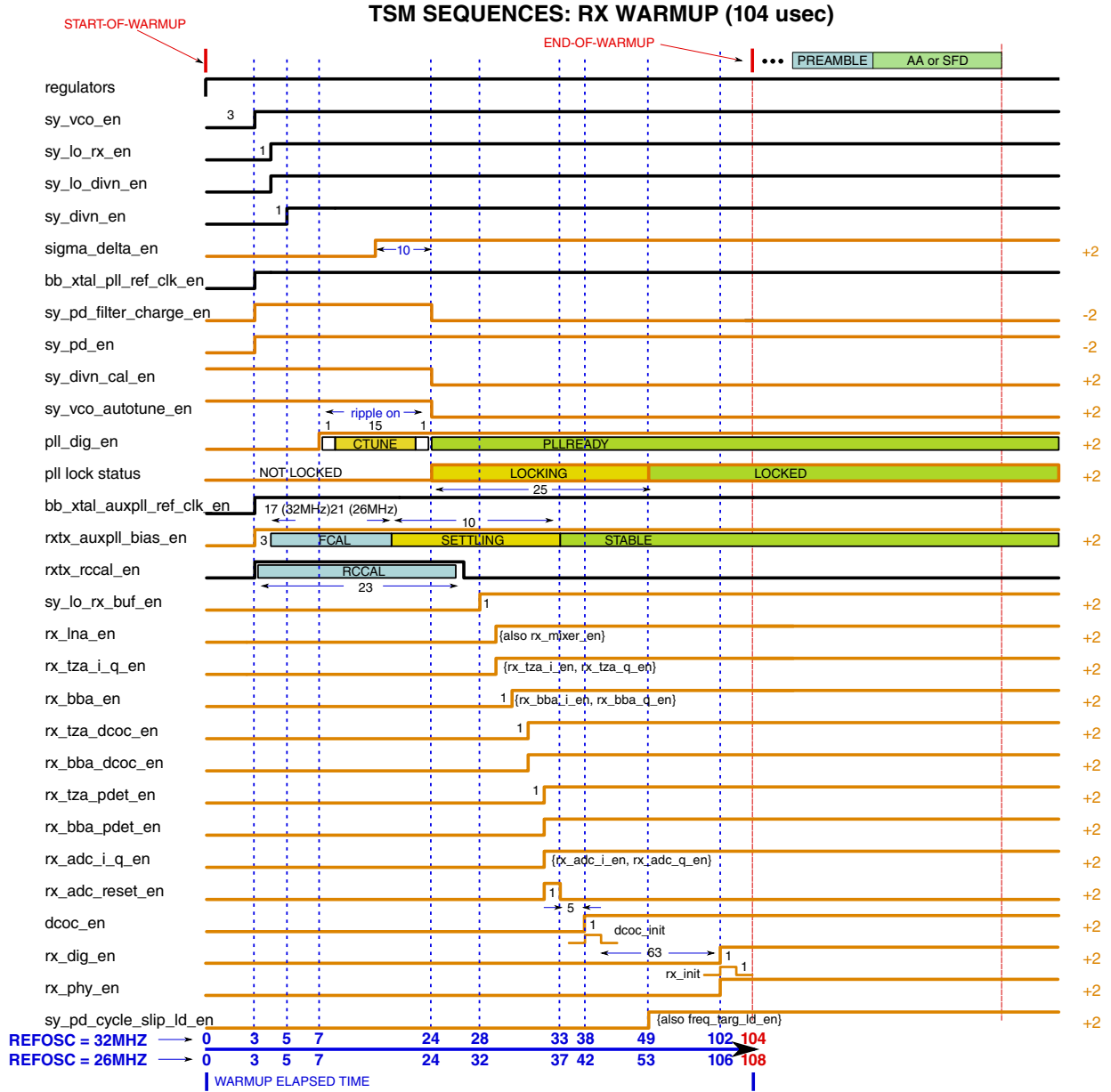

TSM SEQUENCES: FAST TX WARMUP, NO RAMP or 2us RAMP

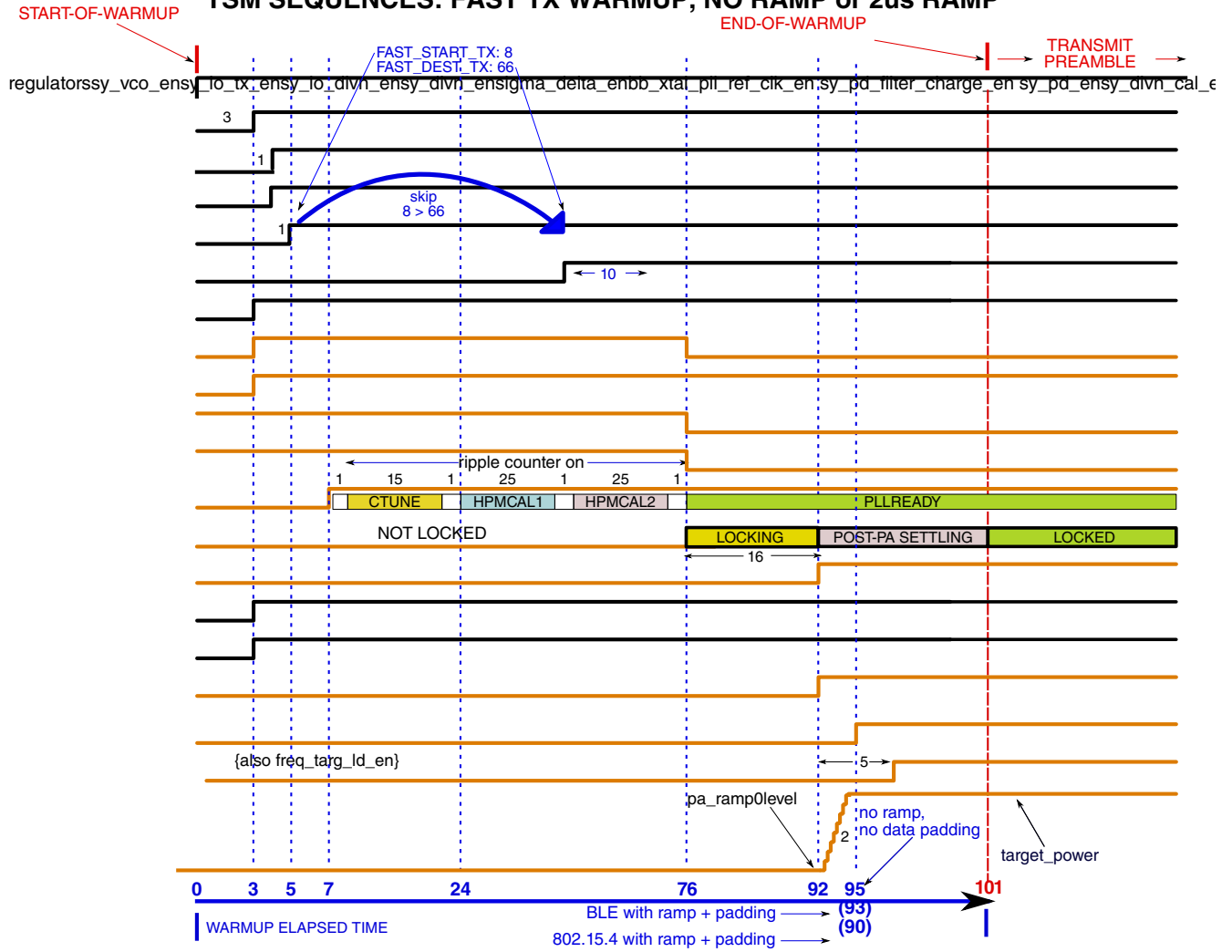

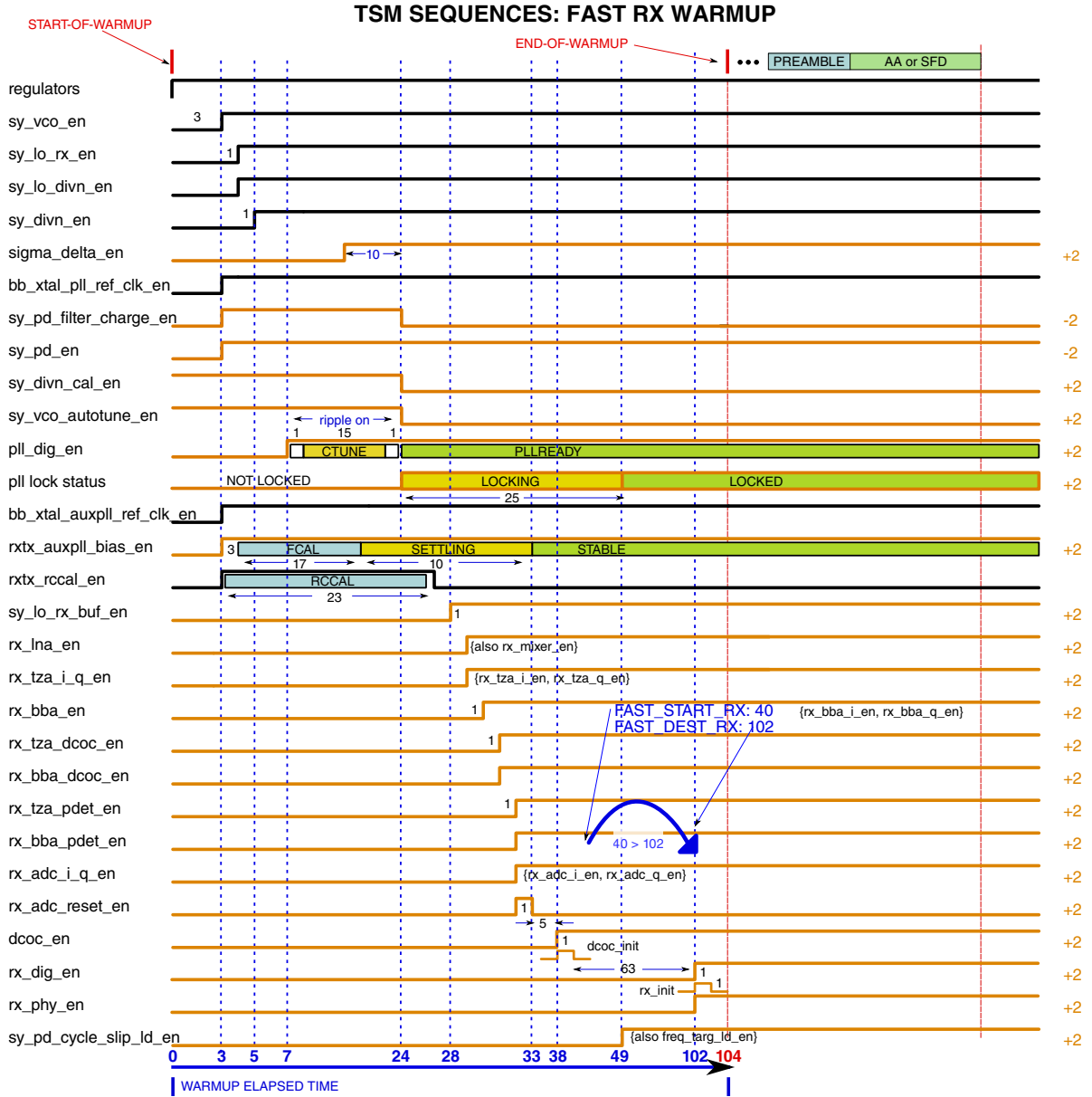

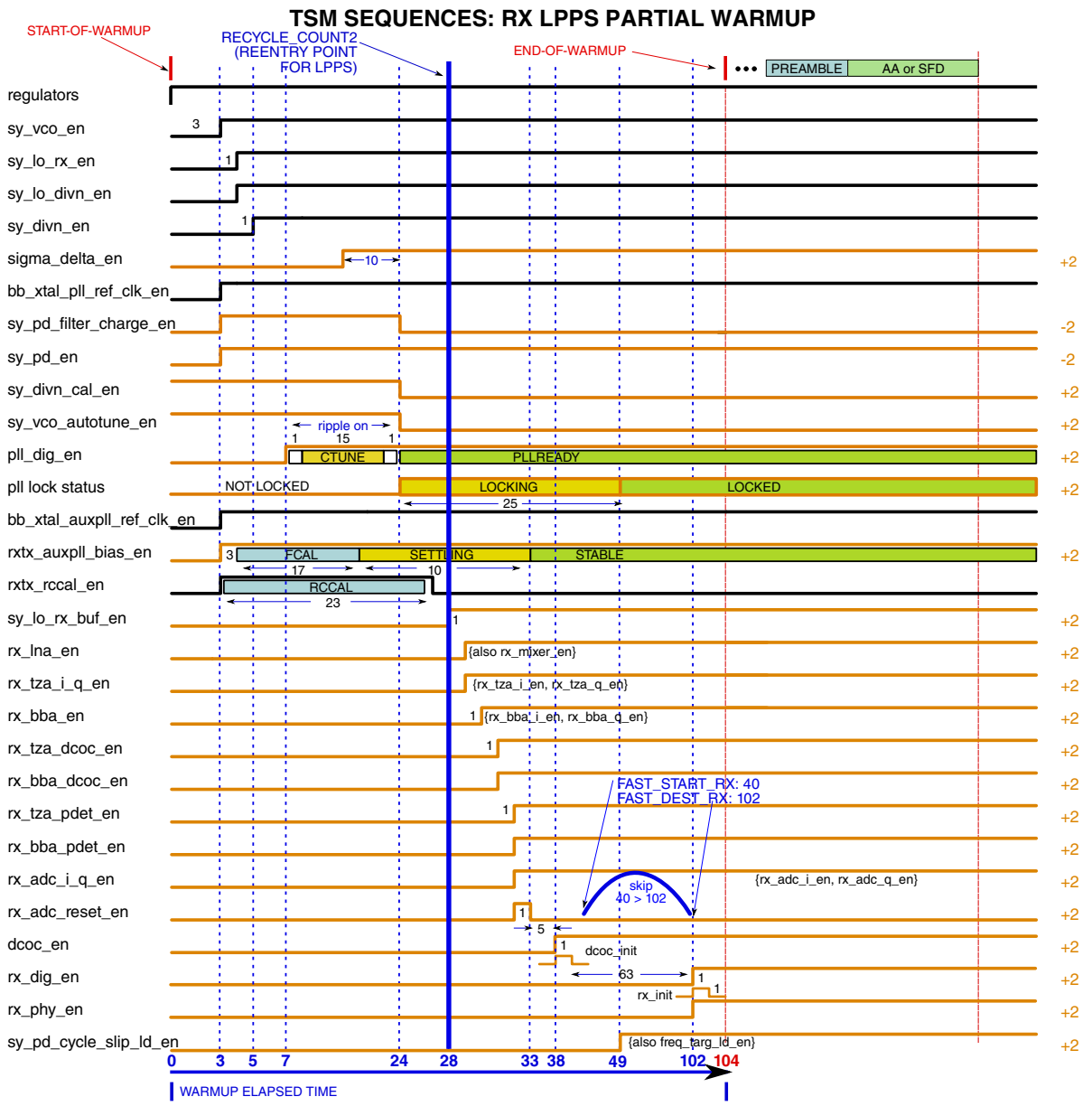

45.4.5.2.17 Clocks

The TSM uses 4 clocks:

1. `ipg_clk`
2. `tsm_clk`
3. `tsm_dly_clk`
4. `tsm_4m_clk`

The “**ipg_clk**”, is a gated 32mhz (or 26mhz) clock from the reference oscillator. This clock only used to re-clock the `tx_pwr_cntl[3:0]` output, to ensure no glitching or skew between the bits, on this power control bus to the PA.

The main clock is the 1MHz **tsm_clk**. This clock establishes the TSM timebase (1us), and runs the TSM counter, as well as the control and abort-handling logic.

Another 1MHz clock is **tsm_dly_clk**. This clock is used to re-clock the 67 TSM-controlled outputs. This clock is time-shifted (delayed) by 1 `ipg_clk` cycle relative to `tsm_clk`.

The 4Mhz clock **tsm_4m_clk** runs the PA ramping logic.

All 4 TSM clocks derive from the same 32MHz (or 26mhz) source, the reference oscillator. They are divided down from this reference frequency in the CGM (Clocks Generator Module). Since all 4 are in the same clock domain, they will be balanced (skew-controlled) during clock-tree synthesis. There there are no clock-domain-crossings or asynchronous interfaces in the TSM.

45.4.5.2.18 Reset

The TSM has a single, active-low, asynchronous reset input: **ipg_hard_async_reset_b** . At integration, this reset should be tied to the master reset for the entire transceiver. There are no special reset requirements.

45.4.5.2.19 Interrupts

For debug purposes, TSM can generate up to 2 interrupts to the host processor. Like all other TSM-controlled outputs, the point during the TX or RX warmup at which the interrupt is triggered, is fully programmable. Since there is no defined mission-mode use for TSM interrupts, no new dedicated timing registers have been provisioned. Instead, the 2 TSM interrupts share timing registers with TSM-controlled outputs **tsm_spare0_en** and **tsm_spare1_en**. The following diagram depicts the reuse scheme.

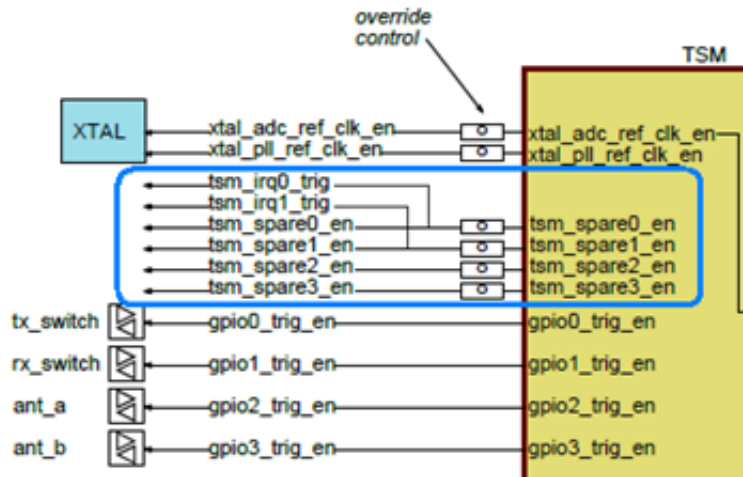

Figure 45-62. TSM Interrupt Re-use Scheme

Two new control bits have been added to TSM_CTRL to enable each TSM interrupt. The following table lists the TSM Interrupt, the TSM enable bit for the interrupt, and the TSM timing register which controls the timing of the interrupt.

Table 45-32. TSM Interrupt Control

| TSM Interrupt | Interrupt Enable Bit (TSM_CTRL) | Timing Control Register |
|---------------|---------------------------------|-------------------------|
| TSM_IRQ0 | TSM_IRQ0_EN | TSM_TIMING43 |
| TSM_IRQ1 | TSM_IRQ1_EN | TSM_TIMING44 |

Because the TSM is part of XCVR space, and XCVR space does not have its own interrupt vector, the TSM interrupt is "assigned" to the Link Layer currently in possession of the 2.4GHz radio. Possession is determined by the state of the XCVR_CTRL[PROTOCOL] bits. Each of the 4 Link Layer controllers (BLE, 802.15.4, and GENERIC_FSK), has in its address space, a TSM_IRQ status bit, as well as a enable bit to allow/disallow the TSM interrupt to assert the Link Layer's interrupt line to the MCU. The bit positioning of the TSM_IRQ varies slightly amongst the 4 Link Layers, to optimally group the TSM_IRQ with existing, protocol-specific interrupt sources, and to minimize the software impact to existing service routines, by requiring as few additional register reads as possible to service the Link Layer's interrupts with TSM_IRQ enabled. The TSM_IRQ status bit, as it appears in each Link Layer's address space, is a logical "OR" of the TSM's TSM0_IRQ and TSM1_IRQ. The Link Layer TSM_IRQ is read-only. It can be cleared by clearing both TSM0_IRQ and TSM1_IRQ in the XCVR's XCVR_STATUS register. In the XCVR_STATUS register, TSM0_IRQ and TSM1_IRQ are both write-1-to-clear bits. See the Register Description for each individual Link Layer, for a description of the TSM_IRQ read-only interrupt status bit, and its bit positioning within the Link Layer's address space.

45.4.5.3 Memory Map and register definition

There are 59 sets of timing registers for the TSM, one set for each TSM-controlled output (or, for the signal controlling the group for the “grouped” outputs). Each register set consists of 4 registers: one to control the assertion time of the output for TX sequences, one to control the assertion time for RX sequence, one to control the deassertion time for TX sequences, and one to control the deassertion time for RX sequences. For TSM-controlled outputs that are grouped, one set of timing registers controls the timing for all members of the group. For each of these 59 sets, the following table lists the SoC register name (TSM_TIMING00 – TSM_TIMING58), and 4 timing register names associated with each. There are various other registers to control the overall TX and RX sequence lengths, configure for Fast Warmups, etc.

See below for the TSM register locations and detailed definitions.

45.4.5.3.1 XCVR_TSM Register Descriptions

45.4.5.3.1.1 XCVR_TSM_ADDR Memory Map

Base address: 4005C2C0h

| Offset | Register | Width (In bits) | Access | Reset value |
|-----------|---|--------------------|--------|-------------|
| 4005C2C0h | TRANSCEIVER SEQUENCE MANAGER CONTROL (CTRL) | 32 | RW | FF004000h |
| 4005C2C4h | TSM END OF SEQUENCE (END_OF_SEQ) | 32 | RW | 67666A63h |
| 4005C2C8h | TSM OVERRIDE REGISTER 0 (OVRD0) | 32 | RW | 00000000h |
| 4005C2CCh | TSM OVERRIDE REGISTER 1 (OVRD1) | 32 | RW | 00000000h |
| 4005C2D0h | TSM OVERRIDE REGISTER 2 (OVRD2) | 32 | RW | 00000000h |
| 4005C2D4h | TSM OVERRIDE REGISTER 3 (OVRD3) | 32 | RW | 00000000h |
| 4005C2D8h | PA POWER (PA_POWER) | 32 | RW | 00000000h |
| 4005C2DCh | PA RAMP TABLE 0 (PA_RAMP_TBL0) | 32 | RW | 10080402h |
| 4005C2E0h | PA RAMP TABLE 1 (PA_RAMP_TBL1) | 32 | RW | 3A342A1Ch |
| 4005C2E4h | TSM RECYCLE COUNT (RECYCLE_COUNT) | 32 | RW | 001A0464h |
| 4005C2E8h | TSM FAST WARMUP CONTROL REGISTER 1 (FAST_CTRL1) | 32 | RW | 0000FF00h |
| 4005C2ECh | TSM FAST WARMUP CONTROL REGISTER 2 (FAST_CTRL2) | 32 | RW | FFFFFFFFh |
| 4005C2F0h | TSM_TIMING00 (TIMING00) | 32 | RW | 67006A00h |
| 4005C2F4h | TSM_TIMING01 (TIMING01) | 32 | RW | 67006A00h |
| 4005C2F8h | TSM_TIMING02 (TIMING02) | 32 | RW | 6700FFFFh |
| 4005C2FCh | TSM_TIMING03 (TIMING03) | 32 | RW | 67006A00h |

Table continues on the next page...

FSK Modulator

| Offset | Register | Width (In bits) | Access | Reset value |
|-----------|-------------------------|--------------------|--------|-------------|
| 4005C300h | TSM_TIMING04 (TIMING04) | 32 | RW | 67006A00h |
| 4005C304h | TSM_TIMING05 (TIMING05) | 32 | RW | 67006A00h |
| 4005C308h | TSM_TIMING06 (TIMING06) | 32 | RW | 67006A00h |
| 4005C30Ch | TSM_TIMING07 (TIMING07) | 32 | RW | 05000500h |
| 4005C310h | TSM_TIMING08 (TIMING08) | 32 | RW | 03000300h |
| 4005C314h | TSM_TIMING09 (TIMING09) | 32 | RW | 03000300h |
| 4005C318h | TSM_TIMING10 (TIMING10) | 32 | RW | 67036A03h |
| 4005C31Ch | TSM_TIMING11 (TIMING11) | 32 | RW | FFFF6A03h |
| 4005C320h | TSM_TIMING12 (TIMING12) | 32 | RW | 6703FFFFh |
| 4005C324h | TSM_TIMING13 (TIMING13) | 32 | RW | 16004A00h |
| 4005C328h | TSM_TIMING14 (TIMING14) | 32 | RW | 672F645Fh |
| 4005C32Ch | TSM_TIMING15 (TIMING15) | 32 | RW | 67036A03h |
| 4005C330h | TSM_TIMING16 (TIMING16) | 32 | RW | 671AFFFFh |
| 4005C334h | TSM_TIMING17 (TIMING17) | 32 | RW | FFFF6A5Ah |
| 4005C338h | TSM_TIMING18 (TIMING18) | 32 | RW | 67056A05h |
| 4005C33Ch | TSM_TIMING19 (TIMING19) | 32 | RW | 16054A05h |
| 4005C340h | TSM_TIMING20 (TIMING20) | 32 | RW | 67056A05h |
| 4005C344h | TSM_TIMING21 (TIMING21) | 32 | RW | 67046A04h |
| 4005C348h | TSM_TIMING22 (TIMING22) | 32 | RW | 6704FFFFh |
| 4005C34Ch | TSM_TIMING23 (TIMING23) | 32 | RW | FFFF6A04h |
| 4005C350h | TSM_TIMING24 (TIMING24) | 32 | RW | 16004A00h |
| 4005C354h | TSM_TIMING25 (TIMING25) | 32 | RW | 671BFFFFh |
| 4005C358h | TSM_TIMING26 (TIMING26) | 32 | RW | FFFF6A5Ah |
| 4005C35Ch | TSM_TIMING27 (TIMING27) | 32 | RW | 671EFFFFh |
| 4005C360h | TSM_TIMING28 (TIMING28) | 32 | RW | 1F1EFFFFh |
| 4005C364h | TSM_TIMING29 (TIMING29) | 32 | RW | 671CFFFFh |
| 4005C368h | TSM_TIMING30 (TIMING30) | 32 | RW | 671EFFFFh |
| 4005C36Ch | TSM_TIMING31 (TIMING31) | 32 | RW | 671DFFFFh |
| 4005C370h | TSM_TIMING32 (TIMING32) | 32 | RW | 671BFFFFh |
| 4005C374h | TSM_TIMING33 (TIMING33) | 32 | RW | 671EFFFFh |
| 4005C378h | TSM_TIMING34 (TIMING34) | 32 | RW | 67056A05h |
| 4005C37Ch | TSM_TIMING35 (TIMING35) | 32 | RW | FFFF6A5Dh |
| 4005C380h | TSM_TIMING36 (TIMING36) | 32 | RW | 6764FFFFh |
| 4005C384h | TSM_TIMING37 (TIMING37) | 32 | RW | 6564FFFFh |
| 4005C388h | TSM_TIMING38 (TIMING38) | 32 | RW | 670C6A40h |
| 4005C38Ch | TSM_TIMING39 (TIMING39) | 32 | RW | 6764FFFFh |
| 4005C390h | TSM_TIMING40 (TIMING40) | 32 | RW | 6724FFFFh |
| 4005C394h | TSM_TIMING41 (TIMING41) | 32 | RW | 2524FFFFh |
| 4005C398h | TSM_TIMING42 (TIMING42) | 32 | RW | FFFFFFFFh |
| 4005C39Ch | TSM_TIMING43 (TIMING43) | 32 | RW | FFFFFFFFh |

Table continues on the next page...

| Offset | Register | Width (In bits) | Access | Reset value |
|-----------|---|--------------------|--------|-------------|
| 4005C3A0h | TSM_TIMING44 (TIMING44) | 32 | RW | FFFFFFFFh |
| 4005C3A4h | TSM_TIMING45 (TIMING45) | 32 | RW | FFFFFFFFh |
| 4005C3A8h | TSM_TIMING46 (TIMING46) | 32 | RW | FFFFFFFFh |
| 4005C3ACh | TSM_TIMING47 (TIMING47) | 32 | RW | FFFFFFFFh |
| 4005C3B0h | TSM_TIMING48 (TIMING48) | 32 | RW | FFFFFFFFh |
| 4005C3B4h | TSM_TIMING49 (TIMING49) | 32 | RW | FFFFFFFFh |
| 4005C3B8h | TSM_TIMING50 (TIMING50) | 32 | RW | FFFFFFFFh |
| 4005C3BCh | TSM_TIMING51 (TIMING51) | 32 | RW | 6703FFFFh |
| 4005C3C0h | TSM_TIMING52 (TIMING52) | 32 | RW | 1504FFFFh |
| 4005C3C4h | TSM_TIMING53 (TIMING53) | 32 | RW | 6704FFFFh |
| 4005C3C8h | TSM_TIMING54 (TIMING54) | 32 | RW | 1504FFFFh |
| 4005C3CCh | TSM_TIMING55 (TIMING55) | 32 | RW | 671EFFFFh |
| 4005C3D0h | TSM_TIMING56 (TIMING56) | 32 | RW | 671EFFFFh |
| 4005C3D4h | TSM_TIMING57 (TIMING57) | 32 | RW | 1A03FFFFh |
| 4005C3D8h | TSM_TIMING58 (TIMING58) | 32 | RW | FFFF6A03h |

45.4.5.3.1.2 TRANSCEIVER SEQUENCE MANAGER CONTROL (CTRL)

45.4.5.3.1.2.1 Address

| Register | Offset |
|----------|-----------|
| CTRL | 4005C2C0h |

FSK Modulator

45.4.5.3.1.2.2 Diagram

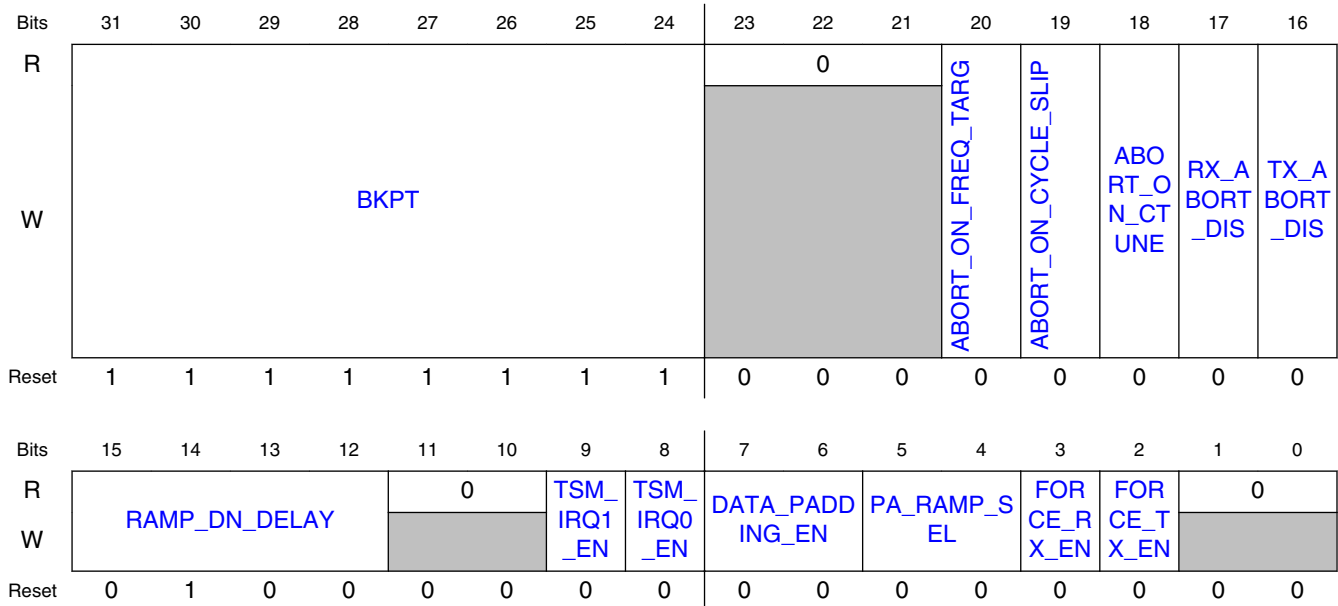

45.4.5.3.1.2.3 Fields

| Field | Function |
|---------------------------|--|
| 31-24 BKPT | TSM Breakpoint Temporarily halt a TSM sequence during the warmup or warmdown phase. When the TSM counter matches the value of BKPT[7:0], breakpoint will take effect and the TSM counter will stop and hold its count. Breakpoint will remain in effect as long as BKPT[7:0] matches the TSM counter value. The TSM Breakpoint can be lifted by modifying the contents of this register. The default value of this register, 0xFF, is greater than the length of the longest possible sequence, so a breakpoint will never be triggered unless BKPT[7:0] is programmed to a value less than the length of sequence. |
| 23-21 — | Reserved |
| 20 ABORT_ON_FREQ_TARG | Abort On Frequency Target Lock Detect Failure 0b - don't allow TSM abort on Frequency Target Unlock Detect 1b - allow TSM abort on Frequency Target Unlock Detect |
| 19 ABORT_ON_CYCLE_SLIP | Abort On Cycle Slip Lock Detect Failure 0b - don't allow TSM abort on Cycle Slip Unlock Detect 1b - allow TSM abort on Cycle Slip Unlock Detect |
| 18 ABORT_ON_CTUNE | Abort On Coarse Tune Lock Detect Failure 0b - don't allow TSM abort on Coarse Tune Unlock Detect 1b - allow TSM abort on Coarse Tune Unlock Detect |
| 17 RX_ABORT_DIS | Receive Abort Disable RX Abort disable. When set, prevents PLL unlock events during RX sequences from aborting the sequence. |
| 16 | Transmit Abort Disable |

Table continues on the next page...

| Field | Function | | | | | | | | | | | | | | | |
|------------------------|---|----------------------------|---------------------|----------------------------|----|---------|---------|----|-----|--------|----|-----|-------|----|-----|-----|
| TX_ABORT_DISABLE | TX Abort disable. When set, prevents PLL unlock events during TX sequences from aborting the sequence. | | | | | | | | | | | | | | | |
| 15-12 RAMP_DN_DELAY | PA Ramp Down Delay Delays the start of the PA Ramp Down, relative to the start of the TSM warmdown, by <i>N</i> microseconds, where <i>N</i> =RAMP_DN_DELAY. Range is 0 to 15us. | | | | | | | | | | | | | | | |
| 11-10 — | Reserved | | | | | | | | | | | | | | | |
| 9 TSM_IRQ1_EN | TSM_IRQ1 Enable/Disable bit TSM_IRQ1 Enable/Disable bit. Intended for debug purposes only. 0b - TSM_IRQ1 is disabled 1b - TSM_IRQ1 is enabled | | | | | | | | | | | | | | | |
| 8 TSM_IRQ0_EN | TSM_IRQ0 Enable/Disable bit TSM_IRQ0 Enable/Disable bit. Intended for debug purposes only. 0b - TSM_IRQ0 is disabled 1b - TSM_IRQ0 is enabled | | | | | | | | | | | | | | | |
| 7-6 DATA_PADDING_EN | Data Padding Enable Enables TX Data Padding. Data padding works in conjunction with PA ramping to minimize spectral transients during PA turn-on and turn-off. The nature of the data padding depends on the setting of XCVR_CTRL[PROTOCOL]. NOTE: Data Padding is not supported for Generic FSK modulations 00b - Disable TX Data Padding 01b - Enable TX Data Padding | | | | | | | | | | | | | | | |
| 5-4 PA_RAMP_SEL | PA Ramp Selection Selects the ramp-rate, and thus the duration, for PA ramping. Ramp-rate is the rate at which the PA ramping logic steps through the PA Ramp Table. There are always 8 ramp steps, if ramping is enabled. NOTE: The default TSM TX sequence needs to be adjusted (re-programmed) for a 4us or 8us ramp. <table border="1" data-bbox="337 1176 1455 1413"> <thead> <tr> <th>PA_RAMP_SEL[1:0]</th> <th>TOTAL RAMP DURATION</th> <th>DURATION OF EACH RAMP STEP</th> </tr> </thead> <tbody> <tr> <td>00</td> <td>No ramp</td> <td>No ramp</td> </tr> <tr> <td>01</td> <td>2us</td> <td>0.25us</td> </tr> <tr> <td>10</td> <td>4us</td> <td>0.5us</td> </tr> <tr> <td>11</td> <td>8us</td> <td>1us</td> </tr> </tbody> </table> | PA_RAMP_SEL[1:0] | TOTAL RAMP DURATION | DURATION OF EACH RAMP STEP | 00 | No ramp | No ramp | 01 | 2us | 0.25us | 10 | 4us | 0.5us | 11 | 8us | 1us |
| PA_RAMP_SEL[1:0] | TOTAL RAMP DURATION | DURATION OF EACH RAMP STEP | | | | | | | | | | | | | | |
| 00 | No ramp | No ramp | | | | | | | | | | | | | | |
| 01 | 2us | 0.25us | | | | | | | | | | | | | | |
| 10 | 4us | 0.5us | | | | | | | | | | | | | | |
| 11 | 8us | 1us | | | | | | | | | | | | | | |
| 3 FORCE_RX_EN | Force Receive Enable Direct software control to launch a RX TSM sequence. Initiates RX Warmup on a 0 to 1 transition and RX Warmdown on a 1 to 0 transition. 0b - TSM Idle 1b - TSM executes a RX sequence | | | | | | | | | | | | | | | |
| 2 FORCE_TX_EN | Force Transmit Enable Direct software control to launch a TX TSM sequence. Initiates a TX Warmup sequence on a 0 to 1 transition and a TX Warmdown sequence on a 1 to 0 transition. 0b - TSM Idle 1b - TSM executes a TX sequence | | | | | | | | | | | | | | | |
| 1-0 | Reserved | | | | | | | | | | | | | | | |

FSK Modulator

| Field | Function |
|-------|----------|
| — | |

45.4.5.3.1.3 TSM END OF SEQUENCE (END_OF_SEQ)

45.4.5.3.1.3.1 Address

| Register | Offset |
|------------|-----------|
| END_OF_SEQ | 4005C2C4h |

45.4.5.3.1.3.2 Diagram

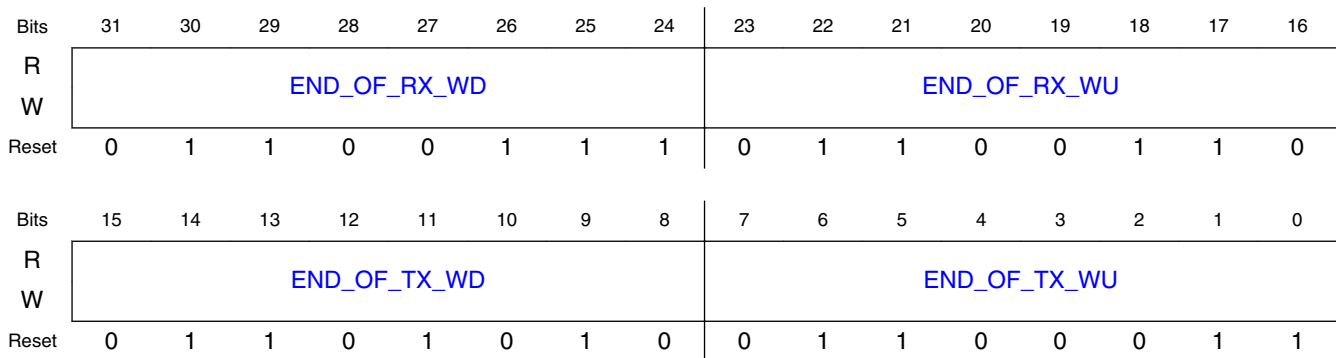

45.4.5.3.1.3.3 Fields

| Field | Function |
|-----------------------|---|
| 31-24 END_OF_RX_WD | End of RX Warmdown This register defines the point at which the TSM RX sequence warmdown completes, and the TSM returns to idle. The duration of the TSM warmdown phase is determined by: END_OF_RX_WD – END_OF_RX_WU. |
| 23-16 END_OF_RX_WU | End of RX Warmup This register defines the length of the TSM RX warmup sequence. After the assertion of a RX sequence-initiating event, when the TSM counter reaches the count matching this register, it will stop and hold its count, and the TSM will transition from the WARMUP to the ON phase. |
| 15-8 END_OF_TX_WD | End of TX Warmdown This register defines the point at which the TSM TX sequence warmdown completes, and the TSM returns to idle. The duration of the TSM warmdown phase is determined by: END_OF_TX_WD – END_OF_TX_WU. |
| 7-0 END_OF_TX_WU | End of TX Warmup This register defines the length of the TSM TX warmup sequence. After the assertion of a TX sequence-initiating event, when the TSM counter reaches the count matching this register, it will stop and hold its count, and the TSM will transition from the WARMUP to the ON phase. |

45.4.5.3.1.4 TSM OVERRIDE REGISTER 0 (OVRD0)

45.4.5.3.1.4.1 Address

| Register | Offset |
|----------|-----------|
| OVRD0 | 4005C2C8h |

45.4.5.3.1.4.2 Diagram

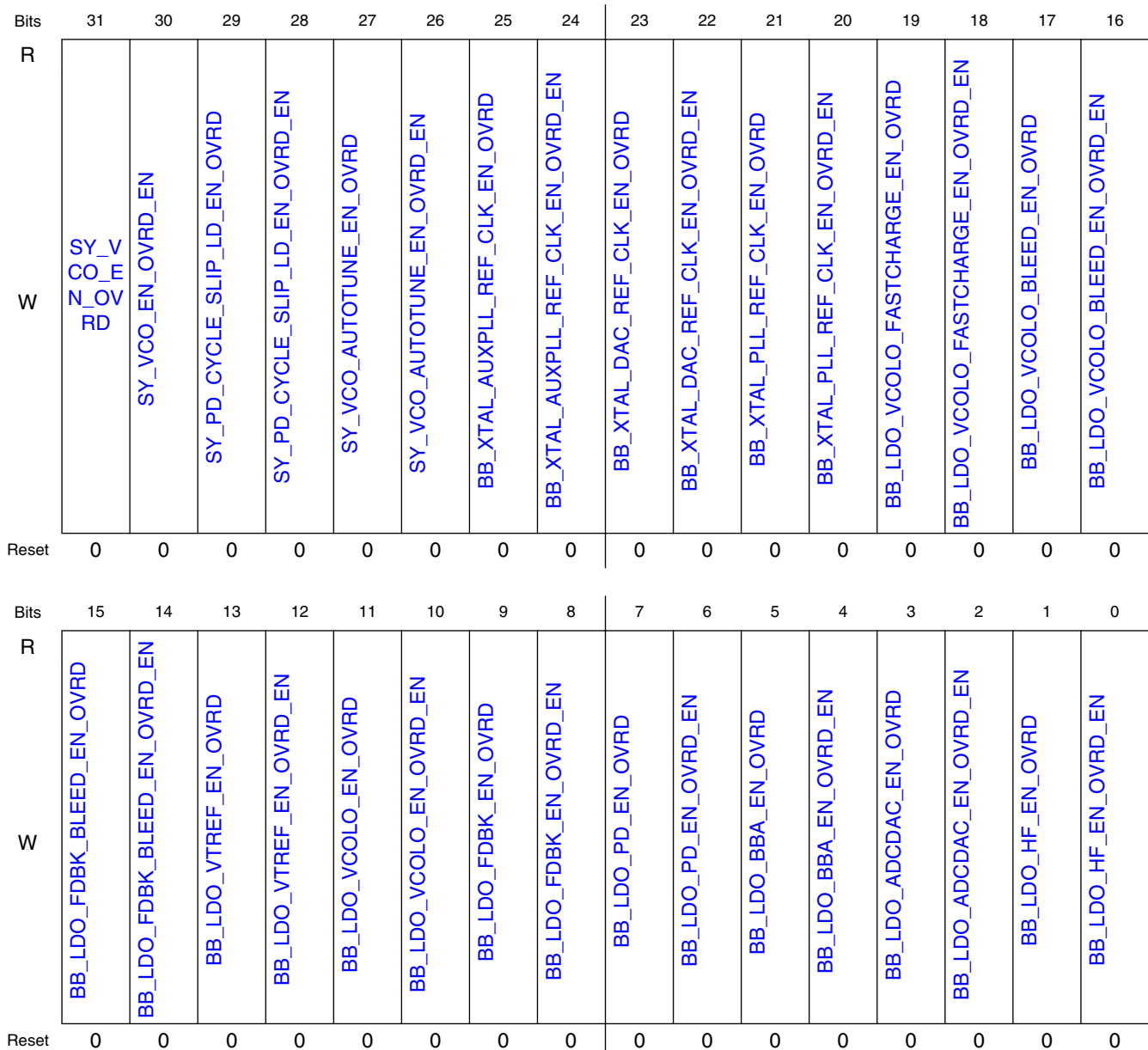

45.4.5.3.1.4.3 Fields

| Field | Function |
|---|---|
| 31 SY_VCO_EN_OVRD | Override value for SY_VCO_EN When SY_VCO_EN_OVRD_EN=1, this value overrides the mission mode state of the signal "sy_vco_en". This bit is ignored when SY_VCO_EN_OVRD_EN==0. |
| 30 SY_VCO_EN_OVRD_EN | Override control for SY_VCO_EN 0b - Normal operation. 1b - Use the state of SY_VCO_EN_OVRD to override the signal "sy_vco_en". |
| 29 SY_PD_CYCLE_SLIP_LD_EN_OVRD | Override value for SY_PD_CYCLE_SLIP_LD_EN When SY_PD_CYCLE_SLIP_LD_EN_OVRD_EN=1, this value overrides the mission mode state of the signal "sy_pd_cycle_slip_ld_en". This bit is ignored when SY_PD_CYCLE_SLIP_LD_EN_OVRD_EN==0. |
| 28 SY_PD_CYCLE_SLIP_LD_EN_OVRD_EN | Override control for SY_PD_CYCLE_SLIP_LD_EN 0b - Normal operation. 1b - Use the state of SY_PD_CYCLE_SLIP_LD_EN_OVRD to override the signal "sy_pd_cycle_slip_ld_en". |
| 27 SY_VCO_AUTOTUNE_EN_OVRD | Override value for SY_VCO_AUTOTUNE_EN When SY_VCO_AUTOTUNE_EN_OVRD_EN=1, this value overrides the mission mode state of the signal "sy_vco_autotune_en". This bit is ignored when SY_VCO_AUTOTUNE_EN_OVRD_EN==0. |
| 26 SY_VCO_AUTOTUNE_EN_OVRD_EN | Override control for SY_VCO_AUTOTUNE_EN 0b - Normal operation. 1b - Use the state of SY_VCO_AUTOTUNE_EN_OVRD to override the signal "sy_vco_autotune_en". |
| 25 BB_XTAL_AUXPLL_REF_CLK_EN_OVRD | Override value for BB_XTAL_AUXPLL_REF_CLK_EN When BB_XTAL_AUXPLL_REF_CLK_EN_OVRD_EN=1, this value overrides the mission mode state of the signal "bb_xtal_auxpll_ref_clk_en". This bit is ignored when BB_XTAL_AUXPLL_REF_CLK_EN_OVRD_EN==0. |
| 24 BB_XTAL_AUXPLL_REF_CLK_EN_OVRD_EN | Override control for BB_XTAL_AUXPLL_REF_CLK_EN 0b - Normal operation. 1b - Use the state of BB_XTAL_AUXPLL_REF_CLK_EN_OVRD to override the signal "bb_xtal_auxpll_ref_clk_en". |
| 23 BB_XTAL_DAC_REF_CLK_EN_OVRD | Override value for BB_XTAL_DAC_REF_CLK_EN When BB_XTAL_DAC_REF_CLK_EN_OVRD_EN=1, this value overrides the mission mode state of the signal "bb_xtal_dac_ref_clk_en". This bit is ignored when BB_XTAL_DAC_REF_CLK_EN_OVRD_EN==0. |
| 22 BB_XTAL_DAC_REF_CLK_EN_OVRD_EN | Override control for BB_XTAL_DAC_REF_CLK_EN 0b - Normal operation. 1b - Use the state of BB_XTAL_DAC_REF_CLK_EN_OVRD to override the signal "bb_xtal_dac_ref_clk_en". |
| 21 BB_XTAL_PLL_REF_CLK_EN_OVRD | Override value for BB_XTAL_PLL_REF_CLK_EN When BB_XTAL_PLL_REF_CLK_EN_OVRD_EN=1, this value overrides the mission mode state of the signal "bb_xtal_pll_ref_clk_en". This bit is ignored when BB_XTAL_PLL_REF_CLK_EN_OVRD_EN==0. |
| 20 | Override control for BB_XTAL_PLL_REF_CLK_EN |

Table continues on the next page...

| Field | Function |
|--|---|
| BB_XTAL_PLL_REF_CLK_EN_OVRD_EN | 0b - Normal operation. 1b - Use the state of BB_XTAL_PLL_REF_CLK_EN_OVRD to override the signal "bb_xtal_pll_ref_clk_en". |
| 19 BB_LDO_VCOLO_FASTCHARGE_EN_OVRD | Override value for BB_LDO_VCOLO_FASTCHARGE_EN When BB_LDO_VCOLO_FASTCHARGE_EN_OVRD_EN=1, this value overrides the mission mode state of the signal "bb_ldo_vcolo_fastcharge_en". This bit is ignored when BB_LDO_VCOLO_FASTCHARGE_EN_OVRD_EN==0. |
| 18 BB_LDO_VCOLO_FASTCHARGE_EN_OVRD_EN | Override control for BB_LDO_VCOLO_FASTCHARGE_EN 0b - Normal operation. 1b - Use the state of BB_LDO_VCOLO_FASTCHARGE_EN_OVRD to override the signal "bb_ldo_vcolo_fastcharge_en". |
| 17 BB_LDO_VCOLO_BLEED_EN_OVRD | Override value for BB_LDO_VCOLO_BLEED_EN When BB_LDO_VCOLO_BLEED_EN_OVRD_EN=1, this value overrides the mission mode state of the signal "bb_ldo_vcolo_bleed_en". This bit is ignored when BB_LDO_VCOLO_BLEED_EN_OVRD_EN==0. |
| 16 BB_LDO_VCOLO_BLEED_EN_OVRD_EN | Override control for BB_LDO_VCOLO_BLEED_EN 0b - Normal operation. 1b - Use the state of BB_LDO_VCOLO_BLEED_EN_OVRD to override the signal "bb_ldo_vcolo_bleed_en". |
| 15 BB_LDO_FDBK_BLEED_EN_OVRD | Override value for BB_LDO_FDBK_BLEED_EN When BB_LDO_FDBK_BLEED_EN_OVRD_EN=1, this value overrides the mission mode state of the signal "bb_ldo_fdbk_bleed_en". This bit is ignored when BB_LDO_FDBK_BLEED_EN_OVRD_EN==0. |
| 14 BB_LDO_FDBK_BLEED_EN_OVRD_EN | Override control for BB_LDO_FDBK_BLEED_EN 0b - Normal operation. 1b - Use the state of BB_LDO_FDBK_BLEED_EN_OVRD to override the signal "bb_ldo_fdbk_bleed_en". |
| 13 BB_LDO_VTREF_EN_OVRD | Override value for BB_LDO_VTREF_EN When BB_LDO_VTREF_EN_OVRD_EN=1, this value overrides the mission mode state of the signal "bb_ldo_vtref_en". This bit is ignored when BB_LDO_VTREF_EN_OVRD_EN==0. |
| 12 BB_LDO_VTREF_EN_OVRD_EN | Override control for BB_LDO_VTREF_EN 0b - Normal operation. 1b - Use the state of BB_LDO_VTREF_EN_OVRD to override the signal "bb_ldo_vtref_en". |
| 11 BB_LDO_VCOLO_EN_OVRD | Override value for BB_LDO_VCOLO_EN When BB_LDO_VCOLO_EN_OVRD_EN=1, this value overrides the mission mode state of the signal "bb_ldo_vcolo_en". This bit is ignored when BB_LDO_VCOLO_EN_OVRD_EN==0. |
| 10 BB_LDO_VCOLO_EN_OVRD_EN | Override control for BB_LDO_VCOLO_EN 0b - Normal operation. 1b - Use the state of BB_LDO_VCOLO_EN_OVRD to override the signal "bb_ldo_vcolo_en". |
| 9 BB_LDO_FDBK_EN_OVRD | Override value for BB_LDO_FDBK_EN When BB_LDO_FDBK_EN_OVRD_EN=1, this value overrides the mission mode state of the signal "bb_ldo_fdbk_en". This bit is ignored when BB_LDO_FDBK_EN_OVRD_EN==0. |
| 8 | Override control for BB_LDO_FDBK_EN 0b - Normal operation. |

Table continues on the next page...

FSK Modulator

| Field | Function |
|--------------------------------|---|
| BB_LDO_FDBK_EN_OVRD_EN | 1b - Use the state of BB_LDO_FDBK_EN_OVRD to override the signal "bb_ldo_fdbk_en". |
| 7 BB_LDO_PD_EN_OVRD | Override value for BB_LDO_PD_EN When BB_LDO_PD_EN_OVRD_EN=1, this value overrides the mission mode state of the signal "bb_ldo_pd_en". This bit is ignored when BB_LDO_PD_EN_OVRD_EN==0. |
| 6 BB_LDO_PD_EN_OVRD_EN | Override control for BB_LDO_PD_EN 0b - Normal operation. 1b - Use the state of BB_LDO_PD_EN_OVRD to override the signal "bb_ldo_pd_en". |
| 5 BB_LDO_BBA_EN_OVRD | Override value for BB_LDO_BBA_EN When BB_LDO_BBA_EN_OVRD_EN=1, this value overrides the mission mode state of the signal "bb_ldo_bba_en". This bit is ignored when BB_LDO_BBA_EN_OVRD_EN==0. |
| 4 BB_LDO_BBA_EN_OVRD_EN | Override control for BB_LDO_BBA_EN 0b - Normal operation. 1b - Use the state of BB_LDO_BBA_EN_OVRD to override the signal "bb_ldo_bba_en". |
| 3 BB_LDO_ADCCDAC_EN_OVRD | Override value for BB_LDO_ADCCDAC_EN When BB_LDO_ADCCDAC_EN_OVRD_EN=1, this value overrides the mission mode state of the signal "bb_ldo_adccdac_en". This bit is ignored when BB_LDO_ADCCDAC_EN_OVRD_EN==0. |
| 2 BB_LDO_ADCCDAC_EN_OVRD_EN | Override control for BB_LDO_ADCCDAC_EN 0b - Normal operation. 1b - Use the state of BB_LDO_ADCCDAC_EN_OVRD to override the signal "bb_ldo_adccdac_en". |
| 1 BB_LDO_HF_EN_OVRD | Override value for BB_LDO_HF_EN When BB_LDO_HF_EN_OVRD_EN=1, this value overrides the mission mode state of the signal "bb_ldo_hf_en". This bit is ignored when BB_LDO_HF_EN_OVRD_EN==0. |
| 0 BB_LDO_HF_EN_OVRD_EN | Override control for BB_LDO_HF_EN 0b - Normal operation. 1b - Use the state of BB_LDO_HF_EN_OVRD to override the signal "bb_ldo_hf_en". |

45.4.5.3.1.5 TSM OVERRIDE REGISTER 1 (OVRD1)

45.4.5.3.1.5.1 Address

| Register | Offset |
|----------|-----------|
| OVRD1 | 4005C2CCh |

45.4.5.3.1.5.2 Diagram

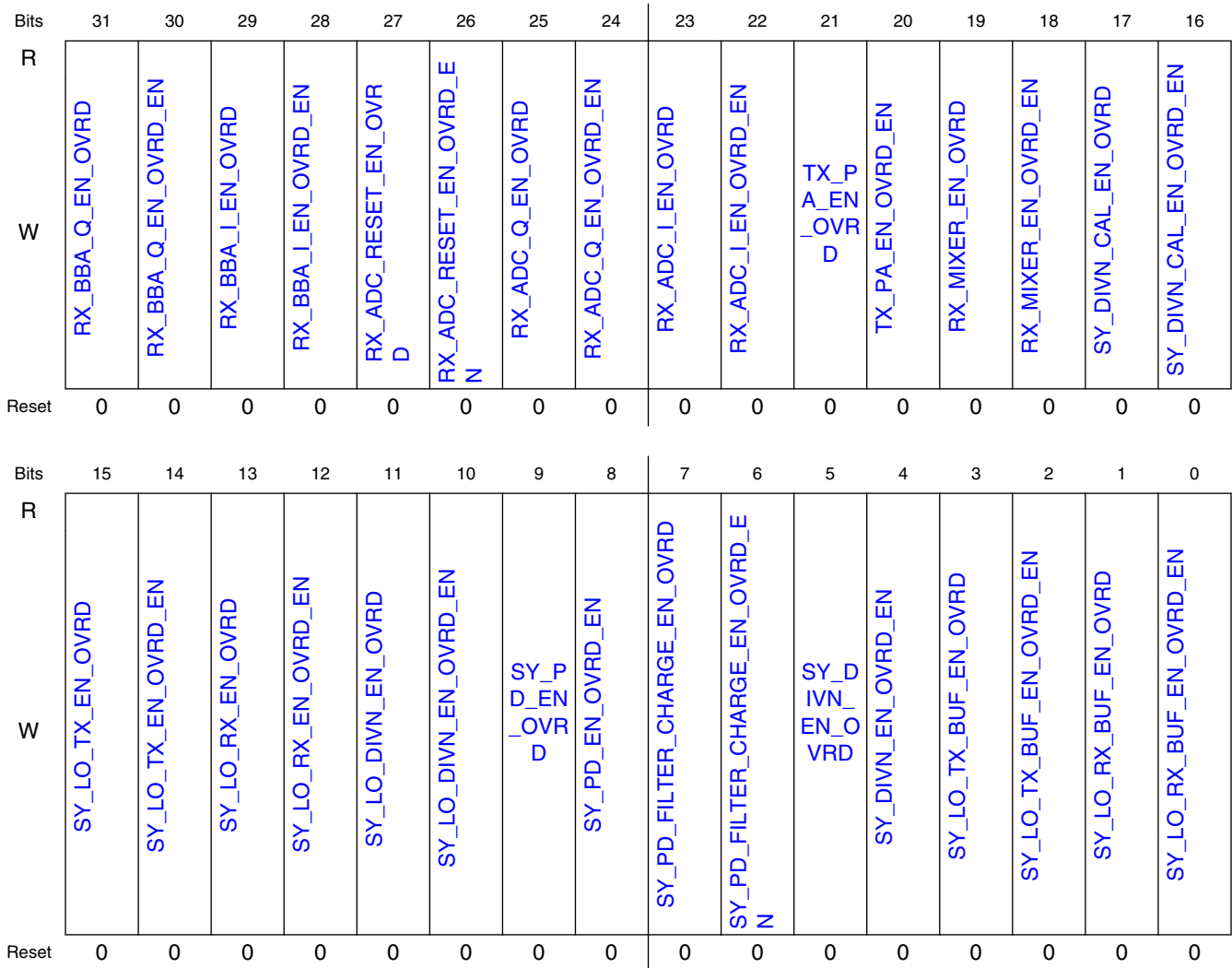

45.4.5.3.1.5.3 Fields

| Field | Function |
|---------------------------|---|
| 31 RX_BBA_Q_EN_OVRD | Override value for RX_BBA_Q_EN When RX_BBA_Q_EN_OVRD_EN=1, this value overrides the mission mode state of the signal "rx_bba_q_en". This bit is ignored when RX_BBA_Q_EN_OVRD_EN==0. |
| 30 RX_BBA_Q_EN_OVRD_EN | Override control for RX_BBA_Q_EN 0b - Normal operation. 1b - Use the state of RX_BBA_Q_EN_OVRD to override the signal "rx_bba_q_en". |
| 29 RX_BBA_I_EN_OVRD | Override value for RX_BBA_I_EN When RX_BBA_I_EN_OVRD_EN=1, this value overrides the mission mode state of the signal "rx_bba_i_en". This bit is ignored when RX_BBA_I_EN_OVRD_EN==0. |
| 28 | Override control for RX_BBA_I_EN 0b - Normal operation. |

Table continues on the next page...

FSK Modulator

| Field | Function |
|-------------------------|---|
| RX_BBA_I_EN_OVRD_EN | 1b - Use the state of RX_BBA_I_EN_OVRD to override the signal "rx_bba_i_en". |
| 27 | Override value for RX_ADC_RESET_EN |
| RX_ADC_RESET_EN_OVRD | When RX_ADC_RESET_EN_OVRD_EN=1, this value overrides the mission mode state of the signal "rx_adc_reset_en". This bit is ignored when RX_ADC_RESET_EN_OVRD_EN==0. |
| 26 | Override control for RX_ADC_RESET_EN |
| RX_ADC_RESET_EN_OVRD_EN | 0b - Normal operation. 1b - Use the state of RX_ADC_RESET_EN_OVRD to override the signal "rx_adc_reset_en". |
| 25 | Override value for RX_ADC_Q_EN |
| RX_ADC_Q_EN_OVRD | When RX_ADC_Q_EN_OVRD_EN=1, this value overrides the mission mode state of the signal "rx_adc_q_en". This bit is ignored when RX_ADC_Q_EN_OVRD_EN==0. |
| 24 | Override control for RX_ADC_Q_EN |
| RX_ADC_Q_EN_OVRD_EN | 0b - Normal operation. 1b - Use the state of RX_ADC_Q_EN_OVRD to override the signal "rx_adc_q_en". |
| 23 | Override value for RX_ADC_I_EN |
| RX_ADC_I_EN_OVRD | When RX_ADC_I_EN_OVRD_EN=1, this value overrides the mission mode state of the signal "rx_adc_i_en". This bit is ignored when RX_ADC_I_EN_OVRD_EN==0. |
| 22 | Override control for RX_ADC_I_EN |
| RX_ADC_I_EN_OVRD_EN | 0b - Normal operation. 1b - Use the state of RX_ADC_I_EN_OVRD to override the signal "rx_adc_i_en". |
| 21 | Override value for TX_PA_EN |
| TX_PA_EN_OVRD | When TX_PA_EN_OVRD_EN=1, this value overrides the mission mode state of the signal "tx_pa_en". This bit is ignored when TX_PA_EN_OVRD_EN==0. |
| 20 | Override control for TX_PA_EN |
| TX_PA_EN_OVRD_EN | 0b - Normal operation. 1b - Use the state of TX_PA_EN_OVRD to override the signal "tx_pa_en". |
| 19 | Override value for RX_MIXER_EN |
| RX_MIXER_EN_OVRD | When RX_MIXER_EN_OVRD_EN=1, this value overrides the mission mode state of the signal "rx_mixer_en". This bit is ignored when RX_MIXER_EN_OVRD_EN==0. |
| 18 | Override control for RX_MIXER_EN |
| RX_MIXER_EN_OVRD_EN | 0b - Normal operation. 1b - Use the state of RX_MIXER_EN_OVRD to override the signal "rx_mixer_en". |
| 17 | Override value for SY_DIVN_CAL_EN |
| SY_DIVN_CAL_EN_OVRD | When SY_DIVN_CAL_EN_OVRD_EN=1, this value overrides the mission mode state of the signal "sy_divn_cal_en". This bit is ignored when SY_DIVN_CAL_EN_OVRD_EN==0. |
| 16 | Override control for SY_DIVN_CAL_EN |
| SY_DIVN_CAL_EN_OVRD_EN | 0b - Normal operation. 1b - Use the state of SY_DIVN_CAL_EN_OVRD to override the signal "sy_divn_cal_en". |
| 15 | Override value for SY_LO_TX_EN |
| SY_LO_TX_EN_OVRD | When SY_LO_TX_EN_OVRD_EN=1, this value overrides the mission mode state of the signal "sy_lo_tx_en". This bit is ignored when SY_LO_TX_EN_OVRD_EN==0. |
| 14 | Override control for SY_LO_TX_EN |
| SY_LO_TX_EN_OVRD_EN | 0b - Normal operation. 1b - Use the state of SY_LO_TX_EN_OVRD to override the signal "sy_lo_tx_en". |

Table continues on the next page...

| Field | Function |
|-------------------------------------|---|
| 13 SY_LO_RX_EN_OVRD | Override value for SY_LO_RX_EN When SY_LO_RX_EN_OVRD_EN=1, this value overrides the mission mode state of the signal "sy_lo_rx_en". This bit is ignored when SY_LO_RX_EN_OVRD_EN==0. |
| 12 SY_LO_RX_EN_OVRD_EN | Override control for SY_LO_RX_EN 0b - Normal operation. 1b - Use the state of SY_LO_RX_EN_OVRD to override the signal "sy_lo_rx_en". |
| 11 SY_LO_DIVN_EN_OVRD | Override value for SY_LO_DIVN_EN When SY_LO_DIVN_EN_OVRD_EN=1, this value overrides the mission mode state of the signal "sy_lo_divn_en". This bit is ignored when SY_LO_DIVN_EN_OVRD_EN==0. |
| 10 SY_LO_DIVN_EN_OVRD_EN | Override control for SY_LO_DIVN_EN 0b - Normal operation. 1b - Use the state of SY_LO_DIVN_EN_OVRD to override the signal "sy_lo_divn_en". |
| 9 SY_PD_EN_OVRD | Override value for SY_PD_EN When SY_PD_EN_OVRD_EN=1, this value overrides the mission mode state of the signal "sy_pd_en". This bit is ignored when SY_PD_EN_OVRD_EN==0. |
| 8 SY_PD_EN_OVRD_EN | Override control for SY_PD_EN 0b - Normal operation. 1b - Use the state of SY_PD_EN_OVRD to override the signal "sy_pd_en". |
| 7 SY_PD_FILTER_CHARGE_EN_OVRD | Override value for SY_PD_FILTER_CHARGE_EN When SY_PD_FILTER_CHARGE_EN_OVRD_EN=1, this value overrides the mission mode state of the signal "sy_pd_filter_charge_en". This bit is ignored when SY_PD_FILTER_CHARGE_EN_OVRD_EN==0. |
| 6 SY_PD_FILTER_CHARGE_EN_OVRD_EN | Override control for SY_PD_FILTER_CHARGE_EN 0b - Normal operation. 1b - Use the state of SY_PD_FILTER_CHARGE_EN_OVRD to override the signal "sy_pd_filter_charge_en". |
| 5 SY_DIVN_EN_OVRD | Override value for SY_DIVN_EN When SY_DIVN_EN_OVRD_EN=1, this value overrides the mission mode state of the signal "sy_divn_en". This bit is ignored when SY_DIVN_EN_OVRD_EN==0. |
| 4 SY_DIVN_EN_OVRD_EN | Override control for SY_DIVN_EN 0b - Normal operation. 1b - Use the state of SY_DIVN_EN_OVRD to override the signal "sy_divn_en". |
| 3 SY_LO_TX_BUF_EN_OVRD | Override value for SY_LO_TX_BUF_EN When SY_LO_TX_BUF_EN_OVRD_EN=1, this value overrides the mission mode state of the signal "sy_lo_tx_buf_en". This bit is ignored when SY_LO_TX_BUF_EN_OVRD_EN==0. |
| 2 SY_LO_TX_BUF_EN_OVRD_EN | Override control for SY_LO_TX_BUF_EN 0b - Normal operation. 1b - Use the state of SY_LO_TX_BUF_EN_OVRD to override the signal "sy_lo_tx_buf_en". |
| 1 SY_LO_RX_BUF_EN_OVRD | Override value for SY_LO_RX_BUF_EN When SY_LO_RX_BUF_EN_OVRD_EN=1, this value overrides the mission mode state of the signal "sy_lo_rx_buf_en". This bit is ignored when SY_LO_RX_BUF_EN_OVRD_EN==0. |
| 0 SY_LO_RX_BUF_EN_OVRD_EN | Override control for SY_LO_RX_BUF_EN 0b - Normal operation. 1b - Use the state of SY_LO_RX_BUF_EN_OVRD to override the signal "sy_lo_rx_buf_en". |

45.4.5.3.1.6 TSM OVERRIDE REGISTER 2 (OVRD2)

45.4.5.3.1.6.1 Address

| Register | Offset |
|----------|-----------|
| OVRD2 | 4005C2D0h |

45.4.5.3.1.6.2 Diagram

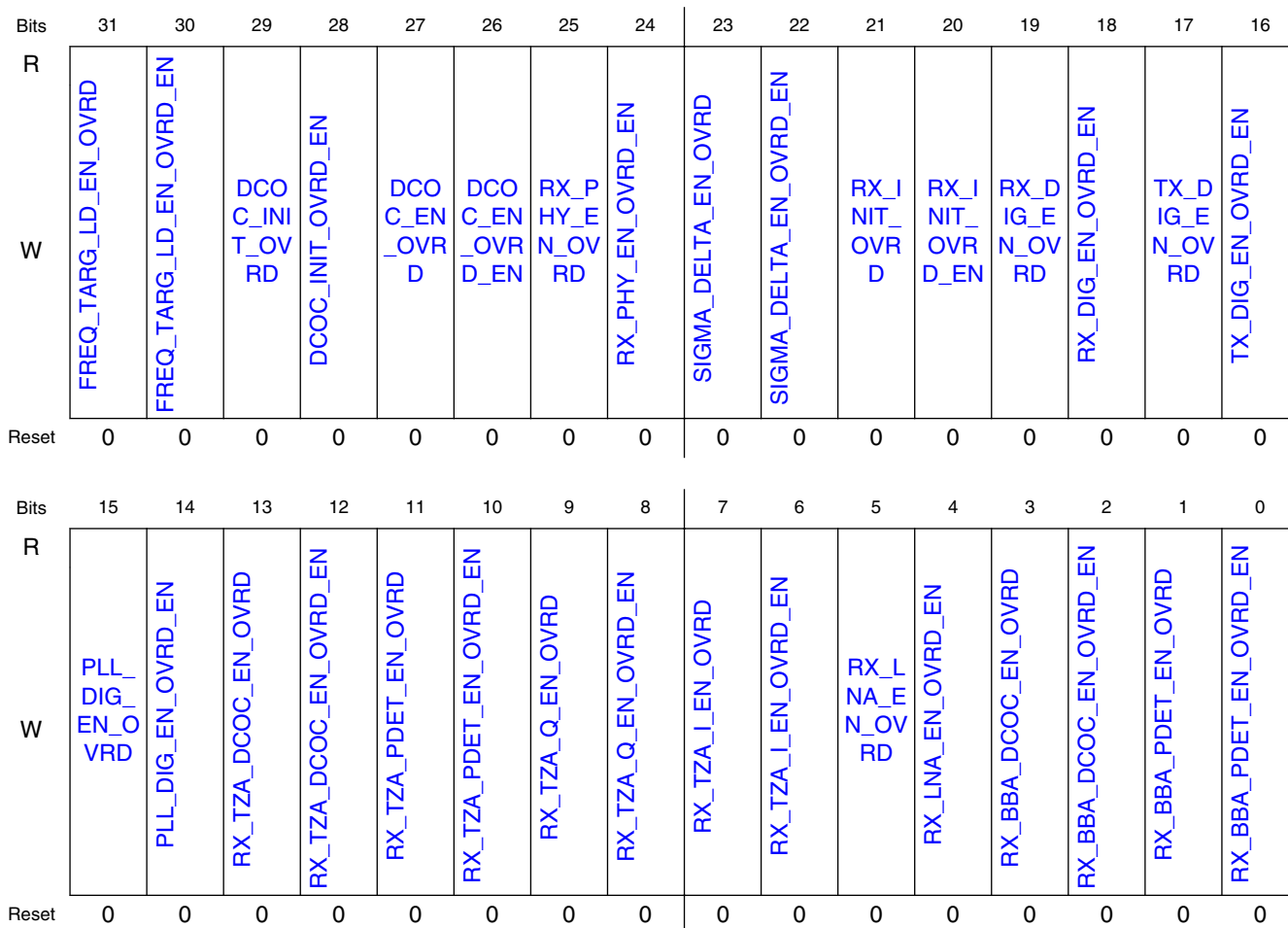

45.4.5.3.1.6.3 Fields

| Field | Function |
|-------|------------------------------------|
| 31 | Override value for FREQ_TARG_LD_EN |

Table continues on the next page...

| Field | Function |
|-------------------------------|---|
| FREQ_TARG_LD_EN_OVRD | When FREQ_TARG_LD_EN_OVRD_EN=1, this value overrides the mission mode state of the signal "freq_targ_ld_en". This bit is ignored when FREQ_TARG_LD_EN_OVRD_EN==0. |
| 30 FREQ_TARG_LD_EN_OVRD_EN | Override control for FREQ_TARG_LD_EN 0b - Normal operation. 1b - Use the state of FREQ_TARG_LD_EN_OVRD to override the signal "freq_targ_ld_en". |
| 29 DCOC_INIT_OVRD | Override value for DCOC_INIT When DCOC_INIT_OVRD_EN=1, this value overrides the mission mode state of the signal "dcoc_init". This bit is ignored when DCOC_INIT_OVRD_EN==0. |
| 28 DCOC_INIT_OVRD_EN | Override control for DCOC_INIT 0b - Normal operation. 1b - Use the state of DCOC_INIT_OVRD to override the signal "dcoc_init". |
| 27 DCOC_EN_OVRD | Override value for DCOC_EN When DCOC_EN_OVRD_EN=1, this value overrides the mission mode state of the signal "dcoc_en". This bit is ignored when DCOC_EN_OVRD_EN==0. |
| 26 DCOC_EN_OVRD_EN | Override control for DCOC_EN 0b - Normal operation. 1b - Use the state of DCOC_EN_OVRD to override the signal "dcoc_en". |
| 25 RX_PHY_EN_OVRD | Override value for RX_PHY_EN When RX_PHY_EN_OVRD_EN=1, this value overrides the mission mode state of the signal "rx_phy_en". This bit is ignored when RX_PHY_EN_OVRD_EN==0. |
| 24 RX_PHY_EN_OVRD_EN | Override control for RX_PHY_EN 0b - Normal operation. 1b - Use the state of RX_PHY_EN_OVRD to override the signal "rx_phy_en". |
| 23 SIGMA_DELTA_EN_OVRD | Override value for SIGMA_DELTA_EN When SIGMA_DELTA_EN_OVRD_EN=1, this value overrides the mission mode state of the signal "sigma_delta_en". This bit is ignored when SIGMA_DELTA_EN_OVRD_EN==0. |
| 22 SIGMA_DELTA_EN_OVRD_EN | Override control for SIGMA_DELTA_EN 0b - Normal operation. 1b - Use the state of SIGMA_DELTA_EN_OVRD to override the signal "sigma_delta_en". |
| 21 RX_INIT_OVRD | Override value for RX_INIT When RX_INIT_OVRD_EN=1, this value overrides the mission mode state of the signal "rx_init". This bit is ignored when RX_INIT_OVRD_EN==0. |
| 20 RX_INIT_OVRD_EN | Override control for RX_INIT 0b - Normal operation. 1b - Use the state of RX_INIT_OVRD to override the signal "rx_init". |
| 19 RX_DIG_EN_OVRD | Override value for RX_DIG_EN When RX_DIG_EN_OVRD_EN=1, this value overrides the mission mode state of the signal "rx_dig_en". This bit is ignored when RX_DIG_EN_OVRD_EN==0. |
| 18 RX_DIG_EN_OVRD_EN | Override control for RX_DIG_EN 0b - Normal operation. 1b - Use the state of RX_DIG_EN_OVRD to override the signal "rx_dig_en". |
| 17 TX_DIG_EN_OVRD | Override value for TX_DIG_EN When TX_DIG_EN_OVRD_EN=1, this value overrides the mission mode state of the signal "tx_dig_en". This bit is ignored when TX_DIG_EN_OVRD_EN==0. |

Table continues on the next page...

FSK Modulator

| Field | Function |
|------------------------------|---|
| 16 TX_DIG_EN_OVRD_EN | Override control for TX_DIG_EN 0b - Normal operation. 1b - Use the state of TX_DIG_EN_OVRD to override the signal "tx_dig_en". |
| 15 PLL_DIG_EN_OVRD | Override value for PLL_DIG_EN When PLL_DIG_EN_OVRD_EN=1, this value overrides the mission mode state of the signal "pll_dig_en". This bit is ignored when PLL_DIG_EN_OVRD_EN==0. |
| 14 PLL_DIG_EN_OVRD_EN | Override control for PLL_DIG_EN 0b - Normal operation. 1b - Use the state of PLL_DIG_EN_OVRD to override the signal "pll_dig_en". |
| 13 RX_TZA_DCOC_EN_OVRD | Override control for RX_TZA_DCOC_EN 0b - Normal operation. 1b - Use the state of RX_TZA_DCOC_EN_OVRD to override the signal "rx_tza_dcoc_en". |
| 12 RX_TZA_DCOC_EN_OVRD_EN | Override control for RX_TZA_DCOC_EN 0b - Normal operation. 1b - Use the state of RX_TZA_DCOC_EN_OVRD to override the signal "rx_tza_dcoc_en". |
| 11 RX_TZA_PDET_EN_OVRD | Override value for RX_TZA_PDET_EN When RX_TZA_PDET_EN_OVRD_EN=1, this value overrides the mission mode state of the signal "rx_tza_pdet_en". This bit is ignored when RX_TZA_PDET_EN_OVRD_EN==0. |
| 10 RX_TZA_PDET_EN_OVRD_EN | Override control for RX_TZA_PDET_EN 0b - Normal operation. 1b - Use the state of RX_TZA_PDET_EN_OVRD to override the signal "rx_tza_pdet_en". |
| 9 RX_TZA_Q_EN_OVRD | Override value for RX_TZA_Q_EN When RX_TZA_Q_EN_OVRD_EN=1, this value overrides the mission mode state of the signal "rx_tza_q_en". This bit is ignored when RX_TZA_Q_EN_OVRD_EN==0. |
| 8 RX_TZA_Q_EN_OVRD_EN | Override control for RX_TZA_Q_EN 0b - Normal operation. 1b - Use the state of RX_TZA_Q_EN_OVRD to override the signal "rx_tza_q_en". |
| 7 RX_TZA_I_EN_OVRD | Override value for RX_TZA_I_EN When RX_TZA_I_EN_OVRD_EN=1, this value overrides the mission mode state of the signal "rx_tza_i_en". This bit is ignored when RX_TZA_I_EN_OVRD_EN==0. |
| 6 RX_TZA_I_EN_OVRD_EN | Override control for RX_TZA_I_EN 0b - Normal operation. 1b - Use the state of RX_TZA_I_EN_OVRD to override the signal "rx_tza_i_en". |
| 5 RX_LNA_EN_OVRD | Override value for RX_LNA_EN When RX_LNA_EN_OVRD_EN=1, this value overrides the mission mode state of the signal "rx_lna_en". This bit is ignored when RX_LNA_EN_OVRD_EN==0. |
| 4 RX_LNA_EN_OVRD_EN | Override control for RX_LNA_EN 0b - Normal operation. 1b - Use the state of RX_LNA_EN_OVRD to override the signal "rx_lna_en". |
| 3 RX_BBA_DCOC_EN_OVRD | Override value for RX_BBA_DCOC_EN When RX_BBA_DCOC_EN_OVRD_EN=1, this value overrides the mission mode state of the signal "rx_bba_dcoc_en". This bit is ignored when RX_BBA_DCOC_EN_OVRD_EN==0. |
| 2 | Override control for RX_BBA_DCOC_EN 0b - Normal operation. |

Table continues on the next page...

| Field | Function |
|------------------------|--|
| RX_BBA_DCOC_EN_OVRD_EN | 1b - Use the state of RX_BBA_DCOC_EN_OVRD to override the signal "rx_bba_dcoc_en". |
| 1 | Override value for RX_BBA_PDET_EN |
| RX_BBA_PDET_EN_OVRD | When RX_BBA_PDET_EN_OVRD_EN=1, this value overrides the mission mode state of the signal "rx_bba_pdet_en". This bit is ignored when RX_BBA_PDET_EN_OVRD_EN==0. |
| 0 | Override control for RX_BBA_PDET_EN |
| RX_BBA_PDET_EN_OVRD_EN | 0b - Normal operation. 1b - Use the state of RX_BBA_PDET_EN_OVRD to override the signal "rx_bba_pdet_en". |

45.4.5.3.1.7 TSM OVERRIDE REGISTER 3 (OVRD3)

45.4.5.3.1.7.1 Address

| Register | Offset |
|----------|-----------|
| OVRD3 | 4005C2D4h |

45.4.5.3.1.7.2 Diagram

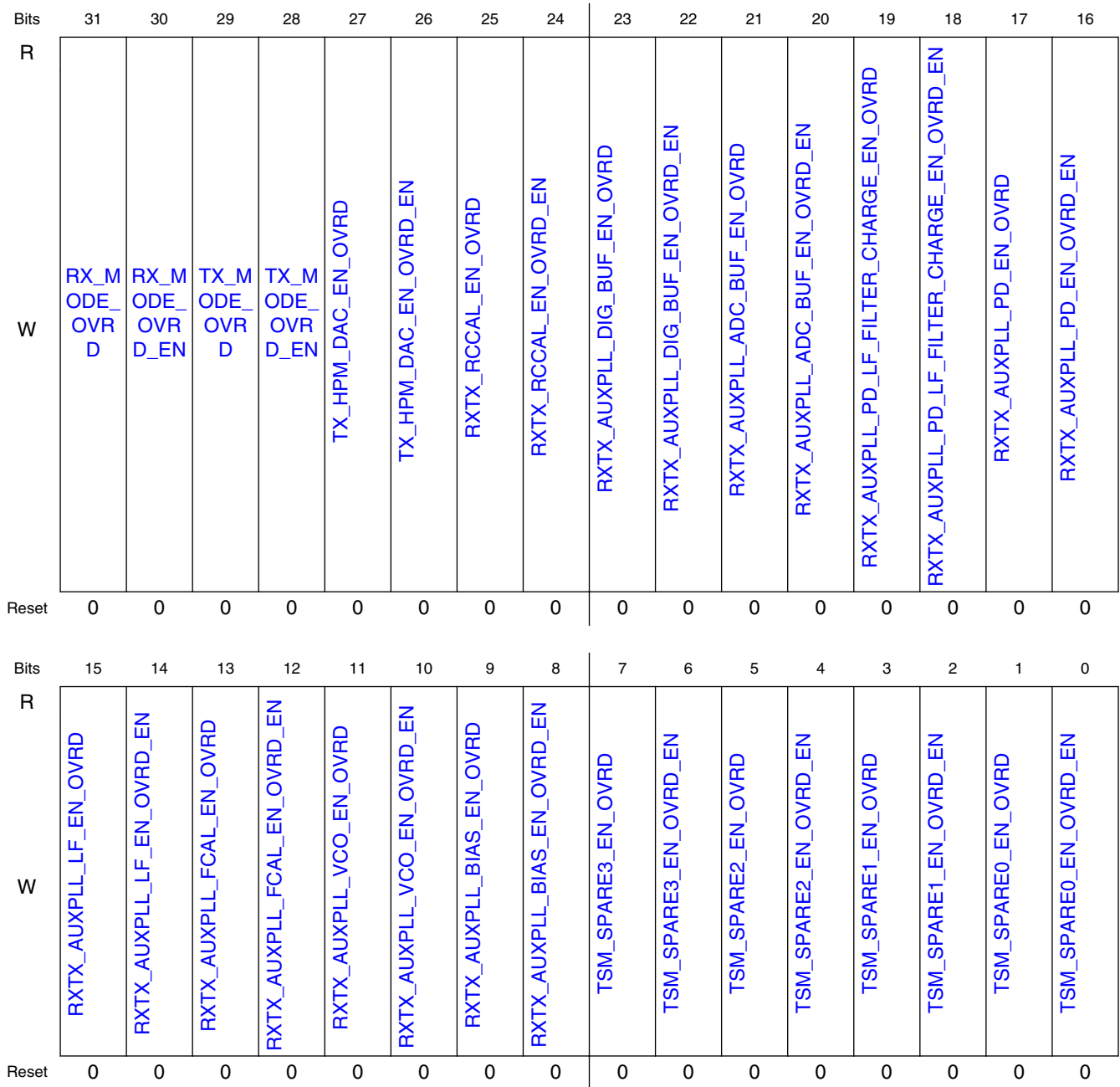

45.4.5.3.1.7.3 Fields

| Field | Function |
|--------------|---|
| 31 | Override value for RX_MODE |
| RX_MODE_OVRD | When RX_MODE_OVRD_EN=1, this value overrides the mission mode state of the signal "rx_mode". This bit is ignored when RX_MODE_OVRD_EN==0. |
| 30 | Override control for RX_MODE |

Table continues on the next page...

| Field | Function |
|--|--|
| RX_MODE_OVRD_EN | 0b - Normal operation. 1b - Use the state of RX_MODE_OVRD to override the signal "rx_mode". |
| 29 | Override value for TX_MODE |
| TX_MODE_OVRD_RD | When TX_MODE_OVRD_EN=1, this value overrides the mission mode state of the signal "tx_mode". This bit is ignored when TX_MODE_OVRD_EN==0. |
| 28 | Override control for TX_MODE |
| TX_MODE_OVRD_RD_EN | 0b - Normal operation. 1b - Use the state of TX_MODE_OVRD to override the signal "tx_mode". |
| 27 | Override value for TX_HPM_DAC_EN |
| TX_HPM_DAC_EN_OVRD | When TX_HPM_DAC_EN_OVRD_EN=1, this value overrides the mission mode state of the signal "tx_hpm_dac_en". This bit is ignored when TX_HPM_DAC_EN_OVRD_EN==0. |
| 26 | Override control for TX_HPM_DAC_EN |
| TX_HPM_DAC_EN_OVRD_EN | 0b - Normal operation. 1b - Use the state of TX_HPM_DAC_EN_OVRD to override the signal "tx_hpm_dac_en". |
| 25 | Override value for RXTX_RCCAL_EN |
| RXTX_RCCAL_EN_OVRD | When RXTX_RCCAL_EN_OVRD_EN=1, this value overrides the mission mode state of the signal "rxtx_rccal_en". This bit is ignored when RXTX_RCCAL_EN_OVRD_EN==0. |
| 24 | Override control for RXTX_RCCAL_EN |
| RXTX_RCCAL_EN_OVRD_EN | 0b - Normal operation. 1b - Use the state of RXTX_RCCAL_EN_OVRD to override the signal "rxtx_rccal_en". |
| 23 | Override value for RXTX_AUXPLL_DIG_BUF_EN |
| RXTX_AUXPLL_DIG_BUF_EN_OVRD | When RXTX_AUXPLL_DIG_BUF_EN_OVRD_EN=1, this value overrides the mission mode state of the signal "rxtx_auxpll_dig_buf_en". This bit is ignored when RXTX_AUXPLL_DIG_BUF_EN_OVRD_EN==0. |
| 22 | Override control for RXTX_AUXPLL_DIG_BUF_EN |
| RXTX_AUXPLL_DIG_BUF_EN_OVRD_EN | 0b - Normal operation. 1b - Use the state of RXTX_AUXPLL_DIG_BUF_EN_OVRD to override the signal "rxtx_auxpll_dig_buf_en". |
| 21 | Override value for RXTX_AUXPLL_ADC_BUF_EN |
| RXTX_AUXPLL_ADC_BUF_EN_OVRD | When RXTX_AUXPLL_ADC_BUF_EN_OVRD_EN=1, this value overrides the mission mode state of the signal "rxtx_auxpll_adc_buf_en". This bit is ignored when RXTX_AUXPLL_ADC_BUF_EN_OVRD_EN==0. |
| 20 | Override control for RXTX_AUXPLL_ADC_BUF_EN |
| RXTX_AUXPLL_ADC_BUF_EN_OVRD_EN | 0b - Normal operation. 1b - Use the state of RXTX_AUXPLL_ADC_BUF_EN_OVRD to override the signal "rxtx_auxpll_adc_buf_en". |
| 19 | Override value for RXTX_AUXPLL_PD_LF_FILTER_CHARGE_EN |
| RXTX_AUXPLL_PD_LF_FILTER_CHARGE_EN_OVRD | When RXTX_AUXPLL_PD_LF_FILTER_CHARGE_EN_OVRD_EN=1, this value overrides the mission mode state of the signal "rxtx_auxpll_pd_lf_filter_charge_en". This bit is ignored when RXTX_AUXPLL_PD_LF_FILTER_CHARGE_EN_OVRD_EN==0. |
| 18 | Override control for RXTX_AUXPLL_PD_LF_FILTER_CHARGE_EN |
| RXTX_AUXPLL_PD_LF_FILTER_CHARGE_EN_OVRD_EN | 0b - Normal operation. 1b - Use the state of RXTX_AUXPLL_PD_LF_FILTER_CHARGE_EN_OVRD to override the signal "rxtx_auxpll_pd_lf_filter_charge_en". |

Table continues on the next page...

FSK Modulator

| Field | Function |
|-----------------------------------|--|
| 17 RXTX_AUXPLL_PD_EN_OVRD | Override value for RXTX_AUXPLL_PD_EN When RXTX_AUXPLL_PD_EN_OVRD_EN=1, this value overrides the mission mode state of the signal "rxtx_auxpll_pd_en". This bit is ignored when RXTX_AUXPLL_PD_EN_OVRD_EN==0. |
| 16 RXTX_AUXPLL_PD_EN_OVRD_EN | Override control for RXTX_AUXPLL_PD_EN 0b - Normal operation. 1b - Use the state of RXTX_AUXPLL_PD_EN_OVRD to override the signal "rxtx_auxpll_pd_en". |
| 15 RXTX_AUXPLL_LF_EN_OVRD | Override value for RXTX_AUXPLL_LF_EN When RXTX_AUXPLL_LF_EN_OVRD_EN=1, this value overrides the mission mode state of the signal "rxtx_auxpll_lf_en". This bit is ignored when RXTX_AUXPLL_LF_EN_OVRD_EN==0. |
| 14 RXTX_AUXPLL_LF_EN_OVRD_EN | Override control for RXTX_AUXPLL_LF_EN 0b - Normal operation. 1b - Use the state of RXTX_AUXPLL_LF_EN_OVRD to override the signal "rxtx_auxpll_lf_en". |
| 13 RXTX_AUXPLL_FCAL_EN_OVRD | Override value for RXTX_AUXPLL_FCAL_EN When RXTX_AUXPLL_FCAL_EN_OVRD_EN=1, this value overrides the mission mode state of the signal "rxtx_auxpll_fc_al_en". This bit is ignored when RXTX_AUXPLL_FCAL_EN_OVRD_EN==0. |
| 12 RXTX_AUXPLL_FCAL_EN_OVRD_EN | Override control for RXTX_AUXPLL_FCAL_EN 0b - Normal operation. 1b - Use the state of RXTX_AUXPLL_FCAL_EN_OVRD to override the signal "rxtx_auxpll_fc_al_en". |
| 11 RXTX_AUXPLL_VCO_EN_OVRD | Override value for RXTX_AUXPLL_VCO_EN When RXTX_AUXPLL_VCO_EN_OVRD_EN=1, this value overrides the mission mode state of the signal "rxtx_auxpll_vco_en". This bit is ignored when RXTX_AUXPLL_VCO_EN_OVRD_EN==0. |
| 10 RXTX_AUXPLL_VCO_EN_OVRD_EN | Override control for RXTX_AUXPLL_VCO_EN 0b - Normal operation. 1b - Use the state of RXTX_AUXPLL_VCO_EN_OVRD to override the signal "rxtx_auxpll_vco_en". |
| 9 RXTX_AUXPLL_BIAS_EN_OVRD | Override value for RXTX_AUXPLL_BIAS_EN When RXTX_AUXPLL_BIAS_EN_OVRD_EN=1, this value overrides the mission mode state of the signal "rxtx_auxpll_bias_en". This bit is ignored when RXTX_AUXPLL_BIAS_EN_OVRD_EN==0. |
| 8 RXTX_AUXPLL_BIAS_EN_OVRD_EN | Override control for RXTX_AUXPLL_BIAS_EN 0b - Normal operation. 1b - Use the state of RXTX_AUXPLL_BIAS_EN_OVRD to override the signal "rxtx_auxpll_bias_en". |
| 7 TSM_SPARE3_EN_OVRD | Override value for TSM_SPARE3_EN When TSM_SPARE3_EN_OVRD_EN=1, this value overrides the mission mode state of the signal "tsm_spare3_en". This bit is ignored when TSM_SPARE3_EN_OVRD_EN==0. |
| 6 TSM_SPARE3_EN_OVRD_EN | Override control for TSM_SPARE3_EN 0b - Normal operation. 1b - Use the state of TSM_SPARE3_EN_OVRD to override the signal "tsm_spare3_en". |
| 5 | Override value for TSM_SPARE2_EN |

Table continues on the next page...

| Field | Function |
|----------------------------|---|
| TSM_SPARE2_EN_OVRD | When TSM_SPARE2_EN_OVRD_EN=1, this value overrides the mission mode state of the signal "tsm_spare2_en". This bit is ignored when TSM_SPARE2_EN_OVRD_EN==0. |
| 4 TSM_SPARE2_EN_OVRD_EN | Override control for TSM_SPARE2_EN 0b - Normal operation. 1b - Use the state of TSM_SPARE2_EN_OVRD to override the signal "tsm_spare2_en". |
| 3 TSM_SPARE1_EN_OVRD | Override value for TSM_SPARE1_EN When TSM_SPARE1_EN_OVRD_EN=1, this value overrides the mission mode state of the signal "tsm_spare1_en". This bit is ignored when TSM_SPARE1_EN_OVRD_EN==0. |
| 2 TSM_SPARE1_EN_OVRD_EN | Override control for TSM_SPARE1_EN 0b - Normal operation. 1b - Use the state of TSM_SPARE1_EN_OVRD to override the signal "tsm_spare1_en". |
| 1 TSM_SPARE0_EN_OVRD | Override value for TSM_SPARE0_EN When TSM_SPARE0_EN_OVRD_EN=1, this value overrides the mission mode state of the signal "tsm_spare0_en". This bit is ignored when TSM_SPARE0_EN_OVRD_EN==0. |
| 0 TSM_SPARE0_EN_OVRD_EN | Override control for TSM_SPARE0_EN 0b - Normal operation. 1b - Use the state of TSM_SPARE0_EN_OVRD to override the signal "tsm_spare0_en". |

45.4.5.3.1.8 PA POWER (PA_POWER)

45.4.5.3.1.8.1 Address

| Register | Offset |
|----------|-----------|
| PA_POWER | 4005C2D8h |

45.4.5.3.1.8.2 Function

This contents of this register are used as PA target power when XCVR_CTRL[TGT_PWR_SRC] = 000

45.4.5.3.1.8.3 Diagram

| | | | | | | | | | | | | | | | | |
|-------|----|----|----|----|----|----|----|----|----------|----|----|----|----|----|----|----|
| Bits | 31 | 30 | 29 | 28 | 27 | 26 | 25 | 24 | 23 | 22 | 21 | 20 | 19 | 18 | 17 | 16 |
| R | 0 | | | | | | | | | | | | | | | |
| W | | | | | | | | | | | | | | | | |
| Reset | 0 | 0 | 0 | 0 | 0 | 0 | 0 | 0 | 0 | 0 | 0 | 0 | 0 | 0 | 0 | 0 |
| Bits | 15 | 14 | 13 | 12 | 11 | 10 | 9 | 8 | 7 | 6 | 5 | 4 | 3 | 2 | 1 | 0 |
| R | 0 | | | | | | | | PA_POWER | | | | | | | |
| W | | | | | | | | | | | | | | | | |
| Reset | 0 | 0 | 0 | 0 | 0 | 0 | 0 | 0 | 0 | 0 | 0 | 0 | 0 | 0 | 0 | 0 |

45.4.5.3.1.8.4 Fields

| Field | Function |
|------------------|--|
| 31-6 Reserved | Reserved |
| 5-0 PA_POWER | PA POWER This contents of this register are used as PA target power when XCVR_CTRL[TGT_PWR_SRC] = 00. The valid values for this field are 0,1,2,4,6,8,...,62 (in increasing order of PA power). That is, above 1, only even numbers are permitted in the PA_POWER bitfield. Odd values of 3..63 are not permitted and will result in unexpected behavior. |

45.4.5.3.1.9 PA RAMP TABLE 0 (PA_RAMP_TBL0)

45.4.5.3.1.9.1 Address

| Register | Offset |
|--------------|-----------|
| PA_RAMP_TBL0 | 4005C2DCh |

45.4.5.3.1.9.2 Function

PA Ramp Table 0

45.4.5.3.1.9.3 Diagram

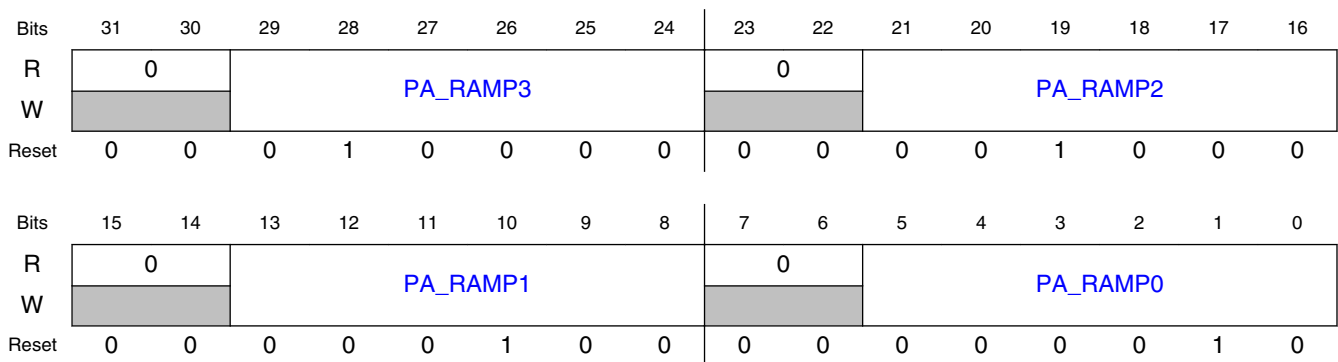

45.4.5.3.1.9.4 Fields

| Field | Function |
|-------|----------|
| 31-30 | Reserved |

Table continues on the next page...

| Field | Function |
|-------------------|--|
| — | |
| 29-24 PA_RAMP3 | PA_RAMP3 If PA ramping is enabled (TSM_CTRL[PA_RAMP_SEL] > 00), the contents of this register are presented to the PA during PA ramping, for the duration of the fourth ramp step. During PA ramp down, the contents of this register are the PA power value during the fourth-to-last ramp step. In both cases, PA_RAMP3 cannot exceed target power (enforced by PA ramping logic). |
| 23-22 — | Reserved |
| 21-16 PA_RAMP2 | PA_RAMP2 If PA ramping is enabled (TSM_CTRL[PA_RAMP_SEL] > 00), the contents of this register are presented to the PA during PA ramping, for the duration of the third ramp step. During PA ramp down, the contents of this register are the PA power value during the third-to-last ramp step. In both cases, PA_RAMP2 cannot exceed target power (enforced by PA ramping logic). |
| 15-14 — | Reserved |
| 13-8 PA_RAMP1 | PA_RAMP1 If PA ramping is enabled (TSM_CTRL[PA_RAMP_SEL] > 00), the contents of this register are presented to the PA during PA ramping, for the duration of the second ramp step. During PA ramp down, the contents of this register are the PA power value during the second-to-last ramp step. In both cases, PA_RAMP1 cannot exceed target power (enforced by PA ramping logic). |
| 7-6 — | Reserved |
| 5-0 PA_RAMP0 | PA_RAMP0 If PA ramping is enabled (TSM_CTRL[PA_RAMP_SEL] > 00), the contents of this register are presented to the PA during PA ramping, when TSM tx_pa_en transitions low to high, and then for the duration of the first ramp step. During PA ramp down, the contents of this register are the PA power value during the final ramp step. In both cases, PA_RAMP0 cannot exceed target power (enforced by PA ramping logic). When PA ramping is enabled, the contents of PA_RAMP0 are also presented to the PA during sequence-idle conditions. |

45.4.5.3.1.10 PA RAMP TABLE 1 (PA_RAMP_TBL1)

45.4.5.3.1.10.1 Address

| Register | Offset |
|--------------|-----------|
| PA_RAMP_TBL1 | 4005C2E0h |

45.4.5.3.1.10.2 Function

PA Ramp Table 1

45.4.5.3.1.10.3 Diagram

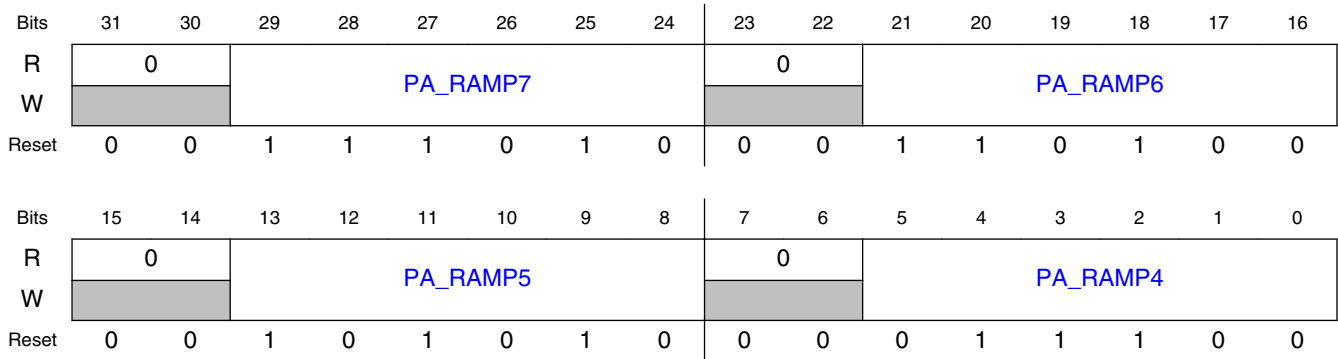

45.4.5.3.1.10.4 Fields

| Field | Function |
|-------------------|---|
| 31-30 — | Reserved |
| 29-24 PA_RAMP7 | PA_RAMP7 If PA ramping is enabled (TSM_CTRL[PA_RAMP_SEL] > 00), the contents of this register are presented to the PA during PA ramping, for the duration of the eighth (final) ramp step. During PA ramp down, the contents of this register are the PA power value during the eighth-to-last (first) ramp step. In both cases, PA_RAMP7 cannot exceed target power (enforced by PA ramping logic). |
| 23-22 — | Reserved |
| 21-16 PA_RAMP6 | PA_RAMP6 If PA ramping is enabled (TSM_CTRL[PA_RAMP_SEL] > 00), the contents of this register are presented to the PA during PA ramping, for the duration of the seventh ramp step. During PA ramp down, the contents of this register are the PA power value during the seventh-to-last ramp step. In both cases, PA_RAMP6 cannot exceed target power (enforced by PA ramping logic). |
| 15-14 — | Reserved |
| 13-8 PA_RAMP5 | PA_RAMP5 If PA ramping is enabled (TSM_CTRL[PA_RAMP_SEL] > 00), the contents of this register are presented to the PA during PA ramping, for the duration of the sixth ramp step. During PA ramp down, the contents of this register are the PA power value during the sixth-to-last ramp step. In both cases, PA_RAMP5 cannot exceed target power (enforced by PA ramping logic). |
| 7-6 — | Reserved |
| 5-0 PA_RAMP4 | PA_RAMP4 If PA ramping is enabled (TSM_CTRL[PA_RAMP_SEL] > 00), the contents of this register are presented to the PA during PA ramping, for the duration of the fifth ramp step. During PA ramp down, the contents of this register are the PA power value during the fifth-to-last ramp step. In both cases, PA_RAMP4 cannot exceed target power (enforced by PA ramping logic). |

45.4.5.3.1.11 TSM RECYCLE COUNT (RECYCLE_COUNT)

45.4.5.3.1.11.1 Address

| Register | Offset |
|---------------|-----------|
| RECYCLE_COUNT | 4005C2E4h |

45.4.5.3.1.11.2 Function

This register contains the TSM Recycle "Jump-to" points for the 3 types of TSM Recycle

45.4.5.3.1.11.3 Diagram

| | | | | | | | | | | | | | | | | |
|-------|----------------|----|----|----|----|----|----|----|----------------|----|----|----|----|----|----|----|
| Bits | 31 | 30 | 29 | 28 | 27 | 26 | 25 | 24 | 23 | 22 | 21 | 20 | 19 | 18 | 17 | 16 |
| R | 0 | | | | | | | | RECYCLE_COUNT2 | | | | | | | |
| W | | | | | | | | | | | | | | | | |
| Reset | 0 | 0 | 0 | 0 | 0 | 0 | 0 | 0 | 0 | 0 | 0 | 1 | 1 | 0 | 1 | 0 |
| Bits | 15 | 14 | 13 | 12 | 11 | 10 | 9 | 8 | 7 | 6 | 5 | 4 | 3 | 2 | 1 | 0 |
| R | RECYCLE_COUNT1 | | | | | | | | RECYCLE_COUNT0 | | | | | | | |
| W | | | | | | | | | | | | | | | | |
| Reset | 0 | 0 | 0 | 0 | 0 | 1 | 0 | 0 | 0 | 1 | 1 | 0 | 0 | 1 | 0 | 0 |

45.4.5.3.1.11.4 Fields

| Field | Function |
|-------------------------|---|
| 31-24 — | Reserved |
| 23-16 RECYCLE_COUNT2 | TSM RX Recycle Count 2 The RECYCLE_COUNT2[7:0] register determines the TSM count value to which the TSM "recycles" when, in LPPS mode, an LPPS power save cycle completes and the receiver is switched back on, necessitating a foreshortened RX warmup. The intention is for this register to be programmed to a TSM count value that is just prior to the assertion of rx_lna_en, but there are no restrictions on programming this register. An LPPS recycle is a command from the LPPS state machine to TSM, requesting a jump from the TSM ON phase back to a programmable point in the WARMUP phase, and resume counting from there. |
| 15-8 RECYCLE_COUNT1 | TSM RX Recycle Count 1 The RECYCLE_COUNT1[7:0] register determines the TSM count value to which the TSM "recycles" when the 802.15.4 Sequence Manager (ZSM) state "RX_PAN1" is reached and the ZSM asserts tsm_recycle[1] to TSM. The intention is for this register to be programmed to a TSM count value such that the TSM de-asserts, and then re-asserts its "pll_dig_en" output, to effectuate a Dual PAN on-the-fly channel change, but there are no restrictions on programming this register. An RX recycle is a command from ZSM to TSM, requesting a jump from the TSM ON phase back to a programmable point in the |

Table continues on the next page...

FSK Modulator

| Field | Function |
|-------------------------------|--|
| | WARMUP phase, and resume counting from there. A recycle will result from the expiration of the Dual PAN Dwell Timer, at which point an RF-channel change is required. This necessitates the desassertion and reassertion of pll_dig_en, hence the return to the WARMUP phase at the appropriate point. |
| 7-0 RECYCLE_COUNT0 UNT0 | TSM RX Recycle Count 0 The RECYCLE_COUNT0[7:0] register determines the TSM count value to which the TSM "recycles" when the 802.15.4 Sequence Manager (ZSM) state "RX_CYC" is reached and the ZSM asserts tsm_recycle[0] to TSM. This register also determines the TSM count value to which the TSM recycles when the ZSM state RX_CCCA is reached because tsm_recycle[0] is also asserted in this state. This register also determines the TSM count value to which the TSM recycles when the Generic_FSK Link Layer asserts a tsm_recycle to TSM. The intention is for this register to be programmed to a TSM count value such that the TSM re-asserts its "rx_init" output, but there are no restrictions on programming this register. An RX recycle is a command from any protocol engine to TSM, requesting a jump from the TSM ON phase back to a programmable point in the WARMUP phase, and resume counting from there. A recycle will result from the reception of a packet with bad CRC or one which fails packet-filtering rules, or the end of a CCA operation in Continuous CCA mode which results in a channel indicating "busy". |

45.4.5.3.1.12 TSM FAST WARMUP CONTROL REGISTER 1 (FAST_CTRL1)

45.4.5.3.1.12.1 Address

| Register | Offset |
|------------|-----------|
| FAST_CTRL1 | 4005C2E8h |

45.4.5.3.1.12.2 Function

This register provides enabling and control for Fast TSM Mode

45.4.5.3.1.12.3 Diagram

| | | | | | | | | | | | | | | | | |
|-------|------------------|----|----|----|----|----|----|----|----|----|----|----|-------------------|-----------------------|-----------------------|-----------------------|
| Bits | 31 | 30 | 29 | 28 | 27 | 26 | 25 | 24 | 23 | 22 | 21 | 20 | 19 | 18 | 17 | 16 |
| R | 0 | | | | | | | | | | | | | | | |
| W | | | | | | | | | | | | | | | | |
| Reset | 0 | 0 | 0 | 0 | 0 | 0 | 0 | 0 | 0 | 0 | 0 | 0 | 0 | 0 | 0 | 0 |
| Bits | 15 | 14 | 13 | 12 | 11 | 10 | 9 | 8 | 7 | 6 | 5 | 4 | 3 | 2 | 1 | 0 |
| R | FAST_RX2TX_START | | | | | | | | 0 | | | | FAST_WU_CLEA R | FAST_RX2 TX_E N | FAST_RX_ WU_ EN | FAST_TX_ WU_ EN |
| W | | | | | | | | | | | | | | | | |
| Reset | 1 | 1 | 1 | 1 | 1 | 1 | 1 | 1 | 0 | 0 | 0 | 0 | 0 | 0 | 0 | 0 |

45.4.5.3.1.12.4 *Fields*

| Field | Function |
|--------------------------|---|
| 31-16 — | Reserved |
| 15-8 FAST_RX2TX_START | TSM "Jump-to" point for a Fast TSM RX-to-TX Transition. This register currently has no functionality. |
| 7-4 — | Reserved |
| 3 FAST_WU_CLEAR | Fast TSM Warmup Clear State This bit clears the RF channel memory in the PLL Digital Block, forcing the next TSM TX Warmup to be normal (not fast), and the next TSM RX Warmup to be normal (not fast), regardless of whether the RF channel has actually changed or not. This bit is not self-clearing. Write '1' to clear channel memory, then write '0' to proceed with TSM operations. |
| 2 FAST_RX2TX_EN | Fast TSM RX-to-TX Transition Enable This bit currently has no functionality. |
| 1 FAST_RX_WU_EN | Fast TSM RX Warmup Enable 0b - Fast TSM RX Warmups are disabled 1b - Fast TSM RX Warmups are enabled, if the RF channel has not changed since the last RX warmup, and for BLE mode, the RF channel is not an advertising channel. |
| 0 FAST_TX_WU_EN | Fast TSM TX Warmup Enable 0b - Fast TSM TX Warmups are disabled 1b - Fast TSM TX Warmups are enabled, if the RF channel has not changed since the last TX warmup, and for BLE mode, the RF channel is not an advertising channel. |

45.4.5.3.1.13 **TSM FAST WARMUP CONTROL REGISTER 2 (FAST_CTRL2)**45.4.5.3.1.13.1 *Address*

| Register | Offset |
|------------|-----------|
| FAST_CTRL2 | 4005C2ECh |

45.4.5.3.1.13.2 *Function*

This register provides configuration for Fast TSM Mode

FSK Modulator

45.4.5.3.1.13.3 Diagram

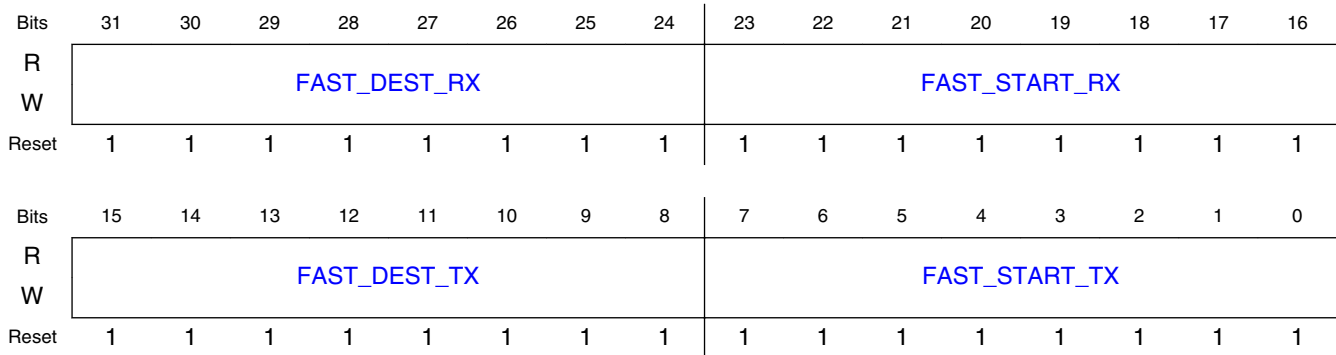

45.4.5.3.1.13.4 Fields

| Field | Function |
|------------------------|--|
| 31-24 FAST_DEST_RX | <p>Fast TSM RX "Jump-to" Point</p> <p>During a Fast RX Warmup, this value represents the ending TSM count for the portion of the warmup that is to be skipped over. If Fast RX Warmups are enabled, FAST_START_RX[7:0] will never be reached and will instead be replaced by the contents of this register, thereby executing the jump.</p> <p>Example:</p> <p style="padding-left: 40px;">FAST_START_RX = 10 FAST_DEST_RX = 15</p> <p>The TSM will count as follows: ... 7,8,9,15,16,17 ...</p> |
| 23-16 FAST_START_RX | <p>Fast TSM RX "Jump-from" Point</p> <p>During a Fast RX Warmup, this value represents the starting TSM count for the portion of the warmup that is to be skipped over. If Fast RX Warmups are enabled, this count will never be reached; its place in the TSM warmup will be replaced by the contents of FAST_DEST_RX[7:0], thereby executing the jump.</p> |
| 15-8 FAST_DEST_TX | <p>Fast TSM TX "Jump-to" Point</p> <p>During a Fast TX Warmup, this value represents the ending TSM count for the portion of the warmup that is to be skipped over. If Fast TX Warmups are enabled, FAST_START_TX[7:0] will never be reached and will instead be replaced by the contents of this register, thereby executing the jump.</p> <p>Example:</p> <p style="padding-left: 40px;">FAST_START_TX = 10 FAST_DEST_TX = 15</p> <p>The TSM will count as follows: ... 7,8,9,15,16,17 ...</p> |
| 7-0 FAST_START_TX | <p>Fast TSM TX "Jump-from" Point</p> <p>During a Fast TX Warmup, this value represents the starting TSM count for the portion of the warmup that is to be skipped over. If Fast TX Warmups are enabled, this count will never be reached; its place in the TSM warmup will be replaced by the contents of FAST_DEST_TX[7:0], thereby executing the jump.</p> |

45.4.5.3.1.14 TSM_TIMING00 (TIMING00)

45.4.5.3.1.14.1 Address

| Register | Offset |
|----------|-----------|
| TIMING00 | 4005C2F0h |

45.4.5.3.1.14.2 Function

This register contains the timing values to control the assertion and deassertion times for both TX and RX sequences for the BB_LDO_HF_EN TSM signal or signal group.

45.4.5.3.1.14.3 Diagram

| | | | | | | | | | | | | | | | | |
|-------|--------------------|----|----|----|----|----|----|----|--------------------|----|----|----|----|----|----|----|
| Bits | 31 | 30 | 29 | 28 | 27 | 26 | 25 | 24 | 23 | 22 | 21 | 20 | 19 | 18 | 17 | 16 |
| R | BB_LDO_HF_EN_RX_LO | | | | | | | | BB_LDO_HF_EN_RX_HI | | | | | | | |
| W | | | | | | | | | | | | | | | | |
| Reset | 0 | 1 | 1 | 0 | 0 | 1 | 1 | 1 | 0 | 0 | 0 | 0 | 0 | 0 | 0 | 0 |
| Bits | 15 | 14 | 13 | 12 | 11 | 10 | 9 | 8 | 7 | 6 | 5 | 4 | 3 | 2 | 1 | 0 |
| R | BB_LDO_HF_EN_TX_LO | | | | | | | | BB_LDO_HF_EN_TX_HI | | | | | | | |
| W | | | | | | | | | | | | | | | | |
| Reset | 0 | 1 | 1 | 0 | 1 | 0 | 1 | 0 | 0 | 0 | 0 | 0 | 0 | 0 | 0 | 0 |

45.4.5.3.1.14.4 Fields

| Field | Function |
|-----------------------------|---|
| 31-24 BB_LDO_HF_EN_RX_LO | De-assertion time setting for BB_LDO_HF_EN (RX) This field sets the point during a TSM RX sequence (the tsm_count[7:0] value) at which the BB_LDO_HF_EN signal or group will transition from HI to LO. |
| 23-16 BB_LDO_HF_EN_RX_HI | Assertion time setting for BB_LDO_HF_EN (RX) This field sets the point during a TSM RX sequence (the tsm_count[7:0] value) at which the BB_LDO_HF_EN signal or group will transition from LO to HI. |
| 15-8 BB_LDO_HF_EN_TX_LO | De-assertion time setting for BB_LDO_HF_EN (TX) This field sets the point during a TSM TX sequence (the tsm_count[7:0] value) at which the BB_LDO_HF_EN signal or group will transition from HI to LO. |
| 7-0 BB_LDO_HF_EN_TX_HI | Assertion time setting for BB_LDO_HF_EN (TX) This field sets the point during a TSM TX sequence (the tsm_count[7:0] value) at which the BB_LDO_HF_EN signal or group will transition from LO to HI. |

45.4.5.3.1.15 TSM_TIMING01 (TIMING01)

FSK Modulator

45.4.5.3.1.15.1 Address

| Register | Offset |
|----------|-----------|
| TIMING01 | 4005C2F4h |

45.4.5.3.1.15.2 Diagram

| | | | | | | | | | | | | | | | | |
|-------|------------------------|----|----|----|----|----|----|----|------------------------|----|----|----|----|----|----|----|
| Bits | 31 | 30 | 29 | 28 | 27 | 26 | 25 | 24 | 23 | 22 | 21 | 20 | 19 | 18 | 17 | 16 |
| R | BB_LDO_ADCDAC_EN_RX_LO | | | | | | | | BB_LDO_ADCDAC_EN_RX_HI | | | | | | | |
| W | | | | | | | | | | | | | | | | |
| Reset | 0 | 1 | 1 | 0 | 0 | 1 | 1 | 1 | 0 | 0 | 0 | 0 | 0 | 0 | 0 | 0 |
| Bits | 15 | 14 | 13 | 12 | 11 | 10 | 9 | 8 | 7 | 6 | 5 | 4 | 3 | 2 | 1 | 0 |
| R | BB_LDO_ADCDAC_EN_TX_LO | | | | | | | | BB_LDO_ADCDAC_EN_TX_HI | | | | | | | |
| W | | | | | | | | | | | | | | | | |
| Reset | 0 | 1 | 1 | 0 | 1 | 0 | 1 | 0 | 0 | 0 | 0 | 0 | 0 | 0 | 0 | 0 |

45.4.5.3.1.15.3 Fields

| Field | Function |
|-------------------------------------|---|
| 31-24 BB_LDO_ADCD AC_EN_RX_LO | De-assertion time setting for BB_LDO_ADCDAC_EN (RX) This field sets the point during a TSM RX sequence (the tsm_count[7:0] value) at which the BB_LDO_ADCDAC_EN signal or group will transition from HI to LO. |
| 23-16 BB_LDO_ADCD AC_EN_RX_HI | Assertion time setting for BB_LDO_ADCDAC_EN (RX) This field sets the point during a TSM RX sequence (the tsm_count[7:0] value) at which the BB_LDO_ADCDAC_EN signal or group will transition from LO to HI. |
| 15-8 BB_LDO_ADCD AC_EN_TX_LO | De-assertion time setting for BB_LDO_ADCDAC_EN (TX) This field sets the point during a TSM TX sequence (the tsm_count[7:0] value) at which the BB_LDO_ADCDAC_EN signal or group will transition from HI to LO. |
| 7-0 BB_LDO_ADCD AC_EN_TX_HI | Assertion time setting for BB_LDO_ADCDAC_EN (TX) This field sets the point during a TSM TX sequence (the tsm_count[7:0] value) at which the BB_LDO_ADCDAC_EN signal or group will transition from LO to HI. |

45.4.5.3.1.16 TSM_TIMING02 (TIMING02)

45.4.5.3.1.16.1 Address

| Register | Offset |
|----------|-----------|
| TIMING02 | 4005C2F8h |

45.4.5.3.1.16.2 *Diagram*

| | | | | | | | | | | | | | | | | |
|-------|---------------------|----|----|----|----|----|----|----|---------------------|----|----|----|----|----|----|----|
| Bits | 31 | 30 | 29 | 28 | 27 | 26 | 25 | 24 | 23 | 22 | 21 | 20 | 19 | 18 | 17 | 16 |
| R | BB_LDO_BBA_EN_RX_LO | | | | | | | | BB_LDO_BBA_EN_RX_HI | | | | | | | |
| W | | | | | | | | | | | | | | | | |
| Reset | 0 | 1 | 1 | 0 | 0 | 1 | 1 | 1 | 0 | 0 | 0 | 0 | 0 | 0 | 0 | 0 |
| Bits | 15 | 14 | 13 | 12 | 11 | 10 | 9 | 8 | 7 | 6 | 5 | 4 | 3 | 2 | 1 | 0 |
| R | 1 | | | | | | | | | | | | | | | |
| W | | | | | | | | | | | | | | | | |
| Reset | 1 | 1 | 1 | 1 | 1 | 1 | 1 | 1 | 1 | 1 | 1 | 1 | 1 | 1 | 1 | 1 |

45.4.5.3.1.16.3 *Fields*

| Field | Function |
|---------------------|---|
| 31-24 | De-assertion time setting for BB_LDO_BBA_EN (RX) |
| BB_LDO_BBA_EN_RX_LO | This field sets the point during a TSM RX sequence (the tsm_count[7:0] value) at which the BB_LDO_BBA_EN signal or group will transition from HI to LO. |
| 23-16 | Assertion time setting for BB_LDO_BBA_EN (RX) |
| BB_LDO_BBA_EN_RX_HI | This field sets the point during a TSM RX sequence (the tsm_count[7:0] value) at which the BB_LDO_BBA_EN signal or group will transition from LO to HI. |
| 15-0 | Reserved |
| — | |

45.4.5.3.1.17 **TSM_TIMING03 (TIMING03)**45.4.5.3.1.17.1 *Address*

| Register | Offset |
|----------|-----------|
| TIMING03 | 4005C2FCh |

FSK Modulator

45.4.5.3.1.17.2 Diagram

| | | | | | | | | | | | | | | | | |
|-------|--------------------|----|----|----|----|----|----|----|--------------------|----|----|----|----|----|----|----|
| Bits | 31 | 30 | 29 | 28 | 27 | 26 | 25 | 24 | 23 | 22 | 21 | 20 | 19 | 18 | 17 | 16 |
| R | BB_LDO_PD_EN_RX_LO | | | | | | | | BB_LDO_PD_EN_RX_HI | | | | | | | |
| W | | | | | | | | | | | | | | | | |
| Reset | 0 | 1 | 1 | 0 | 0 | 1 | 1 | 1 | 0 | 0 | 0 | 0 | 0 | 0 | 0 | 0 |
| Bits | 15 | 14 | 13 | 12 | 11 | 10 | 9 | 8 | 7 | 6 | 5 | 4 | 3 | 2 | 1 | 0 |
| R | BB_LDO_PD_EN_TX_LO | | | | | | | | BB_LDO_PD_EN_TX_HI | | | | | | | |
| W | | | | | | | | | | | | | | | | |
| Reset | 0 | 1 | 1 | 0 | 1 | 0 | 1 | 0 | 0 | 0 | 0 | 0 | 0 | 0 | 0 | 0 |

45.4.5.3.1.17.3 Fields

| Field | Function |
|-----------------------------|---|
| 31-24 BB_LDO_PD_EN_RX_LO | De-assertion time setting for BB_LDO_PD_EN (RX) This field sets the point during a TSM RX sequence (the tsm_count[7:0] value) at which the BB_LDO_PD_EN signal or group will transition from HI to LO. |
| 23-16 BB_LDO_PD_EN_RX_HI | Assertion time setting for BB_LDO_PD_EN (RX) This field sets the point during a TSM RX sequence (the tsm_count[7:0] value) at which the BB_LDO_PD_EN signal or group will transition from LO to HI. |
| 15-8 BB_LDO_PD_EN_TX_LO | De-assertion time setting for BB_LDO_PD_EN (TX) This field sets the point during a TSM TX sequence (the tsm_count[7:0] value) at which the BB_LDO_PD_EN signal or group will transition from HI to LO. |
| 7-0 BB_LDO_PD_EN_TX_HI | Assertion time setting for BB_LDO_PD_EN (TX) This field sets the point during a TSM TX sequence (the tsm_count[7:0] value) at which the BB_LDO_PD_EN signal or group will transition from LO to HI. |

45.4.5.3.1.18 TSM_TIMING04 (TIMING04)

45.4.5.3.1.18.1 Address

| Register | Offset |
|----------|-----------|
| TIMING04 | 4005C300h |

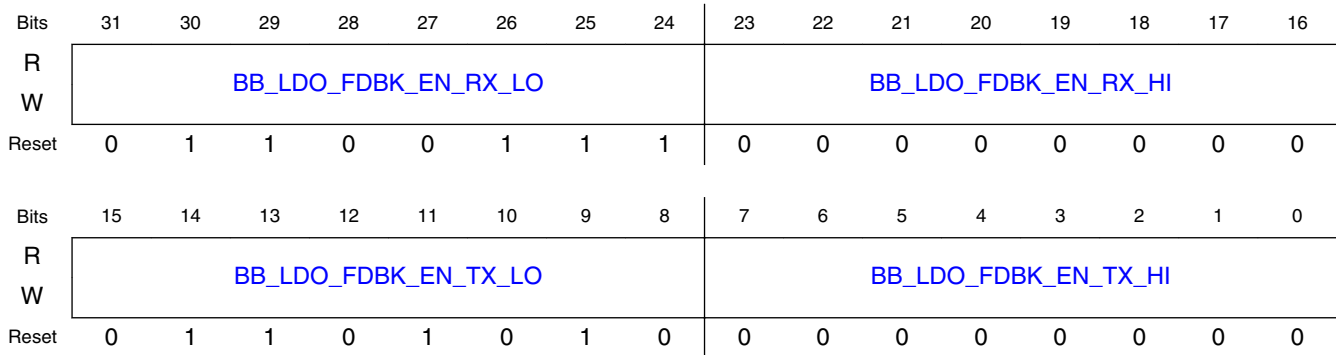
45.4.5.3.1.18.2 *Diagram*45.4.5.3.1.18.3 *Fields*

| Field | Function |
|-------------------------------|---|
| 31-24 BB_LDO_FDBK_EN_RX_LO | De-assertion time setting for BB_LDO_FDBK_EN (RX) This field sets the point during a TSM RX sequence (the tsm_count[7:0] value) at which the BB_LDO_FDBK_EN signal or group will transition from HI to LO. |
| 23-16 BB_LDO_FDBK_EN_RX_HI | Assertion time setting for BB_LDO_FDBK_EN (RX) This field sets the point during a TSM RX sequence (the tsm_count[7:0] value) at which the BB_LDO_FDBK_EN signal or group will transition from LO to HI. |
| 15-8 BB_LDO_FDBK_EN_TX_LO | De-assertion time setting for BB_LDO_FDBK_EN (TX) This field sets the point during a TSM TX sequence (the tsm_count[7:0] value) at which the BB_LDO_FDBK_EN signal or group will transition from HI to LO. |
| 7-0 BB_LDO_FDBK_EN_TX_HI | Assertion time setting for BB_LDO_FDBK_EN (TX) This field sets the point during a TSM TX sequence (the tsm_count[7:0] value) at which the BB_LDO_FDBK_EN signal or group will transition from LO to HI. |

45.4.5.3.1.19 **TSM_TIMING05 (TIMING05)**45.4.5.3.1.19.1 *Address*

| Register | Offset |
|----------|-----------|
| TIMING05 | 4005C304h |

FSK Modulator

45.4.5.3.1.19.2 Diagram

| | | | | | | | | | | | | | | | | |
|-------|-----------------------|----|----|----|----|----|----|----|-----------------------|----|----|----|----|----|----|----|
| Bits | 31 | 30 | 29 | 28 | 27 | 26 | 25 | 24 | 23 | 22 | 21 | 20 | 19 | 18 | 17 | 16 |
| R | BB_LDO_VCOLO_EN_RX_LO | | | | | | | | BB_LDO_VCOLO_EN_RX_HI | | | | | | | |
| W | | | | | | | | | | | | | | | | |
| Reset | 0 | 1 | 1 | 0 | 0 | 1 | 1 | 1 | 0 | 0 | 0 | 0 | 0 | 0 | 0 | 0 |
| Bits | 15 | 14 | 13 | 12 | 11 | 10 | 9 | 8 | 7 | 6 | 5 | 4 | 3 | 2 | 1 | 0 |
| R | BB_LDO_VCOLO_EN_TX_LO | | | | | | | | BB_LDO_VCOLO_EN_TX_HI | | | | | | | |
| W | | | | | | | | | | | | | | | | |
| Reset | 0 | 1 | 1 | 0 | 1 | 0 | 1 | 0 | 0 | 0 | 0 | 0 | 0 | 0 | 0 | 0 |

45.4.5.3.1.19.3 Fields

| Field | Function |
|------------------------------------|---|
| 31-24 BB_LDO_VCOL O_EN_RX_LO | De-assertion time setting for BB_LDO_VCOLO_EN (RX) This field sets the point during a TSM RX sequence (the tsm_count[7:0] value) at which the BB_LDO_VCOLO_EN signal or group will transition from HI to LO. |
| 23-16 BB_LDO_VCOL O_EN_RX_HI | Assertion time setting for BB_LDO_VCOLO_EN (RX) This field sets the point during a TSM RX sequence (the tsm_count[7:0] value) at which the BB_LDO_VCOLO_EN signal or group will transition from LO to HI. |
| 15-8 BB_LDO_VCOL O_EN_TX_LO | De-assertion time setting for BB_LDO_VCOLO_EN (TX) This field sets the point during a TSM TX sequence (the tsm_count[7:0] value) at which the BB_LDO_VCOLO_EN signal or group will transition from HI to LO. |
| 7-0 BB_LDO_VCOL O_EN_TX_HI | Assertion time setting for BB_LDO_VCOLO_EN (TX) This field sets the point during a TSM TX sequence (the tsm_count[7:0] value) at which the BB_LDO_VCOLO_EN signal or group will transition from LO to HI. |

45.4.5.3.1.20 TSM_TIMING06 (TIMING06)

45.4.5.3.1.20.1 Address

| Register | Offset |
|----------|-----------|
| TIMING06 | 4005C308h |

45.4.5.3.1.20.2 *Diagram*

| | | | | | | | | | | | | | | | | |
|-------|-----------------------|----|----|----|----|----|----|----|-----------------------|----|----|----|----|----|----|----|
| Bits | 31 | 30 | 29 | 28 | 27 | 26 | 25 | 24 | 23 | 22 | 21 | 20 | 19 | 18 | 17 | 16 |
| R | BB_LDO_VTREF_EN_RX_LO | | | | | | | | BB_LDO_VTREF_EN_RX_HI | | | | | | | |
| W | | | | | | | | | | | | | | | | |
| Reset | 0 | 1 | 1 | 0 | 0 | 1 | 1 | 1 | 0 | 0 | 0 | 0 | 0 | 0 | 0 | 0 |
| Bits | 15 | 14 | 13 | 12 | 11 | 10 | 9 | 8 | 7 | 6 | 5 | 4 | 3 | 2 | 1 | 0 |
| R | BB_LDO_VTREF_EN_TX_LO | | | | | | | | BB_LDO_VTREF_EN_TX_HI | | | | | | | |
| W | | | | | | | | | | | | | | | | |
| Reset | 0 | 1 | 1 | 0 | 1 | 0 | 1 | 0 | 0 | 0 | 0 | 0 | 0 | 0 | 0 | 0 |

45.4.5.3.1.20.3 *Fields*

| Field | Function |
|--------------------------------|---|
| 31-24 BB_LDO_VTREF_EN_RX_LO | De-assertion time setting for BB_LDO_VTREF_EN (RX) This field sets the point during a TSM RX sequence (the tsm_count[7:0] value) at which the BB_LDO_VTREF_EN signal or group will transition from HI to LO. |
| 23-16 BB_LDO_VTREF_EN_RX_HI | Assertion time setting for BB_LDO_VTREF_EN (RX) This field sets the point during a TSM RX sequence (the tsm_count[7:0] value) at which the BB_LDO_VTREF_EN signal or group will transition from LO to HI. |
| 15-8 BB_LDO_VTREF_EN_TX_LO | De-assertion time setting for BB_LDO_VTREF_EN (TX) This field sets the point during a TSM TX sequence (the tsm_count[7:0] value) at which the BB_LDO_VTREF_EN signal or group will transition from HI to LO. |
| 7-0 BB_LDO_VTREF_EN_TX_HI | Assertion time setting for BB_LDO_VTREF_EN (TX) This field sets the point during a TSM TX sequence (the tsm_count[7:0] value) at which the BB_LDO_VTREF_EN signal or group will transition from LO to HI. |

45.4.5.3.1.21 **TSM_TIMING07 (TIMING07)**45.4.5.3.1.21.1 *Address*

| Register | Offset |
|----------|-----------|
| TIMING07 | 4005C30Ch |

45.4.5.3.1.21.2 Diagram

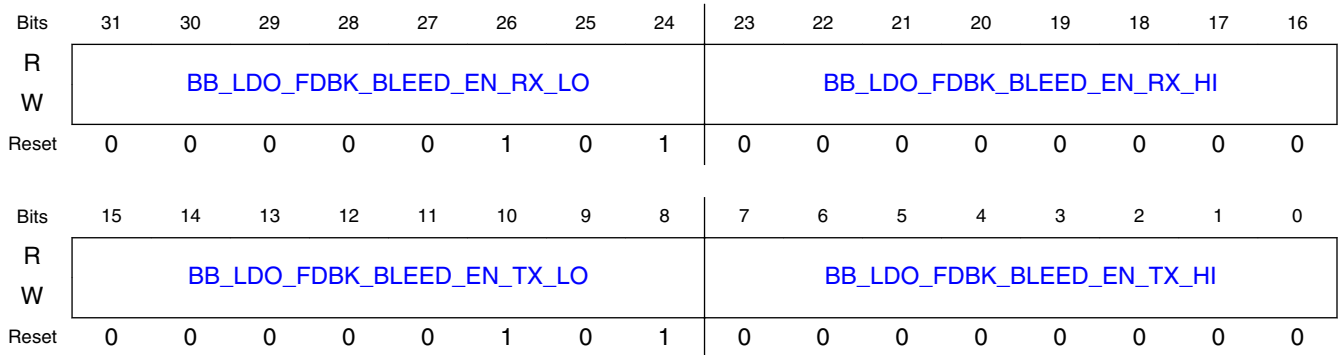

45.4.5.3.1.21.3 Fields

| Field | Function |
|-------------------------------------|---|
| 31-24 BB_LDO_FDBK_BLEED_EN_RX_LO | De-assertion time setting for BB_LDO_FDBK_BLEED_EN (RX) This field sets the point during a TSM RX sequence (the tsm_count[7:0] value) at which the BB_LDO_FDBK_BLEED_EN signal or group will transition from HI to LO. |
| 23-16 BB_LDO_FDBK_BLEED_EN_RX_HI | Assertion time setting for BB_LDO_FDBK_BLEED_EN (RX) This field sets the point during a TSM RX sequence (the tsm_count[7:0] value) at which the BB_LDO_FDBK_BLEED_EN signal or group will transition from LO to HI. |
| 15-8 BB_LDO_FDBK_BLEED_EN_TX_LO | De-assertion time setting for BB_LDO_FDBK_BLEED_EN (TX) This field sets the point during a TSM TX sequence (the tsm_count[7:0] value) at which the BB_LDO_FDBK_BLEED_EN signal or group will transition from HI to LO. |
| 7-0 BB_LDO_FDBK_BLEED_EN_TX_HI | Assertion time setting for BB_LDO_FDBK_BLEED_EN (TX) This field sets the point during a TSM TX sequence (the tsm_count[7:0] value) at which the BB_LDO_FDBK_BLEED_EN signal or group will transition from LO to HI. |

45.4.5.3.1.22 TSM_TIMING08 (TIMING08)

45.4.5.3.1.22.1 Address

| Register | Offset |
|----------|-----------|
| TIMING08 | 4005C310h |

45.4.5.3.1.22.2 *Diagram*

| | | | | | | | | | | | | | | | | |
|-------|-----------------------------|----|----|----|----|----|----|----|-----------------------------|----|----|----|----|----|----|----|
| Bits | 31 | 30 | 29 | 28 | 27 | 26 | 25 | 24 | 23 | 22 | 21 | 20 | 19 | 18 | 17 | 16 |
| R | BB_LDO_VCOLO_BLEED_EN_RX_LO | | | | | | | | BB_LDO_VCOLO_BLEED_EN_RX_HI | | | | | | | |
| W | | | | | | | | | | | | | | | | |
| Reset | 0 | 0 | 0 | 0 | 0 | 0 | 1 | 1 | 0 | 0 | 0 | 0 | 0 | 0 | 0 | 0 |
| Bits | 15 | 14 | 13 | 12 | 11 | 10 | 9 | 8 | 7 | 6 | 5 | 4 | 3 | 2 | 1 | 0 |
| R | BB_LDO_VCOLO_BLEED_EN_TX_LO | | | | | | | | BB_LDO_VCOLO_BLEED_EN_TX_HI | | | | | | | |
| W | | | | | | | | | | | | | | | | |
| Reset | 0 | 0 | 0 | 0 | 0 | 0 | 1 | 1 | 0 | 0 | 0 | 0 | 0 | 0 | 0 | 0 |

45.4.5.3.1.22.3 *Fields*

| Field | Function |
|--|---|
| 31-24 BB_LDO_VCOL O_BLEED_EN_ RX_LO | De-assertion time setting for BB_LDO_VCOLO_BLEED_EN (RX) This field sets the point during a TSM RX sequence (the tsm_count[7:0] value) at which the BB_LDO_VCOLO_BLEED_EN signal or group will transition from HI to LO. |
| 23-16 BB_LDO_VCOL O_BLEED_EN_ RX_HI | Assertion time setting for BB_LDO_VCOLO_BLEED_EN (RX) This field sets the point during a TSM RX sequence (the tsm_count[7:0] value) at which the BB_LDO_VCOLO_BLEED_EN signal or group will transition from LO to HI. |
| 15-8 BB_LDO_VCOL O_BLEED_EN_ TX_LO | De-assertion time setting for BB_LDO_VCOLO_BLEED_EN (TX) This field sets the point during a TSM TX sequence (the tsm_count[7:0] value) at which the BB_LDO_VCOLO_BLEED_EN signal or group will transition from HI to LO. |
| 7-0 BB_LDO_VCOL O_BLEED_EN_ TX_HI | Assertion time setting for BB_LDO_VCOLO_BLEED_EN (TX) This field sets the point during a TSM TX sequence (the tsm_count[7:0] value) at which the BB_LDO_VCOLO_BLEED_EN signal or group will transition from LO to HI. |

45.4.5.3.1.23 **TSM_TIMING09 (TIMING09)**45.4.5.3.1.23.1 *Address*

| Register | Offset |
|----------|-----------|
| TIMING09 | 4005C314h |

FSK Modulator

45.4.5.3.1.23.2 Diagram

| | | | | | | | | | | | | | | | | |
|-------|----------------------------------|----|----|----|----|----|----|----|----------------------------------|----|----|----|----|----|----|----|
| Bits | 31 | 30 | 29 | 28 | 27 | 26 | 25 | 24 | 23 | 22 | 21 | 20 | 19 | 18 | 17 | 16 |
| R | BB_LDO_VCOLO_FASTCHARGE_EN_RX_LO | | | | | | | | BB_LDO_VCOLO_FASTCHARGE_EN_RX_HI | | | | | | | |
| W | | | | | | | | | | | | | | | | |
| Reset | 0 | 0 | 0 | 0 | 0 | 0 | 1 | 1 | 0 | 0 | 0 | 0 | 0 | 0 | 0 | 0 |
| Bits | 15 | 14 | 13 | 12 | 11 | 10 | 9 | 8 | 7 | 6 | 5 | 4 | 3 | 2 | 1 | 0 |
| R | BB_LDO_VCOLO_FASTCHARGE_EN_TX_LO | | | | | | | | BB_LDO_VCOLO_FASTCHARGE_EN_TX_HI | | | | | | | |
| W | | | | | | | | | | | | | | | | |
| Reset | 0 | 0 | 0 | 0 | 0 | 0 | 1 | 1 | 0 | 0 | 0 | 0 | 0 | 0 | 0 | 0 |

45.4.5.3.1.23.3 Fields

| Field | Function |
|---|---|
| 31-24 BB_LDO_VCOLO_FASTCHARGE_EN_RX_LO | De-assertion time setting for BB_LDO_VCOLO_FASTCHARGE_EN (RX) This field sets the point during a TSM RX sequence (the tsm_count[7:0] value) at which the BB_LDO_VCOLO_FASTCHARGE_EN signal or group will transition from HI to LO. |
| 23-16 BB_LDO_VCOLO_FASTCHARGE_EN_RX_HI | Assertion time setting for BB_LDO_VCOLO_FASTCHARGE_EN (RX) This field sets the point during a TSM RX sequence (the tsm_count[7:0] value) at which the BB_LDO_VCOLO_FASTCHARGE_EN signal or group will transition from LO to HI. |
| 15-8 BB_LDO_VCOLO_FASTCHARGE_EN_TX_LO | De-assertion time setting for BB_LDO_VCOLO_FASTCHARGE_EN (TX) This field sets the point during a TSM TX sequence (the tsm_count[7:0] value) at which the BB_LDO_VCOLO_FASTCHARGE_EN signal or group will transition from HI to LO. |
| 7-0 BB_LDO_VCOLO_FASTCHARGE_EN_TX_HI | Assertion time setting for BB_LDO_VCOLO_FASTCHARGE_EN (TX) This field sets the point during a TSM TX sequence (the tsm_count[7:0] value) at which the BB_LDO_VCOLO_FASTCHARGE_EN signal or group will transition from LO to HI. |

45.4.5.3.1.24 TSM_TIMING10 (TIMING10)

45.4.5.3.1.24.1 Address

| Register | Offset |
|----------|-----------|
| TIMING10 | 4005C318h |

45.4.5.3.1.24.2 *Diagram*

| | | | | | | | | | | | | | | | | |
|-------|------------------------------|----|----|----|----|----|----|----|------------------------------|----|----|----|----|----|----|----|
| Bits | 31 | 30 | 29 | 28 | 27 | 26 | 25 | 24 | 23 | 22 | 21 | 20 | 19 | 18 | 17 | 16 |
| R | BB_XTAL_PLL_REF_CLK_EN_RX_LO | | | | | | | | BB_XTAL_PLL_REF_CLK_EN_RX_HI | | | | | | | |
| W | | | | | | | | | | | | | | | | |
| Reset | 0 | 1 | 1 | 0 | 0 | 1 | 1 | 1 | 0 | 0 | 0 | 0 | 0 | 0 | 1 | 1 |
| Bits | 15 | 14 | 13 | 12 | 11 | 10 | 9 | 8 | 7 | 6 | 5 | 4 | 3 | 2 | 1 | 0 |
| R | BB_XTAL_PLL_REF_CLK_EN_TX_LO | | | | | | | | BB_XTAL_PLL_REF_CLK_EN_TX_HI | | | | | | | |
| W | | | | | | | | | | | | | | | | |
| Reset | 0 | 1 | 1 | 0 | 1 | 0 | 1 | 0 | 0 | 0 | 0 | 0 | 0 | 0 | 1 | 1 |

45.4.5.3.1.24.3 *Fields*

| Field | Function |
|---------------------------------------|---|
| 31-24 BB_XTAL_PLL_REF_CLK_EN_RX_LO | De-assertion time setting for BB_XTAL_PLL_REF_CLK_EN (RX) This field sets the point during a TSM RX sequence (the tsm_count[7:0] value) at which the BB_XTAL_PLL_REF_CLK_EN signal or group will transition from HI to LO. |
| 23-16 BB_XTAL_PLL_REF_CLK_EN_RX_HI | Assertion time setting for BB_XTAL_PLL_REF_CLK_EN (RX) This field sets the point during a TSM RX sequence (the tsm_count[7:0] value) at which the BB_XTAL_PLL_REF_CLK_EN signal or group will transition from LO to HI. |
| 15-8 BB_XTAL_PLL_REF_CLK_EN_TX_LO | De-assertion time setting for BB_XTAL_PLL_REF_CLK_EN (TX) This field sets the point during a TSM TX sequence (the tsm_count[7:0] value) at which the BB_XTAL_PLL_REF_CLK_EN signal or group will transition from HI to LO. |
| 7-0 BB_XTAL_PLL_REF_CLK_EN_TX_HI | Assertion time setting for BB_XTAL_PLL_REF_CLK_EN (TX) This field sets the point during a TSM TX sequence (the tsm_count[7:0] value) at which the BB_XTAL_PLL_REF_CLK_EN signal or group will transition from LO to HI. |

45.4.5.3.1.25 **TSM_TIMING11 (TIMING11)**45.4.5.3.1.25.1 *Address*

| Register | Offset |
|----------|-----------|
| TIMING11 | 4005C31Ch |

FSK Modulator

45.4.5.3.1.25.2 Diagram

| | | | | | | | | | | | | | | | | | |
|-------|------------------------------|----|----|----|----|----|----|----|------------------------------|----|----|----|----|----|----|----|----|
| Bits | 31 | 30 | 29 | 28 | 27 | 26 | 25 | 24 | | 23 | 22 | 21 | 20 | 19 | 18 | 17 | 16 |
| R | 1 | | | | | | | | | | | | | | | | |
| W | | | | | | | | | | | | | | | | | |
| Reset | 1 | 1 | 1 | 1 | 1 | 1 | 1 | 1 | | 1 | 1 | 1 | 1 | 1 | 1 | 1 | 1 |
| Bits | 15 | 14 | 13 | 12 | 11 | 10 | 9 | 8 | | 7 | 6 | 5 | 4 | 3 | 2 | 1 | 0 |
| R | BB_XTAL_DAC_REF_CLK_EN_TX_LO | | | | | | | | BB_XTAL_DAC_REF_CLK_EN_TX_HI | | | | | | | | |
| W | | | | | | | | | | | | | | | | | |
| Reset | 0 | 1 | 1 | 0 | 1 | 0 | 1 | 0 | | 0 | 0 | 0 | 0 | 0 | 0 | 1 | 1 |

45.4.5.3.1.25.3 Fields

| Field | Function |
|--------------------------------------|---|
| 31-16 — | Reserved |
| 15-8 BB_XTAL_DAC_REF_CLK_EN_TX_LO | De-assertion time setting for BB_XTAL_DAC_REF_CLK_EN (TX) This field sets the point during a TSM TX sequence (the tsm_count[7:0] value) at which the BB_XTAL_DAC_REF_CLK_EN signal or group will transition from HI to LO. |
| 7-0 BB_XTAL_DAC_REF_CLK_EN_TX_HI | Assertion time setting for BB_XTAL_DAC_REF_CLK_EN (TX) This field sets the point during a TSM TX sequence (the tsm_count[7:0] value) at which the BB_XTAL_DAC_REF_CLK_EN signal or group will transition from LO to HI. |

45.4.5.3.1.26 TSM_TIMING12 (TIMING12)

45.4.5.3.1.26.1 Address

| Register | Offset |
|----------|-----------|
| TIMING12 | 4005C320h |

45.4.5.3.1.26.2 Diagram

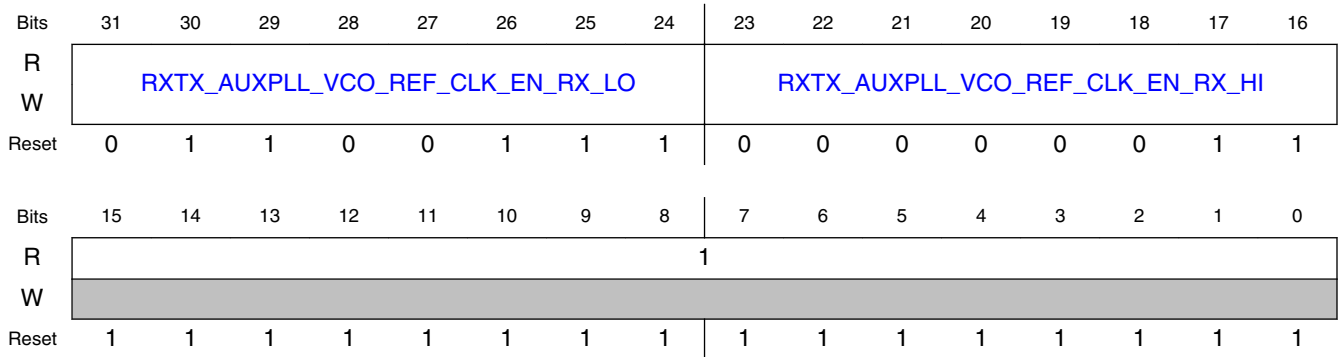

45.4.5.3.1.26.3 Fields

| Field | Function |
|---|---|
| 31-24 RXTX_AUXPLL_VCO_REF_CLK_EN_RX_LO | De-assertion time setting for RXTX_AUXPLL_VCO_REF_CLK_EN (RX) This field sets the point during a TSM RX sequence (the tsm_count[7:0] value) at which the RXTX_AUXPLL_VCO_REF_CLK_EN signal or group will transition from HI to LO. |
| 23-16 RXTX_AUXPLL_VCO_REF_CLK_EN_RX_HI | Assertion time setting for RXTX_AUXPLL_VCO_REF_CLK_EN (RX) This field sets the point during a TSM RX sequence (the tsm_count[7:0] value) at which the RXTX_AUXPLL_VCO_REF_CLK_EN signal or group will transition from LO to HI. |
| 15-0 — | Reserved |

45.4.5.3.1.27 TSM_TIMING13 (TIMING13)

45.4.5.3.1.27.1 Address

| Register | Offset |
|----------|-----------|
| TIMING13 | 4005C324h |

FSK Modulator

45.4.5.3.1.27.2 Diagram

| | | | | | | | | | | | | | | | | |
|-------|--------------------------|----|----|----|----|----|----|----|--------------------------|----|----|----|----|----|----|----|
| Bits | 31 | 30 | 29 | 28 | 27 | 26 | 25 | 24 | 23 | 22 | 21 | 20 | 19 | 18 | 17 | 16 |
| R | SY_VCO_AUTOTUNE_EN_RX_LO | | | | | | | | SY_VCO_AUTOTUNE_EN_RX_HI | | | | | | | |
| W | | | | | | | | | | | | | | | | |
| Reset | 0 | 0 | 0 | 1 | 0 | 1 | 1 | 0 | 0 | 0 | 0 | 0 | 0 | 0 | 0 | 0 |
| Bits | 15 | 14 | 13 | 12 | 11 | 10 | 9 | 8 | 7 | 6 | 5 | 4 | 3 | 2 | 1 | 0 |
| R | SY_VCO_AUTOTUNE_EN_TX_LO | | | | | | | | SY_VCO_AUTOTUNE_EN_TX_HI | | | | | | | |
| W | | | | | | | | | | | | | | | | |
| Reset | 0 | 1 | 0 | 0 | 1 | 0 | 1 | 0 | 0 | 0 | 0 | 0 | 0 | 0 | 0 | 0 |

45.4.5.3.1.27.3 Fields

| Field | Function |
|---|---|
| 31-24 SY_VCO_AUTO TUNE_EN_RX_ LO | De-assertion time setting for SY_VCO_AUTOTUNE_EN (RX) This field sets the point during a TSM RX sequence (the tsm_count[7:0] value) at which the SY_VCO_AUTOTUNE_EN signal or group will transition from HI to LO. |
| 23-16 SY_VCO_AUTO TUNE_EN_RX_ HI | Assertion time setting for SY_VCO_AUTOTUNE_EN (RX) This field sets the point during a TSM RX sequence (the tsm_count[7:0] value) at which the SY_VCO_AUTOTUNE_EN signal or group will transition from LO to HI. |
| 15-8 SY_VCO_AUTO TUNE_EN_TX_ LO | De-assertion time setting for SY_VCO_AUTOTUNE_EN (TX) This field sets the point during a TSM TX sequence (the tsm_count[7:0] value) at which the SY_VCO_AUTOTUNE_EN signal or group will transition from HI to LO. |
| 7-0 SY_VCO_AUTO TUNE_EN_TX_ HI | Assertion time setting for SY_VCO_AUTOTUNE_EN (TX) This field sets the point during a TSM TX sequence (the tsm_count[7:0] value) at which the SY_VCO_AUTOTUNE_EN signal or group will transition from LO to HI. |

45.4.5.3.1.28 TSM_TIMING14 (TIMING14)

45.4.5.3.1.28.1 Address

| Register | Offset |
|----------|-----------|
| TIMING14 | 4005C328h |

45.4.5.3.1.28.2 *Diagram*

| | | | | | | | | | | | | | | | | |
|-------|---------------------------------|----|----|----|----|----|----|----|---------------------------------|----|----|----|----|----|----|----|
| Bits | 31 | 30 | 29 | 28 | 27 | 26 | 25 | 24 | 23 | 22 | 21 | 20 | 19 | 18 | 17 | 16 |
| R | SY_PD_CYCLE_SLIP_LD_FT_EN_RX_LO | | | | | | | | SY_PD_CYCLE_SLIP_LD_FT_EN_RX_HI | | | | | | | |
| W | | | | | | | | | | | | | | | | |
| Reset | 0 | 1 | 1 | 0 | 0 | 1 | 1 | 1 | 0 | 0 | 1 | 0 | 1 | 1 | 1 | 1 |
| Bits | 15 | 14 | 13 | 12 | 11 | 10 | 9 | 8 | 7 | 6 | 5 | 4 | 3 | 2 | 1 | 0 |
| R | SY_PD_CYCLE_SLIP_LD_FT_EN_TX_LO | | | | | | | | SY_PD_CYCLE_SLIP_LD_FT_EN_TX_HI | | | | | | | |
| W | | | | | | | | | | | | | | | | |
| Reset | 0 | 1 | 1 | 0 | 0 | 1 | 0 | 0 | 0 | 1 | 0 | 1 | 1 | 1 | 1 | 1 |

45.4.5.3.1.28.3 *Fields*

| Field | Function |
|--|---|
| 31-24 SY_PD_CYCLE_SLIP_LD_FT_EN_RX_LO | De-assertion time setting for SY_PD_CYCLE_SLIP_LD_FT_EN (RX) This field sets the point during a TSM RX sequence (the tsm_count[7:0] value) at which the SY_PD_CYCLE_SLIP_LD_FT_EN signal or group will transition from HI to LO. |
| 23-16 SY_PD_CYCLE_SLIP_LD_FT_EN_RX_HI | Assertion time setting for SY_PD_CYCLE_SLIP_LD_FT_EN (RX) This field sets the point during a TSM RX sequence (the tsm_count[7:0] value) at which the SY_PD_CYCLE_SLIP_LD_FT_EN signal or group will transition from LO to HI. |
| 15-8 SY_PD_CYCLE_SLIP_LD_FT_EN_TX_LO | De-assertion time setting for SY_PD_CYCLE_SLIP_LD_FT_EN (TX) This field sets the point during a TSM TX sequence (the tsm_count[7:0] value) at which the SY_PD_CYCLE_SLIP_LD_FT_EN signal or group will transition from HI to LO. |
| 7-0 SY_PD_CYCLE_SLIP_LD_FT_EN_TX_HI | Assertion time setting for SY_PD_CYCLE_SLIP_LD_FT_EN (TX) This field sets the point during a TSM TX sequence (the tsm_count[7:0] value) at which the SY_PD_CYCLE_SLIP_LD_FT_EN signal or group will transition from LO to HI. |

45.4.5.3.1.29 **TSM_TIMING15 (TIMING15)**45.4.5.3.1.29.1 *Address*

| Register | Offset |
|----------|-----------|
| TIMING15 | 4005C32Ch |

FSK Modulator

45.4.5.3.1.29.2 Diagram

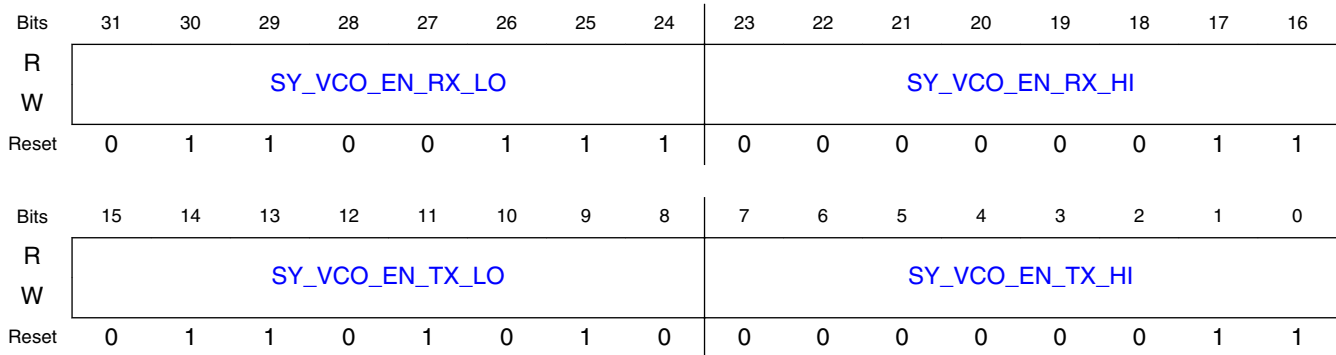

45.4.5.3.1.29.3 Fields

| Field | Function |
|--------------------------|---|
| 31-24 SY_VCO_EN_RX_LO | De-assertion time setting for SY_VCO_EN (RX) This field sets the point during a TSM RX sequence (the tsm_count[7:0] value) at which the SY_VCO_EN signal or group will transition from HI to LO. |
| 23-16 SY_VCO_EN_RX_HI | Assertion time setting for SY_VCO_EN (RX) This field sets the point during a TSM RX sequence (the tsm_count[7:0] value) at which the SY_VCO_EN signal or group will transition from LO to HI. |
| 15-8 SY_VCO_EN_TX_LO | De-assertion time setting for SY_VCO_EN (TX) This field sets the point during a TSM TX sequence (the tsm_count[7:0] value) at which the SY_VCO_EN signal or group will transition from HI to LO. |
| 7-0 SY_VCO_EN_TX_HI | Assertion time setting for SY_VCO_EN (TX) This field sets the point during a TSM TX sequence (the tsm_count[7:0] value) at which the SY_VCO_EN signal or group will transition from LO to HI. |

45.4.5.3.1.30 TSM_TIMING16 (TIMING16)

45.4.5.3.1.30.1 Address

| Register | Offset |
|----------|-----------|
| TIMING16 | 4005C330h |

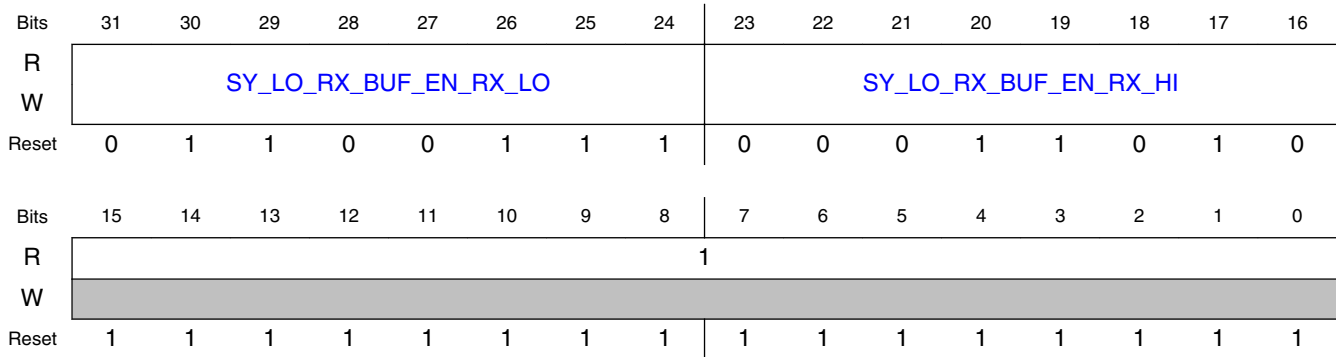
45.4.5.3.1.30.2 *Diagram*45.4.5.3.1.30.3 *Fields*

| Field | Function |
|--------------------------------|---|
| 31-24 SY_LO_RX_BUF_EN_RX_LO | De-assertion time setting for SY_LO_RX_BUF_EN (RX) This field sets the point during a TSM RX sequence (the tsm_count[7:0] value) at which the SY_LO_RX_BUF_EN signal or group will transition from HI to LO. |
| 23-16 SY_LO_RX_BUF_EN_RX_HI | Assertion time setting for SY_LO_RX_BUF_EN (RX) This field sets the point during a TSM RX sequence (the tsm_count[7:0] value) at which the SY_LO_RX_BUF_EN signal or group will transition from LO to HI. |
| 15-0 — | Reserved |

45.4.5.3.1.31 **TSM_TIMING17 (TIMING17)**45.4.5.3.1.31.1 *Address*

| Register | Offset |
|----------|-----------|
| TIMING17 | 4005C334h |

FSK Modulator

45.4.5.3.1.31.2 Diagram

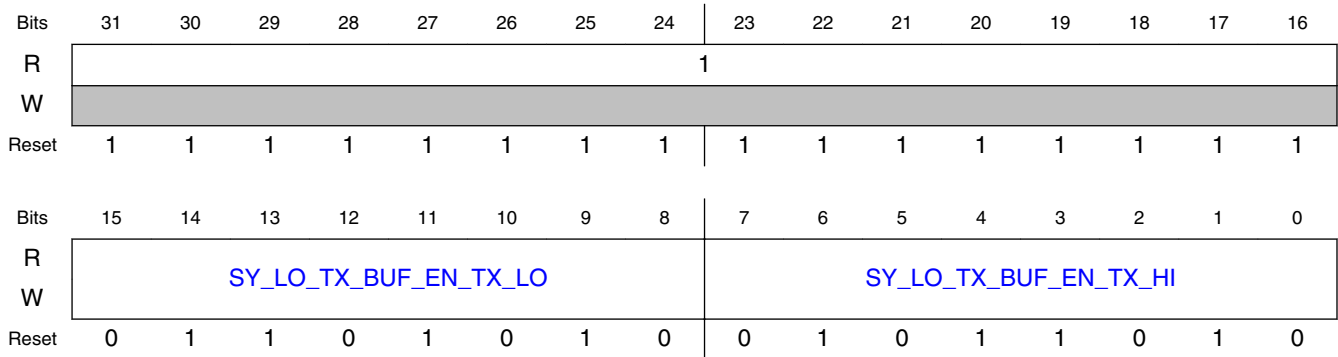

45.4.5.3.1.31.3 Fields

| Field | Function |
|-------------------------------|---|
| 31-16 — | Reserved |
| 15-8 SY_LO_TX_BUF_EN_TX_LO | De-assertion time setting for SY_LO_TX_BUF_EN (TX) This field sets the point during a TSM TX sequence (the tsm_count[7:0] value) at which the SY_LO_TX_BUF_EN signal or group will transition from HI to LO. |
| 7-0 SY_LO_TX_BUF_EN_TX_HI | Assertion time setting for SY_LO_TX_BUF_EN (TX) This field sets the point during a TSM TX sequence (the tsm_count[7:0] value) at which the SY_LO_TX_BUF_EN signal or group will transition from LO to HI. |

45.4.5.3.1.32 TSM_TIMING18 (TIMING18)

45.4.5.3.1.32.1 Address

| Register | Offset |
|----------|-----------|
| TIMING18 | 4005C338h |

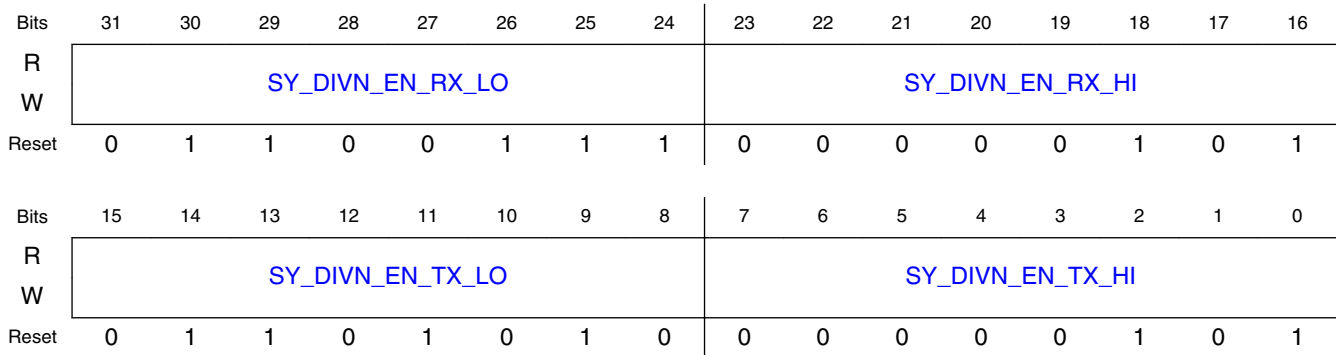
45.4.5.3.1.32.2 *Diagram*45.4.5.3.1.32.3 *Fields*

| Field | Function |
|---------------------------|---|
| 31-24 SY_DIVN_EN_RX_LO | De-assertion time setting for SY_DIVN_EN (RX) This field sets the point during a TSM RX sequence (the tsm_count[7:0] value) at which the SY_DIVN_EN signal or group will transition from HI to LO. |
| 23-16 SY_DIVN_EN_RX_HI | Assertion time setting for SY_DIVN_EN (RX) This field sets the point during a TSM RX sequence (the tsm_count[7:0] value) at which the SY_DIVN_EN signal or group will transition from LO to HI. |
| 15-8 SY_DIVN_EN_TX_LO | De-assertion time setting for SY_DIVN_EN (TX) This field sets the point during a TSM TX sequence (the tsm_count[7:0] value) at which the SY_DIVN_EN signal or group will transition from HI to LO. |
| 7-0 SY_DIVN_EN_TX_HI | Assertion time setting for SY_DIVN_EN (TX) This field sets the point during a TSM TX sequence (the tsm_count[7:0] value) at which the SY_DIVN_EN signal or group will transition from LO to HI. |

45.4.5.3.1.33 **TSM_TIMING19 (TIMING19)**45.4.5.3.1.33.1 *Address*

| Register | Offset |
|----------|-----------|
| TIMING19 | 4005C33Ch |

FSK Modulator

45.4.5.3.1.33.2 Diagram

| | | | | | | | | | | | | | | | | |
|-------|------------------------------|----|----|----|----|----|----|----|------------------------------|----|----|----|----|----|----|----|
| Bits | 31 | 30 | 29 | 28 | 27 | 26 | 25 | 24 | 23 | 22 | 21 | 20 | 19 | 18 | 17 | 16 |
| R | SY_PD_FILTER_CHARGE_EN_RX_LO | | | | | | | | SY_PD_FILTER_CHARGE_EN_RX_HI | | | | | | | |
| W | | | | | | | | | | | | | | | | |
| Reset | 0 | 0 | 0 | 1 | 0 | 1 | 1 | 0 | 0 | 0 | 0 | 0 | 0 | 1 | 0 | 1 |
| Bits | 15 | 14 | 13 | 12 | 11 | 10 | 9 | 8 | 7 | 6 | 5 | 4 | 3 | 2 | 1 | 0 |
| R | SY_PD_FILTER_CHARGE_EN_TX_LO | | | | | | | | SY_PD_FILTER_CHARGE_EN_TX_HI | | | | | | | |
| W | | | | | | | | | | | | | | | | |
| Reset | 0 | 1 | 0 | 0 | 1 | 0 | 1 | 0 | 0 | 0 | 0 | 0 | 0 | 1 | 0 | 1 |

45.4.5.3.1.33.3 Fields

| Field | Function |
|---------------------------------------|---|
| 31-24 SY_PD_FILTER_CHARGE_EN_RX_LO | De-assertion time setting for SY_PD_FILTER_CHARGE_EN (RX) This field sets the point during a TSM RX sequence (the tsm_count[7:0] value) at which the SY_PD_FILTER_CHARGE_EN signal or group will transition from HI to LO. |
| 23-16 SY_PD_FILTER_CHARGE_EN_RX_HI | Assertion time setting for SY_PD_FILTER_CHARGE_EN (RX) This field sets the point during a TSM RX sequence (the tsm_count[7:0] value) at which the SY_PD_FILTER_CHARGE_EN signal or group will transition from LO to HI. |
| 15-8 SY_PD_FILTER_CHARGE_EN_TX_LO | De-assertion time setting for SY_PD_FILTER_CHARGE_EN (TX) This field sets the point during a TSM TX sequence (the tsm_count[7:0] value) at which the SY_PD_FILTER_CHARGE_EN signal or group will transition from HI to LO. |
| 7-0 SY_PD_FILTER_CHARGE_EN_TX_HI | Assertion time setting for SY_PD_FILTER_CHARGE_EN (TX) This field sets the point during a TSM TX sequence (the tsm_count[7:0] value) at which the SY_PD_FILTER_CHARGE_EN signal or group will transition from LO to HI. |

45.4.5.3.1.34 TSM_TIMING20 (TIMING20)

45.4.5.3.1.34.1 Address

| Register | Offset |
|----------|-----------|
| TIMING20 | 4005C340h |

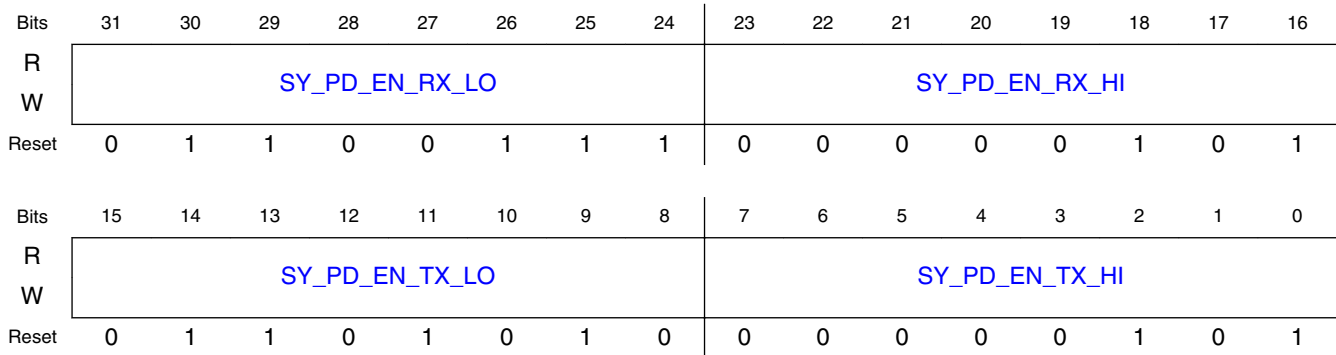
45.4.5.3.1.34.2 *Diagram*45.4.5.3.1.34.3 *Fields*

| Field | Function |
|-------------------------|---|
| 31-24 SY_PD_EN_RX_LO | De-assertion time setting for SY_PD_EN (RX) This field sets the point during a TSM RX sequence (the tsm_count[7:0] value) at which the SY_PD_EN signal or group will transition from HI to LO. |
| 23-16 SY_PD_EN_RX_HI | Assertion time setting for SY_PD_EN (RX) This field sets the point during a TSM RX sequence (the tsm_count[7:0] value) at which the SY_PD_EN signal or group will transition from LO to HI. |
| 15-8 SY_PD_EN_TX_LO | De-assertion time setting for SY_PD_EN (TX) This field sets the point during a TSM TX sequence (the tsm_count[7:0] value) at which the SY_PD_EN signal or group will transition from HI to LO. |
| 7-0 SY_PD_EN_TX_HI | Assertion time setting for SY_PD_EN (TX) This field sets the point during a TSM TX sequence (the tsm_count[7:0] value) at which the SY_PD_EN signal or group will transition from LO to HI. |

45.4.5.3.1.35 **TSM_TIMING21 (TIMING21)**45.4.5.3.1.35.1 *Address*

| Register | Offset |
|----------|-----------|
| TIMING21 | 4005C344h |

FSK Modulator

45.4.5.3.1.35.2 Diagram

| | | | | | | | | | | | | | | | | |
|-------|---------------------|----|----|----|----|----|----|----|---------------------|----|----|----|----|----|----|----|
| Bits | 31 | 30 | 29 | 28 | 27 | 26 | 25 | 24 | 23 | 22 | 21 | 20 | 19 | 18 | 17 | 16 |
| R | SY_LO_DIVN_EN_RX_LO | | | | | | | | SY_LO_DIVN_EN_RX_HI | | | | | | | |
| W | | | | | | | | | | | | | | | | |
| Reset | 0 | 1 | 1 | 0 | 0 | 1 | 1 | 1 | 0 | 0 | 0 | 0 | 0 | 1 | 0 | 0 |
| | | | | | | | | | | | | | | | | |
| Bits | 15 | 14 | 13 | 12 | 11 | 10 | 9 | 8 | 7 | 6 | 5 | 4 | 3 | 2 | 1 | 0 |
| R | SY_LO_DIVN_EN_TX_LO | | | | | | | | SY_LO_DIVN_EN_TX_HI | | | | | | | |
| W | | | | | | | | | | | | | | | | |
| Reset | 0 | 1 | 1 | 0 | 1 | 0 | 1 | 0 | 0 | 0 | 0 | 0 | 0 | 1 | 0 | 0 |

45.4.5.3.1.35.3 Fields

| Field | Function |
|------------------------------|---|
| 31-24 SY_LO_DIVN_EN_RX_LO | De-assertion time setting for SY_LO_DIVN_EN (RX) This field sets the point during a TSM RX sequence (the tsm_count[7:0] value) at which the SY_LO_DIVN_EN signal or group will transition from HI to LO. |
| 23-16 SY_LO_DIVN_EN_RX_HI | Assertion time setting for SY_LO_DIVN_EN (RX) This field sets the point during a TSM RX sequence (the tsm_count[7:0] value) at which the SY_LO_DIVN_EN signal or group will transition from LO to HI. |
| 15-8 SY_LO_DIVN_EN_TX_LO | De-assertion time setting for SY_LO_DIVN_EN (TX) This field sets the point during a TSM TX sequence (the tsm_count[7:0] value) at which the SY_LO_DIVN_EN signal or group will transition from HI to LO. |
| 7-0 SY_LO_DIVN_EN_TX_HI | Assertion time setting for SY_LO_DIVN_EN (TX) This field sets the point during a TSM TX sequence (the tsm_count[7:0] value) at which the SY_LO_DIVN_EN signal or group will transition from LO to HI. |

45.4.5.3.1.36 TSM_TIMING22 (TIMING22)

45.4.5.3.1.36.1 Address

| Register | Offset |
|----------|-----------|
| TIMING22 | 4005C348h |

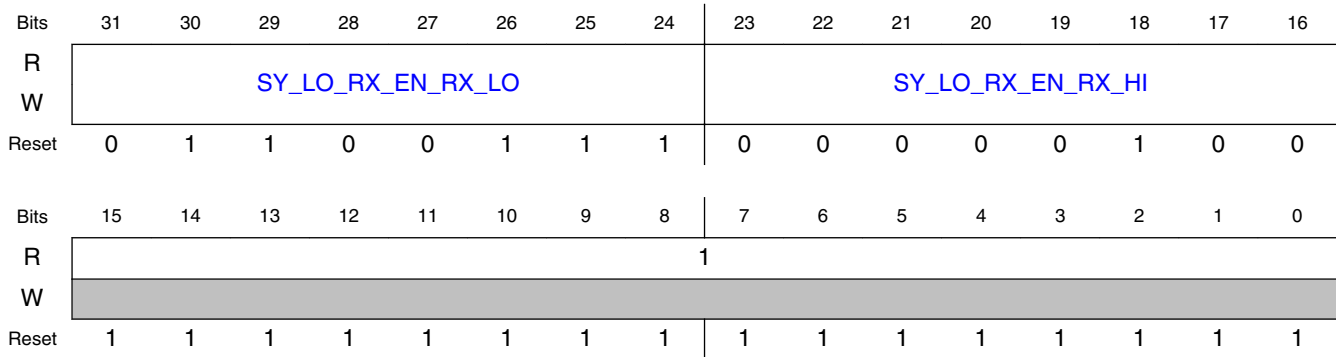
45.4.5.3.1.36.2 *Diagram*45.4.5.3.1.36.3 *Fields*

| Field | Function |
|----------------------------|---|
| 31-24 SY_LO_RX_EN_RX_LO | De-assertion time setting for SY_LO_RX_EN (RX) This field sets the point during a TSM RX sequence (the tsm_count[7:0] value) at which the SY_LO_RX_EN signal or group will transition from HI to LO. |
| 23-16 SY_LO_RX_EN_RX_HI | Assertion time setting for SY_LO_RX_EN (RX) This field sets the point during a TSM RX sequence (the tsm_count[7:0] value) at which the SY_LO_RX_EN signal or group will transition from LO to HI. |
| 15-0 — | Reserved |

45.4.5.3.1.37 **TSM_TIMING23 (TIMING23)**45.4.5.3.1.37.1 *Address*

| Register | Offset |
|----------|-----------|
| TIMING23 | 4005C34Ch |

FSK Modulator

45.4.5.3.1.37.2 Diagram

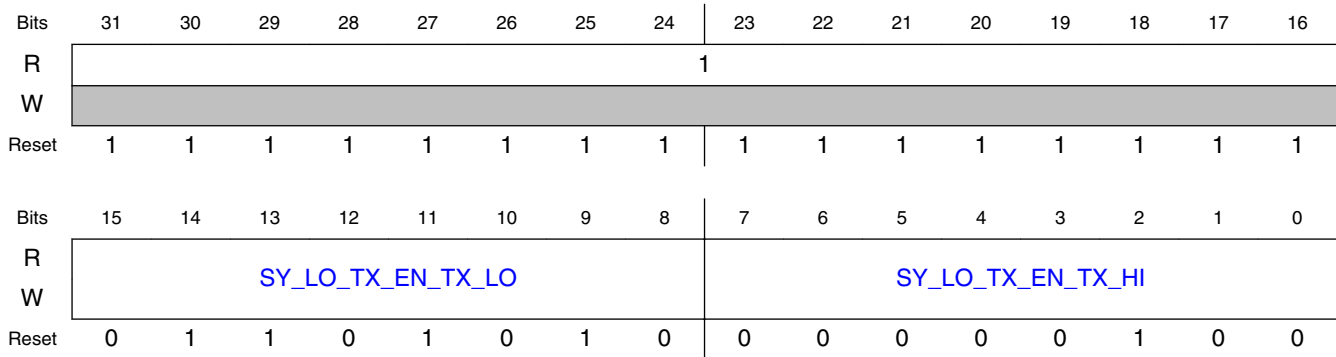

45.4.5.3.1.37.3 Fields

| Field | Function |
|-------------------------------|---|
| 31-16 — | Reserved |
| 15-8 SY_LO_TX_EN _TX_LO | De-assertion time setting for SY_LO_TX_EN (TX) This field sets the point during a TSM TX sequence (the tsm_count[7:0] value) at which the SY_LO_TX_EN signal or group will transition from HI to LO. |
| 7-0 SY_LO_TX_EN _TX_HI | Assertion time setting for SY_LO_TX_EN (TX) This field sets the point during a TSM TX sequence (the tsm_count[7:0] value) at which the SY_LO_TX_EN signal or group will transition from LO to HI. |

45.4.5.3.1.38 TSM_TIMING24 (TIMING24)

45.4.5.3.1.38.1 Address

| Register | Offset |
|----------|-----------|
| TIMING24 | 4005C350h |

45.4.5.3.1.38.2 *Diagram*

| | | | | | | | | | | | | | | | | |
|-------|----------------------|----|----|----|----|----|----|----|----------------------|----|----|----|----|----|----|----|
| Bits | 31 | 30 | 29 | 28 | 27 | 26 | 25 | 24 | 23 | 22 | 21 | 20 | 19 | 18 | 17 | 16 |
| R | SY_DIVN_CAL_EN_RX_LO | | | | | | | | SY_DIVN_CAL_EN_RX_HI | | | | | | | |
| W | | | | | | | | | | | | | | | | |
| Reset | 0 | 0 | 0 | 1 | 0 | 1 | 1 | 0 | 0 | 0 | 0 | 0 | 0 | 0 | 0 | 0 |
| Bits | 15 | 14 | 13 | 12 | 11 | 10 | 9 | 8 | 7 | 6 | 5 | 4 | 3 | 2 | 1 | 0 |
| R | SY_DIVN_CAL_EN_TX_LO | | | | | | | | SY_DIVN_CAL_EN_TX_HI | | | | | | | |
| W | | | | | | | | | | | | | | | | |
| Reset | 0 | 1 | 0 | 0 | 1 | 0 | 1 | 0 | 0 | 0 | 0 | 0 | 0 | 0 | 0 | 0 |

45.4.5.3.1.38.3 *Fields*

| Field | Function |
|-------------------------------|---|
| 31-24 SY_DIVN_CAL_EN_RX_LO | De-assertion time setting for SY_DIVN_CAL_EN (RX) This field sets the point during a TSM RX sequence (the tsm_count[7:0] value) at which the SY_DIVN_CAL_EN signal or group will transition from HI to LO. |
| 23-16 SY_DIVN_CAL_EN_RX_HI | Assertion time setting for SY_DIVN_CAL_EN (RX) This field sets the point during a TSM RX sequence (the tsm_count[7:0] value) at which the SY_DIVN_CAL_EN signal or group will transition from LO to HI. |
| 15-8 SY_DIVN_CAL_EN_TX_LO | De-assertion time setting for SY_DIVN_CAL_EN (TX) This field sets the point during a TSM TX sequence (the tsm_count[7:0] value) at which the SY_DIVN_CAL_EN signal or group will transition from HI to LO. |
| 7-0 SY_DIVN_CAL_EN_TX_HI | Assertion time setting for SY_DIVN_CAL_EN (TX) This field sets the point during a TSM TX sequence (the tsm_count[7:0] value) at which the SY_DIVN_CAL_EN signal or group will transition from LO to HI. |

45.4.5.3.1.39 **TSM_TIMING25 (TIMING25)**45.4.5.3.1.39.1 *Address*

| Register | Offset |
|----------|-----------|
| TIMING25 | 4005C354h |

FSK Modulator

45.4.5.3.1.39.2 Diagram

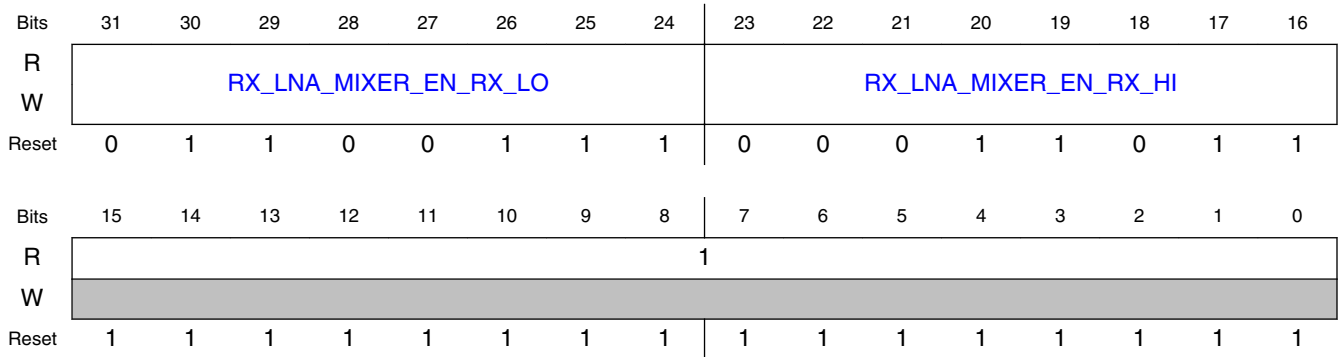

45.4.5.3.1.39.3 Fields

| Field | Function |
|--------------------------------|---|
| 31-24 RX_LNA_MIXER_EN_RX_LO | De-assertion time setting for RX_LNA_MIXER_EN (RX) This field sets the point during a TSM RX sequence (the tsm_count[7:0] value) at which the RX_LNA_MIXER_EN signal or group will transition from HI to LO. |
| 23-16 RX_LNA_MIXER_EN_RX_HI | Assertion time setting for RX_LNA_MIXER_EN (RX) This field sets the point during a TSM RX sequence (the tsm_count[7:0] value) at which the RX_LNA_MIXER_EN signal or group will transition from LO to HI. |
| 15-0 — | Reserved |

45.4.5.3.1.40 TSM_TIMING26 (TIMING26)

45.4.5.3.1.40.1 Address

| Register | Offset |
|----------|-----------|
| TIMING26 | 4005C358h |

45.4.5.3.1.40.2 Diagram

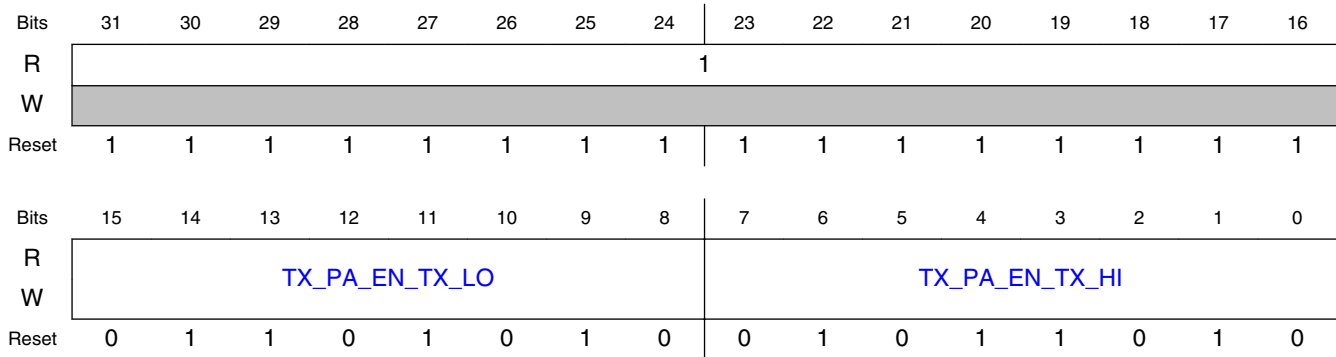

45.4.5.3.1.40.3 Fields

| Field | Function |
|------------------------|---|
| 31-16 — | Reserved |
| 15-8 TX_PA_EN_TX_LO | De-assertion time setting for TX_PA_EN (TX) This field sets the point during a TSM TX sequence (the tsm_count[7:0] value) at which the TX_PA_EN signal or group will transition from HI to LO. |
| 7-0 TX_PA_EN_TX_HI | Assertion time setting for TX_PA_EN (TX) This field sets the point during a TSM TX sequence (the tsm_count[7:0] value) at which the TX_PA_EN signal or group will transition from LO to HI. |

45.4.5.3.1.41 TSM_TIMING27 (TIMING27)

45.4.5.3.1.41.1 Address

| Register | Offset |
|----------|-----------|
| TIMING27 | 4005C35Ch |

FSK Modulator

45.4.5.3.1.41.2 Diagram

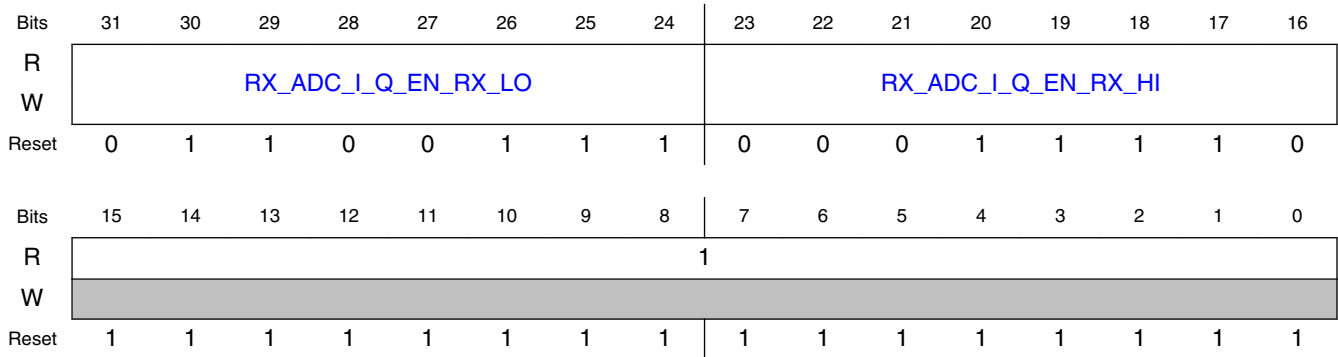

45.4.5.3.1.41.3 Fields

| Field | Function |
|--------------------------------|---|
| 31-24 RX_ADC_I_Q_EN_N_RX_LO | De-assertion time setting for RX_ADC_I_Q_EN (RX) This field sets the point during a TSM RX sequence (the tsm_count[7:0] value) at which the RX_ADC_I_Q_EN signal or group will transition from HI to LO. |
| 23-16 RX_ADC_I_Q_EN_N_RX_HI | Assertion time setting for RX_ADC_I_Q_EN (RX) This field sets the point during a TSM RX sequence (the tsm_count[7:0] value) at which the RX_ADC_I_Q_EN signal or group will transition from LO to HI. |
| 15-0 — | Reserved |

45.4.5.3.1.42 TSM_TIMING28 (TIMING28)

45.4.5.3.1.42.1 Address

| Register | Offset |
|----------|-----------|
| TIMING28 | 4005C360h |

45.4.5.3.1.42.2 *Diagram*

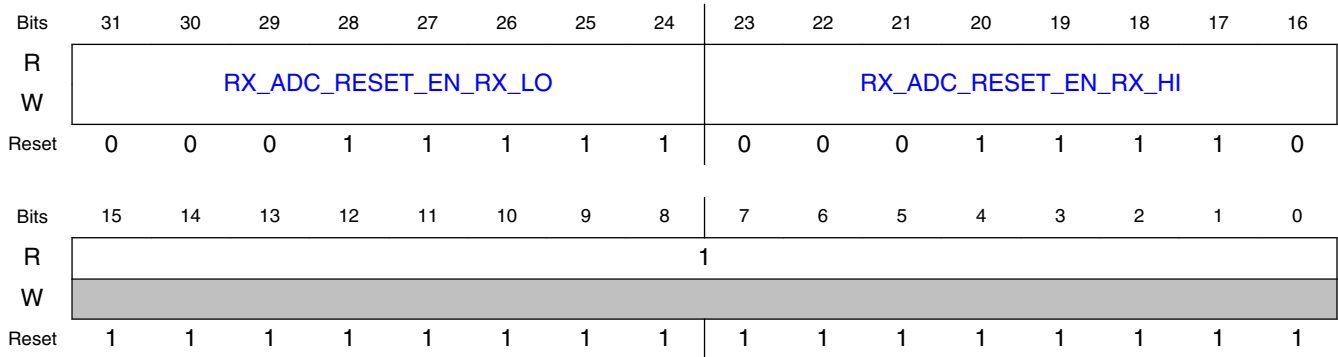

45.4.5.3.1.42.3 *Fields*

| Field | Function |
|------------------------------------|---|
| 31-24 RX_ADC_RESE T_EN_RX_LO | De-assertion time setting for RX_ADC_RESET_EN (RX) This field sets the point during a TSM RX sequence (the tsm_count[7:0] value) at which the RX_ADC_RESET_EN signal or group will transition from HI to LO. |
| 23-16 RX_ADC_RESE T_EN_RX_HI | Assertion time setting for RX_ADC_RESET_EN (RX) This field sets the point during a TSM RX sequence (the tsm_count[7:0] value) at which the RX_ADC_RESET_EN signal or group will transition from LO to HI. |
| 15-0 — | Reserved |

45.4.5.3.1.43 **TSM_TIMING29 (TIMING29)**

45.4.5.3.1.43.1 *Address*

| Register | Offset |
|----------|-----------|
| TIMING29 | 4005C364h |

FSK Modulator

45.4.5.3.1.43.2 Diagram

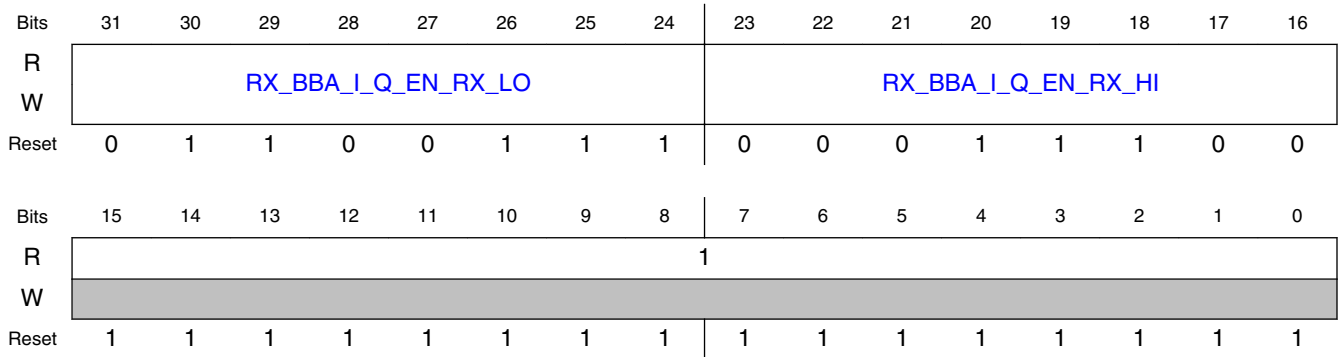

45.4.5.3.1.43.3 Fields

| Field | Function |
|------------------------------|---|
| 31-24 RX_BBA_I_Q_EN_RX_LO | De-assertion time setting for RX_BBA_I_Q_EN (RX) This field sets the point during a TSM RX sequence (the tsm_count[7:0] value) at which the RX_BBA_I_Q_EN signal or group will transition from HI to LO. |
| 23-16 RX_BBA_I_Q_EN_RX_HI | Assertion time setting for RX_BBA_I_Q_EN (RX) This field sets the point during a TSM RX sequence (the tsm_count[7:0] value) at which the RX_BBA_I_Q_EN signal or group will transition from LO to HI. |
| 15-0 — | Reserved |

45.4.5.3.1.44 TSM_TIMING30 (TIMING30)

45.4.5.3.1.44.1 Address

| Register | Offset |
|----------|-----------|
| TIMING30 | 4005C368h |

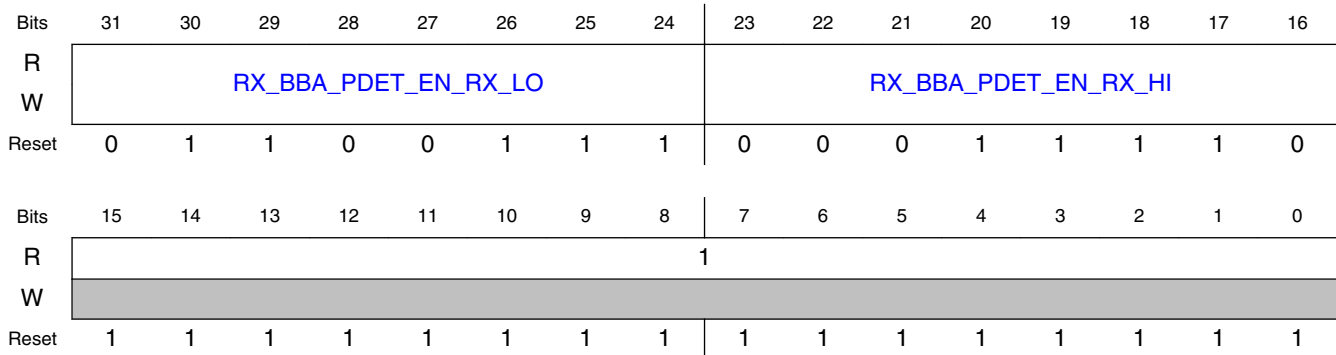
45.4.5.3.1.44.2 *Diagram*45.4.5.3.1.44.3 *Fields*

| Field | Function |
|-------------------------------|---|
| 31-24 RX_BBA_PDET_EN_RX_LO | De-assertion time setting for RX_BBA_PDET_EN (RX) This field sets the point during a TSM RX sequence (the tsm_count[7:0] value) at which the RX_BBA_PDET_EN signal or group will transition from HI to LO. |
| 23-16 RX_BBA_PDET_EN_RX_HI | Assertion time setting for RX_BBA_PDET_EN (RX) This field sets the point during a TSM RX sequence (the tsm_count[7:0] value) at which the RX_BBA_PDET_EN signal or group will transition from LO to HI. |
| 15-0 — | Reserved |

45.4.5.3.1.45 **TSM_TIMING31 (TIMING31)**45.4.5.3.1.45.1 *Address*

| Register | Offset |
|----------|-----------|
| TIMING31 | 4005C36Ch |

FSK Modulator

45.4.5.3.1.45.2 Diagram

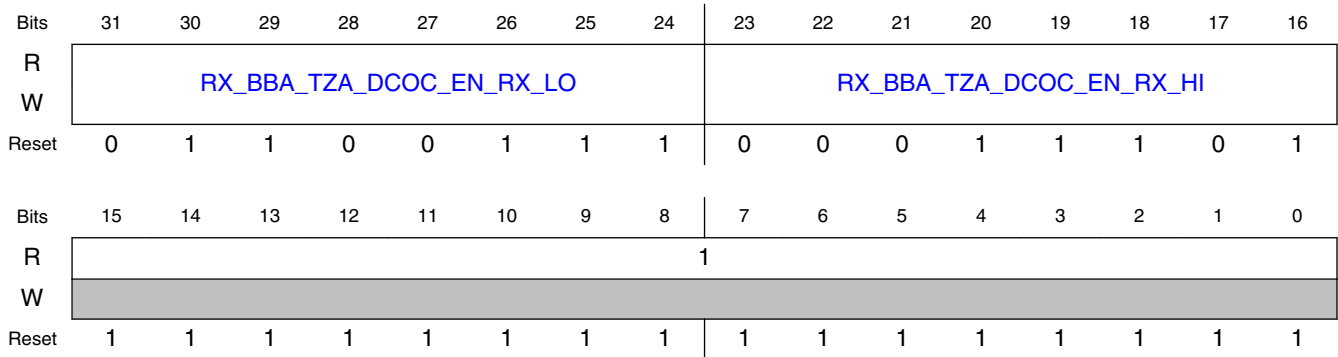

45.4.5.3.1.45.3 Fields

| Field | Function |
|-----------------------------------|---|
| 31-24 RX_BBA_TZA_DCOC_EN_RX_LO | De-assertion time setting for RX_BBA_TZA_DCOC_EN (RX) This field sets the point during a TSM RX sequence (the tsm_count[7:0] value) at which the RX_BBA_TZA_DCOC_EN signal or group will transition from HI to LO. |
| 23-16 RX_BBA_TZA_DCOC_EN_RX_HI | Assertion time setting for RX_BBA_TZA_DCOC_EN (RX) This field sets the point during a TSM RX sequence (the tsm_count[7:0] value) at which the RX_BBA_TZA_DCOC_EN signal or group will transition from LO to HI. |
| 15-0 — | Reserved |

45.4.5.3.1.46 TSM_TIMING32 (TIMING32)

45.4.5.3.1.46.1 Address

| Register | Offset |
|----------|-----------|
| TIMING32 | 4005C370h |

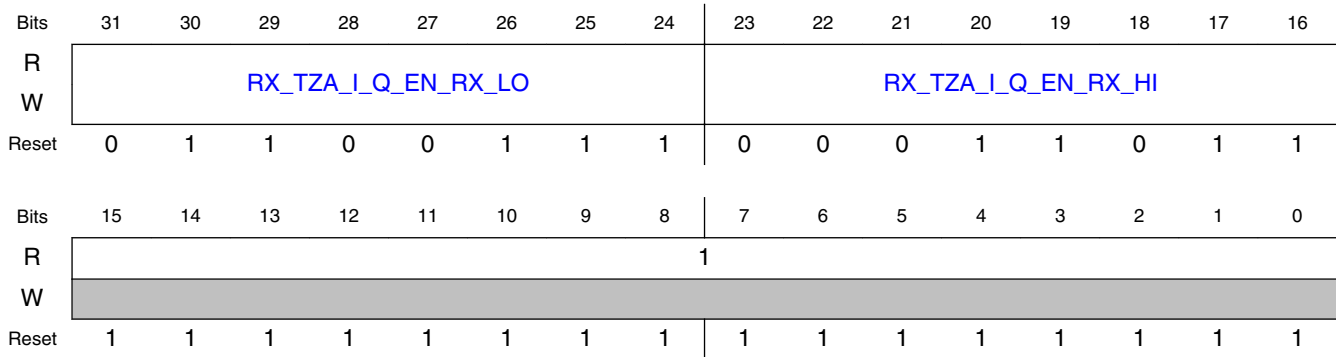
45.4.5.3.1.46.2 *Diagram*45.4.5.3.1.46.3 *Fields*

| Field | Function |
|------------------------------|---|
| 31-24 RX_TZA_I_Q_EN_RX_LO | De-assertion time setting for RX_TZA_I_Q_EN (RX) This field sets the point during a TSM RX sequence (the tsm_count[7:0] value) at which the RX_TZA_I_Q_EN signal or group will transition from HI to LO. |
| 23-16 RX_TZA_I_Q_EN_RX_HI | Assertion time setting for RX_TZA_I_Q_EN (RX) This field sets the point during a TSM RX sequence (the tsm_count[7:0] value) at which the RX_TZA_I_Q_EN signal or group will transition from LO to HI. |
| 15-0 — | Reserved |

45.4.5.3.1.47 **TSM_TIMING33 (TIMING33)**45.4.5.3.1.47.1 *Address*

| Register | Offset |
|----------|-----------|
| TIMING33 | 4005C374h |

FSK Modulator

45.4.5.3.1.47.2 Diagram

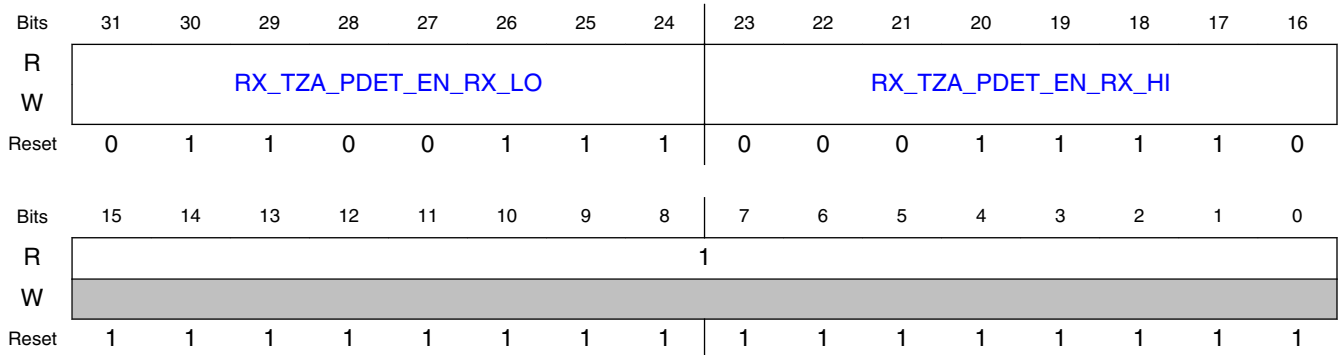

45.4.5.3.1.47.3 Fields

| Field | Function |
|-------------------------------|---|
| 31-24 RX_TZA_PDET_EN_RX_LO | De-assertion time setting for RX_TZA_PDET_EN (RX) This field sets the point during a TSM RX sequence (the tsm_count[7:0] value) at which the RX_TZA_PDET_EN signal or group will transition from HI to LO. |
| 23-16 RX_TZA_PDET_EN_RX_HI | Assertion time setting for RX_TZA_PDET_EN (RX) This field sets the point during a TSM RX sequence (the tsm_count[7:0] value) at which the RX_TZA_PDET_EN signal or group will transition from LO to HI. |
| 15-0 — | Reserved |

45.4.5.3.1.48 TSM_TIMING34 (TIMING34)

45.4.5.3.1.48.1 Address

| Register | Offset |
|----------|-----------|
| TIMING34 | 4005C378h |

45.4.5.3.1.48.2 *Diagram*

| | | | | | | | | | | | | | | | | |
|-------|------------------|----|----|----|----|----|----|----|------------------|----|----|----|----|----|----|----|
| Bits | 31 | 30 | 29 | 28 | 27 | 26 | 25 | 24 | 23 | 22 | 21 | 20 | 19 | 18 | 17 | 16 |
| R | PLL_DIG_EN_RX_LO | | | | | | | | PLL_DIG_EN_RX_HI | | | | | | | |
| W | | | | | | | | | | | | | | | | |
| Reset | 0 | 1 | 1 | 0 | 0 | 1 | 1 | 1 | 0 | 0 | 0 | 0 | 0 | 1 | 0 | 1 |
| Bits | 15 | 14 | 13 | 12 | 11 | 10 | 9 | 8 | 7 | 6 | 5 | 4 | 3 | 2 | 1 | 0 |
| R | PLL_DIG_EN_TX_LO | | | | | | | | PLL_DIG_EN_TX_HI | | | | | | | |
| W | | | | | | | | | | | | | | | | |
| Reset | 0 | 1 | 1 | 0 | 1 | 0 | 1 | 0 | 0 | 0 | 0 | 0 | 0 | 1 | 0 | 1 |

45.4.5.3.1.48.3 *Fields*

| Field | Function |
|---------------------------|---|
| 31-24 PLL_DIG_EN_RX_LO | De-assertion time setting for PLL_DIG_EN (RX) This field sets the point during a TSM RX sequence (the tsm_count[7:0] value) at which the PLL_DIG_EN signal or group will transition from HI to LO. |
| 23-16 PLL_DIG_EN_RX_HI | Assertion time setting for PLL_DIG_EN (RX) This field sets the point during a TSM RX sequence (the tsm_count[7:0] value) at which the PLL_DIG_EN signal or group will transition from LO to HI. |
| 15-8 PLL_DIG_EN_TX_LO | De-assertion time setting for PLL_DIG_EN (TX) This field sets the point during a TSM TX sequence (the tsm_count[7:0] value) at which the PLL_DIG_EN signal or group will transition from HI to LO. |
| 7-0 PLL_DIG_EN_TX_HI | Assertion time setting for PLL_DIG_EN (TX) This field sets the point during a TSM TX sequence (the tsm_count[7:0] value) at which the PLL_DIG_EN signal or group will transition from LO to HI. |

45.4.5.3.1.49 **TSM_TIMING35 (TIMING35)**45.4.5.3.1.49.1 *Address*

| Register | Offset |
|----------|-----------|
| TIMING35 | 4005C37Ch |

FSK Modulator

45.4.5.3.1.49.2 Diagram

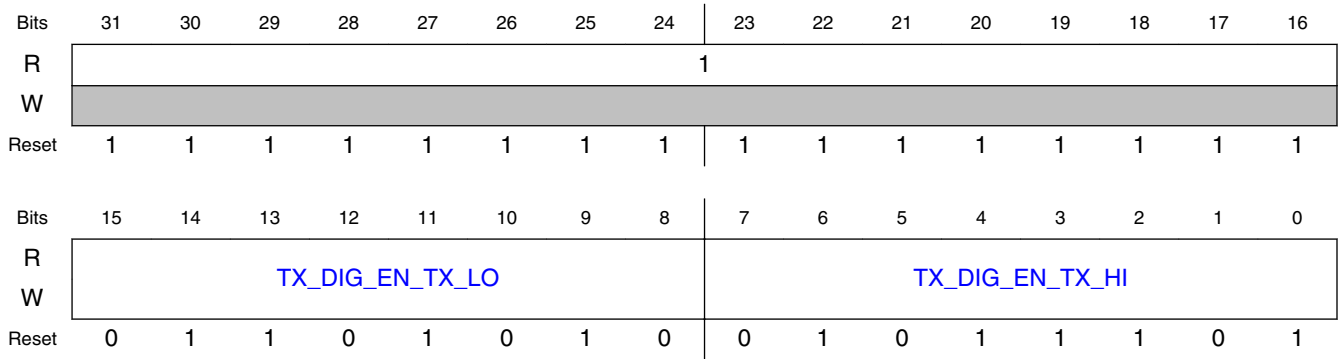

45.4.5.3.1.49.3 Fields

| Field | Function |
|-------------------------|---|
| 31-16 — | Reserved |
| 15-8 TX_DIG_EN_TX_LO | De-assertion time setting for TX_DIG_EN (TX) This field sets the point during a TSM TX sequence (the tsm_count[7:0] value) at which the TX_DIG_EN signal or group will transition from HI to LO. |
| 7-0 TX_DIG_EN_TX_HI | Assertion time setting for TX_DIG_EN (TX) This field sets the point during a TSM TX sequence (the tsm_count[7:0] value) at which the TX_DIG_EN signal or group will transition from LO to HI. |

45.4.5.3.1.50 TSM_TIMING36 (TIMING36)

45.4.5.3.1.50.1 Address

| Register | Offset |
|----------|-----------|
| TIMING36 | 4005C380h |

45.4.5.3.1.50.2 Diagram

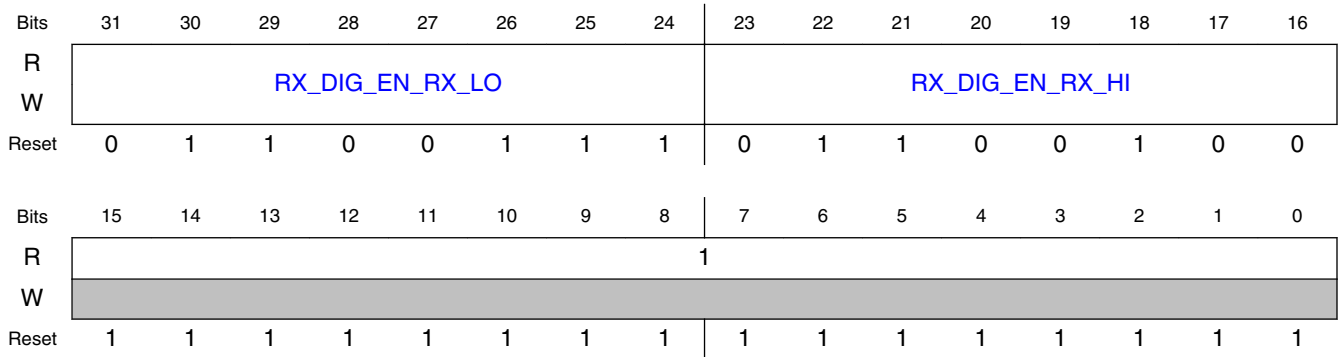

45.4.5.3.1.50.3 Fields

| Field | Function |
|--------------------------|---|
| 31-24 RX_DIG_EN_RX_LO | De-assertion time setting for RX_DIG_EN (RX) This field sets the point during a TSM RX sequence (the tsm_count[7:0] value) at which the RX_DIG_EN signal or group will transition from HI to LO. |
| 23-16 RX_DIG_EN_RX_HI | Assertion time setting for RX_DIG_EN (RX) This field sets the point during a TSM RX sequence (the tsm_count[7:0] value) at which the RX_DIG_EN signal or group will transition from LO to HI. |
| 15-0 — | Reserved |

45.4.5.3.1.51 TSM_TIMING37 (TIMING37)

45.4.5.3.1.51.1 Address

| Register | Offset |
|----------|-----------|
| TIMING37 | 4005C384h |

FSK Modulator

45.4.5.3.1.51.2 Diagram

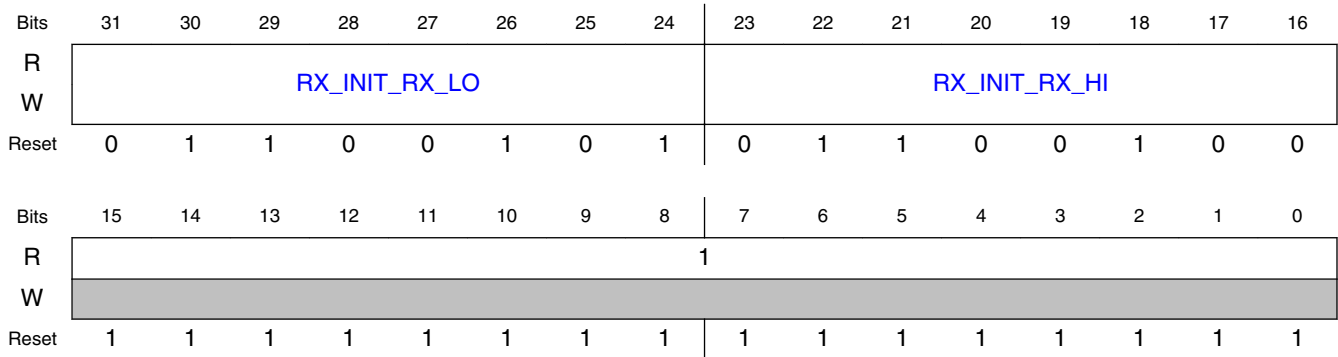

45.4.5.3.1.51.3 Fields

| Field | Function |
|------------------------|---|
| 31-24 RX_INIT_RX_LO | De-assertion time setting for RX_INIT (RX) This field sets the point during a TSM RX sequence (the tsm_count[7:0] value) at which the RX_INIT signal or group will transition from HI to LO. |
| 23-16 RX_INIT_RX_HI | Assertion time setting for RX_INIT (RX) This field sets the point during a TSM RX sequence (the tsm_count[7:0] value) at which the RX_INIT signal or group will transition from LO to HI. |
| 15-0 — | Reserved |

45.4.5.3.1.52 TSM_TIMING38 (TIMING38)

45.4.5.3.1.52.1 Address

| Register | Offset |
|----------|-----------|
| TIMING38 | 4005C388h |

45.4.5.3.1.52.2 *Diagram*

| | | | | | | | | | | | | | | | | |
|-------|----------------------|----|----|----|----|----|----|----|----------------------|----|----|----|----|----|----|----|
| Bits | 31 | 30 | 29 | 28 | 27 | 26 | 25 | 24 | 23 | 22 | 21 | 20 | 19 | 18 | 17 | 16 |
| R | SIGMA_DELTA_EN_RX_LO | | | | | | | | SIGMA_DELTA_EN_RX_HI | | | | | | | |
| W | | | | | | | | | | | | | | | | |
| Reset | 0 | 1 | 1 | 0 | 0 | 1 | 1 | 1 | 0 | 0 | 0 | 0 | 1 | 1 | 0 | 0 |
| Bits | 15 | 14 | 13 | 12 | 11 | 10 | 9 | 8 | 7 | 6 | 5 | 4 | 3 | 2 | 1 | 0 |
| R | SIGMA_DELTA_EN_TX_LO | | | | | | | | SIGMA_DELTA_EN_TX_HI | | | | | | | |
| W | | | | | | | | | | | | | | | | |
| Reset | 0 | 1 | 1 | 0 | 1 | 0 | 1 | 0 | 0 | 1 | 0 | 0 | 0 | 0 | 0 | 0 |

45.4.5.3.1.52.3 *Fields*

| Field | Function |
|----------------------|--|
| 31-24 | De-assertion time setting for SIGMA_DELTA_EN (RX) |
| SIGMA_DELTA_EN_RX_LO | This field sets the point during a TSM RX sequence (the tsm_count[7:0] value) at which the SIGMA_DELTA_EN signal or group will transition from HI to LO. |
| 23-16 | Assertion time setting for SIGMA_DELTA_EN (RX) |
| SIGMA_DELTA_EN_RX_HI | This field sets the point during a TSM RX sequence (the tsm_count[7:0] value) at which the SIGMA_DELTA_EN signal or group will transition from LO to HI. |
| 15-8 | De-assertion time setting for SIGMA_DELTA_EN (TX) |
| SIGMA_DELTA_EN_TX_LO | This field sets the point during a TSM TX sequence (the tsm_count[7:0] value) at which the SIGMA_DELTA_EN signal or group will transition from HI to LO. |
| 7-0 | Assertion time setting for SIGMA_DELTA_EN (TX) |
| SIGMA_DELTA_EN_TX_HI | This field sets the point during a TSM TX sequence (the tsm_count[7:0] value) at which the SIGMA_DELTA_EN signal or group will transition from LO to HI. |

45.4.5.3.1.53 **TSM_TIMING39 (TIMING39)**45.4.5.3.1.53.1 *Address*

| Register | Offset |
|----------|-----------|
| TIMING39 | 4005C38Ch |

FSK Modulator

45.4.5.3.1.53.2 Diagram

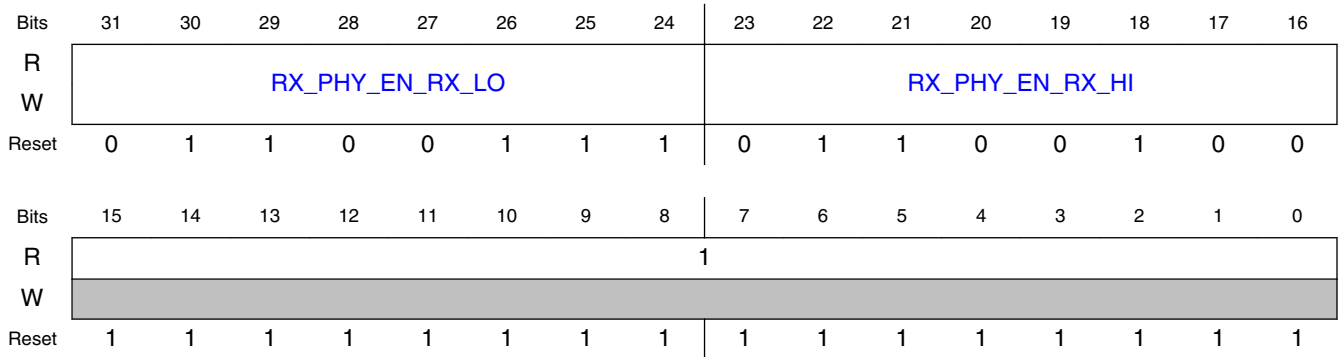

45.4.5.3.1.53.3 Fields

| Field | Function |
|--------------------------|---|
| 31-24 RX_PHY_EN_RX_LO | De-assertion time setting for RX_PHY_EN (RX) This field sets the point during a TSM RX sequence (the tsm_count[7:0] value) at which the RX_PHY_EN signal or group will transition from HI to LO. |
| 23-16 RX_PHY_EN_RX_HI | Assertion time setting for RX_PHY_EN (RX) This field sets the point during a TSM RX sequence (the tsm_count[7:0] value) at which the RX_PHY_EN signal or group will transition from LO to HI. |
| 15-0 — | Reserved |

45.4.5.3.1.54 TSM_TIMING40 (TIMING40)

45.4.5.3.1.54.1 Address

| Register | Offset |
|----------|-----------|
| TIMING40 | 4005C390h |

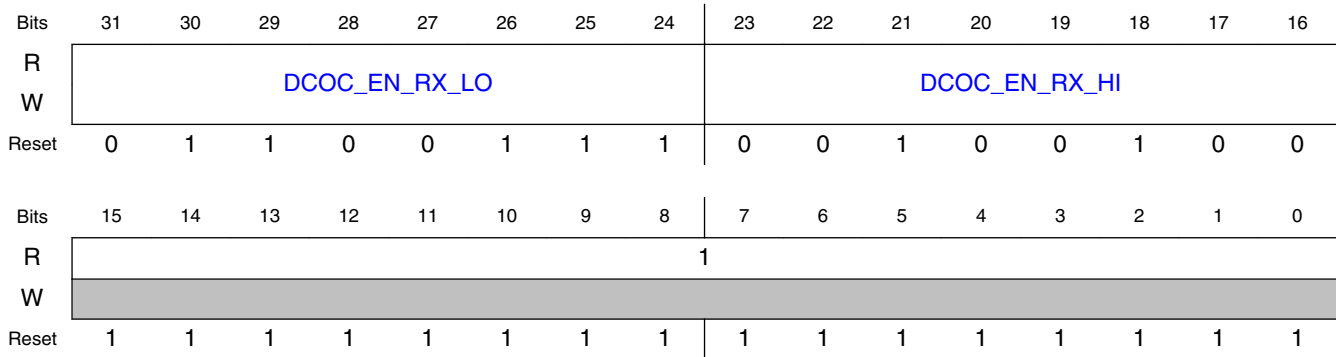
45.4.5.3.1.54.2 *Diagram*45.4.5.3.1.54.3 *Fields*

| Field | Function |
|------------------------|---|
| 31-24 DCOC_EN_RX_LO | De-assertion time setting for DCOC_EN (RX) This field sets the point during a TSM RX sequence (the tsm_count[7:0] value) at which the DCOC_EN signal or group will transition from HI to LO. |
| 23-16 DCOC_EN_RX_HI | Assertion time setting for DCOC_EN (RX) This field sets the point during a TSM RX sequence (the tsm_count[7:0] value) at which the DCOC_EN signal or group will transition from LO to HI. |
| 15-0 — | Reserved |

45.4.5.3.1.55 **TSM_TIMING41 (TIMING41)**45.4.5.3.1.55.1 *Address*

| Register | Offset |
|----------|-----------|
| TIMING41 | 4005C394h |

FSK Modulator

45.4.5.3.1.55.2 Diagram

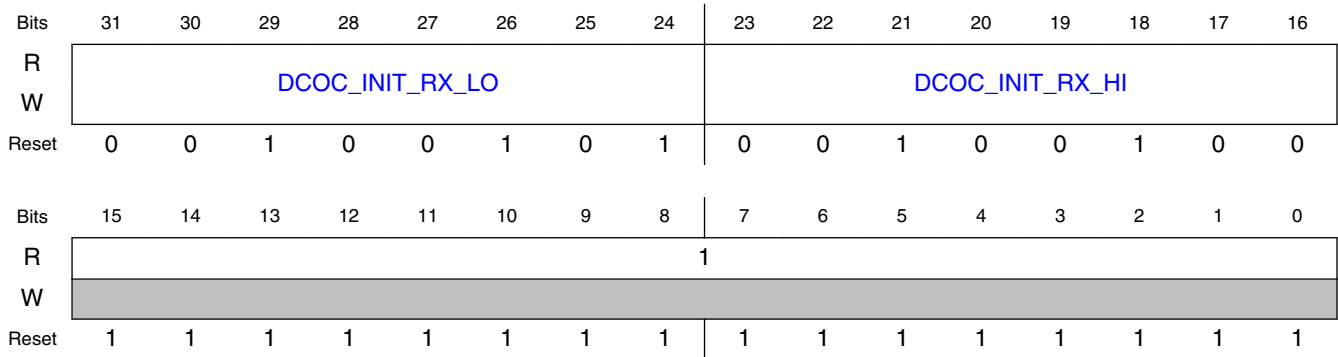

45.4.5.3.1.55.3 Fields

| Field | Function |
|-----------------|---|
| 31-24 | De-assertion time setting for DCOC_INIT (RX) |
| DCOC_INIT_RX_LO | This field sets the point during a TSM RX sequence (the tsm_count[7:0] value) at which the DCOC_INIT signal or group will transition from HI to LO. |
| 23-16 | Assertion time setting for DCOC_INIT (RX) |
| DCOC_INIT_RX_HI | This field sets the point during a TSM RX sequence (the tsm_count[7:0] value) at which the DCOC_INIT signal or group will transition from LO to HI. |
| 15-0 | Reserved |
| — | |

45.4.5.3.1.56 TSM_TIMING42 (TIMING42)

45.4.5.3.1.56.1 Address

| Register | Offset |
|----------|-----------|
| TIMING42 | 4005C398h |

45.4.5.3.1.56.2 *Diagram*

| | | | | | | | | | | | | | | | | |
|-------|-----------------------|----|----|----|----|----|----|----|-----------------------|----|----|----|----|----|----|----|
| Bits | 31 | 30 | 29 | 28 | 27 | 26 | 25 | 24 | 23 | 22 | 21 | 20 | 19 | 18 | 17 | 16 |
| R | SAR_ADC_TRIG_EN_RX_LO | | | | | | | | SAR_ADC_TRIG_EN_RX_HI | | | | | | | |
| W | | | | | | | | | | | | | | | | |
| Reset | 1 | 1 | 1 | 1 | 1 | 1 | 1 | 1 | 1 | 1 | 1 | 1 | 1 | 1 | 1 | 1 |
| Bits | 15 | 14 | 13 | 12 | 11 | 10 | 9 | 8 | 7 | 6 | 5 | 4 | 3 | 2 | 1 | 0 |
| R | SAR_ADC_TRIG_EN_TX_LO | | | | | | | | SAR_ADC_TRIG_EN_TX_HI | | | | | | | |
| W | | | | | | | | | | | | | | | | |
| Reset | 1 | 1 | 1 | 1 | 1 | 1 | 1 | 1 | 1 | 1 | 1 | 1 | 1 | 1 | 1 | 1 |

45.4.5.3.1.56.3 *Fields*

| Field | Function |
|--------------------------------|---|
| 31-24 SAR_ADC_TRIG_EN_RX_LO | De-assertion time setting for SAR_ADC_TRIG_EN (RX) This field sets the point during a TSM RX sequence (the tsm_count[7:0] value) at which the SAR_ADC_TRIG_EN signal or group will transition from HI to LO. |
| 23-16 SAR_ADC_TRIG_EN_RX_HI | Assertion time setting for SAR_ADC_TRIG_EN (RX) This field sets the point during a TSM RX sequence (the tsm_count[7:0] value) at which the SAR_ADC_TRIG_EN signal or group will transition from LO to HI. |
| 15-8 SAR_ADC_TRIG_EN_TX_LO | De-assertion time setting for SAR_ADC_TRIG_EN (TX) This field sets the point during a TSM TX sequence (the tsm_count[7:0] value) at which the SAR_ADC_TRIG_EN signal or group will transition from HI to LO. |
| 7-0 SAR_ADC_TRIG_EN_TX_HI | Assertion time setting for SAR_ADC_TRIG_EN (TX) This field sets the point during a TSM TX sequence (the tsm_count[7:0] value) at which the SAR_ADC_TRIG_EN signal or group will transition from LO to HI. |

45.4.5.3.1.57 **TSM_TIMING43 (TIMING43)**45.4.5.3.1.57.1 *Address*

| Register | Offset |
|----------|-----------|
| TIMING43 | 4005C39Ch |

FSK Modulator

45.4.5.3.1.57.2 Diagram

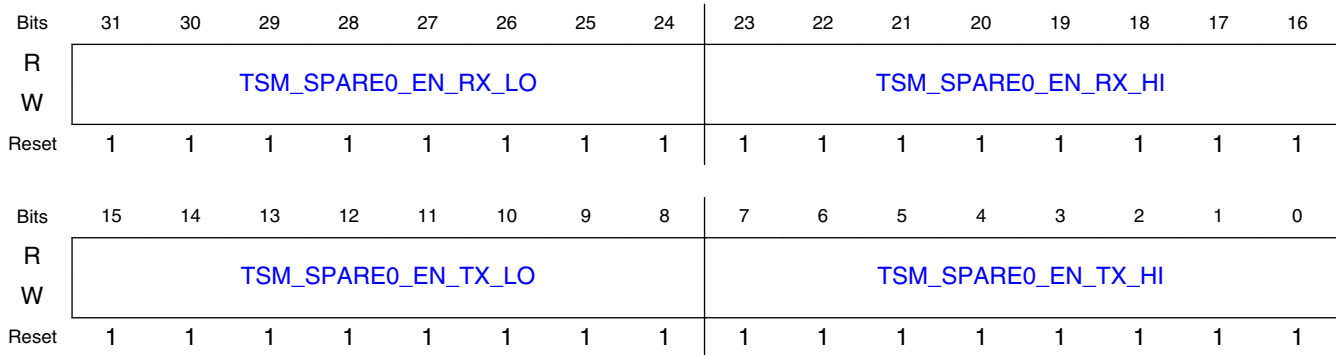

45.4.5.3.1.57.3 Fields

| Field | Function |
|------------------------------|---|
| 31-24 TSM_SPARE0_EN_RX_LO | De-assertion time setting for TSM_SPARE0_EN (RX) This field sets the point during a TSM RX sequence (the tsm_count[7:0] value) at which the TSM_SPARE0_EN signal or group will transition from HI to LO. |
| 23-16 TSM_SPARE0_EN_RX_HI | Assertion time setting for TSM_SPARE0_EN (RX) This field sets the point during a TSM RX sequence (the tsm_count[7:0] value) at which the TSM_SPARE0_EN signal or group will transition from LO to HI. |
| 15-8 TSM_SPARE0_EN_TX_LO | De-assertion time setting for TSM_SPARE0_EN (TX) This field sets the point during a TSM TX sequence (the tsm_count[7:0] value) at which the TSM_SPARE0_EN signal or group will transition from HI to LO. |
| 7-0 TSM_SPARE0_EN_TX_HI | Assertion time setting for TSM_SPARE0_EN (TX) This field sets the point during a TSM TX sequence (the tsm_count[7:0] value) at which the TSM_SPARE0_EN signal or group will transition from LO to HI. |

45.4.5.3.1.58 TSM_TIMING44 (TIMING44)

45.4.5.3.1.58.1 Address

| Register | Offset |
|----------|-----------|
| TIMING44 | 4005C3A0h |

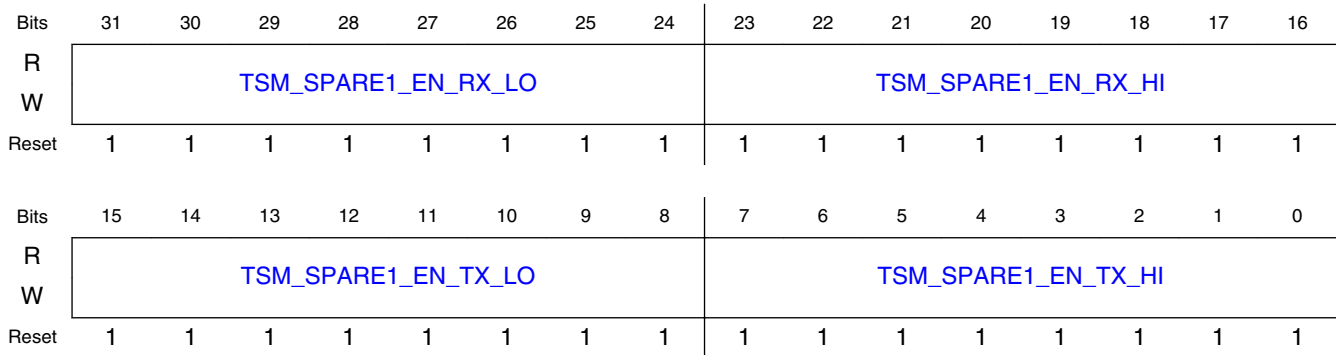
45.4.5.3.1.58.2 *Diagram*45.4.5.3.1.58.3 *Fields*

| Field | Function |
|------------------------------|---|
| 31-24 TSM_SPARE1_EN_RX_LO | De-assertion time setting for TSM_SPARE1_EN (RX) This field sets the point during a TSM RX sequence (the tsm_count[7:0] value) at which the TSM_SPARE1_EN signal or group will transition from HI to LO. |
| 23-16 TSM_SPARE1_EN_RX_HI | Assertion time setting for TSM_SPARE1_EN (RX) This field sets the point during a TSM RX sequence (the tsm_count[7:0] value) at which the TSM_SPARE1_EN signal or group will transition from LO to HI. |
| 15-8 TSM_SPARE1_EN_TX_LO | De-assertion time setting for TSM_SPARE1_EN (TX) This field sets the point during a TSM TX sequence (the tsm_count[7:0] value) at which the TSM_SPARE1_EN signal or group will transition from HI to LO. |
| 7-0 TSM_SPARE1_EN_TX_HI | Assertion time setting for TSM_SPARE1_EN (TX) This field sets the point during a TSM TX sequence (the tsm_count[7:0] value) at which the TSM_SPARE1_EN signal or group will transition from LO to HI. |

45.4.5.3.1.59 **TSM_TIMING45 (TIMING45)**45.4.5.3.1.59.1 *Address*

| Register | Offset |
|----------|-----------|
| TIMING45 | 4005C3A4h |

FSK Modulator

45.4.5.3.1.59.2 Diagram

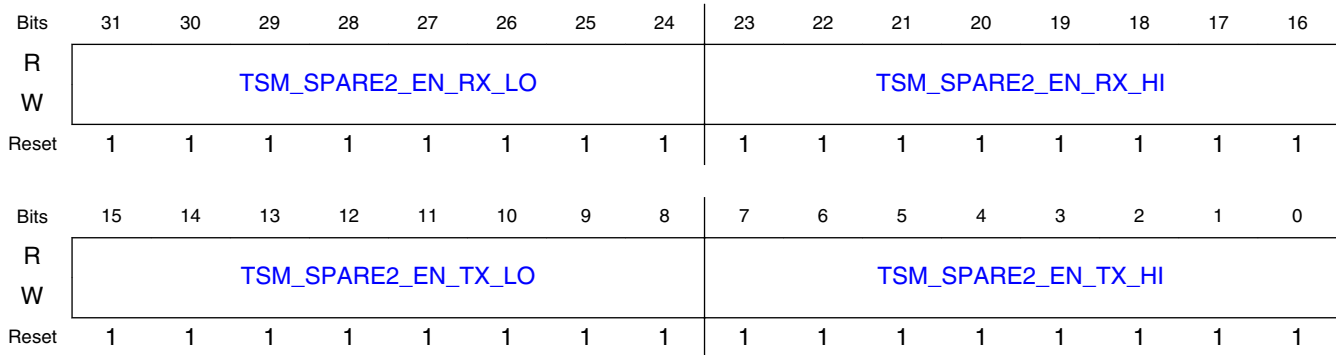

45.4.5.3.1.59.3 Fields

| Field | Function |
|------------------------------|---|
| 31-24 TSM_SPARE2_EN_RX_LO | De-assertion time setting for TSM_SPARE2_EN (RX) This field sets the point during a TSM RX sequence (the tsm_count[7:0] value) at which the TSM_SPARE2_EN signal or group will transition from HI to LO. |
| 23-16 TSM_SPARE2_EN_RX_HI | Assertion time setting for TSM_SPARE2_EN (RX) This field sets the point during a TSM RX sequence (the tsm_count[7:0] value) at which the TSM_SPARE2_EN signal or group will transition from LO to HI. |
| 15-8 TSM_SPARE2_EN_TX_LO | De-assertion time setting for TSM_SPARE2_EN (TX) This field sets the point during a TSM TX sequence (the tsm_count[7:0] value) at which the TSM_SPARE2_EN signal or group will transition from HI to LO. |
| 7-0 TSM_SPARE2_EN_TX_HI | Assertion time setting for TSM_SPARE2_EN (TX) This field sets the point during a TSM TX sequence (the tsm_count[7:0] value) at which the TSM_SPARE2_EN signal or group will transition from LO to HI. |

45.4.5.3.1.60 TSM_TIMING46 (TIMING46)

45.4.5.3.1.60.1 Address

| Register | Offset |
|----------|-----------|
| TIMING46 | 4005C3A8h |

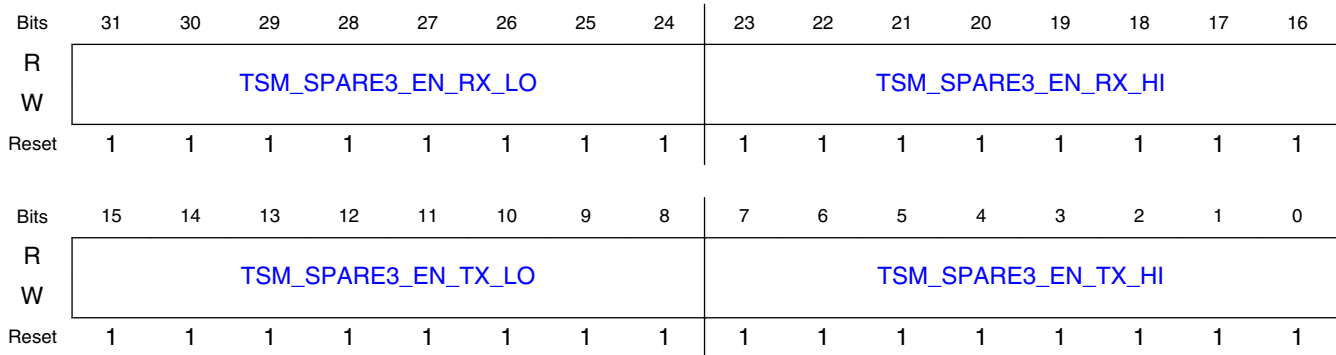
45.4.5.3.1.60.2 *Diagram*45.4.5.3.1.60.3 *Fields*

| Field | Function |
|------------------------------|---|
| 31-24 TSM_SPARE3_EN_RX_LO | De-assertion time setting for TSM_SPARE3_EN (RX) This field sets the point during a TSM RX sequence (the tsm_count[7:0] value) at which the TSM_SPARE3_EN signal or group will transition from HI to LO. |
| 23-16 TSM_SPARE3_EN_RX_HI | Assertion time setting for TSM_SPARE3_EN (RX) This field sets the point during a TSM RX sequence (the tsm_count[7:0] value) at which the TSM_SPARE3_EN signal or group will transition from LO to HI. |
| 15-8 TSM_SPARE3_EN_TX_LO | De-assertion time setting for TSM_SPARE3_EN (TX) This field sets the point during a TSM TX sequence (the tsm_count[7:0] value) at which the TSM_SPARE3_EN signal or group will transition from HI to LO. |
| 7-0 TSM_SPARE3_EN_TX_HI | Assertion time setting for TSM_SPARE3_EN (TX) This field sets the point during a TSM TX sequence (the tsm_count[7:0] value) at which the TSM_SPARE3_EN signal or group will transition from LO to HI. |

45.4.5.3.1.61 **TSM_TIMING47 (TIMING47)**45.4.5.3.1.61.1 *Address*

| Register | Offset |
|----------|-----------|
| TIMING47 | 4005C3ACh |

FSK Modulator

45.4.5.3.1.61.2 Diagram

| | | | | | | | | | | | | | | | | |
|-------|---------------------|----|----|----|----|----|----|----|---------------------|----|----|----|----|----|----|----|
| Bits | 31 | 30 | 29 | 28 | 27 | 26 | 25 | 24 | 23 | 22 | 21 | 20 | 19 | 18 | 17 | 16 |
| R | GPIO0_TRIG_EN_RX_LO | | | | | | | | GPIO0_TRIG_EN_RX_HI | | | | | | | |
| W | | | | | | | | | | | | | | | | |
| Reset | 1 | 1 | 1 | 1 | 1 | 1 | 1 | 1 | 1 | 1 | 1 | 1 | 1 | 1 | 1 | 1 |
| Bits | 15 | 14 | 13 | 12 | 11 | 10 | 9 | 8 | 7 | 6 | 5 | 4 | 3 | 2 | 1 | 0 |
| R | GPIO0_TRIG_EN_TX_LO | | | | | | | | GPIO0_TRIG_EN_TX_HI | | | | | | | |
| W | | | | | | | | | | | | | | | | |
| Reset | 1 | 1 | 1 | 1 | 1 | 1 | 1 | 1 | 1 | 1 | 1 | 1 | 1 | 1 | 1 | 1 |

45.4.5.3.1.61.3 Fields

| Field | Function |
|------------------------------|---|
| 31-24 GPIO0_TRIG_EN_RX_LO | De-assertion time setting for GPIO0_TRIG_EN (RX) This field sets the point during a TSM RX sequence (the tsm_count[7:0] value) at which the GPIO0_TRIG_EN signal or group will transition from HI to LO. |
| 23-16 GPIO0_TRIG_EN_RX_HI | Assertion time setting for GPIO0_TRIG_EN (RX) This field sets the point during a TSM RX sequence (the tsm_count[7:0] value) at which the GPIO0_TRIG_EN signal or group will transition from LO to HI. |
| 15-8 GPIO0_TRIG_EN_TX_LO | De-assertion time setting for GPIO0_TRIG_EN (TX) This field sets the point during a TSM TX sequence (the tsm_count[7:0] value) at which the GPIO0_TRIG_EN signal or group will transition from HI to LO. |
| 7-0 GPIO0_TRIG_EN_TX_HI | Assertion time setting for GPIO0_TRIG_EN (TX) This field sets the point during a TSM TX sequence (the tsm_count[7:0] value) at which the GPIO0_TRIG_EN signal or group will transition from LO to HI. |

45.4.5.3.1.62 TSM_TIMING48 (TIMING48)

45.4.5.3.1.62.1 Address

| Register | Offset |
|----------|-----------|
| TIMING48 | 4005C3B0h |

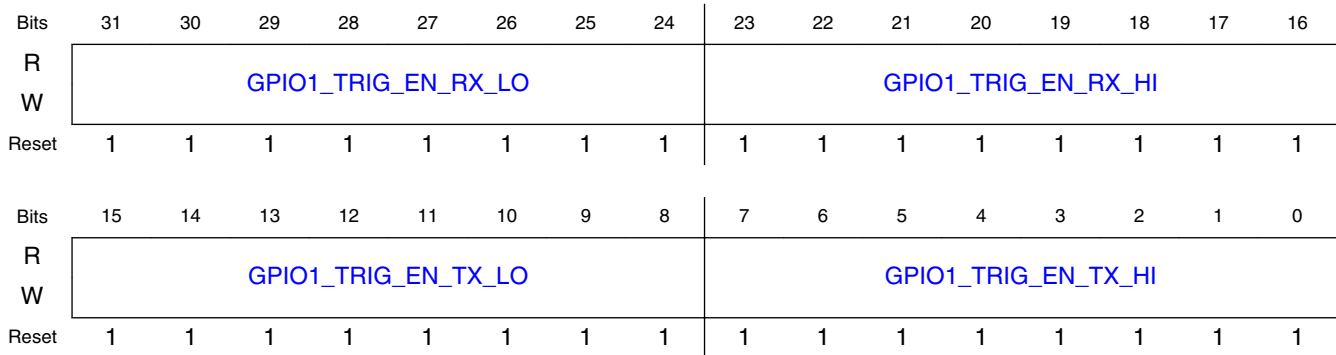
45.4.5.3.1.62.2 *Diagram*45.4.5.3.1.62.3 *Fields*

| Field | Function |
|------------------------------|---|
| 31-24 GPIO1_TRIG_EN_RX_LO | De-assertion time setting for GPIO1_TRIG_EN (RX) This field sets the point during a TSM RX sequence (the tsm_count[7:0] value) at which the GPIO1_TRIG_EN signal or group will transition from HI to LO. |
| 23-16 GPIO1_TRIG_EN_RX_HI | Assertion time setting for GPIO1_TRIG_EN (RX) This field sets the point during a TSM RX sequence (the tsm_count[7:0] value) at which the GPIO1_TRIG_EN signal or group will transition from LO to HI. |
| 15-8 GPIO1_TRIG_EN_TX_LO | De-assertion time setting for GPIO1_TRIG_EN (TX) This field sets the point during a TSM TX sequence (the tsm_count[7:0] value) at which the GPIO1_TRIG_EN signal or group will transition from HI to LO. |
| 7-0 GPIO1_TRIG_EN_TX_HI | Assertion time setting for GPIO1_TRIG_EN (TX) This field sets the point during a TSM TX sequence (the tsm_count[7:0] value) at which the GPIO1_TRIG_EN signal or group will transition from LO to HI. |

45.4.5.3.1.63 **TSM_TIMING49 (TIMING49)**45.4.5.3.1.63.1 *Address*

| Register | Offset |
|----------|-----------|
| TIMING49 | 4005C3B4h |

45.4.5.3.1.63.2 Diagram

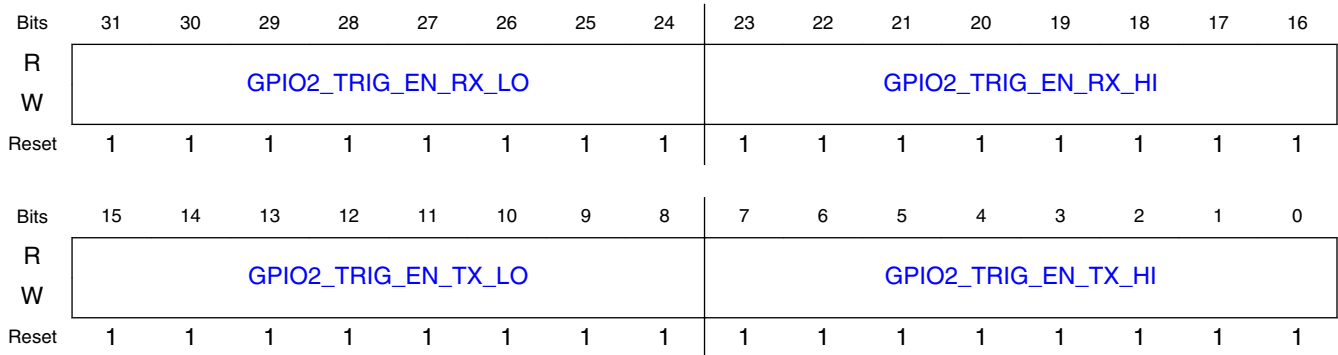

45.4.5.3.1.63.3 Fields

| Field | Function |
|------------------------------|---|
| 31-24 GPIO2_TRIG_EN_RX_LO | De-assertion time setting for GPIO2_TRIG_EN (RX) This field sets the point during a TSM RX sequence (the tsm_count[7:0] value) at which the GPIO2_TRIG_EN signal or group will transition from HI to LO. |
| 23-16 GPIO2_TRIG_EN_RX_HI | Assertion time setting for GPIO2_TRIG_EN (RX) This field sets the point during a TSM RX sequence (the tsm_count[7:0] value) at which the GPIO2_TRIG_EN signal or group will transition from LO to HI. |
| 15-8 GPIO2_TRIG_EN_TX_LO | De-assertion time setting for GPIO2_TRIG_EN (TX) This field sets the point during a TSM TX sequence (the tsm_count[7:0] value) at which the GPIO2_TRIG_EN signal or group will transition from HI to LO. |
| 7-0 GPIO2_TRIG_EN_TX_HI | Assertion time setting for GPIO2_TRIG_EN (TX) This field sets the point during a TSM TX sequence (the tsm_count[7:0] value) at which the GPIO2_TRIG_EN signal or group will transition from LO to HI. |

45.4.5.3.1.64 TSM_TIMING50 (TIMING50)

45.4.5.3.1.64.1 Address

| Register | Offset |
|----------|-----------|
| TIMING50 | 4005C3B8h |

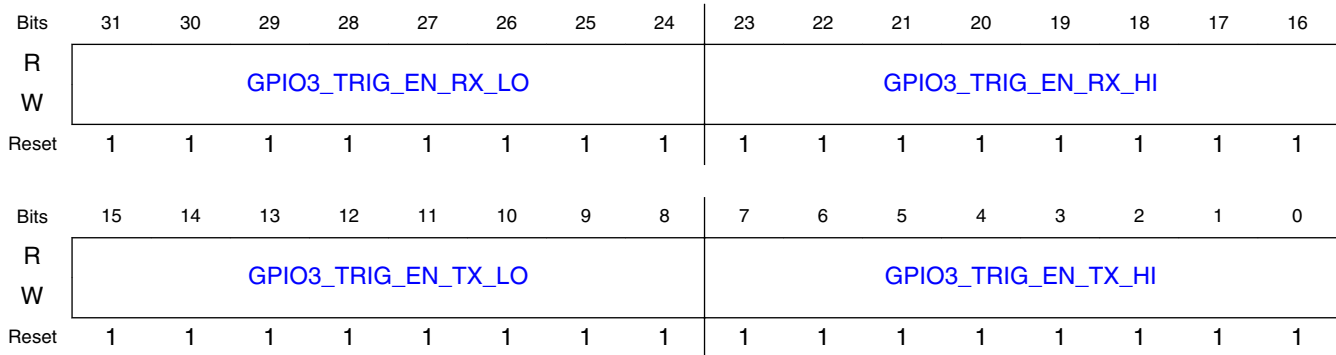
45.4.5.3.1.64.2 *Diagram*45.4.5.3.1.64.3 *Fields*

| Field | Function |
|------------------------------|---|
| 31-24 GPIO3_TRIG_EN_RX_LO | De-assertion time setting for GPIO3_TRIG_EN (RX) This field sets the point during a TSM RX sequence (the tsm_count[7:0] value) at which the GPIO3_TRIG_EN signal or group will transition from HI to LO. |
| 23-16 GPIO3_TRIG_EN_RX_HI | Assertion time setting for GPIO3_TRIG_EN (RX) This field sets the point during a TSM RX sequence (the tsm_count[7:0] value) at which the GPIO3_TRIG_EN signal or group will transition from LO to HI. |
| 15-8 GPIO3_TRIG_EN_TX_LO | De-assertion time setting for GPIO3_TRIG_EN (TX) This field sets the point during a TSM TX sequence (the tsm_count[7:0] value) at which the GPIO3_TRIG_EN signal or group will transition from HI to LO. |
| 7-0 GPIO3_TRIG_EN_TX_HI | Assertion time setting for GPIO3_TRIG_EN (TX) This field sets the point during a TSM TX sequence (the tsm_count[7:0] value) at which the GPIO3_TRIG_EN signal or group will transition from LO to HI. |

45.4.5.3.1.65 **TSM_TIMING51 (TIMING51)**45.4.5.3.1.65.1 *Address*

| Register | Offset |
|----------|-----------|
| TIMING51 | 4005C3BCh |

FSK Modulator

45.4.5.3.1.65.2 Diagram

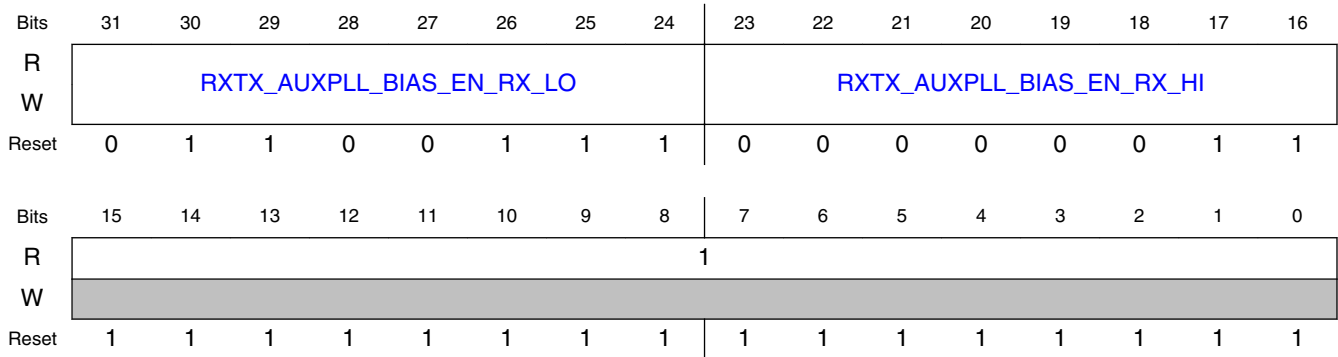

45.4.5.3.1.65.3 Fields

| Field | Function |
|------------------------------------|---|
| 31-24 RXTX_AUXPLL_BIAS_EN_RX_LO | De-assertion time setting for RXTX_AUXPLL_BIAS_EN (RX) This field sets the point during a TSM RX sequence (the tsm_count[7:0] value) at which the RXTX_AUXPLL_BIAS_EN signal or group will transition from HI to LO. |
| 23-16 RXTX_AUXPLL_BIAS_EN_RX_HI | Assertion time setting for RXTX_AUXPLL_BIAS_EN (RX) This field sets the point during a TSM RX sequence (the tsm_count[7:0] value) at which the RXTX_AUXPLL_BIAS_EN signal or group will transition from LO to HI. |
| 15-0 — | Reserved |

45.4.5.3.1.66 TSM_TIMING52 (TIMING52)

45.4.5.3.1.66.1 Address

| Register | Offset |
|----------|-----------|
| TIMING52 | 4005C3C0h |

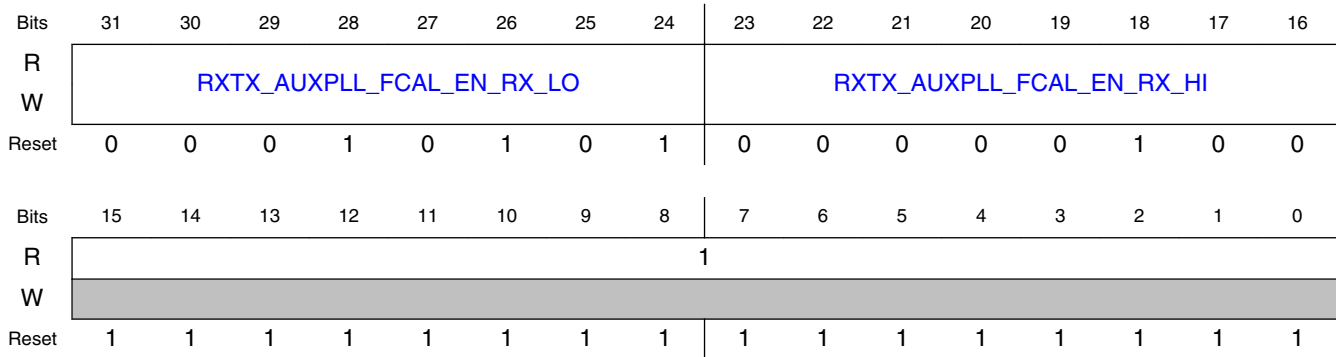
45.4.5.3.1.66.2 *Diagram*45.4.5.3.1.66.3 *Fields*

| Field | Function |
|------------------------------------|---|
| 31-24 RXTX_AUXPLL_FCAL_EN_RX_LO | De-assertion time setting for RXTX_AUXPLL_FCAL_EN (RX) This field sets the point during a TSM RX sequence (the tsm_count[7:0] value) at which the RXTX_AUXPLL_FCAL_EN signal or group will transition from HI to LO. |
| 23-16 RXTX_AUXPLL_FCAL_EN_RX_HI | Assertion time setting for RXTX_AUXPLL_FCAL_EN (RX) This field sets the point during a TSM RX sequence (the tsm_count[7:0] value) at which the RXTX_AUXPLL_FCAL_EN signal or group will transition from LO to HI. |
| 15-0 — | Reserved |

45.4.5.3.1.67 **TSM_TIMING53 (TIMING53)**45.4.5.3.1.67.1 *Address*

| Register | Offset |
|----------|-----------|
| TIMING53 | 4005C3C4h |

FSK Modulator

45.4.5.3.1.67.2 Diagram

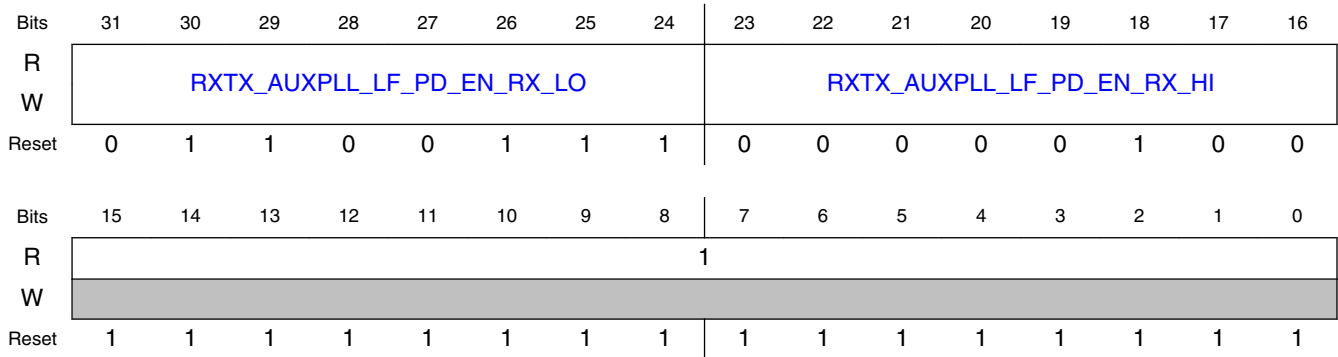

45.4.5.3.1.67.3 Fields

| Field | Function |
|-------------------------------------|---|
| 31-24 RXTX_AUXPLL_LF_PD_EN_RX_LO | De-assertion time setting for RXTX_AUXPLL_LF_PD_EN (RX) This field sets the point during a TSM RX sequence (the tsm_count[7:0] value) at which the RXTX_AUXPLL_LF_PD_EN signal or group will transition from HI to LO. |
| 23-16 RXTX_AUXPLL_LF_PD_EN_RX_HI | Assertion time setting for RXTX_AUXPLL_LF_PD_EN (RX) This field sets the point during a TSM RX sequence (the tsm_count[7:0] value) at which the RXTX_AUXPLL_LF_PD_EN signal or group will transition from LO to HI. |
| 15-0 — | Reserved |

45.4.5.3.1.68 TSM_TIMING54 (TIMING54)

45.4.5.3.1.68.1 Address

| Register | Offset |
|----------|-----------|
| TIMING54 | 4005C3C8h |

45.4.5.3.1.68.2 Diagram

| | | | | | | | | | | | | | | | | |
|-------|--|----|----|----|----|----|----|----|--|----|----|----|----|----|----|----|
| Bits | 31 | 30 | 29 | 28 | 27 | 26 | 25 | 24 | 23 | 22 | 21 | 20 | 19 | 18 | 17 | 16 |
| R | RXTX_AUXPLL_PD_LF_FILTER_CHARGE_EN_RX_LO | | | | | | | | RXTX_AUXPLL_PD_LF_FILTER_CHARGE_EN_RX_HI | | | | | | | |
| W | | | | | | | | | | | | | | | | |
| Reset | 0 | 0 | 0 | 1 | 0 | 1 | 0 | 1 | 0 | 0 | 0 | 0 | 0 | 1 | 0 | 0 |
| Bits | 15 | 14 | 13 | 12 | 11 | 10 | 9 | 8 | 7 | 6 | 5 | 4 | 3 | 2 | 1 | 0 |
| R | 1 | | | | | | | | | | | | | | | |
| W | | | | | | | | | | | | | | | | |
| Reset | 1 | 1 | 1 | 1 | 1 | 1 | 1 | 1 | 1 | 1 | 1 | 1 | 1 | 1 | 1 | 1 |

45.4.5.3.1.68.3 Fields

| Field | Function |
|---|---|
| 31-24 RXTX_AUXPLL_PD_LF_FILTER_CHARGE_EN_RX_LO | De-assertion time setting for RXTX_AUXPLL_PD_LF_FILTER_CHARGE_EN (RX) This field sets the point during a TSM RX sequence (the tsm_count[7:0] value) at which the RXTX_AUXPLL_PD_LF_FILTER_CHARGE_EN signal or group will transition from HI to LO. |
| 23-16 RXTX_AUXPLL_PD_LF_FILTER_CHARGE_EN_RX_HI | Assertion time setting for RXTX_AUXPLL_PD_LF_FILTER_CHARGE_EN (RX) This field sets the point during a TSM RX sequence (the tsm_count[7:0] value) at which the RXTX_AUXPLL_PD_LF_FILTER_CHARGE_EN signal or group will transition from LO to HI. |
| 15-0 — | Reserved |

45.4.5.3.1.69 TSM_TIMING55 (TIMING55)

45.4.5.3.1.69.1 Address

| Register | Offset |
|----------|-----------|
| TIMING55 | 4005C3CCh |

FSK Modulator

45.4.5.3.1.69.2 Diagram

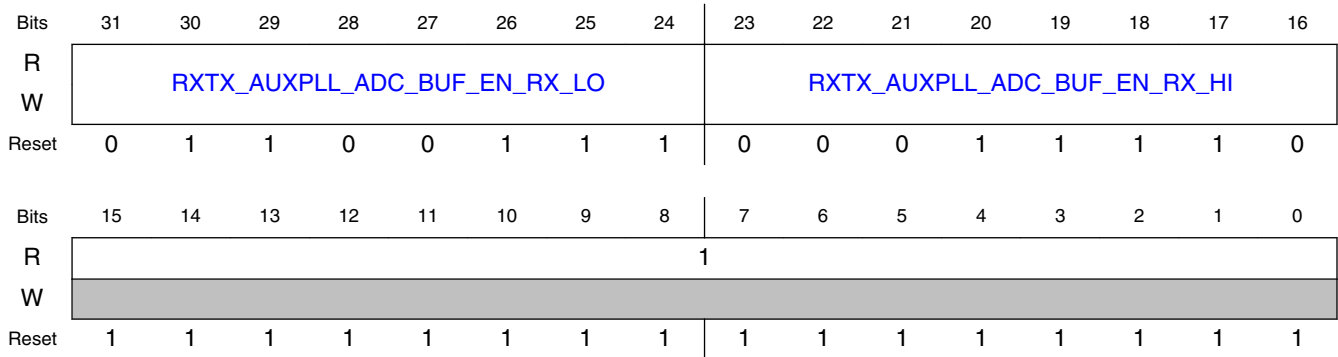

45.4.5.3.1.69.3 Fields

| Field | Function |
|---------------------------------------|---|
| 31-24 RXTX_AUXPLL_ADC_BUF_EN_RX_LO | De-assertion time setting for RXTX_AUXPLL_ADC_BUF_EN (RX) This field sets the point during a TSM RX sequence (the tsm_count[7:0] value) at which the RXTX_AUXPLL_ADC_BUF_EN signal or group will transition from HI to LO. |
| 23-16 RXTX_AUXPLL_ADC_BUF_EN_RX_HI | Assertion time setting for RXTX_AUXPLL_ADC_BUF_EN (RX) This field sets the point during a TSM RX sequence (the tsm_count[7:0] value) at which the RXTX_AUXPLL_ADC_BUF_EN signal or group will transition from LO to HI. |
| 15-0 — | Reserved |

45.4.5.3.1.70 TSM_TIMING56 (TIMING56)

45.4.5.3.1.70.1 Address

| Register | Offset |
|----------|-----------|
| TIMING56 | 4005C3D0h |

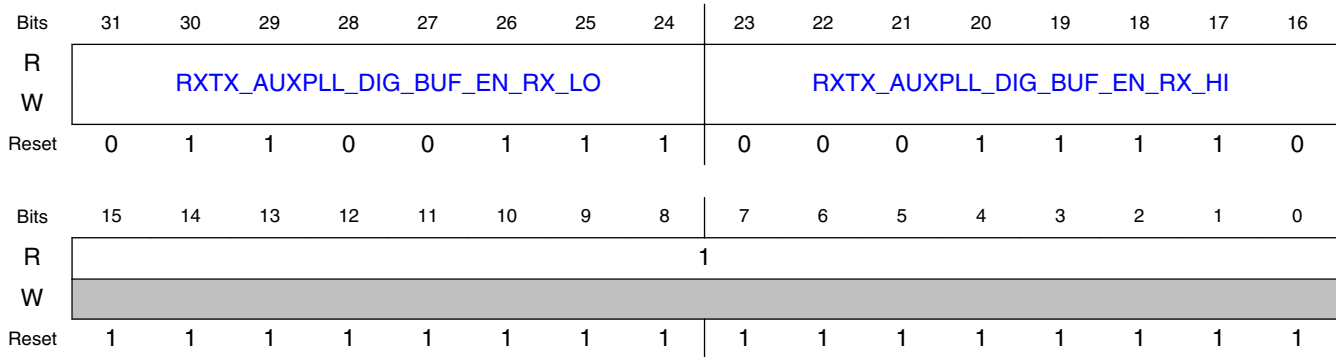
45.4.5.3.1.70.2 *Diagram*45.4.5.3.1.70.3 *Fields*

| Field | Function |
|---------------------------------------|---|
| 31-24 RXTX_AUXPLL_DIG_BUF_EN_RX_LO | De-assertion time setting for RXTX_AUXPLL_DIG_BUF_EN (RX) This field sets the point during a TSM RX sequence (the tsm_count[7:0] value) at which the RXTX_AUXPLL_DIG_BUF_EN signal or group will transition from HI to LO. |
| 23-16 RXTX_AUXPLL_DIG_BUF_EN_RX_HI | Assertion time setting for RXTX_AUXPLL_DIG_BUF_EN (RX) This field sets the point during a TSM RX sequence (the tsm_count[7:0] value) at which the RXTX_AUXPLL_DIG_BUF_EN signal or group will transition from LO to HI. |
| 15-0 — | Reserved |

45.4.5.3.1.71 **TSM_TIMING57 (TIMING57)**45.4.5.3.1.71.1 *Address*

| Register | Offset |
|----------|-----------|
| TIMING57 | 4005C3D4h |

FSK Modulator

45.4.5.3.1.71.2 Diagram

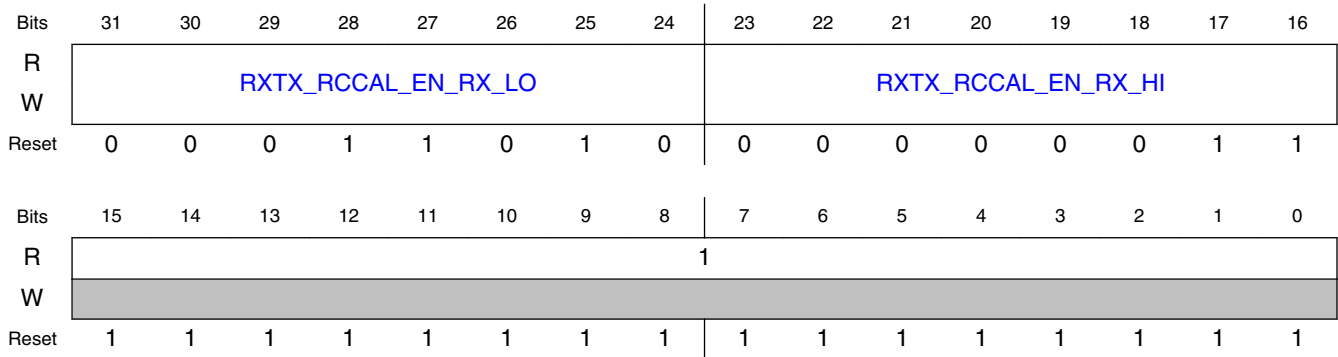

45.4.5.3.1.71.3 Fields

| Field | Function |
|------------------------------|---|
| 31-24 RXTX_RCCAL_EN_RX_LO | De-assertion time setting for RXTX_RCCAL_EN (RX) This field sets the point during a TSM RX sequence (the tsm_count[7:0] value) at which the RXTX_RCCAL_EN signal or group will transition from HI to LO. |
| 23-16 RXTX_RCCAL_EN_RX_HI | Assertion time setting for RXTX_RCCAL_EN (RX) This field sets the point during a TSM RX sequence (the tsm_count[7:0] value) at which the RXTX_RCCAL_EN signal or group will transition from LO to HI. |
| 15-0 — | Reserved |

45.4.5.3.1.72 TSM_TIMING58 (TIMING58)

45.4.5.3.1.72.1 Address

| Register | Offset |
|----------|-----------|
| TIMING58 | 4005C3D8h |

45.4.5.3.1.72.2 Diagram

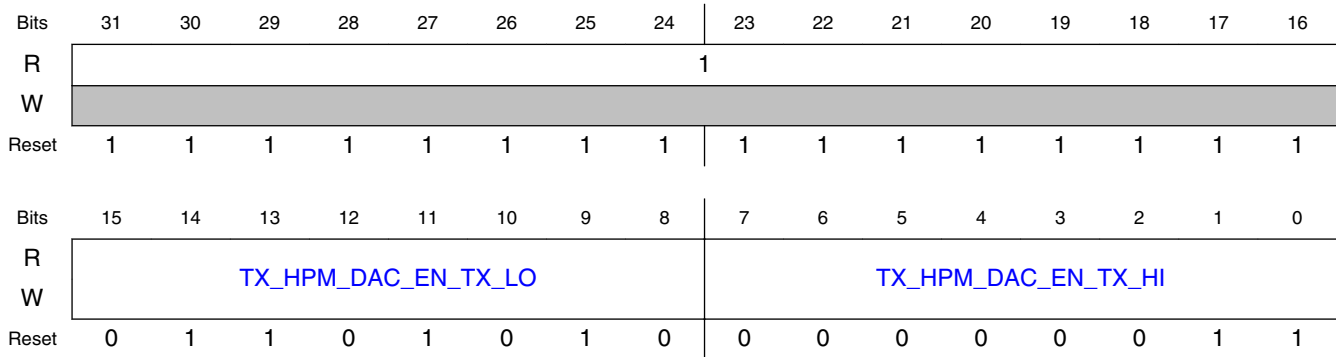

45.4.5.3.1.72.3 Fields

| Field | Function |
|-----------------------------|---|
| 31-16 — | Reserved |
| 15-8 TX_HPM_DAC_EN_TX_LO | De-assertion time setting for TX_HPM_DAC_EN (TX) This field sets the point during a TSM TX sequence (the tsm_count[7:0] value) at which the TX_HPM_DAC_EN signal or group will transition from HI to LO. |
| 7-0 TX_HPM_DAC_EN_TX_HI | Assertion time setting for TX_HPM_DAC_EN (TX) This field sets the point during a TSM TX sequence (the tsm_count[7:0] value) at which the TX_HPM_DAC_EN signal or group will transition from LO to HI. |

45.4.6 Transceiver DMA and Packet RAM Debug Modes

45.4.6.1 Introduction

For debug and evaluation purposes, the 2.4GHz Radio provides the capability to capture a variety of internal data during the reception process, and store it to either system memory (using Transceiver DMA mode) or radio packet ram (using Packet RAM Debug mode), for analysis and post-processing

45.4.6.1.1 Overview

During silicon debug and evaluation, it is often desirable to gain access to data internal to the digital receiver, in order to, for example:

- troubleshoot packet loss issues
- troubleshoot unexpectedly high Bit Error Rate
- fine-tune receiver initialization and configuration parameters

The 2.4GHz radio offers 3 methods of accessing such internal data:

1. Transceiver DMA mode
2. Packet RAM Debug mode
3. Digital Test Mux (DTEST)

This chapter describes the first 2 methods.

Examples of internal data desirable for capture are raw ADC samples, RX digital I and Q outputs, and PHY soft decision data. Transceiver DMA and Packet RAM Debug modes allow a source of internal data to be selected, automate the acquisition of the data, pack the data into a format suitable and optimized for its destination (system or radio memory), implement the interfaces required to access those memories, store the data to memory under program control, and subsequently allow host MCU access to the acquired data for analysis and post-processing. Selected data are organized into pages, to allow contextually related data to be simultaneously captured wherever possible, and allow for maximum utilization of available bandwidth to memory. For DMA mode, two transfer protocols are provided: a low-bandwidth protocol where the radio requests access to memory only when it has a new sample ready, and a high-bandwidth protocol that allows an entire block of radio data to be transferred to memory with a single radio request. For RAM debug mode, the entire radio RAM (2176 bytes) is made available for this debug mode, with hardware to pack data, generate RAM addressing, and detect RAM-full condition to prevent overwriting and loss of data.

45.4.6.1.2 Features

- Captures any of 4 sources of RX_DIG data and 4 sources of PHY data
- DMA engine communicates with SoC DMA2 controller to access system memory
- DMA signalling compliant with IP Interface SRS DarkBlue Line convention
- DMA engine provides 2 options to optimize request signalling to required data rate
- Packet RAM Debug engine automates transfers to radio memory
- Efficient packing of source data optimized to destination memory dimensions
- Efficient packing of source data optimized to make best use of available bandwidth
- DMA and Packet RAM engine clocking disabled in mission mode to reduce power
- Simultaneous DMA and Packet RAM Debug operation possible
- Simultaneous Mission Mode and DMA operation possible

45.4.6.1.3 Block Diagram

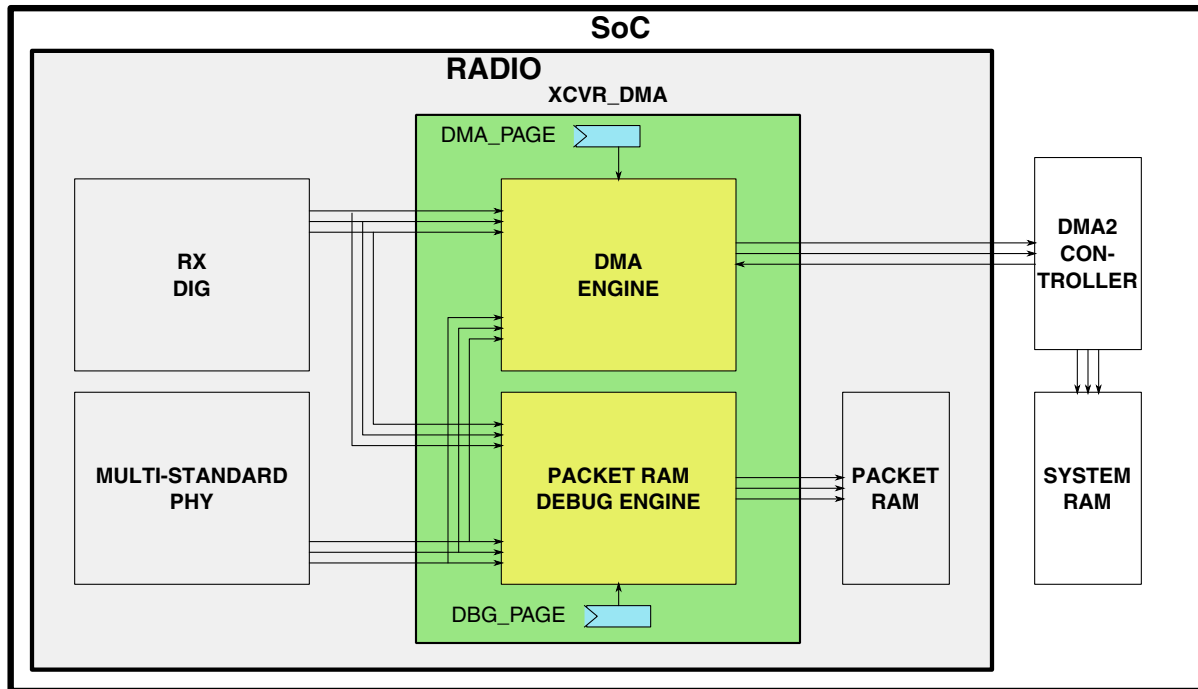

Figure 45-63. Transceiver DMA and Packet RAM Debug

45.4.6.2 Memory Map and Register Definition

45.4.6.2.1 Register Summary

Below is an overview of the DMA and Packet RAM Debug control fields. More detail on these registers can be found in the XCVR_MISC register section.

45.4.6.2.2 Register Descriptions

| Field | R/W | Description |
|---------------|-----|---|
| DMA_PAGE[3:0] | rw | Transceiver DMA Page Selector. Selects the page of receiver data for storage to system memory when using Transceiver DMA Debug Mode. Setting this register to a non-zero value enables the DMA interface logic. Setting this register to zero disables the interface and gates off all associated clocking. The available |

Table continues on the next page...

| Field | R/W | Description |
|------------------|-----|---|
| | | DMA pages are listed in the following Table 45-32 . |
| SINGLE_REQ_MODE | rw | DMA Single Request Mode. Configures the transceiver to transfer the entire block of DMA data with only a single initial request (ipd_req_radio_rx). The DMA2 controller must be configured accordingly. In this mode, the transceiver will use ips_xfr_wait to pace the individual transactions. Single Request Mode should not be used with DMA Pages 11, 12, or 13, because the data rate is too low and therefore ips_xfr_wait would remain asserted for excessively long periods. |
| BYPASS_DMA_SYNC | rw | Bypass External DMA Synchronization. When using transceiver DMA with SINGLE_REQ_MODE=0, synchronization external to the transceiver must be bypassed in order to minimize bus access latency. Using DMA in this mode also requires that the MCU and transceiver both are configured to operate in the RF Oscillator clock domain. |
| DMA_TRIGGERRED | r | DMA TRIGGERRED. This status bit becomes set when the PHY indicates that a Network Address match has occurred. In some cases it may be desirable to delay the start of DMA transfers until such a match occurs; in such cases, software can poll this bit, and once it becomes set, immediately select the desired DMA_PAGE to initiate DMA transfers. This bit is intended for use with DMA_PAGE=13, but is available on all pages. Its usage is optional. |
| DMA_TIMED_OUT | r | DMA Transfer Timed Out. Status bit indicates that the transceiver DMA, while operating in Single Request Mode, asserted ips_xfr_wait for a period in excess of the programmed DMA_TIMEOUT setting, resulting in a timeout condition where the transceiver has forced ips_xfr_wait low. After a timeout, before resuming DMA operations, set DMA_PAGE=0 to disable DMA, and write 1 to this bit to clear it. |
| DMA_TIMEOUT[3:0] | rw | DMA Timeout. In DMA Single Request Mode, adverse consequences may result if the transceiver's ips_xfr_wait signal is asserted for an excessively long period of time, which could occur due to mis-programming of the DMA2 |

Table continues on the next page...

| Field | R/W | Description |
|-------------------|-----|--|
| | | controller, and/or the transceiver itself. DMA Timeout forces the transceiver's ips_xfr_wait low after N microseconds and sets the DMA_TIMED_OUT status bit, where $N=DMA_TIMEOUT$. DMA_TIMEOUT is only relevant when SINGLE_REQ_MODE=1, otherwise the transceiver does not assert ips_xfr_wait. |
| DBG_PAGE[3:0] | rw | Packet RAM Debug Page Selector. Selects the page of receiver data for storage to Packet RAM using Transceiver Packet RAM Debug Mode. Setting this register to a non-zero value enables the Packet RAM Debug mode interface logic. Setting this register to zero disables the interface logic and gates off all associated clocking. The available RAM Debug pages are listed in the following Table 45-32 |
| XCVR_RAM_ALLOW | rw | Allow Packet RAM Transceiver Access. This bit must be set before performing accesses to the Packet RAM using transceiver address space. Transceiver space accesses to Packet RAM are intended for debug purposes only; the individual protocol engines, and the associated IPS busses, have exclusive access to Packet RAM in mission modes. Transceiver space accesses to Packet RAM include direct accesses to RAM at transceiver addresses 0x700 - 0xF80, as well as Packet RAM Debug Mode. When this bit is set, control of RAM clock gating and RAM chip enables are forced on continuously, taking these controls away from the protocol engines. Note: In Packet RAM Debug mode, this bit should be set to 1 first, prior to setting DBG_PAGE to any non-zero setting |
| DBG_TRIGGERRED | r | DBG_TRIGGERRED. This status bit becomes set when the PHY indicates that a Network Address match has occurred. In some cases it may be desirable to delay the start of Packet RAM debug transfers until such a match occurs; in such cases, software can poll this bit, and once it becomes set, immediately select the desired DBG_PAGE to initiate data transfers to Packet RAM. This bit is intended for use with DBG_PAGE=13, but is available on all pages. Its usage is optional. |
| DBG_RAM_FULL[1:0] | r | Packet RAM Debug RAM Full. Status Bits indicating that Packet RAM0 (or RAM1) is full, and the Packet RAM |

| Field | R/W | Description |
|-------|-----|--|
| | | Debug engine has attempted to write another word to that RAM. This, and any subsequent write attempts, will not alter the contents of the RAM, once it has reached capacity. Set DBG_PAGE=0 to clear the DBG_RAM_FULL[1:0] bits. |

45.4.6.3 Functional Description

45.4.6.3.1 Transceiver DMA Mode

Transceiver DMA mode takes internal receive data from the RX_DIG or PHY, packs the data into an optimal format for bandwidth or RAM dimensions, and hands off the data to an external (SoC) DMA controller for ultimate transfer to system memory. Control and configuration of transceiver DMA operation is governed by the bit fields in the DMA_CTRL register of XCVR address space. These bit fields are referenced in the description that follows. In a typical transceiver DMA debug session, the transceiver DMA hardware performs the following steps:

1. Selects a source of internal data from RX_DIG or PHY for capture based on DMA_PAGE[3:0] setting
2. Uses a defined capture signal from RX_DIG or PHY to latch the internal data into a holding register
3. Sequentially packs 2 or more captures of internal data into a 32-bit register until the packing requirements for that DMA_PAGE setting are met
4. Uses the radio's SRS DarkBlue Line-compliant DMA interface to notify SoC DMA controller there is data ready for transfer
5. Repeats steps 1-4 until the debug session is complete (DMA_PAGE set to 0).

Each source of RX_DIG or PHY data has a capture signal associated with it. The capture signal is generated in the source block. The capture signal is a one-reference-clock wide pulse that indicates that the next sample (or samples) of source data is ready for capture. For RX_DIG data sources, the frequency of the capture signal is affected by the RX_DECT_FILT_OSR[2:0] setting (see RX DIG Block Guide). Due to system bandwidth constraints not all RX_DECT_FILT_OSR settings are available, and in some cases the ideal mission mode setting can't be used. The maximum RX_DECT_FILT_OSR setting is dependent on DMA_PAGE, and is listed in the table

below. For any DMA_PAGE selecting source data from RX_DIG, set `RX_DIG_CTRL[RX_DMA_DTEST_EN]=1` (in mission mode, this bit is clear to reduce power consumption.)

At the assertion of the capture signal, the transceiver takes the data sample(s) presented by RX_DIG or PHY and stores them in a holding register. Subsequent assertions on the capture signal fill different portions of the holding register, until the packing requirements for the selected DMA_PAGE setting are achieved. A description of the packing requirements for each DMA_PAGE setting is included in the table below. Packing is complete when the page-specific packing requirements are met, and the contents of the holding register are transferred into the `DMA_DATA[31:0]` register for pickup by the SoC DMA controller.

The `DMA_DATA[31:0]` is a memory-mapped, read-only IPS bus register. It is available for host access, but its primary function is to be read only by the DMA controller upon request from the radio. Once valid data is stored into the `DMA_DATA` register, the radio notifies the SoC DMA controller that a new sample is ready using one of 2 methods:

REQUEST-PER-SAMPLE Mode

In this mode, the radio signals the external DMA controller with a new transfer request whenever a new 32-bit sample word is ready in `DMA_DATA[31:0]`. This is accomplished by setting `SINGLE_REQ_MODE=0`. The maximum DMA transfer rate in this mode is 2Msamples/sec. This mode is not optimal from the point-of-view of the DMA controller, because first-cycle-latency is incurred for every sample. The debug session block size (total data to be transferred) need not be known in advance. To reduce IPS bus latency in this mode, in order to meet the 2Msamples/sec data rate, the following programming restrictions are mandatory:

1. Both radio and MCU must be programmed to run off the same clock source (no clock domain crossing)
2. That clock source must be the Reference Oscillator.
3. Synchronization of the DMA request and done signals must be bypassed, so set `BYPASS_DMA_SYNC=1`.
4. Synchronization of the IPS bus must be bypassed, so set `RSIM_CTRL[GASKET_BYPASS_OVRD_EN]=RSIM_CTRL[GASKET_BYPASS_OVRD]=1`.
5. MCU code should be executed out of internal RAM, not flash, since flash access requirements might not be met at this bus frequency.
6. No Radio IPS bus activity by the host is allowed during a DMA session
7. Once DMA debug session is complete, set `RSIM_CTRL[GASKET_BYPASS_OVRD_EN]=RSIM_CTRL[GASKET_BYPASS_OVRD]=0`.
8. Radio IPS accesses are now permitted

Note: From the SoC perspective, steps (1) and (2) put the SoC in a configuration that is a special case where full MCU-to-radio IPS bus timing has not been closed. In this mode, only paths associated with, and required for, DMA transfers, have closed timing. Therefore, no other IPS bus or ordinary mission-mode activity should be attempted in this mode. This restriction means host accesses to all radio registers is prohibited.

In REQUEST-PER-SAMPLE mode, whenever a new sample is ready, the radio asserts **ipd_req_radio_rx** to notify the external DMA controller. The controller will respond to the request, by reading the sample from the DMA_DATA register, and then asserts **ipd_done_radio_rx**. In order to ensure that the 2Msample/second transfer rate is met, the controller must respond with **ipd_done_radio_rx** within 15 reference oscillator clock periods after the radio asserts **ipd_req_radio_rx**. This timing is achievable if the aforementioned configuration instructions are followed. IC-level simulation of this mode demonstrates that request-to-done timing is a maximum of 13 reference clock periods, after proper configuration. As long as the external controller asserts **ipd_done_radio_rx** no later than 14 reference clock periods after the radio asserts **ipd_req_radio_rx**, the radio shall deassert **ipd_req_radio_rx** on the next reference clock cycle, and hold it deasserted until a new sample is ready. If the external controller asserts **ipd_done_radio_rx** exactly 15 clock periods after the radio asserts **ipd_req_radio_rx**, the radio shall deassert **ipd_req_radio_rx** after the 14th consecutive clock cycle of **ipd_req_radio_rx** assertion, for one clock cycle, in order to generate a low-to-high transition on **ipd_req_radio_rx** on the following clock cycle, when a new sample will be ready for transfer. This is the zero-operating-margin case. If the external controller does not assert **ipd_done_radio_rx** within 15 reference clock periods, there is no guarantee that the controller retrieved the sample from DMA_DATA in time, before the radio updated DMA_DATA to the next sample. This is considered a system malfunction, yielding the possibility that samples have been missed by the controller. It is not a certainty that samples were skipped; it depends on the timing of the DMA IPS bus read relative to the request, but this condition should be avoided.

SINGLE REQUEST Mode

In Single Request mode, the entire block of desired DMA data, is transferred to system memory based on a single request by the transceiver to the external DMA controller. The block size of the debug session must be known in advance, and this size must be programmed into the DMA controller. In this mode, DMA controller does not incur first-cycle latency on every sample, only on the first sample of a debug session. This is because there is only a single, initial request from the radio. In this mode, the MCU can be configured for any clock source, DMA-signal synchronization is not required (BYPASS_DMA_SYNC=0), and RSIM IPS gasket bypass is also not required. Host IPS accesses to radio registers propagate through the synchronizing IPS bus gaskets as in

mission mode; however IPS bus accesses to transceiver registers during DMA activity should be avoided in order to avoid delaying the controller accesses to the DMA_DATA register.

In this mode, once the radio has its first sample packed into DMA_DATA and ready to transfer to the external controller, it will assert **ipd_req_radio_rx**. The radio will hold **ipd_req_radio_rx** asserted until the first read access to the DMA_DATA register by the external controller. At this point, the radio shall deassert **ipd_req_radio_rx** and hold it low for the remainder of the debug session (until DMA_PAGE is set to 0). The external controller shall transfer the entire block of DMA data based on this single radio request. The radio shall ignore **ipd_done_radio_rx** in this mode. The external controller, operating with reduced latency in this mode, lacking the need to process new requests for every sample, will be able to consume samples from the radio faster than the radio can generate them (i.e., greater than 2Msamples/sec). Thus, the radio will assert **ips_xfr_wait_xcvr** to the controller to pace the transfers. When the external controller reads a sample from DMA_DATA, the radio will assert **ips_xfr_wait_xcvr** on the next reference clock cycle, and keep it asserted until a new sample is available on DMA_DATA; it will then deassert **ips_xfr_wait_xcvr** for 1 clock cycle to allow the controller to access DMA_DATA, then reassert it again. This process iterates until the debug session is complete: the pre-programmed block of data is transferred, and DMA_PAGE is set to 0 by program software.

The IPS SkyBlue signal **ips_xfr_wait** allows a peripheral to insert wait states on the IPS bus for cases in which it cannot deliver readback data (**ips_rdata**) in the same clock cycle that **ips_module_en** is asserted. The transceiver DMA interface uses **ips_xfr_wait_xcvr** to throttle the DMA transfers as described above. Because of the potential hazards that can arise due to an extended assertion of **ips_xfr_wait** on any IPS bus, which could result from an incorrectly programmed transceiver or DMA controller, a programmable timeout mechanism has been built in to the transceiver DMA hardware. The timeout mechanism measures the amount of time **ips_xfr_wait_xcvr** is asserted, in microseconds, by the transceiver DMA hardware, and compares it to the contents of the DMA_TIMEOUT[3:0] register, which is also calibrated in microseconds. When they match, the transceiver DMA will force **ips_xfr_wait_xcvr** low, and set the DMA_TIMED_OUT status bit. To clear this bit, disable transceiver DMA by writing DMA_PAGE=0, then write 1 to DMA_TIMED_OUT bit to clear it. Since the timeout condition arose from an erroneously configured transceiver or DMA controller, the data transferred during the DMA session, if any, should be considered invalid. Troubleshoot and rectify the conditions which led to the timeout condition, before initiating a new DMA debug session. DMA timeout applies only to Single Request mode, since **ips_xfr_wait_xcvr** is only asserted in this mode.

PAGE TABLE

The following table describes the available DMA_PAGE settings. The internal source data selected, the capture signal employed, the data packing method, the OSR setting, and the data rate, are provided for each DMA_PAGE setting.

| DMA PAGE | MNEMONIC | PACKING | OSR | CAPTURE SIGNAL | REQUEST RATE | REMARKS |
|----------|----------|--|-----|----------------------|--------------|--|
| 0 | DMAIDLE | --- | --- | --- | --- | No DMA Activity. All clocks to transceiver DMA hardware gated off. |
| 1 | RXDIGIQ | {4'd0, rx_dig_q[11:0], 4'b0, rx_dig_i[11:0]} | 4 | rx_dig_iq_vld (2MHz) | 2MHz | Q and I data captured. Max supported sample rate $ref_osc/16 = 2MHz$ for 32MHz clock. |
| 2 | RXDIGI | {4'd0, rx_dig_i[11:0], 4'b0, rx_dig_i[11:0]} | 2 | rx_dig_iq_vld (4MHz) | 2MHz | I data data captured. Max supported sample rate $ref_osc/8 = 4MHz$ for 32MHz clock. Newer sample is in upper bytes. |
| 3 | RXDIGQ | {4'd0, rx_dig_q[11:0], 4'b0, rx_dig_q[11:0]} | 2 | rx_dig_iq_vld (4MHz) | 2MHz | Q data captured. Max supported sample rate $ref_osc/8 = 4MHz$ for 32MHz clock. Newer sample is in upper bytes. |
| 4 | RAWADCIQ | {rx_dig_q[7:0], rx_dig_i[7:0], rx_dig_q[7:0], rx_dig_i[7:0]} | 2 | rx_dig_iq_vld (4MHz) | 2MHz | Raw ADC capture of I and Q channel but every other I and Q ADC sample are discarded The vld strobe will assert at $ref_clock/8 = 4MHz$ rate. (OSR needs to be programmed for 16). Newest samples are in upper bytes |
| 5 | RAWADCI | {rx_dig_i[7:0], rx_dig_i[7:0]} | 1 | rx_dig_iq_vld (8MHz) | 2MHz | Raw ADC capture of I channel. The vld |

Table continues on the next page...

| DMA PAGE | MNEMONIC | PACKING | OSR | CAPTURE SIGNAL | REQUEST RATE | REMARKS |
|----------|----------|---|-----|-------------------------|--------------|--|
| | | rx_dig_i[7:0], rx_dig_i[7:0]} | | | | strobe will assert at ref_clock/4 = 8MHz rate. (OSR needs to be programmed for 8). Newest sample is in MSB |
| 6 | RAWADCQ | {rx_dig_q[7:0], rx_dig_q[7:0], rx_dig_q[7:0], rx_dig_q[7:0]} | 1 | rx_dig_iq_vld (8MHz) | 2MHz | Raw ADC capture of Q channel. The vld strobe will assert at ref_clock/4 = 8MHz rate. (OSR needs to be programmed for 8). Newest sample is in MSB |
| 7 | DCESTIQ | {4'd0, Qdc_est[11:0], 4'b0, Idc_est[11:0]} | 4 | IQdc_est_vld (2MHz) | 2MHz | Q and I DCOC tracking estimator data captured. Max supported sample rate ref_osc/16 = 2MHz for 32MHz clock |
| 8 | DCESTI | {4'd0, Idc_est[11:0], 4'b0, Idc_est[11:0]} | 2 | IQdc_est_vld (4MHz) | 2MHz | I channel DCOC tracking estimator data captured. Max supported sample rate ref_osc/8 = 4MHz for 32MHz clock. Newer sample is in upper bytes |
| 9 | DCESTQ | {4'd0, Qdc_est[11:0], 4'b0, Qdc_est[11:0]} | 2 | IQdc_est_vld (4MHz) | 2MHz | Q channel DCOC tracking estimator data captured. Max supported sample rate ref_osc/8 = 4MHz for 32MHz clock. Newer sample is in upper bytes |
| 10 | RXINPH | {3'd0,rxin_ph[4:0] , 3'd0, rxin_ph[4:0], 3'd0, | 1 | rx_dig_ph_vld (8MHz) | 2MHz | Phase data captured. Max sample rate is ref_osc/2 = |

Table continues on the next page...

| DMA PAGE | MNEMONIC | PACKING | OSR | CAPTURE SIGNAL | REQUEST RATE | REMARKS |
|----------|----------|--|-----|-------------------------|--------------|--|
| | | rxin_ph[4:0], 3'd0, rxin_ph[4:0}} | | | | 8MHz for 32MHz clock. Newest sample in MSB |
| 11 | DMDHARD | 32 x {fsk_demod_bit} | --- | cg_vbr_en (1MHz) | 31.250KHz | Demodulated bit stream, hard decision output, captured at 1Mb/sec and packed into a 32-bit word with the newest sample in the MS bit position |
| 12 | DMDSOFT | {7'd0, fsk_demod_bit,f sk_demod_soft[7:0], 7'd0, fsk_demod_bit,f sk_demod_soft[7:0]} | --- | cg_vbr_en (1MHz) | 0.5MHz | Soft decision output, and hard decision output, captured at 1Mb/sec. Newest sample in the MS byte (bit) |
| 13 | DMDDATA | 32 x {data_out} | --- | cg_vbr_en (1MHz) | 31.250KHz | Demodulated bit stream, post- FIFO, captured at 1Mb/sec and packed into a 32-bit register with the newest sample in the MS bit position. Capturing begins only after AA match <i>and</i> the first PHY data_out_valid is asserted. |
| 14 | CFOPHASE | {3'd0, cfo_corrected_p h_in[4:0], 3'd0, cfo_corrected_p h_in[4:0], 3'd0, cfo_corrected_p h_in[4:0], 3'd0, cfo_corrected_p h_in[4:0]} | --- | rx_dig_ph_vld (8MHz) | 2MHz | CFO-corrected phase, captured at rx_dig_ph_vld (8MHz). Newest sample in MS byte |

EXAMPLE PROCEDURE

The following steps outline the setup and execution of a Transceiver DMA debug session. This example uses BLE protocol, acquires RX DIG I/Q data, and employs REQUEST-PER-SAMPLE DMA mode:

1. Configure MCU to run off the RF OSC clock source, with divider ratio = 1 (no division)
2. Program RX_DIG for BLE protocol, including
RX_DIG_CTRL[RX_DECT_FILT_OSR]=4
3. Set RX_DIG_CTRL[RX_DMA_DTEST_EN]=1
4. Set TSM_CTRL[FORCE_RX_EN]=1 to launch an RX sequence.
5. Program DMA_CTRL[DMA_PAGE]=RXDIGIQ,
DMA_CTRL[SINGLE_REQ_MODE]=0, and
DMA_CTRL[BYPASS_DMA_SYNC]=1.
6. Set
RSIM_CTRL[GASKET_BYPASS_OVRD_EN]=RSIM_CTRL[GASKET_BYPASS_OVRD]=1 (XCVR IPS gasket bypass)
7. Begin transmitting RF to the DUT
8. Wait for sufficient RX data to be collected to satisfy the requirements of the debug session
9. Clear
RSIM_CTRL[GASKET_BYPASS_OVRD_EN]=RSIM_CTRL[GASKET_BYPASS_OVRD]=0 (XCVR IPS gasket bypass off)
10. Program DMA_CTRL[DMA_PAGE]=0 to terminate the acquisition
11. Download the captured data from system memory

45.4.6.3.2 Packet RAM Debug Mode

Packet RAM Debug mode takes internal receive data from the RX_DIG or PHY, packs the data into a format suitable for storage in the radio's Packet RAM, and then directly fills the 2 RAMs with source data, under program control. Control and configuration of Packet RAM Debug operation is governed by the bit fields in the PACKET_RAM_CTRL register of XCVR address space. These bit fields are referenced in the description that follows. In a typical Packet RAM debug session, the debug hardware performs the following steps:

1. Selects a source of internal data from RX_DIG or PHY for capture based on
DBG_PAGE[3:0] setting
2. Uses a defined capture signal from RX_DIG or PHY to latch the internal data into a holding register
3. Selects a RAM fill method: sequential or simultaneous, based on DBG_PAGE setting
4. Sequentially packs 2 or more captures of internal data into a 16- or 32-bit register until the packing requirements for that DBG_PAGE setting are met
5. Directly accesses the 2 Packet RAM instances to store the receive data (addressing, write enabling, chip enabling, etc.)

6. Repeats steps 1-5 until the debug session is complete (DBG_PAGE set to 0).

Each source of RX_DIG or PHY data has a capture signal associated with it. The capture signal is generated in the source block. The capture signal is a one-reference-clock wide pulse that indicates that the next sample (or samples) of source data is ready for capture. For RX_DIG data sources, the frequency of the capture signal is affected by the RX_DECT_FILT_OSR[2:0] setting (see RX DIG Block Guide). In general there are no restrictions on the OSR setting for Packet RAM debug mode; the RAM fill rate should be able to track with the mission mode OSR settings used by the supported protocols. For any DMA_PAGE selecting source data from RX_DIG, set RX_DIG_CTRL[RX_DMA_DTEST_EN]=1 (in mission mode, this bit is clear to reduce power consumption.)

At the assertion of the capture signal, the transceiver takes the data sample(s) presented by RX_DIG or PHY and stores them in a holding register. Subsequent assertions on the capture signal fill different portions of the holding register, until the packing requirements for the selected DBG_PAGE setting are achieved. Packing of the receive data takes into account the RAM fill method employed, based on the DBG_PAGE setting. RAM fill can be sequential (RAM0 fills first completely, followed by RAM1) or simultaneous (both RAMs fill concurrently). A description of the packing requirements and the RAM fill method for each DBG_PAGE setting is included in the table below. Packing is complete when the page-specific packing requirements are met, and the contents of the holding register are written directly to the RAM instance(s).

The bandwidth to Packet RAM is much higher than Transceiver DMA, since the overhead of DMA-related synchronization and multi-master arbitration can be avoided. The maximum transfer rate for RAM debug mode, for a sample of width less than 8 bits (e.g., RAW ADC samples), and simultaneous RAM fill, can be as high as 128Msamples/sec (compared to 2Msamples/sec for DMA). The tradeoff is that the total Packet RAM space is smaller than the space available in system memory, restricting the size of the block of data that can be saved.

PACKET RAM

The Packet RAM consists of 2 identical RAM blocks, with identical dimensions of 16 bits wide and 544 entries deep

RAM DIMENSIONS

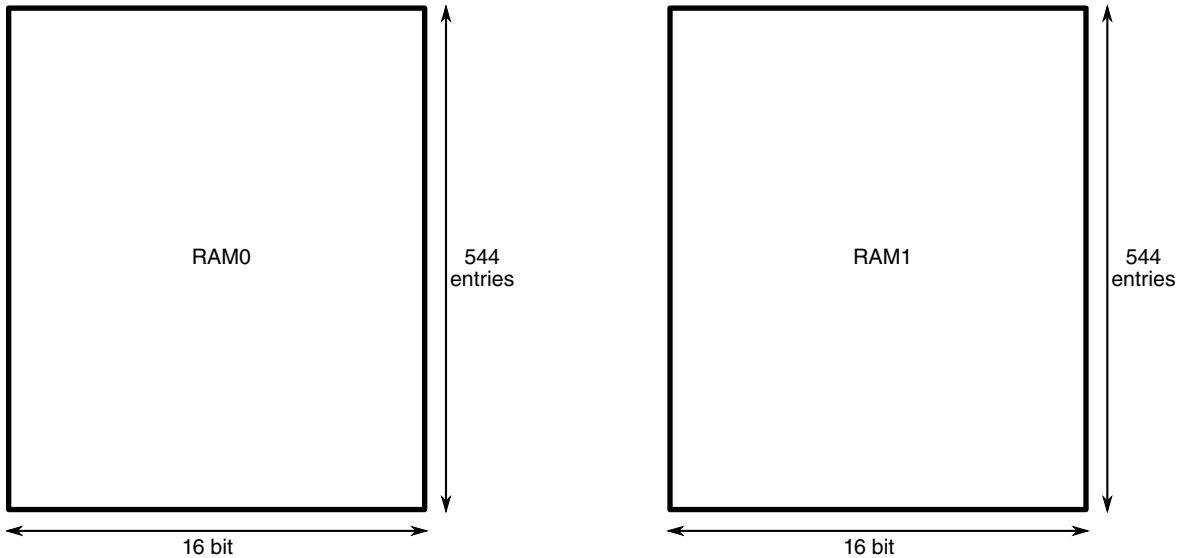

The RAMs are referred to as RAM0 and RAM1. In mission mode, the RAMs are partitioned into segments to suit the needs of the various protocols, and the sectioning is protocol-dependent. However for the purpose of Packet RAM Debug mode, the entire RAM space is made available for receiver data storage, as one contiguous address space. In Packet RAM Debug mode, the debug engine commandeers both RAMs for buffering receive data, and access attempts by the (mission mode) protocol engines to the RAMs are blocked. For a Packet RAM Debug session, set `XCVR_RAM_ALLOW=1`. This affords the transceiver IPS bus and the RAM debug engine exclusive access to both RAM blocks comprising the Packet RAM. It also continuously asserts the Chip Enable to both RAMs, and enables a free-running clocks to both RAMs, overriding these controls from the protocol link layers.

A Packet RAM debug session consists of 2 stages: Acquisition and Downloading.

ACQUISITION

In a typical debug session, the selection of a receive data source is made by setting `DBG_PAGE` to a non-zero value (see the table below for a description of the debug pages). Setting `DBG_PAGE` to a non-zero value starts the clocks to, and activates the Packet RAM Debug Engine. The engine has write-only access to both RAM's while receive data is being collected. (XCVR host IPS access is not blocked, but should be avoided during acquisition). The RAM's will fill with receive data, either sequentially or simultaneously, determined by the `DBG_PAGE` setting. If the receive data source selection involves simultaneous capture of symmetric I and Q channel data, RAM0 is dedicated to I channel capture and RAM1 to Q channel; in such cases, both RAMs fill simultaneously. In all other cases, the RAMs fill sequentially: RAM0 fills to capacity,

followed by RAM1. RAM addressing always starts at address 0 of either (or both) RAMs; the address for both RAMs is always reset to 0 when `DBG_PAGE=0`. When a RAM reaches capacity, further write attempts by the debug engine to that RAM are blocked, and the `DBG_RAM_FULL[0]` or `[1]` status bits become set, depending on which RAM is at capacity. When the fill method is simultaneous, both RAMs will reach the full state at the same instant. Otherwise, RAM0 will reach full first. When sufficient receive data has been acquired to satisfy the requirements of the debug session, or when both RAMs are full, the acquisition should be terminated by setting `DBG_PAGE=0`. The `DBG_RAM_FULL[0]` and `[1]` status bits are "sticky"; once set, they will remain set even after `DBG_PAGE` is set to 0 to end the session. Both bits will self-clear when a new acquisition is started by setting `DBG_PAGE` to a non-zero value. The `XCVR_RAM_ALLOW` should be set for the duration of the debug session. A diagram of the acquisition process is shown below:

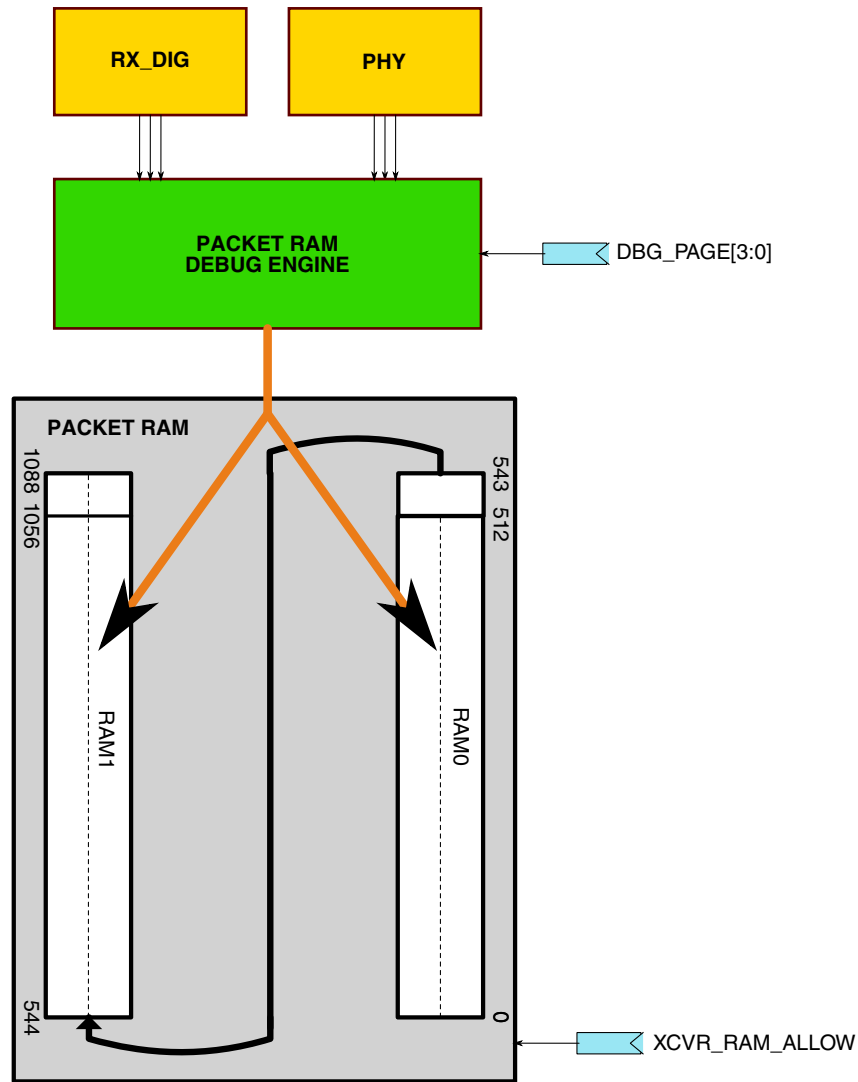

Figure 45-64. Packet RAM Debug Mode Block Diagram

DOWNLOADING

As soon as sufficient data has been collected to satisfy the requirements of the debug session, `DBG_PAGE` should be set to 0 to end the acquisition. The receive data stored in RAM may now be downloaded from the Packet RAM for analysis and post-processing. `XCVR_RAM_ALLOW` should stay set to allow XCVR IPS access to the RAM. The receive data in the RAM has been packed and distributed between the 2 RAMs in accordance with the `DBG_PAGE` selection. Regardless of the `DBG_PAGE` selection, the host accesses the RAM between addresses `XCVR_BASE+0x700` (base of RAM0) and `XCVR_BASE+0xF7F` (last address of RAM1). A diagram depicting how the 2 RAM instances are situated within XCVR address space is shown below.

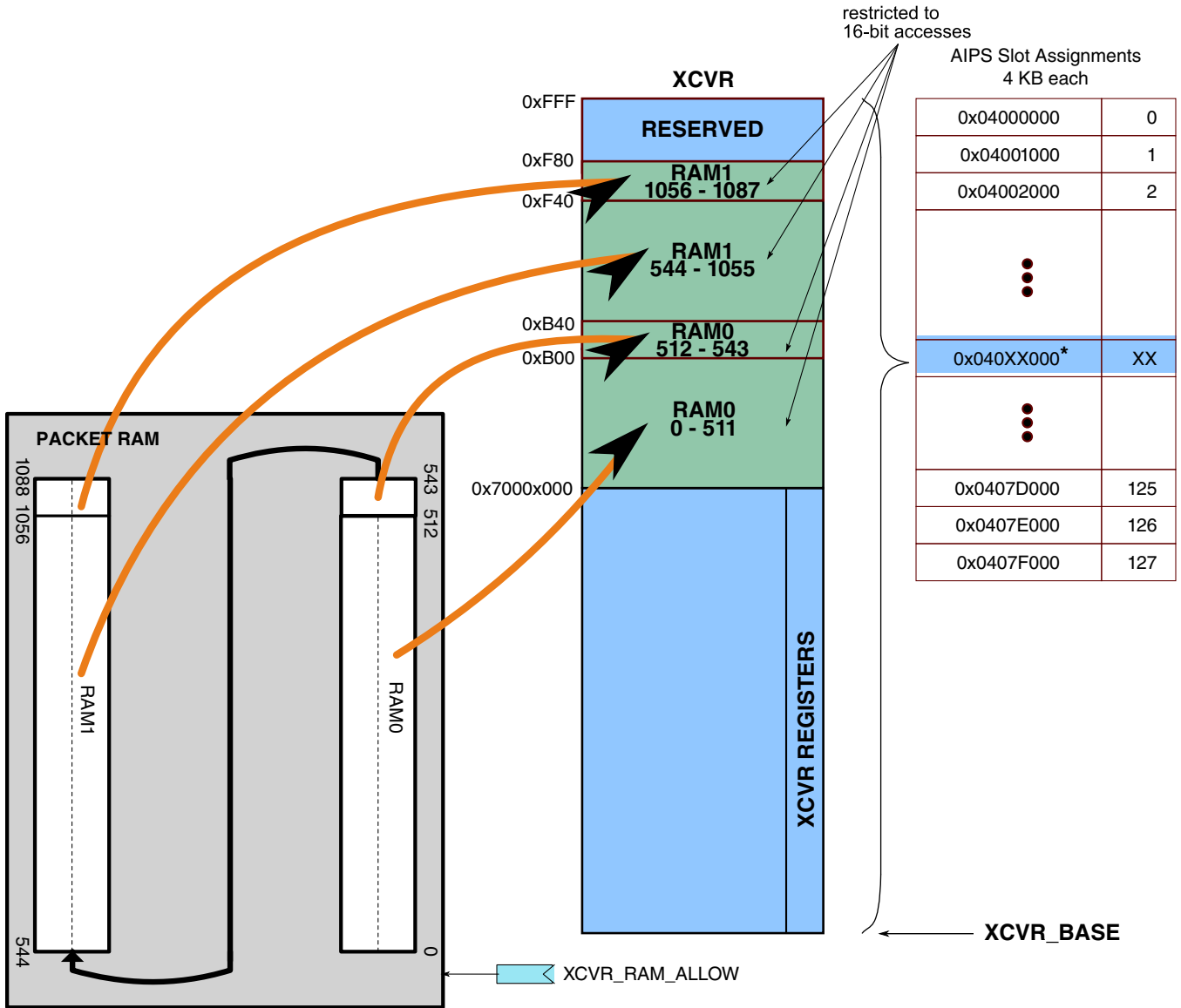

Figure 45-65. Packet RAM Memory Mapping in XCVR Space

PAGE TABLE

The following table describes the available DBG_PAGE settings. In most cases, the DBG_PAGE settings track the Transceiver DMA's DMA_PAGE settings; however DMA_PAGE settings which capture I- and Q-channel-only data are redundant for RAM debug mode, because the bandwidth to packet RAM is high enough to capture I and Q simultaneously with no loss of samples. The internal source data selected, the capture signal employed, the data packing method, and the RAM fill method, and the data rate, are provided for each DBG_PAGE setting.

| DBG PAGE | MNEMONIC | PACKING | CAPTURE SIGNAL | FILL METHOD | REMARKS |
|----------|----------|--|------------------|-------------|---|
| 0 | DBGIDLE | --- | --- | --- | No RAM Debug Activity. All clocks to transceiver debug hardware gated off. |
| 1 | RXDIGIQ | {4b0, rx_dig_i[11:0]} → RAM0 {4b0, rx_dig_q[11:0]} → RAM1 | rx_dig_iq_vld | Simul | Q and I data captured simultaneously. |
| 2 | --- | --- | --- | --- | --- |
| 3 | --- | --- | --- | --- | --- |
| 4 | RAWADCIQ | {rx_dig_i[7:0], rx_dig_i[7:0]} → RAM0 {rx_dig_q[7:0], rx_dig_q[7:0]} → RAM1 | rx_dig_iq_vld | Simul | Raw ADC capture of I and Q channel. Newest samples are in upper bytes |
| 5 | --- | --- | --- | --- | --- |
| 6 | --- | --- | --- | --- | --- |
| 7 | DCESTIQ | {4b0, ldc_est[11:0]} → RAM0 {4b0, Qdc_est[11:0]} → RAM1 | IQdc_est_vld | Simul | Q and I DCOC tracking estimator data captured. |
| 8 | --- | --- | --- | --- | --- |
| 9 | --- | --- | --- | --- | --- |
| 10 | RXINPH | {3'd0, rxin_ph[4:0], 3'd0, rxin_ph[3:0]} | rx_dig_ph_vld | Sequential | Phase data captured. Newest sample in MSB. Fill RAM0 first with 16 bit words, then fill RAM1 |
| 11 | DMDHARD | 16 x {fsk_demod_bit} | cg_vbr_en (1MHz) | Sequential | Demodulated bit stream, hard decision output, captured at 1Mb/sec and packed into a 16-bit word with the newest sample in the MS bit position |
| 12 | DMDSOFT | {7'd0, fsk_demod_bit, fsk_demod_soft[7:0]} | cg_vbr_en (1MHz) | Sequential | Soft decision output, and hard decision output, captured at 1Mb/sec. Newest sample in the MS byte (bit) |
| 13 | DMDDATA | 16 x {data_out} | cg_vbr_en (1MHz) | Sequential | Demodulated bit stream, post-FIFO, |

Table continues on the next page...

| DBG PAGE | MNEMONIC | PACKING | CAPTURE SIGNAL | FILL METHOD | REMARKS |
|----------|----------|--|----------------|-------------|--|
| | | | | | captured at 1Mb/sec and packed into a 16-bit register with the newest sample in the MS bit position. Capturing begins only after AA match <i>and</i> the first PHY data_out_valid is asserted. |
| 14 | CFOPHASE | {3'd0, cfo_corrected_ph_in[4:0], 3'd0, cfo_corrected_ph_in[4:0]} | rx_dig_ph_vld | Sequential | CFO-corrected phase, captured at rx_dig_ph_vld. Newest sample in MS byte |

EXAMPLE PROCEDURE

The following steps outline the setup and execution of a Packet RAM debug session. This example uses BLE protocol, and acquires RX DIG I/Q data

1. Program RX_DIG for BLE protocol
2. Set RX_DIG_CTRL[RX_DMA_DTEST_EN]=1
3. Set PACKET_RAM_CTRL[XCVR_RAM_ALLOW]=1 to allow exclusive XCVR access to radio RAMs
4. Set TSM_CTRL[FORCE_RX_EN]=1 to launch an RX sequence.
5. Begin transmitting RF to the DUT
6. Program PACKET_RAM_CTRL[DBG_PAGE]=RXDIGIQ to begin acquisition
7. Wait for sufficient RX data to be collected, or poll DBG_RAM_FULL[0] (and/or DBG_RAM_FULL[1]), to satisfy the requirements of the debug session
8. Program PACKET_RAM_CTRL[DBG_PAGE]=0 to terminate the acquisition
9. Download the captured data from Packet RAM

45.4.6.3.3 Simultaneous Transceiver DMA and RAM Debug

Tranceiver DMA mode and Packet RAM Debug mode are described in the previous sections. The DMA and Debug engines are separate, independent entities, which theoretically allows both to be employed simultaneously. The most practical case for simul operation would be to select an RX_DIG source for DMA_PAGE and a PHY source for DBG_PAGE. During a such simul debug session, RX_DIG data would go to system memory and PHY data to Packet RAM. After acquisition, data would be downloaded from both memories. Post-processing software could consolidate the data

and take advantage of the synergy that results from combining data captured simultaneously from multiple sources. (DTEST allows a possible third simultaneous source, beyond the scope of this Block Guide).

In addition, it is also theoretically possible to combine either or both debug modes with mission-mode packet reception, with the caveat that the Packet RAM would not be available to receive mission-mode packet data in such a scenario. (Packet processing, filtering, CRC checking, and Link Layer interrupts don't rely on packet RAM and so would not be impacted by the debug modes). Such a combination has been demonstrated successfully in radio-level simulation, with the following setup:

1. Transceiver DMA mode is engaged with DMA_PAGE set to RXINPH (RX phase capture)
2. Packet RAM Debug mode is engaged with DBG_PAGE set to DMDSOFT (PHY soft decision data)
3. RX phase data is downloaded from system memory and verified
4. Demod soft decision data is downloaded from Packet RAM and verified

45.4.6.4 Clocks

The module `xcvr_dma` includes the Transceiver DMA engine and the Packet RAM Debug engine. Each has its own clock:

1. `ipg_clk_dma` serves the Transceiver DMA hardware
2. `ipg_clk_ram_dbg` serves the Packet RAM debug hardware

The **`ipg_clk_dma`** is a gated 32mhz (or 26mhz) clock from the reference oscillator. This clock is activated when `DMA_CTRL[DMA_PAGE]` is set to a non-zero value, and deactivated when set to 0. Several other conditions allow this clock to free-run; for example, if the DMA request `ipd_req_radio_rx` is asserted, or if the `DMA_TIMED_OUT` status bit is asserted awaiting software clearing, **`ipg_clk_dma`** will free-run until those conditions are no longer true

The **`ipg_clk_ram_dbg`** is a gated 32mhz (or 26mhz) clock from the reference oscillator. This clock is connected to `ipg_clk_ram0`. This clock free-runs whenever RAM0 clocking is enabled. For debug mode, `PACKET_RAM_CTRL[XCVR_RAM_ALLOW]` sets this clock to free-running.

These 2 clocks are synchronous to each other. All inputs to `xcvr_dma` module, including both those destined for the Transceiver DMA engine and the Packet RAM debug engine, are also synchronized to the reference oscillator domain. There are no clock domain crossings in this module.

The DMA DarkBlue line signals can cross clock domain boundaries, when `SINGLE_REQ_MODE=1`. The clock domain crossings are from the reference oscillator domain to the MCU clock domain for `ipd_req_radio_rx`, and vice versa for `ipd_done_radio_rx`. Synchronization, both ways, is accomplished outside the radio, in an SoC level block called `radio_dma_sync_glue`. These signals cross no clock domains inside the radio itself.

The DMA SkyBlue line signal `ips_xfr_wait_xcvr` can cross clock domain boundaries, when `SINGLE_REQ_MODE=1`. The clock domain crossing is from the reference oscillator domain to the MCU clock domain. Synchronization is accomplished in the XCVR IPS bus gasket.

There are no special requirements for these clocks, and no anticipated critical paths associated with them.

45.4.6.5 Reset

The `xcvr_dma` module has a single, active-low, asynchronous reset input: `ipg_hard_async_reset_b`. At integration, this reset should be tied to the master reset for the entire transceiver. There are no special reset requirements.

45.4.6.6 Interrupts

There are no interrupts associated with either Transceiver DMA mode or Packet RAM Debug mode.

45.4.7 Transceiver Memory Map and Register Definition

Transceiver registers are detailed in following section.

45.4.7.1 XCVR_MISC Register Descriptions

45.4.7.1.1 XCVR_CTRL_ADDR Memory Map

Base address: 4005C280h

| Offset | Register | Width (In bits) | Access | Reset value |
|-----------|--|--------------------|--------|------------------|
| 4005C280h | TRANSCEIVER CONTROL (XCVR_CTRL) | 32 | RW | 00101000h |
| 4005C284h | TRANSCEIVER STATUS (XCVR_STATUS) | 32 | W1C | See description. |
| 4005C288h | BLE ARBITRATION CONTROL (BLE_ARB_CTRL) | 32 | RW | 00000000h |
| 4005C290h | OVERWRITE VERSION (OVERWRITE_VER) | 32 | RW | 00000000h |
| 4005C294h | TRANSCEIVER DMA CONTROL (DMA_CTRL) | 32 | RW | 00000300h |
| 4005C298h | TRANSCEIVER DMA DATA (DMA_DATA) | 32 | RO | 00000000h |
| 4005C2A0h | PACKET RAM CONTROL (PACKET_RAM_CTRL) | 32 | RW | 00000000h |
| 4005C2A4h | FAD CONTROL (FAD_CTRL) | 32 | RW | 0000F080h |
| 4005C2A8h | LOW POWER PREAMBLE SEARCH CONTROL (LPPS_CTRL) | 32 | RW | 64260000h |
| 4005C2ACh | WIFI COEXISTENCE CONTROL (RF_NOT_ALLOWED_CTRL) | 32 | RW | 00000000h |
| 4005C2B0h | CRC/WHITENER CONTROL (CRCW_CFG) | 32 | RW | 00000001h |
| 4005C2B4h | CRC ERROR CORRECTION MASK (CRC_EC_MASK) | 32 | RO | 00000000h |
| 4005C2B8h | CRC RESULT (CRC_RES_OUT) | 32 | RO | 00000000h |

45.4.7.1.2 TRANSCEIVER CONTROL (XCVR_CTRL)

45.4.7.1.2.1 Address

| Register | Offset |
|-----------|-----------|
| XCVR_CTRL | 4005C280h |

45.4.7.1.2.2 Diagram

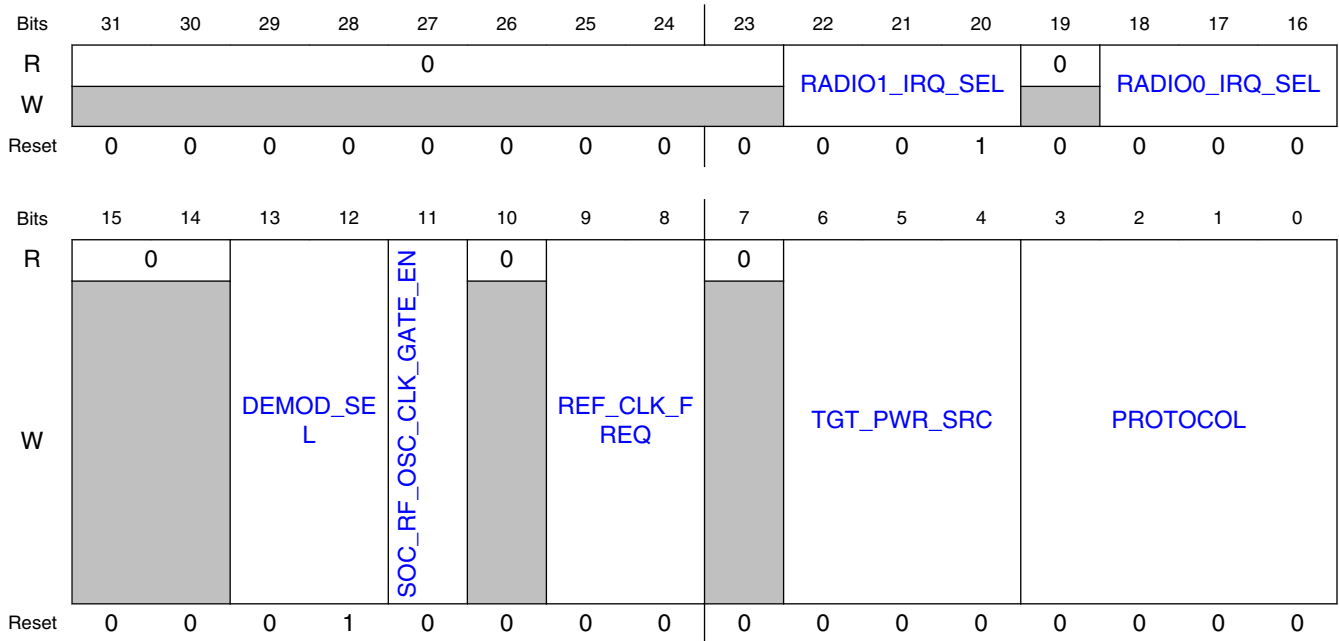

45.4.7.1.2.3 Fields

| Field | Function |
|-------------------------|--|
| 31-23 — | Reserved |
| 22-20 RADIO1_IRQ_SEL | RADIO1_IRQ_SEL Assigns Radio #1 Interrupt (ipi_int_radio1) to a Protocol Engine 000b - Assign Radio #1 Interrupt to BLE 001b - Assign Radio #1 Interrupt to 802.15.4 010b - Radio #1 Interrupt unassigned 011b - Assign Radio #1 Interrupt to GENERIC_FSK 100b - Radio #1 Interrupt unassigned 101b - Radio #1 Interrupt unassigned 110b - Radio #1 Interrupt unassigned 111b - Radio #1 Interrupt unassigned |
| 19 — | Reserved |
| 18-16 RADIO0_IRQ_SEL | RADIO0_IRQ_SEL Assigns Radio #0 Interrupt (ipi_int_radio0) to a Protocol Engine 000b - Assign Radio #0 Interrupt to BLE 001b - Assign Radio #0 Interrupt to 802.15.4 010b - Radio #0 Interrupt unassigned 011b - Assign Radio #0 Interrupt to GENERIC_FSK 100b - Radio #0 Interrupt unassigned 101b - Radio #0 Interrupt unassigned 110b - Radio #0 Interrupt unassigned 111b - Radio #0 Interrupt unassigned |

Table continues on the next page...

| Field | Function | | | | | | | | | | | | | | | | | | |
|------------------------------|---|------------------|---------------------|-------|-------------------------------------|-------|-----------------|-------|--|-------|----------|-------|--|-------|----------|-------|----------|-------|--|
| 15-14 — | Reserved | | | | | | | | | | | | | | | | | | |
| 13-12 DEMOD_SEL | Demodulator Selector This bit selects the demodulator used during reception 00b - No demodulator selected 01b - Use Freescale Constant Envelope demodulator 10b - Use Legacy 802.15.4 demodulator 11b - Reserved | | | | | | | | | | | | | | | | | | |
| 11 SOC_RF_OSC_CLK_GATE_EN | SOC_RF_OSC_CLK_GATE_EN Enable 3V version of RF OSC Clock for use by the SoC | | | | | | | | | | | | | | | | | | |
| 10 — | Reserved | | | | | | | | | | | | | | | | | | |
| 9-8 REF_CLK_FREQ | Radio Reference Clock Frequency This register selects the Reference Clock Frequency for the Radio. 00b - 32 MHz 01b - 26 MHz 10b - Reserved 11b - Reserved | | | | | | | | | | | | | | | | | | |
| 7 — | Reserved | | | | | | | | | | | | | | | | | | |
| 6-4 TGT_PWR_SRC | Target Power Source For determining transmit power, the TGT_PWR_SRC[2:0] bits control target power selection, according to the following table. | | | | | | | | | | | | | | | | | | |
| | <table border="1"> <thead> <tr> <th>TGT_PWR_SRC[2:0]</th> <th>TARGET POWER SOURCE</th> </tr> </thead> <tbody> <tr> <td>0b000</td> <td>PA_POWER[5:0] register (XCVR space)</td> </tr> <tr> <td>0b001</td> <td>BTLE Link Layer</td> </tr> <tr> <td>0b010</td> <td>802.15.4 Link Layer (PA_PWR[5:0] register in 802.15.4 space)</td> </tr> <tr> <td>0b011</td> <td>Reserved</td> </tr> <tr> <td>0b100</td> <td>GENERIC_FSK Link Layer (TX_POWER[5:0] register in GENERIC_FSK space)</td> </tr> <tr> <td>0b101</td> <td>Reserved</td> </tr> <tr> <td>0b110</td> <td>Reserved</td> </tr> <tr> <td>0b111</td> <td>PROTOCOL[3:0] bits determine target power source</td> </tr> </tbody> </table> | TGT_PWR_SRC[2:0] | TARGET POWER SOURCE | 0b000 | PA_POWER[5:0] register (XCVR space) | 0b001 | BTLE Link Layer | 0b010 | 802.15.4 Link Layer (PA_PWR[5:0] register in 802.15.4 space) | 0b011 | Reserved | 0b100 | GENERIC_FSK Link Layer (TX_POWER[5:0] register in GENERIC_FSK space) | 0b101 | Reserved | 0b110 | Reserved | 0b111 | PROTOCOL[3:0] bits determine target power source |
| TGT_PWR_SRC[2:0] | TARGET POWER SOURCE | | | | | | | | | | | | | | | | | | |
| 0b000 | PA_POWER[5:0] register (XCVR space) | | | | | | | | | | | | | | | | | | |
| 0b001 | BTLE Link Layer | | | | | | | | | | | | | | | | | | |
| 0b010 | 802.15.4 Link Layer (PA_PWR[5:0] register in 802.15.4 space) | | | | | | | | | | | | | | | | | | |
| 0b011 | Reserved | | | | | | | | | | | | | | | | | | |
| 0b100 | GENERIC_FSK Link Layer (TX_POWER[5:0] register in GENERIC_FSK space) | | | | | | | | | | | | | | | | | | |
| 0b101 | Reserved | | | | | | | | | | | | | | | | | | |
| 0b110 | Reserved | | | | | | | | | | | | | | | | | | |
| 0b111 | PROTOCOL[3:0] bits determine target power source | | | | | | | | | | | | | | | | | | |
| 3-0 PROTOCOL | Radio Protocol Selection This register selects the Radio Communication Protocol. 0000b - BLE 0001b - BLE in MBAN 0010b - BLE overlap MBAN 0011b - Reserved 0100b - 802.15.4 0101b - 802.15.4j | | | | | | | | | | | | | | | | | | |

FSK Modulator

| Field | Function |
|-------|---|
| | 0110b - 128 Channel FSK 0111b - 128 Channel GFSK 1000b - Generic FSK 1001b - MSK |

45.4.7.1.3 TRANSCEIVER STATUS (XCVR_STATUS)

45.4.7.1.3.1 Address

| Register | Offset |
|-------------|-----------|
| XCVR_STATUS | 4005C284h |

45.4.7.1.3.2 Diagram

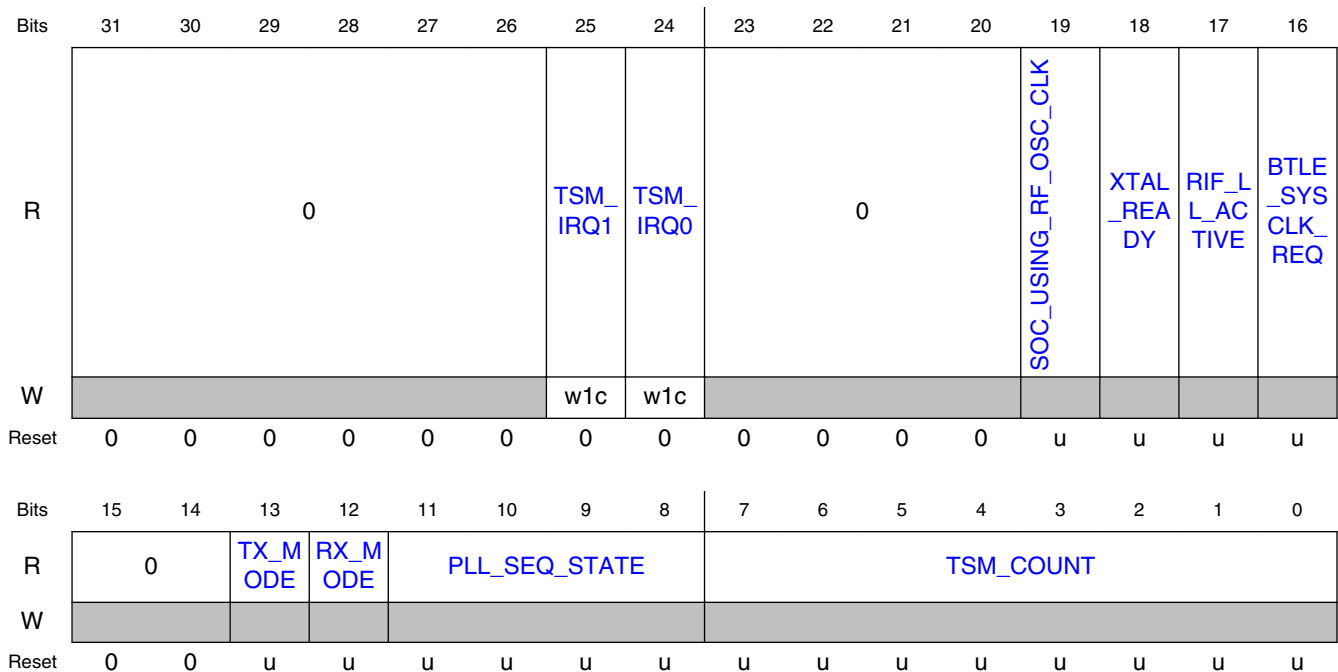

45.4.7.1.3.3 Fields

| Field | Function |
|-------|------------------|
| 31-26 | Reserved |
| — | |
| 25 | TSM Interrupt #1 |

Table continues on the next page...

| Field | Function |
|----------------------------|---|
| TSM_IRQ1 | 0b - TSM Interrupt #1 is not asserted. 1b - TSM Interrupt #1 is asserted. Write '1' to this bit to clear it. |
| 24 TSM_IRQ0 | TSM Interrupt #0 0b - TSM Interrupt #0 is not asserted. 1b - TSM Interrupt #0 is asserted. Write '1' to this bit to clear it. |
| 23-20 — | Reserved |
| 19 SOC_USING_RF_OSC_CLK | SOC Using RF Clock Indication SoC signal from the CLKGEN that asserts high when the MCG is configured to use RF OSC clock as the SoC clock source |
| 18 XTAL_READY | RF Oscillator Xtal Ready Oscillator warmup count complete. 0b - Indicates that the RF Oscillator is disabled or has not completed its warmup. 1b - Indicates that the RF Oscillator has completed its warmup count and is ready for use. |
| 17 RIF_LL_ACTIVE | Link Layer Active Indication Reflects the state of the BTLE “Link Layer Active” status bit. RIF_LL_ACTIVE is to be used by the host as an 'early' indication to prevent host to do any operations while BTLE IP is doing transceiver operations, so as to reduce the peak power and noise. |
| 16 BTLE_SYSCLOCK_REQ | BTLE System Clock Request Reflects the state of the BTLE oscillator request signal. BTLE_SYSCLOCK_REQ is the BTLE control for the RF Oscillator. BTLE will deassert this signal upon entering DSM (deep sleep mode) to request oscillator turn-off, and will re-assert it prior to exiting DSM. The turn-on leadtime on this signal for exiting DSM, is programmable with the BTLE block. This read-only bit can thus be queried to ascertain the power-state of BTLE. |
| 15-14 — | Reserved |
| 13 TX_MODE | Transmit Mode Indicates an TX transceiver operation is in progress. |
| 12 RX_MODE | Receive Mode Indicates an RX transceiver operation is in progress. |
| 11-8 PLL_SEQ_STATE | PLL Sequence State Reflects the state of the PLL digital state machine. 0000b - PLL OFF 0010b - CTUNE 0011b - CTUNE_SETTLE 0110b - HPMCAL1 1000b - HPMCAL1_SETTLE 1010b - HPMCAL2 1100b - HPMCAL2_SETTLE 1111b - PLLREADY |
| 7-0 TSM_COUNT | TSM_COUNT Reflects the instantaneous value of the TSM counter. |

45.4.7.1.4 BLE ARBITRATION CONTROL (BLE_ARB_CTRL)

45.4.7.1.4.1 Address

| Register | Offset |
|--------------|-----------|
| BLE_ARB_CTRL | 4005C288h |

45.4.7.1.4.2 Diagram

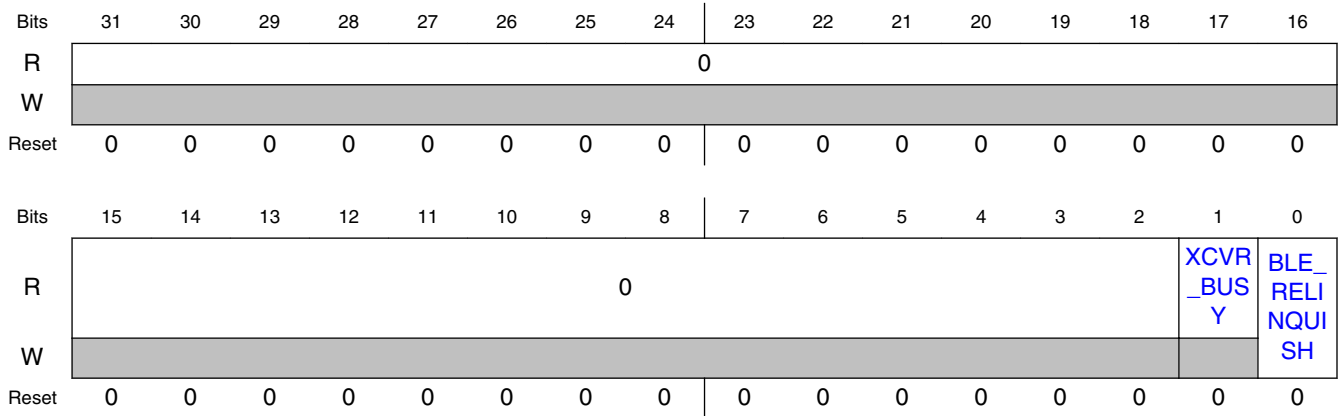

45.4.7.1.4.3 Fields

| Field | Function |
|-------------------------|--|
| 31-2 Reserved | Reserved |
| 1 XCVR_BUSY | Transceiver Busy Status Bit 0b - RF Channel in available (TSM is idle) 1b - RF Channel in use (TSM is busy) |
| 0 BLE_RELINQUI SH | BLE Relinquish Control This bit forces the BLE protocol engine to immediately relinquish access to the RF Channel, in favor of another protocol with higher arbitration priority. BLE is denied RF channel access by blocking BLE access to the TSM; when this bit is subsequently cleared, BLE access is restored. |

45.4.7.1.5 OVERWRITE VERSION (OVERWRITE_VER)

45.4.7.1.5.1 Address

| Register | Offset |
|---------------|-----------|
| OVERWRITE_VER | 4005C290h |

45.4.7.1.5.2 Function

The Overwrite Version allows software to store a version number of trim and calibration values which are used to overwrite the chip default values in the registers. Typically, software would perform the overwrite of the defaults in transceiver registers and then write the version number from the file containing the overwrite values into this register.

NOTE

This register has no hardware connections, it is simply a designated storage location for a version number.

45.4.7.1.5.3 Diagram

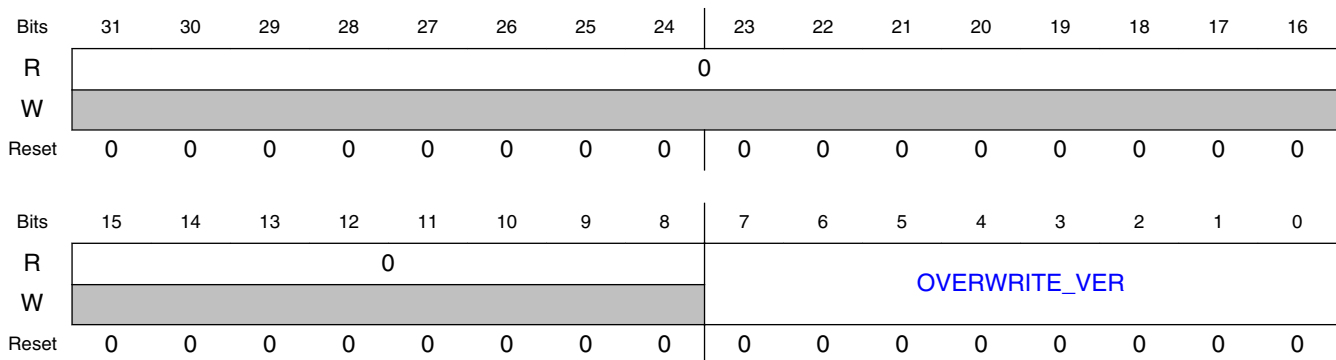

45.4.7.1.5.4 Fields

| Field | Function |
|--------------------------|---|
| 31-8 Reserved | Reserved |
| 7-0 OVERWRITE_V ER | Overwrite Version Number. Points to the version number of the overwrites.h file used to initialize the device; can be used by software to identify a version-controlled set of non-default values to be written into the transceiver's register map. |

45.4.7.1.6 TRANSCEIVER DMA CONTROL (DMA_CTRL)

45.4.7.1.6.1 Address

| Register | Offset |
|----------|-----------|
| DMA_CTRL | 4005C294h |

45.4.7.1.6.2 Diagram

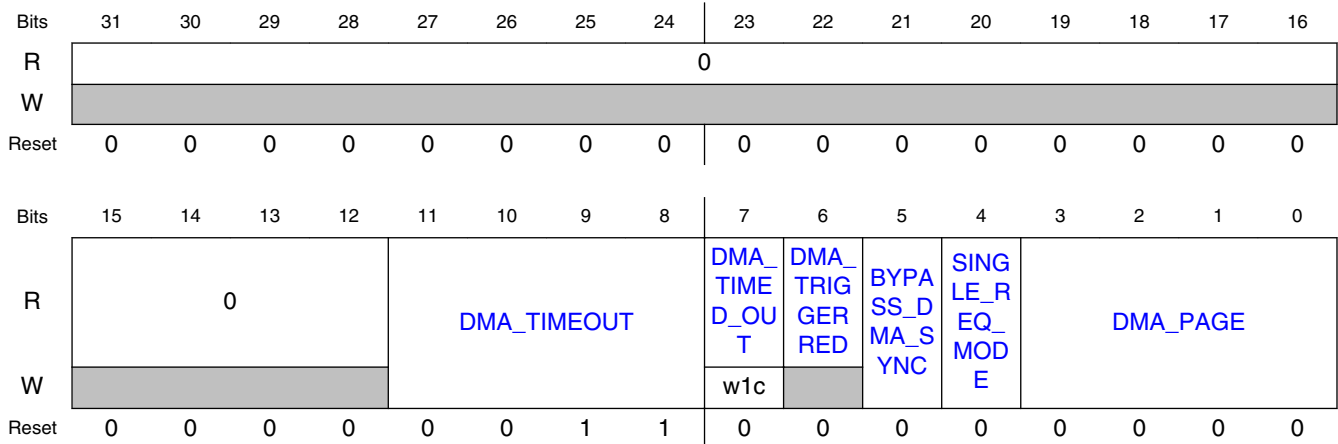

45.4.7.1.6.3 Fields

| Field | Function |
|----------------------|--|
| 31-12 Reserved | Reserved |
| 11-8 DMA_TIMEOUT | DMA Timeout In DMA Single Request Mode, adverse consequences may result if the transceiver's ips_xfr_wait signal is asserted for an excessively long period of time, which could occur due to mis-programming of the DMA2 controller, and/or the transceiver itself. DMA Timeout forces the transceiver's ips_xfr_wait low after N microseconds and sets the DMA_TIMED_OUT status bit, where N=DMA_TIMEOUT. DMA_TIMEOUT is only relevant when SINGLE_REQ_MODE=1, otherwise the transceiver does not assert ips_xfr_wait. |
| 7 DMA_TIMED_OUT | DMA Transfer Timed Out Status bit indicates that the transceiver DMA, while operating in Single Request Mode, asserted ips_xfr_wait for a period in excess of the programmed DMA_TIMEOUT setting, resulting in a timeout condition where the transceiver has forced ips_xfr_wait low. After a timeout, before resuming DMA operations, set DMA_PAGE=0 to disable DMA, and write 1 to this bit to clear it. 0b - A DMA timeout has not occurred 1b - A DMA timeout has occurred in Single Request Mode since the last time this bit was cleared |
| 6 DMA_TRIGGERED | DMA TRIGGERED This status bit becomes set when the PHY indicates that a Network Address match has occurred. In some cases it may be desirable to delay the start of DMA transfers until such a match occurs; in such cases, software can poll this bit, and once it becomes set, immediately select the desired DMA_PAGE to initiate DMA transfers. This bit is intended for use with DMA_PAGE=13, but is available on all pages. Its usage is optional. |
| 5 BYPASS_DMA_SYNC | Bypass External DMA Synchronization When using transceiver DMA with SINGLE_REQ_MODE=0, synchronization external to the transceiver must be bypassed in order to minimize bus access latency. Using DMA in this mode also requires that the MCU and transceiver both are configured to operate in the RF Oscillator clock domain. 0b - Don't Bypass External Synchronization. Use this setting if SINGLE_REQ_MODE=1. 1b - Bypass External Synchronization. This setting is mandatory if SINGLE_REQ_MODE=0. |
| 4 | DMA Single Request Mode |

Table continues on the next page...

| Field | Function |
|-----------------|---|
| SINGLE_REQ_MODE | <p>Configures the transceiver to transfer the entire block of DMA data with only a single initial request (ipd_req_radio_rx). The DMA2 controller must be configured accordingly. In this mode, the transceiver will use ips_xfr_wait to pace the individual transactions. Single Request Mode should not be used with DMA Pages 11, 12, or 13, because the data rate is too low and therefore ips_xfr_wait would remain asserted for excessively long periods.</p> <p>0b - Disable Single Request Mode. The transceiver will assert ipd_req_radio_rx whenever it has a new sample ready for transfer.</p> <p>1b - Enable Single Request Mode. A single initial request by the transceiver will transfer the entire DMA block of data</p> |
| 3-0 DMA_PAGE | <p>Transceiver DMA Page Selector</p> <p>Selects the page of receiver data for storage to system memory when using Transceiver DMA Debug Mode. Setting this register to a non-zero value enables the DMA interface logic. Setting this register to zero disables the interface and gates off all associated clocking. The available DMA pages are listed below.</p> <p>0000b - DMA Idle 0001b - RX_DIG I and Q 0010b - RX_DIG I Only 0011b - RX_DIG Q Only 0100b - RAW ADC I and Q 0101b - RAW ADC I Only 0110b - RAW ADC Q only 0111b - DC Estimator I and Q 1000b - DC Estimator I Only 1001b - DC Estimator Q only 1010b - RX_DIG Phase Output 1011b - Demodulator Hard Decision 1100b - Demodulator Soft Decision 1101b - Demodulator Data Output 1110b - Demodulator CFO Phase Output 1111b - Reserved</p> |

45.4.7.1.7 TRANSCEIVER DMA DATA (DMA_DATA)

45.4.7.1.7.1 Address

| Register | Offset |
|----------|-----------|
| DMA_DATA | 4005C298h |

45.4.7.1.7.2 Diagram

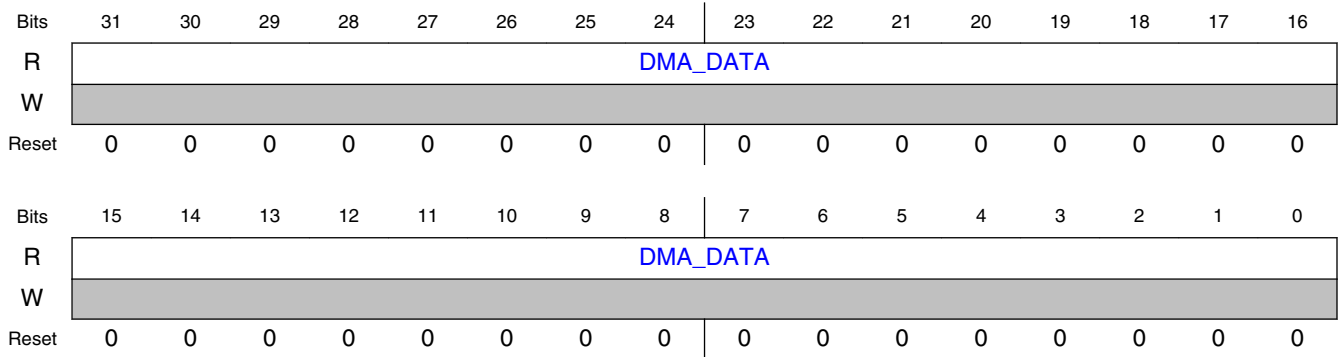

45.4.7.1.7.3 Fields

| Field | Function |
|------------------|--|
| 31-0 DMA_DATA | <p>DMA Data Register</p> <p>This register is the singular address location at which the SoC DMA controller accesses samples from the transceiver for transfer to system memory. During DMA operation, the contents of this register depend on the DMA Page selected. The DMA Data register is intended for DMA purposes only, not Host IPS accesses, but Host IPS bus access to this register is not prohibited.</p> |

45.4.7.1.8 PACKET RAM CONTROL (PACKET_RAM_CTRL)

45.4.7.1.8.1 Address

| Register | Offset |
|-----------------|-----------|
| PACKET_RAM_CTRL | 4005C2A0h |

45.4.7.1.8.2 Diagram

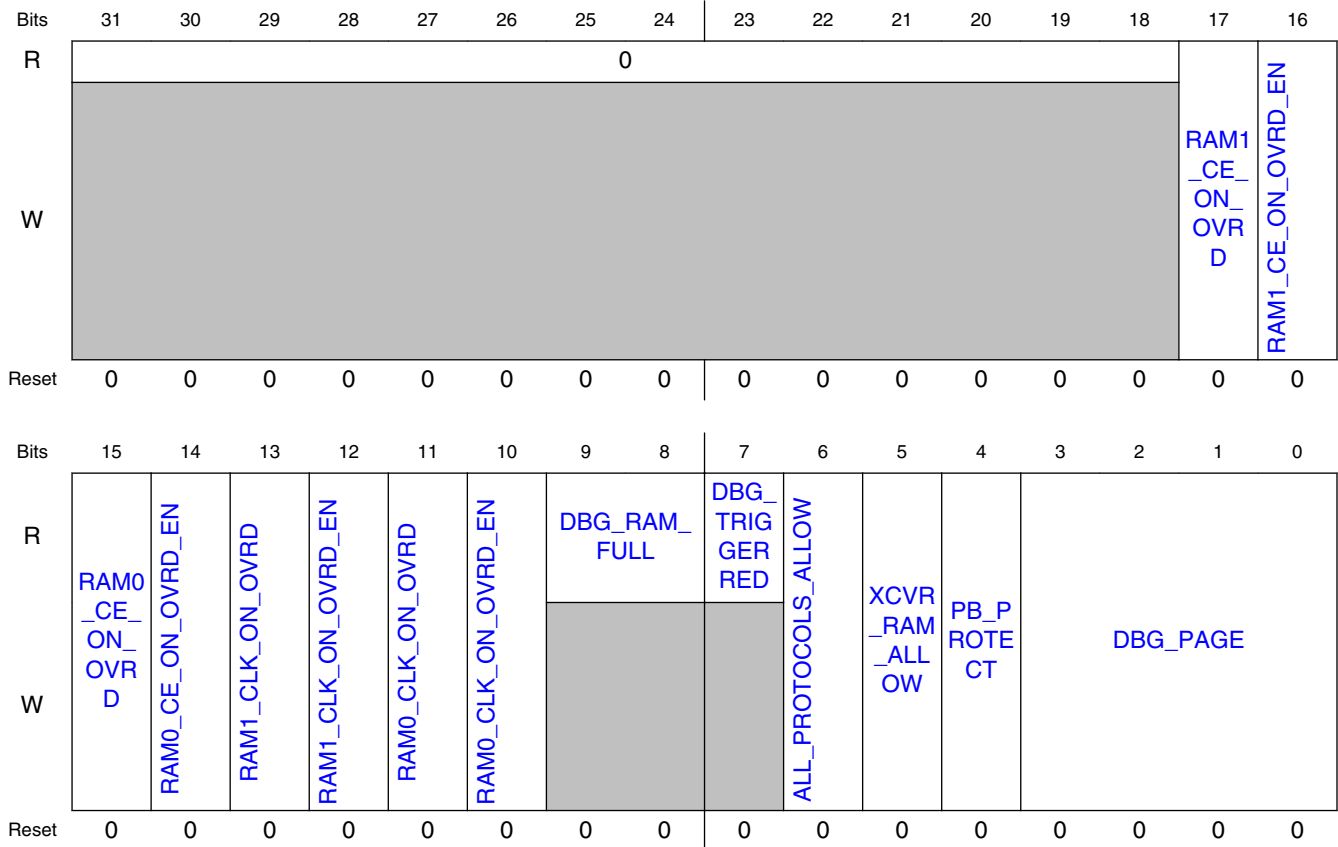

45.4.7.1.8.3 Fields

| Field | Function |
|--------------------------|---|
| 31-18 — | Reserved |
| 17 RAM1_CE_ON_OVRD | Override value for RAM1 CE (Chip Enable) When RAM1_CE_ON_OVRD_EN=1, this value overrides the mission mode state of the RAM1 CE. This bit is ignored when RAM1_CE_ON_OVRD_EN=0. |
| 16 RAM1_CE_ON_OVRD_EN | Override control for RAM1 CE (Chip Enable) 0b - Normal operation. 1b - Use the state of RAM1_CE_ON_OVRD to override the RAM1 CE. |
| 15 RAM0_CE_ON_OVRD | Override value for RAM0 CE (Chip Enable) When RAM0_CE_ON_OVRD_EN=1, this value overrides the mission mode state of the RAM0 CE. This bit is ignored when RAM0_CE_ON_OVRD_EN=0. |
| 14 RAM0_CE_ON_OVRD_EN | Override control for RAM0 CE (Chip Enable) 0b - Normal operation. 1b - Use the state of RAM0_CE_ON_OVRD to override the RAM0 CE. |
| 13 | Override value for RAM1 Clock Gate Enable |

Table continues on the next page...

FSK Modulator

| Field | Function |
|---------------------------|---|
| RAM1_CLK_ON_OVRD | When RAM1_CLK_ON_OVRD_EN=1, this value overrides the mission mode state of the RAM1 Clock Gate Enable. This bit is ignored when RAM1_CLK_ON_OVRD_EN=0. |
| 12 RAM1_CLK_ON_OVRD_EN | Override control for RAM1 Clock Gate Enable 0b - Normal operation. 1b - Use the state of RAM1_CLK_ON_OVRD to override the RAM1 Clock Gate Enable. |
| 11 RAM0_CLK_ON_OVRD | Override value for RAM0 Clock Gate Enable When RAM0_CLK_ON_OVRD_EN=1, this value overrides the mission mode state of the RAM0 Clock Gate Enable. This bit is ignored when RAM0_CLK_ON_OVRD_EN=0. |
| 10 RAM0_CLK_ON_OVRD_EN | Override control for RAM0 Clock Gate Enable 0b - Normal operation. 1b - Use the state of RAM0_CLK_ON_OVRD to override the RAM0 Clock Gate Enable. |
| 9-8 DBG_RAM_FULL | DBG_RAM_FULL[1:0] Status Bits indicating that Packet RAM0 (or RAM1) is full, and the Packet RAM Debug engine has attempted to write another word to that RAM. This, and any subsequent write attempts, will not alter the contents of the RAM, once it has reached capacity. Set DBG_PAGE=0 to clear the DBG_RAM_FULL[1:0] bits. 00b - Neither Packet RAM0 nor RAM1 is full x1b - Packet RAM0 has been filled to capacity. 1xb - Packet RAM1 has been filled to capacity. |
| 7 DBG_TRIGGERED | DBG_TRIGGERED This status bit becomes set when the PHY indicates that a Network Address match has occurred. In some cases it may be desirable to delay the start of Packet RAM debug transfers until such a match occurs; in such cases, software can poll this bit, and once it becomes set, immediately select the desired DBG_PAGE to initiate data transfers to Packet RAM. This bit is intended for use with DBG_PAGE=13, but is available on all pages. Its usage is optional. |
| 6 ALL_PROTOCOLS_ALLOW | Allow IPS bus access to Packet RAM for any protocol at any time. Each supported protocol has an associated IPS bus, with which it can access protocol-specific registers, as well as Packet RAM. Normally IPS bus access to the Packet RAM is restricted to the protocol currently selected by the XCVR_CTRL[PROTOCOL] register, and access attempts by other protocols will result in an assert of ips_xfr_err on the offending IPS interface. When ALL_PROTOCOLS_ALLOW=1, these inhibitions are removed, and any IPS bus can access Packet RAM at any time without any error signalling. 0b - IPS bus access to Packet RAM is restricted to the protocol engine currently selected by XCVR_CTRL[PROTOCOL]. 1b - All IPS bus access to Packet RAM permitted, regardless of XCVR_CTRL[PROTOCOL] setting |
| 5 XCVR_RAM_ALLOWED | Allow Packet RAM Transceiver Access This bit must be set before performing accesses to the Packet RAM using transceiver address space. Transceiver space accesses to Packet RAM are intended for debug purposes only; the individual protocol engines, and the associated IPS busses, have exclusive access to Packet RAM in mission modes. Transceiver space accesses to Packet RAM include direct accesses to RAM at transceiver addresses 0x700 - 0xF80, as well as Packet RAM Debug Mode. When this bit is set, control of RAM clock gating and RAM chip enables are forced on continuously, taking these controls away from the protocol engines. NOTE: In Packet RAM Debug mode, this bit should be set to 1 first, prior to setting DBG_PAGE to any non-zero setting 0b - Protocol Engines, and associated IPS busses, have exclusive access to Packet RAM (mission mode) 1b - Transceiver-space access to Packet RAM, including Packet RAM debug mode, are allowed |
| 4 PB_PROTECT | Packet Buffer Protect |

Table continues on the next page...

| Field | Function |
|-----------------|--|
| | Protect Packet Buffer contents against overwriting by the next received packet. Applies to all protocols except BLE 0b - Incoming received packets overwrite Packet Buffer RX contents (default) 1b - Incoming received packets are blocked from overwriting Packet Buffer RX contents |
| 3-0 DBG_PAGE | Packet RAM Debug Page Selector Selects the page of receiver data for storage to Packet RAM using Transceiver Packet RAM Debug Mode. Setting this register to a non-zero value enables the Packet RAM Debug mode interface logic. Setting this register to zero disables the interface logic and gates off all associated clocking. The available RAM Debug pages are listed below. 0000b - Packet RAM Debug Mode Idle 0001b - RX_DIG I and Q 0010b - Reserved 0011b - Reserved 0100b - RAW ADC I and Q 0101b - Reserved 0110b - Reserved 0111b - DC Estimator I and Q 1000b - Reserved 1001b - Reserved 1010b - RX_DIG Phase Output 1011b - Demodulator Hard Decision 1100b - Demodulator Soft Decision 1101b - Demodulator Data Output 1110b - Demodulator CFO Phase Output 1111b - Reserved |

45.4.7.1.9 FAD CONTROL (FAD_CTRL)

45.4.7.1.9.1 Address

| Register | Offset |
|----------|-----------|
| FAD_CTRL | 4005C2A4h |

45.4.7.1.9.2 Diagram

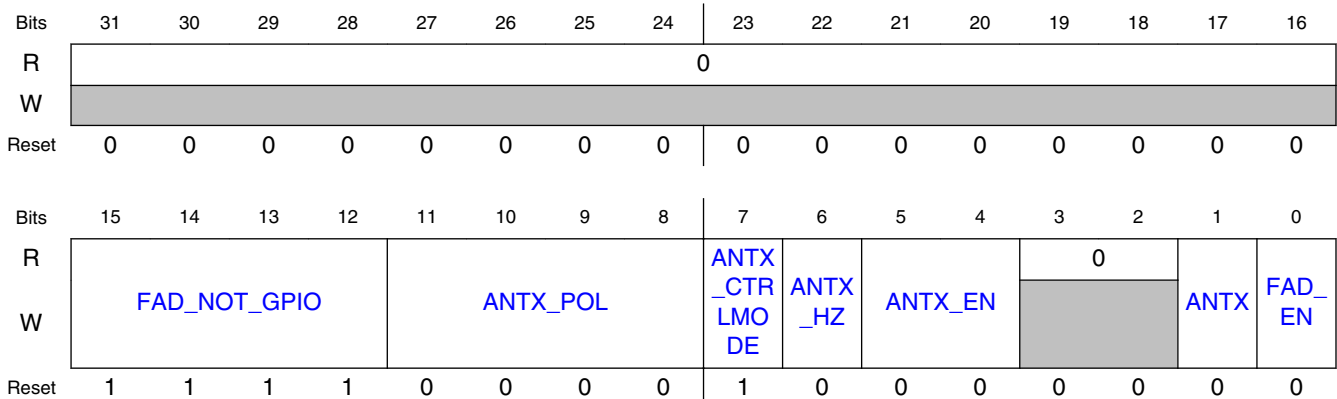

45.4.7.1.9.3 Fields

| Field | Function |
|-----------------------|--|
| 31-16 — | Reserved |
| 15-12 FAD_NOT_GPIO | <p>FAD versus GPIO Mode Selector</p> <p>xxx1: The ANT_A pad is controlled by the antenna-selection algorithm, modified by the register settings above {ANTX_CTRLMODE, ANTX_EN, ANTX_POL}</p> <p>xxx0: The ANT_A pad is controlled directly by the TSM output gpio0_trig_en</p> <p>xx1x: The ANT_B pad is controlled by the antenna-selection algorithm, modified by the register settings above {ANTX_CTRLMODE, ANTX_EN, ANTX_POL}</p> <p>xx0x: The ANT_B pad is controlled directly by the TSM output gpio1_trig_en</p> <p>x1xx: The TX_SWITCH pad is controlled by the antenna-selection algorithm, modified by the register settings above {ANTX_CTRLMODE, ANTX_EN, ANTX_POL}</p> <p>x0xx: The TX_SWITCH pad is controlled directly by the TSM output gpio2_trig_en</p> <p>1xxx: The RX_SWITCH pad is controlled by the antenna-selection algorithm, modified by the register settings above {ANTX_CTRLMODE, ANTX_EN, ANTX_POL}</p> <p>0xxx: The RX_SWITCH pad is controlled directly by the TSM output gpio3_trig_en</p> |
| 11-8 ANTX_POL | <p>FAD Antenna Controls Polarity</p> <p>Control the polarity of the FAD pins:</p> <p>ANTX_POL<0>=1 : invert the ANT_A output</p> <p>ANTX_POL<1>=1 : invert the ANT_B output</p> <p>ANTX_POL<2>=1 : invert the TX_SWITCH output</p> <p>ANTX_POL<3>=1 : invert the RX_SWITCH output</p> |
| 7 ANTX_CTRLMODE | <p>Antenna Diversity Control Mode</p> <p>When ANTX_CTRLMODE=1 (dual mode):</p> <p>ANT_A=NOT(ANTX) AND (GPIO3_TRIG_EN OR GPIO2_TRIG_EN)</p> <p>ANT_B=ANTX AND (GPIO3_TRIG_EN OR GPIO2_TRIG_EN)</p> <p>TX_SWITCH=GPIO2_TRIG_EN</p> <p>RX_SWITCH=GPIO3_TRIG_EN</p> <p>When ANTX_CTRLMODE=0 (single mode):</p> <p>ANT_A=NOT(ANTX) AND (GPIO3_TRIG_EN OR GPIO2_TRIG_EN)</p> <p>ANT_B=ANTX AND (GPIO3_TRIG_EN OR GPIO2_TRIG_EN)</p> <p>TX_SWITCH=GPIO2_TRIG_EN</p> <p>RX_SWITCH=(GPIO3_TRIG_EN OR GPIO2_TRIG_EN)</p> <p>GPIO2_TRIG_EN and GPIO3_TRIG_EN are outputs of the Transceiver Sequence Manager (TSM). The TSM timing registers associated with GPIO2_TRIG_EN and GPIO3_TRIG_EN should be programmed with the desired TX_SWITCH and RX_SWITCH timing, before enabling Fast Antenna Diversity.</p> |
| 6 ANTX_HZ | <p>FAD PAD Tristate Control</p> <p>0b - ANT_A, ANT_B, RX_SWITCH and TX_SWITCH are actively driven outputs.</p> |

Table continues on the next page...

| Field | Function |
|----------------|---|
| | 1b - Antenna controls high impedance- Set ANT_A, ANT_B, RX_SWITCH and TX_SWITCH in high impedance. |
| 5-4 ANTX_EN | FAD Antenna Controls Enable For any of the 4 FAD-related outputs {ANT_A, ANT_B, TX_SWITCH, RX_SWITCH}, when the associated register control bit (FAD_NOT_GPIO[x]=1) puts that output in FAD mode, ANTX_EN[1:0] determines which pairs of FAD related outputs are enabled: 00b - all disabled (held low) 01b - only RX/TX_SWITCH enabled 10b - only ANT_A/B enabled 11b - all enabled |
| 3-2 — | Reserved |
| 1 ANTX | Antenna Selection State If FAD_EN=0, the ANTX bit is used to take manual (software) control of the antenna selection, overriding the FAD state machine; in this case, the readback value of ANTX is whatever was last written by the host. If FAD_EN=1, the FAD state machine controls antenna selection, and the readback value of ANTX reflects the machine-selected antenna. |
| 0 FAD_EN | Fast Antenna Diversity Enable 0b - Fast Antenna Diversity disabled 1b - Fast Antenna Diversity enabled for 802.15.4 |

45.4.7.1.10 LOW POWER PREAMBLE SEARCH CONTROL (LPPS_CTRL)

45.4.7.1.10.1 Address

| Register | Offset |
|-----------|-----------|
| LPPS_CTRL | 4005C2A8h |

45.4.7.1.10.2 Diagram

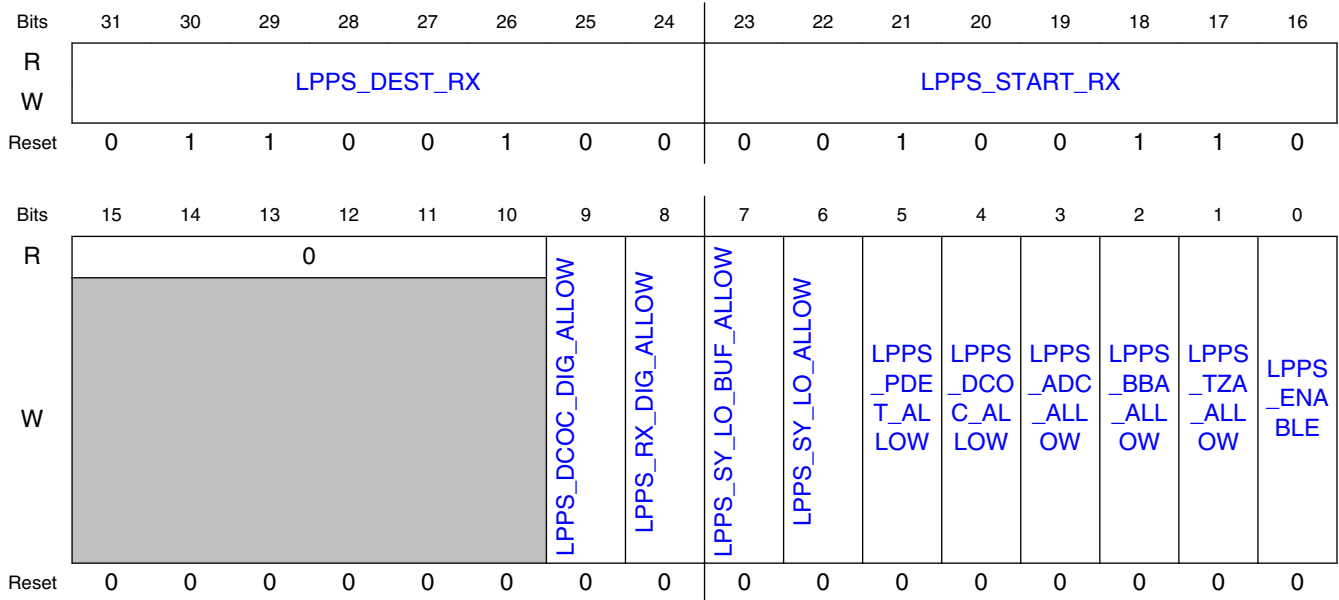

45.4.7.1.10.3 Fields

| Field | Function |
|--------------------------|--|
| 31-24 LPPS_DEST_RX | LPPS Fast TSM RX Warmup "Jump-to" Point During a LPPS Fast RX Warmup, this value represents the ending TSM count for the portion of the warmup that is to be skipped over. In an LPPS Fast RX Warmup, LPPS_START_RX[7:0] will never be reached and will instead be replaced by the contents of this register, thereby executing the jump. Example: LPPS_START_RX = 10 LPPS_DEST_RX = 15 The TSM will count as follows: ... 7,8,9,15,16,17 ... |
| 23-16 LPPS_START_RX | LPPS Fast TSM RX Warmup "Jump-from" Point During a LPPS Fast RX Warmup, this value represents the starting TSM count for the portion of the warmup that is to be skipped over. In an LPPS Fast RX Warmup, this count will never be reached; its place in the TSM warmup will be replaced by the contents of LPPS_DEST_RX[7:0], thereby executing the jump. |
| 15-10 — | Reserved |
| 9 LPPS_DCOC_DIG_ALLOW | LPPS_DCOC_DIG_ALLOW When set to one, allows the following TSM outputs to be controlled by the LPPS state machine: dcoc_en |
| 8 LPPS_RX_DIG_ALLOW | LPPS_RX_DIG_ALLOW When set to one, allows the following TSM outputs to be controlled by the LPPS state machine: rx_dig_en |
| 7 | LPPS_SY_LO_BUF_ALLOW |

Table continues on the next page...

| Field | Function |
|----------------------|--|
| LPPS_SY_LO_BUF_ALLOW | When set to one, allows the following TSM outputs to be controlled by the LPPS state machine: sy_lo_rx_buf_en |
| 6 | LPPS_SY_LO_ALLOW |
| LPPS_SY_LO_ALLOW | When set to one, allows the following TSM outputs to be controlled by the LPPS state machine: sy_lo_rx_en |
| 5 | LPPS_PDET_ALLOW |
| LPPS_PDET_ALLOW | When set to one, allows the following TSM outputs to be controlled by the LPPS state machine: rx_bba_pdet_en, rx_tza_pdet_en |
| 4 | LPPS_DCOC_ALLOW |
| LPPS_DCOC_ALLOW | When set to one, allows the following TSM outputs to be controlled by the LPPS state machine: rx_bba_dcoc_en, rx_tza_dcoc_en |
| 3 | LPPS_ADC_ALLOW |
| LPPS_ADC_ALLOW | When set to one, allows the following TSM outputs to be controlled by the LPPS state machine: rx_adc_en, rx_adc_i_en, rx_adc_q_en |
| 2 | LPPS_BBA_ALLOW |
| LPPS_BBA_ALLOW | When set to one, allows the following TSM outputs to be controlled by the LPPS state machine: rx_bba_i_en, rx_bba_q_en |
| 1 | LPPS_TZA_ALLOW |
| LPPS_TZA_ALLOW | When set to one, allows the following TSM outputs to be controlled by the LPPS state machine: rx_lna_en, rx_tza_i_en, rx_tza_q_en |
| 0 | LPPS_ENABLE |
| LPPS_ENABLE | Master enable for LPPS mode. Allows correlators to be duty-cycled during Preamble Search, and selected analog and digital blocks to be duty-cycled simultaneously. |

45.4.7.1.11 WIFI COEXISTENCE CONTROL (RF_NOT_ALLOWED_CTRL)

45.4.7.1.11.1 Address

| Register | Offset |
|---------------------|-----------|
| RF_NOT_ALLOWED_CTRL | 4005C2ACh |

45.4.7.1.11.2 Diagram

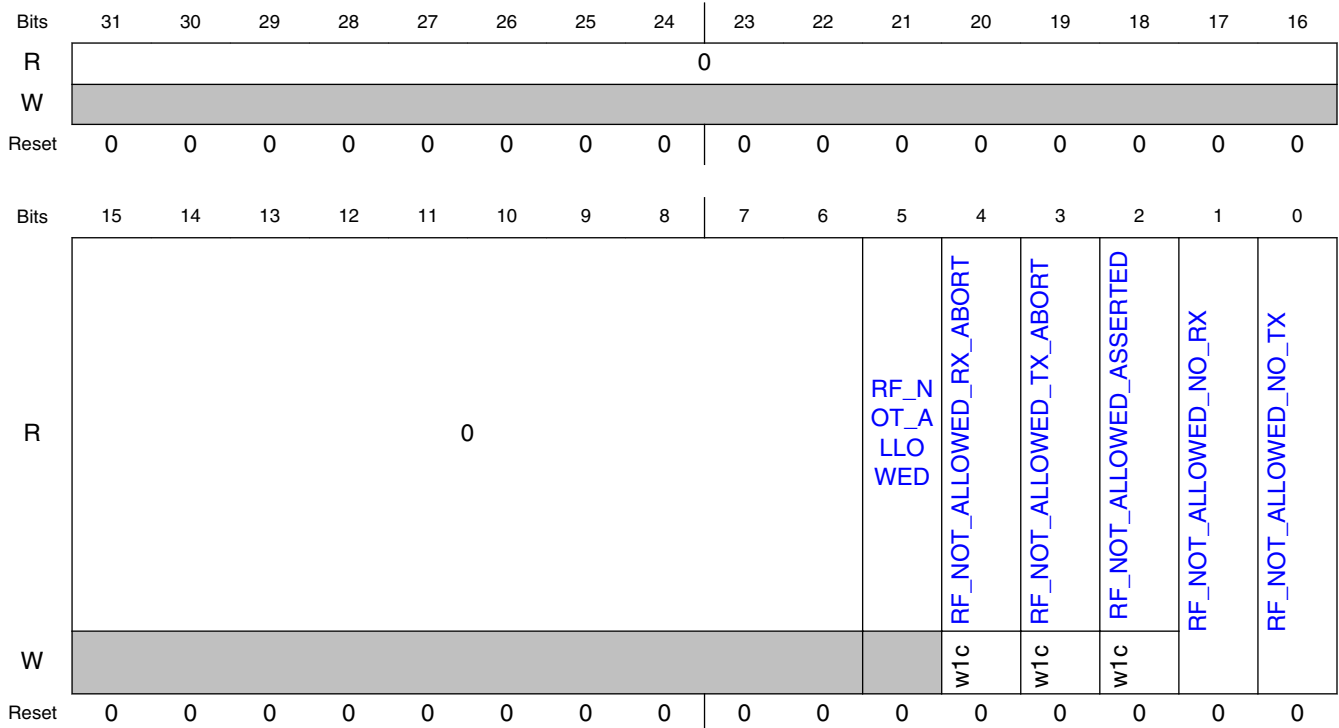

45.4.7.1.11.3 Fields

| Field | Function |
|------------------------------|--|
| 31-6 Reserved | Reserved |
| 5 RF_NOT_ALLOWED WED | RF_NOT_ALLOWED Reflects the instantaneous state of the RF_NOT_ALLOWED pin, synchronized into the RF OSC clock domain. |
| 4 RF_NOT_ALLOWED_RX_ABORT | RF_NOT_ALLOWED_RX_ABORT 0b - A RX abort due to assertion on RF_NOT_ALLOWED has not occurred 1b - A RX abort due to assertion on RF_NOT_ALLOWED has occurred since the last time this bit was cleared |
| 3 RF_NOT_ALLOWED_TX_ABORT | RF_NOT_ALLOWED_TX_ABORT 0b - A TX abort due to assertion on RF_NOT_ALLOWED has not occurred 1b - A TX abort due to assertion on RF_NOT_ALLOWED has occurred since the last time this bit was cleared |
| 2 RF_NOT_ALLOWED_ASSERTED | RF_NOT_ALLOWED_ASSERTED 0b - Assertion on RF_NOT_ALLOWED has not occurred 1b - Assertion on RF_NOT_ALLOWED has occurred since the last time this bit was cleared |
| 1 RF_NOT_ALLOWED_NO_RX | RF_NOT_ALLOWED_NO_RX 0b - Assertion on RF_NOT_ALLOWED has no effect on RX |

Table continues on the next page...

| Field | Function |
|-------------------------------|---|
| RF_NOT_ALLO WED_NO_RX | 1b - Assertion on RF_NOT_ALLOWED can abort RX |
| 0 RF_NOT_ALLO WED_NO_TX | RF_NOT_ALLOWED_NO_TX 0b - Assertion on RF_NOT_ALLOWED has no effect on TX 1b - Assertion on RF_NOT_ALLOWED can abort TX |

45.4.7.1.12 CRC/WHITENER CONTROL (CRCW_CFG)

45.4.7.1.12.1 Address

| Register | Offset |
|----------|-----------|
| CRCW_CFG | 4005C2B0h |

45.4.7.1.12.2 Diagram

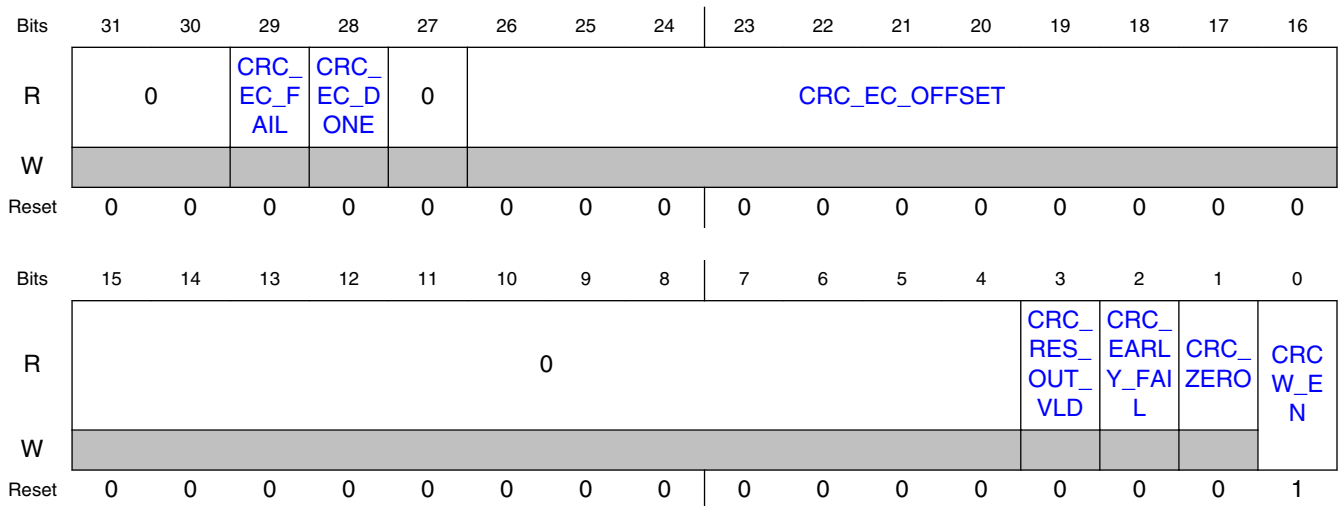

45.4.7.1.12.3 Fields

| Field | Function |
|-------------------|--|
| 31-30 — | Reserved |
| 29 CRC_EC_FAIL | CRC error correction fail This signal is cleared when <i>crc_init</i> is asserted. It is set after the completion of a CRC error correction calculation that does not find a valid data correction solution or if error correction was disabled and the CRC check found an error. |

Table continues on the next page...

FSK Modulator

| Field | Function |
|----------------------------|--|
| 28 CRC_EC_DON E | CRC error correction done This signal is cleared when <i>crc_init</i> is asserted. It is set after the error correction logic completes processing the syndrome. It is immediately set after a packet is received if no error was detected or if error correction is disabled. Otherwise, it can take up to N system clocks after the packet is received to assert, with N = (number of bits used in the CRC calculation, including the CRC value). |
| 27 — | Reserved |
| 26-16 CRC_EC_OFFS ET | CRC error correction offset This value provides the byte offset within the data packet to which the CRC error correction mask should be XOR-ed. This value is valid if the <i>crc_ec_done</i> signal is asserted and the <i>crc_ec_fail</i> signal is not asserted. The offset includes only the bytes used in the CRC calculation, including the CRC value. |
| 15-4 — | Reserved |
| 3 CRC_RES_OUT _VLD | CRC result output valid CRC result output valid. |
| 2 CRC_EARLY_F AIL | CRC error correction fail This signal is cleared when <i>crc_init</i> is asserted. It is set after the completion of a CRC error correction calculation that does not find a valid data correction solution or if error correction was disabled and the CRC check found an error. |
| 1 CRC_ZERO | CRC zero This signal is asserted at any time that the CRC shift register contains a value of zero |
| 0 CRCW_EN | CRC calculation enable Input data bits loaded with this signal asserted are used in the CRC calculation. |

45.4.7.1.13 CRC ERROR CORRECTION MASK (CRC_EC_MASK)

45.4.7.1.13.1 Address

| Register | Offset |
|-------------|-----------|
| CRC_EC_MASK | 4005C2B4h |

45.4.7.1.13.2 Diagram

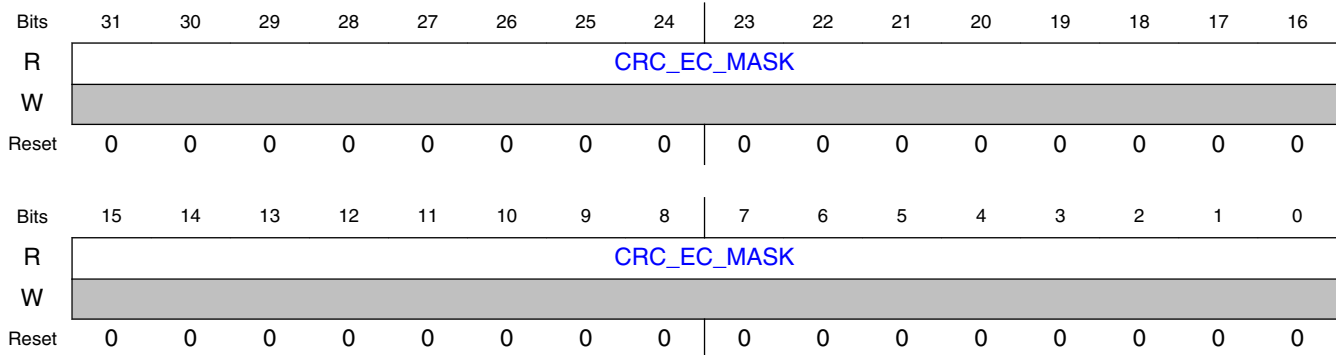

45.4.7.1.13.3 Fields

| Field | Function |
|-------------|---|
| 31-0 | CRC error correction mask |
| CRC_EC_MASK | This value provides a 32-bit XOR mask that must be applied to the input data packet to correct the burst errors detected by the error correction calculation. This value is valid if the <i>crc_ec_done</i> signal is asserted and the <i>crc_ec_fail</i> signal is not asserted. |

45.4.7.1.14 CRC RESULT (CRC_RES_OUT)

45.4.7.1.14.1 Address

| Register | Offset |
|-------------|-----------|
| CRC_RES_OUT | 4005C2B8h |

45.4.7.1.14.2 Diagram

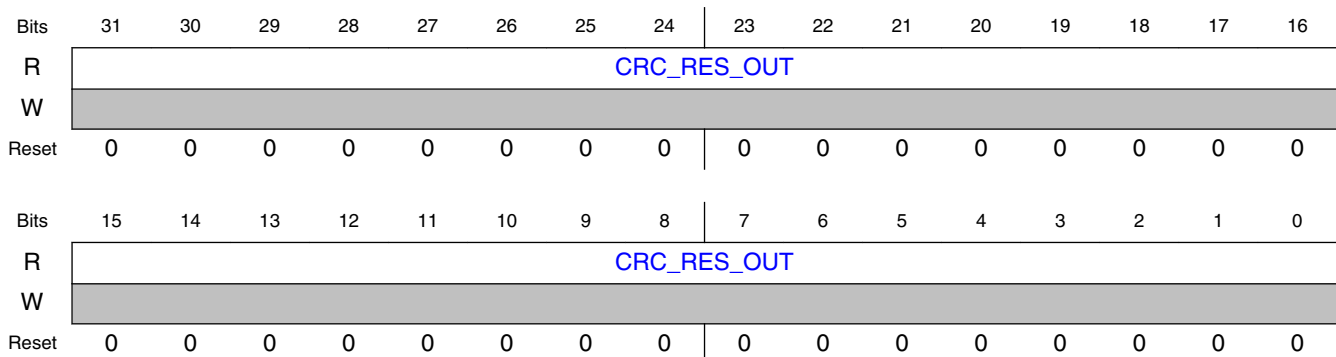

45.4.7.1.14.3 Fields

| Field | Function |
|-------------|--|
| 31-0 | CRC result output |
| CRC_RES_OUT | This bus provides the instantaneous value of the CRC shift register. |

45.4.7.2 XCVR_PHY Register Descriptions

45.4.7.2.1 XCVR_RX_PHY_ADDR Memory Map

Base address: 4005C400h

| Offset | Register | Width (In bits) | Access | Reset value |
|-----------|--|--------------------|--------|-------------|
| 4005C400h | PREAMBLE REFERENCE WAVEFORM 0 (PHY_PRE_REF0) | 32 | RW | FDDDEB39h |
| 4005C404h | PREAMBLE REFERENCE WAVEFORM 1 (PHY_PRE_REF1) | 32 | RW | BEFBFFFFh |
| 4005C408h | PREAMBLE REFERENCE WAVEFORM 2 (PHY_PRE_REF2) | 32 | RW | 0000CE75h |
| 4005C420h | PHY CONFIGURATION REGISTER 1 (PHY_CFG1) | 32 | RW | 1070CD16h |
| 4005C424h | PHY CONFIGURATION REGISTER 2 (PHY_CFG2) | 32 | RW | 01000A48h |
| 4005C428h | PHY EARLY/LATE CONFIGURATION REGISTER (PHY_EL_CFG) | 32 | RW | 00000000h |
| 4005C42Ch | PHY NETWORK ADDRESS FOR BSM (NTW_ADR_BSM) | 32 | RW | 00000000h |
| 4005C430h | PHY STATUS REGISTER (PHY_STATUS) | 32 | RO | 00000000h |

45.4.7.2.2 PREAMBLE REFERENCE WAVEFORM 0 (PHY_PRE_REF0)

45.4.7.2.2.1 Offset

| Register | Offset |
|--------------|-----------|
| PHY_PRE_REF0 | 4005C400h |

45.4.7.2.2 Diagram

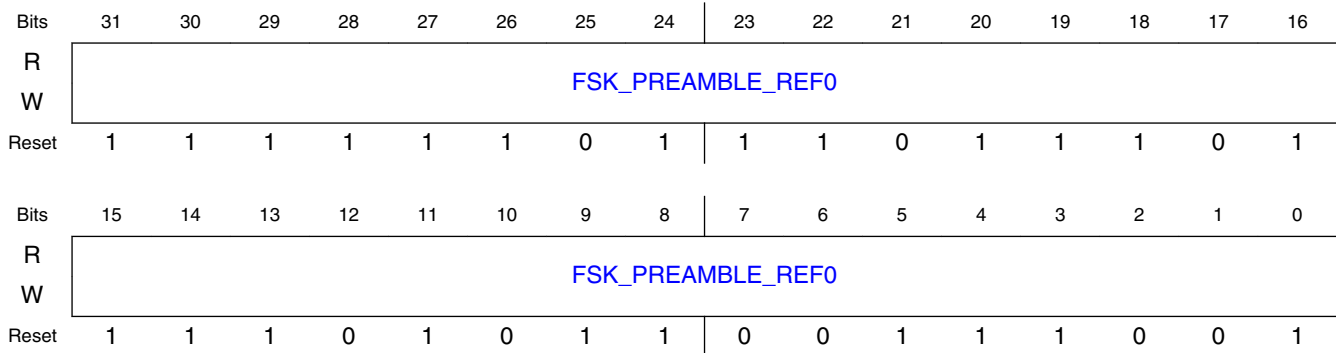

45.4.7.2.3 Fields

| Field | Function | | | | | | | | | | | | | | | | | | | | | | | | | | | | |
|---------------------------|---|-------------------|-------------------|-------------------|-------------------|--------------------------|------------|------------|------------|---------------------|------------|------------|------------|--------------------|------------|------------|------------|--------------------|------------|------------|------------|--------------------|------------|------------|------------|-----|------------|------------|------------|
| 31-0 FSK_PREAMBLE_REF0 | <p>Base preamble reference waveform containing sixteen 5-bit phase values represented in 2's complement notation using 1 sign bit and 4 fractional bits.</p> <p>Thus, the range of representable values is $[-1, 1-1/16]$ and they correspond to phases in the range $[-\pi, \pi(1-1/16)]$.</p> <p>Preamble reference waveform is an 80-bit vector; FSK_PREAMBLE_REF0 constitutes the lowest (least significant) component. The entire reference waveform is assembled by concatenating the following register values:</p> <p>Reference Waveform = {FSK_PREAMBLE_REF2[15:0], FSK_PREAMBLE_REF1[31:0], FSK_PREAMBLE_REF0[31:0]}</p> <p>The preamble reference waveforms for various PHY configurations are as follows:</p> <table border="1"> <thead> <tr> <th>Generic FSK MODE</th> <th>FSK_PREAMBLE_REF0</th> <th>FSK_PREAMBLE_REF1</th> <th>FSK_PREAMBLE_REF2</th> </tr> </thead> <tbody> <tr> <td>BLE (GFSK BT=0.5, h=0.5)</td> <td>0x79CDEB39</td> <td>0xCE77DEF7</td> <td>0x0000CEB7</td> </tr> <tr> <td>GFSK BT=0.5, h=0.32</td> <td>0xBBDE739B</td> <td>0xDEFBDEF7</td> <td>0x0000E739</td> </tr> <tr> <td>GFSK BT=0.5, h=0.7</td> <td>0x37ACE2F7</td> <td>0xADF3BDEF</td> <td>0x0000BE33</td> </tr> <tr> <td>GFSK BT=0.3, h=0.5</td> <td>0x7BCDEB39</td> <td>0xCEF7DEF7</td> <td>0x0000CEB7</td> </tr> <tr> <td>GFSK BT=0.7, h=0.5</td> <td>0x79CDEB39</td> <td>0xCE77DEF7</td> <td>0x0000CEB7</td> </tr> <tr> <td>MSK</td> <td>0x79CDEB38</td> <td>0xCE77DFF7</td> <td>0x0000CEB7</td> </tr> </tbody> </table> | Generic FSK MODE | FSK_PREAMBLE_REF0 | FSK_PREAMBLE_REF1 | FSK_PREAMBLE_REF2 | BLE (GFSK BT=0.5, h=0.5) | 0x79CDEB39 | 0xCE77DEF7 | 0x0000CEB7 | GFSK BT=0.5, h=0.32 | 0xBBDE739B | 0xDEFBDEF7 | 0x0000E739 | GFSK BT=0.5, h=0.7 | 0x37ACE2F7 | 0xADF3BDEF | 0x0000BE33 | GFSK BT=0.3, h=0.5 | 0x7BCDEB39 | 0xCEF7DEF7 | 0x0000CEB7 | GFSK BT=0.7, h=0.5 | 0x79CDEB39 | 0xCE77DEF7 | 0x0000CEB7 | MSK | 0x79CDEB38 | 0xCE77DFF7 | 0x0000CEB7 |
| Generic FSK MODE | FSK_PREAMBLE_REF0 | FSK_PREAMBLE_REF1 | FSK_PREAMBLE_REF2 | | | | | | | | | | | | | | | | | | | | | | | | | | |
| BLE (GFSK BT=0.5, h=0.5) | 0x79CDEB39 | 0xCE77DEF7 | 0x0000CEB7 | | | | | | | | | | | | | | | | | | | | | | | | | | |
| GFSK BT=0.5, h=0.32 | 0xBBDE739B | 0xDEFBDEF7 | 0x0000E739 | | | | | | | | | | | | | | | | | | | | | | | | | | |
| GFSK BT=0.5, h=0.7 | 0x37ACE2F7 | 0xADF3BDEF | 0x0000BE33 | | | | | | | | | | | | | | | | | | | | | | | | | | |
| GFSK BT=0.3, h=0.5 | 0x7BCDEB39 | 0xCEF7DEF7 | 0x0000CEB7 | | | | | | | | | | | | | | | | | | | | | | | | | | |
| GFSK BT=0.7, h=0.5 | 0x79CDEB39 | 0xCE77DEF7 | 0x0000CEB7 | | | | | | | | | | | | | | | | | | | | | | | | | | |
| MSK | 0x79CDEB38 | 0xCE77DFF7 | 0x0000CEB7 | | | | | | | | | | | | | | | | | | | | | | | | | | |

45.4.7.2.3 PREAMBLE REFERENCE WAVEFORM 1 (PHY_PRE_REF1)

45.4.7.2.3.1 Offset

| Register | Offset |
|--------------|-----------|
| PHY_PRE_REF1 | 4005C404h |

45.4.7.2.3.2 Diagram

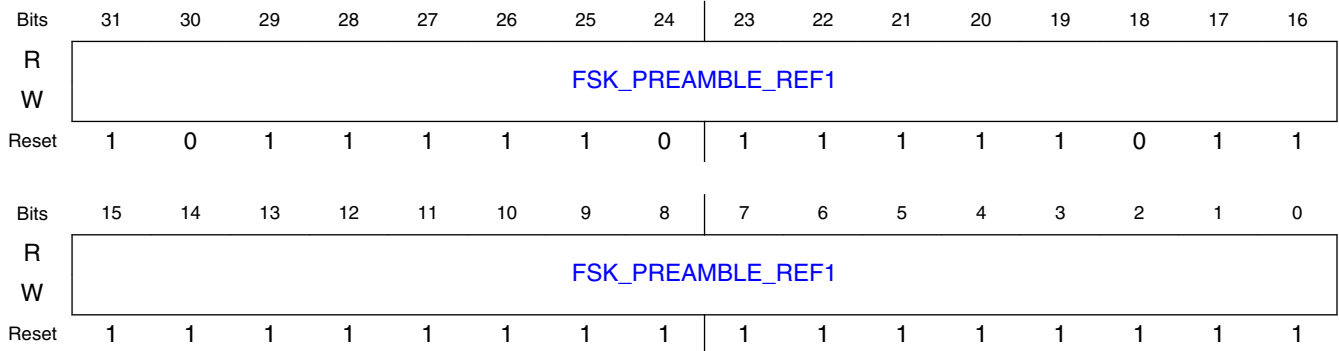

45.4.7.2.3.3 Fields

| Field | Function |
|-------------------------------|-----------------------------|
| 31-0 FSK_PREAMBL E_REF1 | Refer to FSK_PREAMBLE_REF0. |

45.4.7.2.4 PREAMBLE REFERENCE WAVEFORM 2 (PHY_PRE_REF2)

45.4.7.2.4.1 Offset

| Register | Offset |
|--------------|-----------|
| PHY_PRE_REF2 | 4005C408h |

45.4.7.2.4.2 Diagram

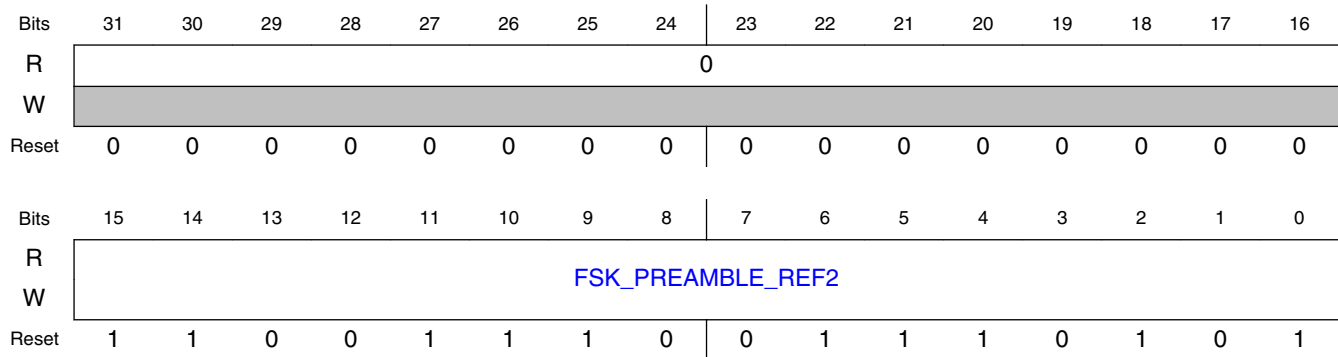

45.4.7.2.4.3 Fields

| Field | Function |
|-------------------------------|-----------------------------|
| 31-16 — | Reserved |
| 15-0 FSK_PREAMBL E_REF2 | Refer to FSK_PREAMBLE_REF0. |

45.4.7.2.5 PHY CONFIGURATION REGISTER 1 (PHY_CFG1)

45.4.7.2.5.1 Offset

| Register | Offset |
|----------|-----------|
| PHY_CFG1 | 4005C420h |

45.4.7.2.5.2 Diagram

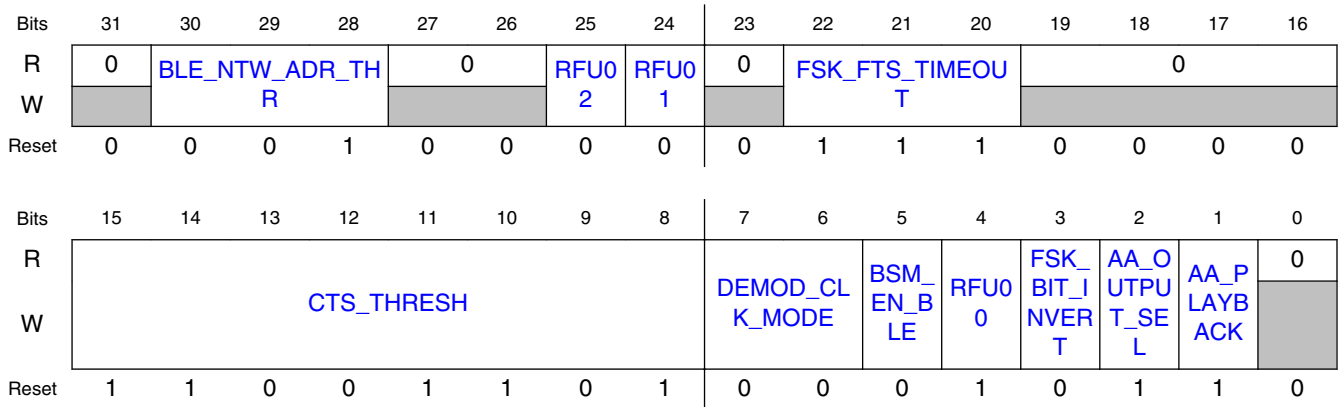

45.4.7.2.5.3 Fields

| Field | Function |
|--------------------------|---|
| 31 — | Reserved |
| 30-28 BLE_NTW_ADR_THR | BLE Network Address Match Bit Error Threshold Number of Tolerated bit errors for Access Address correlation in BLE mode |
| 27-26 — | Reserved |
| 25 RFU02 | Reserved for future use. |
| 24 RFU01 | Reserved for future use. |
| 23 — | Reserved |
| 22-20 FSK_FTS_TIMEOUT | FSK FTS Timeout Number of symbols FTS is allowed to proceed beyond the expected end of the longest AA in FSK 000b - 4 symbols 001b - 5 symbols 010b - 6 symbols 011b - 7 symbols 100b - 8 symbols 101b - 9 symbols 110b - 10 symbols 111b - 11 symbols |
| 19-16 — | Reserved |
| 15-8 CTS_THRESH | CTS Correlation Threshold |

Table continues on the next page...

| Field | Function | | | | | | | | | | | | | | | | | | | | | | | | | | | | | | | | |
|---------------------------|---|-------------------|-------------------------------|------------------|-------------------------------|--------------------------|------|--------|-----------|---------------------------|------|--------|-----------|--------------------|-----|--------|-----------|--------------------|------|--------|-----------|-----|-----|--------|-----------|--------------------|-----|--------|-----------|--------------------|------|--------|-----------|
| | <p>Coarse Timing Search (CTS) correlation threshold is an unsigned 8-bit fixed-point number that represents a range of CTS threshold representable values in $[0, \dots, 1-1/2^8] = \{0000\ 0000, \dots, 1111\ 1111\}$. CTS Threshold is a function of the PHY modulation scheme, data rate, and the receiver chain filtering characteristics and is chosen to maximize the performance.</p> <p>The table below shows the threshold values for an assortment of FSK schemes. They are determined from Simulink model simulations. For more details, please refer to the Multi-PHY chapter in the 2.4GHz Radio 2 ADD.</p> <table border="1"> <thead> <tr> <th>Modulation Scheme</th> <th>Data Rate (kbps)</th> <th>CTS_THRESH value</th> <th>CTS_THRESH bit representation</th> </tr> </thead> <tbody> <tr> <td>BLE (GFSK BT=0.5, h=0.5)</td> <td>1000</td> <td>0.7500</td> <td>1100 0000</td> </tr> <tr> <td>ANT (GFSK BT=0.5, h=0.32)</td> <td>1000</td> <td>0.8008</td> <td>1100 1101</td> </tr> <tr> <td>GFSK BT=0.5, h=0.7</td> <td>500</td> <td>0.7500</td> <td>1100 0000</td> </tr> <tr> <td>GFSK BT=0.3, h=0.5</td> <td>1000</td> <td>0.8516</td> <td>1101 1010</td> </tr> <tr> <td>MSK</td> <td>500</td> <td>0.8125</td> <td>1101 0000</td> </tr> <tr> <td>GFSK BT=0.5, h=0.5</td> <td>250</td> <td>0.8750</td> <td>1110 0000</td> </tr> <tr> <td>GFSK BT=0.7, h=0.5</td> <td>1000</td> <td>0.8515</td> <td>1101 1010</td> </tr> </tbody> </table> | Modulation Scheme | Data Rate (kbps) | CTS_THRESH value | CTS_THRESH bit representation | BLE (GFSK BT=0.5, h=0.5) | 1000 | 0.7500 | 1100 0000 | ANT (GFSK BT=0.5, h=0.32) | 1000 | 0.8008 | 1100 1101 | GFSK BT=0.5, h=0.7 | 500 | 0.7500 | 1100 0000 | GFSK BT=0.3, h=0.5 | 1000 | 0.8516 | 1101 1010 | MSK | 500 | 0.8125 | 1101 0000 | GFSK BT=0.5, h=0.5 | 250 | 0.8750 | 1110 0000 | GFSK BT=0.7, h=0.5 | 1000 | 0.8515 | 1101 1010 |
| Modulation Scheme | Data Rate (kbps) | CTS_THRESH value | CTS_THRESH bit representation | | | | | | | | | | | | | | | | | | | | | | | | | | | | | | |
| BLE (GFSK BT=0.5, h=0.5) | 1000 | 0.7500 | 1100 0000 | | | | | | | | | | | | | | | | | | | | | | | | | | | | | | |
| ANT (GFSK BT=0.5, h=0.32) | 1000 | 0.8008 | 1100 1101 | | | | | | | | | | | | | | | | | | | | | | | | | | | | | | |
| GFSK BT=0.5, h=0.7 | 500 | 0.7500 | 1100 0000 | | | | | | | | | | | | | | | | | | | | | | | | | | | | | | |
| GFSK BT=0.3, h=0.5 | 1000 | 0.8516 | 1101 1010 | | | | | | | | | | | | | | | | | | | | | | | | | | | | | | |
| MSK | 500 | 0.8125 | 1101 0000 | | | | | | | | | | | | | | | | | | | | | | | | | | | | | | |
| GFSK BT=0.5, h=0.5 | 250 | 0.8750 | 1110 0000 | | | | | | | | | | | | | | | | | | | | | | | | | | | | | | |
| GFSK BT=0.7, h=0.5 | 1000 | 0.8515 | 1101 1010 | | | | | | | | | | | | | | | | | | | | | | | | | | | | | | |
| 7-6 DEMOD_CLK_MODE | Demodulator Clock Mode 00b - Normal 01b - Demodulate all samples 10b - Reserved 11b - Reserved | | | | | | | | | | | | | | | | | | | | | | | | | | | | | | | | |
| 5 BSM_EN_BLE | BLE Bit Streaming Mode Enable bit Enable the serialized, received BLE packet bitstream to appear on the BSM pins of the SoC. (See the XCVR BSM Block Guide) 0b - BSM for BLE disabled 1b - BSM for BLE enabled | | | | | | | | | | | | | | | | | | | | | | | | | | | | | | | | |
| 4 RFU00 | Reserved for future use. | | | | | | | | | | | | | | | | | | | | | | | | | | | | | | | | |
| 3 FSK_BIT_INVERT | FSK Bit Invert Inverts FSK mapping of symbols to bits when asserted. | | | | | | | | | | | | | | | | | | | | | | | | | | | | | | | | |
| | <table border="1"> <thead> <tr> <th>FSK_BIT_INVERT</th> <th>$E_s \geq 0$</th> <th>$E_s < 0$</th> </tr> </thead> <tbody> <tr> <td>0</td> <td>1</td> <td>0</td> </tr> <tr> <td>1</td> <td>0</td> <td>1</td> </tr> </tbody> </table> <p>In the table above, E_s is the soft bit output from the symbol demodulator.</p> | FSK_BIT_INVERT | $E_s \geq 0$ | $E_s < 0$ | 0 | 1 | 0 | 1 | 0 | 1 | | | | | | | | | | | | | | | | | | | | | | | |
| FSK_BIT_INVERT | $E_s \geq 0$ | $E_s < 0$ | | | | | | | | | | | | | | | | | | | | | | | | | | | | | | | |
| 0 | 1 | 0 | | | | | | | | | | | | | | | | | | | | | | | | | | | | | | | |
| 1 | 0 | 1 | | | | | | | | | | | | | | | | | | | | | | | | | | | | | | | |
| 2 AA_OUTPUT_SEL | Access Address Output Select Selects whether the demodulated AA bit sequence or the matched AA pattern is output. 0b - demodulated 1b - matched | | | | | | | | | | | | | | | | | | | | | | | | | | | | | | | | |
| 1 | Access Address Playback | | | | | | | | | | | | | | | | | | | | | | | | | | | | | | | | |

Table continues on the next page...

FSK Modulator

| Field | Function | | | | | | | | | | | | |
|-------------|--|---|---------------|-------------|---|---|---|---|---|---|---|---|---|
| AA_PLAYBACK | <p>Enable/disable output of Access Address bit sequence via <i>data_out</i> port depending on <i>aa_output_sel</i> according to the following table:</p> <table border="1"> <thead> <tr> <th>AA_PLAYBACK</th> <th>AA_OUTPUT_SEL</th> <th>ACTIONUNITS</th> </tr> </thead> <tbody> <tr> <td>0</td> <td>X</td> <td>Only PDU bits output via <i>data_out</i> port. No AA bits</td> </tr> <tr> <td>1</td> <td>0</td> <td>Demodulated AA bits followed by PDU bits are output via <i>data_out</i> port.</td> </tr> <tr> <td>1</td> <td>1</td> <td>Matched AA bits followed by PDU bits are output via <i>data_out</i> port.</td> </tr> </tbody> </table> <p>Note: This bit must be set to 1 for Generic FSK, and must be set to 0 for BLE.</p> | AA_PLAYBACK | AA_OUTPUT_SEL | ACTIONUNITS | 0 | X | Only PDU bits output via <i>data_out</i> port. No AA bits | 1 | 0 | Demodulated AA bits followed by PDU bits are output via <i>data_out</i> port. | 1 | 1 | Matched AA bits followed by PDU bits are output via <i>data_out</i> port. |
| AA_PLAYBACK | AA_OUTPUT_SEL | ACTIONUNITS | | | | | | | | | | | |
| 0 | X | Only PDU bits output via <i>data_out</i> port. No AA bits | | | | | | | | | | | |
| 1 | 0 | Demodulated AA bits followed by PDU bits are output via <i>data_out</i> port. | | | | | | | | | | | |
| 1 | 1 | Matched AA bits followed by PDU bits are output via <i>data_out</i> port. | | | | | | | | | | | |
| 0 | Reserved | | | | | | | | | | | | |
| — | | | | | | | | | | | | | |

45.4.7.2.6 PHY CONFIGURATION REGISTER 2 (PHY_CFG2)

45.4.7.2.6.1 Offset

| Register | Offset |
|----------|-----------|
| PHY_CFG2 | 4005C424h |

45.4.7.2.6.2 Diagram

| | | | | | | | | | | | | | | | | | |
|-------|------|----|----|----|---------------|----|------|------|------|------|------|------|-----------------|------|------|------|------|
| Bits | 31 | 30 | 29 | 28 | 27 | 26 | 25 | 24 | 23 | 22 | 21 | 20 | 19 | 18 | 17 | 16 | |
| R | PHY_ | 0 | | | | | RFU1 | RFU1 | RFU1 | RFU1 | RFU1 | RFU1 | RFU1 | RFU1 | RFU0 | RFU0 | RFU0 |
| W | CLK_ | | | | | | 6 | 5 | 4 | 3 | 2 | 1 | 0 | 9 | 8 | 7 | |
| Reset | 0 | 0 | 0 | 0 | 0 | 0 | 0 | 1 | 0 | 0 | 0 | 0 | 0 | 0 | 0 | 0 | |
| Bits | 15 | 14 | 13 | 12 | 11 | 10 | 9 | 8 | 7 | 6 | 5 | 4 | 3 | 2 | 1 | 0 | |
| R | 0 | | | | X2_DEMOD_GAIN | | | | RFU0 | RFU0 | RFU0 | RFU0 | PHY_FIFO_PRECHG | | | | |
| W | | | | | | | | | 6 | 5 | 4 | 3 | | | | | |
| Reset | 0 | 0 | 0 | 0 | 1 | 0 | 1 | 0 | 0 | 1 | 0 | 0 | 1 | 0 | 0 | 0 | |

45.4.7.2.6.3 Fields

| Field | Function | | | | | | | | |
|---------------------------|--|---------------------|----------------------------------|---------------------|----------------------------------|--------------------------|------|--------|------|
| 31 PHY_CLK_ON | Force PHY Clock On (testmode) 0b - PHY clock is enabled by TSM output: rx_phy_en 1b - PHY clock is forced on at all times | | | | | | | | |
| 30-26 — | Reserved | | | | | | | | |
| 25 RFU16 | Reserved for future use. | | | | | | | | |
| 24 RFU15 | Reserved for future use. | | | | | | | | |
| 23 RFU14 | Reserved for future use. | | | | | | | | |
| 22 RFU13 | Reserved for future use. | | | | | | | | |
| 21 RFU12 | Reserved for future use. | | | | | | | | |
| 20 RFU11 | Reserved for future use. | | | | | | | | |
| 19 RFU10 | Reserved for future use. | | | | | | | | |
| 18 RFU09 | Reserved for future use. | | | | | | | | |
| 17 RFU08 | Reserved for future use. | | | | | | | | |
| 16 RFU07 | Reserved for future use. | | | | | | | | |
| 15-12 — | Reserved | | | | | | | | |
| 11-8 X2_DEMOD_G AIN | <p>X2_DEMOD_GAIN</p> <p>Gain parameter used in the symbol demodulator. The unsigned fixed-point gain is 4 bits wide representing a range of representable gain values: $[0, \dots, 1-1/2^4] = \{0000, \dots, 1111\}$. X2_DEMOD_GAIN is a function of the PHY modulation, scheme, data rate, and the receiver chain filtering characteristics and is chosen to minimize the demodulation bit error rate.</p> <p>The table below shows the recommended values for an assortment of FSK schemes. They are determined from Simulink model simulations. For more details, please refer to the Multi-PHY chapter in the 2.4GHz Radio Gen 2 ADD.</p> <table border="1"> <thead> <tr> <th>Modulation Scheme</th> <th>Data Rate (kbps)</th> <th>X2_DEMOD_GAIN value</th> <th>X2_DEMOD_GAIN bit representation</th> </tr> </thead> <tbody> <tr> <td>BLE (GFSK BT=0.5, h=0.5)</td> <td>1000</td> <td>0.6250</td> <td>1010</td> </tr> </tbody> </table> | Modulation Scheme | Data Rate (kbps) | X2_DEMOD_GAIN value | X2_DEMOD_GAIN bit representation | BLE (GFSK BT=0.5, h=0.5) | 1000 | 0.6250 | 1010 |
| Modulation Scheme | Data Rate (kbps) | X2_DEMOD_GAIN value | X2_DEMOD_GAIN bit representation | | | | | | |
| BLE (GFSK BT=0.5, h=0.5) | 1000 | 0.6250 | 1010 | | | | | | |

Table continues on the next page...

FSK Modulator

| Field | Function | | | |
|----------------------------|---|------------------|---------------------|----------------------------------|
| | Modulation Scheme | Data Rate (kbps) | X2_DEMOD_GAIN value | X2_DEMOD_GAIN bit representation |
| | ANT (GFSK BT=0.5, h=0.32) | 1000 | 0.1875 | 0011 |
| | GFSK BT=0.5, h=0.7 | 500 | 0.6250 | 1010 |
| | GFSK BT=0.3, h=0.5 | 1000 | 0.6250 | 1010 |
| | MSK | 500 | 0.6250 | 1010 |
| | GFSK BT=0.5, h=0.5 | 250 | 0.2500 | 0100 |
| | GFSK BT=0.7, h=0.5 | 1000 | 0.5000 | 1000 |
| | | | | |
| 7 RFU06 | Reserved for future use. | | | |
| 6 RFU05 | Reserved for future use. | | | |
| 5 RFU04 | Reserved for future use. | | | |
| 4 RFU03 | Reserved for future use. | | | |
| 3-0 PHY_FIFO_PR ECHG | PHY FIFO Precharge Level Indicates the precharge depth of the output FIFO. | | | |

45.4.7.2.7 PHY EARLY/LATE CONFIGURATION REGISTER (PHY_EL_CFG)

45.4.7.2.7.1 Offset

| Register | Offset |
|------------|-----------|
| PHY_EL_CFG | 4005C428h |

45.4.7.2.7.2 Diagram

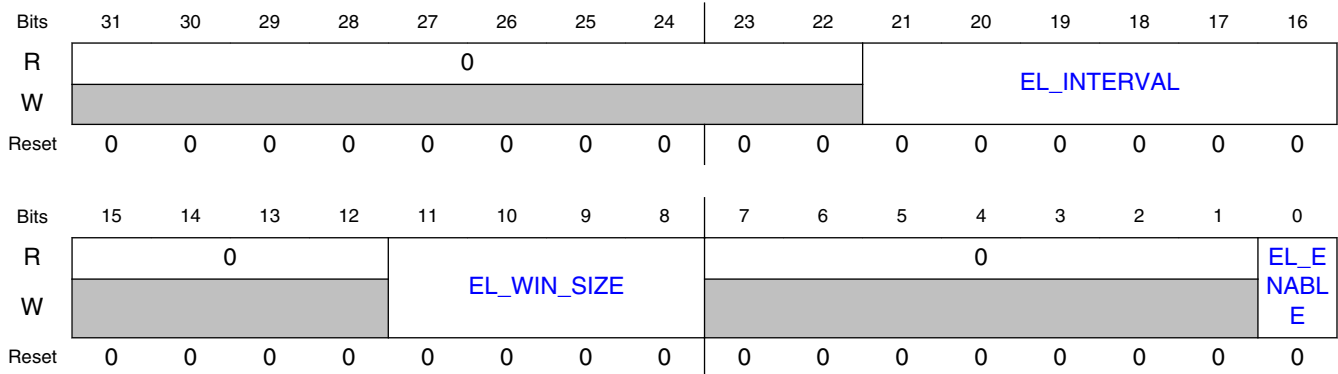

45.4.7.2.7.3 Fields

| Field | Function | | | | | | | | | |
|----------------------|---|-----------|-----|----------|------------------|---|---|------------------|----|---|
| 31-22 — | Reserved | | | | | | | | | |
| 21-16 EL_INTERVAL | EL_INTERVAL No. of FSK/IEEE 802.15.4 symbols between successive EL operation windows. Valid in both FSK and IEEE 802.15.4 modes. | | | | | | | | | |
| | <table border="1"> <thead> <tr> <th>Parameter</th> <th>BLE</th> <th>802.15.4</th> </tr> </thead> <tbody> <tr> <td>EL_WIN_SIZE[3:0]</td> <td>8</td> <td>3</td> </tr> <tr> <td>EL_INTERVAL[5:0]</td> <td>32</td> <td>7</td> </tr> </tbody> </table> | Parameter | BLE | 802.15.4 | EL_WIN_SIZE[3:0] | 8 | 3 | EL_INTERVAL[5:0] | 32 | 7 |
| Parameter | BLE | 802.15.4 | | | | | | | | |
| EL_WIN_SIZE[3:0] | 8 | 3 | | | | | | | | |
| EL_INTERVAL[5:0] | 32 | 7 | | | | | | | | |
| 15-12 — | Reserved | | | | | | | | | |
| 11-8 EL_WIN_SIZE | EL_WIN_SIZE Number of successive FSK/IEEE 802.15.4 symbols over which one EL operation occurs. Valid in both FSK and IEEE 802.15.4 modes. | | | | | | | | | |
| 7-1 — | Reserved | | | | | | | | | |
| 0 EL_ENABLE | EL_ENABLE Enable/disable EL mechanism during PDU/PSDU demodulation 0b - Disable Early/Late 1b - Enable Early/Late | | | | | | | | | |

45.4.7.2.8 PHY NETWORK ADDRESS FOR BSM (NTW_ADR_BSM)

45.4.7.2.8.1 Offset

| Register | Offset |
|-------------|-----------|
| NTW_ADR_BSM | 4005C42Ch |

45.4.7.2.8.2 Diagram

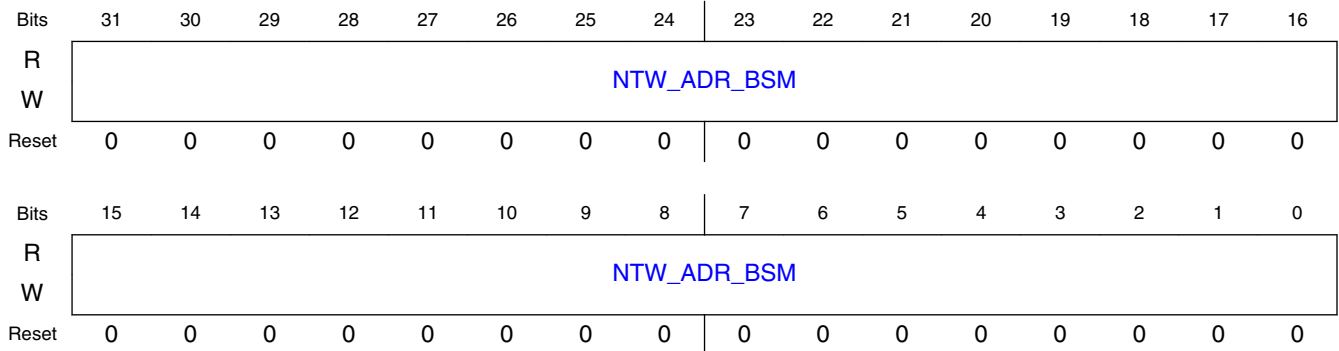

45.4.7.2.8.3 Fields

| Field | Function |
|-------------|--|
| 31-0 | NTW_ADR_BSM |
| NTW_ADR_BSM | PHY will search for this 32-bit Access Address when PHY_CFG1[BSM_EN_BLE]=1 |

45.4.7.2.9 PHY STATUS REGISTER (PHY_STATUS)

45.4.7.2.9.1 Offset

| Register | Offset |
|------------|-----------|
| PHY_STATUS | 4005C430h |

45.4.7.2.9.2 Diagram

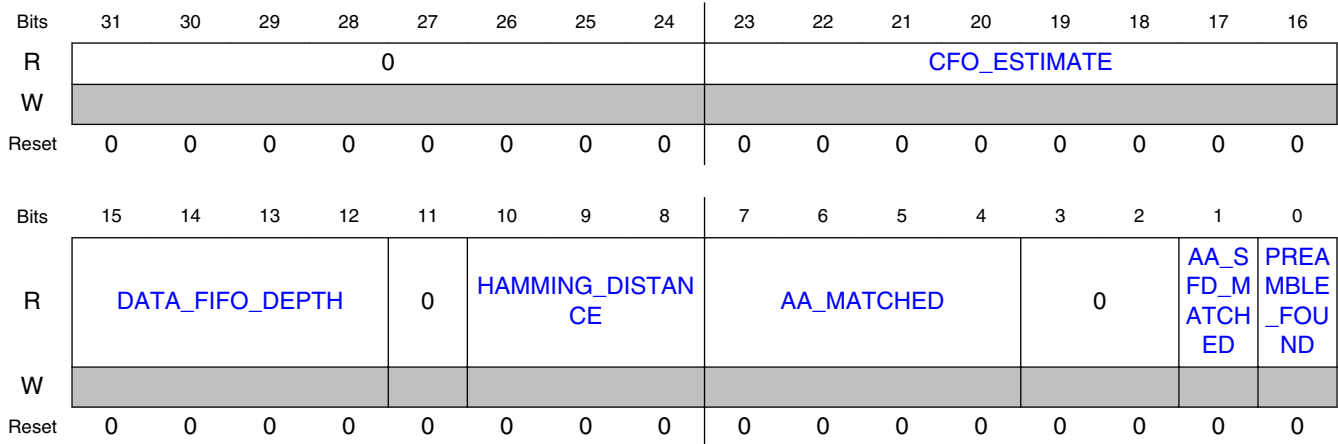

45.4.7.2.9.3 Fields

| Field | Function |
|--------------------------|---|
| 31-24 — | Reserved |
| 23-16 CFO_ESTIMATE | Carrier Frequency Offset Estimate Most recent estimate for Carrier Frequency Offset. The multiplication factor is 7812: i.e., CFO_ESTIMATE x 7812 = actually frequency offset in Hz (ideally). |
| 15-12 DATA_FIFO_DEPTH | DATA FIFO DEPTH Instantaneous depth of the PHY output FIFO. The difference between the FIFO write pointer and read pointer. |
| 11 — | Reserved |
| 10-8 HAMMING_DISTANCE | HAMMING DISTANCE Valid only in FSK mode. Indicates hamming distance between observed AA pattern and the candidate AA pattern that was found to be the best match. |
| 7-4 AA_MATCHED | Access Address Matched All bits reset in IDLE state. When any bit asserted, indicates which of the 4 Network Addresses has been matched. Valid only in FSK mode. 0000b - No Network Address has matched 0001b - Network Address 0 has matched 0010b - Network Address 1 has matched 0100b - Network Address 2 has matched 1000b - Network Address 3 has matched |
| 3-2 — | Reserved |
| 1 AA_SFD_MATCHED | Access Address or SFD Found Reset in IDLE state or when activate_search is de-asserted. Asserted when the AA/SFD is found. |

Table continues on the next page...

FSK Modulator

| Field | Function |
|-------------------------|---|
| 0 PREAMBLE_FO UND | Preamble Found Reset in IDLE state or when <i>activate_search</i> is de-asserted. Asserted when the preamble is found and the coarse symbol timing is determined. If the subsequent AA/SFD search fails and the receiver resumes CTS, this signal will be reset. |

45.4.7.3 XCVR_ZBDEMOM Register Descriptions

45.4.7.3.1 XCVR_ZBDEMOM_ADDR Memory Map

Base address: 4005C480h

| Offset | Register | Width (In bits) | Access | Reset value |
|-----------|--|--------------------|--------|------------------|
| 4005C480h | 802.15.4 DEMOD CORRELLATOR CONTROL (CORR_CTRL) | 32 | RW | See description. |
| 4005C484h | 802.15.4 DEMOD PN TYPE (PN_TYPE) | 32 | RW | 0000001h |
| 4005C488h | 802.15.4 DEMOD PN CODE (PN_CODE) | 32 | RW | 744AC39Bh |
| 4005C48Ch | 802.15.4 DEMOD SYMBOL SYNC CONTROL (SYNC_CTRL) | 32 | RW | 00000008h |
| 4005C490h | 802.15.4 CCA/LQI SOURCE (CCA_LQI_SRC) | 32 | RW | 00000004h |
| 4005C494h | FAD CORRELATOR THRESHOLD (FAD_THR) | 32 | RW | 00000082h |
| 4005C498h | 802.15.4 AFC STATUS (ZBDEM_AFC) | 32 | RW | See description. |

45.4.7.3.2 802.15.4 DEMOD CORRELLATOR CONTROL (CORR_CTRL)

45.4.7.3.2.1 Address

| Register | Offset |
|-----------|-----------|
| CORR_CTRL | 4005C480h |

45.4.7.3.2 Diagram

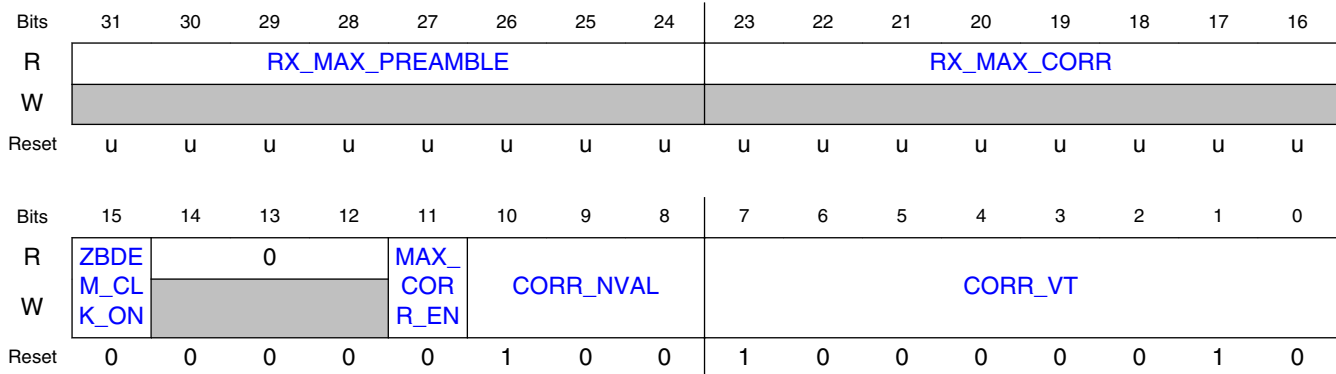

45.4.7.3.3 Fields

| Field | Function |
|--------------------------|--|
| 31-24 RX_MAX_PREAMBLE | RX_MAX_PREAMBLE Max correlator during preamble-- max correlator value found during the preamble. |
| 23-16 RX_MAX_CORR | RX_MAX_CORR Max correlator after preamble-- max correlator value found in packet after the preamble (refreshed every symbol rate if MAX_CORR_EN=1). |
| 15 ZBDEM_CLK_ON | Force 802.15.4 Demodulator Clock On 0b - Normal Operation 1b - Force 802.15.4 Demodulator Clock On (debug purposes only) |
| 14-12 — | Reserved |
| 11 MAX_CORR_EN | MAX_CORR_EN Max correlator after preamble enable-- Enable the refresh of the max corr register |
| 10-8 CORR_NVAL | CORR_NVAL Number of consecutively detected zero-symbols required to declare a preamble detected |
| 7-0 CORR_VT | CORR_VT Correlator threshold, defines the sensitivity of demod during the preamble search state |

45.4.7.3.3 802.15.4 DEMOD PN TYPE (PN_TYPE)

45.4.7.3.3.1 Address

| Register | Offset |
|----------|-----------|
| PN_TYPE | 4005C484h |

45.4.7.3.3.2 Diagram

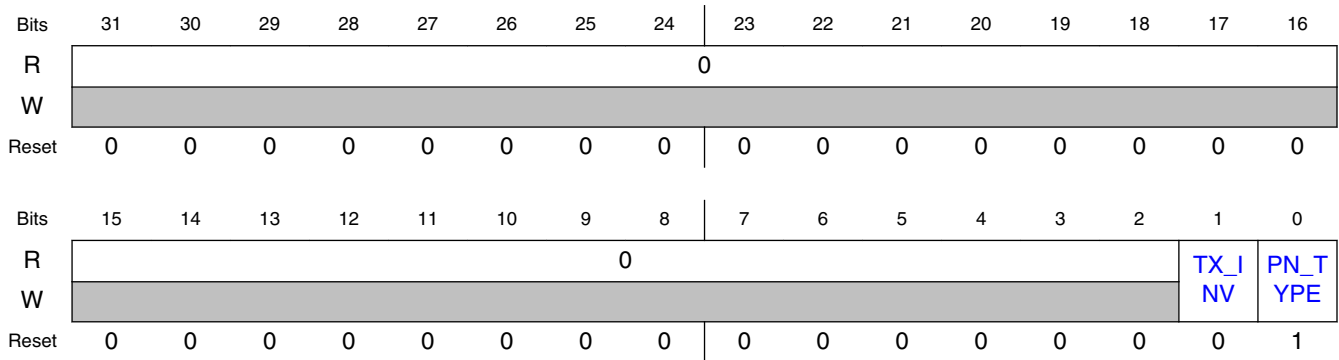

45.4.7.3.3.3 Fields

| Field | Function |
|------------------|---|
| 31-2 Reserved | Reserved |
| 1 TX_INV | TX_INV test mode to invert the transmission |
| 0 PN_TYPE | PN_TYPE PN Type - Pseudo Noise Chip Code Type (802.15.4=1) |

45.4.7.3.4 802.15.4 DEMOD PN CODE (PN_CODE)

45.4.7.3.4.1 Address

| Register | Offset |
|----------|-----------|
| PN_CODE | 4005C488h |

45.4.7.3.4.2 Function

Pseudo Noise Chip Code Seed Value

45.4.7.3.4.3 Diagram

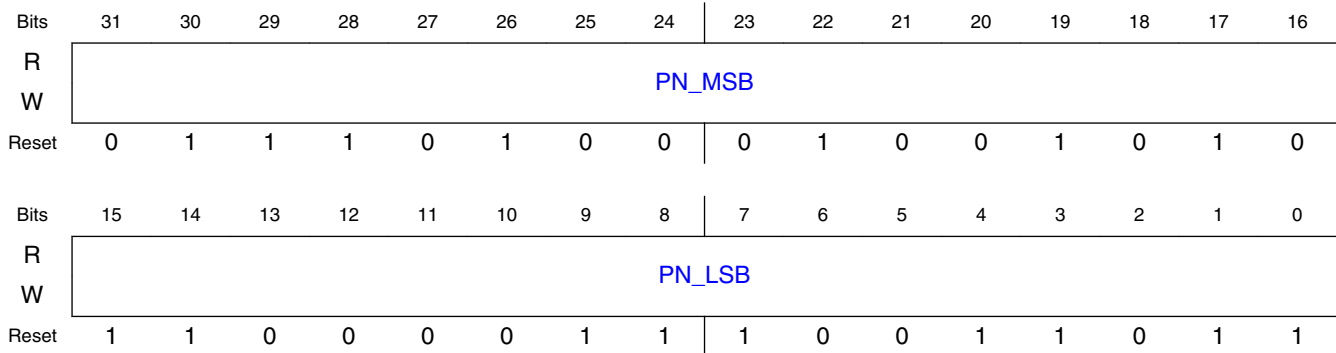

45.4.7.3.4.4 Fields

| Field | Function |
|-----------------|---------------------------|
| 31-16 PN_MSB | PN_MSB PN_CODE MS half |
| 15-0 PN_LSB | PN_LSB PN_CODE LS half |

45.4.7.3.5 802.15.4 DEMOD SYMBOL SYNC CONTROL (SYNC_CTRL)

45.4.7.3.5.1 Address

| Register | Offset |
|-----------|-----------|
| SYNC_CTRL | 4005C48Ch |

45.4.7.3.5.2 Diagram

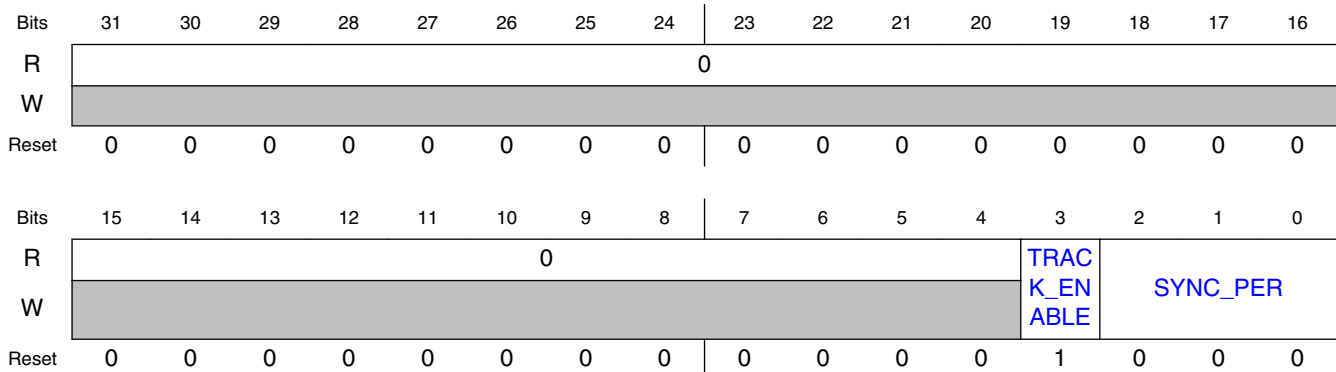

45.4.7.3.5.3 Fields

| Field | Function |
|-------------------|---|
| 31-4 Reserved | Reserved |
| 3 TRACK_ENABLE | TRACK_ENABLE 0b - symbol timing synchronization tracking disabled in Rx frontend 1b - symbol timing synchronization tracking enabled in Rx frontend (default) |
| 2-0 SYNC_PER | Symbol Sync Tracking Period determines update rate for symbol timing, per equation. An early/late measurement is made every 2^SYNC_PER[2:0] symbols. Valid range of SYNC_PER[2:0] is 0 to 4. |

45.4.7.3.6 802.15.4 CCA/LQI SOURCE (CCA_LQI_SRC)

45.4.7.3.6.1 Address

| Register | Offset |
|-------------|-----------|
| CCA_LQI_SRC | 4005C490h |

45.4.7.3.6.2 Function

Selects the Source of CCA and LQI Information Provided to the 802.15.4 Link Layer

45.4.7.3.6.3 Diagram

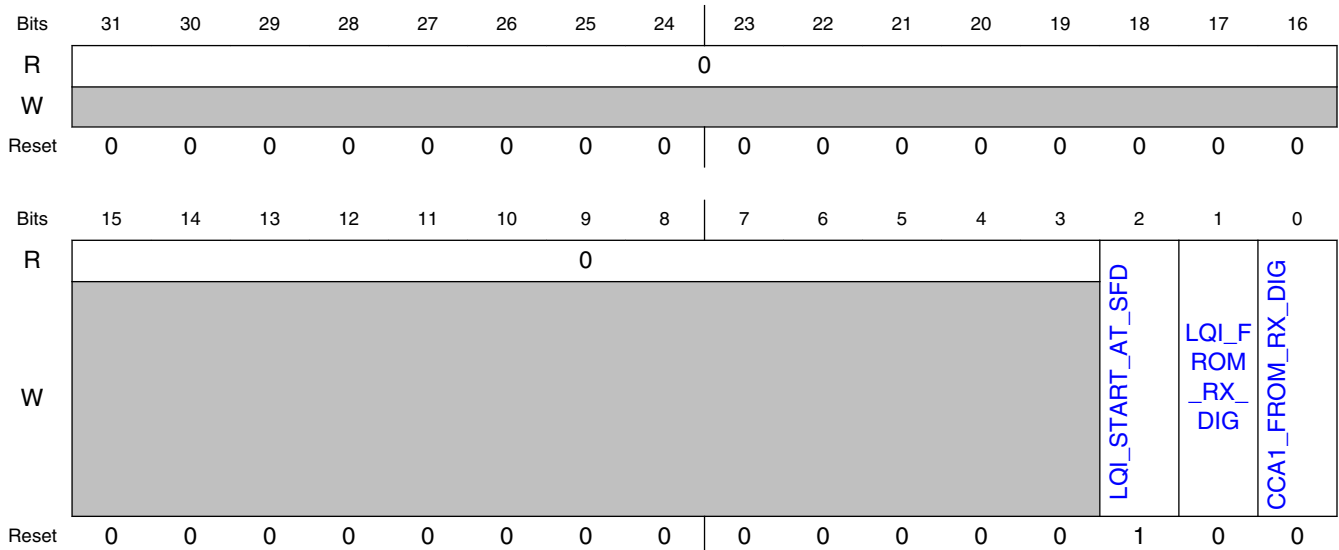

45.4.7.3.6.4 Fields

| Field | Function |
|-----------------------|---|
| 31-3 Reserved | Reserved |
| 2 LQI_START_AT_SFD | Select Start Point for LQI Computation 0b - Start LQI computation at Preamble Detection (similar to previous Freescale 802.15.4 products) 1b - Start LQI computation at SFD (Start of Frame Delimiter) Detection |
| 1 LQI_FROM_RX_DIG | Selects the Source of LQI (Link Quality Indicator) Information Provided to the 802.15.4 Link Layer 0b - Use the LQI information computed internally in the 802.15.4 Demod 1b - Use the LQI information computed by the RX Digital |
| 0 CCA1_FROM_RX_DIG | Selects the Source of CCA1 (Clear Channel Assessment Mode 1) Information Provided to the 802.15.4 Link Layer 0b - Use the CCA1 information computed internally in the 802.15.4 Demod 1b - Use the CCA1 information computed by the RX Digital |

45.4.7.3.7 FAD CORRELATOR THRESHOLD (FAD_THR)

45.4.7.3.7.1 Address

| Register | Offset |
|----------|-----------|
| FAD_THR | 4005C494h |

45.4.7.3.7.2 Diagram

| | | | | | | | | | | | | | | | | |
|-------|----|----|----|----|----|----|----|----|---------|----|----|----|----|----|----|----|
| Bits | 31 | 30 | 29 | 28 | 27 | 26 | 25 | 24 | 23 | 22 | 21 | 20 | 19 | 18 | 17 | 16 |
| R | 0 | | | | | | | | | | | | | | | |
| W | | | | | | | | | | | | | | | | |
| Reset | 0 | 0 | 0 | 0 | 0 | 0 | 0 | 0 | 0 | 0 | 0 | 0 | 0 | 0 | 0 | 0 |
| Bits | 15 | 14 | 13 | 12 | 11 | 10 | 9 | 8 | 7 | 6 | 5 | 4 | 3 | 2 | 1 | 0 |
| R | 0 | | | | | | | | FAD_THR | | | | | | | |
| W | | | | | | | | | | | | | | | | |
| Reset | 0 | 0 | 0 | 0 | 0 | 0 | 0 | 0 | 1 | 0 | 0 | 0 | 0 | 0 | 1 | 0 |

45.4.7.3.7.3 Fields

| Field | Function |
|-------|----------|
| 31-8 | Reserved |

Table continues on the next page...

FSK Modulator

| Field | Function |
|----------------|---|
| Reserved | |
| 7-0 FAD_THR | FAD_THR Correlator threshold at which the FAD will select the antenna. |

45.4.7.3.8 802.15.4 AFC STATUS (ZBDEM_AFC)

45.4.7.3.8.1 Address

| Register | Offset |
|-----------|-----------|
| ZBDEM_AFC | 4005C498h |

45.4.7.3.8.2 Diagram

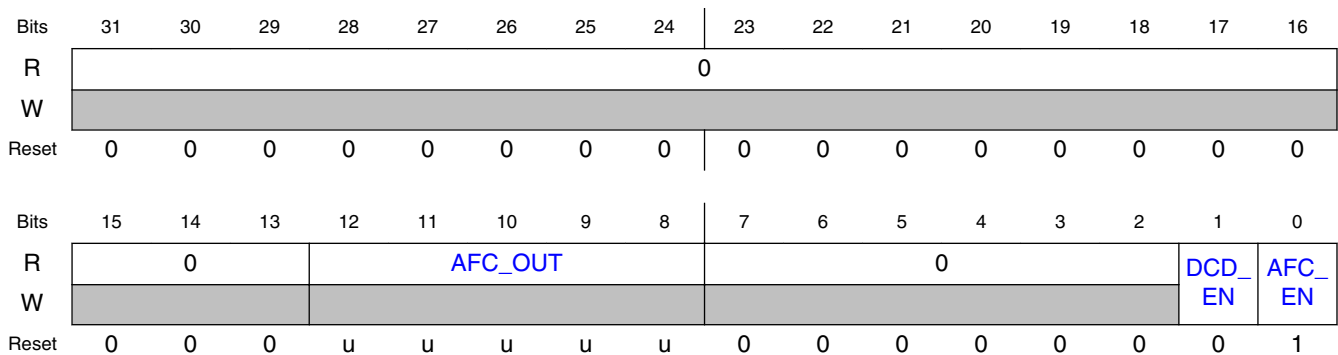

45.4.7.3.8.3 Fields

| Field | Function |
|-------------------|--|
| 31-13 Reserved | Reserved |
| 12-8 AFC_OUT | AFC_OUT AFC Result from the last received packet. Format is Signed, Two's Complement. Each LSB represents 15KHz of Frequency Offset |
| 7-2 — | Reserved |
| 1 DCD_EN | DCD_EN 0b - NCD Mode (default) 1b - DCD Mode |
| 0 | AFC_EN |

| Field | Function |
|--------|---|
| AFC_EN | the AFC Function 0b - AFC is disabled 1b - AFC is enabled |

45.5 Transceiver Analog

45.5.1 Introduction

The 2.4 GHz radio is comprised of both an analog and digital portion. The analog portion of the radio provides the local oscillator (LO), transmit modulation, and receiver down conversion, along with the various circuits needed to support those functions.

The analog block also provides a clock to the digital domain that is to be used as a reference. This clock is derived from an external reference and, in the case of a crystal, should be trimmed to be as accurate as possible. The two supported frequencies for this reference are 26 MHz and 32 MHz.

RF input and output are combined with an integrated balun located on the device. Thus, only a single RF port is needed.

It is also of note that the analog contains several LDO circuits to supply various blocks within the design.

The analog radio is configured and commanded by the digital domain using both static configuration signals and dynamic control signals.

45.5.1.1 Features

The 2.4 GHz analog radio block includes the following features:

- Fractional-N Frequency Synthesizer PLL shared by receive and transmit
- Integrated balun
- Programmable Power Amplifier (PA) from -30 dBm to +4 dBm
- Transmitter supporting constant envelope modulation for 2.4 GHz ISM and 2.36 GHz MBAN frequency bands (2360 to 2483.5 MHz)
- Direct PLL modulation for transmit
- Direct conversion receiver for 2.4 GHz ISM and 2.36 GHz MBAN frequency bands (2360 to 2483.5 MHz)

- Receive line-up comprised of a Low Noise Amplifier & Mixer, Baseband amplifier and filter, and sigma-delta ADC
- Direct analog diagnostic lines for debug and test
- Multiple LDOs to power analog circuits from line supply
- XO (REF_OSC) circuit to use an external crystal and provide a reference clock internally at 26 MHz or 32 MHz
- AuxPLL to provide a 2x reference clock
- DC correction DACs for the TZA and BBA stages
- Programmable receiver gains in both the LNA and BBA stages

45.5.1.2 Block diagram

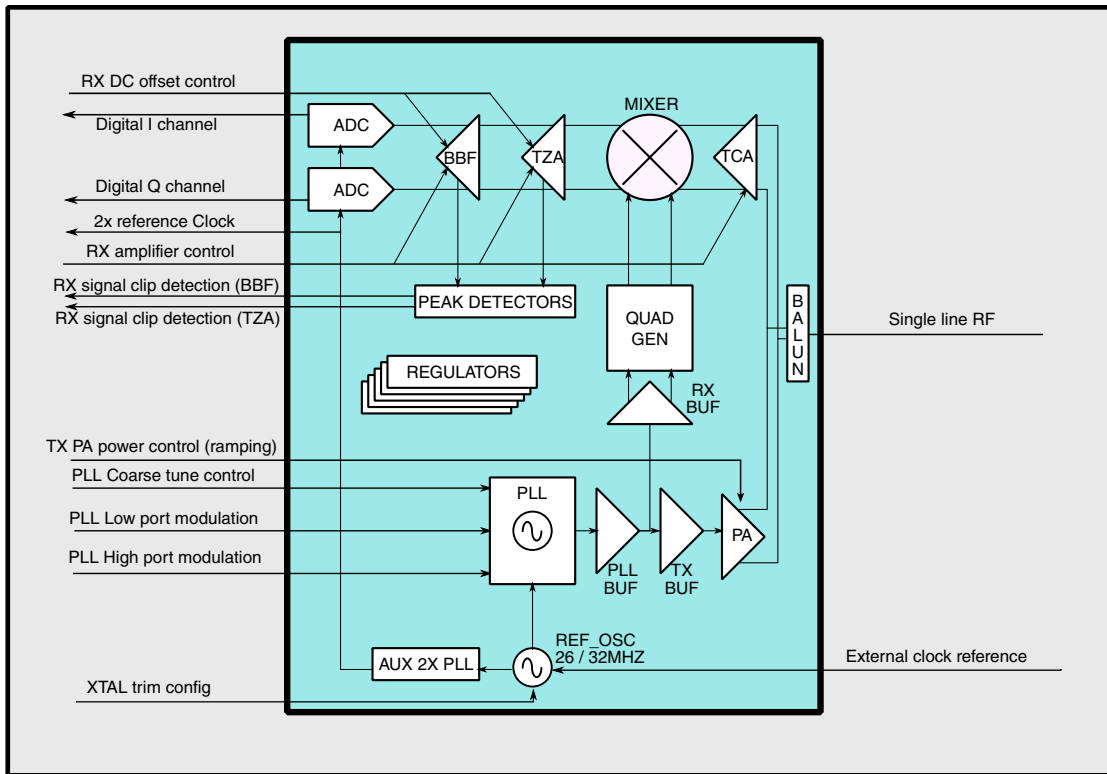

Figure 45-66. Analog Radio Block diagram

45.5.2 Functional description

The following section briefly describes the functionality of the 2.4 GHz analog radio. It is not intended to be a complete description as many of the details are covered by descriptions of the control signals that are provided from the digital domain.

The analog block serves several purposes. Primarily, it provides the necessary circuitry to transmit at 2.4 GHz and receive in the same bands. When configured for transmission, the PLL is locked to the desired frequency (band and channel) as controlled by the PLL digital module. The digital radio then modulates the high port and low port of the PLL to generate the desired RF transmission. For receiver operation, the PLL is locked to the desired band and channel just as in transmit. The mixer provides a down-converted signal at baseband. The signal then goes through the baseband amplifier and is presented to the ADC. The ADC then converts the analog signal to a digital format, where it is observed by the digital domain. The receiver uses a 2x frequency clock to convert, so this clock is also provided to the digital domain from the AuxPLL. The receive path also contains several configurable parameters. For the gain, the LNA and BBA stages can be adjusted by signals from the digital domain. This is typically performed by the AGC circuit. DC offset can be corrected by controlling offset DACs at both stages, as well.

Both transmit and receive utilize an integrated balun. This results in a single RF port for the device and eliminates the need for a board level balun.

Several LDO blocks within the analog block provide the necessary supply to corresponding circuits. There is an LDO for the BBA, etc.

The XO block uses a reference crystal (typically) to produce a stable reference clock for the analog blocks and the digital domain. More details are provided in the section describing this block.

To assist in measurements and debug, multiple diagnostic analog signals are provided. These signals can be configured by inputs from the digital domain and then observed externally or with an ADC resident in the device.

45.5.2.1 XO Block

The XO block generates a 26 MHz or a 32 MHz reference clock for the digital domain, PLL, DAC, and AuxPLL blocks of the radio. It generates the output clocks from a crystal mounted externally to the device.

This block is alternatively known as REF_OSC, OSC, or XTAL, occasionally.

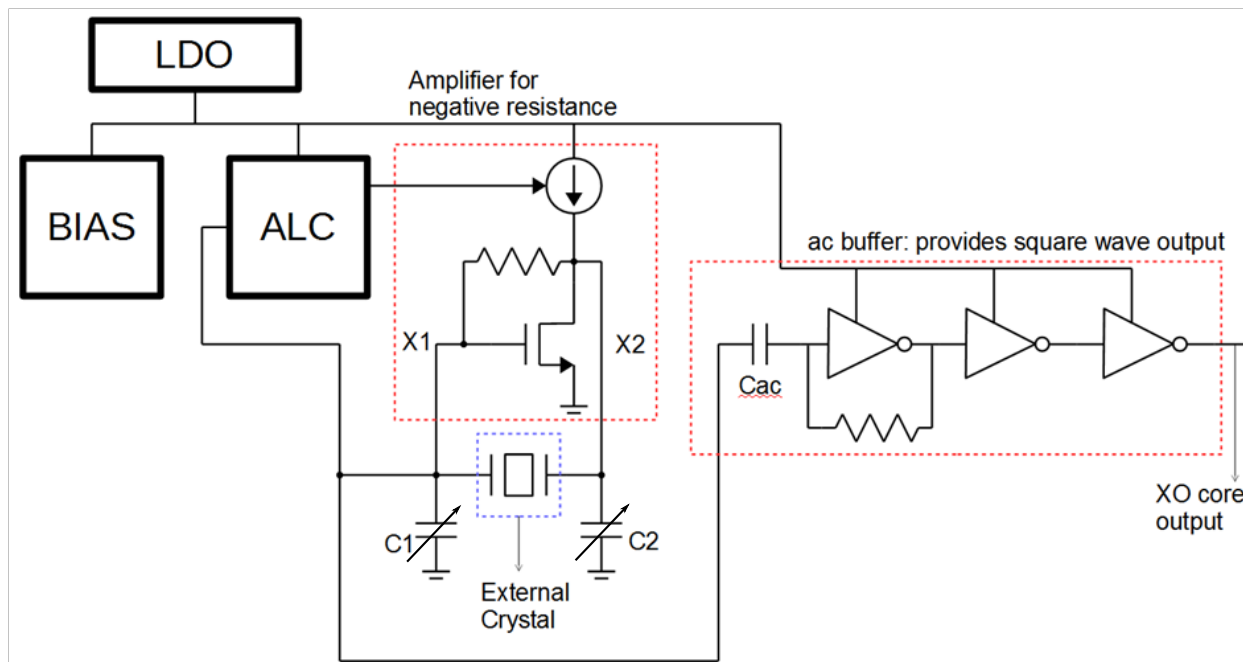

Figure 45-67. XO circuit diagram

45.5.2.1.1 XTAL Trim

To enable optimum performance, it is required to trim the XO such that an accurate clock is produced based on the external crystal used. C1 and C2 are tuneable and intended for this purpose. They can be adjusted by configuring the XTAL_TRIM bits in the digital domain.

45.6 Link Layer

45.6.1 BLE Link Layer

45.6.1.1 BLE Register Descriptions

45.6.1.1.1 Platform Registers

Platform Register Descriptions for the Bluetooth Link Layer

Instruction Register

| Addr 16-bit | Addr 32-bit | Register Name | RW | Description | Reset |
|----------------|----------------|------------------|----|--|--------|
| 0x00 | 0x000 | COMMAND_REGISTER | WO | Instructions register to send commands to link layer hardware for controlling hardware operations. | 0xXX00 |

| Field | Bit | Description | Reset |
|-----------------|-------|---|-------|
| Reserved | 15:10 | Not used | XX |
| conn_index[1:0] | 9:8 | Connection index to specify the command is for which connection engine. | 0 |
| command | 7:0 | 8-bit command from firmware to the link layer controller. See Instruction Set for the list of instructions and their opcodes. The instruction results in the link layer hardware starting/stopping an operation. <u>Notes on use</u> 1. Few of the commands will require other configuration registers to be set, before the command is written. Refer to Instruction Set for details of the registers to be set before setting these instructions. | 00 |

Event clear Register

| Addr 16-bit | Addr 32-bit | Register Name | RW | Description | Reset |
|----------------|----------------|---------------|----|---|--------|
| 0x04 | 0x008 | EVENT_CLEAR | WO | Clears the source of the interrupt. This register is written by firmware to clear interrupts set in the EVENT_STATUS register. One or more interrupts can be cleared in a single | 0x0000 |

Link Layer

| Addr 16-bit | Addr 32-bit | Register Name | RW | Description | Reset |
|----------------|----------------|---------------|----|---|-------|
| | | | | write operation, by writing a 1 at the bit fields specific to the interrupts being cleared. It is not required to write a follow-up write with zero as the previous write is not actually stored. | |

| Field | Bit | Description | Reset |
|--------------|------|--|-------|
| Reserved | 15:6 | Not used. | XX |
| Dsm_intr_clr | 5 | Clear deep sleep mode exit interrupt. Write to the register with this bit set to 1, clears the interrupt source. | |
| Sm_intr_clr | 4 | Clear sleep-mode-exit interrupt. Write to the register with this bit set to 1, clears the interrupt source. | |
| Reserved | 3:0 | Not used. | |

Event status register

| Addr 16-bit | Addr 32-bit | Register Name | RW | Description | Reset |
|----------------|----------------|---------------|----|--|--------|
| 0x04 | 0x008 | EVENT_STATUS | RO | Event (Interrupt) status. Indicates pending events which require servicing by firmware. Each of the status bits is set by the link layer hardware. The bits are set till they are cleared by firmware by writing to appropriate event clear registers. | 0x0000 |

| Field | Bit | Description | Reset |
|-------|-----|-------------|-------|
|-------|-----|-------------|-------|

Table continues on the next page...

| | | | |
|-----------|------|---|----|
| Reserved | 15:6 | Not used. | XX |
| Dsm_intr | 5 | Deep sleep mode exit interrupt. This bit is set, when link layer hardware exits from deep sleep mode. The bit is cleared when firmware writes to EVENT_CLEAR register with this bit position set to 1. | 0 |
| Sm_intr | 4 | Sleep-mode-exit interrupt. This bit is set, when link layer hardware exits from sleep mode. The bit is cleared when firmware writes to EVENT_CLEAR register with this bit position set to 1. | 0 |
| Conn_intr | 3 | Connection interrupt. If bit is set to 1, it indicates an event occurred in the connection operation. This interrupt is aggregation of interrupts for all the connections. The source of the event for the specific connection needs to be read from the CONN_INTR_STATUS register specific to the connection. This bit is cleared, when firmware clears ALL interrupts by writing to the CONN_INTR_CLEAR register. | 0 |
| Init_intr | 2 | Initiator interrupt. If bit is set to 1, it indicates an event occurred in the initiating procedure. The source of the event needs to be read from the INIT_STATUS register. This bit is cleared, when firmware clears ALL interrupts by writing to the INIT_INTR_CLEAR register. | 0 |
| Scan_intr | 1 | Scanner interrupt. If bit is set to 1, it indicates an event occurred in the scanning procedure. The source of the event needs to be read from the SCAN_STATUS register. This bit is cleared, when firmware clears ALL interrupts by writing to the SCAN_INTR_CLEAR register. | 0 |
| Adv_intr | 0 | Advertiser interrupt. If bit is set to 1, it indicates an event occurred in the advertising procedure. The source of the event needs to be read from | 0 |

Link Layer

| | | |
|--|--|---|
| | | <p>the ADV_STATUS register. This bit is cleared, when firmware clears ALL interrupts by writing to the ADV_INTR_CLEAR register.</p> |
|--|--|---|

Event enable register

| Addr 16-bit | Addr 32-bit | Register Name | RW | Description | Reset |
|----------------|----------------|---------------|----|--|--------|
| 0x08 | 0x010 | EVENT_ENABLE | RW | Event indications enable. The register enables/masks each of the possible event sources from causing an interrupt. The bit fields mask only the events from interrupting the firmware. However hardware can still generate the interrupt. Firmware, when detects one interrupt, can mask all the interrupts temporarily, by clearing the register value to 0x0000. The interrupts can be masked till the first interrupt is processed and enable the interrupts back. This ensures no new interrupts is missed while firmware is processing one. | 0x0000 |

| Field | Bit | Description | Reset |
|------------|------|--|-------|
| Reserved | 15:6 | Not used. | XX |
| Dsm_int_en | 5 | Deep Sleep-mode-exit interrupt enable. 1 – enable deep sleep mode exit event to interrupt the firmware. | 0 |

Table continues on the next page...

| Field | Bit | Description | Reset |
|-------------|-----|--|-------|
| | | 0 – disable deep sleep mode exit interrupt to firmware. | |
| Sm_int_en | 4 | Sleep-mode-exit interrupt enable. 1 – enable sleep mode exit event to interrupt the firmware. 0 – disable sleep mode exit interrupt to firmware. | 0 |
| Conn_int_en | 3 | Connection interrupt enable. 1 – enable connection procedure to interrupt the firmware. 0 – disable connection procedure interrupt to firmware. | 0 |
| Init_int_en | 2 | Initiator interrupt enable. 1 – enable initiator procedure to interrupt the firmware. 0 – disable initiator procedure interrupt to firmware. | 0 |
| Scn_int_en | 1 | Scanner interrupt enable. 1 – enable scan procedure to interrupt the firmware. 0 – disable scan procedure interrupt to firmware. | 0 |
| Adv_int_en | 0 | Advertiser interrupt enable. 1 – enable advertiser procedure to interrupt the firmware. 0 – disable advertiser procedure interrupt to firmware. | 0 |

Wakeup Configuration register

| Addr 16-bit | Addr 32-bit | Register Name | RW | Description | Reset |
|----------------|----------------|---------------|----|---|--------|
| 0x5C | 0x0B8 | WAKEUP_CONFIG | RW | Wakeup configuration to configure the various offsets while waking up from sleep mode or deep sleep mode. | 0x0000 |

Link Layer

| Field | Bit | Description | Reset |
|------------------------------|-------|--|-------|
| Dsm_offset_to_wakeup_instant | 15:10 | Number of “slots” before the wake up instant before which the hardware needs to exit from deep sleep mode. The slot is of 625 us period. This is a one-time configuration field, which is used every time hardware does an auto-wakeup before the next wakeup instant. | 0 |
| Sm_offset_to_wakeup_instant | 9 | Number of “slots” (1slot = 625 microseconds) before the wake up instant before which the hardware needs to exit from sleep mode. This is a onetime configuration field, which is used every time hardware does an auto-wakeup before the next wakeup instant. | 0 |
| Retain_in_dsm2 | 8 | “1” indicates Connection RAM to be retained during DSM2. | 0 |
| Osc_startup_delay | 7:0 | <p>Oscillator stabilization/startup delay. This is in X.Y format where X is in terms of number of BT slots (625 us) and Y is in terms of number of clock periods of 16KHz clock input, required for RF oscillator to stabilize the clock output to the controller on its output pin, after oscillator is turned ON. In this period the clock is assumed to be unstable, and so the controller does not turn on the clock to internal logic till this period is over. This means, the wake up from deep sleep mode must account for this delay before the wakeup instant.</p> <p>Osc_startup_delay[7:5] is number of slots(625 us)</p> <p>Osc_startup_delay[4:0] is number of clock periods of 16KHz clock</p> <p>(Warning: Min. value of Osc_startup_delay [4:0] supported is 1 and Max. value is 9. Therefore programmable range is 1 to 9)</p> | 00 |

NOTE

In case of firm ware DSM exit mode: Exit from DSM shall be in synchronization with ref_clk (625 us slots timing) and shall not come out of DSM mode before meeting the oscillator start up delay. It is expected to have 0 to 625 us extra delay to wake-up from DSM, depends upon the assertion of the dsm_exit signal (firmware exit).

Sleep Threshold register

| Addr 16-bit | Addr 32-bit | Register Name | RW | Description | Reset |
|----------------|----------------|---------------------|----|--|--------|
| 0x5E | 0x0BC | SLEEP_THRESHO LD | RW | Sleep Threshold register. Stores threshold values for entering sleep mode or deep sleep mode. The threshold values are compared with the inactivity period to determine entry into one of the modes. | 0x0000 |

| Field | Bit | Description | Reset |
|---------------------|-------|---|-------|
| Sm_threshold[3:0] | 15:12 | Number of inactive “slots” above which the device can enter sleep mode. If the number of slots is below this threshold, then device will not enter sleep mode. | 0 |
| Dsm_threshold[11:0] | 11:0 | Number of inactive “slots” above which the device can enter sleep mode. If the number of slots is below this threshold, then device will not enter deep sleep mode. | 0 |

NOTE

Typically dsm_threshold > sm_threshold value. This means the following behavior is expected

Link Layer

| No. of inactive slots(N) | Behaviour |
|--------------------------------------|-----------------|
| $N < sm_threshold$ | No power save |
| $Sm_threshold < N < dsm_threshold$ | Sleep Mode |
| $N > dsm_threshold$ | Deep sleep mode |

Wakeup control register

| Addr 16-bit | Addr 32-bit | Register Name | RW | Description | Reset |
|----------------|----------------|--------------------|----|---|--------|
| 0x60 | 0x0C0 | WAKEUP_CONTR OL | RW | Wakeup instant register. Program the 16-bit reference clock value for auto-wakeup from deep sleep mode. | 0x0000 |

| Field | Bit | Description | Reset |
|----------------------|------|--|-------|
| Wakeup_instant[15:0] | 15:0 | Instant, with reference to the internal 16-bit clock reference, at which the hardware must wakeup from deep sleep mode. This is calculated by firmware based on the next closest instant where a controller operation is required (like advertiser/scanner). Firmware reads the next instant of the procedures in the corresponding *_NEXT_INSTANT registers. This value is used only when hardware auto wakeup from deep sleep mode is enabled in the clock control register. | 0 |

NOTE

It is recommended to program wakeup_instant such a way that the actual instant to wakeup shall be at least two counts (two slots of 625 us) ahead of reference clock when entering DSM. The actual instant to wakeup is “wakeup_instant – dsm_offset_to_wakeup_instant – osc_startup_delay, and it shall be greater than “reference clock + 2”

Clock control register

| Addr 16-bit | Addr 32-bit | Register Name | RW | Description | Reset |
|----------------|----------------|---------------|----|--|--------|
| 0x62 | 0x0C4 | CLOCK_CONFIG | RW | Clock control and configuration. Controls clock gating and clock switch logic. | 0x0080 |

| Field | Bit | Description | Reset |
|--------------------|-----|--|-------|
| Deep_sleep_mode_en | 15 | Enable deep sleep mode. 1 – enable, 0 – disable. Enables hardware logic related to deep sleep mode to control the deep sleep mode operation. If disabled, the related logic is not executed and hardware cannot enter deep sleep mode. | 0 |
| Sleep_mode_en | 14 | Enable sleep mode. 1 – enable, 0 – disable. Enables hardware to control sleep mode operation. | 0 |
| Dsm_intr_en | 13 | Enable DSM exit interrupt. 1 – enable, 0 – disable. Enables hardware to generate an interrupt while exiting deep sleep mode. When enabled, interrupt is generated independent of whether exit procedure is initiated by hardware or firmware. | 0 |
| sm_intr_en | 12 | Enable SM exit interrupt. 1 – enable, 0 – disable. Enables hardware to generate an interrupt while exiting sleep mode – irrespective of whether it is initiated by hardware or firmware. The interrupt is captured and stored till it gets cleared. Disabling this bit mask the sleep mode exit event from hardware & firmware. | 0 |
| Dsm_auto_sleep_en | 11 | Enable deep sleep mode auto entry in hardware. 1 – enable hardware to enter DSM automatically 0 – disable hardware to enter DSM automatically. | 0 |

Table continues on the next page...

Link Layer

| Field | Bit | Description | Reset |
|-------------------------------|-----|--|-------|
| Sm_auto_wkup_en | 10 | <p>Enable sleep mode auto wakeup enable. 1- enable, 0 – disable.</p> <p>Enables hardware to automatically wakeup from sleep mode at the instant = <i>wakeup_instant</i> – <i>sm_offset_to_wakeup_instant</i>. The <i>wakeup_instant</i> is the field in the <i>wakeup control register</i> described earlier. The <i>sm_offset_to_wakeup_instant</i> value is the field described in the <i>wakeup configuration register</i>.</p> | 0 |
| Lpo_sel_external | 9 | <p>Select external sleep clock. 1 – External clock, 0 - internal generated clock.</p> <p>The field is used to select either the low power clock input on sleep_clk input pin(of frequency 16.384KHz) directly to run the DSM logic or to use the internal generated reference clock(of 16KHz) for the same.</p> | 0 |
| Lpo_clk_freq_sel | 8 | <p>Clock frequency select. 0 – 32 kHz, 1 – 32.768 kHz.</p> <p>Base frequency of the sleep_clk input used for generating the internal reference clock of approximate 16 khz frequency.</p> | 0 |
| LLH_idle (READ ONLY field) | 7 | <p>Indicates if hardware is doing any transmit/receive operation or there is a pending interrupt from hardware. This information is used by firmware to decide to program the hardware into deep sleep mode.</p> <p>1 – LL hardware is idle.</p> <p>0 – LL hardware is busy. In this case LL hardware will not enter deep sleep mode, even if firmware gives an enter DSM command. (In this situation hardware generates dsm exit interrupt to inform firmware that DSM entry was not successful).</p> | 1 |
| Reserved | 6 | Not used | |

Table continues on the next page...

| Field | Bit | Description | Reset |
|------------------|-----|---|-------|
| Sysclk_gate_en | 5 | <p>Sysclk gate enable. 1- enable, 0 – disable.</p> <p>Enables clock gating of system clock input to the link layer. If 1, it enables the DSM logic to control the clock gate for system clock input from pin. If 0, the DSM logic has no control and the system clock is always ON.</p> | 0 |
| Coreclk_gate_en | 4 | <p>Core clock gate enable. 1 – enable, 0 – disable.</p> <p>Enables gating of clock to the llh_core module in hardware. If 1, the sleep mode/deep sleep mode logic can control the clock gate to shutdown/wakeup the clock to the module. If 0, the logic has no control and clock is always turned ON.</p> | 0 |
| Conn_clk_gate_en | 3 | <p>Connection block clock gate enable. 1 – enable, 0 – disable.</p> <p>Enables gating of clock to the connection module (llh_connch_top) in hardware. If 1, the sleep mode logic can control the clock gate to shutdown/wakeup the clock to the engine. If 0, the logic has no control and clock to the module is always turned ON.</p> | 0 |
| Init_clk_gate_en | 2 | <p>Initiator block clock gate enable. 1 – enable, 0 – disable.</p> <p>Enables gating of clock to the initiator module (llh_init). If 1, the sleep mode logic can control the clock gate to shutdown/wakeup the clock to the module. If 0, the logic has no control and clock to the module is always turned ON.</p> | 0 |
| Scan_clk_gate_en | 1 | <p>Scan block clock gate enable. 1 – enable, 0 – disable.</p> <p>Enables gating of clock to the scanner module (llh_scan) in hardware. If 1, the sleep mode logic can control the clock gate to shutdown/wakeup the clock to the</p> | 0 |

Table continues on the next page...

Link Layer

| Field | Bit | Description | Reset |
|-----------------|-----|--|-------|
| | | module. If 0, the logic has no control and clock to the module is always turned ON. | |
| Adv_clk_gate_en | 0 | Advertiser block clock gate enable. 1 – enable, 0 – disable. Enables gating of clock to the advertiser module (llh_adv) in hardware. If 1, the sleep mode logic can control the clock gate to shutdown/ wakeup the clock to the module. If 0, the logic has no control and clock to the module is always turned ON. | 0 |

Reference Clock register

| Addr 16-bit | Addr 32-bit | Register Name | RW | Description | Reset |
|----------------|----------------|---------------|----|--|--------|
| 0x64 | 0x0C8 | TIM_COUNTER_L | RO | 16-bit reference clock used for timing reference in the operation of the hardware. | 0x0000 |

| Field | Bit | Description | Reset |
|-------------|------|--|-------|
| Clock[15:0] | 15:0 | 16-bit internal reference clock. The clock is a free running clock, incremented by a 625 us periodic pulse. It is used as a reference clock to derive all the timing required as per protocol. | 0000 |

BLE Time Control

| Addr 16-bit | Addr 32-bit | Register Name | RW | Description | Reset |
|----------------|----------------|---------------|----|------------------------------------|--------|
| 0X6C | 0XD8 | TIME_CONTROL | WO | LLH clock frequency configuration. | 0x0000 |

| Field | Bit | Description | Reset |
|---------------------|------|--|-------|
| RFU | 15:8 | Not used | 0x0 |
| bb_clk_freq_minus_1 | 7:3 | The frequency information (FREQ – 1) of the clock input to LL Hardware is configured in this register by the firmware during initialization. This information is used inside LL Hardware to derive timing information for the Bluetooth operations. For example, if the frequency of the input clock is 12 MHz this field shall be programmed to 0xB. (1 less than frequency) | 0x0 |
| RFU | 2:0 | Not used | 0x0 |

DSM configuration register

| Addr 16-bit | Addr 32-bit | Register Name | RW | Description | Reset |
|----------------|----------------|---------------|----|-----------------------------|--------|
| 0X51A | 0XA34 | DSM_CONFIG | RW | DSM configuration register. | 0x0008 |

| Field | Bit | Description | Reset |
|---------------------------|------|--|-------|
| Not used | 15:9 | Not used | 0x0 |
| enable_conn_clk_ctrl[1:0] | 8:7 | Each bit corresponds to one connection engine (bit 7 for conn engine 0). Each of the bits if set to '1' will enable LLH to turn on corresponding CONNECTION engine clock on EXIT_SM command from firmware. To use this feature CONNECTION NAP modes shall be enabled in LLH. | 0x0 |
| enable_init_clk_ctrl | 6 | If this bit is set to '1' then LLH will turn on INIT engine clock on EXIT_SM command from firmware. To use this feature INIT NAP modes shall be enabled in LLH. | 0x0 |
| enable_scan_clk_ctrl | 5 | If this bit is set to '1' then LLH will turn on SCAN engine clock on EXIT_SM command from firmware. To use this feature SACN NAP mode shall be enabled in LLH. | 0x0 |

Table continues on the next page...

Link Layer

| Field | Bit | Description | Reset |
|---------------------|-----|--|-------|
| enable_adv_clk_ctrl | 4 | If this bit is set to '1' then LLH will turn on ADV engine clock on EXIT_SM command from firmware. To use this feature ADV NAP mode shall be enabled in LLH. | 0x0 |
| enable_eng_clk_ctrl | 3 | Configuration bit for turning off all engine specific clocks after wakeup from SHUTDOWN (after register restore is complete). If this bit is set to '1' then LLH will turn off all engine specific clocks after restore_done. To use this feature all NAP modes shall be enabled in LLH. | 0x1 |
| restore_done_bypass | 2 | Configuration bit for bypassing wait for restore_done signal to exit from RESTORE state. If this bit is set to '1' then power control FSM will move to next state without waiting for restore_done from RESTORE state and if this bit is set to '0' then power state machine will wait in RESTORE state till restore_done comes. This bit can be effectively used to reduce wakeup time if restore gets completed in one LP clock cycle. | 0x0 |
| store_done_bypass | 1 | Configuration bit for bypassing wait for store_done signal to enter in to SHUTDOWN. If this bit is set to '1' then power control FSM will move to next state without waiting for store_done from STORE state and if this bit is set to '0' then power state machine will wait in STORE state till store_done comes. This bit can be effectively used to reduce SHUTDOWN entry time if store gets completed in one LP clock cycle. | 0x0 |
| dsm_config | 0 | Configuration bit for DSM SHUTDOWN LLH store and restore control. If this bit is set to '1' then LLH will do the store and restore of its registers on its own during entry and after exit from | 0x0 |

| Field | Bit | Description | Reset |
|-------|-----|---|-------|
| | | shutdown. To use this feature DSM SHUTDOWN mode is to be supported and also LLH shall have access to RETENTION RAM. | |

NOTE

To enable dynamic power saving through selective clock gating of different engines LL firmware will set the configuration bits corresponding to BT procedures which are active. This will ensure that clocks to only active blocks are enabled during EXIT_SM command from LL firmware to LL hardware. User can over-ride this mode by setting the bits.

Nearest Instant register

| Addr 16-bit | Addr 32-bit | Register Name | RW | Description | Reset |
|----------------|----------------|---------------|----|--|--------|
| 0X520 | 0XA40 | NEAREST_INST | RO | This register reports the next immediate instant in terms of bt_clock value (actual value being reported is INSTANT – 3) where hardware has any scheduled BT activity. Firmware reads this register along with the TIM_COUNTER_L register to calculate the possibility of power save mode entry. | 0x0000 |

| Field | Bit | Description | Reset |
|------------------------|------|---|--------|
| global_nearest_instant | 15:0 | This field holds the immediate future value of BT_CLOCK where a scheduled Bluetooth activity is supposed to happen. When no Bluetooth activity is running the register will hold current BT_CLOCK value – 3. | 0x0000 |

45.6.1.1.2 Advertising Channel Registers

Advertising Channel Register Descriptions for the Bluetooth Link Layer

Advertising parameters register

| Addr 16-bit | Addr 32-bit | Register Name | RW | Description | Reset |
|----------------|----------------|---------------|----|---|--------|
| 0x0C | 0x018 | ADV_PARAMS | RW | Advertising parameters register. Firmware sets the necessary parameters for the advertising procedure into this register before issuing start advertise command. The fields in this register correspond to the fields in the LE_Set_Advertising_Parameters HCI command. | 0x00E0 |

| Field | Bit | Description | Reset |
|---------------------------------------|-------|--|-------|
| peer_rx_txaddr (Read Only) | 15 | Transmit address field of the received packet indicating the peer address type as public/random. This field is used by firmware to report peer_addr_type parameter in the connection complete event. 0 – addr type is public. 1 – addr type is random. | 0 |
| peer_addr_resolved_reg (Read Only) | 14 | Address resolution status of the received packet if the received address was RPA. 0 – RPA resolution fail 1 – RPA resolution pass. Else this bit is set to zero. | 0 |
| Reserved | 13 | Not used | |
| slv_index | 12:11 | Slave index is programmed by FW before initiation procedure for selecting connection engine in slave role connection. | 0 |

Table continues on the next page...

| Field | Bit | Description | Reset |
|--------------------------------|-----|--|-------|
| | | Number of supported engines is 2. (Index from 0x0 to 0x1) | |
| adv_low_duty_cycle | 10 | This bit field is used to specify to the Controller the Low Duty Cycle connectable directed advertising variant being used. 1 – Low Duty Cycle Connectable Directed Advertising. 0 – High Duty Cycle Connectable Directed Advertising. | 0 |
| Force_scan_rsp (Write Only) | 9 | Force scan response packet always. <i>Used only if TESTER build is enabled.</i> 1 – Override ADV packet type and send scan response packet type in the header field in all ADV packets 0 – no effect. | 0 |
| Rx_addr | 8 | Peer addresses type. This is the Direct_Address_type field programmed, only if ADV_DIRECT_IND type is sent. 1 – Rxaddr type is random. 0 – Rxaddr type is public. | 0 |
| Adv_channel_map | 7:5 | Advertising channel map indicates the advertising channels used for advertising. By setting the bit, corresponding channel is enabled for use. At least one channel bit should be set. Bit 7 - enable channel 39. Bit 6 - enable channel 38. Bit 5 - enable channel 37. | 7 |
| Adv_filt_policy | 4:3 | Advertising filter policy. The set of devices that the advertising procedure uses for device filtering is called the White List . 0x00 – Allow scan request from any device, allow connect request from any device. | 0 |

Table continues on the next page...

Link Layer

| Field | Bit | Description | Reset |
|----------|-----|--|-------|
| | | <p>0x01 – Allow scan request from devices in white list only, allow connect request from any device.</p> <p>0x10 – Allow scan request from any device, allow connect request from devices in white list only.</p> <p>0x11 – Allow scan request from devices in white list only, allow connect request from devices in white list only.</p> | |
| Adv_type | 2:1 | <p>The Advertising type is used to determine the packet type that is used for advertising when advertising is enabled.</p> <p>00b – Connectable undirected advertising. (adv_ind)</p> <p>01b – Connectable directed advertising (adv_direct_ind).</p> <p>10b – Discoverable undirected advertising (adv_discover_ind)</p> <p>11b – Non connectable undirected advertising (adv_nonconn_ind).</p> | 0 |
| Reserved | 0 | Reserved for future use. | 0 |

Advertising Interval register

| Addr 16-bit | Addr 32-bit | Register Name | RW | Description | Reset |
|----------------|----------------|----------------------|----|--|--------|
| 0x0E | 0x01C | ADV_INTERVAL_TIMEOUT | RW | <p>Advertising interval register. It is the interval between two consecutive advertising events. For directed advertising, this register holds the timeout value.</p> <p>Has a resolution of 625 us.</p> <p>Time = N * 625 us</p> <p>Time Range: 20 ms to 10.24 s.</p> | 0x0020 |

| Addr 16-bit | Addr 32-bit | Register Name | RW | Description | Reset |
|----------------|----------------|---------------|----|---|-------|
| | | | | Firmware updates this value before issuing start advertise command. | |

| Field | Bit | Description | Reset |
|--------------|------|---|--------|
| Adv_interval | 15:0 | Range: 0x0020 to 0x4000 (For ADV_IND) 0x00A0 to 0x4000 (For ADV_SCAN_IND and NONCONN_IND) For directed advertising, firmware programs the default value of 1.28 s. | 0x0010 |

Advertising interrupt clear register

| Addr 16-bit | Addr 32-bit | Register Name | RW | Description | Reset |
|----------------|----------------|----------------|----|--|--------|
| 0x10 | 0x020 | ADV_INTR_CLEAR | WO | Clears the source of the interrupt. This register is written by firmware to clear interrupts set in the ADV_STATUS register. One or more interrupts can be cleared in a single write operation, by setting the bit field to 1 for corresponding interrupt. It is not required to write a follow-up write with bit 0, as the previous bit 1 is not actually stored. | 0x0000 |

Link Layer

| Field | Bit | Description | Reset |
|------------------|------|---|-------|
| Reserved | 15:8 | Not used. | XX |
| adv_timeout | 7 | Clear adv_timeout interrupt. Applicable in ADV_DIRECT_IND advertising. Write to the register with this bit set to 1, clears the interrupt source. | 0 |
| slv_connected | 6 | Clear slave connected interrupt. Write to the register with this bit set to 1, clears the interrupt source. | 0 |
| conn_req_rx_intr | 5 | Clear connect request packet received interrupt. Write to the register with this bit set to 1, clears the interrupt source | 0 |
| scan_req_rx_intr | 4 | Clear scan request packet received interrupt. Write to the register with this bit set to 1, clears the interrupt source | 0 |
| scn_rsp_tx_intr | 3 | Clear scan response packet transmitted interrupt. Write to the register with this bit set to 1, clears the interrupt source | 0 |
| adv_tx_intr | 2 | Clear adv packet transmitted interrupt. Write to the register with this bit set to 1, clears the interrupt source | 0 |
| adv_close_intr | 1 | Clear advertising event stop interrupt. Write to the register with this bit set to 1, clears the interrupt source | 0 |
| adv_strt_intr | 0 | Clear advertising event start interrupt. Write to the register with this bit set to 1, clears the interrupt source | 0 |

Advertising status register

| Addr 16-bit | Addr 32-bit | Register Name | RW | Description | Reset |
|----------------|----------------|---------------|----|---|--------|
| 0x10 | 0x020 | ADV_STATUS | RO | Advertising status register shows the status of the interrupts .Each of the status bits is set by the advertising procedure in hardware. The bits are set till they are cleared by firmware by writing to | 0x0000 |

| Addr 16-bit | Addr 32-bit | Register Name | RW | Description | Reset |
|----------------|----------------|---------------|----|--|-------|
| | | | | appropriate interrupt clear registers. | |

| Field | Bit | Description | Reset |
|------------------|------|--|-------|
| Reserved | 15:9 | Not used. | XX |
| Adv_on | 8 | Advertiser procedure is ON in hardware. Indicates that advertiser procedure is ON in hardware. 1 – on 0 – off | 0 |
| adv_timeout | 7 | If this bit is set it indicates that the directed advertising event has timed out after 1.28 s. Applicable in adv_direct_ind advertising only. | 0 |
| slv_connected | 6 | If this bit is set it indicates that connection is created as slave. | 0 |
| conn_req_rx_intr | 5 | If this bit is set it indicates connect request packet is received. | 0 |
| scan_req_rx_intr | 4 | If this bit is set it indicates scan request packet received. | 0 |
| scn_rsp_tx_intr | 3 | If this bit is set it indicates scan response packet transmitted in response to previous scan request packet received. | 0 |
| adv_tx_intr | 2 | If this bit is set it indicates ADV packet is transmitted. | 0 |
| adv_close_intr | 1 | If this bit is set it indicates current advertising event is closed. | 0 |
| adv_strt_intr | 0 | If this bit is set it indicates a new advertising event started after interval expiry. | 0 |

Advertising next instant register

| Addr 16-bit | Addr 32-bit | Register Name | RW | Description | Reset |
|----------------|----------------|----------------------|----|-------------------------------------|--------|
| 0x12 | 0x024 | ADV_NEXT_INSTA NT | RO | Shows the instant at which the next | 0x0000 |

Link Layer

| Addr 16-bit | Addr 32-bit | Register Name | RW | Description | Reset |
|----------------|----------------|---------------|----|--|-------|
| | | | | advertising event begins. This is with reference to internal reference clock of resolution 625 us. | |

| Field | Bit | Description | Reset |
|------------------|------|---|-------|
| next_adv_instant | 15:0 | Shows the next start of advertising event with reference to the internal reference clock. | 0 |

Scan Interval register

| Addr 16-bit | Addr 32-bit | Register Name | RW | Description | Reset |
|----------------|----------------|---------------|----|---|--------|
| 0x14 | 0x028 | SCAN_INTERVAL | RW | Scan interval register. Interval between two consecutive scanning events. Firmware sets the scanning interval value to this register before issuing start scan command. | 0x0010 |

| Field | Bit | Description | Reset |
|---------------|------|---|--------|
| scan_interval | 15:0 | Interval between two consecutive scanning events. Range: 0x0004 to 0x4000 Default: 0x0010 (10 ms) Time = N * 625 us Time Range: 2.5 ms to 10.24 s . | 0X0010 |

Scan Window register

| Addr 16-bit | Addr 32-bit | Register Name | RW | Description | Reset |
|----------------|----------------|---------------|----|---|--------|
| 0x16 | 0x02C | SCAN_WINDOW | RW | Scan window register. Duration of scan in a scanning event, which should be less than or equal to scan interval value . Firmware sets the scan window value to this register before issuing start scan command. | 0x0010 |

| Field | Bit | Description | Reset |
|-------------|------|--|--------|
| scan_window | 15:0 | Duration of scan in a scanning event, which should be less than or equal to scan interval value. Range: 0x0004 to 0x4000 Default: 0x0010 (10 ms) Time = N * 625 us Time Range: 2.5 ms to 10.24 s . | 0X0010 |

Scan parameters register

| Addr 16-bit | Addr 32-bit | Register Name | RW | Description | Reset |
|----------------|----------------|---------------|----|---|--------|
| 0x18 | 0x030 | SCAN_PARAM | RW | Scanning parameters register. Firmware sets the necessary parameters for scanning procedure into this register before issuing start scan command. The fields are derived from the LE_Set_Scan_Parameters HCI command. | 0x0000 |

Link Layer

| Field | Bit | Description | Reset |
|------------------|------|---|-------|
| Reserved | 15:7 | Not used. | XX |
| scan_tx_addr[1] | 6 | MSB of the device's Own address. This bit along with scan_tx_addr[0] decides the own address used for scanner. | 0 |
| Dup_filt_en | 5 | Filter duplicate packets. 1 – Duplicate packet filtering enabled. 0 – Duplicate packet filtering not enabled. This field is derived from the <i>LE_set_scan_enable</i> command. | 0 |
| scan_filt_policy | 4:3 | The scanner filter policy determines how the scanner processes advertising packets . 0x00 – Accept advertising packets from any device. A connectable Directed advertising packet not containing the scanner's device address is ignored. 0x01 – Accept advertising packets from only devices in the whitelist . A connectable Directed advertising packet not containing the scanner's device address is ignored. 0x10 – Accept advertising packets from any device. A connectable Directed advertising packet is not ignored if the InitA is a resolvable private address. 0x11 – Accept advertising packets from only devices in the whitelist. A connectable Directed advertising packet is not ignored if the InitA is a resolvable private address. Adv_direct_ind packets which are not addressed to this device are ignored. | 0 |
| scan_type | 2:1 | 0x00 – passive scanning. (default) 0x01 – active scanning. 0x10 – RFU | 0 |

Table continues on the next page...

| Field | Bit | Description | Reset |
|-----------------|-----|--|-------|
| | | 0x11 – RFU | |
| scan_tx_addr[0] | 0 | Device's own address type. 1 – addr type is random. 0 – addr type is public. NOTE: Scan_tx_addr[1:0] 0x0 – use public address 0x1 – use random address 0x2 – use RPA if matching entry is available in Resolving list else use public address. 0x3 – use RPA if matching entry is available in Resolving list else use random address. | 0 |

Scan interrupt clear register

| Addr 16-bit | Addr 32-bit | Register Name | RW | Description | Reset |
|----------------|----------------|-----------------|----|--|--------|
| 0x1C | 0x038 | SCAN_INTR_CLEAR | WO | Clears the source of the interrupt. This register is written by firmware to clear interrupts set in the SCAN_STATUS register. One or more interrupts can be cleared in a single write operation. | 0x0000 |

| Field | Bit | Description | Reset |
|------------------|------|--|-------|
| Reserved | 15:5 | Not used. | XX |
| scan_rsp_rx_intr | 4 | Clear scan_rsp packet received interrupt. Write to the register with this bit set to 1, clears the interrupt source. | 0 |
| adv_rx_intr | 3 | Clear adv packet received interrupt. Write to the register | 0 |

Table continues on the next page...

Link Layer

| Field | Bit | Description | Reset |
|-----------------|-----|--|-------|
| | | with this bit set to 1, clears the interrupt source | |
| scan_tx_intr | 2 | Clear scan request packet transmitted interrupt. Write to the register with this bit set to 1, clears the interrupt source | 0 |
| scan_close_intr | 1 | Clear scan event close interrupt. Write to the register with this bit set to 1, clears the interrupt source | 0 |
| scan_strt_intr | 0 | Clear scan event start interrupt. Write to the register with this bit set to 1, clears the interrupt source | 0 |

Scan status register

| Addr 16-bit | Addr 32-bit | Register Name | RW | Description | Reset |
|----------------|----------------|---------------|----|--|--------|
| 0x1C | 0x038 | SCAN_STATUS | RO | Shows the status of the interrupt. This register is read by firmware to learn the pending scan interrupts that are set and are to be served. | 0x0000 |

| Field | Bit | Description | Reset |
|----------------------|--------------|---|-------|
| Reserved | 15:9 and 7:6 | Not used. | XX |
| scan_on | 8 | Scan procedure is active. 1 – scan procedure is active. 0 – scan procedure is not active. | |
| scan_rsp_adv_rx_intr | 5 | If this bit is set after both SCAN_RSP and ADV packets are received. This interrupt may be enabled, if firmware desires to be interrupted after complete reception, instead of interrupt for each packet – which are enabled by bits 4 and 3. | 0 |
| scan_rsp_rx_intr | 4 | If this bit is set it indicates SCAN_RSP packet is received. Firmware can read the content of the packet from | 0 |

Table continues on the next page...

| Field | Bit | Description | Reset |
|-----------------|-----|---|-------|
| | | the INIT_SCN_ADV_RX_FIFO. | |
| adv_rx_intr | 3 | If this bit is set it indicates ADV packet received. Firmware can read the content of the packet from the INIT_SCN_ADV_RX_FIFO. | 0 |
| scan_tx_intr | 2 | If this bit is set it indicates scan request packet is transmitted. | 0 |
| scan_close_intr | 1 | If this bit is set it indicates scan window is closed. | 0 |
| scan_strt_intr | 0 | If this bit is set it indicates scan window is opened. | 0 |

NOTE

scan_rsp_adv_rx_intr — This interrupt is generated while active scanning ,after receiving both the adv and scan response packets, in case of receiving adv_ind and adv_discover_ind. Currently not in use.

scan_rsp_rx_intr – This interrupt is generated while active scanning upon receiving scan response packet.

adv_rx_intr – This interrupt is generated while active/passive scanning upon receiving adv packets.

Scan next instant register

| Addr 16-bit | Addr 32-bit | Register Name | RW | Description | Reset |
|----------------|----------------|-------------------|----|--|--------|
| 0x1E | 0x03C | SCAN_NEXT_INSTANT | RO | Shows the instant with respect to internal reference clock of resolution 625 us at which next scanning event begins. | 0x0000 |

| Field | Bit | Description | Reset |
|-------------------|------|--|-------|
| next_scan_instant | 15:0 | Shows the instant with respect to internal reference clock at which next scanning window begins. | 0 |

Initiator Interval register

| Addr 16-bit | Addr 32-bit | Register Name | RW | Description | Reset |
|----------------|----------------|---------------|----|---|--------|
| 0x20 | 0x040 | INIT_INTERVAL | RW | Initiator interval register. Firmware sets the initiator's scanning interval value to this register before issuing create connection command. | 0x0000 |

| Field | Bit | Description | Reset |
|--------------------|------|--|--------|
| Init_scan_interval | 15:0 | Interval between two consecutive scanning events. Range: 0x0004 to 0x4000 Time = N * 625 us Time Range: 2.5 ms to 10.24 s . | 0X0000 |

Initiator window register

| Addr 16-bit | Addr 32-bit | Register Name | RW | Description | Reset |
|----------------|----------------|---------------|----|---|--------|
| 0x22 | 0x044 | INIT_WINDOW | RW | Initiator window register. Firmware sets the scan window value to this register before issuing the create connection command. | 0x0000 |

| Field | Bit | Description | Reset |
|------------------|------|---|--------|
| Init_scan_window | 15:0 | Duration of scan in a scanning event, which should be less than or equal to scan interval value. Range: 0x0004 to 0x4000 Default: 0x0010 (10 ms) Time = N * 625 us | 0X0000 |

| Field | Bit | Description | Reset |
|-------|-----|---------------------------------|-------|
| | | Time Range: 2.5 ms to 10.24 s . | |

Initiator parameter register

| Addr 16-bit | Addr 32-bit | Register Name | RW | Description | Reset |
|----------------|----------------|---------------|----|---|--------|
| 0x24 | 0x048 | INIT_PARAM | RW | Initiator parameters register. Firmware sets the necessary parameters for initiation procedure to this register before issuing the create connection command. The fields in this register are derived from the parameters in the LE_Create_Connec tion HCI command. | 0x0000 |

| Field | Bit | Description | Reset |
|---------------------------------------|-------|--|-------|
| Reserved | 15:10 | Not used. | XX |
| peer_rpa_resolved_capt (Read only) | 9 | If received peer address is an RPA, this bit represents the RPA resolution status. ie., 1 – RPA resolution pass. 0 – RPA resolution fail. Else this bit is set to zero. | 0 |
| init_tx_addr[1] | 8 | MSB of the device's Own address type. This bit along with init_tx_addr[0] decides the own address of the device. | 0 |
| Reserved | 7 | Not used | XX |
| Init_conn_index | 6:4 | Firmware programs the index of the conn engine for the master connection at init start. Index can be in the range 0x0 to 0x1. | 0x0 |
| init_filt_policy | 3 | The Initiator_Filter_Policy is used to determine whether the White List is used or not used. | 0 |

Table continues on the next page...

Link Layer

| Field | Bit | Description | Reset |
|---------------------------------------|-----|---|-------|
| | | <p>0 – White list is not used to determine which advertiser to connect to. Instead the Peer_Address_Type and Peer_Address fields are used to specify the address type and address of the advertising device to connect to.</p> <p>1 – White list is used to determine the advertising device to connect to.</p> <p>Peer_Address_Type and Peer_Address fields are ignored when whitelist is used.</p> | |
| init_rx_addr[1] | 2 | MSB of the device's peer address type (FW programmed). This bit along with init_rx_addr[0] decides the peer address of the device. | 0 |
| rx_addr/rx_tx_addr init_rx_addr[0] | 1 | <p>Peer address type.</p> <p>The rx_addr field is updated by the receiver with the address type of the received connectable advertising packet.</p> <p>1- addr type is random. 0-addr type is public.</p> <p>LSB of the device's peer address type (FW programmed).</p> <p>Init_rx_addr[1:0] –</p> <p>0x0 – public address 0x1 – random address 0x2 – public identity address 0x3 – random(static) identity address</p> | 0 |
| Tx_addr init_tx_addr[0] | 0 | <p>Own address type.</p> <p>1 – addr type is random. 0 – addr type is public.</p> <p>LSB of the device's Own address type.</p> <p>Init_tx_addr[1:0] -</p> <p>0x0 – use public address (addr type is zero)</p> | 0 |

| Field | Bit | Description | Reset |
|-------|-----|---|-------|
| | | 0x1 – use public address (addr type is one) 0x2 – use RPA if matching entry is available in Resolving list else use public address. 0x3 – use RPA if matching entry is available in Resolving list else use random address. | |

Initiator interrupt clear register

| Addr 16-bit | Addr 32-bit | Register Name | RW | Description | Reset |
|----------------|----------------|-----------------|----|--|--------|
| 0x28 | 0x050 | INIT_INTR_CLEAR | WO | Clears the source of the interrupt. This register is written by firmware to clear interrupts set in the INIT_STATUS register. One or more interrupts can be cleared in a single write operation. | 0x0000 |

| Field | Bit | Description | Reset |
|----------------------|------|--|-------|
| Reserved | 15:5 | Not used. | XX |
| master_conn_created | 4 | Clear master connection created interrupt. Write to the register with this bit set to 1, clears the interrupt source. | 0 |
| Reserved | 3 | Not used. | X |
| Init_tx_start | 2 | Clear init transmission start interrupt. Write to the register with this bit set to 1, clears the interrupt source. | 0 |
| init_close_window | 1 | Clear Initiator scan window close interrupt. Write to the register with this bit set to 1, clears the interrupt source | 0 |
| init_interval_expire | 0 | Clear Initiator scan window start interrupt. Write to the register with this bit set to 1, clears the interrupt source | 0 |

Initiator status register

Link Layer

| Addr 16-bit | Addr 32-bit | Register Name | RW | Description | Reset |
|----------------|----------------|---------------|----|---|--------|
| 0x28 | 0x050 | INIT_STATUS | RO | Shows the status of the interrupt. This register is read by firmware to learn the pending initiator interrupts that are set and are to be served. | 0x0000 |

| Field | Bit | Description | Reset |
|----------------------|------|---|-------|
| Reserved | 15:5 | Not used. | XX |
| master_conn_created | 4 | If this bit is set it indicates connection is created as master. | 0 |
| Reserved | 3 | Not used. | X |
| Init_tx_start | 2 | If this bit is set it indicates initiator packet (CONREQ) transmission has started. | 0 |
| init_close_window | 1 | If this bit is set it indicates initiator scan window has finished. | 0 |
| init_interval_expire | 0 | If this bit is set it indicates initiator scan window has started. | 0 |

Initiator next instant register

| Addr 16-bit | Addr 32-bit | Register Name | RW | Description | Reset |
|----------------|----------------|-------------------|----|--|--------|
| 0x2A | 0x054 | INIT_NEXT_INSTANT | RO | Shows the instant with respect to internal reference clock of 625 us resolution at which next initiator scanning event begins. | 0x0000 |

| Field | Bit | Description | Reset |
|-------------------|------|---|-------|
| next_init_instant | 15:0 | Shows the instant with respect to internal reference clock at which next initiator scanning event begins. | 0 |

Initiator Anchor Point register

| Addr 16-bit | Addr 32-bit | Register Name | RW | Description | Reset |
|----------------|----------------|-----------------------|----|---|--------|
| 0x100 | 0x200 | INIT_ANCHOR_PO INT | RW | Firmware programs this register (while programming INIT parameters) with the instant (value of bt_clock) at which the initiator should start the procedure for the first time. This will give firmware a better control in effectively scheduling the new connections in the multiple connection scenarios. | 0x0000 |

| Field | Bit | Description | Reset |
|-------------------|------|--|-------|
| Init_anchor_point | 15:0 | The value of bt_clock (625 us period) at which initiator should start the procedure. | 0 |

Device Random address lower register

| Addr 16-bit | Addr 32-bit | Register Name | RW | Description | Reset |
|----------------|----------------|-----------------------|----|--|--------|
| 0x2C | 0x058 | DEV_RANDOM_ADD R_L | RW | Lower 16 bit random address of the device. | 0x0000 |

| Field | Bit | Description | Reset |
|-----------|------|--|-------|
| Rand_addr | 15:0 | Lower 16 bit of 48-bit random address of the device. | 0 |

Device Random address middle register

Link Layer

| Addr 16-bit | Addr 32-bit | Register Name | RW | Description | Reset |
|----------------|----------------|---------------------|----|---|--------|
| 0x2E | 0x05C | DEV_RAND_ADD R_M | RW | Middle 16 bit random address of the device. | 0x0000 |

| Field | Bit | Description | Reset |
|-----------|------|--|-------|
| Rand_addr | 15:0 | Middle 16 bit of 48-bit random address of the device. | 0 |

Device Random address higher register

| Addr 16-bit | Addr 32-bit | Register Name | RW | Description | Reset |
|----------------|----------------|---------------------|----|---|--------|
| 0x30 | 0x060 | DEV_RAND_ADD R_H | RW | Higher 16 bit random address of the device. | 0x0000 |

| Field | Bit | Description | Reset |
|-----------|------|--|-------|
| Rand_addr | 15:0 | Higher 16 bit of 48-bit random address of the device. | 0 |

Peer address lower register

| Addr 16-bit | Addr 32-bit | Register Name | RW | Description | Reset |
|----------------|----------------|---------------|----|--|--------|
| 0x34 | 0x068 | PEER_ADDR_L | RW | Lower 16 bit address of the peer device. | 0x0000 |

| Field | Bit | Description | Reset |
|-----------|------|---|-------|
| peer_addr | 15:0 | Lower 16-bit of 48-bit address of the peer device. | 0 |

Peer address middle register

| Addr 16-bit | Addr 32-bit | Register Name | RW | Description | Reset |
|----------------|----------------|---------------|----|---|--------|
| 0x36 | 0x06C | PEER_ADDR_M | RW | Middle 16-bit address of the peer device. | 0x0000 |

| Field | Bit | Description | Reset |
|-----------|------|---|-------|
| peer_addr | 15:0 | Middle 16-bit of 48-bit address of the peer device. | 0 |

Peer address higher register

| Addr 16-bit | Addr 32-bit | Register Name | RW | Description | Reset |
|----------------|----------------|---------------|----|---|--------|
| 0x38 | 0x070 | PEER_ADDR_H | RW | Higher 16-bit address of the peer device. | 0x0000 |

| Field | Bit | Description | Reset |
|-----------|------|--|-------|
| peer_addr | 15:0 | Higher 16-bit of 48-bit of address of the peer device. | 0 |

Initiator Peer Address Lower Register

| Addr 16-bit | Addr 32-bit | Register Name | RW | Description | Reset |
|----------------|----------------|------------------|----|--|--------|
| 0x66 | 0x0CC | INIT_PEER_ADDR_L | RW | Lower 16-bit of init peer address. This register is used only if multiple connections are supported. | 0x0000 |

| Field | Bit | Description | Reset |
|----------------|------|---|-------|
| init_peer_addr | 15:0 | Lower 16-bit of the 48-bit init peer address. | 0 |

Initiator Peer Address Middle Register

Link Layer

| Addr 16-bit | Addr 32-bit | Register Name | RW | Description | Reset |
|----------------|----------------|------------------|----|---|--------|
| 0x68 | 0x0D0 | INIT_PEER_ADDR_M | RW | Middle 16-bit of init peer address. This register is used only if multiple connections are supported. | 0x0000 |

| Field | Bit | Description | Reset |
|----------------|------|--|-------|
| Init_peer_addr | 15:0 | Middle 16-bit of the 48 bit init peer address. | 0 |

Initiator Peer Address Upper Register

| Addr 16-bit | Addr 32-bit | Register Name | RW | Description | Reset |
|----------------|----------------|------------------|----|--|--------|
| 0x6A | 0x0D4 | INIT_PEER_ADDR_H | RW | Lower 16-bit of init peer address. This register is used only if multiple connections are supported. | 0x0000 |

| Field | Bit | Description | Reset |
|----------------|------|---|-------|
| Init_peer_addr | 15:0 | Upper 16-bit of the 48-bit init peer address. | 0 |

The peer address registers are used for multiple purposes. The register is written by firmware to provide the peer address to be used for a hardware procedure. When firmware reads the register, it reads back peer address values updated by hardware.

While doing directed Advertising, the firmware writes the peer address of the device specified by the `Direct_Address` parameter of the `LE_Set_Advertising_Parameters` command.

While device is configured as an initiator without white list filtering, the peer address specified in the `peer_address` field of the create connection command is programmed into this register, which is used by hardware procedures.

While device is configured as an initiator and white list is enabled, firmware can read this register to get the address of the peer device from which connectable ADV packet was received and to which the connection is created.

When a connection is created as a slave, the firmware can read this register to get the address of the peer device to which connection is created.

INIT_PEER_ADDR is used only for multiple connection support where peer address for initiation is kept at INIT_PEER_ADDR register and ADV peer address is kept/read from PEER_ADDR register.

White List address type register

| Addr 16-bit | Addr 32-bit | Register Name | RW | Description | Reset |
|----------------|----------------|---------------|----|---|--------|
| 0x3C | 0x078 | WL_ADDR_TYPE | RW | Stores the address type of the device addresses stored in whitelist | 0x0000 |

| Field | Bit | Description | Reset |
|----------|------|---|-------|
| Reserved | 15:8 | Reserved | 0 |
| type | 7:0 | 8 address type bits corresponding to the device address stored. 1 – Address type is random. 0 – Address type is public. | 0 |

White list enable register

| Addr 16-bit | Addr 32-bit | Register Name | RW | Description | Reset |
|----------------|----------------|---------------|----|---|--------|
| 0x3E | 0x7C | WL_ENABLE | RW | Stores the valid entry bit corresponding to each of the device address stored in the whitelist. | 0x0000 |

| Field | Bit | Description | Reset |
|----------|------|-------------------------|-------|
| Reserved | 15:8 | Reserved for future use | |

Table continues on the next page...

Link Layer

| Field | Bit | Description | Reset |
|-------|-----|---|-------|
| en | 7:0 | Stores the valid entry bit corresponding to each of the eight device addresses stored in the whitelist memory in the hardware. 1 – White list entry is valid. 0 – White list entry invalid. | 0 |

Advertising data transmit FIFO

| Addr 16-bit | Addr 32-bit | Register Name | RW | Description | Reset |
|----------------|----------------|------------------|----|---|--------|
| 0x70 | 0x0E0 | ADV_TX_DATA_FIFO | WO | IO mapped FIFO of depth 16 (2 byte wide), to store ADV data of maximum length 31 bytes for transmitting. Firmware writes consecutive words by writing to the same address location. | 0x0000 |

| Field | Bit | Description | Reset |
|-------|------|------------------------------------|-------|
| data | 15:0 | Advertising data for transmission. | 0 |

Adv scan response data transmit FIFO

| Addr 16-bit | Addr 32-bit | Register Name | RW | Description | Reset |
|----------------|----------------|---------------------|----|---|--------|
| 0x74 | 0x0E8 | ADV_SCN_RSP_TX_FIFO | WO | IO mapped FIFO of depth 16 (2 byte wide), to store scan response data of maximum length 31 bytes for transmitting. Firmware writes consecutive words by writing to the same location. | 0x0000 |

| Field | Bit | Description | Reset |
|-------|------|--------------------------------------|-------|
| data | 15:0 | scan response data for transmission. | 0 |

NOTE

ADV_TX_DATA_FIFO and ADV_SCN_RSP_TX_FIFO shares same physical FIFO of depth 32. 16 locations for each FIFO are allocated.

| | | |
|---------------------------------------|--------------|-----------------------------------|
| ADV_TX_DATA_FIFO address 16'h70 | Data byte 1 | Length of adv host data |
| Data byte 3 | Data byte 2 | Length of scan response host data |
| Data byte 31 | Data byte 30 | |
| ADV_SCN_RSP_TX_FIFO address 16'h74 | Data byte 1 | |
| Data byte 3 | Data byte 2 | Length of scan response host data |
| Data byte 31 | Data byte 30 | |

The length of the payload combined with first payload data and loaded to the advertise channel data transmit FIFO followed by rest of the host data.

Example: Structure of advertising channel transmit FIFO.

bit15 bit8 bit7 bit0

| [15:8] | [7:0] |
|-------------|--------------------------------------|
| Data byte 1 | Length of the payload stored in FIFO |
| Data byte 3 | Data byte 2 |
| Data byte 5 | Data byte 4 |
| Data byte 7 | Data byte 6 |

Conn request data Transmit FIFO

| Addr 16-bit | Addr 32-bit | Register Name | RW | Description | Reset |
|----------------|----------------|------------------|----|---|--------|
| 0x78 | 0x0F0 | CONN_REQ_TX_FIFO | WO | IO mapped FIFO of depth 48, to store connection request data of maximum length 34 bytes for transmitting. | 0x0000 |

Link Layer

| Field | Bit | Description | Reset |
|-------|------|--|-------|
| Data | 15:0 | Connection request data during transmit operation. | 0 |

Adv scan response data receive FIFO

| Addr 16-bit | Addr 32-bit | Register Name | RW | Description | Reset |
|----------------|----------------|----------------------|----|--|--------|
| 0x7C | 0x0F8 | INIT_SCN_ADV_RX_FIFO | RO | IO mapped FIFO of depth 64, to store ADV and SCAN_RSP header and payload received by the scanner. The RSSI value at the time of reception of this packet is also stored. Firmware reads from the same address to read out consecutive words of data. | 0x0000 |

| Field | Bit | Description | Reset |
|-------|------|---|-------|
| Data | 15:0 | adv, scan response data during receive operation. | 0 |

NOTE

The 16 bit header is first loaded to the advertise channel data receive FIFO followed by the payload data and then 16 bit RSSI.

Example: Structure of advertising channel receives FIFO with payload with even number of bytes.

| [15:8] | [7:0] |
|-------------|-------------|
| Header 2 | Header 1 |
| Data byte 2 | Data byte 1 |
| Data byte 4 | Data byte 3 |
| Data byte 6 | Data byte 5 |
| RSSI | RSSI |

Example: Structure of advertising channel receive FIFO with payload with odd number of bytes.

| [15:8] | [7:0] |
|-------------|-------------|
| Header 2 | Header 1 |
| Data byte 2 | Data byte 1 |
| Data byte 4 | Data byte 3 |
| | Data byte 5 |
| RSSI | RSSI |

Device public address lower register

| Addr 16-bit | Addr 32-bit | Register Name | RW | Description | Reset |
|----------------|----------------|----------------|----|--|--------|
| 0XE0 | 0X1C0 | DEV_PUB_ADDR_L | RW | Lower 16 bit public address of the device. | 0x3412 |

| Field | Bit | Description | Reset |
|-------------|------|--|--------|
| public_addr | 15:0 | Lower 16-bit of 48-bit public address of the device. | 0x3412 |

Device public address middle register

| Addr 16-bit | Addr 32-bit | Register Name | RW | Description | Reset |
|----------------|----------------|----------------|----|---|--------|
| 0XE2 | 0X1C4 | DEV_PUB_ADDR_M | RW | Middle 16-bit public address of the device. | 0x0056 |

| Field | Bit | Description | Reset |
|-------------|------|---|--------|
| public_addr | 15:0 | Middle 16-bit of 48-bit public address of the device. | 0x0056 |

Device public address higher register

Link Layer

| Addr 16-bit | Addr 32-bit | Register Name | RW | Description | Reset |
|----------------|----------------|----------------|----|---|--------|
| 0XE4 | 0X1C8 | DEV_PUB_ADDR_H | RW | Higher 16-bit public address of the device. | 0x0000 |

| Field | Bit | Description | Reset |
|-------------|------|--|-------|
| public_addr | 15:0 | Higher 16-bit of 48-bit public address of the peer device. | 0 |

Advertising channel transmit power register

| Addr 16-bit | Addr 32-bit | Register Name | RW | Description | Reset |
|----------------|----------------|-----------------|----|---|--------|
| 0XE6 | 0X1CC | ADV_CH_TX_POWER | RW | <p>The advertising channel transmit power register sets the transmit power level used for LE advertising channel packets and for <u>DTM mode transmissions</u>.</p> <p>The same register is used for setting Transmit power level of all non-connection channels. This includes: Advertising, scanning, Initiating, and Direct test mode (DTM Transmitter tests).</p> | 0x874F |

| Field | Bit | Description | Reset |
|--------------------|-----|--|--------|
| adv_transmit_power | 5:0 | <p>Size: 1 Octet (signed integer)</p> <p>Range: $-20 \leq N \leq 10$</p> <p>Units: dBm</p> <p>Accuracy: +/- 4 dBm in general.</p> <p>In implementation this is a radio specific value. Only the lower 6 bits are used in this device.</p> | 0x874F |

Offset to first instant register

| Addr 16-bit | Addr 32-bit | Register Name | RW | Description | Reset |
|----------------|----------------|----------------------------|----|--|--------|
| 0XE8 | 0X1D0 | OFFSET_TO_FIR T_INSTANT | RW | <p>Offset to the first instant register. The first event instant is determined by firmware based on other procedures which may be on with various intervals, so as to not overlap on the existing procedure instants. For this, firmware determines the offset to the first instant from the current clock and programs the offset in OFFSET_TO_FIR T_INSTANT register.</p> <p>Unit is in time slots of 625 us</p> <p>For example if current clock value is 0004, and offset is 0008, then first event will begin when clock value becomes 000c.</p> | 0x0006 |

| Field | Bit | Description | Reset |
|-----------------------|------|--|--------|
| offset_to_first_event | 15:0 | <p>The offset with respect to the internal reference clock at which instant the first event occurs.</p> <p>This register will give flexibility to the firmware to position the connection at a desired point with respect to the internal free running clock. It is optional to be updated by firmware. This is not updated in the current firmware. This is for future use.</p> | 0x0006 |

Advertiser configuration register

| Addr 16-bit | Addr 32-bit | Register Name | RW | Description | Reset |
|----------------|----------------|---------------|----|--|--------|
| 0xEA | 0x1D4 | ADV_CONFIG | RW | Advertiser procedure configuration register. Firmware sets the configuration parameters to this register before issuing start adv command. | 0x20FF |

| Field | Bit | Description | Reset |
|--------------------|-------|--|--------|
| adv_pkt_interval | 15:11 | Time between the beginnings of two consecutive advertising PDU's. Time = N * 625 us Time Range: <=10 ms | 00100b |
| Reserved | 10:9 | Not used. | 0 |
| Adv_rand_disable | 8 | Disable randomization of adv interval. When disabled, interval is same as programmed in adv_interval register. | 0 |
| adv_timeout_en | 7 | Enable adv_timeout interrupt. Applicable in adv_direct_ind advertising. | 1 |
| slv_connected_en | 6 | Enable slave connected interrupt. | 1 |
| adv_conn_req_rx_en | 5 | Enable connect request packet received interrupt. | 1 |
| adv_scn_req_rx_en | 4 | Enable scan request packet received interrupt. | 1 |
| scn_tx_en | 3 | Enable scan response packet transmitted interrupt. | 1 |
| adv_tx_en | 2 | Enable adv packet transmitted interrupt. | 1 |
| adv_cls_en | 1 | Enable advertising event stop interrupt. | 1 |
| adv_strt_en | 0 | Enable advertising event start interrupt. | 1 |

Scan configuration register

| Addr 16-bit | Addr 32-bit | Register Name | RW | Description | Reset |
|----------------|----------------|---------------|----|---|--------|
| 0xEC | 0x1D8 | SCAN_CONFIG | RW | Scanner procedure configuration register. Firmware sets the configuration parameters to this register before issuing start scan command | 0xE07F |

| Field | Bit | Description | Reset |
|------------------|-------|---|-------|
| scan_channel_map | 15:13 | Advertising channels that are enabled for scanning operation. 15 – Enables channel 39 for use. 14 – Enables channel 38 for use. 13 – Enables channel 37 for use. | 111 |
| Reserved | 12 | Not used. | X |
| backoff_enable | 11 | Enable random backoff feature in scanner. 1 – enable. 0 – disable. | 0 |
| Reserved | 10:5 | Not used | XX |
| scn_rsp_rx_en | 4 | Enable scan_rsp packet received interrupt. | 1 |
| adv_rx_en | 3 | Enable adv packet received interrupt. | 1 |
| scn_tx_en | 2 | Enable scan request packet transmitted interrupt. | 1 |
| scn_close_en | 1 | Enable scan event close interrupt. | 1 |
| scn_strt_en | 0 | Enable scan event start interrupt. | 1 |

Initiator configuration register

| Addr 16-bit | Addr 32-bit | Register Name | RW | Description | Reset |
|----------------|----------------|---------------|----|--|--------|
| 0xEE | 0x1DC | INIT_CONFIG | RW | Initiator procedure configuration register. Firmware | 0x0000 |

Link Layer

| Addr 16-bit | Addr 32-bit | Register Name | RW | Description | Reset |
|----------------|----------------|---------------|----|---|-------|
| | | | | sets the configuration parameters to this register before issuing create connection command | |

| Field | Bit | Description | Reset |
|------------------|-------|---|-------|
| init_channel_map | 15:13 | Advertising channels that are enabled for initiator scanning operation. 15 – Enables channel 39 for use. 14 – Enables channel 38 for use. 13 – Enables channel 37 for use. | 0 |
| Reserved | 12:8 | Not used | XX |
| conn_created | 4 | Enable master connection created interrupt | 0 |
| Reserved | 3 | Reserved | |
| conn_req_tx_en | 2 | Enables connection request packet transmission start interrupt. | 0 |
| init_close_en | 1 | Enable Initiator scan window close interrupt. | 0 |
| init_strt_en | 0 | Enable Initiator scan window start interrupt. | 0 |

Whitelist base address register

| Addr 16-bit | Addr 32-bit | Register Name | RW | Description | Reset |
|----------------|----------------|---------------------|----|---|--------|
| 0X1A0 | 0X340 | WHITELIST_BASE_ADDR | RW | It is the starting address of white list memory which holds the white listed device address. For a 48 bit device address, three writes of 16 bits is required at the | 0x0000 |

| Addr 16-bit | Addr 32-bit | Register Name | RW | Description | Reset |
|----------------|----------------|---------------|----|---|-------|
| | | | | <p>appropriate offset from this base address.</p> <p>The whitelist device addresses are stored as group of 3-words at offset of $N*3$, where $N=0$ to 7, from this base address.</p> <p>While writing the device address, the firmware writes the address in the following order for storage.</p> <p>1st write – [15:0], 2nd write – [31:16], 3rd write – [47:32] bits of the device address.</p> | |

| Field | Bit | Description | Reset |
|-------------|------|--|-------|
| Device_addr | 15:0 | Device address values written to white list memory are written as 16-bit wide address. | 0 |

Whitelist end address register

| Addr 16-bit | Addr 32-bit | Register Name | RW | Description | Reset |
|----------------|----------------|--------------------|----|---|--------|
| 0X1D0 | 0X3A0 | WHITELIST_END_ADDR | RW | It is the last address of white list memory which holds the white list device address. It holds last [47:32] bits of 8th white list device address. It is not accessed by firmware, only used for hardware reference. | 0x0000 |

Link Layer

| Field | Bit | Description | Reset |
|-------------|------|--|-------|
| Device_addr | 15:0 | Device address values written to white list memory are written as 16-bit wide address. | 0 |

Advertiser Tx memory base address register – Reserved for future use

| Addr 16-bit | Addr 32-bit | Register Name | RW | Description | Reset |
|----------------|----------------|----------------------|----|--|--------|
| 0X160 | 0X2C0 | ADV_TX_MEM_BASE_ADDR | RW | It is the starting address of ADV Tx memory which holds the data to be transmitted during Advertising operation. | 0x0000 |

| Field | Bit | Description | Reset |
|-------|------|---|-------|
| Data | 15:0 | Data values written to Tx memory are written as 16-bit wide data. | 0 |

Connection Tx memory base address register

| Addr 16-bit | Addr 32-bit | Register Name | RW | Description | Reset |
|----------------|----------------|----------------------|----|--|--------|
| 0X800 | 0X1000 | CONN_TXMEM_BASE_ADDR | WO | It is the starting address of Connection Transmit data memory which holds the data to be transmitted during connection. The connection Transmit memory is individually addressable location for firmware. So firmware writes to consecutive even address values to write the next word (2-byte) of data. Hardware accesses this memory as a | 0x0000 |

| Addr 16-bit | Addr 32-bit | Register Name | RW | Description | Reset |
|----------------|----------------|---------------|----|---|-------|
| | | | | FIFO. The hardware buffer index is managed in hardware. No buffer index needs to be maintained for firmware access. | |

| Field | Bit | Description | Reset |
|-------|------|---|-------|
| Data | 15:0 | Data values written to Tx memory are written as 16-bit wide data. | 0 |

Connection Rx memory base address register

| Addr 16-bit | Addr 32-bit | Register Name | RW | Description | Reset |
|----------------|----------------|----------------------|----|---|--------|
| 0X400 | 0X800 | CONN_RXMEM_BASE_ADDR | RO | It is the starting address of Connection Receive data memory/FIFO which holds the data to be received during connection. The connection receive memory/FIFO is used as a FIFO by both hardware and firmware. Firmware needs to read from the same address to read out the consecutive words in the FIFO. | 0x0000 |

| Field | Bit | Description | Reset |
|-------|------|--|-------|
| Data | 15:0 | Data values read from Rx memory are read as 16-bit wide data | 0 |

Conn_req_word0 register

Link Layer

| Addr 16-bit | Addr 32-bit | Register Name | RW | Description | Reset |
|----------------|----------------|--------------------|----|---|--------|
| 0x1E0 | 0x3C0 | CONN_REQ_WOR D0 | RW | The connect request word0 register must be programmed with the access address value of the connect request packet, before initiating connection. After slave connection this value can be obtained by reading this register on the advertiser side. | 0x0000 |

| Field | Bit | Description | Reset |
|-------------------|------|---|--------|
| Access_addr[15:0] | 15:0 | This field defines the lower 16 bits of the access address that is to be sent in the connect request packet of the initiator. | 0x0000 |

Conn_req_word1 register

| Addr 16-bit | Addr 32-bit | Register Name | RW | Description | Reset |
|----------------|----------------|--------------------|----|---|--------|
| 0x1E2 | 0x3C4 | CONN_REQ_WOR D1 | RW | The connect request word1 register must be programmed with the access address value of the connect request packet, before initiating connection. After slave connection this value can be obtained by reading this register on the advertiser side. | 0x0000 |

| Field | Bit | Description | Reset |
|-----------------------|------|--|--------|
| Access_Address[31:16] | 15:0 | This field defines the upper 16 bits of the access address that is to be sent in the | 0x0000 |

| Field | Bit | Description | Reset |
|-------|-----|--|-------|
| | | connect request packet of the initiator. | |

Conn_req_word2 register

| Addr 16-bit | Addr 32-bit | Register Name | RW | Description | Reset |
|----------------|----------------|--------------------|----|--|--------|
| 0x1E4 | 0x3C8 | CONN_REQ_WOR D2 | RW | This field defines the lower byte[7:0] of the CRC initialization value, and tx_window_size[7:0], to be sent in the connect request packet of the initiator. After slave connection these values can be obtained by reading this register on the advertiser side. | 0x0000 |

| Field | Bit | Description | Reset |
|---------------------|------|--|-------|
| crc_init[7:0] | 15:8 | This field defines the lower byte[7:0] of the CRC initialization value. | 0 |
| Tx_window_size[7:0] | 7:0 | window_size along with the window_offset is used to calculate the first connection point anchor point for the master. This shall be a multiple of 1.25 ms in the range of 1.25 ms to the lesser of 10 ms and (connInterval – 1.25 ms). Values range from 0 to 10 ms. | 0 |

Conn_req_word3 register

| Addr 16-bit | Addr 32-bit | Register Name | RW | Description | Reset |
|----------------|----------------|--------------------|----|--|--------|
| 0x1E6 | 0x3CC | CONN_REQ_WOR D3 | RW | This field must be programmed with the upper byte [23:8] of the CRC initialization | 0x0000 |

Link Layer

| Addr 16-bit | Addr 32-bit | Register Name | RW | Description | Reset |
|----------------|----------------|---------------|----|---|-------|
| | | | | value. After slave connection this value can be obtained by reading this register on the advertiser side. | |

| Field | Bit | Description | Reset |
|----------------|------|---|--------|
| crc_init[23:8] | 15:0 | This field defines the upper byte [23:8] of the CRC initialization value that is to be sent in the connect request packet of the initiator. | 0x0000 |

Conn_req_word4 register

| Addr 16-bit | Addr 32-bit | Register Name | RW | Description | Reset |
|----------------|----------------|----------------|----|--|--------|
| 0x1E8 | 0x3D0 | CONN_REQ_WORD4 | RW | This field defines the 16 bits of the transmit window offset that is to be sent in the connect request packet of the initiator. After slave connection this value can be obtained by reading this register on the advertiser side. | 0x0000 |

| Field | Bit | Description | Reset |
|------------------|------|---|-------|
| Tx_window_offset | 15:0 | This is used to determine the anchor point for the master transmission. Range: This shall be a multiple of 1.25 ms in the range of 0 ms to connInterval value. | 0 |

Conn_req_word5 register

| Addr 16-bit | Addr 32-bit | Register Name | RW | Description | Reset |
|----------------|----------------|--------------------|----|---|--------|
| 0x1EA | 0x3D4 | CONN_REQ_WOR D5 | RW | This field defines the 16 bits of the connection interval value that is to be sent in the connect request packet of the initiator. After slave connection this value can be obtained by reading this register on the advertiser side. | 0x0000 |

| Field | Bit | Description | Reset |
|-------------------|------|---|--------|
| Conn_interval_val | 15:0 | The value configured in this register determines the spacing between the connection events. This shall be a multiple of 1.25 ms in the range of 7.5 ms to 4.0 s. | 0x0000 |

Conn_req_word6 register

| Addr 16-bit | Addr 32-bit | Register Name | RW | Description | Reset |
|----------------|----------------|--------------------|----|---|--------|
| 0x1EC | 0x3D8 | CONN_REQ_WOR D6 | RW | This field defines the 16 bits of the slave latency value that is to be sent in the connect request packet of the initiator. After slave connection this value can be obtained by reading this register on the advertiser side. | 0x0000 |

| Field | Bit | Description | Reset |
|-----------------|------|---|--------|
| Slv_latency_val | 15:0 | The value configured in this field defines the number of consecutive connection events that the slave device is not required to listen for master. The value of connSlaveLatency should not | 0x0000 |

Link Layer

| Field | Bit | Description | Reset |
|-------|-----|--|-------|
| | | cause a Supervision Timeout. This shall be an integer in the range of 0 to $((\text{connSupervision Timeout}/\text{connInterval})-1)$. connSlaveLatency shall also be less than 500. | |

Conn_req_word7 register

| Addr 16-bit | Addr 32-bit | Register Name | RW | Description | Reset |
|----------------|----------------|--------------------|----|---|--------|
| 0x1EE | 0x3DC | CONN_REQ_WOR D7 | RW | This field defines the 16 bits of the supervision timeout value that is to be sent in the connect request packet of the initiator. After slave connection this value can be obtained by reading this register on the advertiser side. | 0x0000 |

| Field | Bit | Description | Reset |
|------------|------|---|--------|
| Sup_to_val | 15:0 | This field defines the maximum time between two received Data packet PDUs before the connection is considered lost. This shall be a multiple of 10 ms in the range of 100 ms to 32.0 s and it shall be larger than $(1+\text{connSlaveLatency}) * \text{connInterval}$. | 0x0000 |

Conn_req_word8 register

| Addr 16-bit | Addr 32-bit | Register Name | RW | Description | Reset |
|----------------|----------------|--------------------|----|---|--------|
| 0x1F0 | 0x3E0 | CONN_REQ_WOR D8 | RW | This field defines the channel map for channels [15:0], that is to be sent in the connect request packet of the | 0x0000 |

| Addr 16-bit | Addr 32-bit | Register Name | RW | Description | Reset |
|----------------|----------------|---------------|----|---|-------|
| | | | | initiator. After slave connection this value can be obtained by reading this register on the advertiser side. | |

| Field | Bit | Description | Reset |
|---------------------|------|--|---------------|
| Data_channels[15:0] | 15:0 | This register field indicates which of the data channels are in use. This stores the information for the lower 16 (15:0) data channel indices. 1 – indicates the corresponding data channel is used 0 – indicates the channel is unused. | Data_channels |

Conn_req_word9 register

| Addr 16-bit | Addr 32-bit | Register Name | RW | Description | Reset |
|----------------|----------------|--------------------|----|--|--------|
| 0x1F2 | 0x3E4 | CONN_REQ_WOR D9 | RW | This field defines the channel map for channels [31:16], that is to be sent in the connect request packet of the initiator. After slave connection this value can be obtained by reading this register on the advertiser side. | 0x0000 |

| Field | Bit | Description | Reset |
|----------------------|------|--|---------------|
| Data_channels[31:16] | 15:0 | This register field indicates which of the data channels are in use. This stores the information for the middle 16 (31:16) data channel indices. 1 – indicates the corresponding data channel is used | Data_channels |

Link Layer

| Field | Bit | Description | Reset |
|-------|-----|--------------------------------------|-------|
| | | 0 – indicates the channel is unused. | |

Conn_req_word10 register

| Addr 16-bit | Addr 32-bit | Register Name | RW | Description | Reset |
|----------------|----------------|---------------------|----|--|--------|
| 0x1F4 | 0x3E8 | CONN_REQ_WOR D10 | RW | This field defines the channel map for channels [36:32], that is to be sent in the connect request packet of the initiator. After slave connection this value can be obtained by reading this register on the advertiser side. | 0x0000 |

| Field | Bit | Description | Reset |
|----------------------|-----|--|---------------|
| Data_channels[36:32] | 4:0 | This register field indicates which of the data channels are in use. This stores the information for the upper 5 (36:32) data channel indices. 1 – indicates the corresponding data channel is used 0 – indicates the channel is unused. | Data_channels |

Conn_req_word11 register

| Addr 16-bit | Addr 32-bit | Register Name | RW | Description | Reset |
|----------------|----------------|---------------------|----|--|--------|
| 0x1F6 | 0x3EC | CONN_REQ_WOR D11 | RW | The connect request word0 register must be programmed with Connection parameters sca, hop_increment value of the connect request packet, before initiating connection. After | 0x0000 |

| Addr 16-bit | Addr 32-bit | Register Name | RW | Description | Reset |
|----------------|----------------|---------------|----|--|-------|
| | | | | slave connection this value can be obtained by reading this register on the advertiser side. | |

| Field | Bit | Description | Reset |
|--------------------|-----|---|-------|
| Sca[2:0] | 7:5 | This field defines the sleep clock accuracies given in ppm. | 0 |
| hop_increment[4:0] | 4:0 | This field is used for the data channel selection process. | 0 |

RPA timer interval register

| Addr 16-bit | Addr 32-bit | Register Name | RW | Description | Reset |
|----------------|----------------|------------------------|----|---|--------|
| 0x582 | 0xB04 | RPA_TIMER_INTE RVAL | RW | The RPA timer interval register stores the RPA refresh time interval. (FW programmed). | 0x0000 |

| Field | Bit | Description | Reset |
|------------------------|------|---|-------|
| rpa_timer_interval_val | 15:0 | This field holds the lower value of the RPA refresh time interval in seconds. | 0 |

RPA timer interval register_U

| Addr 16-bit | Addr 32-bit | Register Name | RW | Description | Reset |
|----------------|----------------|--------------------------|----|---|--------|
| 0x58A | 0xB14 | RPA_TIMER_INTE RVAL_U | RW | The RPA timer interval register stores the RPA refresh time interval. (FW programmed). | 0x0000 |

Link Layer

| Field | Bit | Description | Reset |
|------------------------|-----|---|-------|
| rpa_timer_interval_val | 9:0 | This field holds the upper value of the RPA refresh time interval in seconds. | 0 |

Privacy Configuration register

| Addr 16-bit | Addr 32-bit | Register Name | RW | Description | Reset |
|----------------|----------------|-----------------------|----|---|--------|
| 0x108 | 0x210 | LL_PRIVACY_CO NFIG | RW | This register fields can be set to enable/disable Privacy feature in LLH. | 0x0000 |

| Field | Bit | Description | Reset |
|----------------|------|--|-------|
| Reserved | 15:1 | Reserved for future use. | 0 |
| privacy_config | 0 | Whenever this bit is set LLH will try to resolve the address for all ADVCH procedures. | 0 |

RPA selection index register

| Addr 16-bit | Addr 32-bit | Register Name | RW | Description | Reset |
|----------------|----------------|-----------------------------|----|---|-------|
| 0x10A | 0x214 | CURRENT_LOCAL _IRK_INDEX | RW | This register is programmed by firmware before advertising and Initiation procedures. This bit is used to indicate the local IRK to be used by HW during advertising and Initiation procedures. | 0xFF |

| Field | Bit | Description | Reset |
|----------|------|--------------------------|-------|
| Reserved | 15:8 | Reserved for future use. | 0 |

Table continues on the next page...

| Field | Bit | Description | Reset |
|---------------------|--|---|-------|
| cur_local_irk_index | 7:4 | This field holds the resolving list index corresponding to the IRK to be used for the INIT procedure. This field is invalid when white list is enabled. Value 0xF – valid IRK for INIT procedure is not set in resolving list. | 0xF |
| 3:0 | This field holds the resolving list index corresponding to the IRK to be used for the ADV procedure. This field is also valid when white list is enabled. Value 0xF – valid IRK for ADV procedure is not set in resolving list. | 0xF | |

Peer identity address type register

| Addr 16-bit | Addr 32-bit | Register Name | RW | Description | Reset |
|----------------|----------------|-------------------------|----|--|-------|
| 0x10C | 0x218 | PEER_IDENTITY_ADDR_TYPE | RW | This register stores the peer identity address type (Public or Random) corresponding to the IRK pair populated in the resolving list. The value is valid if the resolving list entry is valid. | 0x0 |

| Field | Bit | Description | Reset |
|-------------------|------|---|-------|
| Reserved | 15:4 | Reserved for future use. | 0 |
| peer_id_addr_type | 3:0 | Peer_id_addr_type [i] = 0/1 => ith resolving list entry corresponds to a peer whose address is public/random. | 0 |

Resolving list entry valid register

| Addr 16-bit | Addr 32-bit | Register Name | RW | Description | Reset |
|----------------|----------------|----------------|----|--------------------------------------|-------|
| 0x10E | 0x21C | RES_LIST_VALID | RW | This register is used to indicate to | 0x0 |

Link Layer

| Addr 16-bit | Addr 32-bit | Register Name | RW | Description | Reset |
|----------------|----------------|---------------|----|--|-------|
| | | | | HW which resolving list entries are valid/invalid. | |

| Field | Bit | Description | Reset |
|--------------------|------|--|-------|
| Reserved | 15:4 | Reserved for future use. | 0 |
| device_valid_entry | 3:0 | Device_valid_entry [i] = 0/1 => ith resolving list entry is invalid/valid. | 0 |

Advertising parameters 2 register

| Addr 16-bit | Addr 32-bit | Register Name | RW | Description | Reset |
|----------------|----------------|---------------|----|--|-------|
| 0x0A | 0x14 | ADV_PARAMS_2 | RW | This register stores the own address type for the Advertising procedure. | 0x0 |

| Field | Bit | Description | Reset |
|-------------|------|--|-------|
| Reserved | 15:2 | Reserved for future use. | 0 |
| adv_tx_addr | 1:0 | Device Own_address_type field. 0x0 – Own address type is public address. 0x1 – Own address type is random address. 0x2 – Own address type is RPA. If resolving list contains no matching entry, use public address. 0x3 – Own address type is RPA. If resolving list contains no matching entry, use random address. | 0 |

Local IRK 0 registers

| Addr 16-bit | Addr 32-bit | Register Name | RW | Description | Reset |
|----------------|-----------------|---------------|----|--|--|
| 0xD00 – 0xD0E | 0x1A00 – 0x1A1C | L_IRK_0_x | RW | These registers store the local IRK value for 0th resolving list entry. IRK value is of 128 bits and stored in Little Endian format (lowest address register has the LSW). | 0x0000000000000000 0000000000000000 0000 |

| Field | Bit | Description | Reset |
|-----------------|-------|---|-------|
| dev_localirk[0] | 127:0 | This field has the 128 bit value of local IRK for 0th resolving list entry. | 0 |

Local IRK 1 registers

| Addr 16-bit | Addr 32-bit | Register Name | RW | Description | Reset |
|----------------|-----------------|---------------|----|--|--|
| 0xD10 – 0xD1E | 0x1A20 – 0x1A3C | L_IRK_1_x | RW | These registers store the local IRK value for first resolving list entry. IRK value is of 128 bits and stored in Little Endian format (lowest address register has the LSW). | 0x0000000000000000 0000000000000000 0000 |

| Field | Bit | Description | Reset |
|-----------------|-------|---|-------|
| dev_localirk[1] | 127:0 | This field has the 128 bit value of local IRK for first resolving list entry. | 0 |

Local IRK 2 registers

| Addr 16-bit | Addr 32-bit | Register Name | RW | Description | Reset |
|----------------|-----------------|---------------|----|--|--|
| 0xD20 – 0xD2E | 0x1A40 – 0x1A5C | L_IRK_2_x | RW | These registers store the local IRK value for second | 0x0000000000000000 0000000000000000 0000 |

Link Layer

| Addr 16-bit | Addr 32-bit | Register Name | RW | Description | Reset |
|----------------|----------------|---------------|----|--|-------|
| | | | | resolving list entry. IRK value is of 128 bits and stored in Little Endian format (lowest address register has the LSW). | |

| Field | Bit | Description | Reset |
|-----------------|-------|--|-------|
| dev_localirk[2] | 127:0 | This field has the 128 bit value of local IRK for second resolving list entry. | 0 |

Local IRK 3 registers

| Addr 16-bit | Addr 32-bit | Register Name | RW | Description | Reset |
|----------------|-----------------|---------------|----|--|--|
| 0xD30 – 0xD3E | 0x1A60 – 0x1A7C | L_IRK_3_x | RW | These registers store the local IRK value for third resolving list entry. IRK value is of 128 bits and stored in Little Endian format (lowest address register has the LSW). | 0x0000000000000000 0000000000000000 0000 |

| Field | Bit | Description | Reset |
|-----------------|-------|---|-------|
| dev_localirk[3] | 127:0 | This field has the 128 bit value of local IRK for third resolving list entry. | 0 |

Peer IRK 0 registers

| Addr 16-bit | Addr 32-bit | Register Name | RW | Description | Reset |
|----------------|-----------------|---------------|----|---|--|
| 0xD80 – 0xD8E | 0x1B00 – 0x1B1C | P_IRK_0_x | RW | These registers store the peer IRK value for 0 th resolving list entry. IRK value is of 128 bits and stored in | 0x0000000000000000 0000000000000000 0000 |

| Addr 16-bit | Addr 32-bit | Register Name | RW | Description | Reset |
|----------------|----------------|---------------|----|---|-------|
| | | | | Little Endian format (lowest address register has the LSW). | |

| Field | Bit | Description | Reset |
|----------------|-------|--|-------|
| dev_peerirk[0] | 127:0 | This field has the 128 bit value of peer IRK for 0 th resolving list entry. | 0 |

Peer IRK 1 registers

| Addr 16-bit | Addr 32-bit | Register Name | RW | Description | Reset |
|----------------|-----------------|---------------|----|---|--|
| 0xD90 – 0xD9E | 0x1B20 – 0x1B3C | P_IRK_1_x | RW | These registers store the peer IRK value for first resolving list entry. IRK value is of 128 bits and stored in Little Endian format (lowest address register has the LSW). | 0x0000000000000000 0000000000000000 0000 |

| Field | Bit | Description | Reset |
|----------------|-------|--|-------|
| dev_peerirk[1] | 127:0 | This field has the 128 bit value of peer IRK for first resolving list entry. | 0 |

Peer IRK 2 registers

| Addr 16-bit | Addr 32-bit | Register Name | RW | Description | Reset |
|----------------|-----------------|---------------|----|---|--|
| 0xDA0 – 0xDAE | 0x1B40 – 0x1B5C | P_IRK_2_x | RW | These registers store the peer IRK value for 2 nd resolving list entry. IRK value is of 128 bits and stored in Little Endian format (lowest address register has the LSW). | 0x0000000000000000 0000000000000000 0000 |

Link Layer

| Field | Bit | Description | Reset |
|----------------|-------|--|-------|
| dev_peerirk[2] | 127:0 | This field has the 128 bit value of peer IRK for 2 nd resolving list entry. | 0 |

Peer IRK 3 registers

| Addr 16-bit | Addr 32-bit | Register Name | RW | Description | Reset |
|----------------|-----------------|---------------|----|---|--|
| 0xDB0 – 0xDBE | 0x1B60 – 0x1B7C | P_IRK_3_x | RW | These registers store the peer IRK value for 3 rd resolving list entry. IRK value is of 128 bits and stored in Little Endian format (lowest address register has the LSW). | 0x0000000000000000 0000000000000000 0000 |

| Field | Bit | Description | Reset |
|----------------|-------|--|-------|
| dev_peerirk[3] | 127:0 | This field has the 128 bit value of peer IRK for 3 rd resolving list entry. | 0 |

Peer identity address 0 registers

| Addr 16-bit | Addr 32-bit | Register Name | RW | Description | Reset |
|----------------|-----------------|------------------|----|--|----------------|
| 0xE00 – 0xE04 | 0x1C00 – 0x1C08 | PEER_ID_ADDR_0_x | RW | These registers store the peer identity address for 0 th resolving list entry. Identity address is of 48 bits and stored in Little Endian format (lowest address register has the LSW). | 0x000000000000 |

| Field | Bit | Description | Reset |
|----------------------|------|--|-------|
| dev_identity_addr[0] | 47:0 | This field has the 48 bit value of peer ID address for 0 th resolving list entry. | 0 |

Peer identity address 1 registers

| Addr 16-bit | Addr 32-bit | Register Name | RW | Description | Reset |
|----------------|-----------------|------------------|----|--|----------------|
| 0xE06 – 0xE0A | 0x1C0C – 0x1C14 | PEER_ID_ADDR_1_x | RW | These registers store the peer identity address for 1 st resolving list entry. Identity address is of 48 bits and stored in Little Endian format (lowest address register has the LSW). | 0x000000000000 |

| Field | Bit | Description | Reset |
|----------------------|------|--|-------|
| dev_identity_addr[1] | 47:0 | This field has the 48 bit value of peer ID address for 1 st resolving list entry. | 0 |

Peer identity address 2 registers

| Addr 16-bit | Addr 32-bit | Register Name | RW | Description | Reset |
|----------------|-----------------|------------------|----|--|----------------|
| 0xE0C – 0xE10 | 0x1C18 – 0x1C20 | PEER_ID_ADDR_2_x | RW | These registers store the peer identity address for 2 nd resolving list entry. Identity address is of 48 bits and stored in Little Endian format (lowest address register has the LSW). | 0x000000000000 |

| Field | Bit | Description | Reset |
|----------------------|------|--|-------|
| dev_identity_addr[2] | 47:0 | This field has the 48 bit value of peer ID address for 2 nd resolving list entry. | 0 |

Peer identity address 3 registers

Link Layer

| Addr 16-bit | Addr 32-bit | Register Name | RW | Description | Reset |
|----------------|-----------------|------------------|----|--|----------------|
| 0xE12 – 0xE16 | 0x1C24 – 0x1C2C | PEER_ID_ADDR_3_x | RW | These registers store the peer identity address for 3 rd resolving list entry. Identity address is of 48 bits and stored in Little Endian format (lowest address register has the LSW). | 0x000000000000 |

| Field | Bit | Description | Reset |
|----------------------|------|--|-------|
| dev_identity_addr[3] | 47:0 | This field has the 48 bit value of peer ID address for 3 rd resolving list entry. | 0 |

Local RPA 0 registers

| Addr 16-bit | Addr 32-bit | Register Name | RW | Description | Reset |
|----------------|-----------------|---------------|----|--|----------------|
| 0xE30 – 0xE34 | 0x1C60 – 0x1C68 | L_RPA_0_x | RO | These registers store the local RPA generated by the HW using the local IRK of the 0 th resolving list entry. RPA is of 48 bits and stored in Little Endian format (lowest address register has the LSW). | 0x000000000000 |

| Field | Bit | Description | Reset |
|-----------------|------|--|-------|
| self_rpa_list_0 | 47:0 | This field has the 48 bit value of local RPA for 0 th resolving list entry. | 0 |

Local RPA 1 registers

| Addr 16-bit | Addr 32-bit | Register Name | RW | Description | Reset |
|----------------|-----------------|---------------|----|-------------------------------------|----------------|
| 0xE36 – 0xE3A | 0x1C6C – 0x1C74 | L_RPA_1_x | RO | These registers store the local RPA | 0x000000000000 |

| Addr 16-bit | Addr 32-bit | Register Name | RW | Description | Reset |
|----------------|----------------|---------------|----|--|-------|
| | | | | generated by the HW using the local IRK of the 1 st resolving list entry. RPA is of 48 bits and stored in Little Endian format (lowest address register has the LSW). | |

| Field | Bit | Description | Reset |
|-----------------|------|--|-------|
| self_rpa_list_1 | 47:0 | This field has the 48 bit value of local RPA for 1 st RESOLVING LIST entry. | 0 |

Local RPA 2 registers

| Addr 16-bit | Addr 32-bit | Register Name | RW | Description | Reset |
|----------------|-----------------|---------------|----|--|----------------|
| 0xE3C – 0xE40 | 0x1C78 – 0x1C80 | L_RPA_2_x | RO | These registers store the local RPA generated by the HW using the local IRK of the 2 nd RESOLVING LIST entry. RPA is of 48 bits and stored in Little Endian format (lowest address register has the LSW). | 0x000000000000 |

| Field | Bit | Description | Reset |
|-----------------|------|--|-------|
| self_rpa_list_2 | 47:0 | This field has the 48 bit value of local RPA for 2 nd RESOLVING LIST entry. | 0 |

Local RPA 3 registers

| Addr 16-bit | Addr 32-bit | Register Name | RW | Description | Reset |
|----------------|-----------------|---------------|----|--|----------------|
| 0xE42 – 0xE46 | 0x1C84 – 0x1C8C | L_RPA_3_x | RO | These registers store the local RPA generated by the | 0x000000000000 |

Link Layer

| Addr 16-bit | Addr 32-bit | Register Name | RW | Description | Reset |
|----------------|----------------|---------------|----|---|-------|
| | | | | HW using the local IRK of the 3 rd resolving list entry. RPA is of 48 bits and stored in Little Endian format (lowest address register has the LSW). | |

| Field | Bit | Description | Reset |
|-----------------|------|--|-------|
| self_rpa_list_3 | 47:0 | This field has the 48 bit value of local RPA for 3 rd RESOLVING LIST entry. | 0 |

Peer RPA 0 registers

| Addr 16-bit | Addr 32-bit | Register Name | RW | Description | Reset |
|----------------|-----------------|---------------|----|--|----------------|
| 0xE60 – 0xE64 | 0x1CC0 – 0x1CC8 | P_RPA_0_x | RO | These registers store the peer RPA generated by the HW using the peer IRK of the 0 th resolving list entry. RPA is of 48 bits and stored in Little Endian format (lowest address register has the LSW). | 0x000000000000 |

| Field | Bit | Description | Reset |
|-----------------|------|---|-------|
| peer_rpa_list_0 | 47:0 | This field has the 48 bit value of peer RPA for 0 th resolving list entry. | 0 |

Peer RPA 1 registers

| Addr 16-bit | Addr 32-bit | Register Name | RW | Description | Reset |
|----------------|-----------------|---------------|----|---|----------------|
| 0xE66 – 0xE6A | 0x1CCC – 0x1CD4 | P_RPA_1_x | RO | These registers store the peer RPA generated by the HW using the peer | 0x000000000000 |

| Addr 16-bit | Addr 32-bit | Register Name | RW | Description | Reset |
|----------------|----------------|---------------|----|--|-------|
| | | | | IRK of the 1 st resolving list entry. RPA is of 48 bits and stored in Little Endian format (lowest address register has the LSW). | |

| Field | Bit | Description | Reset |
|-----------------|------|---|-------|
| peer_rpa_list_1 | 47:0 | This field has the 48 bit value of peer RPA for 1 st resolving list entry. | 0 |

Peer RPA 2 registers

| Addr 16-bit | Addr 32-bit | Register Name | RW | Description | Reset |
|----------------|-----------------|---------------|----|--|----------------|
| 0xE6C-0xE70 | 0x1CD8 – 0x1CE0 | P_RPA_2_x | RO | These registers store the peer RPA generated by the HW using the peer IRK of the 2 nd resolving list entry. RPA is of 48 bits and stored in Little Endian format (lowest address register has the LSW). | 0x000000000000 |

| Field | Bit | Description | Reset |
|-----------------|------|---|-------|
| peer_rpa_list_2 | 47:0 | This field has the 48 bit value of peer RPA for 2 nd resolving list entry. | 0 |

Peer RPA 3 registers

| Addr 16-bit | Addr 32-bit | Register Name | RW | Description | Reset |
|----------------|-----------------|---------------|----|--|----------------|
| 0xE72-0xE76 | 0x1CE4 – 0x1CEC | P_RPA_3_x | RO | These registers store the peer RPA generated by the HW using the peer IRK of the 3 rd | 0x000000000000 |

Link Layer

| Addr 16-bit | Addr 32-bit | Register Name | RW | Description | Reset |
|----------------|----------------|---------------|----|---|-------|
| | | | | resolving list entry. RPA is of 48 bits and stored in Little Endian format (lowest address register has the LSW). | |

| Field | Bit | Description | Reset |
|-----------------|------|---|-------|
| peer_rpa_list_3 | 47:0 | This field has the 48 bit value of peer RPA for 3 rd resolving list entry. | 0 |

RPA timer wrap count register

| Addr 16-bit | Addr 32-bit | Register Name | RW | Description | Reset |
|----------------|----------------|----------------------|----|--|-------|
| 0x586 | 0xB0C | RPA_TIMER_WRAP_COUNT | RO | The RPA timer wrap count register stores the wrap count value. A wrap is a complete bt_clock roll from 0x0000 to 0xFFFF. | 0x0 |

| Field | Bit | Description | Reset |
|----------------------|-------|---|-------|
| Reserved | 15:10 | Not used | 0 |
| rpa_timer_wrap_count | 9:0 | This field holds the bt_clock wrap count value. | 0 |

RPA timer current wrap register

| Addr 16-bit | Addr 32-bit | Register Name | RW | Description | Reset |
|----------------|----------------|------------------------|----|--|-------|
| 0x584 | 0xB08 | RPA_TIMER_CURRENT_WRAP | RO | The RPA timer current wrap register stores the current wrap count value. | 0x0 |

| Field | Bit | Description | Reset |
|------------------------|-------|--|-------|
| Reserved | 15:12 | Not used | 0 |
| rpa_timer_current_wrap | 11:2 | This field holds RPA timer's current wrap count value. | 0 |
| rpa_timer_en | 1 | Indicates whether RPA timer is ON in hardware. 1 – on 0 – off | 0 |
| wrap_valid | 0 | Indicates whether RPA timer's wrap is valid. 1 – wrap is valid 0 – wrap is invalid | 0 |

RPA timer next instant register

| Addr 16-bit | Addr 32-bit | Register Name | RW | Description | Reset |
|----------------|----------------|------------------------|----|---|-------|
| 0x588 | 0xB10 | RPA_TIMER_NEXT_INSTANT | RO | Holds the next RPA timer instant value. | 0x0 |

| Field | Bit | Description | Reset |
|------------------------|-------|--|-------|
| Reserved | 15:10 | Not used | 0 |
| rpa_timer_next_instant | 9:0 | Holds the next RPA timer instant value. This instant is valid when wrap valid = 1. | 0 |

45.6.1.1.3 Data Channel Registers

Data Channel Register Descriptions for the Bluetooth Link Layer

Transmit window offset register

| Addr 16-bit | Addr 32-bit | Register Name | RW | Description | Reset |
|----------------|----------------|------------------------|----|--|--------|
| 0x40 | 0x080 | TRANSMIT_WINDOW_OFFSET | RW | Stores the transmit window offset parameter used during connection setup and connection update procedures. | 0x0000 |

Link Layer

| | | | | | |
|--|--|--|--|---|--|
| | | | | The register is updated by hardware when device is slave. | |
|--|--|--|--|---|--|

| Field | Bit | Description | Reset |
|---------------|------|---|-------|
| window_offset | 15:0 | This is used to determine the first anchor point for the master transmission, from the time of connection creation. Range: This shall be a multiple of 1.25 ms in the range of 0 ms to connInterval value. | 0 |

Transmit window size register

| Addr 16-bit | Addr 32-bit | Register Name | RW | Description | Reset |
|----------------|----------------|----------------------|----|--|--------|
| 0x42 | 0x084 | TRANSMIT_WINDOW_SIZE | RW | Stores the transmit window size parameter used during connection setup and connection update procedures. The register is updated by hardware when device is slave. | 0x0000 |

| Field | Bit | Description | Reset |
|-------------|-----|--|-------|
| window_size | 7:0 | window_size along with the window_offset is used to calculate the first connection point anchor point for the master. This shall be a multiple of 1.25 ms in the range of 1.25 ms to the lesser of 10 ms and (connInterval – 1.25 ms). Values range from 0 to 10 ms. | 0 |

Data channel map 0 (lower word) register

| Addr | Addr | Register Name | RW | Description | Reset |
|------|------|---------------|----|-------------|-------|
|------|------|---------------|----|-------------|-------|

Table continues on the next page...

| 16-bit | 32-bit | | | | |
|--------|--------|------------------|----|---|--------|
| 0x44 | 0x088 | DATA_CHANNELS_L0 | RW | Stores the channel map for channels [15:0]. The register is updated by firmware whenever a new/updated channel map is available for the connection. | 0x0000 |

| Field | Bit | Description | Reset |
|---------------|------|---|--------|
| Data_channels | 15:0 | This register field indicates which of the data channels are in use. This stores the information for the lower 16 (15:0) data channel indices. '1' indicates the corresponding data channel is used and '0' indicates the channel is unused. | 0x0000 |

Data channel map 0(middle word) register

| Addr 16-bit | Addr 32-bit | Register Name | RW | Description | Reset |
|----------------|----------------|------------------|----|---|--------|
| 0x46 | 0x08C | DATA_CHANNELS_MO | RW | Stores the channel map for channels[31:16]. The register is updated by firmware whenever a new/updated channel map is available for the connection. | 0x0000 |

| Field | Bit | Description | Reset |
|---------------|------|---|--------|
| Data_channels | 15:0 | This register field indicates which of the data channels are in use. This stores the information for the middle 16 (31:16) data channel indices. '1' indicates the corresponding data channel is used and '0' indicates the channel is unused. | 0x0000 |

Data channel map 0(upper word) register

| Addr 16-bit | Addr 32-bit | Register Name | RW | Description | Reset |
|----------------|----------------|------------------|----|---|--------|
| 0x48 | 0x090 | DATA_CHANNELS_H0 | RW | Stores the channel map for channels[36:32]. The register is updated by firmware whenever a new/updated channel map is available for the connection. | 0x0000 |

| Field | Bit | Description | Reset |
|---------------|------|---|-------|
| Data_channels | 15:5 | Unused | 0 |
| Data_channels | 4:0 | This register field indicates which of the data channels are in use. This stores the information for the upper 5 (36:32) data channel indices. '1' indicates the corresponding data channel is used and '0' indicates the channel is unused. | 0x00 |

Data channel map 1 (lower word) register

| Addr 16-bit | Addr 32-bit | Register Name | RW | Description | Reset |
|----------------|----------------|------------------|----|--|--------|
| 0x4C | 0x098 | DATA_CHANNELS_L1 | RW | Stores the channel map for channels[15:0]. The register is updated by firmware whenever a new/updated channel map is available for the connection. | 0x0000 |

| Field | Bit | Description | Reset |
|-------|-----|-------------|-------|
|-------|-----|-------------|-------|

Table continues on the next page...

| | | | |
|---------------|------|--|--------|
| Data_channels | 15:0 | This register field indicates which of the data channels are in use. This stores the information for the lower 16 data channel indices. '1' indicates the corresponding data channel is used and '0' indicates the channel is unused. | 0x0000 |
|---------------|------|--|--------|

Data channel map 1 (middle word) register

| Addr 16-bit | Addr 32-bit | Register Name | RW | Description | Reset |
|----------------|----------------|------------------|----|---|--------|
| 0x4E | 0x09C | DATA_CHANNELS_M1 | RW | Stores the channel map for channels[31:16]. The register is updated by firmware whenever a new/updated channel map is available for the connection. | 0x0000 |

| Field | Bit | Description | Reset |
|---------------|------|---|--------|
| Data_channels | 15:0 | This register field indicates which of the data channels are in use. This stores the information for the middle 16 data channel indices. '1' indicates the corresponding data channel is used and '0' indicates the channel is unused. | 0x0000 |

Data channel map 1 (upper word) register

| Addr 16-bit | Addr 32-bit | Register Name | RW | Description | Reset |
|----------------|----------------|------------------|----|--|--------|
| 0x50 | 0x0A0 | DATA_CHANNELS_H1 | RW | Stores the channel map for channels[36:32]. The register is updated by firmware whenever a new/updated | 0x0000 |

Link Layer

| | | | | | |
|--|--|--|--|--|--|
| | | | | channel map is available for the connection. | |
|--|--|--|--|--|--|

| Field | Bit | Description | Reset |
|---------------|------|---|-------|
| Data_channels | 15:5 | Unused | 0 |
| Data_channels | 4:0 | This register field indicates which of the data channels are in use. This stores the information for the upper 5 data channel indices. '1' indicates the corresponding data channel is used and '0' indicates the channel is unused. | 0x00 |

Note: The Data channel map 0 and data channel map 1 are two sets of channel maps stored, common for all the connections. At any given time, only two maps can be maintained and the connections will use one of the two sets as indicated by the channel map index field in the CE_CNFG_STS registers specific to the link. Firmware must also manage to update this field along with the map.

Connection channel Status register

| Addr 16-bit | Addr 32-bit | Register Name | RW | Description | Reset |
|----------------|----------------|---------------|----|--|--------|
| 0x56 | 0x0AC | CONN_STATUS | RO | Indicates the status of the connection channel data path and other common connection channel operations. | 0x0000 |

| Field | Bit | Description | Reset |
|-------------------|-------|--|-------|
| Rx_packet_counter | 15:12 | This field stores the count for the number of receive packets in the receive FIFO that are still not ready by firmware. The counter value is incremented by hardware for every good packet it stores in the FIFO. | 0 |

Table continues on the next page...

| | | | |
|----------|------|---|---|
| | | After firmware reads a packet, it decrements the counter by issuing the PACKET_RECEIVED command from the commander. | |
| Reserved | 11:0 | Reserved for future use | 0 |

Connection configuration register

| Addr 16-bit | Addr 32-bit | Register Name | RW | Description | Reset |
|----------------|----------------|---------------|----|--|--------|
| 0xF0 | 0x1E0 | CONN_CONFIG | RW | This register fields can be set to configure the LLH in data transfer scenarios. | 0x631F |

| Field | Bit | Description | Reset |
|---------------------|-----|--|-------|
| pdu_index_auto_updt | 15 | This bit enable the LL hardware to update the index of the PDU being queued in the data buffer. 0x0- LL Hardware to update the index of the PDU being queued. 0x1- LL firmware to update the index when PDU is queued. | 0x0 |
| mask_suto_at_update | 14 | This bit is used to enable/disable masking of internal hardware supervision timeout trigger when switching from old connection parameters to new parameters. 1 - Enable 0 - Disable | 0x01 |
| extend_cu_tx_win | 13 | This bit is used to enable/disable extending the additional rx window on slave side during connection update in event of packet miss at the update instant. 1 - Enable 0 - Disable | 0x01 |

Table continues on the next page...

Link Layer

| | | | |
|---------------|----|---|-----|
| slv_md_config | 12 | <p>Configuration is provided to send last data packet with MD bit set/zero or one (only for slave mode).</p> <p>SLV_MD_CONFIG bit has effect only when md_bit_ctr bit is not set</p> <p>0 – The MD bit is set based on the transmit buffer empty condition. The last packet goes with a MD bit set since the FIFO would not be empty as we have to retain the data in the buffer till we realize the ACK from the remote side.</p> <p>1 - MD bit will be controlled based on the availability of next data in the FIFO. So send last data packet with MD bit zero or one. If the data transmitted is the last packet in the FIFO the MD bit will be '0' in that packet. Only if the next location holds data then MD bit will be '1'.</p> | 0x0 |
| aww_en | 11 | <p>This field indicates whether window widen optimization is enable or not.</p> <p>0 – It indicates AWW is enable</p> <p>1 – It indicates AWW is disable</p> | 0x0 |
| sl_dsm_en | 10 | <p>This resiter field indicates whether slave latency dsm is enable or not.</p> <p>0 – It indicates SL_DSM is enable</p> <p>1 – It indicates SL_DSM is disable</p> | 0x0 |

| | | | |
|-------------------|---|---|-----|
| index_not_in_addr | 9 | <p>This register field indicates whether connection index is present in address or not.</p> <p>1 – Index is not in address</p> <p>0 – Index is in address</p> | 0x1 |
| Sw_cntrl_md | 8 | <p>This register field indicates whether the MD (More Data) bit needs to be controlled by 'software' or, 'hardware and software logic combined'.</p> | 0x1 |

| | | | |
|--|--|--|--|
| | | <p>1 - MD bit is exclusively controlled by software, ie based on status of <i>CE_CNFG_STS_REGISTER[6]</i> - <i>md</i> bit.</p> <p>0 - MD Bit in the transmitted pdu is controlled by software and hardware logic. MD bit is set in transmitted packet, only if the software has set the <i>md</i> bit in <i>CE_CNFG_STS_REGISTER[6]</i> and either of the following conditions is true,</p> <ol style="list-style-type: none"> 1. If there are packets queued for transmission. 2. If there is an acknowledgement awaited from the remote side for the packet transmitted. | |
|--|--|--|--|

| | | | |
|-------------------|-----|---|-----|
| rx_intr_threshold | 7:4 | <p>This register field allows setting a threshold for the packet received interrupt to the firmware.</p> <p>For example if the value programmed is</p> <p>0x2 – then LLH will generate interrupt only on receiving the second packet.</p> <p>In any case if the received number of packets in a conn event is less than the threshold or there are still packets (less than threshold) pending in the Rx FIFO, LLH will generate the interrupt at the <i>ce_close</i>.</p> <p>Min value possible is 1. Max value depends on the Rx FIFO capacity.</p> | 0x1 |
| rx_pkt_limit | 3:0 | <p>Defines a limit for the number of Rx packets that can be received by the LLH. Default maximum value is 0xF. Minimum value shall be '1' or no packet will be stored in the Rx FIFO.</p> | 0xF |

Note:

The DUT should not send empty packets with MD bit set to 1. This will extend the connection event and increase the power consumption which is unnecessary. However there could be scenarios where maximum throughput is the target. In that case we would need to extend the connection event and allow additional time for the software to queue additional data. So both the behaviors are kept in the implementation and can be selected using md_bit_ctr (ie CONN_CONFIG[8]).

md_bit_ctr = 1 - MD bit is exclusively controlled by software.

If this bit is set, the MD bit in the transmitted packets is exclusively based on the status of md bit (CE_CNFG_STS_REGISTER[6]).

In this mode, empty packets with MD bit set would be transmitted by us during the time an acknowledgement is being processed in the other end. This feature will extend the connection event since the remote end host will get see the MD bit and so stays in the same connection event, and this will allow us more time for our software to process the acknowledgement and queue additional data from the host to hardware. This is useful when we need to maximize the data transmitted in a connection interval.

sw_cntrl_md = 0 - MD bit is controlled by software and hardware logic.

Note that MD bit is not set in the transmitted packet if software has not set the md bit in CE_CNFG_STS_REGISTER[6] as 0b.

In this mode of operation an empty packet will still be sent since the send status clearing and more data check is at same time.

Connection channel transmit power register

| Addr 16-bit | Addr 32-bit | Register Name | RW | Description | Reset |
|----------------|----------------|------------------|----|---|--------|
| 0xF2 | 0x1E4 | CONN_CH_TX_POWER | RW | Connection channel transmit power. This register controls transmit power on all connection channel transmissions. | 0x0000 |

| Field | Bit | Description | Reset |
|--------------------|-----|--|--------|
| Conn_tx_power[5:0] | 5:0 | Transmit power to be used for all packets transmitted on the connection channel. | 0x0000 |

Connection Interrupt mask register

| Addr 16-bit | Addr 32-bit | Register Name | RW | Description | Reset |
|----------------|----------------|----------------|----|---|--------|
| 0xF8 | 0x1F0 | CONN_INTR_MASK | RW | Connection Interrupt enable register. This register controls enabling of interrupts and other enables common for all connections. | 0x0000 |

| Field | Bit | Description | Reset |
|--------------------------|-------|--|-------|
| ping_nearly_expired_intr | 15 | If this bit is set ping timer nearly expired interrupt is enabled. | 0 |
| ping_timer_expired_intr | 14 | If this bit is set ping timer expired interrupt is enabled. | 0 |
| Reserved | 13:10 | Unused. | 0 |
| rx_bad_pdu_int_en | 9 | If this bit is set packet receive bad pdu interrupt is enabled. Effective only when bit 6 is set. | 0 |
| rx_good_pdu_int_en | 8 | If this bit is set packet receive good pdu interrupt is enabled. Effective only when bit 6 is set. | 0 |
| conn_updt_intr_en | 7 | If this bit is set connection update interrupt is enabled. | 0 |
| ce_rx_int_en | 6 | If this bit is set interrupt is enabled for reception of packet in a connection event. Bit 8 and 9 are sub-mask bits below this mask. | 0 |
| ce_tx_ack_int_en | 5 | If this bit is set transmission acknowledgement interrupt is enabled: This interrupt is generated to indicate to the firmware that a non-empty packet transmitted is successfully acknowledged by the remote device. For negative acknowledgements from remote device, this interrupt indication is not generated. | 0 |

Table continues on the next page...

Link Layer

| | | | |
|------------------|---|---|---|
| close_ce_int_en | 4 | If this bit is set connection event closed interrupt is enabled. | 0 |
| start_ce_int_en | 3 | If this bit is set connection event start interrupt is enabled | 0 |
| map_updt_int_en | 2 | If this bit is set, channel map update interrupt is enabled. | 0 |
| conn_estb_int_en | 1 | If this bit is set connection establishment interrupt is enabled. | 0 |
| conn_cl_int_en | 0 | If this bit is set connection closed interrupt is enabled. | 0 |

Slave timing control register

| Addr 16-bit | Addr 32-bit | Register Name | RW | Description | Reset |
|----------------|----------------|--------------------------|----|---|--------|
| 0xFA | 0x1F4 | SLAVE_TIMING_C ONTROL | RW | Slave timing control register. This register controls slave related timing. | 0xBE96 |

| Field | Bit | Description | Reset |
|--------------------|------|---|-------|
| Slave_time_adj_val | 15:8 | Timing adjust value. The internal micro second counter is adjusted to this value whenever slave receives a good access address match at connection anchor point. This will ensure the slave gets synchronized to master timing. | 0xBE |
| Slave_time_set_val | 7:0 | Programmable adjust value to the clock counter when slave is connected | 0x96 |

Window widen for offset register

| Addr 16-bit | Addr 32-bit | Register Name | RW | Description | Reset |
|----------------|----------------|-------------------------|----|---|--------|
| 0xB2 | 0x164 | WINDOW_WIDEN_ WINOFF | RW | Window widen value corresponding to transmitwindowoffs et. Firmware | 0x000A |

| | | | | | |
|--|--|--|--|--|--|
| | | | | calculates the possible drift due to transmit window offset to the first packet after connection/ connection update and programs the value into this register. The value is in microseconds. | |
|--|--|--|--|--|--|

| Field | Bit | Description | Reset |
|--------------|-------|--|-------|
| Reserved | 15:12 | Unused | |
| Window_widen | 11:0 | This field stores the additional number of microseconds the slave must conn_config its listening window to listen for a master packet for receiving the first packet after connection creation. This value is calculated based on the window offset value to the first anchor point. This is used at connection setup directly. During connection setup, this value is added with window_widen_intvl register value to calculate the window widening size. | 00A |

Connection Index register

| Addr 16-bit | Addr 32-bit | Register Name | RW | Description | Reset |
|----------------|----------------|---------------|----|---|--------|
| 0x58 | 0x0B0 | CONN_INDEX | RW | Index of the connection to which the connection-specific parameter is being written to or read from. Firmware shall update this register with proper index before writing/ reading the connection-specific registers (refer to register summary before for the connection specific register set). | 0x0000 |

Link Layer

| | | | | | |
|--|--|--|--|---|--|
| | | | | This register is relevant only for multiple connection support. If multiple connection is supported but number of connections is made one then the register value needs to be kept 0x0. | |
|--|--|--|--|---|--|

| Field | Bit | Description | Reset |
|---------------|------|---|-------|
| RFU | 15:2 | Reserved | 0 |
| fw_conn_index | 1:0 | This field is used to index the multiple connections existing. Range is 0 to 1. 0x0 – Connection Engine 0 in LLH 0x1 – Connection Engine 1 in LLH | 0 |

Connection Interrupt clear register

| Addr 16-bit | Addr 32-bit | Register Name | RW | Description | Reset |
|----------------|----------------|-----------------|----|--|--------|
| 0x54 | 0x0A8 | CONN_INTR_CLEAR | WO | Clear connection interrupts. Write to the register to clear one more connection interrupts. This register is implemented per connection. To clear interrupt for a specific connection, connection index register must be programmed before writing to this register. | 0x0000 |

| Field | Bit | Description | Reset |
|--------------------------------|-----|--|-------|
| conn_ping_timer_nearly_expired | 15 | If this bit is written with 1, it clears the | 0 |

Table continues on the next page...

| | | | |
|------------------------|------|---|---|
| | | conn_ping_timer_nearly_expire interrupt. | |
| conn_ping_timer_expire | 14 | If this bit is written with 1, it clears the conn_ping_timer_expire interrupt. | 0 |
| Reserved | 13:8 | Unused | 0 |
| con_updt_done | 7 | If this bit is written with 1, it clears the connection updated interrupt. | 0 |
| ce_rx | 6 | If this bit is written with 1, it clears the connection event received interrupt. | 0 |
| ce_tx_ack | 5 | If this bit is written with 1, it clears the ce transmission acknowledgement interrupt. | 0 |
| close_ce | 4 | If this bit is written with 1, it clears the connection event closed interrupt. | 0 |
| start_ce | 3 | If this bit is written with 1, it clears the connection event started interrupt. | 0 |
| map_updt_done | 2 | If this bit is written with 1, it clears the map update done interrupt. | 0 |
| conn_estb | 1 | If this bit is written with 1, it clears the connection established interrupt. | 0 |
| conn_closed | 0 | If this bit is written with 1, it clears the connection updated interrupt. | 0 |

Connection Interrupt status register

| Addr 16-bit | Addr 32-bit | Register Name | RW | Description | Reset |
|----------------|----------------|------------------|----|--|--------|
| 0x54 | 0x0A8 | CONN_INTR_STATUS | RO | Connection Interrupt status register. To read interrupt for a specific connection, connection index register must be programmed before reading from this register. | 0x0000 |

| Field | Bit | Description | Reset |
|-------|-----|-------------|-------|
|-------|-----|-------------|-------|

Table continues on the next page...

Link Layer

| | | | |
|-------------------------|-------|--|---|
| ping_nearly_expird_intr | 15 | If this is set, it indicates that ping timer has nearly expired. | 0 |
| ping_timer_expird_intr | 14 | If this is set, it indicates that ping timer has expired. | 0 |
| rx_pdu_status | 13:11 | Status of PDU received. This information is valid along with receive interrupt. Xx1 – Bad Packet (packet with CRC error) 000 – empty PDU 010 - new data (non-empty) PDU 110 – Duplicate Packet | 0 |
| discon_status | 10:8 | Reason for disconnect – indicates the reason the link is disconnected by hardware. 001 – connection failed to be established 010 - supervision timeout 011 – kill connection by host 100 – kill connection after ACK transmitted 101 – PDU response timer expired | 0 |
| con_updt_done | 7 | This bit is set when the last connection event with previous connection parameters is reached. The bit is set immediately after the receive operation at the anchor point of the last connection event. | 0 |
| ce_rx | 6 | If this bit is set it indicates that a packet is received in the connection event. | 0 |
| ce_tx_ack | 5 | If this bit is set it indicates that the connection event transmission acknowledgement is received for the previous non-empty packet transmitted. | 0 |
| close_ce | 4 | If this bit is set it indicates that the connection event closed interrupt has happened. | 0 |
| start_ce | 3 | If this bit is set it indicates that the connection event started interrupt has happened. | 0 |
| map_updt_done | 2 | If this bit is set it indicates that the channel map update is | 0 |

Table continues on the next page...

| | | | |
|----------------|---|--|---|
| | | completed at the instant specified by the firmware. | |
| conn_estb_updt | 1 | If this bit is set it indicates that the connection has been established. The bit is also set when a connection update procedure is completed, at the start of the first anchor point with the updated parameters. | 0 |
| conn_closed | 0 | If this bit is set it indicates that the link is disconnected. | 0 |

Connection Interval register

| Addr 16-bit | Addr 32-bit | Register Name | RW | Description | Reset |
|----------------|----------------|---------------|----|--|--------|
| 0x80 | 0x100 | CONN_INTERVAL | RW | Connection Interval registers. Firmware writes the connection interval specific to the connection. The connection index register must be programmed with index of the connection, before programming the register. | 0x0000 |

| Field | Bit | Description | Reset |
|---------------------|------|---|--------|
| connection Interval | 15:0 | The value configured in this register determines the spacing between the connection events. This shall be a multiple of 1.25 ms in the range of 7.5 ms to 4.0 s. | 0x0000 |

Supervision timeout register

| Addr 16-bit | Addr 32-bit | Register Name | RW | Description | Reset |
|----------------|----------------|---------------|----|--|--------|
| 0x82 | 0x104 | SUP_TIMEOUT | RW | Supervision timeout for the connection. The connection index register must | 0x0000 |

Link Layer

| | | | | | |
|--|--|--|--|--|--|
| | | | | be programmed with index of the connection, before programming the register. | |
|--|--|--|--|--|--|

| Field | Bit | Description | Reset |
|---------------------|------|--|--------|
| supervision_timeout | 15:0 | <p>This field defines the maximum time between two received Data packet PDUs before the connection is considered lost.</p> <p>This shall be a multiple of 10 ms in the range of 100 ms to 32.0 s and it shall be larger than $(1+connSlaveLatency)*connInterval$.</p> | 0x0000 |

Slave Latency register

| Addr 16-bit | Addr 32-bit | Register Name | RW | Description | Reset |
|----------------|----------------|---------------|----|---|--------|
| 0x84 | 0x108 | SLAVE_LATENCY | RW | Slave latency for the connection. The connection index register must be programmed with index of the connection, before programming the register. | 0x0000 |

| Field | Bit | Description | Reset |
|---------------|------|---|--------|
| slave_latency | 15:0 | <p>The value configured in this field defines the number of consecutive connection events that the slave device is not required to listen for master.</p> <p>The value of <code>connSlaveLatency</code> should not cause a Supervision Timeout.</p> <p>This shall be an integer in the range of 0 to $((connSupervisionTimeout/$</p> | 0x0000 |

| | | | |
|--|--|---|--|
| | | connInterval)-1). connSlaveLatency shall also be less than 500. | |
|--|--|---|--|

Connection event length register

| Addr 16-bit | Addr 32-bit | Register Name | RW | Description | Reset |
|----------------|----------------|---------------|----|---|------------|
| 0x86 | 0x10C | CE_LENGTH | RW | Connection event length for the connection. The connection index register must be programmed with index of the connection, before programming the register. | 0x00 00 |

| Field | Bit | Description | Reset |
|-------------------------|------|---|--------|
| Connection event Length | 15:0 | This field defines the length of Connection event. This value is derived from the CE length HCI parameters received from the host. This determines the number of master transmit slots in a connection event, subject to either of the MD bits being set. If both MD bits are set to 0, this has no effect. Units : 625 us. Note: The connection event length as specified by the CE_LENGTH shall not exceed CONN_INTERVAL – 1.25 ms. | 0x0000 |

The CE-length parameter, according to the Bluetooth specification, is the length of the connection event.

Take an example to illustrate this scenario:

Assume a connection with interval = 100ms. that the application has put allowed 20ms of CE-length.

Here, the CE-length can be up to 100ms (100ms - 150us to be exact).

If the connection is maintained for 5 minutes, there could be $10 \times 60 \times 5 = 3000$ connection-intervals.

The CE-length need not maintained constant during all the 3000 connection events.

Here are the typical cases that determine the value of CE-length:

(1) No data packets exchanged. we are just maintaining time and frequency synchronization. In this case, only a packet pair will be exchanged every connection interval. Here, CE-length = 1.

(2) Average of 10 packets to be sent per connection event.

We can pump data in multiple ways here:

2.1: Send data at uniform rate : In this case, the CE-length will be enough to accommodate 10 packets, which will take about 7ms. As this is less than application enforced limit of 20ms, we can comfortably push all the 10 data packets in this connection interval. So data will be pumped to the other BT device at the same rate as is received from my application.

2.2: Can send data in bursts. Assume that we accumulate data for 1 second and pump out at the end of 1 second(this is not done by our Bluetooth stack, the application needs to buffer the data). So, at 10th connection interval, we have 100 packets accumulated. We are now ready to pump this data. 100 packets take about 70 ms. This is above the application enforced 20ms. So, the hardware can pump data that can fill up 20ms. The remaining data will be deferred to the next connection interval.

So, in this case, you would see a CE-length spread over time like this (Per connection interval):

0,0,0,0,0,0,0,0,0,0, 20,20,20,10,0,0,0,0,0,0, 20,20,20,10,0,0,0,0,0,0,
20,20,20,10,0,0,0,0,0,0,

and so on.

(3) We are receiving data at the same rate as in (2). This case is to honor data sent by the other BT-device by giving it more time in the current connection interval.

In (2) and (3) you will see non-empty packets either transmitted or received. We can also utilize the CE-length for different reasons:

(4) A transaction is in progress, and we are expecting a response packet very soon. In this case, we may be exchanging only empty packets now, and in the next few packet-pairs.

In this case, you will the CE-length to be large, and a non-empty packet may not be exchanged in all the slots.

Access address (lower) register

| Addr 16-bit | Addr 32-bit | Register Name | RW | Description | Reset |
|----------------|----------------|--------------------------------|----|--|--------|
| 0x88 | 0x110 | PDU_ACCESS_AD DR_L_REGISTER | RW | Access address bits 15:0 for the connection. The connection index register must be programmed with index of the connection, before programming the register. | 0x0000 |

| Field | Bit | Description | Reset |
|-------------------------------|------|--|--------|
| PDU Access Address Lower bits | 15:0 | This field defines the lower 16 bits of the access address for each Link layer connection between any two devices. | 0x0000 |

Access address (upper) register

| Addr 16-bit | Addr 32-bit | Register Name | RW | Description | Reset |
|----------------|----------------|--------------------------------|----|---|--------|
| 0x8A | 0x114 | PDU_ACCESS_AD DR_H_REGISTER | RW | Access address bits 32:16 for the connection. The connection index register must be programmed with index of the connection, before programming the register. | 0x0000 |

| Field | Bit | Description | Reset |
|-------------------------------|------|---|--------|
| PDU Access Address Lower bits | 15:0 | This field defines the higher 16 bits of the access address for each Link layer connection between any two devices. | 0x0000 |

Connect Event Instant register

| Addr | Addr | Register Name | RW | Description | Reset |
|------|------|---------------|----|-------------|-------|
|------|------|---------------|----|-------------|-------|

Table continues on the next page...

Link Layer

| 16-bit | 32-bit | | | | |
|--------|--------|-----------------|----|--|--------|
| 0x8C | 0x118 | CONN_CE_INSTANT | RW | This is the instant used for connection update procedure and channel map update procedure. | 0x0000 |

| Field | Bit | Description | Reset |
|------------|------|--|--------|
| Ce_instant | 15:0 | This is the value of the free running Connection Event counter when the new parameters of 'connection update' and/or 'Channel map update' will be effective. Range : 0x0000 to 0xFFFF | 0x0000 |

Connect Event Counter register

| Addr 16-bit | Addr 32-bit | Register Name | RW | Description | Reset |
|----------------|----------------|-----------------|----|--|--------|
| 0x92 | 0x124 | CONN_CE_COUNTER | RO | This is the free running counter, connEventCounter as defined by Bluetooth spec. | 0x0000 |

| Field | Bit | Description | Reset |
|------------------------|------|---|--------|
| connectionEventCounter | 15:0 | Firmware will read the instantaneous Event counter from this register, during connection update and channel map update procedure. Firmware will use this value to calculate the instant from which the new parameters (for connection update and channel map update) will be effective. | 0x0000 |

Connection configuration & status register

| Addr 16-bit | Addr 32-bit | Register Name | RW | Description | Reset |
|----------------|----------------|---------------|----|-------------|-------|
|----------------|----------------|---------------|----|-------------|-------|

Table continues on the next page...

| | | | | | |
|------|-------|----------------------|----|---|--------|
| 0x8E | 0x11C | CE_CNFG_STS_REGISTER | RW | <p>Connection specific configuration and status information register.</p> <p>This register facilitates the pause/resume mechanism of data PDUs by LL , typically used during “enable encryption” procedure.</p> <p>In case multiple connections are supported, “connection index register” has to be written by the f/w before programming/ reading this register</p> | 0x0000 |
|------|-------|----------------------|----|---|--------|

| Field | Bit | Description | Reset |
|----------------------|-------|--|-------|
| current_pdu_index | 15:12 | Read Only field. The index of the transmit packet buffer that is currently in transmission/ waiting for transmission. | 0 |
| Reserved | 11 | Reserved for future use. | 0 |
| conn_active | 10 | Read Only field . This bit is ‘1’ whenever the connection is active. | 0 |
| force_nesn0 | 9 | not used | 0 |
| pause_data | 8 | <p>Pause data. 1 – pause data, 0 – do not pause.</p> <p>Pause the data transfer on the connection. The current_pdu_index in hardware does not move to next index until pause_data is cleared.</p> | 0 |
| map_index/curr_index | 7 | <p>Mixed info field. Written by firmware to select the channel map register set to be used by hardware for this connection.</p> <p>1 – use channel map register set 1. 0 – use channel map register set 0.</p> | 0 |

Table continues on the next page...

Link Layer

| | | | |
|------------------------------------|-----|---|---|
| | | When firmware reads this field, it returns the current map index being used in hardware. | |
| md | 6 | MD bit set to '1' indicates device has more data to be sent. | 0 |
| mas_slv | 5 | mas_slv bit set to '1' indicates that device is configured as a master or a slave. 1 – master, 0 – slave. | 0 |
| data_list_head_up | 4 | Update the first packet buffer index ready for transmission to start/resume data transfer after a pause. <u>The bit must be toggled every time the firmware needs to indicate the start/resume. This requires a read modify write operation.</u> | 0 |
| Data_list_index/ last_ack_index | 3:0 | Data list index for start/resume. This field must be valid along with data_list_head_up and indicate the transmit packet buffer index at which the data is loaded. The default number of buffers in the IP is 5, but may be customized for a customer. The buffers are indexed 0 to 4. Hardware will start the next data transmission from the index indicated by this field. | 0 |

Next CE instant register

| Addr 16-bit | Addr 32-bit | Register Name | RW | Description | Reset |
|----------------|----------------|-----------------|----|---|--------|
| 0x90 | 0x120 | NEXT_CE_INSTANT | RO | 16-bit internal reference clock value at which the next connection event will occur on a connection. The connection index register must be programmed with index of the | 0x0000 |

| | | | | | |
|--|--|--|--|--|--|
| | | | | connection, before reading the register. | |
|--|--|--|--|--|--|

| Field | Bit | Description | Reset |
|---------|------|--|--------|
| Instant | 15:0 | 16-bit internal reference clock value at which the next connection event will occur on a connection. The connection index register must be programmed with index of the connection, before reading the register. | 0x0000 |

Connection parameter 1 register

| Addr 16-bit | Addr 32-bit | Register Name | RW | Description | Reset |
|----------------|----------------|---------------|----|---|--------|
| 0xF4 | 0x1E8 | CONN_PARAM1 | RW | Connection parameters like sca, hop_increment and crc_init exchanged in connect_request of this connection. | 0x0000 |

| Field | Bit | Description | Reset |
|--------------------|------|---|-------|
| crc_init[7:0] | 15:8 | This field defines the lower byte (7:0) of the CRC initialization vector. | 0 |
| hop_increment[4:0] | 7:3 | Hop increment for connection channel. | |
| sca[2:0] | 2:0 | Sleep Clock accuracy value. | |

Connection parameter 2 register

| Addr 16-bit | Addr 32-bit | Register Name | RW | Description | Reset |
|----------------|----------------|---------------|----|--|--------|
| 0xF6 | 0x1EC | CONN_PARAM2 | RW | Connection parameter crc_init bits 24:7 exchanged in connect_request of this connection. | 0x0000 |

Link Layer

| | | | | | |
|--|--|--|--|---|--|
| | | | | The connection index register must be programmed with index of the connection, before reading the register. | |
|--|--|--|--|---|--|

| Field | Bit | Description | Reset |
|----------------|------|---|--------|
| crc_init[23:8] | 15:0 | This field defines the upper two bytes (23:8) of the CRC initialization vector. | 0x0000 |

Connection Update New Interval

| Addr 16-bit | Addr 32-bit | Register Name | RW | Description | Reset |
|----------------|----------------|--------------------------|----|---|--------|
| 0x1D2 | 0x3A4 | CONN_UPDATE_NEW_INTERVAL | RW | The connection interval that will be effective after the connection update instant. | 0x0000 |

| Field | Bit | Description | Reset |
|-------------------------|------|---|--------|
| Conn_interval_new[15:0] | 15:0 | This register will have the new connection interval that the hardware will use after the connection update instant. Before the instant, the connection interval in the register CONN_INTERVAL will be used by hardware. | 0x0000 |

- Connection Update New Latency

| Addr 16-bit | Addr 32-bit | Register Name | RW | Description | Reset |
|----------------|----------------|-------------------------|----|---|--------|
| 0x1D4 | 0x3A8 | CONN_UPDATE_NEW_LATENCY | RW | The slave latency that will be effective after the connection update instant. | 0x0000 |

| Field | Bit | Description | Reset |
|--------------------------|------|---|--------|
| Slave_latency_newl[15:0] | 15:0 | This register will have the new slave latency parameter that the hardware will use after the connection update instant. Before the instant, the connection interval in the register SLAVE_LATENCY will be used by hardware. | 0x0000 |

- Connection Update New Su To

| Addr 16-bit | Addr 32-bit | Register Name | RW | Description | Reset |
|----------------|----------------|-----------------------|----|---|--------|
| 0x1D6 | 0x3AC | CONN_UPDATE_NEW_SU_TO | RW | The Supervision timeout that will be effective after the connection update instant. | 0x0000 |

| Field | Bit | Description | Reset |
|----------------------|------|---|--------|
| Conn_so_to_new[15:0] | 15:0 | This register will have the new supervision timeout that the hardware will use after the connection update instant. Before the instant, the connection interval in the register SUP_TIMEOUT will be used by hardware. | 0x0000 |

- Connection Update New slaveLatency x connInterval value

| Addr 16-bit | Addr 32-bit | Register Name | RW | Description | Reset |
|----------------|----------------|-----------------------------|----|---|--------|
| 0x1D8 | 0x3B0 | CONN_UPDATE_NEW_SL_INTERVAL | RW | The (slaveLatency * connInterval) value that will be effective after the connection update instant. | 0x0000 |

Link Layer

| Field | Bit | Description | Reset |
|----------------------------|------|--|--------|
| sl_conn_interval_new[15:0] | 15:0 | This register will have the new SL*CI value that the hardware will use after the connection update instant. Before the instant, the connection interval in the register SL_CONN_INTERVAL will be used by hardware. | 0x0000 |

Window Widen for Interval register

| Addr 16-bit | Addr 32-bit | Register Name | RW | Description | Reset |
|----------------|----------------|--------------------|----|---|--------|
| 0xB0 | 0x160 | WINDOW_WIDEN_INTVL | RW | Window widening value based on connection interval of the connection. The connection index register must be programmed with index of the connection, before reading the register. | 0x000A |

| Field | Bit | Description | Reset |
|--------------|-------|--|--------|
| Reserved | 15:12 | Not used | |
| Window_widen | 11:0 | <p>This value defines the increased listening time for the slave.</p> <p>The windowWidening shall be smaller than $((\text{connInterval}/2) - T_IFS)$ us)</p> <p>This value is calculated by firmware based on the drift, the connection interval value. The value is the unit widening value for one connection interval duration. In case of slave latency, this value is accumulated till the next anchor point at which the slave will listen.</p> | 0x000A |

PDU response timer register

| Addr 16-bit | Addr 32-bit | Register Name | RW | Description | Reset |
|----------------|----------------|----------------|----|--|--------|
| 0x502 | 0xA04 | PDU_RESP_TIMER | RW | PDU response timer register. This timer is used to monitor the time to get the response for the control procedures for which timeout rules are specified in the specification. | 0x0000 |

| Field | Bit | Description | Reset |
|-------------------|------|--|-------|
| Pdu_resp_time_val | 15:0 | <p>This register is loaded with the count value to monitor the time to get a response for the control PDU sent to a peer device.</p> <p>Firmware starts the timer by issuing the command, RESP_TIMER_ON, after it has queued a control PDU for transmission that requires a response.</p> <p>If a response is received, firmware stops and clears the timer by issuing the command RESP_TIMER_OFF.</p> <p>If this timer expires, it results in hardware closing the connection and triggering a conn_closed interrupt.</p> <p>The <i>discon_status</i> field in the Connection status register is set with the appropriate reason.</p> <p>Units : Milliseconds. Resolution : 1.25 ms</p> | 0 |

Next response timeout instant register

| Addr 16-bit | Addr 32-bit | Register Name | RW | Description | Reset |
|----------------|----------------|---------------------|----|--|--------|
| 0x504 | 0xA08 | NEXT_RESP_TIMER_EXP | RO | 16-bit internal reference clock value at which the next PDU response | 0x0000 |

Link Layer

| | | | | | |
|--|--|--|--|---|--|
| | | | | timeout event will occur on a connection. | |
|--|--|--|--|---|--|

| Field | Bit | Description | Reset |
|------------------------|------|---|--------|
| Next_resp_timer_expire | 15:0 | This field defines the clock instant at which the next PDU response timeout event will occur on a connection. This is with reference to the 16-bit internal reference clock. | 0x0000 |

Next Supervision timeout instant register

| Addr 16-bit | Addr 32-bit | Register Name | RW | Description | Reset |
|----------------|----------------|---------------|----|---|--------|
| 0x506 | 0xA0C | NEXT_SUP_TO | RO | 16-bit internal reference clock value at which the next supervision timeout event will occur on a connection. | 0x0000 |

| Field | Bit | Description | Reset |
|----------------------|------|---|--------|
| Next_timeout_instant | 15:0 | This field defines the clock instant at which the next connection supervision timeout event will occur on a connection. This is with reference to the 16-bit internal reference clock. | 0x0000 |

Data list SENT Status register

| Addr 16-bit | Addr 32-bit | Register Name | RW | Description | Reset |
|----------------|----------------|-----------------------|----|--|--------|
| 0x94 | 0x128 | DATA_LIST_SENT_STATUS | WO | The register is used by firmware to indicate that a packet buffer is queued (loaded) with data for transmission. | 0x0000 |

| | | | | | |
|--|--|--|--|--|--|
| | | | | Firmware sets a SENT bit in hardware corresponding to the packet buffer queued with a packet for transmission. | |
|--|--|--|--|--|--|

| Field | Bit | Description | Reset |
|------------|------|---|-------|
| Reserved | 15:9 | Unused | 0 |
| Set/Clear | 8 | <p>Used to set the SENT bit in hardware for the selected packet buffer.</p> <p>1 – packet queued</p> <p>When firmware has a packet to send, firmware first loads the next available packet buffer. Then the hardware SENT bit is set by writing 1 to this bit field along with the list_index field that identified the buffer index. This indicates that a packet has been queued in the data buffer for sending. This packet is now ready to be transmitted.</p> <p>The SENT bit in hardware is cleared by hardware only when it has received an acknowledgement from the remote device.</p> <p>Firmware typically does not clear the bit. However, it only clears the bit on its own if it needs to ‘flush’ a packet from the buffer, without waiting to receive acknowledgement from the remote device, firmware clears BIT7 along with the list_index specified.</p> <p>Note: This register has a different meaning in the Read-path</p> | 0 |
| List_index | 7:0 | <p>Indicates the buffer index for which the SENT bit is being updated by firmware.</p> <p>The default number of buffers in the IP is 5. The index range is 0-4.</p> | 0 |

Data list ACK update register

| Addr 16-bit | Addr 32-bit | Register Name | RW | Description | Reset |
|----------------|----------------|----------------------|----|--|--------|
| 0x96 | 0x12C | DATA_LIST_ACK_STATUS | WO | Clear ACK indication for the packet, as reported by link layer hardware. | 0x0000 |

| Field | Bit | Description | Reset |
|------------|------|--|--------|
| Reserved | 15:9 | Unused | 0x0000 |
| Set/clear | 8 | <p>Firmware uses the field to clear the ACK bit in the hardware to indicate that the acknowledgement for the transmit packet has been received and processed by firmware.</p> <p>Firmware clears the ACK bit in the hardware by writing in this register only after the acknowledgement is processed successfully by firmware.</p> <p>For clearing ack for a packet transmitted in fifo-index : '3', firmware will write '3' in the 'list-index' field and set this bit (BIT7) to 0.</p> <p>This is the indication that the corresponding packet buffer identified by List-Index is cleared of previous transmission and can be re-used for another packet from now on.</p> <p>The ACK bit in hardware is set by hardware when it has successfully transmitted a packet.</p> <p>Note: This register has a different meaning in the Read-path</p> | 0 |
| List_index | 7:0 | <p>Indicates the buffer index for which the ACK bit is being updated by firmware.</p> <p>The default number of buffers in the IP is 5. The index range is 0-4.</p> | 0 |

Data list SENT status register

| Addr 16-bit | Addr 32-bit | Register Name | RW | Description | Reset |
|----------------|----------------|-----------------------|----|---|--------|
| 0x94 | 0x128 | DATA_LIST_SENT_STATUS | RO | Status of SENT bit of all the transmit buffers available in the hardware. | 0x0000 |

| Field | Bit | Description | Reset |
|----------|------|--|--------|
| Reserved | 15:8 | Unused | 0x0000 |
| tx_sent | 7:0 | The bits in this field indicate the status of the SENT bit in the hardware for each packet buffer. The bit values are 1 – queued 0 – no packet / packet ack received by hardware Example1: If the read value is : 0x03, then packets in buffer 0 and buffer 1 are in the queue to be transmitted. All the other FIFOs are empty or hardware has cleared them after receiving acknowledgement. | 0 |

Data list ACK update register

| Addr 16-bit | Addr 32-bit | Register Name | RW | Description | Reset |
|----------------|----------------|----------------------|----|--|--------|
| 0x96 | 0x12C | DATA_LIST_ACK_STATUS | RO | Status of ACK bit of all the transmit buffers available in the hardware. | 0x0000 |

| Field | Bit | Description | Reset |
|----------|------|---|--------|
| Reserved | 15:8 | Unused | 0x0000 |
| tx_ack | 7:0 | If a particular bit is set, then the packet in the selected buffer has been transmitted | 0 |

Link Layer

| | | | |
|--|--|---|--|
| | | <p>(at least once) by the hardware and hardware is waiting for acknowledgement.</p> <p>Example1 : If the read value is : 0x03, then packets in FIFO-0 and FIFO-1 are acknowledged by the remote device. These acknowledgements are pending to be processed by firmware.</p> <p>Example2 : If the read value is : 0x02, then packet FIFO-1 is acknowledged by the remote device. This acknowledgement is pending to be processed by firmware.</p> <p>Note : This register has a different meaning in the Write-path.</p> | |
|--|--|---|--|

The SENT bit and ACK bit have to be taken together to understand the meaning of packet status. The table below describes how the two bits are sequentially updated by either hardware/firmware to complete one data transmission.

| SENT | ACK | Description |
|------|-----|---|
| 0 | 0 | Buffer is empty. No packet is queued in the buffer |
| 1 | 0 | Packet is queued by firmware. |
| 1 | 1 | Packet is transmitted by hardware. Hardware is waiting for acknowledgement. |
| 0 | 1 | Hardware has received ACK. Firmware has not yet processed the ACK. |
| 0 | 0 | Firmware has processed the ack. The buffer is again empty. |

Device Data List Status Register

| Addr 16-bit | Addr 32-bit | Register Name | RW | Description | Reset |
|----------------|----------------|-------------------------|----|---|--------|
| 0x290 | 0x520 | DEVICE_DATA_LIST_STATUS | RO | Status of data packets queued and sent. | 0x0000 |

| Field | Bit | Description | Reset |
|-------------------------|------|---|--------|
| Reserved | 15:8 | Unused | 0x0000 |
| device_data_list_status | 7:0 | <p>These bits the status of data packet queued and sent at device level. If the particular bit is set to '1' indicates that there either pending PDU in the queue or pending ACK to be cleared. Based on the status of this register FW will queue next PDU.</p> <p>Note : This register is used only in shared connection tx_fifo.</p> | 0 |

Data list Index 0 register

| Addr 16-bit | Addr 32-bit | Register Name | RW | Description | Reset |
|----------------|----------------|---------------|----|--------------------------|--------|
| 0x98 | 0x130 | LIST_INDEX0 | WO | Reserved for future use. | 0x0000 |

Data list Index 1 register

| Addr 16-bit | Addr 32-bit | Register Name | RW | Description | Reset |
|----------------|----------------|---------------|----|--------------------------|--------|
| 0x9A | 0x134 | LIST_INDEX1 | WO | Reserved for future use. | 0x0000 |

Data buffer descriptor 0-7 register

| Addr 16-bit | Addr 32-bit | Register Name | RW | Description | Reset |
|--|----------------|---|----|--|--------|
| 0xA0-0xAE | 0x140-0x15C | DATA_MEM_DES CRIPTOR0- DATA_MEM_DES CRIPTOR7 | RW | Descriptor for packet stored in the each of the transmit buffer which includes the packet specific information like length and LLID. | 0x0000 |
| DATA_MEM_DESCRIPTOR 5 to DATA_MEM_DESCRIPTOR 7 is RFU. | | | | | |

Link Layer

| Field | Bit | Description | Reset |
|-------------|------|--|-------|
| conn_handle | 15:8 | Unused. Reserved for future use. | 0x0 |
| Enc | 7 | Unused. Reserved for future use. | |
| Data_length | 6:2 | This field indicates the length of the data packet. Range: 0x0 to 0x1F. | 0 |
| LLID | 1:0 | The LLID indicates whether the packet is an LL Data PDU or an LL Control PDU. 00b= Reserved. 01b=LL Data PDU: Continuation fragment of an L2CAP message or an Empty PDU. 10b=LL Data PDU: Start of an L@CAP message or a complete L2CAP message with no fragmentation. 11b=LL Control PDU. | |

Feature Configuration register

| Addr 16-bit | Addr 32-bit | Register Name | RW | Description | Reset |
|-------------|-------------|--------------------|----|---|--------|
| 0x508 | 0xA10 | LLH_FEATURE_CONFIG | RW | Enabling/Disabling of different features implemented in connection. | 0x0000 |

| Field | Bit | Description | Reset |
|----------------|-----|---|-------|
| Reserved | 7:2 | RFU | 0 |
| Quick_transmit | 0 | Quick transmit feature in slave latency is enabled by setting this bit. When slave latency is enabled, this feature enables the slave to transmit in the immediate connection interval, in case required, instead of waiting till the end of slave latency | 0 |

Adaptive Window Widening Config

| Addr 16-bit | Addr 32-bit | Register Name | RW | Description | Reset |
|----------------|----------------|---------------|----|---|--------|
| 0x50A | 0xA14 | AWW_CONFIG | RW | Enabling/Disabling of various AWW specific functions and AWW configurable parameters. | 0xE244 |

| Field | Bit | Description | Reset |
|-------------------------|-------|--|-------|
| aww_error_tolerance_en | 15 | This bit enables/disables the access code bit error tolerance functionality. 1 – enable 0 - disable | 1 |
| aww_tolerance_threshold | 14:10 | This value sets the lower bound on tolerance of bit errors in access code to overlook AWW history recapture. Eg., 0x18 implies 32-24 = 8 bit errors are tolerable. | 0x18 |
| aww_alg_auto_switch_en | 9:9 | This bit is used to enable/disable the functionality of automatic switching between the AWW algorithms i.e The Conservative Mode and Greedy Mode. 1 – Enable 0 – Disable | 1 |
| aww_alg_sel | 8:8 | IF the AWW algorithm auto switch functionality is disabled, this bit is used to manually select the AWW algorithm to be used. 1 – Greedy Mode 0 – Conservative Mode | 0 |
| constancy_cnt_init_val | 7:4 | This value defines the number of connection events for which the adaptive window module checks if master anchor points variations fall within set threshold before switching from conservative mode to greedy mode. Valid Range : (0x1,0xf) | 0x04 |
| Obs_ce_cnt_init_val | 3:0 | This value defines the number of connection events for which the adaptive window module | 0x04 |

Link Layer

| | | | |
|--|--|--|--|
| | | performs measurements of master anchor point swing before it applies the optimized window in accordance with conservative mode aww algorithm. Valid Range : (0x1,0xf) | |
|--|--|--|--|

Slave Window Adjustment

| Addr 16-bit | Addr 32-bit | Register Name | RW | Description | Reset |
|----------------|----------------|---------------|----|--|--------|
| 0x50C | 0xA18 | SLV_WIN_ADJ | RW | Programmable adjust value to add to the calculated window widen value. This allows the firmware to add flexibility to calculated value of drift - to compensate for any underestimated drift in the manufacturer specification of crystal drift. | 0x0010 |

| Field | Bit | Description | Reset |
|-------------|-------|--|-------|
| Reserved | 15:11 | Unused | 0x00 |
| Slv_win_adj | 10:0 | Window Adjust value. This value is added to the calculated slave window widening value to be used as final window widen value. | 0x10 |

slaveLatency x connInterval value

| Addr 16-bit | Addr 32-bit | Register Name | RW | Description | Reset |
|----------------|----------------|-------------------|----|--|-------|
| 0x50E | 0xA1C | SL_CONN_INTER VAL | RW | Programmable Register which holds the (slaveLatency * connInterval) value for the connection. | |

| Field | Bit | Description | Reset |
|----------------------|------|---|--------|
| Sl_conn_interval_val | 15:0 | This field defines the (SL*CI) product for the ongoing connection. This value is used in calculation of next connection instant during slave latency. | 0x0000 |

LE Ping timer address register

| Addr 16-bit | Addr 32-bit | Register Name | RW | Description | Reset |
|----------------|----------------|----------------------|----|---|--------|
| 0x510 | 0xA20 | CONN_PING_TIMER_ADDR | RW | The register used to configure the LE Authenticated payload Timeout (LE APTO) which is the Maximum amount of time specified between packets authenticated by a MIC. This value of ping timer is in the order of 10ms, valid range 0x1 ~ 0xFFFF | 0x0000 |

LE Ping connection timer offset

| Addr 16-bit | Addr 32-bit | Register Name | RW | Description | Reset |
|----------------|----------------|------------------------|----|---|--------|
| 0x512 | 0xA24 | CONN_PING_TIMER_OFFSET | RW | The value of ping timer nearly expired offset in the order of 10ms, valid range 0x0 ~ 0xFFFF. This is the time period after which the ping timer nearly expired interrupt is generated. | 0x0000 |

LE Ping timer next expiry instant

Link Layer

| Addr 16-bit | Addr 32-bit | Register Name | RW | Description | Reset |
|----------------|----------------|--------------------------|----|---|--------|
| 0x514 | 0xA28 | CONN_PING_TIMER_NEXT_EXP | RO | The value of ping timer next expiry instant in the terms of native clock value (least 16 bit value of the 17 bit ping counter). This together with CONN_PING_TIMER_NEXT_EXP_WRAP will provide the correct status of ping timer duration. | 0x0000 |

LE Ping timer next expiry wrap count

| Addr 16-bit | Addr 32-bit | Register Name | RW | Description | Reset |
|----------------|----------------|-----------------------|----|---|--------|
| 0x516 | 0xA2C | CONN_SEC_CURRENT_WRAP | RO | This register holds the current position of the Ping timer. | 0x0000 |

| Field | Bit | Description | Reset |
|-----------------------|------|---|-------|
| RESERVED | 15:9 | RFU | 0x0 |
| CONN_SEC_NEAR_WRAP | 8:5 | This field provides the time offset of the nearly expired event from the authentication payload timeout event. This offset is in the order of 40959.375 ms and specifies the time offset after starting the ping timer the nearly expired event will be generated. Time= N*40959.375 ms. | 0x0 |
| CONN_SEC_CURRENT_WRAP | 4:1 | This field provides the current position of the ping timer and the value is in the order of 40959.375 ms. Time= N*40959.375 ms For Example if the APTO configured in 655,350 ms and this field returns 10, it means | 0x0 |

Table continues on the next page...

| | | | |
|------------|---|--|-----|
| | | another 6 more units are remaining for the APTO event to be generated. | |
| WRAP_VALID | 0 | This field will be '1' from nearly expired event to the authenticated payload timeout or till the next reload of the ping timer. | 0x0 |

Connection Arbiter Parameter register

| Addr 16-bit | Addr 32-bit | Register Name | RW | Description | Reset |
|----------------|----------------|---------------------|----|--|-------|
| 0x102 | 0x204 | CONN_ARB_PAR AMS | RO | Register holds the highest priority request to the connection arbiter from the connection engines. | 0xF |

| Field | Bit | Description | Reset |
|------------------|------|---|-------|
| Reserved | 15:4 | Not used | -- |
| priority_pointer | 3:0 | Pointer for the highest priority request to the connection arbiter. | 0xF |

Conn_SUTO_CI_Ratio register

| Addr 16-bit | Addr 32-bit | Register Name | RW | Description | Reset |
|----------------|----------------|------------------------|----|--|--------|
| 0x104 | 0x208 | CONN_SUTO_CI_ RATIO | RW | Firmware programs this register with connection supervision timeout to connection interval ratio at the time of connection creation/connection update. | 0x0000 |

| Field | Bit | Description | Reset |
|-------|-------|-------------|-------|
| RFU | 15:13 | Not used | 0x0 |

Table continues on the next page...

Link Layer

| | | | |
|--------------------------|------|--|--------|
| conn_suto_ci_ratio[12:0] | 12:0 | This register will have the ratio of the connection supervision timeout to the connection interval as programmed by the firmware before a connection creation or a connection update. The value is used by hardware to update the priority of a connection link that is nearing connection timeout due to packet miss. | 0x0000 |
|--------------------------|------|--|--------|

Connection Priority Config register

| Addr | Addr 32-bit | Register Name | RW | Description | Reset |
|-------|-------------|--------------------|----|---|--------|
| 0x106 | 0x20C | CONN_PRIORITY_CNFG | RW | This register is used by the firmware to override the hardware priority and set the priority of each connection link in the connection arbiter. The value of Zero has the least priority. | 0x0000 |

| Field | Bit | Description | Reset |
|--------------|------|---|-------|
| priority_sel | 15 | If this bit is set to '1' connection arbiter will use the firmware programmed priority set in this register for each connection engine. | 0 |
| RFU | 14:6 | Not used | 0x0 |
| fw_priority1 | 5:3 | Firmware programmed priority for connection engine 1. | 0x0 |
| fw_priority0 | 2:0 | Firmware programmed priority for connection engine 0. | 0x0 |

Connection Update New SUP_TO to CI ratio

| Addr | Addr 32-bit | Register Name | RW | Description | Reset |
|------|-------------|---------------|----|-------------|-------|
|------|-------------|---------------|----|-------------|-------|

Table continues on the next page...

| | | | | | |
|-------|-------|---------------------------|----|--|--------|
| 0x1DA | 0x3B4 | CONN_UPDT_NEW_SU_CI_RATIO | RW | The Supervision Timeout to conn interval ratio that will be effective after the connection update instant. Firmware programs this register along with other connection update parameter registers. | 0x0000 |
|-------|-------|---------------------------|----|--|--------|

| Field | Bit | Description | Reset |
|------------------------|-------|---|--------|
| RFU | 15:13 | Not used. | 0x0 |
| conn_suto_ci_ratio_new | 12:0 | This register will have the new supervision timeout to connection interval ratio that the hardware will use after the connection update instant. Before the instant, the value in the register CONN_SUTO_CI_RATIO will be used by hardware. | 0x0000 |

Slave Window Offset Full register

| Addr 16-bit | Addr 32-bit | Register Name | RW | Description | Reset |
|----------------|----------------|-----------------|----|--|--------|
| 0x1DC | 0x3B8 | SL_WIN_OFF_FULL | RW | This register is programmed with the maximum possible window widen value by the firmware when dsm entry during slave latency feature is enabled. This value is used by the hardware to calculate the next ce instant being reported to firmware. | 0x0000 |

| Field | Bit | Description | Reset |
|-------|-----|-------------|-------|
|-------|-----|-------------|-------|

Table continues on the next page...

Link Layer

| | | | |
|--------------------|------|--|--------|
| RFU | 15:6 | Not used. | 0x0 |
| sl_window_off_full | 5:0 | Value of maximum possible window widen programmed by the firmware when slave latency dsm feature is enabled. | 0x0000 |

Connection RSSI register

| Addr 16-bit | Addr 32-bit | Register Name | RW | Description | Reset |
|----------------|----------------|---------------|----|--|--------|
| 0x518 | 0xA30 | CONN_RX_RSSI | RO | This connection register holds the RSSI value of the last good (empty/non-empty) packet received by the specific connection. | 0x0000 |

| Field | Bit | Description | Reset |
|--------------|------|---|--------|
| conn_rx_rssi | 15:0 | RSSI during the last good packet received in the specific connection. | 0x0000 |

Connection Rx Memory read enable register

| Addr 16-bit | Addr 32-bit | Register Name | RW | Description | Reset |
|----------------|----------------|---------------------------------|----|---|--------|
| 0x522 | 0xA44 | LLH_MEM_READ_ENABLE_CONTROL_REG | WO | This register is used by the firmware to control read access to the connection Rx memory. | 0x0000 |

| Field | Bit | Description | Reset |
|--------------------|-------|--|-------|
| Reserved | 15:14 | Not Used | 0x0 |
| conn_rxmem_rd_ctrl | 0 | When this bit is '1', connection Rx memory is enabled. | 0 |

45.6.1.1.4 Test and Debug Registers

Test and Debug Register Descriptions for the Bluetooth Link Layer

DTM control register

| Addr 16-bit | Addr 32-bit | Register Name | RW | Description | Reset |
|----------------|----------------|-----------------|----|---|--------|
| 0xB8 | 0x170 | LE_RF_TEST_MODE | RW | LE Direct Test Mode (DTM) configuration and control register. Used to control the direct test mode (DTM) operation. | 0x0000 |

| Field | Bit | Description | Reset |
|------------------|-------|--|-------|
| Test_length[5:0] | 15:10 | 0x00-0x25 Length in bytes of payload data in each packet 0x3F – Continuous Transmit mode with 1010 pattern. 0x26-0xFF(except 0x3F) Reserved for future use | 0 |
| Pkt_payload[2:0] | 9:7 | Payload type as per the HCI parameter. 0x00 Pseudo-Random bit sequence 9 0x01 Pattern of alternating bits '11110000' 0x02 Pattern of alternating bits '10101010' 0x03 Pseudo-Random bit sequence 15 0x04 Pattern of All '1' bits 0x05 Pattern of All '0' bits 0x06 Pattern of alternating bits '00001111' 0x07 Pattern of alternating bits '0101' 0x08-0xFF Reserved for future use | 0 |
| Test_type | 6 | Mixed Info Field. Read: 1 – Indicates DTM test ON | 0 |

Table continues on the next page...

Link Layer

| | | | |
|---------------------|-----|---|---|
| | | 0 – Indicates DTM test OFF Write: 1 – To enable continuous receive mode 0 – To disable continuous receive mode | |
| Test_frequency[5:0] | 5:0 | $N = (F - 2402) / 2$ Range: 0x00 – 0x27. Frequency Range : 2402 MHz to 2480 MHz | 0 |

DTM receive packet count register

| Addr 16-bit | Addr 32-bit | Register Name | RW | Description | Reset |
|----------------|----------------|----------------------|----|--|--------|
| 0xBA | 0x174 | DTM_RX_PKT_CO UNT | RO | Count of the number of LE packets received when device is configured in receive test mode. | 0x0000 |

| Field | Bit | Description | Reset |
|-----------------------|------|--|-------|
| Rx_packet_count[15:0] | 15:0 | Number of packets received in receive test mode. | 0 |

Connection channel test control register

| Addr 16-bit | Addr 32-bit | Register Name | RW | Description | Reset |
|----------------|----------------|-----------------------|----|--|--------|
| 0xBC | 0x178 | CONN_TEST_CO NTROL | RW | Connection test control register. To introduce test behavior in the operation of connection. | 0x0000 |

| Field | Bit | Description | Reset |
|---------------------|------|--|-------|
| Reserved | 15:8 | Reserved for future use | 0 |
| Nonempty_pdu_rxnack | 7 | NACK the received packet, if rx packet is a NON-EMPTY PDU. | 0 |

Table continues on the next page...

| | | | |
|-------------------|---|--|---|
| | | <p>1 – Always NACK (no acknowledgement)</p> <p>0 – No change from normal behavior</p> | |
| Empty_pdu_rxnack | 6 | <p>NACK received packet, if rx packet is an EMPTY PDU.</p> <p>1 – Always NACK</p> <p>0 – No change from normal behavior</p> | 0 |
| Nonempty_pdu_retx | 5 | <p>Retransmit previous transmitted non-empty PDU irrespective of received NESN (whether acknowledged or not).</p> <p>1 – Always retransmit</p> <p>0 – No change from normal behavior</p> | 0 |
| empty_pdu_retx | 4 | <p>Retransmit previous transmitted empty PDU irrespective of received NESN (whether acknowledged or not).</p> <p>1 – Always retransmit</p> <p>0 – No change from normal behavior</p> | 0 |
| Nonempty_crc_err | 3 | <p>Cause CRC field error in transmitted non-empty PDU (only).</p> <p>1 – Causes CRC error</p> <p>0 – no change from normal behavior</p> | 0 |
| empty_crc_err | 2 | <p>Cause CRC field error in transmitted empty PDU (only).</p> <p>1 – Causes CRC error</p> <p>0 – no change from normal behavior</p> | 0 |
| Nonempty_acc_err | 1 | <p>Causes Access address error in transmitted non-empty PDU.</p> <p>1 – Causes access address error</p> <p>0 – no change from normal behavior</p> | 0 |
| empty_acc_err | 0 | <p>Causes Access address error in transmitted empty PDU.</p> <p>1 – Causes access address error</p> | 0 |

Link Layer

| | |
|--|------------------------------------|
| | 0 – no change from normal behavior |
|--|------------------------------------|

Advertising channel test control register

| Addr 16-bit | Addr 32-bit | Register Name | RW | Description | Reset |
|----------------|----------------|--------------------|----|---|--------|
| 0xBE | 0x17C | ADVCH_TEST_CONTROL | RW | Advertising channel test control register. To introduce advertising channel test control operation. | 0x0000 |

| Field | Bit | Description | Reset |
|----------------|------|---|-------|
| Reserved | 15:7 | Reserved for future use | 0 |
| Scan_tx_hdr | 6 | Corrupt the tx header of SCAN_REQ packet 1 – corrupt the address 0 – no change | 0 |
| Peer_addr_err | 5 | Corrupt the peer address field in the SCAN_REQ packet 1 – corrupt the address 0 – no change | 0 |
| Rcv_txaddr_err | 4 | Corrupt the received transmit address type indication 1 – corrupt the tx address type (invert the bit) 0 – no change | 0 |
| Scnrsp_tx_err | 3 | Introduce CRC error in scan response packet. 1 – corrupt CRC 0 – no change | 0 |
| Rx_crc_err | 2 | Receive packet CRC error indication. 1 – Indicate CRC error of received packet, irrespective of good/bad CRC 0 – No change from normal behavior | 0 |
| Tx_crc_err | 1 | Corrupt transmit packet CRC, irrespective of packet type. | 0 |

Table continues on the next page...

| | | | |
|------------|---|--|---|
| | | 1 – Corrupt CRC 0 – No change in normal behavior This is done by corrupting the <code>crc_init</code> value. | |
| Tx_acc_err | 0 | Corrupt transmit packet access address. 1 – Corrupt access address 0 – No change in normal behavior | 0 |

DTM Error Count

| Addr 16-bit | Addr 32-bit | Register Name | RW | Description | Reset |
|----------------|----------------|-------------------|----|---|--------|
| 0xC0 | 0x180 | DTM_CRC_ERR_COUNT | RO | Indicates number of packets received with CRC error in the DTM mode | 0x0000 |

| Field | Bit | Description | Reset |
|-----------------------|--------|--|-------|
| dtm_crc_err_pkt_count | [15:0] | DTM CRC error packet count. Used for Debug purpose only. | 0 |

Channel Address register

| Addr 16-bit | Addr 32-bit | Register Name | RW | Description | Reset |
|----------------|----------------|----------------------|----|--|--------|
| 0xC4 | 0x188 | CH_ADDR/ TXRX_HOP | RO | Contains value of the transmit and receive hop frequency | 0x0000 |

| Field | Bit | Description | Reset |
|-----------|--------|--|-------|
| reserved | 15 | Reserved for future use | 0 |
| hop_ch_rx | [14:8] | Receive channel index. Channel index on which previous packet is received. | 0 |
| reserved | 7 | Reserved for future use | 0 |

Table continues on the next page...

Link Layer

| | | | |
|-----------|-------|--|---|
| hop_ch_tx | [6:0] | Transmit channel index. Channel index on which previous packet is transmitted. | 0 |
|-----------|-------|--|---|

Divider Value Register for SCA

| Addr 16-bit | Addr 32-bit | Register Name | RW | Description | Reset |
|----------------|----------------|---------------|----|--|--------|
| 0x500 | 0xA00 | DIV_VAL_ADDR | RW | This value will go to divide by N module to derive various sleep clock frequencies | 0x1F3C |

| Reference Clock | Divider Value | Output Sleep Frequency(kHz) | PPM | SCA |
|-----------------|---------------|-----------------------------|------------|-----------|
| Decimal | Hex | | | |
| 16.384 kHz | 7808 | 1E80 | 16.39351 | 580.59674 |
| 7809 | 1E81 | 16.39135 | 448.73375 | 0 |
| 7810 | 1E82 | 16.38920 | 317.56129 | 0 |
| 7811 | 1E83 | 16.38722 | 196.25739 | 1 |
| 7812 | 1E84 | 16.38501 | 61.54619 | 4 |
| 7813 | 1E85 | 16.38287 | -69.19713 | 4 |
| 7814 | 1E86 | 16.38097 | -185.16635 | 1 |
| 7815 | 1E87 | 16.37870 | -323.70446 | 0 |
| 7816 | 1E88 | 16.37668 | -446.48984 | 0 |
| 16 kHz | 7996 | 1F3C | 16.00811 | 507.13706 |
| 7997 | 1F3D | 16.00610 | 380.94506 | 0 |
| 7998 | 1F3E | 16.00414 | 258.94704 | 0 |
| 7999 | 1F3F | 16.00221 | 137.93902 | 2 |
| 8000 | 1F40 | 15.99992 | -4.79998 | 7 |
| 8001 | 1F41 | 15.99786 | -133.74211 | 2 |
| 8002 | 1F42 | 15.99585 | -259.13283 | 0 |
| 8003 | 1F43 | 15.99392 | -380.01553 | 0 |
| 8004 | 1F44 | 15.99192 | -505.02482 | |

A macro 'SCA_DRIFT' is used to select the clock source for the Sleep Clock.

When the SCA_DRIFT macro is enabled then the sleep clock source is derived from the 64MHz based on the register DIV_VAL_ADDR setting. Otherwise sleep clock source is the on board 32.768 kHz

From 64 MHz of RF clock either 16 kHz or 16.384 kHz clock is derived using DCM (Digital Clock Manager, clock multiplier by 2) and a clock divider (divide by N). 64 MHz clock is given to DCM and this multiplied clock of 128 MHz is given to divide by N module. With 64 MHz clock only, it was not possible to cover lower, middle and upper range of required SCA (0 to 7) that led to use a DCM to get a higher clock and desired SCA values.

Clock divider value is given into a Programmable Read/Write register DIV_VAL_ADDR, whose address is 0x500 for 16 bit address bus.

Config.xml file is having all power up configuration parameters for BlueLitE IP. This will be loaded into Hardware after Reset.

For the validation, In order to introduce SCA other than '0' which is by default configuration of BlueLitE IP, one has to change corresponding "sca" field in config.xml file also. E.g. if one has selected SCA of 4 from table 2 given, then DIV_VAL_ADDR has to be programmed with 0x1E84 for positive ~61 PPM or 0x1E85 for negative ~69 PPM and "sca" field in config.xml has to be updated with 0x04.

Whenever SCA value is chosen from sleep clock frequency of 16 kHz, at that time internal adjustment for sleep clock frequency is not required. For that "clock_config" field in config.xml has to be updated with 0xA020.

DTM 2 wire UART Baud rate configuration

| Addr 16-bit | Addr 32-bit | Register Name | RW | Description | Reset |
|----------------|----------------|----------------------|----|---|--------|
| 0x580 | 0xB00 | DTM_2WIRE_CON FIG | RW | This value will go to different baud rate generator module for DTM 2 wire UART. | 0x006F |

| Field | Bit | Description | Reset |
|-----------------------|------|---|--------|
| dtm_2wire_baud_config | 15:0 | This value will be given to baud clock generator module. For different input clock frequency to LLH, this value will be different to generate corresponding baud clock as mentioned in below table. | 0x006F |

| Radio clock | Baud rate | Configuration Value |
|-------------|-----------|---------------------|
| 26 MHz | 1200 | 0x2A3B |
| 2400 | 0X151E | |
| 9600 | 0X0546 | |
| 14400 | 0X0384 | |
| 19200 | 0X02A1 | |
| 38400 | 0X0152 | |
| 57600 | 0X00E1 | |
| 115200 | 0X006F | |
| 32MHz | 1200 | |
| 2400 | 0X0CFE | |
| 9600 | 0X033E | |
| 14400 | 0X0229 | |
| 19200 | 0X019E | |
| 38400 | 0X00D0 | |
| 57600 | 0X008A | |
| 115200 | 0X0042 | |

45.6.1.1.5 Interface Registers

Interface Register Descriptions for the Bluetooth Link Layer

Receive trigger control register

| Addr 16-bit | Addr 32-bit | Register Name | RW | Description | Reset |
|----------------|----------------|-----------------------|----|--|--------|
| 0XFC | 0X1F8 | RECEIVE_TRIG_C TRL | RW | Receivers trigger control register. The threshold value for access address match, the access match trigger timeout is programmed to this register by firmware. | 0x0000 |

| Field | Bit | Description | Reset |
|---------------------|------|--|-------|
| Acc_trigger_timeout | 15:8 | If access address match does not occur then within this time from the start of receive | 0 |

Table continues on the next page...

| | | | |
|-----------------------|-----|--|---|
| | | operation, the receive operation times out and stops. An internal counter value of 1usec resolution is continuously compared with the value programmed. Max value :0Xff | |
| Reserved | 7 | Not used–RFU | 0 |
| | 6 | RFU | |
| Acc_trigger_threshold | 5:0 | Access address match threshold value. Number of bits of access address that should match with the expected access address to trigger an access code match. Max value : 32 (for 32-bit access address) Lower values may be programmed for bad radios or channels but care must be taken to ensure there are no 'false' matches due to reduced number of bits required to match. NOTE: BQB spec mandates this to be 32. So ensure that the standard versions have 32. For debugging or RF tuning, we can experiment with smaller values. | 0 |

Transmit/Receive data delay Register

| | | | | | |
|------|-------|--------------------|----|--|--------|
| 0xC8 | 0x190 | TX_RX_ON_DELA Y | RW | Controls the delay in link layer from internal reference point, to start the transmit and receive operation. | 0x0000 |
|------|-------|--------------------|----|--|--------|

| Field | Bit | Description | Reset |
|-----------------|------|---|-------|
| Txon_delay[7:0] | 15:8 | Transmit delay – Delay from internal trigger of transmit to transmission of first bit on air. It is used to control the T_IFS. The delay is in resolution of 1 microsecond. | 0x00 |

Table continues on the next page...

Link Layer

| | | | |
|-----------------|-----|---|------|
| Rxon_delay[7:0] | 7:0 | Receive delay – Delay from start of receive to expected first bit of receive packet at the controller. Used to control the turn on time of radio to optimize on power. The delay is in resolution of 1 microsecond. | 0x00 |
|-----------------|-----|---|------|

Transmit/receive synthesizer delay register

| | | | | | |
|------|-------|-------------------|----|---|--------|
| 0xCC | 0x198 | TX_RX_SYNTH_DELAY | RW | Controls the link layer behavior after waiting for TSM Warmup Time. | 0x0000 |
|------|-------|-------------------|----|---|--------|

| Field | Bit | Description | Reset |
|---------------------|------|--|-------|
| Tx_synth_delay[7:0] | 15:8 | Transmit synthesizer delay – For KW41 this value is derived from equation in XCVR_INIT based solely on TSM TX warmup time. | 0x00 |
| Rx_synth_delay[7:0] | 7:0 | Receive synthesizer delay – For KW41 this value is derived from equation in XCVR_INIT based solely on TSM RX warmup time. | 0x00 |

RSSI Register

| | | | | | |
|------|-------|-----------------|----|---|--------|
| 0xD8 | 0x1B0 | RADIO_RSSI_READ | RO | Indicates the RSSI value read from the radio for the last packet received. Mixed-info-field/register | 0x0000 |
|------|-------|-----------------|----|---|--------|

| Field | Bit | Description | Reset |
|-----------|------|--|-------|
| Rssi_data | 15:0 | Indicates the RSSI value read from the radio for the last packet received. The meaning is specific to the RF IC used. Mixed-info-field/register | 0x0 |

BLE_RF_ACTIVE_PERIOD register

| | | | | | |
|------|-------|----------------------|----|---|--------|
| 0x5A | 0x0B4 | ble_rf_active_period | RW | <ul style="list-style-type: none"> Register to specify the time offset before the start of a transceiver operation (i.e., a Tx/Rx) at which "BLE_RF_ACTIVE" output signal shall be asserted by the LLH. The purpose of the "BLE_RF_ACTIVE" signal is to indicate to the host of any upcoming transceiver activity. The host may schedule not to do any power intensive operations during this time to reduce the system peak power. BLE_RF_ACTIVE is a preemption signal for the system power management system to be ready for the upcoming radio operation. The time offset is specified in the units of BT slots (625us). <p>NOTE: The BLE_RF_ACTIVE signal will be asserted at the specified time offset before a transceiver operation and remain asserted till the end of the operation.</p> <p>NOTE: During multichannel advertising the BLE_RF_ACTIVE signal will only remain asserted for the first channel event. Subsequent channel events will not generate a BLE_RF_ACTIVE signal. The system power management should use this first BLE_RF_ACTIVE signal to transition to ready state for the duration of the multichannel advertising event.</p> | 0x0000 |
|------|-------|----------------------|----|---|--------|

| Field | Bit | Description | Reset |
|---------------------|------|---|-------|
| Reserved | 15:7 | RFU | xx |
| ble_rf_active_slots | 6 | Polarity bit for ble_rf_active 0: active high 1: active low. | |
| ble_rf_active_slots | 5:0 | Number of BT slots (625 us) in advance of the actual start of the slot (tx/Rx) to assert ble_rf_active. "ble_rf_active" is always de-asserted when the value is 6'h0 (all zeros) and always asserted when the value is 6'h3F(all ones) Therefore the Min. value is 625 us and the Max value is 62*625 us. | 0 |

45.6.1.1.6 Instruction Set

Instruction Set Description for the Bluetooth Link Layer

Instruction Set

| Command | Opcode | Description |
|--------------|--------|---|
| START_ADV | 0x40 | Start Advertiser operation. The associated Advertiser configuration registers are programmed before the command is issued. [refer to llh_set_adv_parameters function in lec_llh/simulation/llh_driver/ll_hardware_api.c file] |
| STOP_ADV | 0x41 | Stop advertiser operation. |
| START_SCAN | 0x42 | Start scanner operation. The associated configuration registers must be programmed before the command is issued. [refer to llh_set_scan_parameters function in lec_llh/simulation/llh_driver/ll_hardware_api.c file] |
| STOP_SCAN | 0x43 | Stop the scanner operation. |
| START_INIT | 0x44 | Start connection creation operation. The associated configuration registers must be programmed before the command is issued. [refer to create_connection function in lec_llh/simulation/llh_driver/ll_hardware_api.c file] |
| STOP_INIT | 0x45 | Cancel connection creation operation. |
| DTM_TX_START | 0x46 | Start Direct Test Mode Transmit Test. The associated configuration registers must be programmed before the command is issued. [refer to dtm_tx_test function in lec_llh/simulation/llh_driver/ll_hardware_api.c file] |
| DTM_RX_START | 0x47 | Start Direct Test Mode Receive Test. The associated configuration registers must be programmed before the command is issued. |

Table continues on the next page...

| | | |
|----------------------|------|---|
| | | [refer to dtm_rx_test function in lec_llh/simulation/llh_driver/ll_hardware_api.c file] |
| DTM_STOP | 0x48 | Stop Direct Test Mode. |
| UPDATE_CHAN_MAP | 0x4B | Update channel map for the connection. |
| UPDATE_CONN_INSTANT | 0x4C | Start connection update procedure for the connection. |
| PACKET_RECEIVED | 0x4D | Indicates a received connection packet is read by firmware from connection receive FIFO. |
| ENTER_DSM | 0x50 | Enter deep sleep mode. |
| ENTER_SM | 0x51 | Enter sleep mode. |
| EXIT_SM | 0x52 | Exit sleep mode |
| ENC_CLK_ON | 0x53 | Turn on clock to encryption block |
| ENC_CLK_OFF | 0x54 | Turn off clock to encryption block |
| ADV_CLK_ON | 0x55 | Turn on clock to advertiser block in NAP mode. |
| ADV_CLK_OFF | 0x56 | Turn off clock to advertiser block in NAP mode. |
| SCAN_CLK_ON | 0x57 | Turn on clock to scanner block in NAP mode. |
| SCAN_CLK_OFF | 0x58 | Turn off clock to scanner block in NAP mode. |
| INIT_CLK_ON | 0x59 | Turn on clock to initiator block in NAP mode. |
| INIT_CLK_OFF | 0x5a | Turn off clock to initiator block in NAP mode. |
| CONN_CLK_ON | 0x5b | Turn on clock to connection block in NAP mode. |
| CONN_CLK_OFF | 0x5c | Turn off clock to connection block in NAP mode. |
| UPDATE_CONN | 0x68 | Update connection parameters. Deprecated. |
| KILL_CONN | 0x70 | Kill connection immediately. |
| KILL_CONN_AFTER_TX | 0x71 | Kill connection after a transmit operation is over. |
| RESET_US_COUNTER | 0xc3 | Reset microsecond counter |
| RESP_TIMER_ON | 0x72 | Start PDU response timer. The PDU_RESP_TIMER register must be programmed with timeout value before issuing this command. |
| RESP_TIMER_OFF | 0x73 | Stop PDU response timer. |
| RESET_READ_PTR | 0x74 | Reset the white list memory read pointer to 0. |
| *CONN_PING_TIMER_ON | 0x75 | Start connection ping timer |
| *CONN_PING_TIMER_OFF | 0x76 | Stop connection ping timer |

Table continues on the next page...

Link Layer

| | | |
|--------------------|------|---------------------------------------|
| ENTER_DSM_SHUTDOWN | 0x77 | Enter deep sleep mode with shutdown |
| STORE_START | 0x78 | Firmware triggers the store process |
| RESTORE_START | 0x79 | Firmware triggers the restore process |
| DATA_RESTORE_ON | 0x7A | Firmware data restore enable |
| DATA_RESTORE_OFF | 0x7B | Firmware data restore disable |
| START_RPA_TIMER | 0x7C | Start Privacy RPA timer |
| STOP_RPA_TIMER | 0x7D | Stop Privacy RPA timer |
| START_RPA_GEN | 0x7E | Start RPA address generation |

45.6.1.2 BLE_RF Register Descriptions

45.6.1.2.1 BTLE_RF Memory Map

| Offset | Register | Width (In bits) | Access | Reset value |
|-----------|--|--------------------|--------|------------------|
| 4005B600h | BLUETOOTH LOW ENERGY PART ID (BLE_PART_ID) | 16 | RO | 0003h |
| 4005B604h | BLE DSM STATUS (DSM_STATUS) | 16 | RO | See description. |
| 4005B608h | BLUETOOTH LOW ENERGY MISCELLANEOUS CONTROL (MISC_CTRL) | 16 | RW | 0000h |

45.6.1.2.2 BLUETOOTH LOW ENERGY PART ID (BLE_PART_ID)

45.6.1.2.2.1 Address

| Register | Offset |
|-------------|-----------|
| BLE_PART_ID | 4005B600h |

45.6.1.2.2.2 Diagram

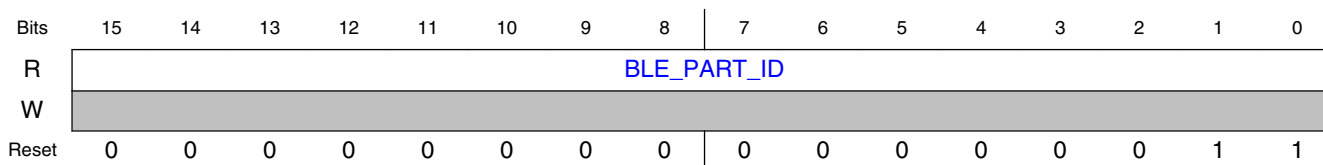

45.6.1.2.2.3 Fields

| Field | Function |
|---------------------|---|
| 15-0 BLE_PART_ID | BLE Part ID 0000000000000000b - Pre-production 0000000000000001b - Pre-production 0000000000000010b - KW40Z 0000000000000011b - KW41Z |

45.6.1.2.3 BLE DSM STATUS (DSM_STATUS)

45.6.1.2.3.1 Address

| Register | Offset |
|------------|-----------|
| DSM_STATUS | 4005B604h |

45.6.1.2.3.2 Function

BLE Deep Sleep Mode Status Register

45.6.1.2.3.3 Diagram

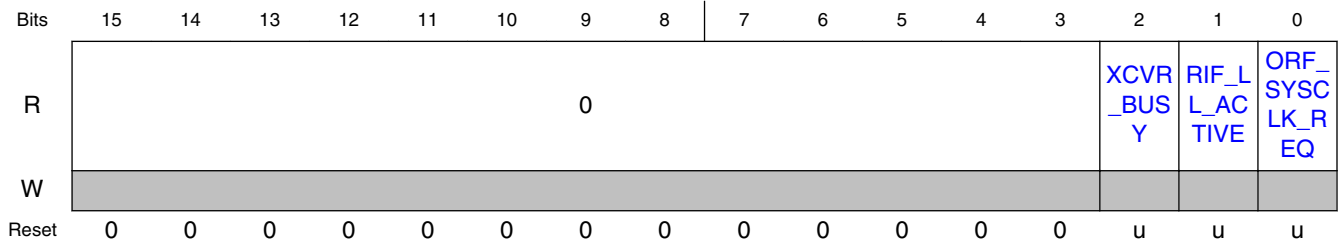

45.6.1.2.3.4 Fields

| Field | Function |
|----------------|---|
| 15-3 — | Reserved. |
| 2 XCVR_BUSY | Transceiver Busy Status Bit 0b - RF Channel in available (TSM is idle) 1b - RF Channel in use (TSM is busy) |
| 1 | Link Layer Active |

Table continues on the next page...

Link Layer

| Field | Function |
|-----------------|--|
| RIF_LL_ACTIVE | Reflects the state of the BLE LL output of the same name, the signal to be used by the host as an 'early' indication to prevent host to do any operations while the BLE block is doing transceiver operations, so as to reduce the peak power and noise. |
| 0 | RF Oscillator Requested |
| ORF_SYSCCLK_REQ | Reflects the state of the BLE LL output of the same name, the control signal used to enable/disable the RF Oscillator for entry and exit from DSM (deep sleep mode). |

45.6.1.2.4 BLUETOOTH LOW ENERGY MISCELLANEOUS CONTROL (MISC_CTRL)

45.6.1.2.4.1 Address

| Register | Offset |
|-----------|-----------|
| MISC_CTRL | 4005B608h |

45.6.1.2.4.2 Function

BLE Miscellaneous Control Register

45.6.1.2.4.3 Diagram

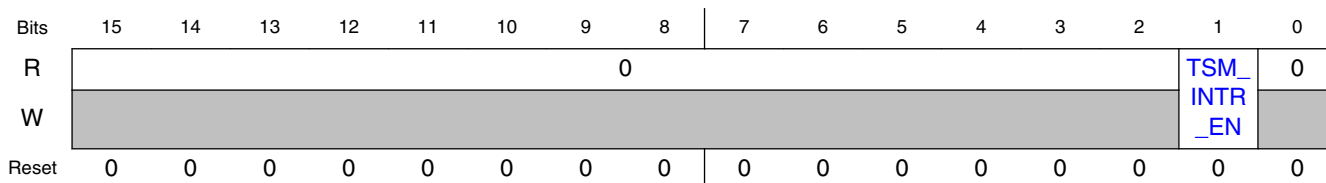

45.6.1.2.4.4 Fields

| Field | Function |
|------------------|--|
| 15-2 — | Reserved. |
| 1 TSM_INTR_EN | TSM Interrupt Enable This control bit enables the TSM Interrupt for BLE. If TSM_INTR_EN=1 and a TSM Interrupt occurs during a BLE TX or RX operation, bit [8] of the BLE EVENT_STATUS register will become set. 0b - a TSM Interrupt during a BLE TX or RX sequence will not set bit [8] of BLE EVENT_STATUS 1b - a TSM Interrupt during a BLE TX or RX sequence will set bit [8] of BLE EVENT_STATUS |
| 0 — | Reserved. |

45.6.2 802.15.4 Link Layer Controller

45.6.2.1 Introduction

The 802.15.4 Link Layer Controller implements all hardware functionality of the 802.15.4 Link Layer.

45.6.2.2 Overview

The 802.15.4 Link Layer implementation is divided into software and hardware components. The 802.15.4 Link Layer Controller represents the hardware component of the link layer. Link Layer hardware functionality is further sub-divided into functional blocks. These blocks include:

- Packet Processor block.
- Sequence Manager block.
- Packet Storage block.
- Event Timer block.
- Interrupts block.
- Clear Channel Assessment/Energy Detect/Link Quality Indication block.
- Bit Streaming Mode block.

Together, these blocks implement and accelerate critical functions of the 802.15.4 Link Layer. The non-timing critical functions are implemented in software on a MCU.

45.6.2.3 Block Diagram

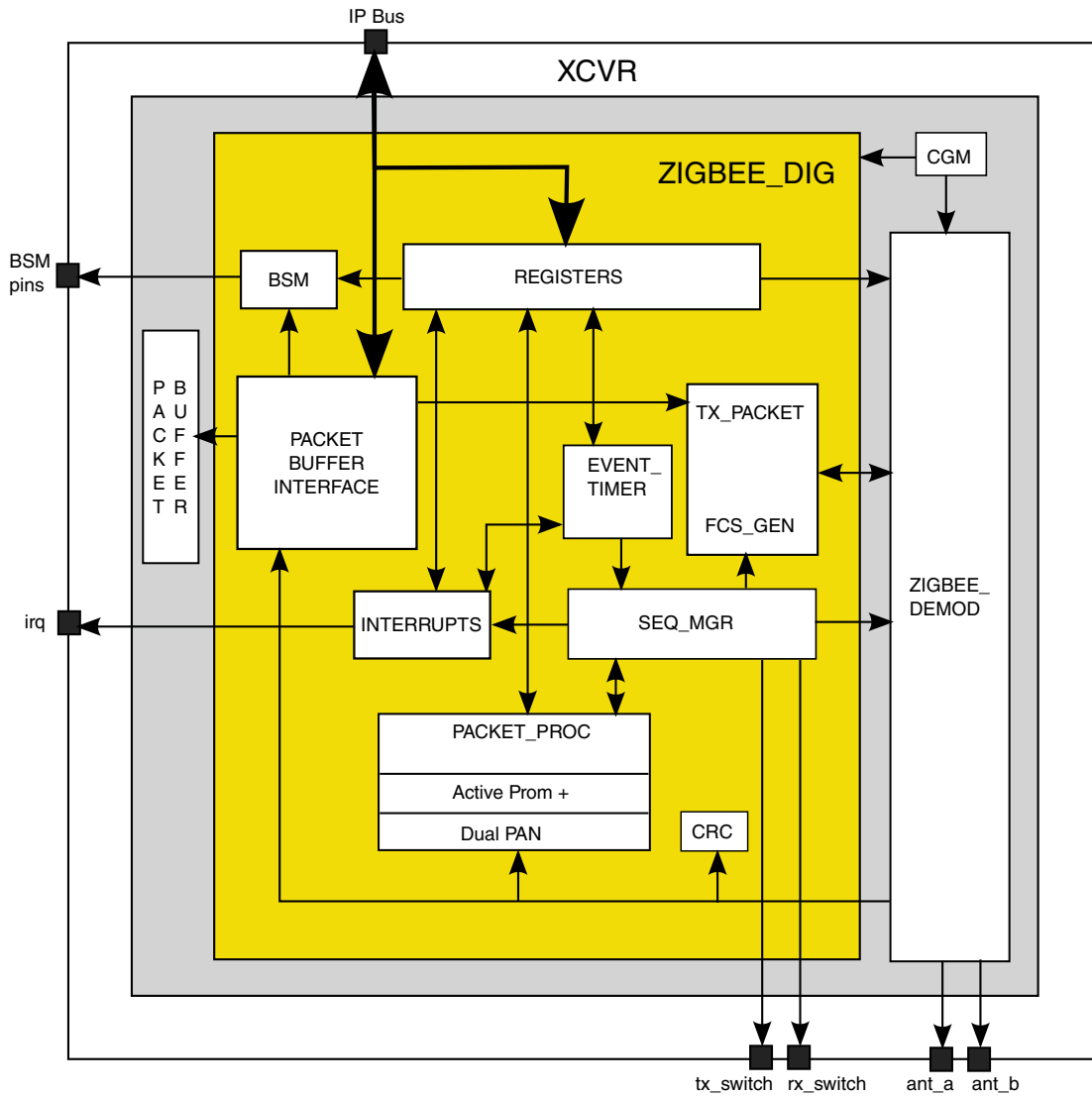

Figure 45-68. 802.15.4 Link Layer Controller Block Diagram

45.6.2.4 Functional Description

45.6.2.5 Packet Processor

45.6.2.5.1 Introduction

The 802.15.4 Packet Processor performs sophisticated hardware filtering of the incoming received packet, to determine whether the packet is both PHY- and MAC-compliant, whether the packet is addressed to this device, and if the device is a PAN Coordinator, whether a message is pending for the sending device. The packet processor greatly reduces the packet filtering burden on software, allowing software to tend to higher-layer tasks with a lower latency and smaller software footprint.

Table 45-33. References

| Revision | Title |
|--------------------------|---|
| IEEE Std 802.15.4 -2003 | Part 15.4: Wireless Medium Access Control (MAC) and Physical Layer (PHY) Specifications for Low-Rate Wireless Personal Area Networks (LR-WPANs) |
| IEEE Std 802.15.4 -2006 | 802.15.4: Wireless Medium Access Control (MAC) and Physical Layer (PHY) Specifications for Low-Rate Wireless Personal Area Networks (WPANs) |
| IEEE Std 802.15.4 -2011 | Part 15.4: Low-Rate Wireless Personal Area Networks (LR-WPANs) |
| IEEE Std 802.15.4e™-2012 | Part 15.4: Low-Rate Wireless Personal Area Networks (LR-WPANs) (Amendment to IEEE Std 802.15.4™-2011) |
| IEEE Std 802.15.4 -2015 | Part 15.4: Low-Rate Wireless Personal Area Networks (LR-WPANs) (Amendment to IEEE Std 802.15.4-2011) |

45.6.2.5.1.1 Overview

The 802.15.4 Packet Processor performs aggressive hardware filtering of the incoming packet as it is being received, to increase battery life by not awakening the MCU to process packets which are non-compliant or not addressed to the device, or that violate the 802.15.4 MAC Frame structure. The advanced frame parsing enables the sequence manager to handle complex sequences, by, for example, determining whether a receive frame requires an acknowledge, and generating the Sequence Number for that acknowledge, so that the transmit/receive combination sequence can be executed without any MCU intervention. Finally, the packet processor includes a hardware accelerator that allows the device to handle a critical timing requirement that had been problematic for 8-bit MCU's in the past: the quick-turnaround requirement for an indirect queue-lookup to determine the correct response to an end device sending a data polling request. The packet processor contains a register-based table of end devices which have messages pending, allowing a single-cycle hardware table lookup to be performed, and a minimum-turnaround-time acknowledge packet to be sent to the end device without MCU intervention. The packet processor also includes support for Dual PAN mode, which allows the device to simultaneously reside on 2 networks, with 2 separate IEEE addresses. And the packet processor also supports Active Promiscuous mode, which allows address filtering rules to be bypassed, while still enabling the device to automatically acknowledge packets which are addressed to the device.

45.6.2.5.1.2 Features

- Aggressive packet filtering to enable long, uninterrupted MCU sleep periods
- Fully compliant with both 2003 and 2006 versions of the 802.15.4 wireless standard
- Supports all Frame Types, including reserved types
- Supports all valid 802.15.4 Frame Lengths
- Enables auto-Tx Acknowledge frames (no MCU intervention) by parsing of Frame Control Field and Sequence Number
- Supports all Source and Destination Address modes, and also PAN ID Compression
- Supports Broadcast address for PAN ID and short address mode
- Supports “Promiscuous” mode, to receive all packets regardless of address- and rules-checking
- Allows Frame Type-specific filtering (e.g., reject all but Beacon frames)
- Supports SLOTTED and non-SLOTTED modes
- Includes special filtering rules for PAN Coordinator devices
- Enables minimum-turnaround TX-Acknowledge frames for data-polling requests by automatically determining message-pending status
- Assists MCU in locating pending messages in its indirect queue for data-polling end devices
- Assists MCU in determining if a poll request originated from a valid child end device
- Makes available to MCU detailed status of frames which fail address- or rules-checking
- Supports Dual PAN mode, allowing the device to exist on 2 PAN’s simultaneously
- Supports 2 IEEE addresses for the device
- Supports Active Promiscuous Mode
- Includes provisions to enable software support of 802.15.4e and 802.15.4-2015 frame types and versions

45.6.2.5.1.3 Block diagram

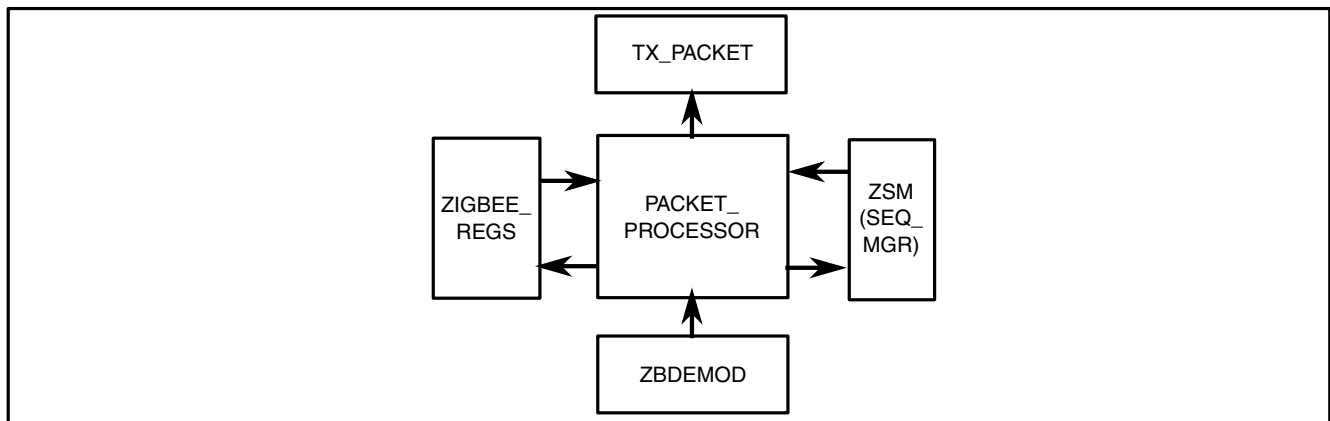

Figure 45-69. Block diagram

45.6.2.5.2 Memory Map and register definition

Numerous registers exist to provide configuration and status for the 802.15.4 Packet Processor.

The memory-mapped registers which affect the Packet Processor are described in the table below.

| Field | R/W | Description |
|-----------------|-----|---|
| PI | r | <p>Poll Indication:</p> <p>1: the received packet was a data request, regardless of whether a source-address table-match occurred, and regardless of whether source-address matching is enabled (see SRCADDR_EN bit);</p> <p>0: the received packet was not a data request</p> <p>PI is a read-only bit.</p> |
| SRCADDR | r | <p>If Source Address Management is engaged, meaning at least one of the following bits is set:</p> <ul style="list-style-type: none"> • SAPO_EN • SAA0_EN • SAP1_EN • SAA1_EN <p>then SRCADDR will be set to 1 if the packet just received is a poll request (PI=1), and at least one of the following conditions is met:</p> <ul style="list-style-type: none"> • SAPO_EN && SAPO_ADDR_PRESENT • SAA0_EN && SAA0_ADDR_ABSENT • SAP1_EN && SAP1_ADDR_PRESENT • SAA1_EN && SAA1_ADDR_ABSENT <p>If SRCADDR=1, this indicates to SW that the Packet Processor has determined that an auto-TxACK frame must be transmitted with the FramePending subfield of the FrameControlField set to 1. HW will assemble and transmit this Ack packet.</p> <p>If the above conditions are not met, SRCADDR will be cleared to 0.</p> |
| SAP0_EN | rw | <p>1: Enables SAP0 Partition</p> <p>0: Disables SAP0 Partition</p> |
| SAA0_EN | rw | <p>1: Enables SAA0 Partition</p> <p>0: Disables SAA0 Partition</p> |
| SAP1_EN | rw | <p>1: Enables SAP1 Partition</p> <p>0: Disables SAP1 Partition</p> |
| SAA1_EN | rw | <p>1: Enables SAA1 Partition</p> <p>0: Disables SAA1 Partition</p> |
| SAA0_START[6:0] | rw | First Index of SAA0 partition. |
| SAP1_START[6:0] | rw | First Index of SAP1 partition. |
| SAA1_START[6:0] | rw | First Index of SAA1 partition. |

Table continues on the next page...

Link Layer

| Field | R/W | Description |
|------------------------|-----|---|
| SAM_CHECKSUM[15:0] | | Software-computed source address checksum, to be installed into a table index |
| SAM_INDEX[6:0] | | Contains the table index to be enabled or invalidated. Software must ensure that the index is within the range of the desired partition. |
| SAM_INDEX_WR | w | For 32-bit writes, SAM_INDEX_WR must be set to indicate that the table entry specified by SAM_INDEX[6:0] is to be written; if SAM_INDEX_WR=0, the table entry is not written, but the SAM_INDEX[6:0] register is updated. For 8-bit writes, this bit is ignored. |
| SAM_INDEX_EN | w | Enable the index selected by SAM_INDEX[6:0] for searching. |
| SAM_INDEX_INV | w | Invalidate the index selected by SAM_INDEX[6:0] |
| FIND_FREE_IDX | w | After modifying Valid bits (enabling or invalidating), write this bit to 1 to force HW to update the "First Free Index" registers to account for the changed Valid bits. This HW update process takes 4us. SW can poll SAM_BUSY to determine when the table update is complete. Write-only bit. Writing 0 to this bit has no effect. Readback value is indeterminate. |
| SAM_BUSY | r | HW is in the process of updating the Source Address table, either in response to a poll indication from the packet processor, or due to SW setting FIND_FREE_IDX=1. In the latter case, SW should poll SAM_BUSY until low before accessing the "First Free Index" registers. Read-only bit. |
| INVALIDATE_ALL | w | Writing a 1 to this bit clears all 128 Valid bits. Invalidates the entire table. Write-only bit. Writing 0 to this bit has no effect. Readback value is indeterminate. |
| SAP0_1ST_FREE_IDX[6:0] | r | First non-enabled (invalid) index in the SAP0 partition. Read-only. |
| SAA0_1ST_FREE_IDX[6:0] | r | First non-enabled (invalid) index in the SAA0 partition. Read-only. |
| SAP1_1ST_FREE_IDX[6:0] | r | First non-enabled (invalid) index in the SAP1 partition. Read-only. |
| SAA1_1ST_FREE_IDX[6:0] | r | First non-enabled (invalid) index in the SAA1 partition. Read-only |
| PROMISCUOUS | rw | <p>Bypasses most packet filtering.</p> <p>1: all packet filtering except frame length checking (FrameLength>=5 and FrameLength<=127) is bypassed.</p> <p>0: normal mode</p> <p>Note: Promiscuous Mode is not intended for Sequence TR with RXACKRQD=1 (auto-RXACK mode), because the contents of auto-RXACK packets are not stored in the Packet Buffer. If auto-RXACK packets are to be stored in the PB, use ACTIVE_PROMISCUOUS instead.</p> |
| PANCORDNTR0 | rw | Device is a PAN Coordinator on PAN0. Allows device to receive packets with no destination address, if Source PAN ID matches. |
| MACPANID0[15:0] | rw | MAC PAN ID for PAN0. The packet processor compares the incoming packet's Destination PAN ID against the contents of this register to determine if the packet is addressed to this device; or if the incoming packet is a Beacon frame, the packet processor compares the incoming packet Source PAN ID against this register. Also, if PANCORDNTR0=1, and the incoming packet has no Destination Address field, and if the incoming packet is a Data or MAC Command frame, the packet processor compares the incoming packet Source PAN ID against this register. |

Table continues on the next page...

| Field | R/W | Description |
|----------------------|-----|--|
| MACSHORTADDRS0[15:0] | rw | MAC Short Address for PAN0, for 16-bit destination addressing mode. The packet processor compares the incoming packet's Destination Address against the contents of this register to determine if the packet is addressed to this device. |
| MACLONGADDRS0[63:0] | rw | MAC Long Address for PAN0, for 64-bit destination addressing mode. The packet processor compares the incoming packet's Destination Address against the contents of this register to determine if the packet is addressed to this device. |
| BEACON_FT | rw | 1: Beacon frame type enabled. 0: reject all Beacon frames |
| ACK_FT | rw | 1: Acknowledge frame type enabled. 0: reject all Acknowledge frames |
| DATA_FT | rw | 1: Data frame type enabled. 0: reject all Data frames |
| CMD_FT | rw | 1: MAC Command frame type enabled. 0: reject all MAC Command frames |
| LLDN_FT | rw | 1: LLDN frame type enabled (Frame Type 4). 0: reject all MAC Command frames |
| MULTIPURPOSE_FT | rw | 1: MULTIPURPOSE frame type enabled (Frame Type 5). 0: reject all MAC Command frames |
| EXTENDED_FT | rw | 1: EXTENDED frame type enabled (Frame Type 7). 0: reject all MAC Command frames |
| NS_FT | rw | 1: Not-specified (reserved) frame type enabled. No packet filtering is performed, except for frame length checking (FrameLength \geq 5 and FrameLength \leq 127). 0: reject all reserved frame types |
| EXTENDED_FCS_CHK | rw | Verify FCS on Frame Type Extended 1: Packet Processor will check FCS at end-of-packet based on packet length derived from PHR, for Frame Type EXTENDED 0: Packet Processor will not check FCS for Frame Type EXTENDED (default) |
| ACTIVE_PROMISCUOUS | rw | 1: Provide Data Indication on all received packets under the same rules which apply in PROMISCUOUS mode, however acknowledge those packets under rules which apply in non-PROMISCUOUS mode 0: normal operation (Default) |
| FRM_VER_FILTER[3:0] | rw | The incoming packet's Frame Control Field is parsed to obtain the FrameVersion subfield, and that value is compared against this register, in accordance with the following: xxx1: Accept received packets with FrameVersion=00 xx1x: Accept received packets with FrameVersion=01 x1xx: Accept received packets with FrameVersion=10 1xxx: Accept received packets with FrameVersion=11 These filtering rules apply to Beacon, Acknowledge, Data, and MAC Command Frame Types, since these frame types require a 2-octet Frame Control Field which embeds a 2-bit FrameVersion subfield. |

Table continues on the next page...

Link Layer

| Field | R/W | Description |
|----------------------|-----|---|
| | | <p>Later frame types introduced in the 802.15.4e addendum (LLDN, Multipurpose) don't guarantee a FrameVersion subfield with the original meaning, so these filtering rules do not apply to these frame types. See registers LLDN_FT and MULTIPURPOSE_FT.</p> <p>For Acknowledge frames, FrameVersion bits are ignored by the Packet Processor, irrespective of FRM_VER_FILTER.</p> |
| MACPANID1[15:0] | rw | MAC PAN ID for PAN1. The packet processor compares the incoming packet's Destination PAN ID against the contents of this register to determine if the packet is addressed to this device; or if the incoming packet is a Beacon frame, the packet processor compares the incoming packet Source PAN ID against this register. Also, if PANCORNDTR1=1, and the incoming packet has no Destination Address field, and if the incoming packet is a Data or MAC Command frame, the packet processor compares the incoming packet Source PAN ID against this register. |
| MACSHORTADDRS1[15:0] | rw | MAC Short Address for PAN1, for 16-bit destination addressing mode. The packet processor compares the incoming packet's Destination Address against the contents of this register to determine if the packet is addressed to this device. |
| MACLONGADDRS1[63:0] | rw | MAC Long Address for PAN1, for 64-bit destination addressing mode. The packet processor compares the incoming packet's Destination Address against the contents of this register to determine if the packet is addressed to this device. |
| ACTIVE_NETWORK | rw | <p>Selects the PAN on which to transceive, by activating a PAN parameter set (PAN0 or PAN1). In Manual Dual PAN mode (or Single PAN mode), this bit selects the active PAN parameter set (channel and addressing parameters) which governs all autosequences. In Auto Dual PAN mode, this bit selects the PAN on which to begin transceiving, latched at the point at which DUAL_PAN_DWELL register is written.</p> <p>1: Select PAN1 0: Select PAN0 (Default)</p> |
| DUAL_PAN_AUTO | rw | <p>Activates automatic Dual PAN operating mode. In this mode, PAN-switching is controlled by hardware at a pre-programmed rate, determined by DUAL_PAN_DWELL.</p> <p>1: Auto Dual PAN Mode 0: Manual Dual PAN mode (or Single PAN mode). Default.</p> <p>Whenever DUAL_PAN_AUTO=0, CURRENT_NETWORK=ACTIVE_NETWORK at all times. In other words, software directly controls which PAN is selected.</p> <p>Whenever DUAL_PAN_AUTO=1, CURRENT_NETWORK is controlled by hardware</p> |
| PANCORNDTR1 | rw | Device is a PAN Coordinator on PAN1. Allows device to receive packets with no destination address, if Source PAN ID matches. |
| CURRENT_NETWORK | r | <p>This read-only bit indicates which PAN is currently selected by hardware in automatic Dual PAN mode</p> <p>1: PAN1 is selected 0: PAN0 is selected</p> |

Table continues on the next page...

| Field | R/W | Description | | | | | | | | | | | | | | | |
|--------------------------|-----------------------|--|--------------------------|-----------------------|---------------------|-------|-------|------------|----|-------|-------------|------|------|------------|----|------|-------------------|
| DUAL_PAN_DWELL[7:0] | rw | <p>Channel Frequency Dwell Time. In Auto Dual PAN mode, hardware will toggle the PAN, after dwelling on the current PAN for the interval described below (assuming Preamble/SFD not detected). A write to DUAL_PAN_DWELL, always re-initializes the DWELL TIMER to the programmed value. If a write to DUAL_PAN_DWELL occurs during an autosequence, the DWELL TIMER will begin counting down immediately. If a write to DUAL_PAN_DWELL occurs when there is no autosequence underway, the DWELL TIMER will not begin counting until the next autosequence begins; it will begin counting at the start of the sequence warmup.</p> <table border="1"> <thead> <tr> <th>PRESCALER (bits [1:0])</th> <th>TIMEBASE (bits [7:2])</th> <th>RANGE (min) - (max)</th> </tr> </thead> <tbody> <tr> <td>00</td> <td>0.5ms</td> <td>0.5 - 32ms</td> </tr> <tr> <td>01</td> <td>2.5ms</td> <td>2.5 - 160ms</td> </tr> <tr> <td>10</td> <td>10ms</td> <td>10 - 640ms</td> </tr> <tr> <td>11</td> <td>50ms</td> <td>50ms - 3.2seconds</td> </tr> </tbody> </table> <p>A write to DUAL_PAN_DWELL also causes the value of ACTIVE_NETWORK to get latched into the hardware. This latched value will be the starting point for the automatic dual-pan mode (i.e., start on PAN0 or on PAN1). The starting value takes effect immediately (if sequence is underway and DUAL_PAN_AUTO=1), or is otherwise delayed until sequence starts and DUAL_PAN_AUTO=1.</p> | PRESCALER (bits [1:0]) | TIMEBASE (bits [7:2]) | RANGE (min) - (max) | 00 | 0.5ms | 0.5 - 32ms | 01 | 2.5ms | 2.5 - 160ms | 10 | 10ms | 10 - 640ms | 11 | 50ms | 50ms - 3.2seconds |
| PRESCALER (bits [1:0]) | TIMEBASE (bits [7:2]) | RANGE (min) - (max) | | | | | | | | | | | | | | | |
| 00 | 0.5ms | 0.5 - 32ms | | | | | | | | | | | | | | | |
| 01 | 2.5ms | 2.5 - 160ms | | | | | | | | | | | | | | | |
| 10 | 10ms | 10 - 640ms | | | | | | | | | | | | | | | |
| 11 | 50ms | 50ms - 3.2seconds | | | | | | | | | | | | | | | |
| DUAL_PAN_REMAIN[5:0] | | <p>This read-only register indicates time remaining before next PAN switch in auto Dual PAN mode. The units for this register, depend on the PRESCALER setting (bits [1:0]) in the DUAL_PAN_DWELL register, according to the following table:</p> <table border="1"> <thead> <tr> <th>DUAL_PAN_DWELL PRESCALER</th> <th>DUAL_PAN_REMAIN UNITS</th> </tr> </thead> <tbody> <tr> <td>00</td> <td>0.5ms</td> </tr> <tr> <td>01</td> <td>2.5ms</td> </tr> <tr> <td>10</td> <td>10ms</td> </tr> <tr> <td>11</td> <td>50ms</td> </tr> </tbody> </table> <p>The readback value indicates that between N-1 and N timebase units remain until the next PAN switch. For example, a DUAL_PAN_REMAIN readback value of 3, with a DUAL_PAN_DWELL PRESCALER setting of 2 (10ms), indicates that between 20ms (2*10ms) and 30ms (3*10ms), remain until the next automatic PAN switch.</p> | DUAL_PAN_DWELL PRESCALER | DUAL_PAN_REMAIN UNITS | 00 | 0.5ms | 01 | 2.5ms | 10 | 10ms | 11 | 50ms | | | | | |
| DUAL_PAN_DWELL PRESCALER | DUAL_PAN_REMAIN UNITS | | | | | | | | | | | | | | | | |
| 00 | 0.5ms | | | | | | | | | | | | | | | | |
| 01 | 2.5ms | | | | | | | | | | | | | | | | |
| 10 | 10ms | | | | | | | | | | | | | | | | |
| 11 | 50ms | | | | | | | | | | | | | | | | |
| RECD_ON_PAN0 | r | <p>Indicates the packet which was just received, was received on PAN0. In Dual PAN mode operating on 2 different channels, RECD_ON_PAN0 will be set if CURRENT_NETWORK=0 when the packet was received, regardless of FILTERFAIL status.</p> | | | | | | | | | | | | | | | |

Table continues on the next page...

| Field | R/W | Description |
|----------------------|-----|---|
| | | In DUAL PAN mode operating with same channel on both networks, CURRENT_NETWORK will be ignored and RECD_ON_PAN0 will be set only if a valid packet was received on PAN0 (PAN0's FILTERFAIL_FLAG is deasserted). |
| RECD_ON_PAN1 | r | Indicates the packet which was just received, was received on PAN1. In Dual PAN mode operating on 2 different channels, RECD_ON_PAN1 will be set if CURRENT_NETWORK=1 when the packet was received, regardless of FILTERFAIL status. In DUAL PAN mode operating with same channel on both networks, CURRENT_NETWORK will be ignored and RECD_ON_PAN1 will be set only if a valid packet was received on PAN1 (PAN1's FILTERFAIL_FLAG is deasserted). |
| FILTERFAIL_CODE[9:0] | r | Status of packet processor filtering. For incoming packets which have been rejected by the packet processor, FILTERFAIL_CODE will indicate which violated packet-filtering rule(s) led to the rejection. This is intended for debug only. The contents of this register are valid at the FILTERFAIL_IRQ interrupt. The packet processor maintains 2 independent copies of FILTERFAIL_CODE[9:0], one for each PAN. When reading this register, software can select for which PAN the FILTERFAIL_CODE applies, using the FILTERFAIL_PAN_SEL bit. See Appendix A of this Block Guide for a description of Filterfail codes |
| FILTERFAIL_PAN_SEL | rw | 1: FILTERFAIL_CODE[9:0] will report the FILTERFAIL status of PAN1 0: FILTERFAIL_CODE[9:0] will report the FILTERFAIL status of PAN0 |
| LENIENCY[39:0] | rw | The LENIENCY register allows individual packet filtering rules to be overridden, on a rule-by-rule basis. In other words, a specific packet filtering rule, such as an address-mode check, which would result in an incoming packet being rejected, can be overridden by setting the corresponding bit in the LENIENCY register, which would then result in the packet being accepted. This is similar to PROMISCUOUS mode, except that it allows checks to be overridden individually. This will facilitate debug, and potentially allow the device to communicate with devices which may not be 100% MAC-compliant. The mapping of LENIENCY register bits to rules is shown in Appendix B of this document. |

45.6.2.5.3 Functional Description

The packet processor is responsible for receiving symbols from the demodulator, combining them into octets, assembling the octets into packets, filtering the packets in compliance with the 802.15.4 wireless MAC standard, and storing the packets into the Packet Buffer (Packet RAM).

The packet processor parses the incoming packets on-the-fly to determine:

1. whether the packet is MAC-compliant, and if it is,
2. whether the packet is addressed to the end device.

The packet processor performs aggressive filtering on incoming packets, in order to reduce unnecessary MCU wake-ups, to allow longer MCU sleep durations, and to provide sufficient hardware automation so as to enable complex sequences to be executed by the sequence manager. The packet processor also includes hardware support for Dual PAN operation (allowing the device to reside on two networks simultaneously), and for Active Promiscuous mode (allowing the device to receive all packets, but acknowledging only those addressed to the device).

The 802.15.4 packet processor also includes functionality to allow a critical-timing requirement to be met, which in the past has been problematic for low-MIPS 802.15.4 receiving devices: the ability of a coordinator device to respond to a MAC Command data request from an end device, with an Acknowledge frame containing a FramePending bit accurately reflecting the presence of a message for the end device in the coordinator's indirect queue, or the absence of the end device in the coordinator's neighbor table, within the prescribed 192us window. This functionality is described in more detail in the Source Address Matching section.

45.6.2.5.3.1 Packet Filtering Background

The packet processor parses packets to verify compliance with the 802.15.4 MAC frame format. The basic MAC frame format is shown in the figure below.

| | | | | | | | | |
|---------------|-----------------|----------------------------|---------------------|-----------------------|----------------|---------------------------|---------------|-----|
| Octets: 2 | 1 | 0/2 | 0/2/8 | 0/2 | 0/2/8 | 0/5/6/10/ 14 | variable | 2 |
| Frame Control | Sequence Number | Destination PAN Identifier | Destination Address | Source PAN Identifier | Source Address | Auxiliary Security Header | Frame Payload | FCS |
| | | Addressing fields | | | | | | |
| MHR | | | | | | | MAC Payload | MFR |

Figure 45-70. MAC Frame Format

The packet processor parses the incoming octets on the fly, as they are received. The Frame Control Field, two octets in length, contains subfields which encode “instructions” on how to parse the remainder of the MHR (MAC Header). The structure of the Frame Control Field is shown in the figure below.

| Bits: 0–2 | 3 | 4 | 5 | 6 | 7–9 | 10–11 | 12–13 | 14–15 |
|--------------|------------------|---------------|--------------|--------------------|----------|-----------------------|---------------|------------------------|
| Frame Type | Security Enabled | Frame Pending | Ack. Request | PAN ID Compression | Reserved | Dest. Addressing Mode | Frame Version | Source Addressing Mode |

Figure 45-71. Frame Control Field

The packet processor utilizes the Frame Control Fields subfields in the following manner:

| FCF Subfield | Utilization by Packet Processor |
|-----------------------------|---|
| FrameType | Interprets the remaining MHR as specific to Beacon, Ack, Data, Command, or Reserved frame types. Each frame type has a unique MHR structure, and so different parsing rules apply. |
| SecurityEnabled | If SecurityEnabled=1 and FrameVersion>0 (frame versions 2006 and later), an Auxiliary Security Header field will be present in the MHR and will need to be further parsed by the packet processor if this is a MAC Command frame (see Source Address Matching Section below). There is no other use of SecurityEnabled by the packet processor. |
| FramePending | ignored by packet processor |
| Ack. Request | will be copied into the pp_ack_request signal to the sequence manager. An auto-TxAck frame will follow the incoming receive frame if necessary conditions are met |
| PAN ID Compression | used for addressing mode rules-checking and addressing field parsing. |
| Reserved | ignored by packet processor |
| Destination Addressing Mode | used for addressing mode rules-checking and addressing field parsing |
| FrameVersion | For Beacon, Data, and MAC Command frames, FrameVersion is checked against the allowed frame versions according to FRM_VER_FILTER For Acknowledge frames, FrameVersion is ignored. If SecurityEnabled=1 and FrameVersion>0 (frame versions 2006 and later), an Auxiliary Security Header field will be present in the MHR and the MHR will need to be further parsed by the packet processor if this is a MAC Command frame (see Source Address Matching Section). |
| Source Addressing Mode | used for addressing mode rules-checking and addressing field parsing |

The Packet Processor parses the FrameType field of the Frame Control Field per the following table:

| Frame type value b ₂ b ₁ b ₀ | Description |
|--|----------------|
| 000 | Beacon |
| 001 | Data |
| 010 | Acknowledgment |
| 011 | MAC command |
| 100–111 | Reserved |

Figure 45-72. Frame Type Field

Directly following the Frame Control Field is the Sequence Number field. The Sequence Number field of the MHR is captured by the packet processor. If an auto-TxAck frame follows the incoming receive frame, the captured Sequence Number will be copied to the transmitted Acknowledge packet, and the Packet Processor will insert FrameVersion=00 into the Frame Control Field of the transmitted frame, regardless of the received FrameVersion subfield of the original frame.

The Addressing Fields follow the Sequence Number. The format of the Addressing Fields depends upon the Source and Destination Addressing Mode subfields of the Frame Control Field. The Addressing Modes are defined in the table below:

| Addressing mode value b ₁ b ₀ | Description |
|--|--|
| 00 | PAN identifier and address fields are not present. |
| 01 | Reserved. |
| 10 | Address field contains a 16-bit short address. |
| 11 | Address field contains a 64-bit extended address. |

Figure 45-73. Addressing Mode Fields

The packet processor uses these Source and Destination Address Modes shown above, to extract the Source PAN ID and Address (if present), and the Destination PAN ID and Address (if present), from the MHR, according to the table below:

Link Layer

| FrameType | Destination Addressing Mode | Source Addressing Mode | PanID-Compression | Addressing Fields |
|---|-----------------------------|------------------------|-------------------|---|
| Acknowledge only (reject all other frame types) | 0 | 0 | 0 | None |
| Data or Command (reject Ack and Beacon frames) | 2 or 3 | 0 | 0 | DstPanID + DstAddr |
| Beacon (all devices), or Data or Command (PAN Coord Only) (reject Ack frames) | 0 | 2 or 3 | 0 | SrcPanID + SrcAddr |
| Data or Command (reject Ack and Beacon frames) | 2 or 3 | 2 or 3 | 0 | DstPanID + DstAddr + SrcPanID + SrcAddr |
| Reject all frames (Illegal as per Section 7.2.2.1.5) | 0 | 0 | 1 | - |
| Reject all frames (Illegal as per Section 7.2.2.1.5) | 2 or 3 | 0 | 1 | - |
| Reject all frames (Illegal as per Section 7.2.2.1.5) | 0 | 2 or 3 | 1 | - |
| Data or Command (reject Ack or Beacon frames) | 2 or 3 | 2 or 3 | 1 | DstPanID + DstAddr + SrcAddr |
| Reject all frames (Illegal as per Section 7.2.2.1.6) | 1 | - | - | - |
| Reject all frames (Illegal as per Section 7.2.2.1.8) | - | 1 | - | - |

The Source PAN ID and Address, and Destination PAN ID and Address, extracted by the packet processor, are then checked against the MACPANID, MACSHORTADDRS, and MACLONGADDRS register settings, depending on the FrameType of the incoming packet, to determine:

1. Is the addressing mode combination valid for this frame type?
2. Do the address fields indicate that the packet is indeed addressed to the end device?

The details on how the packet processor answers those 2 questions, are described in the following sections.

45.6.2.5.3.2 Packet Filtering Detail

The figure below is a high-level representation of the packet filtering performed by the 802.15.4 packet processor. The sections which follow provide more detail on the packet filter implementation.

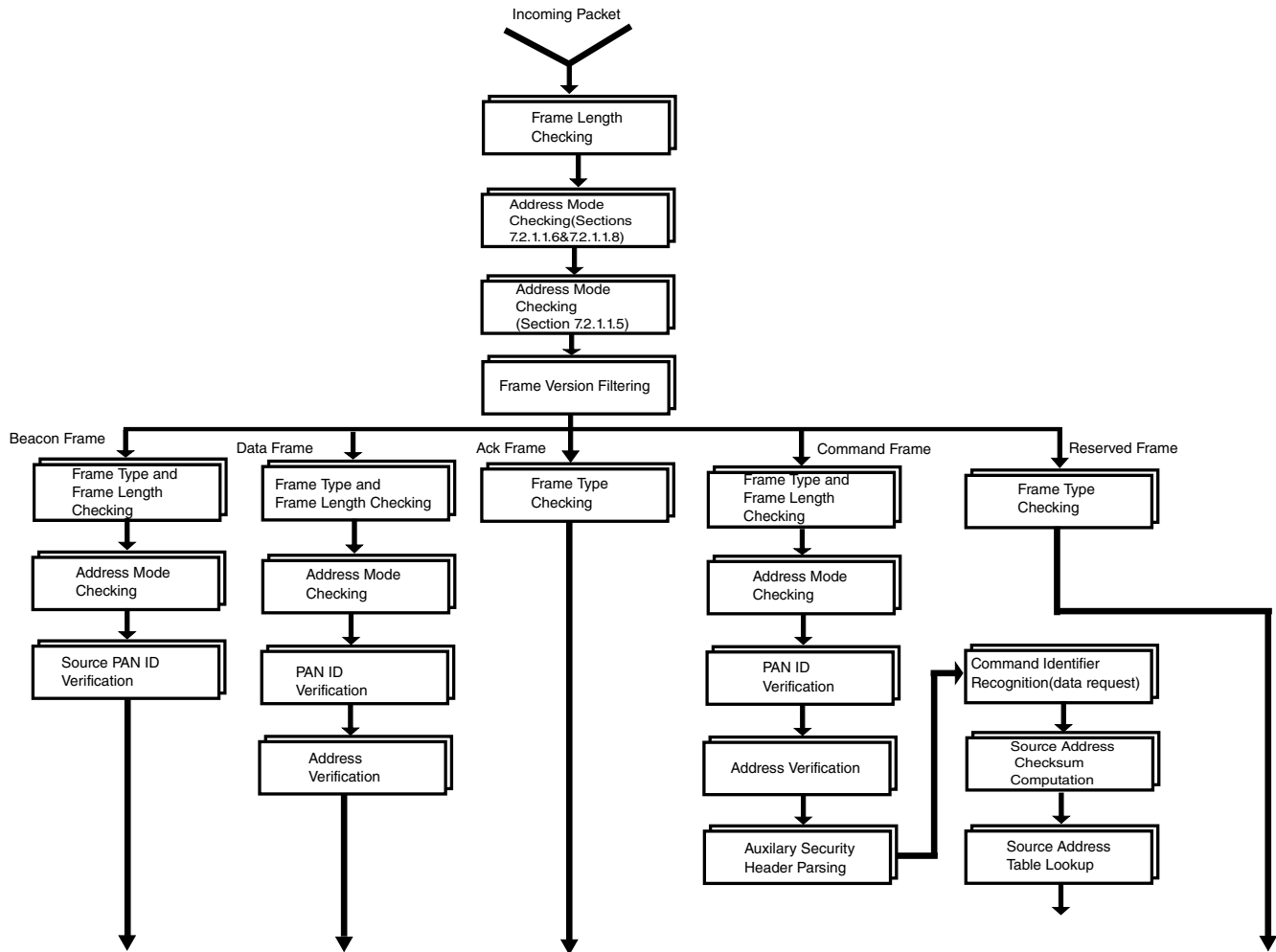

Figure 45-74. Packet Filtering Flow Diagram

First-Stage Packet Filtering

The first stage of packet filtering examines the incoming packet, and implements basic rule-checking, based on the 2006 version of the 802.15.4 standard, and is applied to *all* frame types. First stage rule-checking is described in the table below:

| | Filtering Step | Description |
|---|---|---|
| 1 | Frame Length Checking | Check that all frames are at least 5 octets long (minimum frame length required by the standard), and no longer than 127 octets long (maximum frame length allowed by the standard). |
| 2 | Address Mode Checking (Sections 7.2.1.1.6 and 7.2.1.1.8) | Check that neither Source nor Destination Address Mode set to 1 (illegal addressing mode) |
| 3 | Address Mode Checking (Section 7.2.1.1.5) | Check for PAN ID Compression enabled, with either Source or Destination Address Mode set to 0 (illegal addressing mode) |
| 4 | FrameVersion Checking | Check that incoming packet's Frame Version is allowed based on FRM_VER_FILTER setting. (FRM_VER_FILTER is a programmable register, see Register Descriptions Section). |

Packets which pass first stage filtering, proceed to the second stage of packet filtering, which is *frame type-specific* filtering. Packets which fail initial rule checking are marked as rejected.

Second-Stage Packet Filtering

The second stage of packet filtering is *frame type-specific*. Different variations of the MAC Header (MHR) apply to different frame types, so different parsing mechanisms apply to each.

Note: In the following section, the following references are to register bits; see [Register Description Section](#) for register descriptions: BEACON_FT, ACK_FT, DATA_FT, CMD_FT, NS_FT, PANCORDNTR, MACPANID, MACSHORTADDRS, and MACLONGADDRS.

1) For Beacon frames, these are the basic filtering steps:

- Check that Beacon frames are enabled by software (BEACON_FT)
- Check that FrameLength ≥ 9
- Check for illegal combinations of PAN ID Compression and Source/Destination Address Modes
- Verify the Source PAN ID matches MACPANID, or that MACPANID = 0xffff.

2) For Acknowledge frames, these are the basic filtering steps:

- Check that Ack frames are enabled by software (ACK_FT)
- If Sequence TR is active and RXACKRQD = 1 (see ZSM Sequence Manager BG), check the received Sequence Number matches the transmitted Sequence Number; FrameVersion bits are ignored, as per section 7.2.2.3.1 of the 802.15.4 standard.

Note: It is recommended to use Sequence TR to receive Acknowledge frames, not Sequence R (see ZSM Sequence Manager Block Guide)

3) For Data frames, these are the basic filtering steps:

- Check that Data frames are enabled by software (DATA_FT)
- Check that FrameLength ≥ 9
- Check for illegal combinations of Source and Destination Address Modes
- If PANCORDNTR=0, check for missing Destination Address field or present Source Address field
- If no Destination Address field (PANCORDNTR=1 only), check Source PAN ID matches MACPANID
- If Destination Address present, check Destination PAN ID matches MACPANID or broadcast (0xffff)
- If Short Destination Address field, check address matches MACSHORTADDRS or broadcast (0xffff)
- If Long Destination Address field, check address matches MACLONGADDRS.

4) For MAC Command frames, these are the basic filtering steps:

- Check that Command frames are enabled by software (CMD_FT)
- Check that FrameLength ≥ 9
- Check for illegal combinations of Source and Destination Address Modes
- If PANCORDNTR=0, check for missing Destination Address field or present Source Address field
- If no Destination Address field (PANCORDNTR=1 only), check Source PAN ID matches MACPANID
- If no Destination Address field (PANCORDNTR=1 only), capture Source PAN ID and Source Address for later use
- If Destination Address present, check Destination PAN ID matches MACPANID or broadcast (0xffff)
- If Short Destination Address field, check address matches MACSHORTADDRS or broadcast (0xffff)
- If Long Destination Address field, check address matches MACLONGADDRS.
- At end of the addressing field, if incoming packet's FrameVersion=0 or SecurityEnabled=0, capture the next octet (Command Identifier)
- At end of the addressing field, if incoming packet's FrameVersion!=0 and SecurityEnabled=1, parse the Auxiliary Security Header, then capture the next octet (Command Identifier)
- If Command Identifier indicates the MAC Command is a data request, compute a "Source Address Checksum" to uniquely identify the sending device.

45.6.2.5.3.3 Source Address Management

The 802.15.4 wireless MAC standard envisions a scenario whereby an end device may interrogate a coordinator as to whether the coordinator is storing data (i.e., a pending message) for the end device. The situation arises in a beacon-enabled network, when a coordinator includes in its transmitted beacon frame the MAC address of the end device in its “Pending Address Fields”. The “Pending Address Fields” are part of the required MAC payload of the beacon frame. The “Pending Address Fields” contain a list of end device addresses for which messages are pending. In this scenario, an end device which finds its address included in the “Pending Address Fields” of the received beacon frame, must respond to the beacon (coordinator) with a MAC Command of type “data request”. Alternatively, in non-beacon-enabled networks, an end device may periodically wake up and “poll” a coordinator, to determine if a message is pending for the end device. In either case, the coordinator stores messages for its end devices in its “indirect queue”. The coordinator must respond to an incoming MAC Command data request (which *must* have AckRequest=1 in its Frame Control Field), with an Acknowledge frame containing a FramePending subfield indicating the presence (or absence) of a message for the requesting end device, in the coordinator’s indirect queue. For a coordinator built around a low-MIPS MCU, a significant amount of MCU time is typically required, simply to ascertain whether a given end device has a message pending or not; the indirect queue can be quite large, and for 8-bit MCU’s, the queue must be searched byte-by-byte. This makes it difficult, or impossible, for an underpowered MCU to establish frame-pending status within the 192us RX-to-TX turnaround time required by the standard.

Also, coordinators may include, in software, a “Neighbor Table”, the contents of which consist of all the end devices with which the coordinator is in communication. The neighbor table requires periodic maintenance by coordinator (parent) software, as end devices (children) come and go within the network, join different parents, or simply never return. Child tables have limited capacity and parents need to create space for new devices that may show up. A timeout mechanism is the only way that can guarantee that child tables will eventually be cleaned up. Coordinator software must “age out” end devices with which there has not been recent communication. In order for an end device to refresh its status within its parent’s Neighbor Table, the end device may periodically send a “keepalive” message in the form of a MAC Data Poll Request. Upon receipt of such a poll request, the parent must search its neighbor table to determine if the source address of the end device is a valid table entry. If the end device exists in the table, an Acknowledgment packet must be transmitted to the end device, with the FramePending subfield set to 0, and coordinator software resets that end device’s timeout counter; if the child is not present in the table, an Acknowledgment packet must be transmitted to the end device, with the FramePending subfield set to 1, and the parent device will follow up by transmitting a “Leave Packet” to the end device, instructing the end device to sever its child status with the parent. The end device may opt to rejoin at a later time. Due to the

size of the parent's Neighbor table, the search a child's source address can be time consuming, and may not always be possible within the 192us RX-to-TX turnaround time required by the standard.

To alleviate both of these problems, the 802.15.4 packet processor includes hardware acceleration to expedite the source address table search, greatly relieving the software bottleneck during the critical 192us turnaround time. The table search acceleration consists of 2 components: 1) a search for the *presence* of a specific end device's source address, which expedites the process of determining whether a message is pending for the device; and 2) a search for the *absence* of a specific end device's source address, which expedites the process of determining whether the end device is a valid child of the parent.

The packet processor maintains a register table (128 deep, 16-bit wide). The table is divided into multiple partitions, one to perform the "Source Address Present" (SAP) search, and another to perform the "Source Address Absent" (SAA) search. In the SAP partition of the table, coordinator software will store the address of end devices for which it has a message pending; in the SAA partition of the table, coordinator software will store the address of end devices for which it is the parent. To reduce area, the address information is stored in a "compressed" format. Software compresses the address information, and stores it into the table partitions, during a non-critical time. Then, when the coordinator's packet processor receives a MAC Command data request, it extracts the source address information from the incoming packet, and compresses it using the *same* compression algorithm used by software to populate the source address table. The packet processor performs 2 steps simultaneously:

1. it compares the just-received, compressed source address information, or "checksum", against all of the enabled entries in the SAP partition of the table. If a match is found in the SAP partition, the packet processor *asserts* the **rx_frame_pending** signal to the transmit block (TX_PACKET), so that an auto-TxAck packet can be sent to the requesting end device, with the FramePending subfield set to 1, indicating that the end device has a message pending in the coordinator's indirect queue. A message packet from the coordinator to the end device will follow.
2. it compares the just-received, compressed source address information, or "checksum", against all of the enabled entries in the SAA partition of the table. If *no* match is found in the SAA partition, the packet processor *asserts* the **rx_frame_pending** signal to the transmit block (TX_PACKET), so that an auto-TxAck packet can be sent to the requesting end device, with the FramePending subfield set to 1, indicating that the end device is not a valid child of this parent, and a "Leave Packet" from the coordinator to the end device, will follow.

If neither condition is met, i.e., there is no address match in the SAP partition, and a positive match in the SAA partition, the packet processor *deasserts* the **rx_frame_pending** signal, so that an auto-TxAck packet can be sent indicating to the end device that it has no data pending, and that it remains a valid child of this parent; the end device may then deactivate its receiver immediately. For the packet processor, the entire table lookup occurs in 128 clock cycles, once the last source address octet has been received. The SAP and SAA lookups are performed simultaneously. The checksum is also computed on-the-fly by hardware as the source address octets are received, taking no more than 1 clock cycle per octet. Finally, table-search status is reported to the MCU:

1. after the packet processor completes its SAP table search, the status bit **SAP0_ADDR_PRESENT** will be set to 1 if a match is found in the SAP partition, and the table index which matched will be indicated in the **SAP0_MATCH[6:0]** register, to further assist software in locating the relevant message within its indirect queue; if no match is found in the SAP partition, the status bit **SAP0_ADDR_PRESENT** will be set to 0.
2. after the packet processor completes its SAA table search, the status bit **SAA0_ADDR_ABSENT** will be set to 1 if *no* match is found in the SAA partition; if a positive match is found in the SAA partition, the status bit **SAA0_ADDR_ABSENT** will be set to 0, and the table index which matched will be indicated in the **SAA0_MATCH[6:0]** register, to further assist software in locating the child device within its neighbor table.

Both features, SAP and SAA acceleration, are optional, and functionally independent. Coordinator software can elect to enable both, either, or neither feature. The control bit **SAP0_EN** enables SAP acceleration. The control bit **SAA0_EN** enables SAA acceleration. If either feature is disabled, that table partition (SAP or SAA) is not searched, and so is not a factor in determining FramePending status for the transmitted Acknowledge frame. If *both* features are disabled, FramePending status defaults to software control, and merely tracks the state of the **ACK_FRM_PND** register bit; in this case software must manage FramePending status for all auto-TxAck frames.

Software can also take direct control of FramePending status for the next auto-TxAck frame at any time (regardless of whether SAP or SAA acceleration is enabled), by setting the **ACK_FRM_PND_CTRL** bit; in this case, hardware FramePending status will track the state of **ACK_FRM_PND**.

In order to support Dual PAN mode, a device could theoretically be a PAN Coordinator on both networks. Thus, a coordinator device may need to maintain distinct message pending lists and/or neighbor tables for the 2 PANs. Accordingly, the packet processor further subdivides the Source Address Management table into 4, instead of 2, partitions:

1. **SAP0**: Source Address Present Partition for PAN0
2. **SAA0**: Source Address Absent Partition for PAN0

3. SAP1: Source Address Present Partition for PAN1
4. SAA1: Source Address Absent Partition for PAN1

SOURCE ADDRESS TABLE PARTITIONS

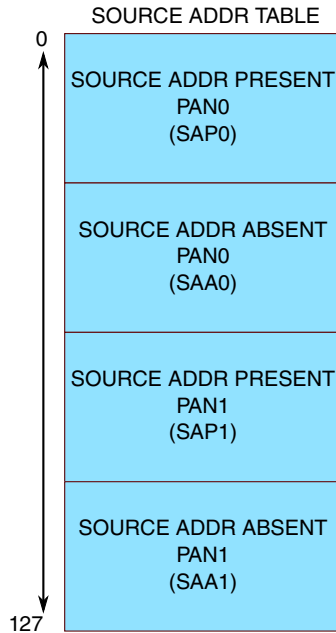

Four register control bits enable each partition individually. If a partition is enabled, and a MAC poll request is received on the corresponding PAN (e.g. SAP0 or SAA0 partitions on PAN0), then the partition is searched by the packet processor, looking for a source address match (or absence), and the result of the search affects the FramePending status; if a partition is disabled, the partition is not searched, and will not influence FramePending status. The register bits are described in the table below.

| REGISTER NAME | DESCRIPTION |
|---------------|------------------------|
| SAP0_EN | Enables SAP0 Partition |
| SAA0_EN | Enables SAA0 Partition |
| SAP1_EN | Enables SAP1 Partition |
| SAA1_EN | Enables SAA1 Partition |

For maximum flexibility in supporting all combinations of message-pending status, neighbor-table status, and dual PAN mode, the dividing-line between all the partitions is fully programmable. The SAP0 partition always starts at table index 0. Three registers control the starting point for the other 3 partitions. The starting point is defined the first table index (0-127) of that partition. The registers are described below, along with some software restrictions to ensure table consistency.

| REGISTER NAME | DESCRIPTION | RESTRICTIONS |
|-----------------|--------------------------------|--|
| SAA0_START[6:0] | First Index of SAA0 partition. | If SAA0_START=0, then there is no SAP0 partition (SAP0_EN should be set to 0) |
| SAP1_START[6:0] | First Index of SAP1 partition. | Software must ensure that: SAP1_START ≥ SAA0_START If SAP1_START = SAA0_START, then there is no SAA0 partition (SAA0_EN should be set to 0) |
| SAA1_START[6:0] | First Index of SAA1 partition. | Software must ensure that: SAA1_START ≥ SAP1_START If SAA1_START = SAP1_START, then there is no SAP1 partition (SAP1_EN should be set to 0) |

A diagram which depicts one example of how the dividing-line registers affect partitioning of the table, is shown below.

SOURCE ADDRESS TABLE PARTITIONS -- NON-EQUAL SIZES (EXAMPLE)

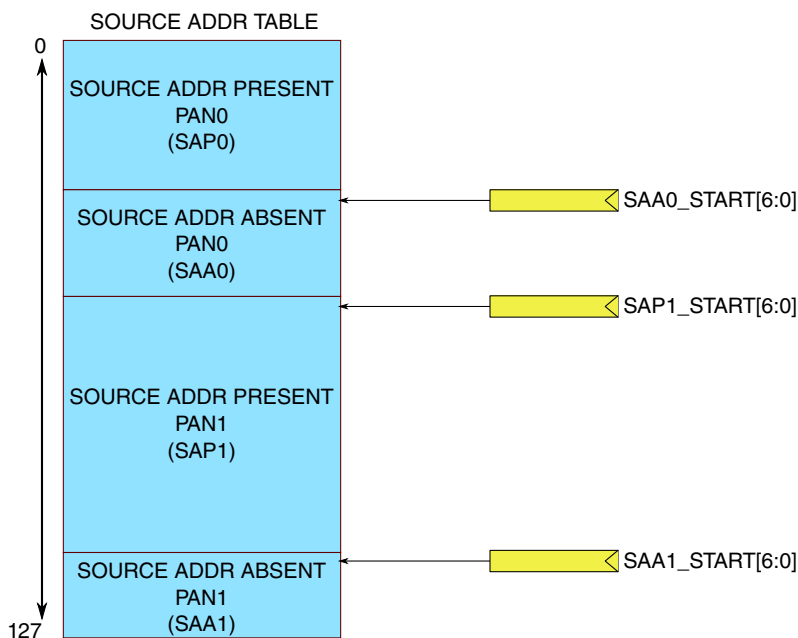

Each table partition consists of one or more indices, which can be used to store source address checksums. The first index for any partition, is defined by the aforementioned *PARTITION_START*[6:0] register, where *PARTITION_* is one of {SAP0, SAP1, SAA0, SAA1}. The last index for any partition, is defined by the next higher partition's *PARTITION_START*[6:0] register, minus 1. When populating the table with source address information, software must be sure to select an index that is within the defined range for the partition. For example, when installing a checksum in the SAP1 partition:

$$\text{SAP1_START} \leq \text{Selected_Index} \leq (\text{SAA1_START} - 1)$$

To populate the table partitions, a 7-bit register SAM_INDEX[6:0] is provided, as well as a “index enable bit”, and a “index invalidate” bit. A 16-bit SAM_CHECKSUM[15:0] is provided, into which software will write the computed checksum. Installing a checksum into any partition is referred to as “Enabling an Index”, and removing a checksum from any partition is referred to as “Invalidating an Index”. A description of the registers is provided in the following table:

| REGISTER NAME | DESCRIPTION |
|--------------------|---|
| SAM_CHECKSUM[15:0] | Software-computed source address checksum, to be installed into a table index |
| SAM_INDEX[6:0] | Contains the table index to be enabled or invalidated. Software must ensure that the index is within the range of the desired partition. |
| SAM_INDEX_WR | For 32-bit writes, this must be set to indicate that the table entry specified by SAM_INDEX[6:0] is to be written; if SAM_INDEX_WR=0, the table entry is not written, but the SAM_INDEX[6:0] register is updated. For 8-bit writes, this bit is ignored. |
| SAM_INDEX_EN | Enable the index selected by SAM_INDEX[6:0] for searching. |
| SAM_INDEX_INV | Invalidate the index selected by SAM_INDEX[6:0] |
| FIND_FREE_IDX | After modifying Valid bits (enabling or invalidating), write this bit to 1 to force HW to update the “First Free Index” registers to account for the changed Valid bits. This HW update process takes 4us. SW can poll SAM_BUSY to determine when the table update is complete. Write-only bit. Writing 0 to this bit has no effect. Readback value is indeterminate. |
| SAM_BUSY | HW is in the process of updating the Source Address table, either in response to a poll indication from the packet processor, or due to SW setting FIND_FREE_IDX=1. In the latter case, SW should poll SAM_BUSY until low before accessing the “First Free Index” registers. Read-only bit. |
| INVALIDATE_ALL | Writing a 1 to this bit clears all 128 Valid bits. Invalidates the entire table. Write-only bit. Writing 0 to this bit has no effect. Readback value is indeterminate. |

All the index-control registers reside within a single 32-bit word, so that a single 32-bit write can store a new checksum in the table, and simultaneously enable, or invalidate, the index. For 32-bit writes, SAM_INDEX_WR must be set to 1 to cause the SAM_CHECKSUM[15:0] to be loaded into the table at the address specified by SAM_INDEX[6:0]. For 32-bit reads, it is necessary first to update SAM_INDEX[6:0] to the desired table index, if it is not already set to the desired index; this requires a write to SAM_INDEX[6:0] with SAM_INDEX_WR=0, so as to not update the table contents. Then, a subsequent 32-bit read will return the table contents at the desired index.

For systems that don't support 32-bit writes, the register fields should be written in the following order:

1. SAM_INDEX[6:0]
2. SAM_CHECKSUM (the 2 bytes can be written in either order)
3. SAM_INDEX_EN (to enable), or SAM_INDEX_INV (to invalidate)

During operation, when a packet is received and the packet processor searches the table for a source address match, only enabled indices within each partition are searched. Invalidated indices are ignored.

To assist software in finding an available index to store the next source address checksum, the packet processor makes available the following 4 read-only registers:

| REGISTER NAME | DESCRIPTION |
|------------------------|---|
| SAP0_1ST_FREE_IDX[6:0] | First non-enabled (invalid) index in the SAP0 partition |
| SAA0_1ST_FREE_IDX[6:0] | First non-enabled (invalid) index in the SAA0 partition |
| SAP1_1ST_FREE_IDX[6:0] | First non-enabled (invalid) index in the SAP1 partition |
| SAA1_1ST_FREE_IDX[6:0] | First non-enabled (invalid) index in the SAA1 partition |

Operational Use

The following flow description illustrates how hardware and software interact to utilize the Source Addressing Management feature to facilitate pending-message handling and neighbor table management. This flow assumes both SAP and SAA acceleration are enabled, and Dual PAN mode is in effect. There are 11 sequential steps.

Step 1: Message Packet Reception, Extracting the Message, Indirect Queue Management

A message (data frame) is received by a coordinator. The message is received from one end device, and is intended for another end device. The coordinator's packet processor receives the packet, and stores it in the packet buffer. Coordinator software downloads the packet data from the packet buffer, extracts the message from the MAC payload, and stores the message in its indirect queue.

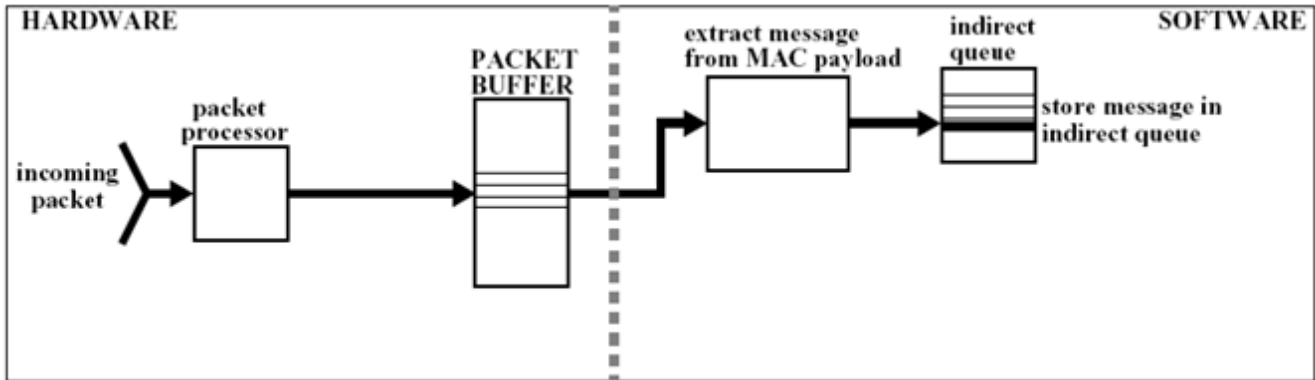

Step 2: Software computes address checksum

Coordinator software also extracts the destination information (Destination PANID and Destination Address), from the data packet stored in the packet buffer. Software uses this information to compute a 16-bit checksum. This checksum uniquely identifies the sending device, with a high degree of reliability. The checksum is computed according to the following rules:

| Destination Addressing Mode | Rule |
|-----------------------------|---|
| Mode 2 (short address) | Checksum = (Destination PAN ID + DstAddr[15:0]) % 65536 |
| Mode 3 (long address) | Checksum = (Destination PAN ID + DstAddr[15:0]) % 65536 Checksum = (Checksum + DstAddr[31:16]) % 65536 Checksum = (Checksum + DstAddr[47:32]) % 65536 Checksum = (Checksum + DstAddr[63:48]) % 65536 |

Step 3: Software populates the address table

Coordinator software chooses an index in the Source Address Table in which it will store the just-computed checksum. If the data packet was received on PAN0, an index in the SAP0 partition should be chosen. Software may consult the register SAP0_1ST_FREE_IDX[6:0] to find the first available index in this partition. If the data packet was received on PAN1, an index in the SAP1 partition should be chosen. Software may consult the register SAP1_1ST_FREE_IDX[6:0] to find the first available index in this partition.

If an index is chosen which is already valid, software should first invalidate the index with the following procedure:

1. Set SAM_INDEX[6:0] to the selected index
2. Set SAM_INDEX_EN=0 and SAM_INDEX_INV=1

These steps can be performed in a single, 32-bit register write.

To install the source address checksum into the index and enable the index, the following procedure should be used:

1. Program SAM_CHECKSUM[15:0] to the computed checksum
2. Set SAM_INDEX[6:0] to the selected index
3. Set SAM_INDEX_EN=1 and SAM_INDEX_INV=0

These steps can be performed in a single, 32-bit register write.

The index is now enabled, and the packet processor will include it in its search when the next MAC Poll Request is received.

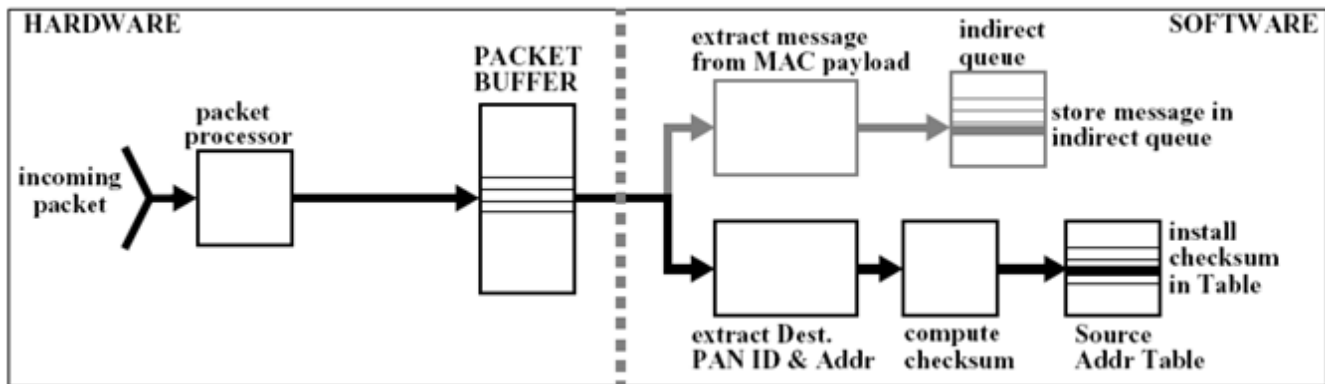

Step 4: Incoming Poll request, Packet Processor parses the Auxiliary Security Header

An incoming packet is received. The packet processor performs routine packet filtering. After determining that the packet is type ‘MAC Command’, the packet processor must perform additional packet parsing in order to locate the packet’s Command Frame Identifier. This is the octet that distinguishes this command as being of type “data request”, from other MAC Command types. For the packet processor, this extra parsing is more complex, because the Command Frame Identifier is part of the MAC payload; this is the only scenario where the packet processor is required to parse the payload. This is further complicated by the fact that the revision 2006 (and subsequent) of the 802.15.4 wireless MAC standard, includes a variable-length “Auxiliary Security Header”, prior to the MAC payload. This header is only present for FrameVersion > 0, and SecurityEnabled = 1. The packet processor must conditionally parse this header in order to locate the start of the MAC payload, where the Command Frame Identifier is located. The packet processor uses 2 subfields of the Frame Control Field to parse the Auxiliary Security Header (A.S.H.): FrameVersion, and SecurityEnabled. The packet processor parses the Auxiliary Security Header (A.S.H.) according to the following table:

| Length of Auxiliary Security Header (Octets) | SecurityEnabled (Frame Control Field) | FrameVersion (Frame Control Field) | KeyIdentifierMode (Security Control Field) | Remarks |
|---|---------------------------------------|------------------------------------|--|--|
| 0 | 0 | 00 or 01 | - | If !SecurityEnabled, no ASH regardless of FrameVersion |
| 0 | 1 | 00 | 0 | If packet is 2003-compliant, no ASH |
| 5 Security Control (1 octet) + Frame Counter (4 octet) | 1 | 01 | 0x00 | ASH present. Length of ASH computed by HW. |
| 6 Security Control (1 octet) + Frame Counter (4 octet) + Key Identifier (1 octet) | 1 | 01 | 0x01 | ASH present. Length of ASH computed by HW. |
| 10 Security Control (1 octet) + Frame Counter (4 octet) + Key Identifier (5 octet) | 1 | 01 | 0x2 | ASH present. Length of ASH computed by HW. |
| 14 Security Control (1 octet) + Frame Counter (4 octet) + Key Identifier (9 octet) | 1 | 01 | 0x3 | ASH present. Length of ASH computed by HW. |
| - | - | 10 or 11 | - | HW will handle these FrameVersion's indentially to FrameVersion 01 |

The contents of the A.S.H. are irrelevant to the packet processor; only its length is important. This is because the octet which immediately follows the A.S.H. is the Command Frame Identifier. This is all the packet processor needs to know.

Step 5: Hardware extracts the Command Frame Identifier

After parsing the A.S.H. (if present), the next octet in the MAC payload, in accordance with the 802.15.4 standard, is the Command Frame Identifier.

| Command frame identifier | Command name | RFD | | Subclause |
|--------------------------|------------------------------|-----|----|-----------|
| | | Tx | Rx | |
| 0x01 | Association request | X | | 5.3.1 |
| 0x02 | Association response | | X | 5.3.2 |
| 0x03 | Disassociation notification | X | X | 5.3.3 |
| 0x04 | Data request | X | | 5.3.4 |
| 0x05 | PAN ID conflict notification | X | | 5.3.5 |
| 0x06 | Orphan notification | X | | 5.3.6 |
| 0x07 | Beacon request | | | 5.3.7 |
| 0x08 | Coordinator realignment | | X | 5.3.8 |
| 0x09 | GTS request | | | 5.3.9 |
| 0x0a–0xff | Reserved | | | — |

The packet processor checks to see if the Command Frame Identifier = 0x4. If it is not, packet processing for this frame is complete, the remainder of the packet is received, without inspection by the packet processor, and is stored in the packet buffer. If the Command Frame Identifier = 0x4, then this is a data request, and assuming the prior rules-checking and address-checking on this packet have already passed, then the Source Address Matching function will be applied to this packet, continuing in STEP 6.

Step 6: Hardware Computes the Source Address Checksum

The packet processor uses the received Source PAN ID and Source Address for this packet to compute a 16-bit Source Address checksum. This checksum uses precisely the same algorithm that software uses to compute its Address checksum (see STEP 2), except that the *Source* PAN ID and address are used, rather than the Destination PAN ID and address. This checksum uniquely identifies the sending device, with a high degree of reliability. Note if the incoming packet's Frame Control Field has the PANIDCompression subfield asserted, the packet processor will substitute "Destination PAN ID" for "Source PAN ID" in the computation, since Source PAN ID will not be present under these circumstances.

Step 7: Hardware performs "Source Address Present" Table Search

If the MAC poll request was received on PAN0, and SAP0_EN=1 to enable searches of the PAN0 “Source Address Present” partition, the packet processor uses its Source Address checksum to look for a match in the SAP0 partition of the table. Only table entries that are enabled, are compared against (see STEP 3); table indices which are not enabled, are ignored in the search.

If a single table match is found (i.e., 1 software-computed checksum in SAP0 partition matches the hardware-computed checksum for the incoming packet), this means that there is a message for this requestor in the coordinator’s message queue. For a SAP0 match, the packet processor takes these 2 steps:

1. Set SAP0_ADDR_PRESENT=1
2. Set SAP0_MATCH[6:0] to the index which matched

If multiple table matches are found (i.e., more than 1 software-computed checksum in the SAP0 partition matches the hardware-computed checksum for the incoming packet), this means that there are multiple messages for this requestor in the coordinator’s message queue. In this case, the packet processor takes the same steps as for a single match, with the SAP0_MATCH[6:0] register being set to the lowest-value matching index (i.e., the smallest number) within the SAP0 partition.

If no source address match is found in the SAP0 table search, the packet processor will set SAP0_ADDR_PRESENT=0.

If, on the other hand, the MAC poll request was received on PAN1, and SAP1_EN=1 to enable searches of the PAN1 “Source Address Present” partition, the packet processor uses its Source Address checksum to look for a match in the SAP1 partition of the table. Only table entries that are enabled, are compared against (see STEP 3); table indices which are not enabled, are ignored in the search.

If a single table match is found (i.e., 1 software-computed checksum in SAP1 partition matches the hardware-computed checksum for the incoming packet), this means that there is a message for this requestor in the coordinator’s message queue. For a SAP1 match, the packet processor takes these 2 steps:

1. Set SAP1_ADDR_PRESENT=1
2. Set SAP1_MATCH [6:0] to the index which matched

If multiple table matches are found (i.e., more than 1 software-computed checksum in the SAP1 partition matches the hardware-computed checksum for the incoming packet), this means that there are multiple messages for this requestor in the coordinator’s message queue. In this case, the packet processor takes the same steps as for a single match, with the SAP1_MATCH[6:0] register being set to the lowest-value matching index (i.e., the smallest number) within the SAP1 partition.

If no source address match is found in the SAP1 table search, the packet processor will set `SAP1_ADDR_PRESENT=0`.

Step 8: Hardware performs “Source Address Absent” Table Search

If the MAC poll request was received on PAN0, and `SAA0_EN=1` to enable searches of the PAN0 “Source Address Absent” partition, the packet processor uses its Source Address checksum to look for a match in the SAA0 partition of the table. Only table entries that are enabled, are compared against (see STEP 3); table indices which are not enabled, are ignored in the search.

If one (or more) table match is found (i.e., a software-computed checksum in SAA0 partition matches the hardware-computed checksum for the incoming packet), this means that the end device which sent the poll request is a valid child of this parent. For a SAA0 match, the packet processor takes these 2 steps:

1. Set `SAA0_ADDR_ABSENT=0`
2. Set `SAA0_MATCH[6:0]` to the first index which matched

If *no* source address match is found in the SAA0 table search, the packet processor will set `SAA0_ADDR_ABSENT=1`.

If, on the other hand, the MAC poll request was received on PAN1, and `SAA1_EN=1` to enable searches of the PAN1 “Source Address Absent” partition, the packet processor uses its Source Address checksum to look for a match in the SAA1 partition of the table. Only table entries that are enabled, are compared against (see STEP 3); table indices which are not enabled, are ignored in the search.

If one (or more) table match is found (i.e., a software-computed checksum in SAA1 partition matches the hardware-computed checksum for the incoming packet), this means that the end device which sent the poll request is a valid child of this parent. For a SAA1 match, the packet processor takes these 2 steps:

1. Set `SAA1_ADDR_ABSENT=0`
2. Set `SAA1_MATCH[6:0]` to the first index which matched

If *no* source address match is found in the SAA1 table search, the packet processor will set `SAA0_ADDR_ABSENT=1`.

Step 9: Hardware determines FramePending status

The packet processor maintains an internal flag called **rx_frame_pending**, which is sent to the TX_PACKET block after every received packet, to directly control the state of the FramePending subfield of the Frame Control Field in the upcoming auto-TxAck frame (if enabled with AUTOACK=1).

If the Source Address Management feature is completely disabled, i.e.,

$$\text{SAP0_EN} = \text{SAA0_EN} = \text{SAP1_EN} = \text{SAA1_EN} = 0$$

then the packet processor will set the **rx_frame_pending flag** to the value of the ACK_FRM_PND register, putting the state of FramePending under direct software control.

Otherwise, if *any* of the following conditions are met, the packet processor will set its **rx_frame_pending** flag to 1:

1. The MAC Poll Request was received on PAN0, SAP0_EN=1, and SAP0_ADDR_PRESENT=1
2. The MAC Poll Request was received on PAN1, SAP1_EN=1, and SAP1_ADDR_PRESENT=1
3. The MAC Poll Request was received on PAN0, SAA0_EN=1, and SAA0_ADDR_ABSENT=1
4. The MAC Poll Request was received on PAN1, SAA1_EN=1, and SAA1_ADDR_ABSENT=1

If none of the conditions are met, **rx_frame_pending** flag will be set to 0.

Step 10: Receive interrupt RXIRQ

The packet processor receives the remainder of the packet, and verifies the FCS. Assuming the CRC check passes, the RXIRQ interrupt is issued. In the coordinator software's RXIRQ Interrupt Service Routine, software can determine if the received packet was a MAC Poll Request by reading the PI bit of the IRQSTS register. If PI=0, the received packet was not a poll request, and no action relating to Source Address Matching need be taken.

Otherwise, if *either* SAP0_ADDR_PRESENT=1 or SAP1_ADDR_PRESENT=1, an auto-TxAck packet is being sent with the FramePending subfield set to 1, so software should follow up by constructing a data packet (or packets) for the requesting end device, with a payload consisting of the message for this device which had been stored in the coordinator's indirect queue.

Also, if *either* SAA0_ADDR_ABSENT=1 or SAA1_ADDR_ABSENT=1, an auto-TxAck packet is being sent with the FramePending subfield set to 1, so software should follow up by constructing a “Leave Message” for the requesting end device.

Step 11: Software disables the spent index

In the final step, coordinator software must disable (invalidate) the index which was just used to locate and send the stored message to the requesting end device. To disable the index:

1. Set SAM_INDEX[6:0] to the selected index
2. Set SAM_INDEX_EN=0 and SAM_INDEX_INV=1

At this point, the disabled index is now an available table entry, which can be used to install a new Address checksum for another message in the indirect queue.

45.6.2.5.3.4 Dual PAN Mode

In the past, radio transceivers designed for 802.15.4 applications allow a device to associate to one and only one PAN (Personal Area Network), at any given time. The Packet Processor includes hardware support for a device to reside on two networks simultaneously. In optional Dual PAN mode, the device will alternate between the 2 PAN's, under hardware or software control. Hardware support for Dual PAN operation consists of 2 sets of PAN and IEEE addresses for the device, 2 different channels (one for each PAN), a programmable timer to automatically switch PAN's (including on-the-fly channel-changing) without software intervention, control bits to configure and enable Dual PAN mode, and read-only bits to monitor status in Dual PAN mode. A device can be configured to be a PAN Coordinator on either network, both networks, or neither.

For the purpose of defining a "PAN" in the context of Dual PAN mode, two sets of network parameters are maintained. In this document, "PAN0" and "PAN1" will be used to refer to the 2 PAN's. Each parameter set uniquely identifies a PAN for Dual PAN mode. These parameters are:

| PAN0 | PAN1 |
|-----------------------------------|-----------------------------------|
| CHANNEL_NUM0 | CHANNEL_NUM1 |
| MACPANID0 (16-bit register) | MACPANID1 (16-bit register) |
| MACSHORTADDRES0 (16-bit register) | MACSHORTADDRES1 (16-bit register) |
| MACLONGADDRES0 (64-bit registers) | MACLONGADDRES1 (64-bit registers) |
| PANCORDNTR0 (1-bit register) | PANCORDNTR1 (1-bit register) |

During device initialization, if Dual PAN mode is to be utilized, software will program both parameter sets, to configure the hardware for operation on two networks.

Two modes are available for Dual PAN operation: manual and automatic.

Manual Dual PAN

In manual Dual PAN mode, software controls which PAN is selected for transmission and reception, at all times. Software populates both PAN network parameter-set registers listed above. Software then selects a PAN to begin transmission or reception. A single control bit **ACTIVE_NETWORK**, selects the PAN. To select PAN0, **ACTIVE_NETWORK** should be set to 0; to select PAN1, **ACTIVE_NETWORK** should be set to 1. Software then initiates an autosequence by writing the appropriate value to XCVSEQ (PHY_CTRL1 Register). At any point, software can elect to switch to the alternate PAN. To do so, software aborts the sequence (if one is active) by writing XCVSEQ=IDLE. Software then toggles **ACTIVE_NETWORK**, and restarts a new sequence with XCVSEQ. Software is responsible for aborting and initiating sequences. Hardware is responsible for warming up the transceiver on the selected channel (CHANNEL_NUM0 or CHANNEL_NUM1), and performing address-filtering on the selected network's address parameters (PANCORDNTR, MacPanID, Short Address, and/or IEEE address). Software overhead is significantly reduced in this mode, since there is no need to re-program all of the the PAN-select registers every time the PAN is toggled in Dual PAN mode; only a single bit (**ACTIVE_NETWORK**) need be written. For manual Dual PAN operation, **DUAL_PAN_AUTO** should be set to 0.

The following diagram depicts Dual PAN operation in manual mode. In this example, software populates both PAN parameters sets during initialization. In this example, software elects to initiate packet reception on PAN1, so **ACTIVE_NETWORK** is set to 1. Software initiates the Sequence R by writing to XCVSEQ. Hardware warms up the receiver on CHANNEL_NUM1 and enters preamble-search. In this example, no packet is received, but a data request from higher-level software requires a switch to PAN0. Software responds by aborting the reception by writing Sequence I to XCVSEQ. Software then sets **ACTIVE_NETWORK** to 0 to select PAN0. In the example, software initiates a Sequence TR. Hardware warms up the receiver for CCA on CHANNEL_NUM0, performs CCA (channel is idle), warms down the receiver, and warms up the transmitter on CHANNEL_NUM0, transmits the requested packet, warms down the transmitter and warms up the receiver again (as per the autosequence) on CHANNEL_NUM0, to receive the acknowledge packet. The acknowledge packet is received and the autosequence completes successfully with RXIRQ and SEQIRQ. Software elects to resume packet reception on PAN1 (which was in progress before the data request). Software toggles **ACTIVE_NETWORK** back to 1, and re-initiates Sequence R.

DUAL PAN MANUAL MODE

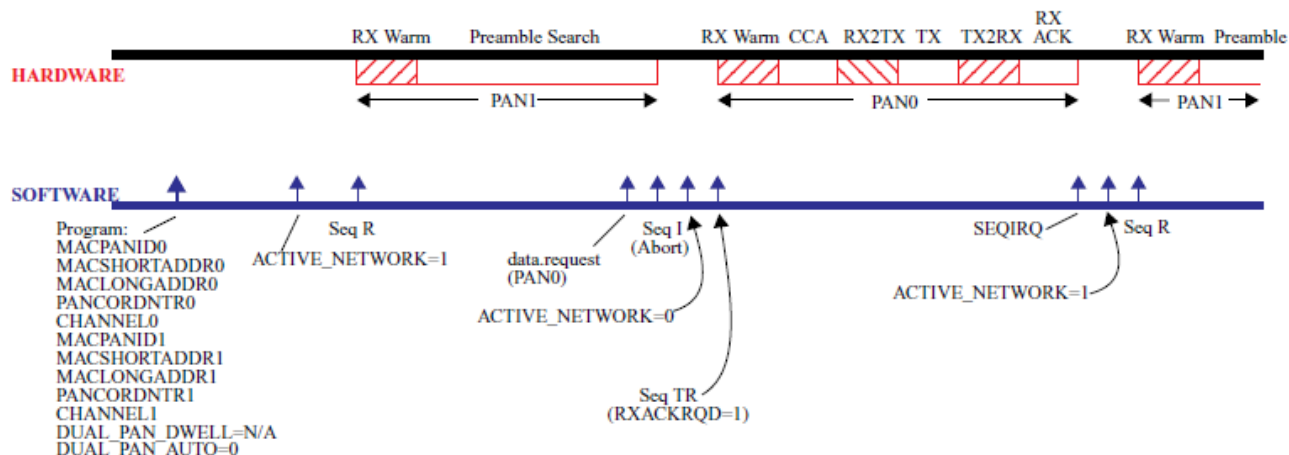

Auto Dual PAN

In automatic Dual PAN mode, hardware is responsible for alternating the selected PAN, at a pre-programmed interval. Software programs a "PAN dwell time", which determines the amount of time during which the hardware will receive on a given PAN. This is done by programming the **DUAL_PAN_DWELL** register. (For a description of the **DUAL_PAN_DWELL** register, and how it controls the channel frequency dwell time, see the [Register Description](#) section of this Block Guide). Software sets the **DUAL_PAN_AUTO** bit to 1 for automatic Dual PAN operation, and sets **ACTIVE_NETWORK** to correspond to the PAN on which it desires packet reception to begin. Software then initiates a Sequence R. Hardware warms up the receiver on the selected PAN, and begins preamble search. When the dwell time expires, assuming preamble and SFD have not been detected, hardware will switch to the alternate PAN. This includes an on-the-fly channel change. Once switched to the alternate PAN, hardware will use the address filtering parameters (PANCORDNTR, MacPanID, Short Address, and/or IEEE address) programmed for the alternate PAN. Once the dwell time expires on the alternate PAN, assuming preamble and SFD have not been detected, hardware will switch back to the original PAN. This process will repeat indefinitely, until one of the following occurs:

1. A packet is successfully received (address match and CRC valid).
2. Software aborts the Sequence R
3. A TMR3 RX timeout, which automatically aborts the Sequence R
4. A PLL unlock automatically aborts the Sequence R (if unlock aborting is enabled)

If the hardware PAN dwell timer expires *during* a packet reception (i.e., preamble and SFD have been detected during a Sequence R), the PAN-switch will be delayed until the packet is completely received. If the packet is received successfully (address match and CRC valid), the receive sequence will terminate with RXIRQ and SEQIRQ (if an auto-Acknowledge was requested and enabled, the sequence will complete after the Acknowledge packet was transmitted, and TXIRQ will also be set, in addition to RXIRQ and SEQIRQ); the PAN switch will occur at this point, after the Sequence has returned to IDLE.

If the received packet fails FCS (CRC check), or, if the packet was not intended for the device (address mismatch), the hardware will toggle the PAN, and return to preamble-search on the new PAN.

If the hardware PAN dwell timer expires during a state *other* than RX preamble search during Sequence R (i.e., if expiration occurs during TX, CCA, ED, Sequence TR, or any warmup or transitional state), PAN-switch will be delayed until either:

1. Preamble Search state is reached during a Sequence R (not Sequence TR)
2. Sequence returns to IDLE.

At any point, software can elect to interrupt the automatic Dual PAN operation, by aborting the sequence with a XCVSEQ=IDLE, and the setting the **DUAL_PAN_AUTO** bit to 0. In response, hardware will freeze the current state of the dwell timer, and capture the currently-selected PAN, so that hardware-controlled PAN alternation can resume where it left off, later. Software can then tend to that tasks that caused the Dual PAN interruption. When software wants to resume Dual PAN operation, it then sets **DUAL_PAN_AUTO=1**, and re-initiates Sequence R. Hardware will resume the dwell timer from the point it was frozen earlier, on the same PAN, and will warmup the receiver to receive on the PAN which was being monitored before the interruption. Hardware will dwell on that PAN until the timer expires, and then switch PAN's (assuming no preamble and SFD detected, subject to the conditions listed above). Software can always determine the selected PAN at any time, in any mode, by reading **CURRENT_NETWORK** bit. If **DUAL_PAN_AUTO=0**, then **CURRENT_NETWORK = ACTIVE_NETWORK**. If **DUAL_PAN_AUTO=1**, then **CURRENT_NETWORK** is controlled by hardware.

To initiate auto Dual PAN operation for the first time, or to reset the dwell timer to its programmed value and allow software to select the initial PAN for auto Dual PAN operation, software should program the desired initial PAN to **ACTIVE_NETWORK** (0 for PAN0, 1 for PAN1), and then program the desired dwell time into the **DUAL_PAN_DWELL** register. Hardware always responds to a write to **DUAL_PAN_DWELL**, by resetting the dwell timer to its programmed value, and selecting the initial PAN for auto Dual PAN operation, based on the state of

ACTIVE_NETWORK. A write to **DUAL_PAN_DWELL**, always re-initializes the DWELL TIMER to the programmed value. If a write to **DUAL_PAN_DWELL** occurs during an autosequence, the DWELL TIMER will begin counting down immediately. If a write to **DUAL_PAN_DWELL** occurs when there is no autosequence underway, the DWELL TIMER will not begin counting until the next autosequence begins; it will begin counting at the start of the autosequence warmup. Under all circumstances, **DUAL_PAN_AUTO** must be asserted to allow the DWELL TIMER to count. If **DUAL_PAN_AUTO=0**, the DWELL TIMER will freeze and hold its state, until **DUAL_PAN_AUTO=1**. However, a write to **DUAL_PAN_DWELL** will still initialize the DWELL TIMER to its programmed value, regardless of the state of **DUAL_PAN_AUTO**.

At any point during auto Dual PAN mode, software can ascertain the PAN currently being serviced by hardware, by reading the **CURRENT_NETWORK** bit. Software can also determine the time-remaining in the current dwell, by reading the **DUAL_PAN_REMAIN** Register.

In auto Dual PAN mode, software retains responsibility for initiating and aborting sequences. There is no provision for hardware-initiated sequences. TMR2 may be used to initiate an autosequence at a future time. TMR3 may be used as an RX hardware-abort mechanism.

The following diagram depicts Dual PAN operation in automatic mode. In this example, software populates both PAN parameters sets during initialization. In this example, software wants to initiate packet reception in auto Dual PAN mode, on PAN1, so **ACTIVE_NETWORK** is set to 1. For auto Dual PAN operation, software programs the desired PAN-switching interval into **DUAL_PAN_DWELL** register, in this case, 4ms. Software initiates the Sequence R by writing to XCVSEQ. The dwell timer begins counting as soon as the receiver warmup begins. Hardware warms up the receiver on CHANNEL_NUM1 (since PAN1 was selected as the initial PAN in this example), and begins preamble search. If a packet is received during this interval, hardware applies PAN1 address filtering. In this example, no preamble is detected at the point at which the dwell timer expires. So, at this point, hardware executes a PAN-switch to PAN0, which includes an on-the-fly channel change. The on-the-fly channel change requires approximately 93us and no preamble detection is possible during this "blind spot". (For more details on how the hardware executes the Dual PAN on-the-fly channel change, see the ZSM Sequence Manager Block Guide, Section [Dual PAN Mode](#).) After the PAN switch, hardware resumes preamble search on CHANNEL_NUM0, and applies PAN0 address filtering if a packet is received. In this example, no preamble is detected at the point at which the dwell timer expires. So, at this point, hardware performs a PAN-switch back to PAN1. And so on and so forth.

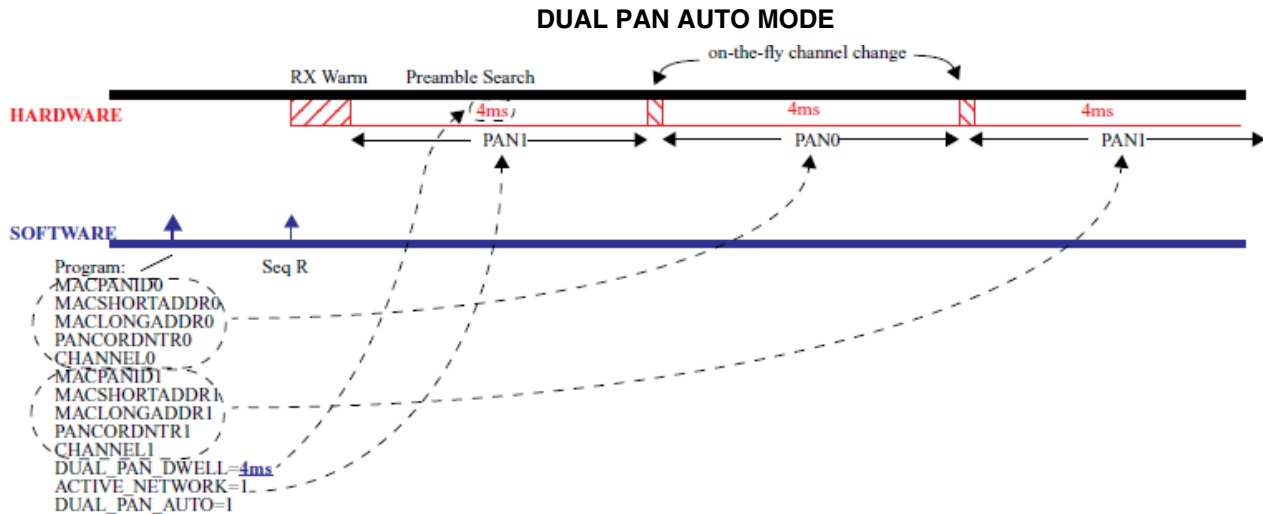

Two-PAN-one-channel

A special case occurs if a device is operating in Dual PAN mode (either Auto or Manual mode), and both PAN's occupy the same channel; in other words, `CHANNEL_NUM0=CHANNEL_NUM1`. In this case, hardware will detect this condition automatically, and apply both sets of address-filtering parameters simultaneously. Hardware will provide Data Indication if the received packet matches either the PAN0 address parameter set {`MACPANID0`, `MACSHORTADDRS0`, `MACLONGADDRS0`, `PANCORDNTR0`}, or the PAN1 address parameter set {`MACPANID1`, `MACSHORTADDRS1`, `MACLONGADDRS1`, `PANCORDNTR1`}. At Data Indication, two status bits can be queried by software to quickly determine on which PAN the packet was received, `RECD_ON_PAN0` or `RECD_ON_PAN1`. In the "Two-PAN-one-channel" scenario, it is possible for a packet to satisfy both sets of addressing parameters (PAN0 and PAN1). When this happens, both `RECD_ON_PAN0` and `RECD_ON_PAN1` will be set. In the "Two-PAN-one-channel" scenario, the `CURRENT_NETWORK` bit should be ignored, since both networks are simultaneously active.

If Dual PAN mode is not to be utilized, `ACTIVE_NETWORK` should be maintained at 0 (default) to select the PAN0 parameters for transceiving. In single PAN operation, the PAN1 parameter registers need not be programmed, and can be used as scratchpad. `CHANNEL_NUM1` should not be programmed, and should instead be left in its default state, if Dual PAN mode is not in use.

Dual PAN Channel Override

In Dual PAN mode, in case there is a need to generate a frequency which may be offset from the 16 prescribed 5MHz-spaced channels, to, for example, avoid interference on one of the Dual PAN channels, a method has been provided to do that, by designating one of the two PAN channels to use the transceiver's set of direct frequency-programming registers, instead of CHANNEL_NUMx. Programming the direct frequency-programming registers – integer, numerator, and denominator, allows an RF frequency to be selected with much more precision than the 5MHz granularity of the 802.15.4 mapped-channel registers, CHANNEL_NUM0 and CHANNEL_NUM1. This is referred to as “Dual PAN Channel Override”. For more details on this feature, see the ZSM Sequence Manager Block Guide, Section Dual PAN Channel Override.

45.6.2.5.3.5 Active Promiscuous Mode

Functional description

The 802.15.4 Wireless Medium Access Control (MAC) and Physical Layer (PHY) Specifications for Low-Rate Wireless Personal Area Networks (WPANs) defines the following behavior for Promiscuous Mode operation:

"In promiscuous mode, the MAC sublayer shall pass all frames received after the first filter directly to the upper layers without applying any more filtering or processing."

Where first level filtering is described as:

"For the first level of filtering, the MAC sublayer shall discard all received frames that do not contain a correct value in their FCS field in the MFR (see 7.2.1.9)"

Promiscuous mode allows a device to receive and process all 802.15.4 frames which pass FCS check (CRC), regardless of whether or not they are addressed to the device. This allows a device to receive and process all valid traffic on a network. In Promiscuous mode, the Packet Processor will provide a Data Indication on all such packets. This capability allows a simple network sniffer to be constructed, which can display comprehensive packet data for all packets transmitted on a network within receiving range of the device.

Since a device operating in promiscuous mode is designed to do so discreetly, automatic acknowledgement of all received packets is inhibited, regardless of the state of the Ack Request field in the Frame Control Field of the received packet; otherwise, the sniffing device would be acknowledging received frames for which it was not the addressee.

The Packet Processor features an "Active Promiscuous Mode". In this mode, the Packet Processor will process packets according to the same rules that it applies to Promiscuous mode, except that it will automatically transmit an acknowledgement packet *for frames*

that are addressed to the device. In other words, in Active Promiscuous mode, if the received frame meets all the address and packet filtering requirements that would have applied in non-promiscuous mode, an acknowledgement packet will be transmitted; a Data Indication will still be provided for all valid packets (those which pass FCS check). Note that all existing packet processor rules governing transmission of acknowledge packets, are still in effect; i.e., AUTOACK bit of the PHY_CTRL1 Register must be set to 1, and the Ack Request field in the Frame Control Field of the received packet must be set to 1.

The Packet Processor can be also programmed to provide a Data Indication for packets which fail FCS check, by setting CRC_MSK=0. Received packets which fail FCS check are never acknowledged, under any circumstances.

Special Handling for Broadcast Packets

Special rules apply to received packets which contain a broadcast PAN Identifier (0xffff), and/or a broadcast short address (0xffff). According to the 802.15.4 standard,

“For valid frames that are not broadcast, if the Frame Type subfield indicates a data or MAC command frame and the Acknowledgment Request subfield of the Frame Control field is set to one, the MAC sublayer shall send an acknowledgment frame.”

An exception is made for received packets which contain a broadcast PAN Identifier, and a long address which matches the device's IEEE address. Such packets are acknowledged, because the IEEE address uniquely identifies the device, regardless of PAN. This special case will apply also in Active Promiscuous mode; such packets will be acknowledged. The following diagram describes the packet processor's "acknowledgement decision" for all permutations of broadcast indicators in the received packet's addressing fields.

ACKNOWLEDGE-ON-BROADCAST (ALL PERMUTATIONS)

| | PAN ID = !BROADCAST DSTADDR = !BROADCAST | PAN ID = !BROADCAST DSTADDR = BROADCAST | PAN ID = BROADCAST DSTADDR = BROADCAST | PAN ID = BROADCAST DSTADDR = !BROADCAST |
|--------------------------------|---|--|---|--|
| SHORT | ACK | NO ACK | NO ACK | NO ACK |
| LONG | ACK | | | ACK |
| DESTINATION ADDRESS MODE | | | | |

Special Handling for Broadcast Packets

The Packet Processor features an autosequence to automatically receive, and verify, Acknowledge Frames after a Transmit frame has been sent by the device. This is accomplished by programming a Sequence TR with RXACKRQD=1. During normal operation, these receive Acknowledge Frames are not stored in the Packet Buffer. They are merely checked for matching Sequence Number and Frame Version, with a Data Indication issued for a valid match on both. In Active Promiscuous Mode, receive Acknowledge frames *will* be stored into the Packet Buffer, just like any other received frame. This saves software from having to re-construct the contents of the Acknowledge packet, from the contents of the packet which was originally transmitted. Ordinary Promiscuous Mode should therefore not be used with Sequence TR with RXACKRQD=1. Use Active Promiscuous instead.

45.6.2.5.3.6 Provisions to Enable Software Support for 802.15.4e and 802.15.4-2015

Addendum 802.15.4e to the 802.15.4-2011 standard introduces 3 new variations on the 802.15.4 MAC Frame Structure:

1. FrameVersion=2 (Frame Types: Beacon, Acknowledge, Data, and MAC Command)
2. LLDN Frame Type
3. Multipurpose Frame Type

In addition, the 802.15.4-2015 revision to the standard introduces a new Frame Type: Extended (Frame Type = 0b111).

All three of the “4e-compliant packets”, as well as the Extended Frame Type, modify the format and definition of the Frame Control Field in such a way as to render parsing of the MHR by the packet processor impossible, without major upgrades to the hardware. For example, the packet processor hardware does not support 8-bit (simple) addressing, nor Sequence Number Suppression.

As in interim solution, provisions have been added to the packet processor to allow these new packet variations to be recognized and conditionally admitted (Data Indication to software). Three new Frame Type control bits, and a modification of the Frame Version Filtering bits, are included in the Packet Processor, and affect hardware packet parsing as indicated in the following table:

| REGISTER | DEFINITION |
|---------------------|---|
| FRM_VER_FILTER[3:0] | <p>Frame Version selector. The incoming packet's Frame Control Field is parsed to obtain the FrameVersion subfield, and that value is compared against this register, in accordance with the following:</p> <p>xxx1: Accept received packets with FrameVersion=00 xx1x: Accept received packets with FrameVersion=01 x1xx: Accept received packets with FrameVersion=10 1xxx: Accept received packets with FrameVersion=11</p> <p>These filtering rules apply to Beacon, Acknowledge, Data, and MAC Command Frame Types, since these frame types require a 2-octet Frame Control Field which embeds a 2-bit FrameVersion subfield. Later frame types introduced in the 802.15.4e addendum (LLDN, Multipurpose) don't guarantee a FrameVersion subfield with the original meaning, so these filtering rules do not apply to those frame types. See registers LLDN_FT and MULTIPURPOSE_FT.</p> |
| LLDN_FT | <p>1: LLDN frame type enabled (Frame Type 4) 0: reject all LLDN frames</p> |
| MULTIPURPOSE_FT | <p>1: Multipurpose frame type enabled (Frame Type 5) 0: reject all Multipurpose frames</p> |
| EXTENDED_FT | <p>1: Extended frame type enabled (Frame Type 7) 0: reject all Extended frames</p> |

The Extended Frame Type does not comply with the General MAC Frame Format, which is shown in the following diagram:

| | | | | | | | | | | |
|----------------|-----------------|----------------------------|---------------------|-----------------------|----------------|---------------------------|---------------------------|-------------|---------------|-----|
| Octets: 1/2 | 0/1 | 0/2 | 0/2/8 | 0/2 | 0/2/8 | variable | variable | | variable | 2/4 |
| Frame Control | Sequence Number | Destination PAN Identifier | Destination Address | Source PAN Identifier | Source Address | Auxiliary Security Header | Information Elements (IE) | | Frame Payload | FCS |
| | | Addressing fields | | | | | Header IEs | Payload IEs | | |
| MHR | | | | | | | MAC Payload | | MFR | |

Figure 86—General MAC frame format

Figure 45-75. General MAC Frame Format

Instead, the Extended Frame has its own unique format, which is shown in the following diagram:

| | | |
|------------|---------------------|------------------------|
| Bits: 0-2 | 3-5 | variable |
| Frame Type | Extended Frame Type | Extended Frame Payload |

Figure 105—Extended frame format

Figure 45-76. Extended Frame Format

Because the Extended Frame Payload, which is not defined in the 802.15.4-2015 revision to the standard, would be intended to contain and fully specify the FCS, the Packet Processor will not be able to verify FCS on received packets with Frame Type Extended. FCS checking will need to be implemented in software.

Note: If the EXTENDED_FT bit is set to enable Data Indication on packets of Frame Type Extended, software should expect a substantial increase in the frequency of notifications, as a consequence of the lack of hardware verification of FCS, which will have implications for software workload as well as power consumption in the SoC.

When the packet processor receives any of the 4e-compliant frames, if the corresponding control bit is set, the hardware will skip Stage 2 filtering, and merely verify FCS. If FCS passes, the packet processor will notify software of the packet, without inspection of the addressing fields or payload. For such packets, software will be responsible for parsing the MHR and payload sections of the frame. If the corresponding control bit is not set, the packet processor will reject the received packet and there will be no Data Indication.

When the packet processor receives a packet of Frame Type Extended, if the EXTENDED_FT bit is set, the hardware will skip Stage 2 filtering, and after the entire packet is received, the packet processor will merely notify software of the packet, without inspection of the Extended Frame Type bits or the Extended Frame Payload. For such packets, software will be responsible for parsing the Extended Frame Type and the Extended Frame Payload sections of the frame. If the corresponding control bit is not set, the packet processor will reject the received packet and there will be no Data Indication.

Like all existing frames prior to 802.15.4e and 802.15.4-2015, a received frame may require an acknowledgement. In the case of the new 802.15.4e and 802.15.4-2015 frames, the required timing for the acknowledge frame transmission, has been modified. The acknowledgement no longer immediately follows the packet reception. For this reason, upon reception of any of these 4e-compliant 2015-compliant packets, the packet processor will cancel any auto-ACK transmission, regardless of the state of the PHY_CTRL[AUTOACK] bit and AR field of the received packet's Frame Control Field. Software will be responsible for constructing the acknowledgment packet and transmitting it at the appropriate time using a Sequence T.

To help expedite software processing of the 4e- and 2015-compliant Frame Types and Versions, additional status bits have been added to the 802.15.4 register set, which are described in the following table:

| STATUS BIT | RESIDES IN REGISTER | DEFINITION |
|------------------|---------------------|---|
| ENH_PKT_STATUS | IRQSTS | 1: The last packet received was 4e- or 2015-compliant (SW should query the RX_FRAME_FILTER register for additional status bits) 0: The last packet received was neither 4e- nor 2015-compliant |
| BEACON_FV2_REC'D | RX_FRAME_FILTER | 1: The last packet received was a FrameType Beacon with FrameVersion 2 0: The last packet received was not a FrameType Beacon with FrameVersion 2 |
| DATA_FV2_REC'D | RX_FRAME_FILTER | 1: The last packet received was a FrameType Data with FrameVersion 2 0: The last packet received was not a FrameType Data with FrameVersion 2 |
| ACK_FV2_REC'D | RX_FRAME_FILTER | 1: The last packet received was a FrameType Acknowledge with FrameVersion 2 0: The last packet received was not a FrameType Acknowledge with FrameVersion 2 |
| CMD_FV2_REC'D | RX_FRAME_FILTER | 1: The last packet received was a FrameType MAC Command with FrameVersion 2 0: The last packet received was not a FrameType MAC Command with FrameVersion 2 |
| LLDN_REC'D | RX_FRAME_FILTER | 1: The last packet received was a FrameType LLDN 0: The last packet received was not a FrameType LLDN |

Table continues on the next page...

Link Layer

| | | |
|--------------------|-----------------|--|
| MULTIPURPOSE_REC'D | RX_FRAME_FILTER | 1: The last packet received was a FrameType Multipurpose with FrameVersion 2 0: The last packet received was not a FrameType Multipurpose |
| EXTENDED_REC'D | RX_FRAME_FILTER | 1: The last packet received was a FrameType Extended 0: The last packet received was not a FrameType Extended |

The new status bits are mapped into the 802.15.4 Address space as shown in the diagram below:

| ADDR | BIT 7 | BIT 6 | BIT 5 | BIT 4 | BIT 3 | BIT 2 | BIT 1 | BIT 0 | REGISTER NAME |
|------|-------------------------------|--------------------------|----------------------------|------------------------|--|--------------------|----------------------|-----------------------|-----------------|
| 000 | RX_FRM_PEND r | PLL_UNLOCK_IRQ r/w/1c | FILTERFAIL_IRQ r/w/1c | RXWTRMRK_IRQ r/w/1c | CCA_IRQ r/w/1c | RX_IRQ r/w/1c | TX_IRQ r/w/1c | SEQ_IRQ r/w/1c | IRQSTS1 |
| 001 | CRCVALID r | CCA r | SRCADDR r | PI f | ENH_PKT_STATUS r | TSM_IRQ f | PB_ERR_IRQ r/w/1c | | IRQSTS2 |
| 03C | EXTENDED_FT rw 0 | NS_FT rw 0 | MULTIPURPOSE_FT rw 0 | LLDN_FT rw 0 | CMD_FT rw 1 | ACK_FT rw 1 | DATA_FT rw 1 | BEACON_FT rw 1 | RX_FRAME_FILTER |
| 03D | ACTIVE_PROMISCUOUS rw 0 | | | | FRM_VER_FILTER[3] FRM_VER_FILTER[2] FRM_VER_FILTER[1] FRM_VER_FILTER[0] rw 0 0 1 1 | | | | FRM_VER_FILTER |
| 03E | EXTENDED_REC'D r | MULTIPURPOSE_REC'D r | | LLDN_REC'D r | CMD_FV2_REC'D r | ACK_FV2_REC'D r | DATA_FV2_REC'D r | BEACON_FV2_REC'D r | RX_FRAME_FILTER |

Figure 45-77. Enhanced Packet Status Bits

45.6.2.5.3.7 Clocks

Packet Processor is a fully synchronous module. It has a single clock input **clk_250khz**. The clock frequency, 250KHz, is the 802.15.4 bit rate. This clock input is driven by a divide-down of the RF Oscillator, generated in the CRM (Clocks and Resets module). The Packet Processor has no asynchronous interfaces.

45.6.2.5.3.8 Reset

The Packet Processor has a single, active-low, asynchronous reset input: **rst_b**. At integration, this reset should be tied to the master reset for the entire transceiver. There are no special reset requirements.

45.6.2.5.3.9 Interrupts

The Packet Processor does not generate any interrupts.

45.6.2.6 802.15.4 Sequence Manager (ZSM)

45.6.2.6.1 Introduction

This Block Guide describes the 802.15.4 Sequence Manager.

45.6.2.6.1.1 Overview

The 802.15.4 Sequence Manager (ZSM) is a hardware state machine which controls the timing of all transmit, receive, and CCA operations for the 802.15.4 Link Layer. The ZSM manages high-level 802.15.4 required timing (autosequences), and interfaces directly with a lower-level, protocol-neutral sequence manager called the Transceiver Sequence Manager (TSM), which manages the direct control of the digital, analog, and RF components of the 2.4GHz transceiver. See the TSM Block Guide for more details.

For each digital and analog element in the 2.4GHz transceiver, the ZSM and TSM operate seamlessly and collaboratively, to perform some or all of the following functions:

- activation
- deactivation
- initialization
- mode transitions
- initiating calibration routines
- clock enabling and disabling
- interrupt triggering and status generation

Designed into the ZSM are a variety of complex sequences, called autosequences, which are sequential concatenations of simpler, building-block sequences. The hardware autosequences provide the following advantages:

- smaller SW memory footprint: HW automates operations previously done by SW
- increases MCU sleep times, reducing current consumption
- handles timing-critical sequences (rx-to-tx), e.g., data-polling, not possible in SW

Sequences can be initiated by software directly, or alternatively, can be initiated automatically at the expiration of a hardware timer. The general parameters of the sequences can be programmed by software prior to initiating the sequences. Such parameters allow software to select, for example:

- whether CCA is required ahead of a transmit sequence
- whether an automatic Ack frame should be transmitted after a receive sequence
- slotted vs. unslotted mode
- type of CCA (e.g., Energy Detect, CCA Mode 2)

- whether the device is a PAN Coordinator or not
- whether the device resides on 2 networks simultaneously (Dual PAN mode)

The Sequence Manager also includes support for Dual PAN Mode, and Active Promiscuous Mode.

45.6.2.6.1.2 Features

- Supports complex sequences
- Unburdens software by automating many transceiver operations
- Data-polling accelerator hardware enables critical-timing sequences
- Includes Continuous CCA for low-latency-transmit applications
- Includes capability to conditionally perform CCA prior to every transmit operation
- Includes capability to conditionally transmit an Ack frame after every receive operation
- Supports software- or timer-initiated sequences
- Fully supports 2003 and 2006 versions of the 802.15.4 standard
- Supports slotted and unslotted modes
- Supports beacon-enabled and non-beacon-enabled networks
- Supports orderly transceiver shutdown on PLL unlock event
- Increases software visibility by making SEQ_STATE state readable
- Supports Dual PAN Mode, including on-the-fly channel changing
- Supports Active Promiscuous Mode

45.6.2.6.1.3 Modes and operations

The ZSM controls, coordinates, and automates all 802.15.4 transceiver operations within the 2.4GHz radio. Software selects the desired sequence, sets the general parameters, and (optionally) configures a hardware timer to trigger the sequence at a precise time in the future. Subsequently, the MCU can enter a low-power state, or tend to other activities, while the sequence manager state machine conducts the programmed transceiver operations. When the sequence completes, an interrupt alerts the MCU. At this point the MCU can check the completion status of the sequence, download received data from the packet buffer, and then prepare the next sequence. Sequences can be simple transceiver operations. For example, transmit one frame, or, perform a CCA on a channel.

Alternatively, the sequence manager supports complex sequences, which use simple operations as building blocks, strung together in a back-to-back fashion, with precise timing intervals between operations. For example, a “TR” sequence calls for a transmit frame followed by a receive frame. For complex sequences, interrupts can optionally be generated at the completion of each stage of the sequence, providing greater visibility for the MCU into the timeline of the sequence. Software can determine the precise state of

the sequence manager state machine at any time. Software can opt to abort a sequence at any time; when this happens, the sequence manager will return to its IDLE state in an orderly fashion.

45.6.2.6.1.4 Block diagram

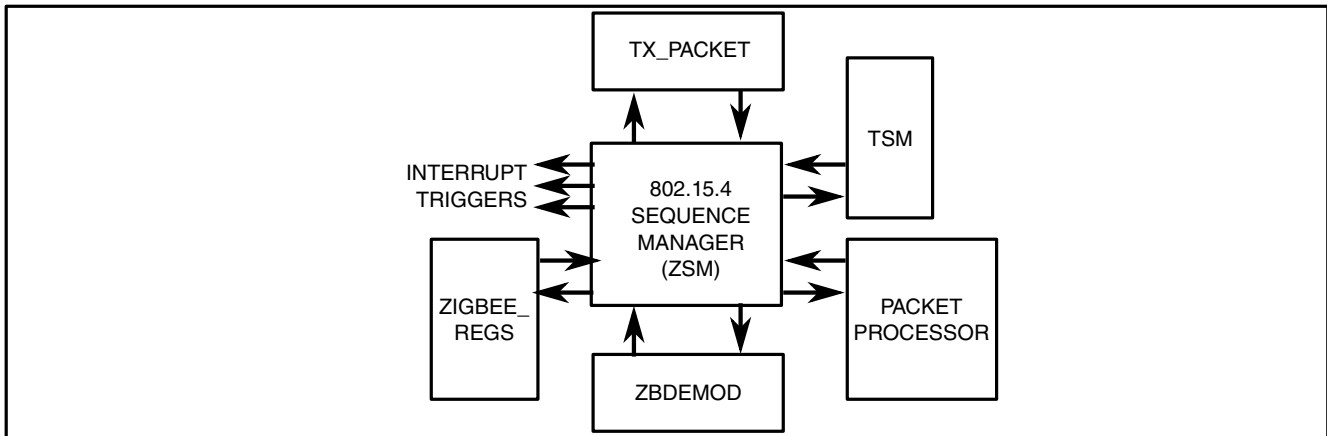

Figure 45-78. Block diagram

45.6.2.6.2 Memory Map and register definition

Numerous registers exist to provide configuration and status for the Sequence Manager. See table below.

| Field | R/W | Description | | | | | | | | | | | | | | | | | | | | | |
|--------|----------|--|--------|----------|-------------|---|---|------|---|---|---------|---|---|----------|---|---|-----|---|----|------------------|---|------|----------------|
| XCVSEQ | rw | <p>The Transceiver Sequence Selector register selects a sequence for the sequence manager to execute. Sequence initiation can be immediate, or scheduled (see TMRTRIGEN). A write of XCVSEQ=IDLE will abort any ongoing sequence. A write of XCVSEQ=IDLE must always be performed after a sequence is complete, and before a new sequence is programmed. Any write to XCVSEQ other than XCVSEQ=IDLE during an ongoing sequence, shall be ignored. The mapping of XCVSEQ to sequence types is as follows:</p> <table border="1"> <thead> <tr> <th>XCVSEQ</th> <th>SEQUENCE</th> <th>DESCRIPTION</th> </tr> </thead> <tbody> <tr> <td>0</td> <td>I</td> <td>IDLE</td> </tr> <tr> <td>1</td> <td>R</td> <td>RECEIVE</td> </tr> <tr> <td>2</td> <td>T</td> <td>TRANSMIT</td> </tr> <tr> <td>3</td> <td>C</td> <td>CCA</td> </tr> <tr> <td>4</td> <td>TR</td> <td>TRANSMIT/RECEIVE</td> </tr> <tr> <td>5</td> <td>CCCA</td> <td>CONTINUOUS CCA</td> </tr> </tbody> </table> | XCVSEQ | SEQUENCE | DESCRIPTION | 0 | I | IDLE | 1 | R | RECEIVE | 2 | T | TRANSMIT | 3 | C | CCA | 4 | TR | TRANSMIT/RECEIVE | 5 | CCCA | CONTINUOUS CCA |
| XCVSEQ | SEQUENCE | DESCRIPTION | | | | | | | | | | | | | | | | | | | | | |
| 0 | I | IDLE | | | | | | | | | | | | | | | | | | | | | |
| 1 | R | RECEIVE | | | | | | | | | | | | | | | | | | | | | |
| 2 | T | TRANSMIT | | | | | | | | | | | | | | | | | | | | | |
| 3 | C | CCA | | | | | | | | | | | | | | | | | | | | | |
| 4 | TR | TRANSMIT/RECEIVE | | | | | | | | | | | | | | | | | | | | | |
| 5 | CCCA | CONTINUOUS CCA | | | | | | | | | | | | | | | | | | | | | |

Table continues on the next page...

Link Layer

| Field | R/W | Description |
|--------------|-----|---|
| TMRTRIGEN | rw | Timer2 Trigger Enable. 1: allow timer TC2 (or TC2') to initiate a preprogrammed sequence (see XCVSEQ register). 0: programmed sequence initiates immediately upon write to XCVSEQ. |
| CCABFRTX | rw | CCA Before TX. Applies only to Sequences T and TR, ignored during all other sequences. 1: at least one CCA measurement is required prior to the transmit operation (see also SLOTTED). 0: no CCA required, transmit operation begins immediately. |
| SLOTTED | rw | Slotted Mode, for beacon-enabled networks. Applies only to Sequences T, TR, and R, ignored during all other sequences. Used, in concert with CCABFRTX, to determine how many CCA measurements are required prior to a transmit operation. Also used during R sequence to determine whether the ensuing transmit acknowledge frame (if any) needs to be synchronized to a backoff slot boundary. |
| RXACKRQD | rw | Receive Acknowledge Frame required. Applies only to Sequence TR, ignored during all other sequences. 1: A receive Ack frame follows the transmit frame. 0: An ordinary receive frame (not an Ack frame) follows the transmit frame. |
| AUTOACK | rw | Auto Acknowledge Enable. Applies only to Sequence R and Sequence TR, ignored during other sequences. 1: sequence manager will follow a receive frame with an automatic hardware-generated Tx Ack frame, assuming other necessary conditions are met. 0: sequence manager will not follow a receive frame with a Tx Ack frame, under any conditions; the sequence will terminate after the receive frame. |
| CRC_MSK | rw | CRC Mask. 1: sequence manager requires CRCVALID=1 at the end of the received frame in order for the receive operation to complete successfully; if CRCVALID=0, sequence manager will return to preamble-detect mode after the last octet of the frame has been received. 0: sequence manager ignores CRCVALID and considers the receive operation complete after the last octet of the frame has been received. |
| PROMISCUOUS | rw | Prevents auto-TxAck on received packets 1: promiscuous mode, no auto-TxAck 0: auto-TxAck allowed, depending on other conditions. |
| CCATYPE[1:0] | rw | Clear Channel Assessment Type. Selects one of four possible functions for CCA or ED, per below. (see CCA Block Guide for more details). 00: ENERGY DETECT 01: CCA MODE 1 10: CCA MODE 2 |

Table continues on the next page...

| Field | R/W | Description | | | | | | |
|------------------------|-----------------------|---|------------------------|-----------------------|---------------------|----|-------|------------|
| | | 11: CCA MODE 3 | | | | | | |
| TC3TMOUT | rw | 1: Allow a TMR3 timeout to abort any RX operation 0: Don't allow a TMR3 timeout to abort any RX operation See Appendix A of this Block Guide for more details on how autosequences are affected by a TMR3 timeout | | | | | | |
| SEQ_STATE[4:0] | r | This read-only register reflects realtime Sequence Manager state | | | | | | |
| ACTIVE_PROMISCUOUS | rw | 1: Provide Data Indication on all received packets under the same rules which apply in PROMISCUOUS mode, however acknowledge those packets under rules which apply in non-PROMISCUOUS mode 0: normal operation (Default) | | | | | | |
| ACTIVE_NETWORK | rw | Selects the PAN on which to transceive, by activating a PAN parameter set (PAN0 or PAN1). In Manual Dual PAN mode (or Single PAN mode), this bit selects the active PAN parameter set (channel and addressing parameters) which governs all autosequences. In Auto Dual PAN mode, this bit selects the PAN on which to begin transceiving, latched at the point at which DUAL_PAN_DWELL register is written. 1: Select PAN1 0: Select PAN0 (Default) | | | | | | |
| DUAL_PAN_AUTO | rw | Activates automatic Dual PAN operating mode. In this mode, PAN-switching is controlled by hardware at a pre-programmed rate, determined by DUAL_PAN_DWELL. 1: Auto Dual PAN Mode 0: Manual Dual PAN mode (or Single PAN mode). Default. Whenever DUAL_PAN_AUTO=0, CURRENT_NETWORK=ACTIVE_NETWORK at all times. In other words, software directly controls which PAN is selected. Whenever DUAL_PAN_AUTO=1, CURRENT_NETWORK is controlled by hardware | | | | | | |
| CURRENT_NETWORK | r | This read-only bit indicates which PAN is currently selected by hardware in automatic Dual PAN mode 1: PAN1 is selected 0: PAN0 is selected | | | | | | |
| DUAL_PAN_DWELL[7:0] | rw | Channel Frequency Dwell Time. In Auto Dual PAN mode, hardware will toggle the PAN, after dwelling on the current PAN for the interval described below (assuming Preamble/SFD not detected). A write to DUAL_PAN_DWELL, always re-initializes the DWELL TIMER to the programmed value. If a write to DUAL_PAN_DWELL occurs during an autosequence, the DWELL TIMER will begin counting down immediately. If a write to DUAL_PAN_DWELL occurs when there is no autosequence underway, the DWELL TIMER will not begin counting until the next autosequence begins; it will begin counting at the start of the sequence warmup. | | | | | | |
| | | <table border="1"> <thead> <tr> <th>PRESCALER (bits [1:0])</th> <th>TIMEBASE (bits [7:2])</th> <th>RANGE (min) - (max)</th> </tr> </thead> <tbody> <tr> <td>00</td> <td>0.5ms</td> <td>0.5 - 32ms</td> </tr> </tbody> </table> | PRESCALER (bits [1:0]) | TIMEBASE (bits [7:2]) | RANGE (min) - (max) | 00 | 0.5ms | 0.5 - 32ms |
| PRESCALER (bits [1:0]) | TIMEBASE (bits [7:2]) | RANGE (min) - (max) | | | | | | |
| 00 | 0.5ms | 0.5 - 32ms | | | | | | |

Table continues on the next page...

| Field | R/W | Description | | | | | | | | | | | | |
|--------------------------|-----------------------|--|-----------------------|---------------------|--------------------------|-----------------------|----|-------|----|-------|----|------|----|------|
| | | PRESCALER (bits [1:0]) | TIMEBASE (bits [7:2]) | RANGE (min) - (max) | | | | | | | | | | |
| | | 01 | 2.5ms | 2.5 - 160ms | | | | | | | | | | |
| | | 10 | 10ms | 10 - 640ms | | | | | | | | | | |
| | | 11 | 50ms | 50ms - 3.2seconds | | | | | | | | | | |
| | | <p>A write to DUAL_PAN_DWELL also causes the value of ACTIVE_NETWORK to get latched into the hardware. This latched value will be the starting point for the automatic dual-pan mode (i.e., start on PAN0 or on PAN1). The starting value takes effect immediately (if sequence is underway and DUAL_PAN_AUTO=1), or is otherwise delayed until sequence starts and DUAL_PAN_AUTO=1.</p> | | | | | | | | | | | | |
| DUAL_PAN_REMAIN[5:0] | | <p>This read-only register indicates time remaining before next PAN switch in auto Dual PAN mode. The units for this register, depend on the PRESCALER setting (bits [1:0]) in the DUAL_PAN_DWELL register, according to the following table:</p> <table border="1"> <thead> <tr> <th>DUAL_PAN_DWELL PRESCALER</th> <th>DUAL_PAN_REMAIN UNITS</th> </tr> </thead> <tbody> <tr> <td>00</td> <td>0.5ms</td> </tr> <tr> <td>01</td> <td>2.5ms</td> </tr> <tr> <td>10</td> <td>10ms</td> </tr> <tr> <td>11</td> <td>50ms</td> </tr> </tbody> </table> <p>The readback value indicates that between N-1 and N timebase units remain until the next PAN switch. For example, a DUAL_PAN_REMAIN readback value of 3, with a DUAL_PAN_DWELL PRESCALER setting of 2 (10ms), indicates that between 20ms (2*10ms) and 30ms (3*10ms), remain until the next automatic PAN switch.</p> | | | DUAL_PAN_DWELL PRESCALER | DUAL_PAN_REMAIN UNITS | 00 | 0.5ms | 01 | 2.5ms | 10 | 10ms | 11 | 50ms |
| DUAL_PAN_DWELL PRESCALER | DUAL_PAN_REMAIN UNITS | | | | | | | | | | | | | |
| 00 | 0.5ms | | | | | | | | | | | | | |
| 01 | 2.5ms | | | | | | | | | | | | | |
| 10 | 10ms | | | | | | | | | | | | | |
| 11 | 50ms | | | | | | | | | | | | | |
| RECD_ON_PAN0 | r | <p>Indicates the packet which was just received, was received on PAN0.</p> <p>In Dual PAN mode operating on 2 different channels, RECD_ON_PAN0 will be set if CURRENT_NETWORK=0 when the packet was received, regardless of FILTERFAIL status.</p> <p>In DUAL PAN mode operating with same channel on both networks, CURRENT_NETWORK will be ignored and RECD_ON_PAN0 will be set only if a valid packet was received on PAN0 (PAN0's FILTERFAIL_FLAG is deasserted).</p> | | | | | | | | | | | | |
| RECD_ON_PAN1 | r | <p>Indicates the packet which was just received, was received on PAN1.</p> <p>In Dual PAN mode operating on 2 different channels, RECD_ON_PAN1 will be set if CURRENT_NETWORK=1 when the packet was received, regardless of FILTERFAIL status.</p> <p>In DUAL PAN mode operating with same channel on both networks, CURRENT_NETWORK will be ignored and RECD_ON_PAN1 will be set only if a valid packet was received on PAN1 (PAN1's FILTERFAIL_FLAG is deasserted).</p> | | | | | | | | | | | | |

Table continues on the next page...

| Field | R/W | Description |
|---------------------|-----|---|
| ACKDELAY[5:0] | rw | <p>Provides a fine-tune adjustment of the time delay between Rx warmdown and the beginning of Tx warmup for an Tx Acknowledge packet. ACKDELAY register will apply to both SLOTTED and UNSLOTTED TxAck, but only to TxAck (not T sequences). This is a two's complement value. The minimum permissible value is -19 (0x2D). Values less than -19 will lead to unexpected results.</p> <p>Resolution = 2us.</p> <p>Range = +/- 62us.</p> <p>Default = 0x0.</p> <p>Max ACKDELAY = 0x1F.</p> <p>Min ACKDELAY = 0x2d.</p> |
| TXDELAY[5:0] | rw | <p>Provides a fine-tune adjustment of the time delay between post-CCA Rx warm-down and the beginning of Tx warm-up for an Tx (non-Ack) packet. TXDELAY register will apply in both SLOTTED and UNSLOTTED modes, but only to T sequences (e.g., T, TR, and T(R)), not TxAck operations. This is a two's complement value. The minimum permissible value is -19 (0x2D). Values less than -19 will lead to unexpected results.</p> <p>Resolution = 2us.</p> <p>Range = +/- 62us.</p> <p>Default = 0x0.</p> <p>Max TXDELAY = 0x1F.</p> <p>Min TXDELAY = 0x2d</p> |
| CLR_NEW_SEQ_INHIBIT | rw | <p>when asserted, overrides the automatic hardware locking of the programmed XCVSEQ while an autosequence is underway. Asserting this feature will allow software to change the programmed autosequence "on-the-fly", without aborting and returning to idle between sequences. Overriding the hardware lockout of XCVSEQ should be used with caution, since the Sequence Manager is not designed (or verified) for manual state transitions between one type of autosequence and other (i.e., Sequence T -> Sequence R).</p> |
| NO_RX_RECYCLE | rw | <p>when asserted, prevents the Sequence Manager from automatically re-starting the receiver when a packet is received which results in a FilterFail or CRC failure. Normally, the Sequence Manager jumps to the RX_CYC state, and then resumes from there with a new Rx warmup, in search of a new packet. When this bit is set, the Sequence Manager will instead return to idle state, and issue a SEQIRQ, after a FilterFail or CRC failure.</p> |
| LATCH_PREAMBLE | rw | <p>1: Make PREAMBLE_DET and SFD_DET bits of PHY_STS Register "sticky", i.e., occurrences of preamble and SFD detection are latched and held until the start of the next autosequence</p> <p>0: Don't make PREAMBLE_DET and SFD_DET bits of PHY_STS Register "sticky", i.e, these status bits reflect the realtime, dynamic state of preamble_detect and sfd_detect. (default)</p> |
| XCVSEQ_ACTUAL[2:0] | r | <p>indicates the programmed sequence that has been recognized by the Sequence Manager.</p> <p>Takes into account the fact that sequence-change commands from software are ignored</p> |

Table continues on the next page...

Link Layer

| Field | R/W | Description |
|---------------------|-----|---|
| | | while a sequence is underway (see new_seq_inhibit bit). Read-only bits. |
| SEQ_IDLE | r | when asserted, indicates that the Sequence Manager is in its idle state. Read-only bit. |
| NEW_SEQ_INHIBIT | r | when asserted, indicates that a new programmed autosequence has commenced (TMR2 match has occurred if TMRTRIGEN=1). Once this bit is asserted, software is blocked from commanding any new autosequences (other than Sequence I to abort the current sequence), until the current sequence completes. Hardware will ignore a sequence-change command from software while this bit is asserted. Hardware will automatically deassert this bit once the sequence completes. Read-only bit. |
| RX_TIMEOUT_PENDING | r | when asserted, indicates that a TMR3 timeout (RX timeout) flag has been set by Hardware, but the Sequence Manager has not yet aborted because an RX operation is not currently underway. This would be the case, for example, during a Sequence TR, if a TMR3 timeout were to occur during the transmit operation of this sequence; the sequence would not be aborted by Hardware until the receive operation begins. This bit will always be 0 if TC3TMOUT=0. Read-only bit. |
| RX_MODE | r | indicates that an RX operation is in progress. CCA and ED operations are considered RX operations. Read-only bit. |
| TMR2_SEQ_TRIG_ARMED | r | when asserted, indicates that TMR2 has been programmed and is armed to trigger a new autosequence, when Sequence Manager timer-triggering mode is selected (i.e., TMRTRIGEN=1). When timer-triggering mode is selected, TMR2 must be re-programmed (using either T2CMP or T2), in advance of each new sequence. Once TMR2 is programmed, this bit will be asserted, and will remain asserted until the new sequence commences (at TMR2 match). Hardware will deassert this bit when the new sequence starts. When TMRTRIGEN=0, this bit should be ignored. Read-only bit. |
| SW_ABORTED | r | when asserted, indicates that the autosequence has terminated due to an Software abort. Software can abort any programmed autosequence by writing Sequence I to XCVSEQ. This bit is valid at the SEQIRQ interrupt. Hardware will maintain this bit asserted until the next autosequence commences. Read-only bit. |
| TC3_ABORTED | r | when asserted, indicates that the autosequence has terminated due to an TC3 (TMR3) timeout during a receive operation. This bit is valid at the SEQIRQ interrupt. Hardware will maintain this bit asserted until the next autosequence commences. Read-only bit. |
| PLL_ABORTED | r | when asserted, indicates that the autosequence has terminated due to an PLL unlock event. This bit is valid at the SEQIRQ interrupt. Hardware will maintain this bit asserted until the next autosequence commences. Read-only bit. |
| CCCA_BUSY_CNT[5:0] | r | For Sequence CCCA mode only, this register indicates the number of "busy" CCA attempts which occurred during the autosequence, before the channel was detected to be idle. This register can also be read in real-time (during the autosequence) to determine how many busy CCA attempts have occurred to that point. The register saturates at 63 (i.e., if there are more than 63 busy attempts, the register will continue to read 63). This register is automatically cleared to zero by hardware when the next autosequence commences. Read-only register. |

Table continues on the next page...

| Field | R/W | Description |
|-------------------|-----|---|
| SEQ_T_STATUS[5:0] | r | Status of the just-completed (or ongoing) Sequence T or Sequence TR autosequence. This register is valid at all times during, and after, the Sequence T or Sequence TR. Not valid for other types of autosequences. This is a read-only register. The bits of this register map to status, according to the following table: [0] 1st CCA complete (CCABFRTX=1) [1] 2nd CCA complete (SLOTTED=1) [2] Tx operation complete [3] Rx Rec ycle occurred (Sequence TR only) [4] Rx operation complete (Sequence TR only) [5] TxAck operation complete(Sequence TR only) |
| CONTINUOUS_EN | rw | Enable Continuous TX or RX mode (testmode). See Appendix B. |
| SLOT_PRELOAD[7:0] | rw | This register represents the number that gets loaded into the slot_timer at SFD detect, which ultimately determines when the next slot boundary will occur. Due to processing delays within the analog front-end and digital modem, the point at which SFD is detected by the modem, is delayed relative to over-the-air timing. Since this timing may not be known prior to until actual silicon, and since this is such a critical timing parameter for slotted operations, it has been made programmable. The default value is 0x74. This timing parameter is critical for the Sequence R autosequence in slotted mode, when an automatic TxAck is required. |

45.6.2.6.3 Functional description

This section describes the supported sequences in more detail. All sequences can be initiated by software directly (instantaneously) by writing the desired sequence to the XCVSEQ register, with the TMRTRIGEN bit deasserted. Alternatively, software can schedule the initiation of a sequence at a precise time in the future, by programming the desired start time into the T2CMP (or T2PRIMECMP) timer compare register, and setting the TMRTRIGEN bit. The XCVSEQ register field is writable and readable, so software can read this register to determine which sequence it had programmed earlier. After the sequence completes (SEQIRQ interrupt), software should set the XCVSEQ to IDLE (0x0), before initiating a new sequence. If the sequence-complete interrupt (SEQIRQ) is masked, software can determine when the sequence is complete by polling the SEQ_STATE register, until it returns to SEQ_IDLE (0x0). While a sequence is ongoing, software can abort the sequence at any time by writing IDLE (0x0) to XCVSEQ; the sequence manager state machine will respond with an orderly return to the SEQ_IDLE state, and a SEQIRQ will be generated. While a sequence is underway, software should not attempt to change XCVSEQ (other than aborting the sequence as previously described); the sequence manager will ignore all mid-sequence attempts to change XCVSEQ. As mentioned previously, software should write the IDLE value to XCVSEQ before changing sequences. If TMR2 triggering is enabled (TMRTRIGEN=1),

after the scheduled sequence is automatically launched at TMR2 match, and then completes, software must re-arm TMR2 triggering by writing to either T2CMP, or T2PRIMECMP. At least the LS byte of one of these registers must be written to re-arm. This hardware interlock is designed to prevent the inadvertent re-triggering of sequences, which would otherwise occur after the 24-bit Event Timer rolls over.

The supported sequences are shown in the following table.

Table 45-34. Supported Sequences

| XCVSEQ | Sequence | Description |
|--------|----------|---|
| 0 | I | Idle |
| 1 | R | Receive Sequence - conditionally followed by a TxAck |
| 2 | T | Transmit Sequence |
| 3 | C | Standalone CCA |
| 4 | TR | Transmit /Receive Sequence - transmit unconditionally followed by either an R or RxAck |
| 5 | CCCA | Continuous CCA - sequence completes when channel is idle |
| 6 | Reserved | |
| 7 | Reserved | |

All sequences can be aborted by a PLL unlock detection. The unlock detection is qualified by the sequence manager; in other words, an unlock detection during the early stages of the PLL warmup is expected, and is not allowed to abort the sequence at that point. The primary rationale for the PLL unlock abort, is to prevent transmission on an incorrect, or unstable, frequency during a transmit operation, or to increase battery life by not prolonging a receive or CCA operation that is bound to fail. Software can disable the PLL unlock auto-abort. See Section [Sequence Aborting](#), this Block Guide.

45.6.2.6.3.1 Supported Sequences

45.6.2.6.3.1.1 Sequence I (Idle)

When the IDLE value is written to XCVSEQ, the sequence manager goes to its SEQ_IDLE state. If not already in SEQ_IDLE, the sequence manager executes an orderly warmdown to return to SEQ_IDLE. A SEQIRQ interrupt is then issued. Writing IDLE value to XCVSEQ is the proper way to abort a sequence.

When a sequence is aborted in this way (called a software abort), the SW_ABORTED bit of the ABORT_STS register in 802.15.4 space, will become set. This bit will be self-cleared at the start of the next autosequence.

45.6.2.6.3.1.2 Sequence R (Receive)

Sequence R is the basic receive sequence. Sequence R can be used to receive all types of 802.15.4 PHY- and MAC-compliant frames, including reserved frame types. However, reception of Acknowledge frames is not recommended using Sequence R. This is because reception of an Acknowledge frame, usually follows a transmitted frame, with a designated Sequence Number, so that the received Acknowledge frame can be verified for the matching Sequence Number. In a standalone Sequence R, there is no Sequence Number to verify against, so any Acknowledge frame is merely transferred to the Packet Buffer. (Note: the appropriate way to receive Acknowledge frames is with Sequence TR, with the RXACKRQD bit asserted). Using Sequence R, *all* frames which pass frame-filtering rules and CRC check, are transferred to the Packet Buffer.

The basic execution of a successful Sequence R is as follows:

- MCU writes TC2 compare value to the desired initiation time, and sets TMRTRIGEN (optional)
- MCU writes XCVSEQ=R
- Wait for TC2 match (if TMRTRIGEN=1)
- SEQ_MGR executes RxWarmup
- Preamble Detected
- SFD Detected
- FrameLength octet received, transferred to Packet Buffer
- N additional octets received ($N = \text{FrameLength}$), transferred to Packet Buffer. *Note if ($\text{FrameLength} > 127$), then $N = 127$.*
- If frame-filtering rules and CRC check pass:
 - ---> RXIRQ interrupt issued
 - ---> SEQ_MGR executes RxWarmdown
 - ---> If received Frame Control Field indicates AckRequest=1
 - ---- ---> SEQ_MGR executes TxWarmup
 - ---- ---> an Ack frame is transmitted using the received Sequence Number
 - ---- ---> SEQ_MGR executes TxWarmdown
- SEQIRQ interrupt issued

When Sequence R is initiated, the ZSM sequence manager warms up the receiver (analog and digital elements), via the TSM (Transceiver Sequence Manager). See TSM Block Guide. After warmup is complete, timer TMR3 can be enabled as a “bracketing” timer (software option). If a TMR3 timer match occurs, and software has asserted the TC3TMOUT bit, the sequence manager will warm down the receiver and return to

SEQ_IDLE state. Assuming no TMR3 timeout, reception proceeds in preamble-search mode. Once a preamble is detected, reception continues in SFD-search mode. At this point, the sequence manager's slot timer is activated. This is because a slotted "transmit acknowledge" frame (TxAck) may be required later in this sequence. The slot timer is loaded with the following value (in us):

$$\text{Slot Timer Preload} = 160 + \text{TXWARMUPTIME} + (2 * \text{ACKDELAY}).$$

The 160 term arises because, at the point of SFD detection, we are exactly 10 symbols into the backoff slot, and the symbol period is 16us. The slot timer will count up and eventually rollover at 319, to 0. (There are 320us in a backoff slot). The receiver receives the next octet (FrameLength). Starting with this octet, and continuing through the remainder of the frame, each octet that is received is transferred to Packet Buffer. After each octet is transferred to Packet Buffer, the Packet Buffer address is incremented by 1. The next 2 octets (Frame Control Field) are then received, which are parsed to obtain the AckRequest field, and the FrameVersion field. The next octet is then received (SequenceNumber), and stored. The remainder of the frame, determined by FrameLength, is then received. As the octets are received, the packet data is parsed and subjected to packet-filtering rules (see Packet Processor Block Guide). If any of the packet-filtering rules fail, or if the CRC check on the FCS field fails, the sequence manager will return the receiver to preamble-search mode, after the last octet has been received and transferred to Packet Buffer. Assuming the packet-filtering rules and CRC pass, an interrupt (RXIRQ) is issued to the MCU. At this point, the sequence manager must determine if a TxAck is required. A TxAck is required if the following 3 conditions are all met:

- AUTOACK=1 (register bit)
- PROMISCUOUS=0 (register bit)
- The received FrameControlField has AckRequest=1

If these conditions are met, and SLOTTED mode is not in effect, the sequence manager loads its TxAck timer with the following value (in us):

$$\text{TxAck Timer Preload} = 192 - \text{TXWARMUPTIME} - 2 * \text{ACKDELAY}$$

The 192us is the non-slotted RX-to-TX turnaround requirement in the 802.15.4 standard. The TXWARMUPTIME takes into account the fact that the TxAck timer must expire early for the Tx warmup to be complete at exactly the 192us point. The ACKDELAY is a signed, fine-tune adjustment to the TxAck transmission time (+/- 62us).

If SLOTTED mode is in effect, the slot timer was previously loaded (at SFD detect), but the sequence manager needs to determine how much time is left in the current backoff slot. If less than 192us remain, the sequence manager must wait an *additional* backoff slot before initiating the Ack transmission. So it sets a flag indicating it must allow the slot counter to rollover an additional iteration.

Finally, at TxAck timer expiration (in non-SLOTTED mode), or at the qualified rollover of the slot timer (in SLOTTED mode), a Tx warmup is initiated. The conclusion of the Tx warmup will coincide precisely with a backoff slot boundary if SLOTTED mode is in effect. The sequence manager will then initiate the transmission of the Ack frame. The entire Ack frame will be built up by hardware; the Packet Buffer is not used for the auto-TxAck feature. The hardware will insert the following parameters into the Ack frame's Frame Control Field:

Table 45-35. Frame Control Field for Hardware-generated Auto-TxAck Frame

| FCF Field | Value |
|---------------------|---|
| FrameType | Acknowledge |
| SecurityEnabled | 0 |
| FramePending | Determined by the Packet Processor. (see Packet Processor Block Guide, Section Source Address Management) |
| AckRequest | 0 |
| PanIDCompression | 0 |
| Reserved (bits 7-9) | 000 |
| DstAddrMode | 0 |
| FrameVersion | 0 |
| SrcAddrMode | 0 |

The Sequence Number for the Ack packet, will be the Sequence Number obtained from the previously received frame.

After the Ack frame has been transmitted, the sequence manager will issue a TXIRQ interrupt, and then perform a Tx warmdown. Finally, a SEQIRQ interrupt will be issued, and the sequence manager returns to SEQ_IDLE state.

Sequence R Timing Diagrams

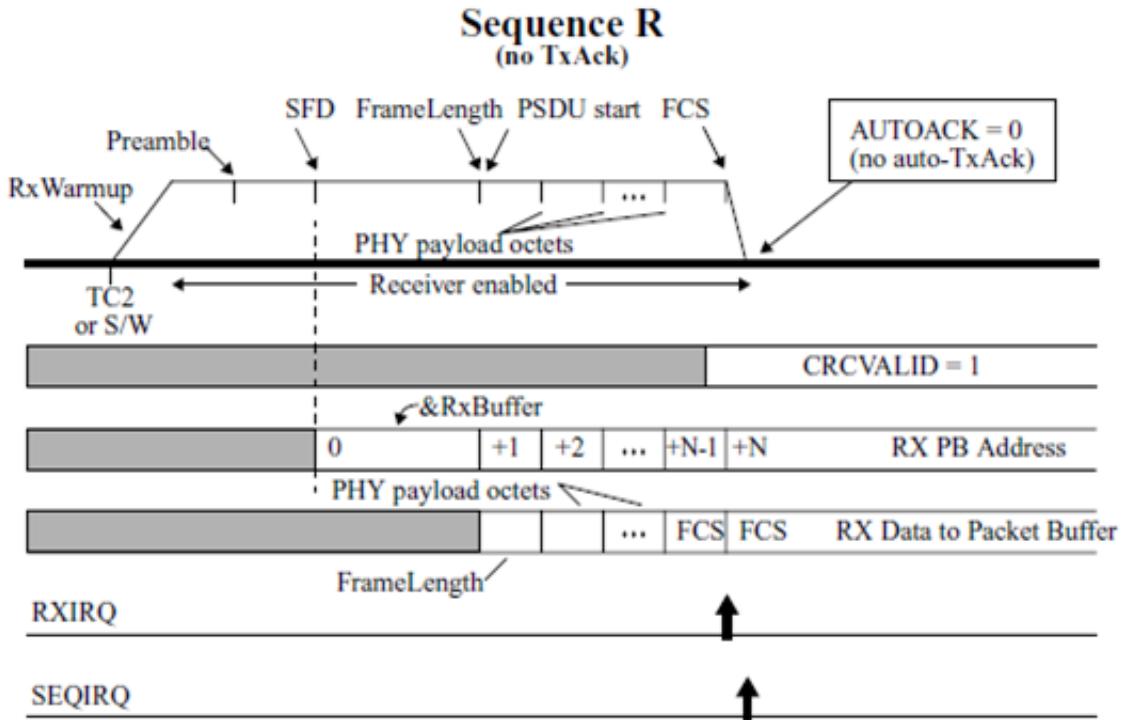

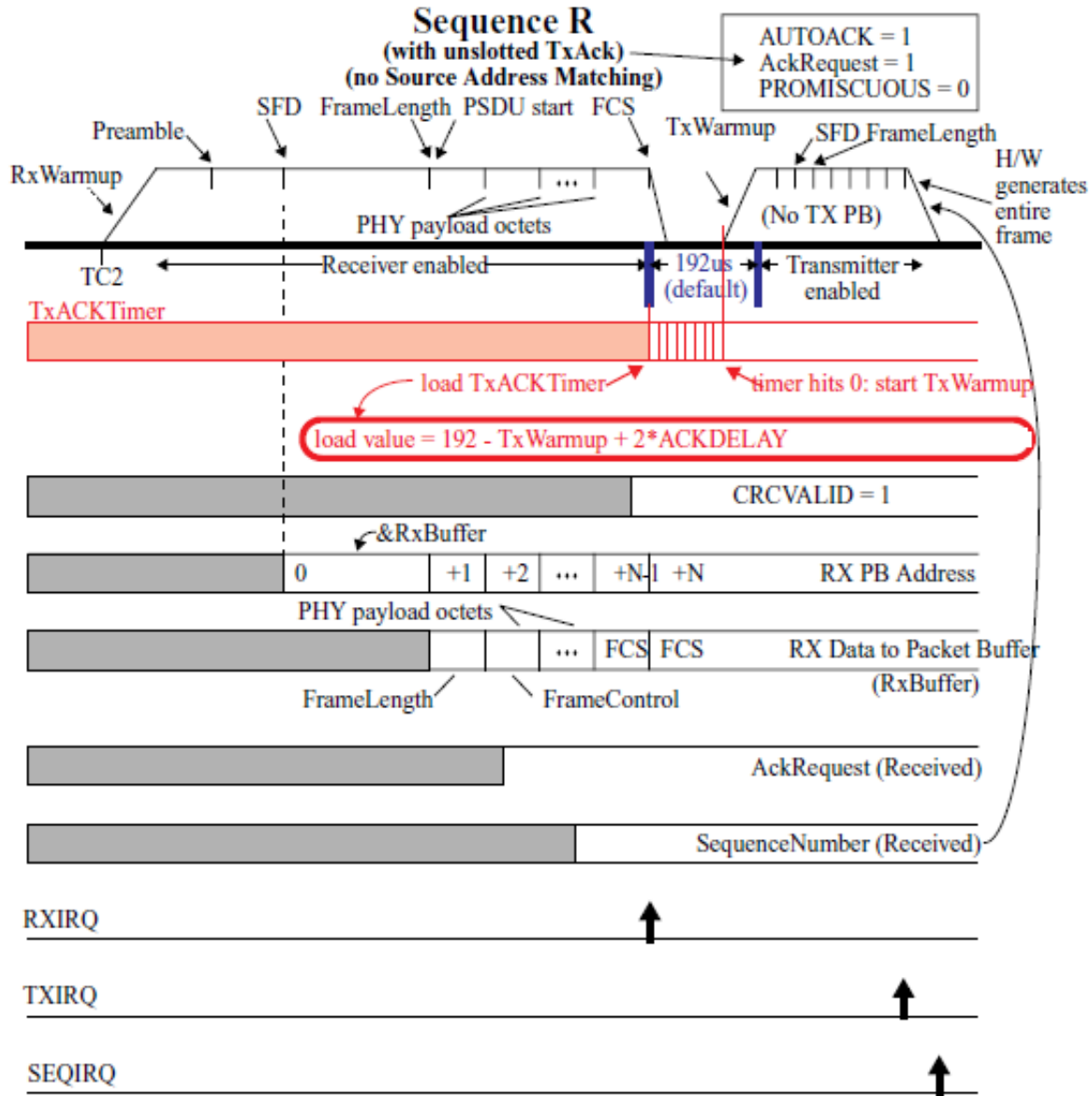

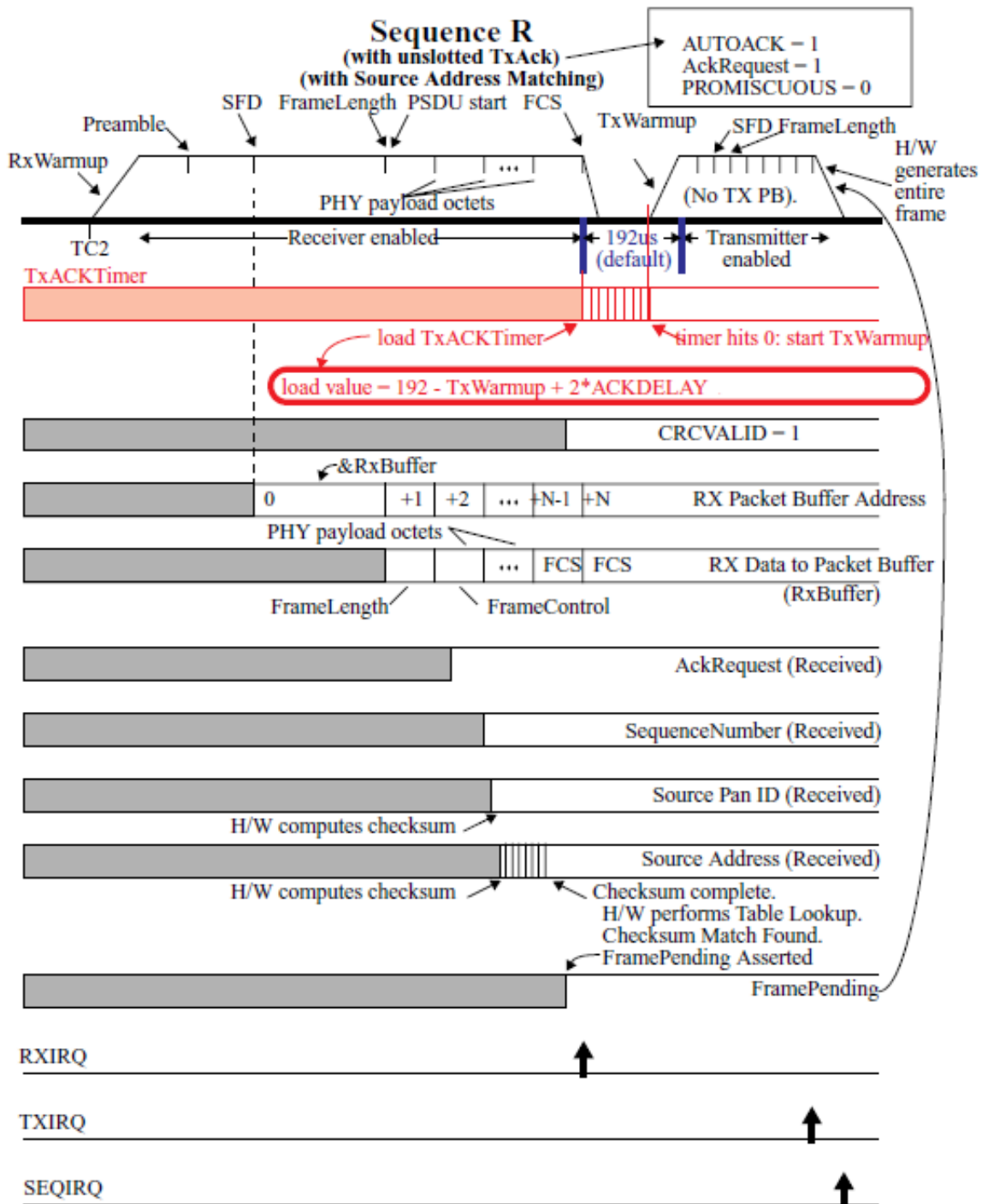

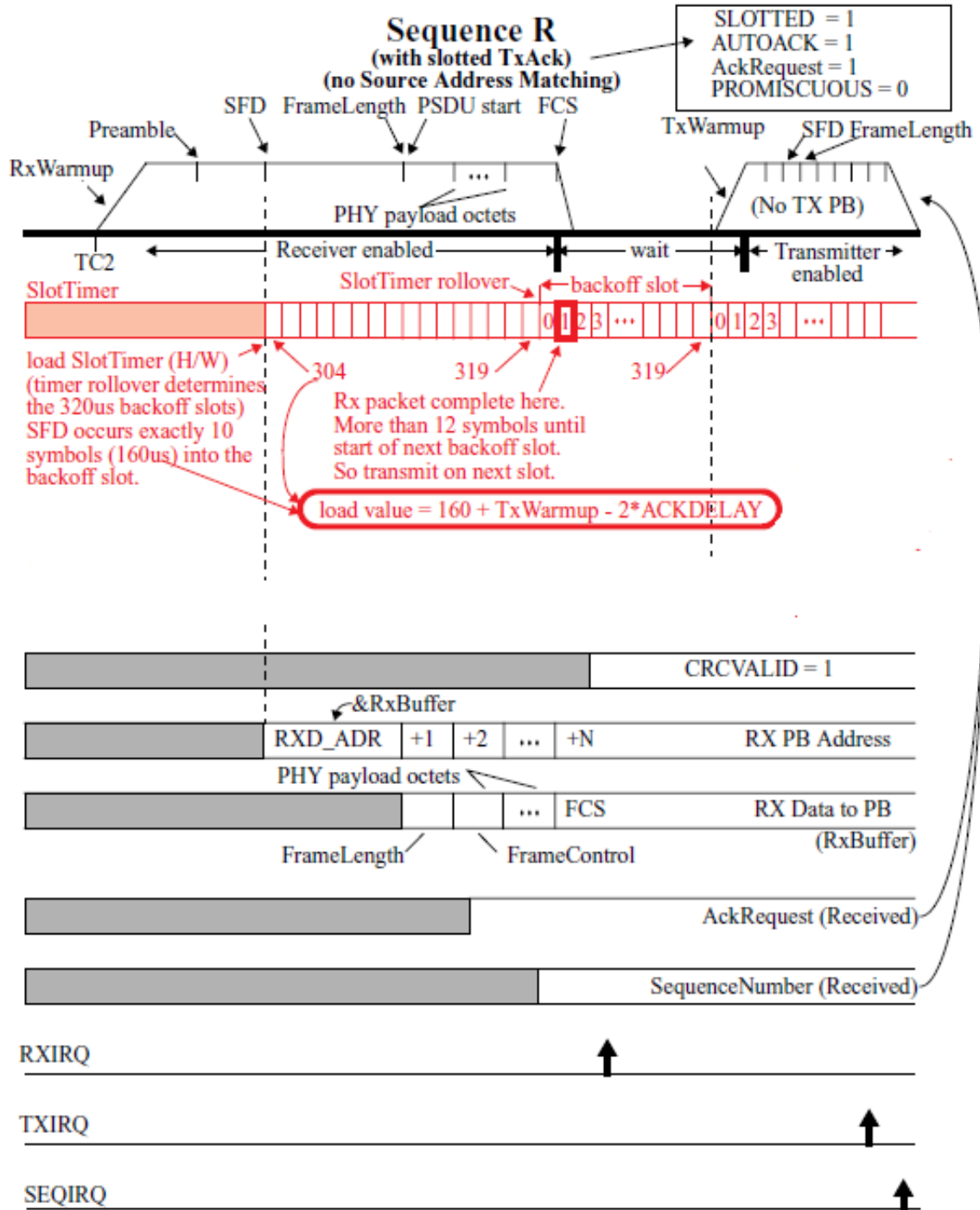

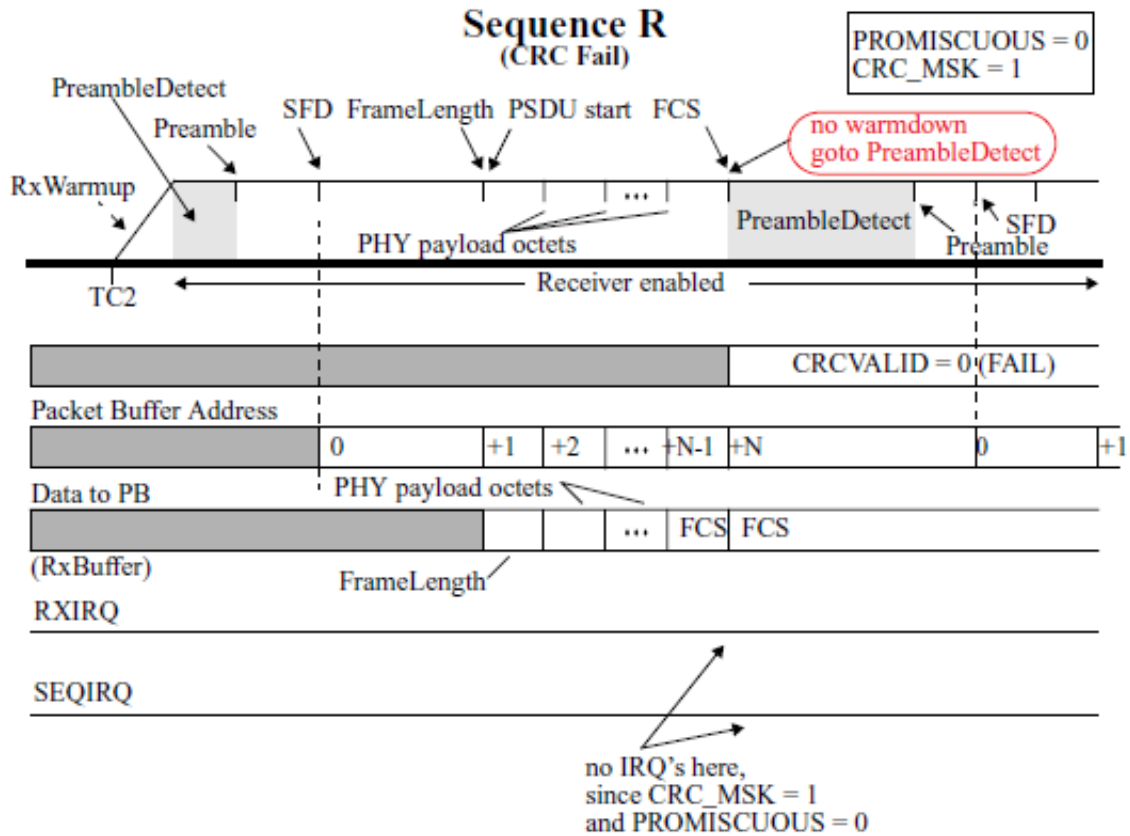

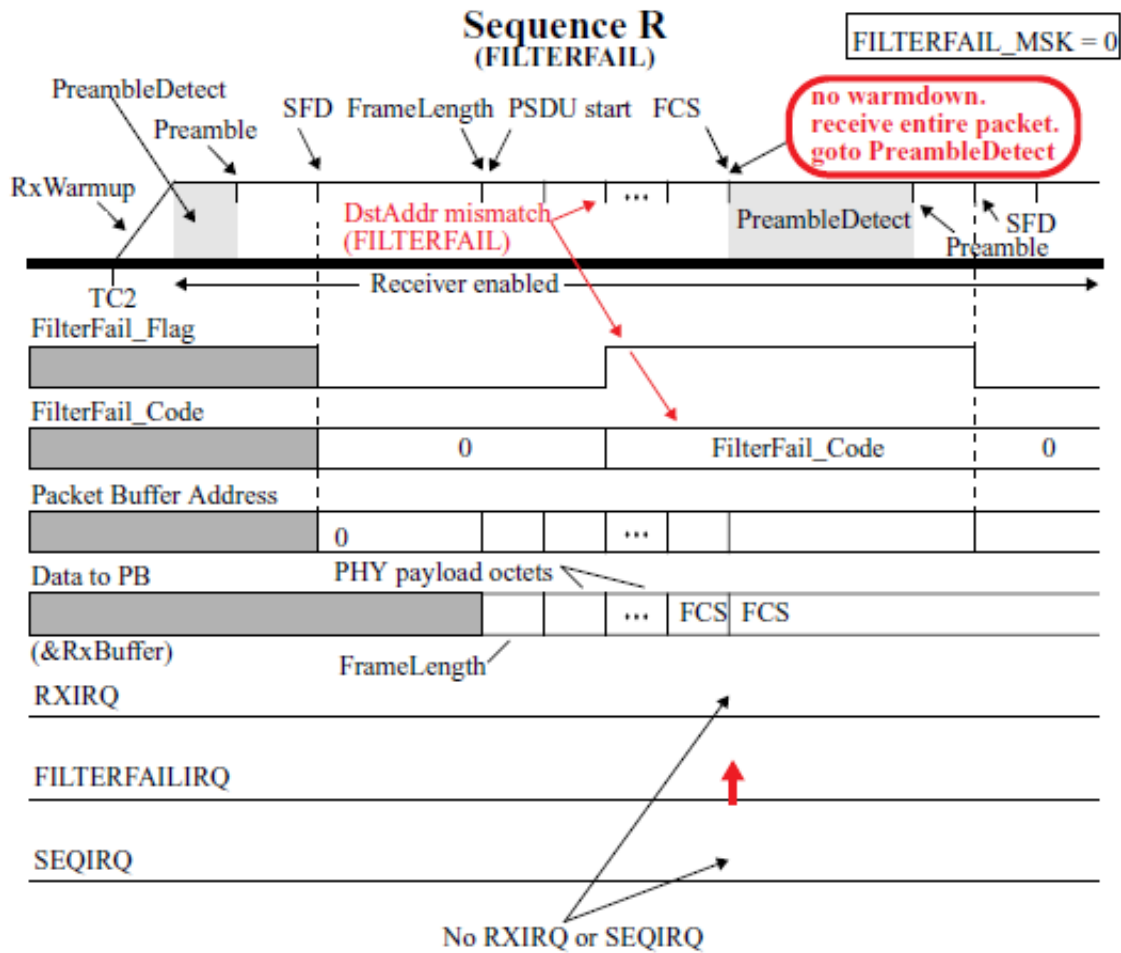

45.6.2.6.3.1.3 Sequence T (Transmit)

Sequence T is the basic, standalone transmit sequence. Sequence T can be used to transmit all types of 802.15.4 PHY- and MAC-compliant frames. However, transmission of Acknowledge frames is not recommended using Sequence T. This is because transmission of an Acknowledge frame, usually follows a received frame, with a designated Sequence Number. The ZSM sequence manager automates the transmission of an Ack frame which follows a received frame, using Sequence R with the AUTOACK bit asserted. This is the recommended method for transmitting an Ack frame. This is especially beneficial, because the transmitted Ack frame octets are generated by hardware, and so no setup of a transmit packet in Packet Buffer, is required. However, sequence manager hardware does not prohibit Ack frames using Sequence T.

Sequence T allows for the insertion of 1 or 2 CCA (clear channel assessment) measurements prior to transmission, to ensure that the selected channel is idle. The CCA-before-TX feature is governed by two register bits, CCABFRTX and SLOTTED. All CCA measurements must indicate channel-idle, in order for the sequence manager to proceed to transmission; if the channel is determined by CCA to be busy, the sequence

manager will terminate the sequence without a transmission. The number of CCA measurements attempted by the sequence manager, and the timing of the measurements, is shown in the following table.

Table 45-36. Timing of CCA Operations for Sequence T

| CCABFRTX | SLOTTED | Number of CCA measurements | Timing of Initiation of CCA measurement #1 | Timing of Initiation of CCA measurement #2 | Timing of First Bit of Transmitted Frame (assumes channel idle) |
|----------|---------|----------------------------|--|--|---|
| 0 | X | 0 | - | - | Immediately follows TxWarmup |
| 1 | 0 | 1 | Immediately follows RxWarmup | - | Immediately follows RxWarmdown and TxWarmup |
| 1 | 1 | 2 | Immediately follows RxWarmup | 320us after Initiation of CCA measurement #1 | 320us after Initiation of CCA measurement #2 |

Any CCA mode can be used for Sequence T and Sequence TR (CCA Modes 1, 2, and 3 are available. See the CCA Block Guide). Software must configure the CCATYPE bits prior to initiating the autosequence, to select the CCA Mode.

The basic execution of a successful Sequence T is as follows:

- MCU writes TC2 compare value to the desired initiation time, and sets TMRTRIGEN (optional)
- MCU sets CCABFRTX if one or more CCA's are required prior to transmit
- MCU sets SLOTTED if in slotted mode (2 CCA's will be attempted)
- MCU writes XCVSEQ=T
- Wait for TC2 match (if TMRTRIGEN=1)
- If CCABFRTX=1 :
 - ---> SEQ_MGR executes RxWarmup
 - ---> SEQ_MGR initiates CCA measurement (takes 128us)
 - ---> if CCA indicates channel busy, sequence terminates, CCAIRQ & SEQIRQ issued
 - ---> otherwise, if CCA indicates channel idle:
 - ---- ---> if SLOTTED=0, SEQ_MGR executes a RxWarmdown, followed by a TxWarmup
 - ---- ---> if SLOTTED=1, SEQ_MGR initiates a 2nd CCA, 320us after initiating 1st CCA.
 - ---- ---> if SLOTTED=1, and channel busy, sequence terminates, CCAIRQ & SEQIRQ issued

- ---- ---> if SLOTTED=1, and channel idle, SEQ_MGR executes a RxWarmdown, followed by a TxWarmup
- if SLOTTED=1, SEQ_MGR waits until 320us elapse after 2nd CCA initiation
- SEQ_MGR executes TxWarmup
- Preamble transmitted
- SFD transmitted
- FrameLength octet is obtained from Packet Buffer Address 0, and transmitted
- CRC engine is reset
- N additional octets are obtained from Packet Buffer and transmitted ($N = \text{FrameLength} - 2$)
- Each octet that is transmitted, is shifted through the CRC engine
- After N th octet transmitted, FCS is available from CRC engine.
- FCS lower octet transmitted
- FCS upper octet transmitted
- SEQ_MGR issues TXIRQ
- SEQ_MGR executes TxWarmdown
- SEQ_MGR issues SEQIRQ

When Sequence T is initiated, the sequence manager first must determine if one or more CCA measurements are required. If CCABFRTX bit is asserted, the sequence manager warms up the receiver (analog and digital elements), via the TSM (Transceiver Sequence Manager). See TSM Block Guide. Immediately after the conclusion of the warmup, a CCA measurement is initiated. The CCA measurement takes 128us. If CCA indicates the channel is busy, the sequence manager warms down the receiver, issues CCAIRQ and SEQIRQ interrupts, and terminates the sequence. If, however, CCA indicates the channel is idle, the sequence manager inspects the SLOTTED bit to determine what to do next. If the SLOTTED bit is clear, the sequence manager issues a CCAIRQ interrupt, and then executes a warmdown of the receiver. If, however, the SLOTTED bit is set, the sequence manager does not issue a CCAIRQ interrupt; instead, the sequence manager initiates a second CCA measurement, precisely 320us after the initiation of the first CCA. This 320us interval is timed by the slot timer, which had been preloaded with 320 (microseconds) at the instant that Rx warmup was complete. At the conclusion of the second CCA, the sequence manager issues a CCAIRQ. If the second CCA indicates the channel is busy, the sequence manager warms down the receiver, issues a SEQIRQ interrupt, and terminates the sequence. If, however, CCA indicates the channel is idle, the sequence manager executes a warmdown of the receiver. Prior to executing the warmdown, the sequence manager reloads the slot timer, in order to precisely schedule the ensuing transmission. This time, the slot timer is loaded with a smaller value, in order to account for the fact that the timer must expire early in order to trigger the Tx warmup, which must complete at precisely the next backoff slot boundary. Thus, this time the slot timer is preloaded with:

Slot Timer Preload = $320 - \text{TXWARMUPTIME} + (2 * \text{TXDELAY})$.

The 320us is the duration of the backoff slot. The TXWARMUPTIME takes into account the fact that the TxAck timer must expire early for the Tx warmup to be complete at exactly the 320us point. The TXDELAY is a signed, fine-tune adjustment to the TxAck transmission time (+/- 62us).

If the SLOTTED bit is asserted, once the slot timer expires, the sequence manager executes a Tx warmup. The conclusion of this warmup coincides with the backoff slot boundary. If the SLOTTED bit is deasserted, the sequence manager does not wait for the slot timer, and instead executes a Tx warmup immediately after the Rx warmdown.

At this point, the sequence manager begins the transmit operation. The preamble and SFD are transmitted first. The preamble and SFD octets are generated by hardware, and are not included in the Packet Buffer. Then, the FrameLength octet is obtained from the Packet Buffer (address 0), and the buffer address pointer is incremented by one. The FrameLength octet is transmitted. The CRC engine is reset at this point. The FrameLength octet is used to determine how many more octets remain in the Packet Buffer. The number of remaining octets is:

Number of octets remaining in Tx buffer = $\text{FrameLength} - 2$

This is because the final 2 octets of the transmit frame constitute the FCS (Frame Check Sequence), and this value is hardware-computed. Thus, FCS is not part of the Tx buffer. Each of the octets in the Tx buffer is transmitted, and simultaneously shifted through CRC, to generate the FCS field. Once the Tx buffer is drained and all of its octets transmitted, the 2 FCS octets are transmitted, starting with the least significant octet. At this point, the transmit operation is complete. The sequence manager issues a TXIRQ interrupt. The sequence manager then executes a complete Tx warmdown, and follows up with a SEQIRQ interrupt. The sequence manager returns to SEQ_IDLE state.

Sequence T Timing Diagrams

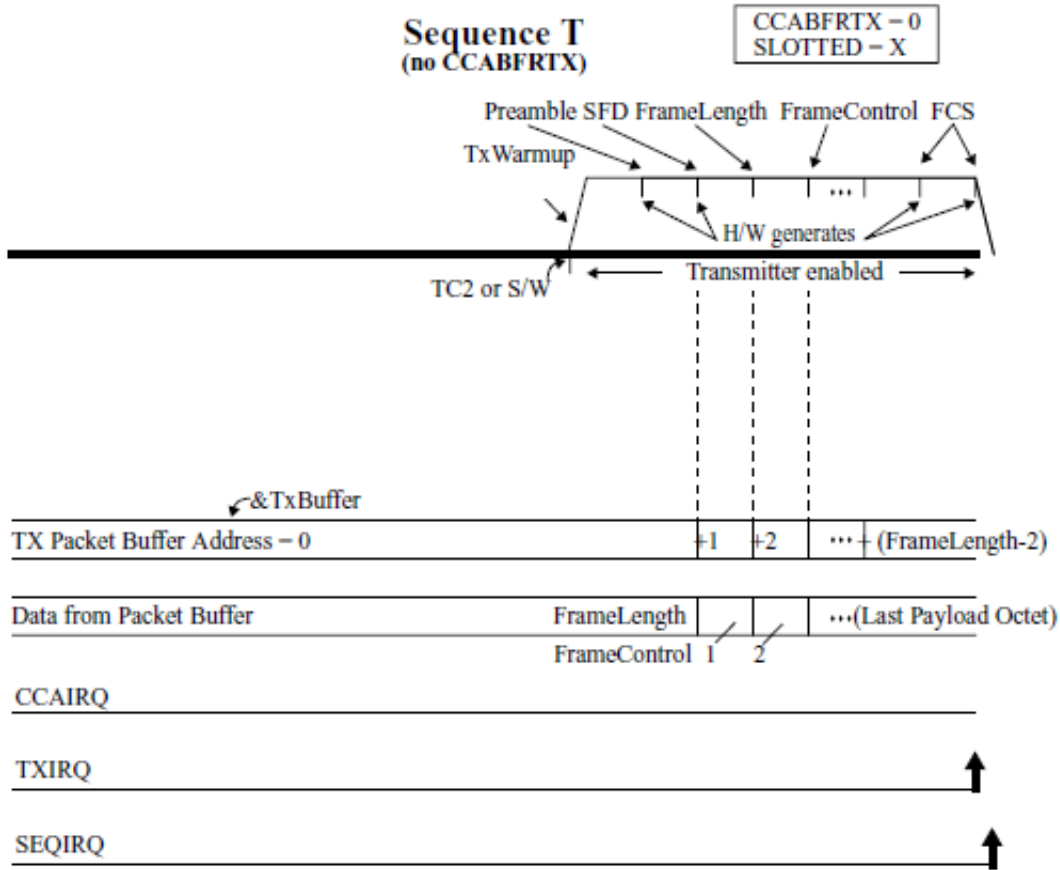

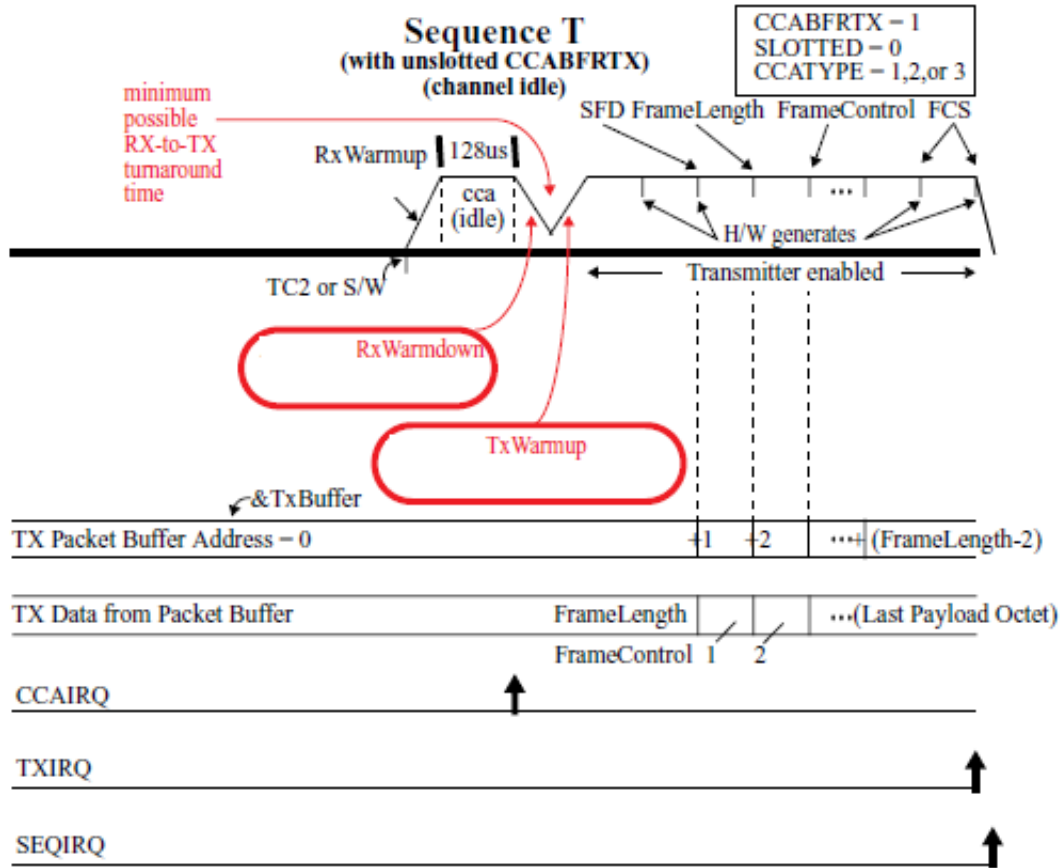

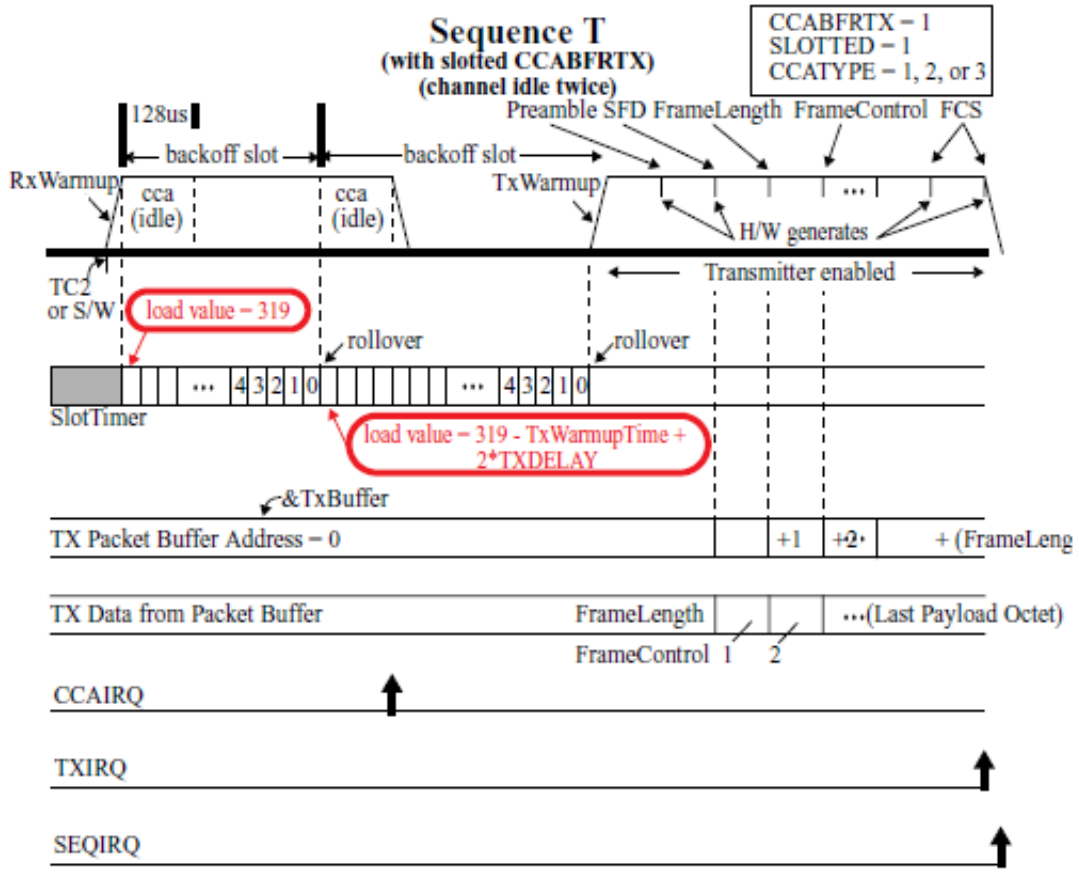

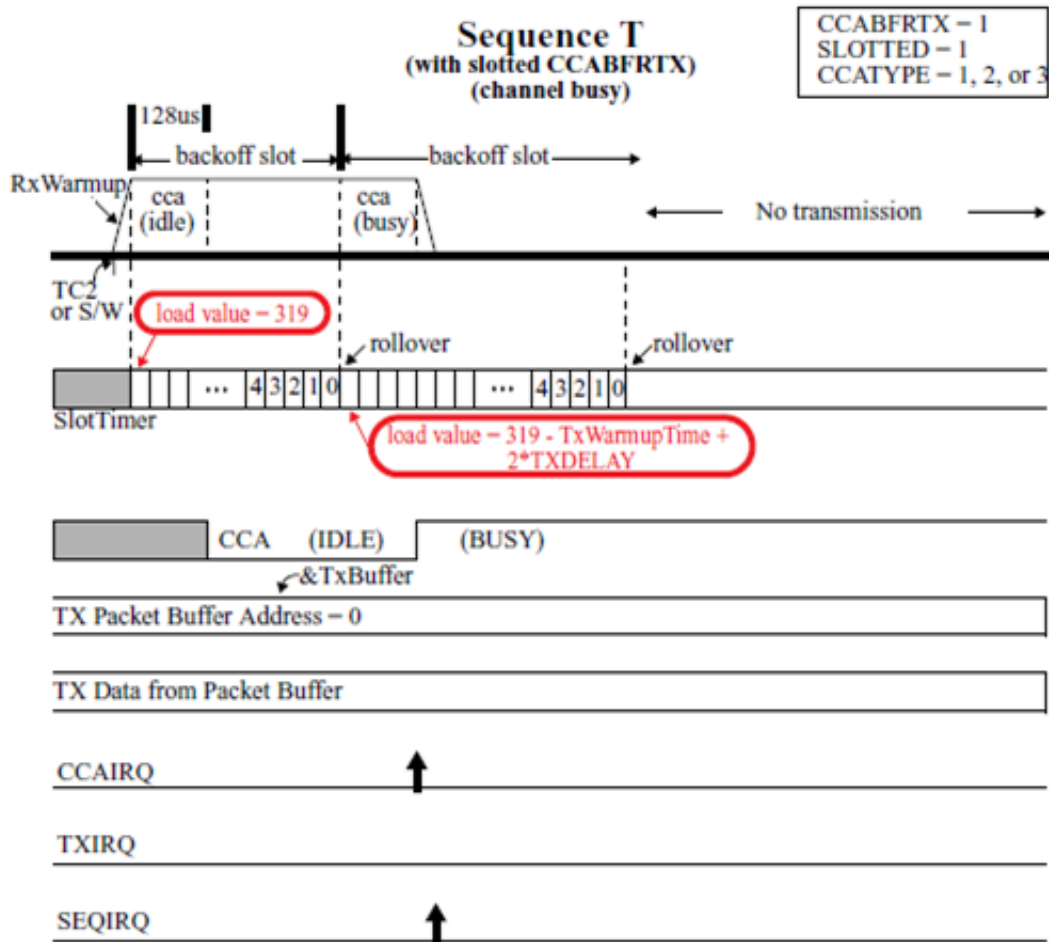

45.6.2.6.3.1.4 Sequence C (CCA)

Sequence C is the standalone CCA sequence. During Sequence C, the sequence manager executes a Clear Channel Assessment (CCA). The result of the CCA measurement is reported back to software in the CCA bit of the IRQSTS2 Register. The CCA bit indicates either a busy channel (1), or an idle channel (0).

The basic execution of a Sequence C is as follows:

- MCU writes TC2 compare value to the desired initiation time, and sets TMRTRIGEN (optional)
- MCU writes XCVSEQ=C
- Wait for TC2 match (if TMRTRIGEN=1)
- SEQ_MGR asserts one of { cca1_en, cca2_en, cca3_en, ed_en } to CCA_DIG
- SEQ_MGR executes RxWarmup, via Transceiver Sequence Manager (see TSM Block Guide)
- SEQ_MGR initiates CCA measurement by asserting rx_cca_en to CCA_DIG

- SEQ_MGR waits for CCA to complete
- CCA bit is set to the CCA status (1=busy 0=idle)
- CCAIRQ interrupt issued
- SEQ_MGR executes RxWarmdown
- SEQIRQ interrupt issued

When Sequence C is initiated, the sequence manager asserts one of 4 control signals to CCA_DIG, based on which CCA or ED mode is programmed into CCATYPE[1:0]. The mapping of CCATYPE[1:0] to control signal is shown in the following table:

| CCATYPE[1:0] | CCA_DIG CONTROL SIGNAL |
|--------------|------------------------|
| 00 | ed_en |
| 01 | cca1_en |
| 10 | cca2_en |
| 11 | cca3_en |

The asserted control signal will remain asserted for the duration of the Sequence C. The sequence manager warms up the receiver (analog and digital elements), via the Transceiver Sequence Manager (TSM). The TC3 “bracketing” timer has no effect on the sequence manager during Sequence C, so it cannot abort the sequence. At the completion of the warmup, the sequence manager initiates the CCA by asserting the **rx_cca_en** signal to CCA_DIG. While CCA is enabled, the CCA_DIG measures and averages the energy or signal on the channel. At the completion of the CCA process, the CCA bit is set to the status of the channel (idle or busy). The CCAIRQ is issued, the receiver is warmed down, the SEQIRQ is issued, and the sequence manager returns to SEQ_IDLE state.

Any CCATYPE setting may be used for Sequence C.

Sequence C Timing Diagrams

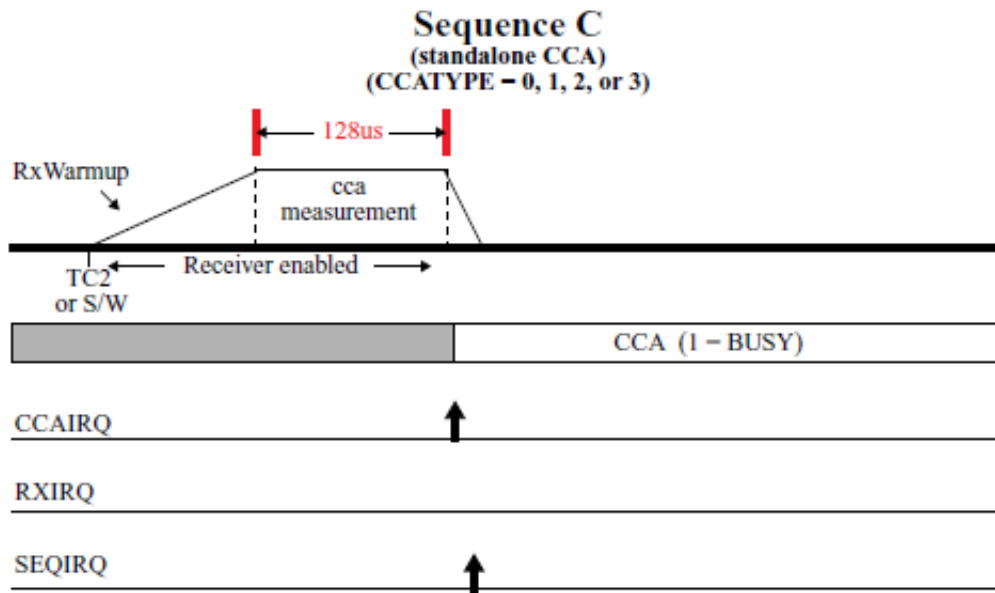

45.6.2.6.3.1.5 Sequence TR (Transmit/Receive)

Sequence TR is a combination Transmit/Receive sequence. The sequence is executed as a concatenation of 1 transmit operation followed by 1 receive operation, with a minimum TX-to-RX turnaround time in between. There are 2 permutations of Sequence TR, depending on the RXACKRQD bit. For both permutations, the Sequence T which constitutes the first half of a Sequence TR, is identical to the standalone Sequence T (XCVSEQ=2). This means that the transmit operation can be slotted or unslotted, and can be preceded by 1 or 2 CCA measurements, depending on the state of the CCABFRTX and SLOTTED bits.

If RXACKRQD=0, then Sequence TR is executed as a Sequence T followed by a Sequence R, with a minimum TX-to-RX turnaround time in between. The Sequence R, which constitutes the second half of the Sequence TR, is identical to the standalone Sequence R (XCVSEQ=1). This means that the receive operation can be followed by an automatic, hardware-generated transmit Acknowledge frame, if all the necessary conditions are met. As with basic Sequence R, data for a successful receive operation is always transferred to Packet Buffer.

If RXACKRQD=1, then Sequence TR is executed as a Sequence T followed by a Receive-Acknowledge-Only frame. This type of receive operation is special, and not the same as a standalone Sequence R. The Ack-only receive operation filters all incoming frames, looking only for an Acknowledge frame whose Sequence Number matches the Sequence Number which was transmitted in the Sequence T portion of the sequence. All

non-matching frames are discarded, and after each non-matching frame, the sequence manager will return the receiver to preamble-detect mode. This receive operation will continue until the matching Ack frame is received. Since this is a Receive-Acknowledge-Only operation, and not a Sequence R, there will be no receive octets transferred to Packet Buffer (an exception is made if `ACTIVE_PROMISCUOUS=1`; if so, all receive octets are transferred to the Packet Buffer, even for the Receive-Acknowledge-Only frame). The sequence will end with a `RXIRQ` interrupt, which indicates that the matching Ack frame was successfully received.

Needless to say, if during the transmit operation of a Sequence TR, an Acknowledge frame is being requested of the receiving end device (Frame Control Field: `AckRequest=1`), then Sequence TR with `RXACKRQD=1` is the appropriate procedure. (Using Sequence TR with `RXACKREQ=0` is *not* recommended for this scenario, since there is no Sequence Number matching.)

Conversely, if during the transmit operation of a Sequence TR, an Acknowledge frame is *not* being requested of the receiving end device (Frame Control Field: `AckRequest=0`), then Sequence TR with `RXACKRQD=1` should *never* be used, since a receive acknowledge frame will not be forthcoming. Instead, use Sequence TR with `RXACKRQD=0`, or simply Sequence T, if no followup receive frame is expected.

Sequence TR Timing Diagrams

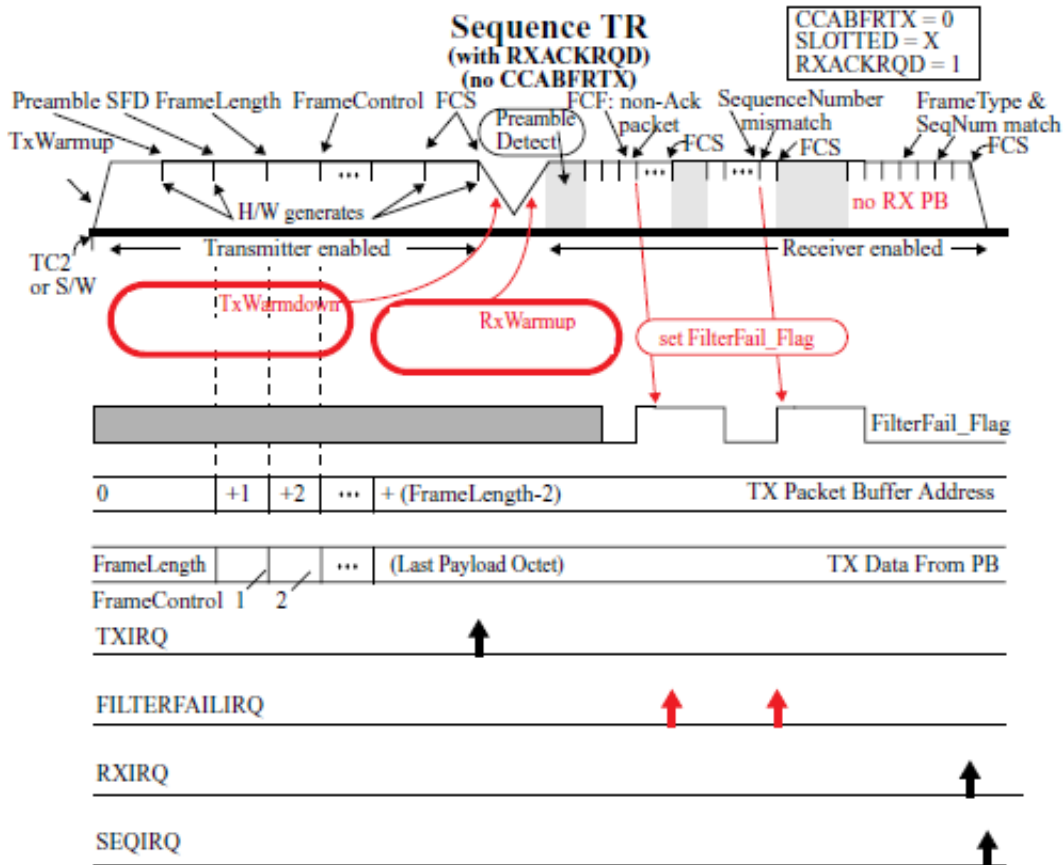

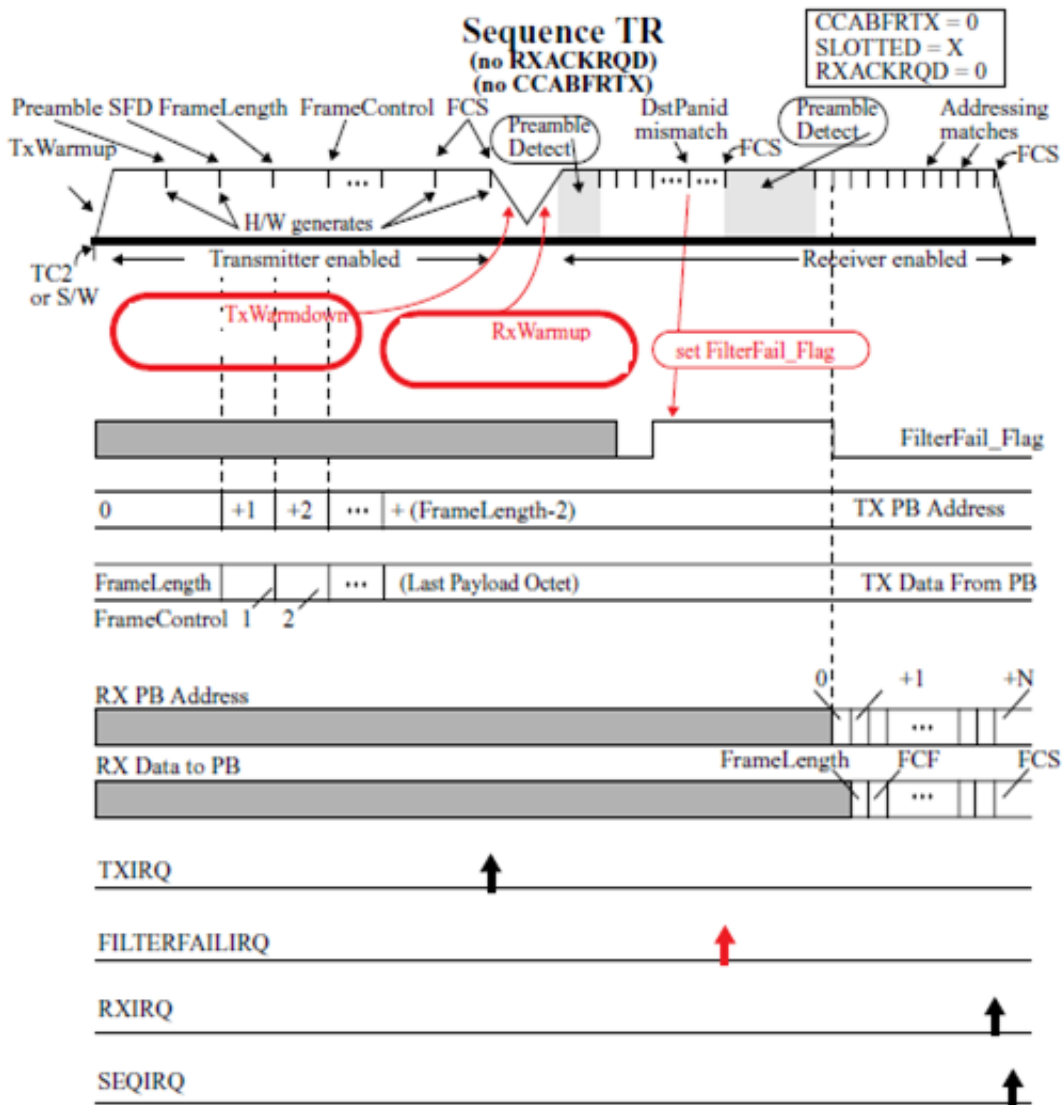

45.6.2.6.3.1.6 Sequence CCCA (Continuous CCA)

Sequence CCCA is the Continuous CCA sequence. This sequence is designed to accommodate situations where channel availability may be infrequent, or low-duty-cycle, and a device needs to be able to transmit at the earliest available opportunity. During Sequence CCCA, the sequence manager repeats CCA measurements continuously until a channel-idle condition is found. The interval between the end of one CCA measurement, and the start of the next, is 63 μ s. The actual interval between consecutive CCA measurements (i.e., from measurement-start to measurement-start), in the CCCA sequence, is 193 μ s. After each CCA iteration, the CCA bit (IRQSTS2 Register) is set to the result of the measurement. As long as the CCA bit is high (busy) at the end of the iteration, the sequence manager will initiate a new measurement. Unlike Sequence C (standalone CCA), there is no CCAIRQ interrupt generated at the end of each CCA

measurement, until the channel-idle condition is detected, at which point CCAIRQ is issued. The SLOTTED bit has no effect on this sequence. A Sequence CCCA will be aborted by the ZSM Sequence Manager if a TMR3 match occurs, and TC3TMOUT=1. CCA Modes 1, 2, or 3, can be used for Continuous CCA.

The basic execution of a Sequence CCCA is as follows:

- MCU writes TC2 compare value to the desired initiation time, and sets TMRTRIGEN (optional)
- MCU writes XCVSEQ=CCCA
- Wait for TC2 match (if TMRTRIGEN=1)
- SEQ_MGR asserts one of { **cca1_en**, **cca2_en**, **cca3_en** } to CCA_DIG
- SEQ_MGR executes RxWarmup
- SEQ_MGR initiates CCA measurement by asserting **rx_cca_en** to CCA_DIG
- SEQ_MGR waits for CCA to complete
- CCA bit is set to the CCA status (1=busy 0=idle)
- If CCA=1, initiate a new CCA measurement immediately and repeat the previous 4 steps
- If CCA=0, CCAIRQ is issued
- SEQ_MGR executes RxWarmdown
- SEQIRQ interrupt issued

Note: The CCA bit (IRQSTS2 register) may change dynamically during the CCA measurement, and are only considered valid (and sampled by the Sequence Manager), at the end of the CCA measurement; therefore the user should not continuously poll CCA during CCCA and be expecting continuously-valid results

Note: The user can continuously monitor progress of the Sequence CCCA by reading the CCCA_BUSY_CNT register.

Sequence CCCA Timing Diagrams

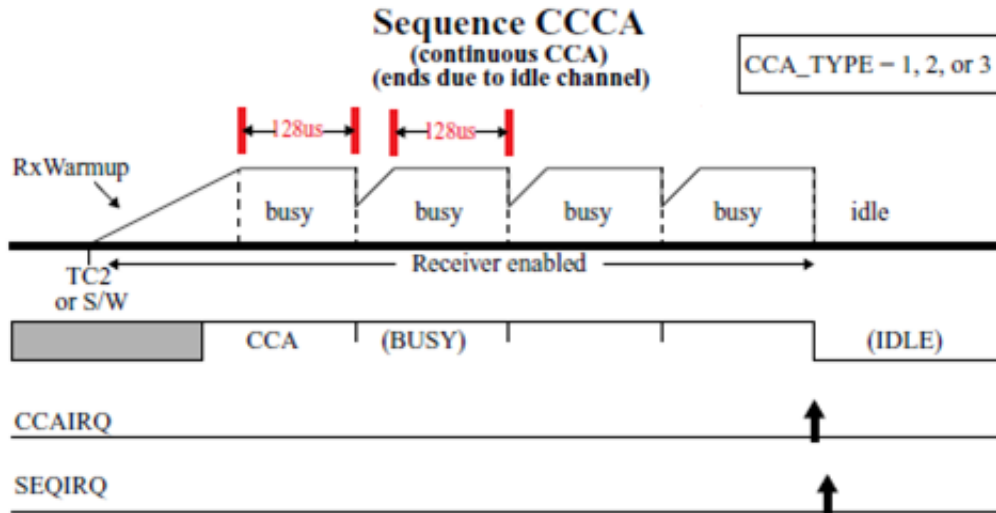

45.6.2.6.3.2 SM/TSM Interaction

The 802.15.4 Sequence Manager (ZSM) controls high-level autosequence timing, but offloads low level warmup and warmdown tasks to a dedicated, protocol-neutral Transceiver Sequence Manager, or TSM (see TSM Block Guide). The ZSM initiates high-level functions, such as a CCA measurement operation or a transmit acknowledge operation, by commanding the TSM to execute an RX warmup, a TX warmup, a RX warmdown, a TX warmdown, or an RX recycle. Based on these commands, TSM generates the precise timing to control all of the digital, analog, and RF components of the TX and RX chains. The TSM is fully programmable, allowing all of the enabling and control signals to the transceiver components to be independently scheduled with 1µs precision. TSM also allows all enable and control signals to be optionally overridden at any time, giving software complete control of each transceiver block, and ultimately the entire warmup/warmdown process if desired.

The ZSM and TSM sequence managers operate on the same clock domain, and both have 1µs resolution. The TSM is fully programmable, while the ZSM is largely hardwired, with a few key exceptions. In the ZSM/TSM relationship, ZSM is the master and TSM is the slave. The key ZSM/TSM interface signaling is shown below:

ZSM/TSM INTERFACE SIGNALS

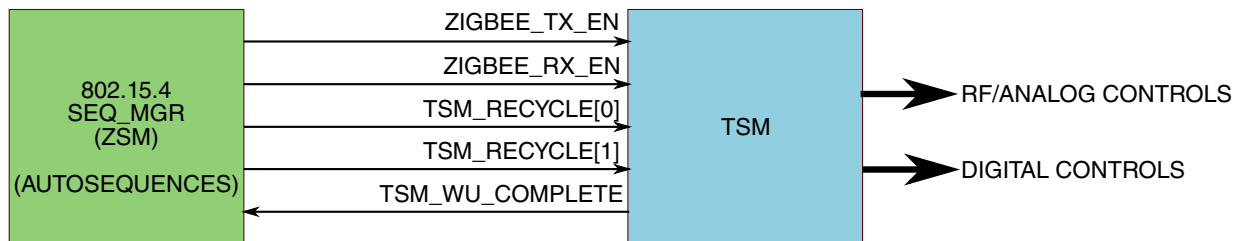

A description of the interface signals is provided in the table below.

| SM/TSM INTERFACE SIGNAL | DESCRIPTION |
|-------------------------|--|
| ZIGBEE_TX_EN | A low-to-high transition initiates a TSM TX warmup, starting 1us after the transition. A high-to-low transition initiates a TSM TX warmdown, starting 1us after the transition. |
| ZIGBEE_RX_EN | A low-to-high transition initiates a TSM RX warmup, starting 1us after the transition. A high-to-low transition initiates a TSM RX warmdown, starting 1us after the transition. |
| TSM_RECYCLE[0] | This signal asserts in the ZSM RX_CYC state, and causes the TSM to jump from its "ON" phase, back to a point in the TSM RX warmup determined by the TSM's RECYCLE_COUNT0[7:0] register in XCVR space. This process is used to execute an RX recycle. This signal is also asserted in the ZSM RX_CCCA state, with the same response by the TSM. This process is used to re-initialize the CCA function during Continuous CCA (CCCA) operations. |
| TSM_RECYCLE[1] | This signal asserts in the ZSM RX_PAN1 state, and causes the TSM to jump from its "ON" phase, back to a point in the TSM RX warmup determined by the TSM's RECYCLE_COUNT1[7:0] register in XCVR space. This process is used to re-initialize the PLL digital on a new RF channel, during a Dual PAN mode on-the-fly channel change. |
| TSM_WU_COMPLETE | For the ZSM states which assert ZIGBEE_TX_EN or ZIGBEE_RX_EN, this 1us-wide signal from the TSM indicates that the warmup is complete, and the ZSM is now free to advance to its next state. The TSM_WU_COMPLETE is asserted 1us before the actual end of sequence, which is determined by the END_OF_TX_WU[7:0] register for TX warmup, and the END_OF_RX_WARMUP[7:0] register for RX warmup. |

45.6.2.6.3.3 ZSM State Diagram

A ZSM state diagram is shown below. The states in yellow, are ZSM states which require interaction with the TSM. For example, a TSM control signal is asserted or deasserted, and/or a wait for warmup-complete from TSM is required; the assertions of the TSM control signals are shown in red. The states in blue have no interaction with TSM, so the timing of these states, and the transitions between such states, are governed by the ZSM itself.

802.15.4 SEQUENCE MANAGER AND TSM INTERACTION

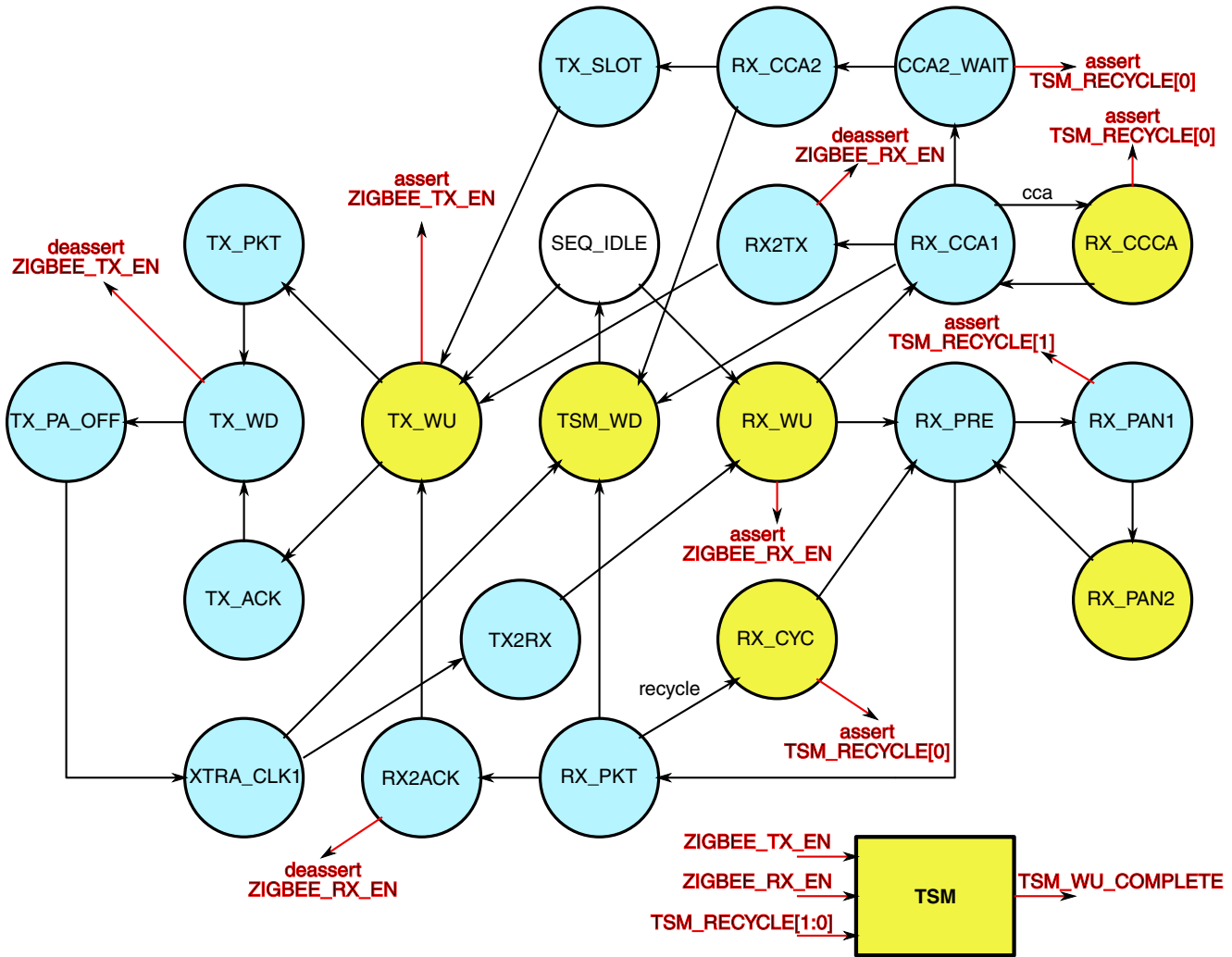

Each ZSM state is represented in the hardware by a 5-bit state vector. The ZSM state can be monitored at any time by way of the read-only SEQ_STATE[4:0] register in 802.15.4 space. The mapping of ZSM state names to state vectors is shown in the table below:

| ZSM STATE | VECTOR |
|-----------|--------|
| SEQ_IDLE | 0x00 |
| RX_WU | 0x10 |
| RX_PRE | 0x14 |
| RX_PKT | 0x15 |
| RX2ACK | 0x16 |
| RX_CYC | 0x17 |
| RX_PAN1 | 0x1D |
| RX_PAN2 | 0x1E |
| RX_CCA1 | 0x18 |
| CCA2_WAIT | 0x19 |

Table continues on the next page...

Link Layer

| ZSM STATE | VECTOR |
|-----------|--------|
| RX_CCA2 | 0x1A |
| RX_CCCA | 0x1C |
| RX2TX | 0x1B |
| TX_WU | 0x01 |
| TX_PKT | 0x05 |
| TX_ACK | 0x06 |
| TX_SLOT | 0x07 |
| TX_WD | 0x08 |
| TX_PA_OFF | 0x09 |
| XTRA_CLK1 | 0x0A |
| TX2RX | 0x0B |
| TSM_WD | 0x1F |

45.6.2.6.3.4 ZSM Warmup Timing

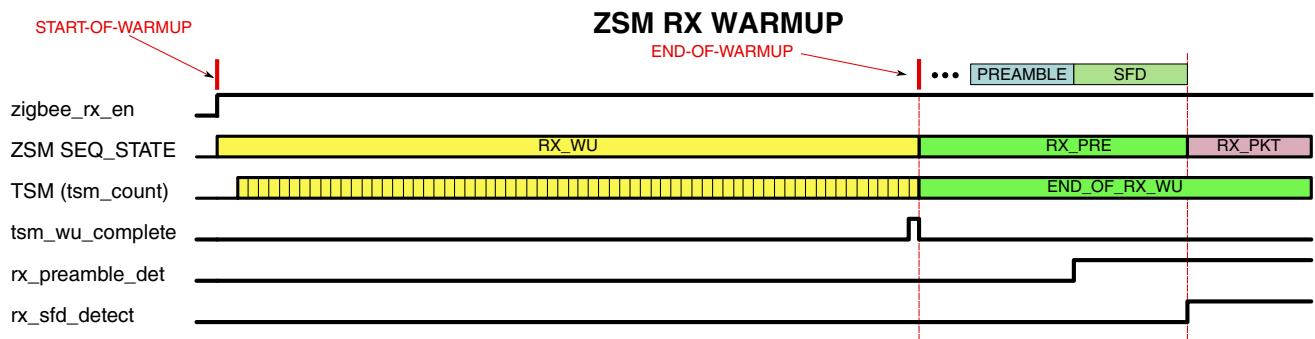
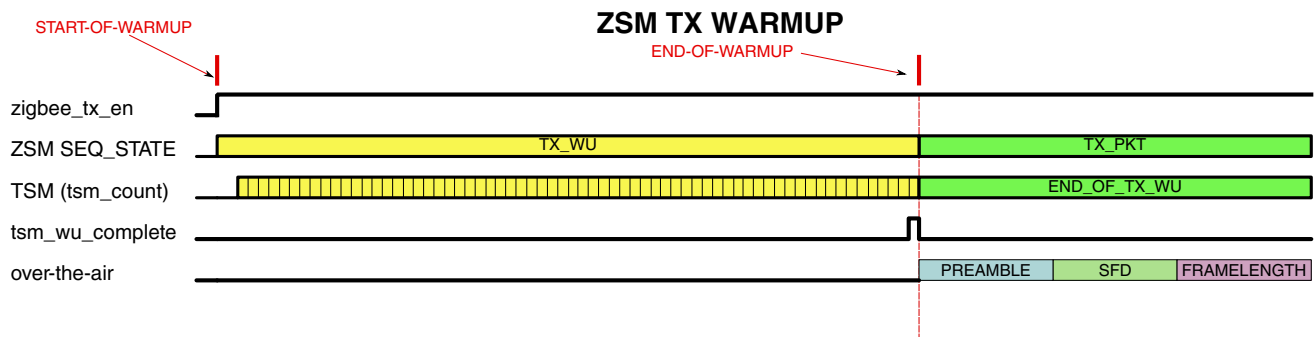

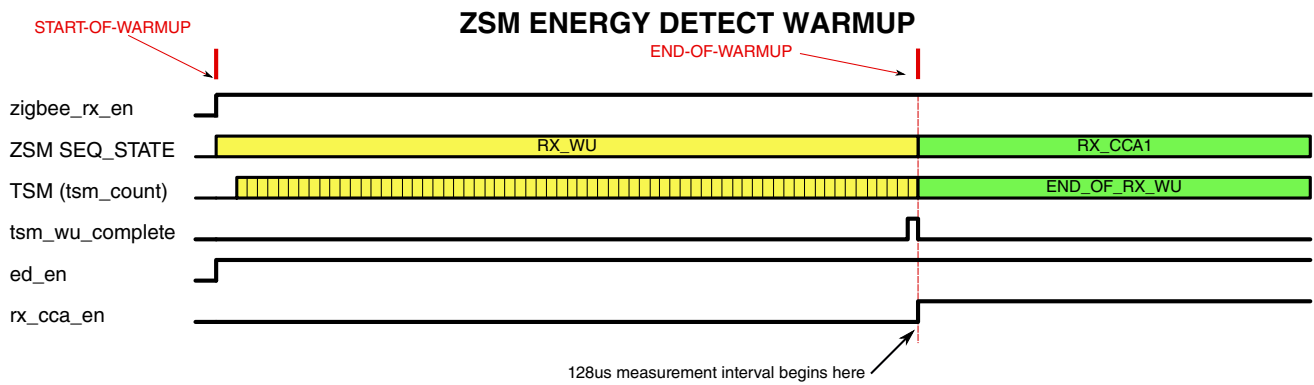
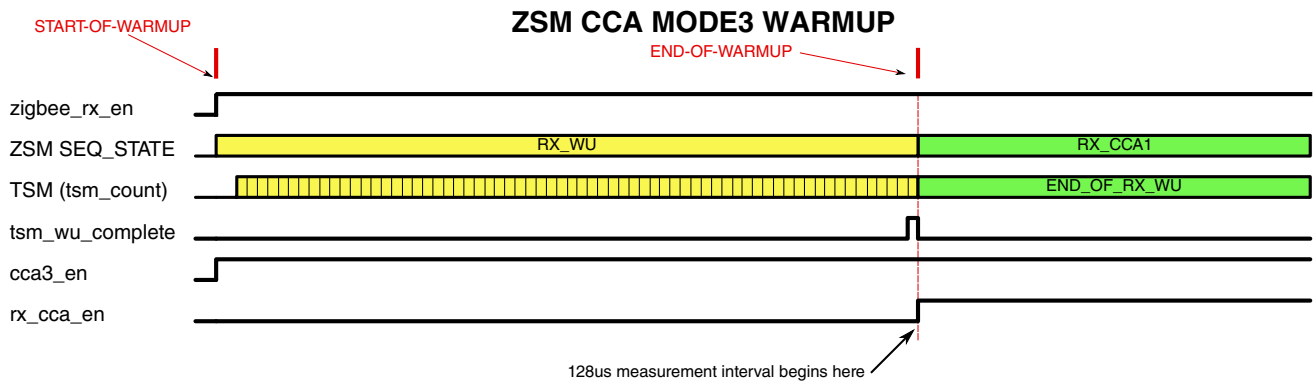
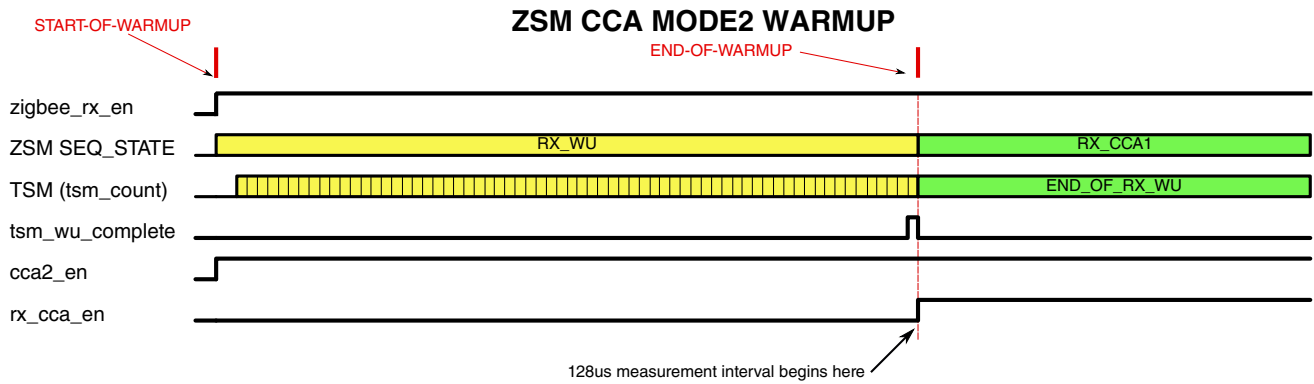
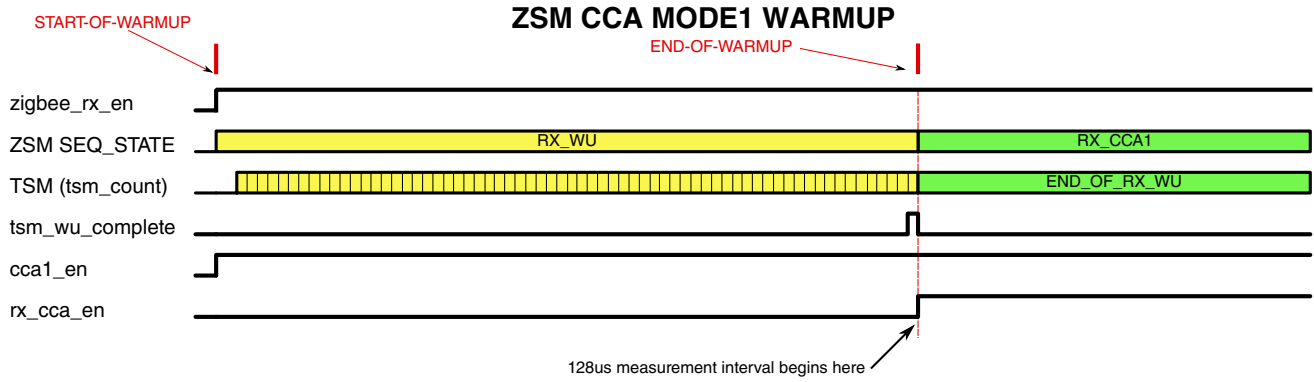

45.6.2.6.3.5 Dual PAN Mode

Dual PAN On-the-fly Channel Change

The 802.15.4 Sequence Manager supports Dual PAN mode, which allows the device to reside on 2 networks simultaneously, switching back and forth between the 2 networks under software, or hardware control. (See the Packet Processor Block Guide for more details on Dual PAN mode).

In Automatic Dual PAN Mode, the device must switch from one network to another under hardware control, at a software-programmed rate. Since the 2 networks often occupy different channels (frequencies), the sequence manager supports an “on-the-fly channel change”, whereby, during a Sequence R, in preamble-search state (RX_PRE), the sequence manager will request the TSM to toggle **pll_dig_en** and switch to a new RF channel, wait out a PLL settling time, and then resume preamble search on the new channel. The entire on-the-fly channel change consumes 93us (based on default TSM programming), and consumes 2 ZSM states. The first state (RX_PAN1) issues **tsm_recycle[1]** to the TSM, which causes TSM to jump from its “ON” phase, back to the **tsm_count** value which is programmed into the RECYCLE_COUNT1[7:0] register in XCVR space. Based on the default programming for RECYCLE1_COUNT, along with the default programming for the TSM timing registers, this TSM recycle will cause the TSM to jump back to the point 1us before **pll_dig_en** is asserted, resulting in a 1us-long deassertion of **pll_dig_en**. The TSM will resume counting from that point, which will re-assert **pll_dig_en**, and the ZSM will simultaneously select the alternate Dual Pan channel. Meanwhile, the ZSM will advance to RX_PAN2 state and wait there pending **tsm_wu_complete** from the TSM. The TSM will resume counting until it once again until it reaches END_OF_RX_WU[7:0], and then will return to its ON phase. At the end of the TSM RX warmup, TSM will issue **tsm_wu_complete** to ZSM, which will return ZSM to RX_PRE (preamble search) state.

Normally, during RX sequences, the PLL is monitored for unlock conditions, and if such an unlock were to occur, the ZSM would abort the RX sequence by deasserting ZIGBEE_RX_EN to TSM. During RX_PAN1 and RX_PAN2 states, ZSM asserts **in_pan_switch** to the transceiver, which indicates that PLL unlock detection should be temporarily suspended while the channel change and subsequent PLL re-lock takes place. Once the ZSM transitions from RX_PAN2 state back to RX_PRE, ZSM will deassert **in_pan_switch** to resume PLL unlock monitoring.

As mentioned, the entire on-the-fly channel change consumes 93us, based on default TSM programming. This 93us represents a short “blind spot” during which preamble detection can’t occur, while the device switches from one RF frequency to another. See diagram below.

ZSM DUAL PAN ON-THE-FLY CHANNEL CHANGE

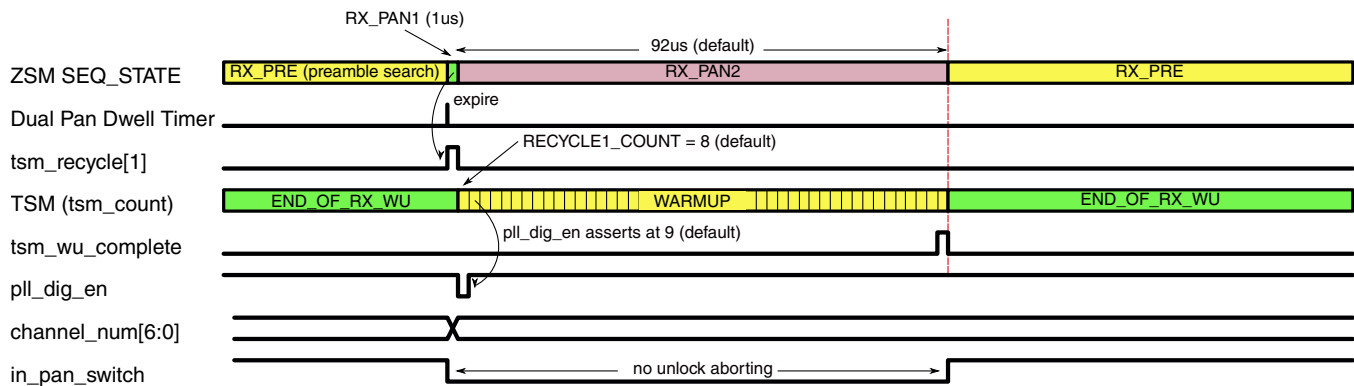

Dual PAN Channel Override

When using Dual PAN mode, the channels are assigned to the 2 PAN's by programming the CHANNEL_NUM0[6:0] and CHANNEL_NUM1[6:0] registers in 802.15.4 space. This method allows a channel number, from 11 to 26, to be programmed into each register, and the channel number is processed downstream into the necessary Integer, Numerator, and Denominator components, required to generate the correct RF frequencies (see PLL Digital Block Guide).

In Dual PAN mode, in case there is a need to generate a frequency which may be offset from the 16 prescribed 5MHz-spaced channels, to, for example, avoid interference on one of the Dual PAN channels, a method has been provided to do that, by designating one of the two PAN channels to use the transceiver's set of direct frequency-programming registers, instead of CHANNEL_NUMx. Programming the direct frequency-programming registers – integer, numerator, and denominator, allows an RF frequency to be selected with much more precision than the 5MHz granularity of the 802.15.4 mapped-channel registers, CHANNEL_NUM0 and CHANNEL_NUM1.

Two bits have been provided in 802.15.4 space to realize this feature: ZB_DP_CHAN_OVRD_SEL and ZB_DP_CHAN_OVRD_EN. When ZB_DP_CHAN_OVRD_EN=1, this enables one of the Dual PAN channels to use the direct frequency programming. The ZB_DP_CHAN_OVRD_SEL bit determines *which* channel uses the direct programming, according to the following table:

| ZB_DP_CHAN_OVRD_EN | ZB_DP_CHAN_OVRD_SEL | PAN0 Frequency Determined by ... | PAN1 Frequency Determined by ... |
|--------------------|---------------------|----------------------------------|----------------------------------|
| 0 | X | CHANNEL_NUM0[6:0] | CHANNEL_NUM1[6:0] |
| 1 | 0 | DIRECT FREQUENCY PROGRAMMING | CHANNEL_NUM1[6:0] |
| 1 | 1 | CHANNEL_NUM0[6:0] | DIRECT FREQUENCY PROGRAMMING |

Direct Frequency Programming is accomplished by setting the PLL's Integer, Numerator, and Denominator registers to the appropriate values for the desired RF frequency. These registers are in XCVR address space, and are shown in the following table:

| DIRECT FREQUENCY PROGRAMMING PARAMETER | REGISTER NAME (XCVR SPACE) | REGISTER MNEMONIC |
|--|----------------------------|-------------------|
| Integer | LPM_INTG[6:0] | PLL_LP_SDM_CTRL1 |
| Numerator | LPM_NUM[27:0] | PLL_LP_SDM_CTRL2 |
| Denominator | LPM_DENOM[27:0] | PLL_LP_SDM_CTRL3 |

See the PLL Digital Block Guide for RF frequency programming details.

In Dual PAN automatic mode, if ZB_DP_CHAN_OVRD_EN=1, when the hardware switches to the PAN selected by ZB_DP_CHAN_OVRD_SEL as a direct-programming channel, the CHANNEL_NUMx[6:0] register is ignored and the directly programmed frequency is used instead; when the hardware switches back to the other channel, the CHANNEL_NUMx[6:0] register is used once again.

45.6.2.6.3.6 Sequence Aborting

All 802.15.4 sequences can be aborted by a PLL unlock detection. The unlock detection is qualified by the ZSM sequence manager; in other words, an unlock condition during the early stages of the PLL warmup is expected, and is not allowed to abort the sequence at that point. The primary rationale for the PLL unlock abort is to prevent transmission on an incorrect, or unstable, frequency during a transmit operation, or to increase battery life by not prolonging a receive or CCA operation that is bound to fail. Software can disable the PLL unlock auto-abort.

When a PLL unlock event occurs during a 802.15.4 autosequence, the TSM's abort facilities are not used, to allow the ZSM to handle the unlock condition directly, as shown in the following diagram:

802.15.4 PLL UNLOCK HANDLING

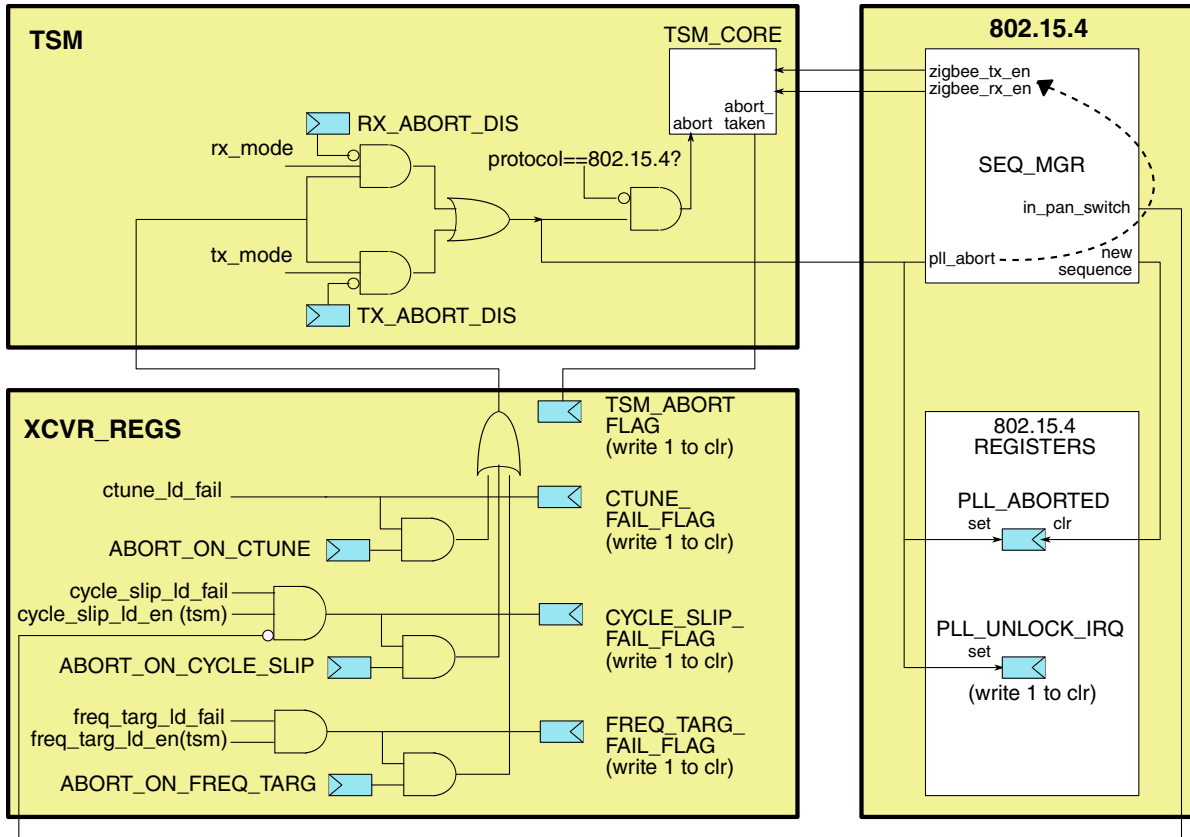

The combined-abort signal is blocked from reaching the TSM, and instead is routed to the 802.15.4 Sequence Manager (ZSM). This is due to the fact that the ZSM already includes abort-handling logic, which is being re-used from previous NXP 802.15.4 products. Keeping the unlock handling intact, facilitates the porting of software from one Freescale 802.15.4 product to the next.

For 802.15.4, the logic which determines which ZSM states allow aborting, is designed into the ZSM state machine. Not all states require an abort-on-unlock. When an unlock event occurs during a ZSM state that requires an abort, the ZSM will deassert its initiating signal to TSM (`zigbee_tx_en` or `zigbee_rx_en`), which results in a de facto abort, similar to a TSM-generated abort. For a ZSM abort, the `PLL_UNLOCK_IRQ` bit will become set, as will the `PLL_ABORTED` bit. The `PLL_UNLOCK_IRQ` bit is of type write-1-to-clear, and resides in the `IRQSTS1` register of 802.15.4 space. The `PLL_ABORTED` bit is a read-only bit, and resides in the `ABORT_STS` register of 802.15.4 space; it will self-clear at the start of the next autosequence.

45.6.2.6.3.7 Clocks

The ZSM sequence manager use 2 clocks.

The main clock is **seq_mgr_clk**. This clock establishes the sequence manager timebase (1us), and runs the sequence manager state machine and auxiliary timers.

A secondary clock is “**ck**”, which is a gated 32mhz clock from the reference oscillator. This clock is used only for low-latency processing of a few incoming signals, such as the issuing of XCVSEQ sequence commands through the IPS bus interface, which can occur at a rate faster than 1us.

The **seq_mgr_clk** and **ck** derive from the same 32MHz source. Thus, these 2 clocks are in the same clock domain, and will be balanced (skew-controlled) during clock-tree synthesis. The **seq_mgr_clk** will be generated in the CRM. All inputs to the sequence manager are also in this same clock domain, including all the TSM interface signals, and the IPS bus-based control registers; there are no clock-domain-crossings or asynchronous interfaces in the ZSM sequence manager.

45.6.2.6.3.8 Reset

The 802.15.4 Sequence Manager(ZSM) has a single, active-low, asynchronous reset input: **rst_b** . At integration, this reset should be tied to the master reset for the entire transceiver. There are no special reset requirements.

45.6.2.6.3.9 Interrupts

The 802.15.4 Sequence Manager generates 4 interrupt "triggers":

1. rxirq_trig
2. txirq_trig
3. ccairq_trig
4. filterfail_irq_trig

These triggers are not a direct interrupts to the MCU, but are used to set individual 802.15.4 Interrupt Status bits to become 4 of the 12 802.15.4 Link Layer interrupt sources which, if enabled, will result in the 802.15.4 interrupt **ipi_int_zigbee** being asserted to the MCU. These 4 interrupt triggers will assert the 802.15.4 Interrupt Status Bits RXIRQ, TXIRQ, CCAIRQ, and FILTERFAIL_IRQ, respectively. All of these Interrupt Status Bits reside in the IRQSTS1 register of 802.15.4 Address Space. See the 802.15.4 Interrupts Block Guide for more details on how the 802.15.4 Link Layer interrupt sources are consolidated into a single MCU interrupt line.

45.6.2.6.3.10 Appendix A

Effect of Timer TMR3 on Sequence Manager

Timer TMR3 can be used as a “bracketing” timer, to abort certain sequences after a software-determined timeout period. This timeout mechanism is enabled by setting the TC3TMOUT bit to 1. If TC3TMOUT=0, then the abort mechanism is disabled, and timer TMR3 functions merely as a software timer.

Timer TMR3’s hardware-abort functions are summarized in the following table.

Table 45-37. TMR3 Hardware Abort Functions

| SEQUENCE | TC3TMOUT=0 | TC3TMOUT=1 |
|----------|------------|---|
| I | S/W timer | S/W timer |
| R | S/W timer | Abort sequence |
| T | S/W timer | S/W timer |
| C | S/W timer | S/W timer |
| TR | S/W timer | Abort sequence, (during receive operation only) |
| CCCA | S/W timer | Abort sequence |

45.6.2.6.3.11 Appendix B

Continuous TX and RX Modes

Setting the bit CONTINUOUS_EN enables continuous transmission or reception, determined by which type of sequence is subsequently activated using the XCVSEQ register (i.e., Sequence T or Sequence R). Continuous TX and RX modes are designed to be used in tandem; i.e., two communicating devices, one serving as a continuous transmitter, and the other serving as a continuous receiver. The CONTINUOUS_EN resides in the SEQ_MGR_CTRL register of 802.15.4 address space. A description of the continuous TX and RX modes follows:

Continuous TX Mode

Continuous TX mode instructs the Sequence Manager to stay in a transmitting state forever (TX_PKT state), rather than shutting down the sequence after the 802.15.4 packet has been transmitted. In Continuous TX mode, data to be transmitted must be pre-established in the Packet Buffer prior to initiating a Sequence T. In Continuous TX mode, the first byte of the Packet Buffer determines the length of the buffer, in bytes. In this mode, when the end of the buffer is reached, instead of transmitting FCS (CRC bytes), the TX modem circles back to the 2nd byte of the buffer (the byte after the length byte), and re-transmits the remainder of the buffer again, and this repeats continuously, until one of the following events occurs:

- 1) CONTINUOUS_EN is deasserted by SW
- 2) SW aborts the Sequence T by writing Sequence I to XCVSEQ
- 3) An PLL Unlock occurs, aborting the Sequence

To prepare for Continuous TX mode, the following steps should be taken:

- 1) Write the “length” byte to the first byte of the Packet Buffer
- 2) Write the remaining Packet Buffer contents (a total of “length” bytes)
- 3) Assert the CONTINUOUS_EN bit
- 4) Start the Transmit Sequence by writing Sequence T to XCVSEQ.

After Continuous TX mode has been entered, the SEQ_STATE register can be monitored to verify the Sequence Manager has reached the TX_PKT state, and remains in this state.

Continuous RX Mode

Continuous RX mode instructs the Sequence Manager to stay in a receiving state forever (RX_PKT state), rather than shutting down the sequence after a 802.15.4 packet has been received. For continuous RX mode, it is assumed that another device has been deployed as a continuous transmitter. The length of the continuous transmitter’s TX buffer, will also be the length of the continuous receiver’s RX buffer. For the receiver, in Continuous RX mode, the length of the buffer is determined by the DUAL_PAN_DWELL register. (Needless to say, Continuous RX mode should not be engaged simultaneously with Dual PAN mode, since DUAL_PAN_DWELL is serving an alternate purpose). For Continuous RX mode, DUAL_PAN_DWELL should be programmed to the same value as the “length” byte of the continuous transmitter’s TX buffer. See step 2) above, for Continuous TX mode. In Continuous RX mode, the first byte received (after Preamble and SFD), will be the “length” byte, which can be read from the RX_FRM_LEN register of the receiving device. (It is up to the user to guarantee that this length byte on the TX device matches the contents of the DUAL_PAN_DWELL register on the RX devices, by correctly programming the 2 devices). Each subsequent byte which is received, will be written to the next sequential address of the Packet Buffer, starting at PB address 0. When the number of received bytes matches the contents of DUAL_PAN_DWELL register, the Packet Buffer’s address generation logic will circle back to PB address 0, and store the next received byte to this location. Then, each subsequent received byte, will be written to the next sequential address of the Packet Buffer. In this way, the contents of TX buffer on the continuous transmitter, will be identical to the contents of the RX buffer on the continuous receiver (assuming no reception errors). To prepare for Continuous RX mode, the following steps should be taken:

- 1) Program DUAL_PAN_DWELL register with the contents of the “length” byte of the continuously-transmitting device’s TX Buffer
- 2) Assert the CONTINUOUS_EN bit
- 3) Start the Receive Sequence by writing Sequence R to XCVSEQ.

After Continuous RX mode has been entered, the SEQ_STATE register can be monitored to verify the Sequence Manager has reached the RX_PKT state, and remains in this state. The contents of the Packet Buffer can also be observed in realtime, to verify they match the contents of the TX device’s TX buffer. The Sequence Manager will remain in the RX_PKT state until one of the following events occurs:

- 1) CONTINUOUS_EN is deasserted by SW
- 2) SW aborts the Sequence R by writing Sequence I to XCVSEQ
- 3) An PLL Unlock occurs, aborting the Sequence

45.6.2.7 Packet Storage

The 802.15.4 Link Layer has access to a Packet Buffer to store data to be transmitted, and to receive incoming packet data. The 802.15.4 Link Layer software prepares data to be transmitted, by loading the octets, in order, into the Packet Buffer. After reception, the octets received over the air are stored into the Packet Buffer, in the order they are received. The Packet Buffer contains separate spaces for TX and RX data, so incoming receive octets don’t overwrite previously-loaded content intended for transmission. The Packet Buffer is large enough to accommodate the longest 802.15.4 packet, 127 bytes, for both transmit and receive.

The 802.15.4 Packet Buffer is contained within the multi-protocol Packet RAM. In the Packet RAM, space has been allocated for 802.15.4 packets, with separate spaces for TX and RX. The Packet RAM is 16 bits wide, so the 802.15.4 Link Layer controller hardware will address the RAM in an interleaved fashion as it stores octets to, or fetches octets from, the RAM-based packet buffer. 802.15.4 will utilize space in RAM1, since this RAM is partitionable for multi-protocol operation (RAM0 is not). The 802.15.4 TX buffer space begins at RAM1 Entry #0, and 802.15.4 RX buffer space begins at RAM1 Entry #64. Separate TX and RX spaces means that incoming RX packets don’t overwrite TX packet data.

In addition, the 802.15.4 Link Layer controller includes acceleration for Source Address Matching (see Section: [802.15.4 Packet Processor, Source Address Management](#)). The hardware acceleration includes a Source Address Table, which is 128 entries by 16 bits wide. This table is also implemented in RAM1.

The partitioning of the Packet Buffer RAM1 amongst transmit, receive and source address matching sections for 802.15.4 is shown in the diagram below.

PACKET RAM ALLOCATIONS FOR 802.15.4

1. RAM1 holds TX Packet (@ Entry #0) & RX Packet (@ Entry #64)
2. RAM1 holds Src Addr Table (@ Entry #128)
3. TX & RX Packets Separated (RX doesn't overwrite TX)
4. Host Access Restricted to 16-Bit
5. See Below for Host/LL Multi-Access Restrictions
6. Retention: Not Req'd

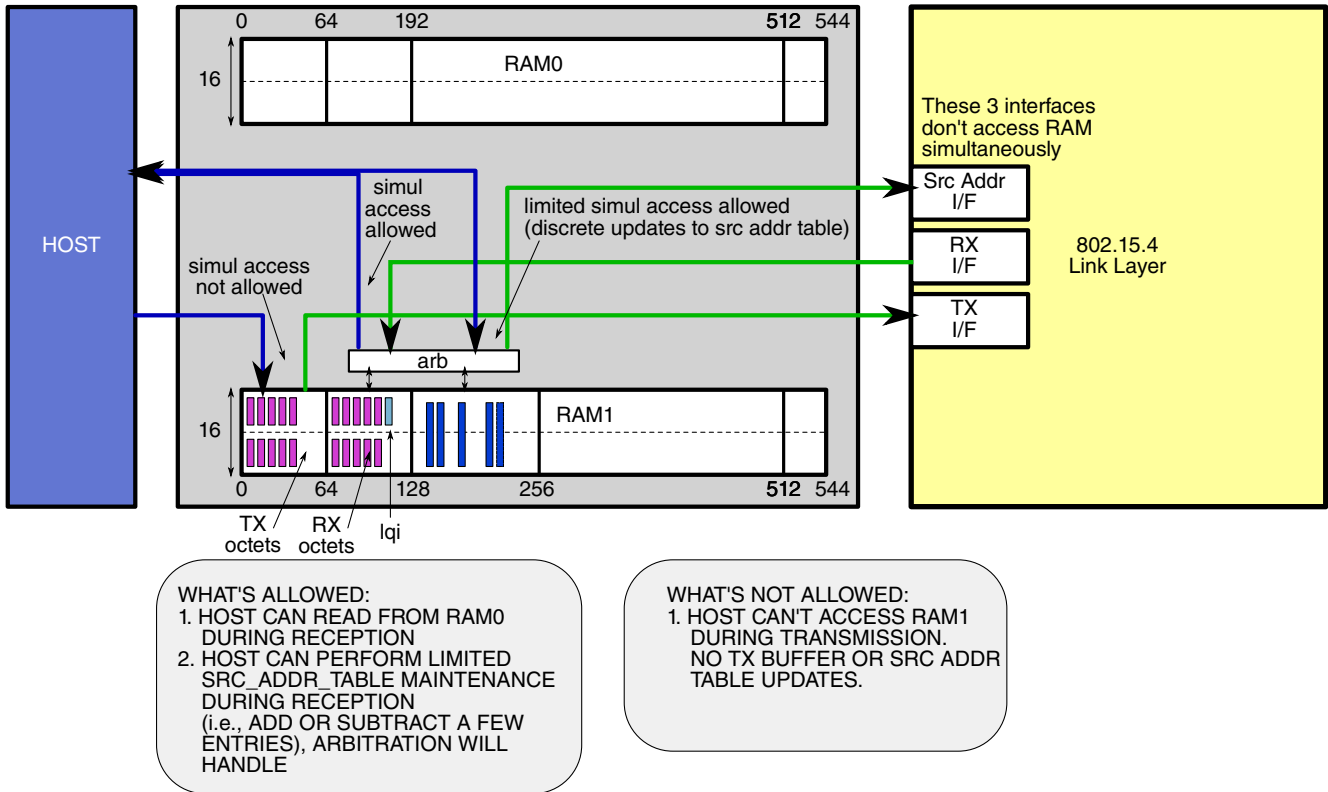

During packet reception, the MCU is allowed to access the RX packet buffer of RAM1, in order to download the packet while it's being received, if so desired. In cases where both the MCU and the 802.15.4 Link Layer controller attempt to access RAM1 during reception, internal hardware arbitration is provided to delay 802.15.4 Link Layer accesses to RAM1 until the MCU completes its access. The longest-duration continuous burst read by the MCU of RAM1, given a maximum 802.15.4 packet length of 128 octets (127 data octets plus 1 LQI octet) is shorter than the required interval between 802.15.4 Link Layer updates, so the Link Layer can be waited without any possibility of overrun.

During packet reception, the MCU is allowed to access the Source Address Table partition of RAM1. Access to the Source Address Table is indirect, and is performed through the 802.15.4 Register Interface, specifically by programming SAM_TABLE

register with the index of the table entry to be written or read, and the desired checksum in the case of write accesses. Because accesses to Source Address Table consist of discrete writes to 802.15.4 registers, and not long burst accesses, arbitration shall be able to accommodate Link Layer read accesses to the table while the Host access is underway, by delaying the Link Layer access until the Host completes.

During packet transmission, MCU access to RAM1 is not allowed. The 802.15.4 software must program the TX buffer before commanding a TX operation, and must not alter the Source Address Table once transmission has begun.

Arbitration

Arbitration hardware has been provided to allow the MCU to download data from the Packet RAM while the packet is being received, in order to allow a headstart on software packet processing, if required by the application. In the SoC, there is no provisions to wait the MCU on IPS or APB bus accesses to the radio. Therefore, in case of simultaneous access attempts by the MCU and the 802.15.4 Link Layer to RAM1, arbitration hardware delays the Link Layer access to RAM1 until the MCU completes its access. In the intended scenario, 802.15.4 software sets a RX watermark interrupt, and on this interrupt, proceeds to download the contents of the Packet RX buffer in RAM1. Given the maximum length packet of 127 octets, plus 1 LQI octet, the maximum length read burst by the MCU would be $128 / (2 \text{ octets} / \text{access}) / 32\text{MHz} = 2\mu\text{s}$. The update interval for the 802.15.4 Link Layer is the received symbol period of $16\mu\text{s}$. Since the longest wait interval the MCU could impose on the Link Layer does not exceed the Link Layer RAM1 update interval, there is no possibility of buffer overrun. The diagram below depicts 2 multi-access scenarios. In the first, the Host and Link Layer accesses do not overlap. In the second, overlap occurs, so arbitration is invoked, and the Link Layer access is slightly delayed.

RAM ARBITRATION TO ALLOW SIMUL HOST/LL ACCESS DURING RECEPTION

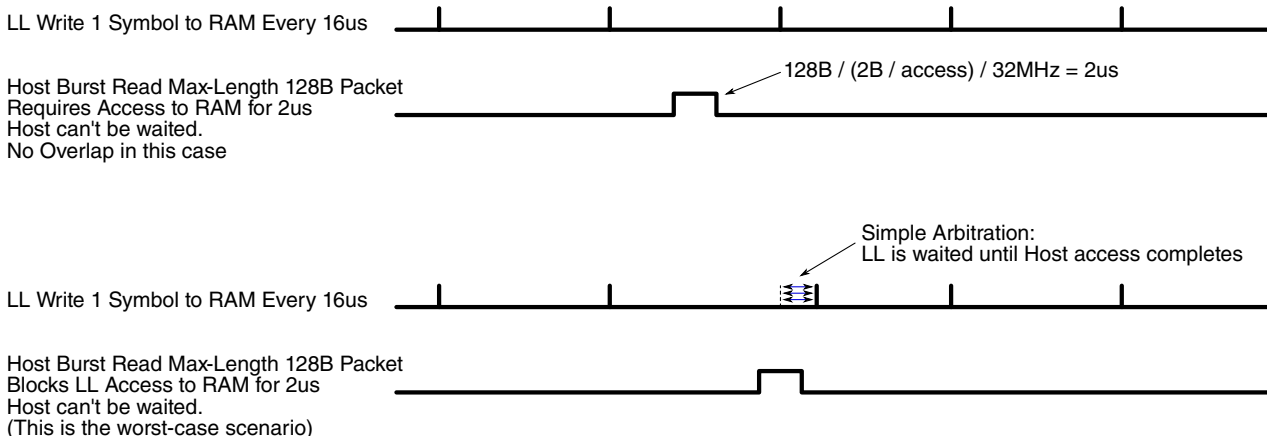

45.6.2.8 Memory Mapping

In the SoC memory map, space has been allocated to 802.15.4. Within the SoC, peripherals are allocated memory space in 4KB blocks, called IPS slots. 802.15.4 occupies one such slot. 802.15.4 address space consists of the 802.15.4 registers, as well as the Packet Buffer (RAM), which is memory-mapped into 802.15.4 memory space. The partitioning of address space for 802.15.4 is shown in the diagram below.

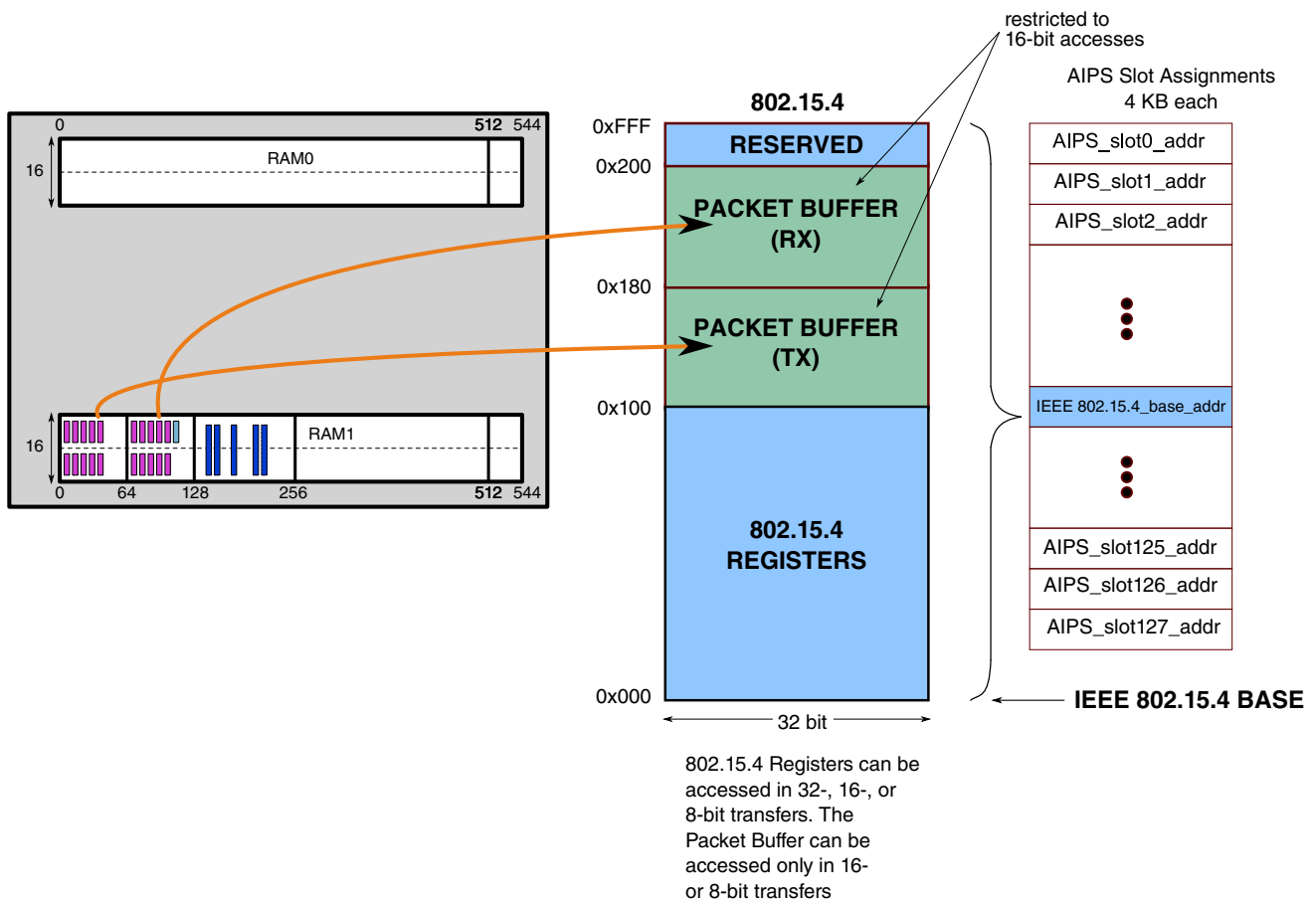

Figure 45-79. 802.15.4 MEMORY MAPPING

NOTE

See AIPS Memory Map for specific memory assignments details.

The Packet Buffer (RAM), is accessible by the MCU in 16-, or 8-bit accesses. The 802.15.4 Registers are accessible in 32-, 16-, or 8-bit accesses. The Source Address Table partition in RAM, is not accessible directly by the MCU, but via a prescribed protocol

using the 802.15.4 SAM_TABLE register (see Section: [Packet Processor, Source Address Management](#)). Therefore, the table is not memory-mapped directly into 802.15.4 address space.

45.6.2.9 Event Timer

OVERVIEW

The 802.15.4 Link Layer Controller contains an internal Event Timer block that manages link layer timing.

The Event Timer consists of a prescaler and a 24-bit counter which increment whenever the 32MHz reference oscillator is operating (i.e., the controller is not in Deep Sleep Mode). Interrupts to the MCU may be generated when the current time of the counter matches several pre-determined values set in programmable registers. The current time is accessible at any time via a read operation, as well as, programmable via a write operation.

The Event Timer provides the following functions:

- Timer to generate current system time
- Interrupt generation at pre-determined system times
- Abort an RX sequence at pre-determined system time
- Latches timestamp value during packet reception
- Initiates timer-triggered sequences

Note: The Event Timer is actually a 28-bit value, with 24 integer bits and 4 fractional bits. For most operations involving the Event Timer, such as interrupt-generation and sequence-triggering, only the integer portion need be considered, and the fractional component can be ignored. Extended-precision (28-bit) Event Timer operations are required only to realize the increased accuracy required for entering and exiting Deep Sleep Mode. See Section [Extended Precision Event Timer](#) below.

EVENT TIMER TIME BASE

The Event Timer's base clock (tmr_clk) is derived from a prescaler which is clocked by the 32MHz crystal source. The prescaler provides a counter input frequency of 62.5KHz, which sets the granularity and resolution of the current time. The 24-bit counter automatically rolls over upon reaching its maximum value, yielding a maximum possible Event Timer duration of 268.436 seconds.

READING CURRENT TIME

"Current Time" is defined as the value of the Event Timer internal counter. This 24-bit value can be read as the upper 3 bytes of the EVENT_TMR register. The EVENT_TMR register resides at address ZLL_BASE + 0x8, so the upper 3 bytes begin at ZLL_BASE + 0x9. The 24-bit value represents the integer component of the 28-bit Event Timer, which is all that is needed for most Event Timer operations. (For accessing the extended precision Event Timer, see Section Extended Precision Event Timer below.)

SETTING CURRENT TIME

"Current Time" is defined as the value of the Event Timer internal counter. This 24-bit value is available as the upper 3 bytes of the EVENT_TMR register. The EVENT_TMR register resides at address ZLL_BASE + 0x8, so the upper 3 bytes begin at ZLL_BASE + 0x9. The current time is programmable, but does not have to be programmed. In the reset condition, the current time is set to zero. Current time advances from zero at the tmr_clk clock rate and rolls over to zero after reaching its maximum value.

The Event Timer can be updated in one of 2 ways:

EVENT_TMR_LD: Write the desired new EVENT_TMR value into the EVENT_TMR field of the EVENT_TMR register (upper 3 bytes), with the EVENT_TMR_LD bit set.

EVENT_TMR_ADD: Write the desired *increment* to the EVENT_TMR value into the EVENT_TMR field of the EVENT_TMR register (upper 3 bytes), with the EVENT_TMR_ADD bit set. The increment will be added to the current value of EVENT_TMR to become the new EVENT_TMR value. Since the Event Timer value is 24-bits, the addition is modulo 2^{24} .

Needless to say, EVENT_TMR_LD and EVENT_TMR_ADD are mutually exclusive, and no more than 1 of these bits should be set.

The 24-bit value represents the integer component of the 28-bit Event Timer, which is all that is needed for most Event Timer operations. (For accessing and updating the extended precision Event Timer, see Section Extended Precision Event Timer below.)

LATCHING THE TIMESTAMP

During packet reception, the 802.15.4 link layer controller has the ability generate a timestamp, or to latch a copy of the "current time" while continuing to increment its internal counter. This timestamp value latched within the Event Timer corresponds to the beginning of a receive packet where the actual packet data begins after the SFD (Start-of-Frame-Delimiter) has been received. The timestamp[23:0] can be accessed by reading the read-only register of the same name, TIMESTAMP, which resides at address ZLL_BASE + 0xC. Once the timestamp has been latched, it shall remain valid until the *next* SFD detection.

EVENT TIMER COMPARATORS

There are four 24-bit timer compare fields:

1. T1CMP[23:0] at address ZLL_BASE + 0x10
2. T2CMP[23:0] at address ZLL_BASE + 0x14
3. T3CMP[23:0] at address ZLL_BASE + 0x1C
4. T4CMP[23:0] at address ZLL_BASE + 0x20

And a special 16-bit timer compare field, for situations where the upper byte of EVENT_TMR is a don't-care.

- T2PRIMECMP[15:0] at address ZLL_BASE + 0x18

The TMR2IRQ status bit, can be set by a match to T2CMP or T2PRIMECMP. If register bit TC2PRIME_EN=1 (PHY_CTRL register, address ZLL_BASE + 0x04), then TMR2IRQ becomes set by a match to T2PRIMECMP (16-bit compare); if TC2PRIME_EN=0, then TMR2IRQ becomes set by a match to T2CMP (24-bit compare).

Each timer comparator has a enable bit that enables or disables the compare function. The enable bit is written to a 1 to enable the corresponding comparator, and the default condition is the timer compare disabled (reset to 0):

1. TMR1CMP_EN (for T1CMP)
2. TMR2CMP_EN (for T2CMP and T2PRIMECMP)
3. TMR3CMP_EN (for T3CMP)
4. TMR4CMP_EN (for T4CMP)

If a timer comparator is enabled using its associated bit, the corresponding interrupt status bit (TMRxIRQ) will be set by a timer compare match to its respective TxCMP register. If a timer comparator is disabled using its associated bit, the corresponding interrupt status bit (TMRxIRQ) will not be set by a timer compare match to its respective TxCMP register.

When enabled, all four fields can be continuously compared to the current value of the Event Timer counter. When a match occurs, the following corresponding internal status flags assert:

1. TMR1IRQ (T1CMP match)
2. TMR2IRQ (T2CMP or T2PRIMECMP match)
3. TMR3IRQ (T3CMP match)
4. TMR4IRQ (T4CMP match)

These 4 status bits all reside in the IRQSTS register at address ZLL_BASE + 0x0. The 4 interrupt status bits are write-1-to-clear. The status bit remains set until a 1 is written to the bit location in the IRQSTS register. Writing 0 to the bit, or reading the bit, will not change its state.

When a comparator match occurs and the internal status flag asserts, the following interrupt masks can enable an interrupt on the ipi_int_zigbee line to the MCU:

1. TMR1MSK, applies to TMRQ1IRQ
2. TMR2MSK, applies to TMRQ2IRQ
3. TMR3MSK, applies to TMRQ3IRQ
4. TMR4MSK, applies to TMRQ4IRQ

If the interrupt mask is set to 1 (masked), the respective interrupt status bit, TMRxIRQ, will not cause an interrupt on the ipi_int_zigbee line. If the interrupt mask is set to 0 (enabled), the respective interrupt status bit, TMRxIRQ, will cause an interrupt on ipi_int_zigbee. Timer mask bits, TMRxMSK, have no effect on the state of the TMRxIRQ interrupt status bits; they only allow (or prevent) the respective TMRxIRQ bit from generating an interrupt to the MCU on ipi_int_zigbee.

INTENDED EVENT TIMER USAGE

It is intended that the system utilize the current time value and the timer compare functions of the Event Timer to schedule system events, including:

1. Generating time-based interrupts
2. Aborting an RX operation
3. Triggering transceiver operations

GENERATING TIME-BASED INTERRUPTS

Generating time-based interrupts is accomplished by setting timer compare values relative to the current time, allowing the Event Timer counter to increment until a timer compare match is generated, and using this match to generate an interrupt to the host. The general procedure is as follows:

1. Disable the timer compare: set TMRxCMP_EN=0
2. Enable the timer compare interrupt mask: set TMRxMSK=1
3. Read the current time value from EVENT_TMR register
4. Determine an offset to this value to equal desired future time.
5. Write to EVENT_TMR register with the EVENT_TMR field set to this offset, and set EVENT_TMR_ADD=1
6. Re-enable the timer compare: set TMRxCMP_EN=1
7. Unmask the timer compare interrupt mask: set TMRxMSK=0
8. Wait for TMRxIRQ

9. After TMRxIRQ, program the appropriate TMRxCMP_EN bit to disable the compare function. If this is not done, the compare function will continue to run and generate another interrupt every time the counter rolls over and again matches the comparator.

USING T3CMP TO ABORT AN RX OPERATION

The Event Timer provides a timer-based mechanism to automatically abort an RX operation. The 802.15.4 link layer is put into an RX operation when XCVSEQ[2:0] (PHY_CTRL register, address ZLL_BASE + 0x4) is set to 0x01. An RX autosequence will commence, and will begin a search for preamble. Software can program in advance, a hardware timeout to occur, such that the RX autosequence can be automatically aborted by hardware after a certain amount of time elapses without a packet being detected. The general procedure is as follows:

1. Read the current time value from EVENT_TMR register
2. Add an offset to this value to equal desired future time to abort the RX operation.
3. Program register T3CMP[23:0] to value future time.
4. Program TC3TMOUT=1, (PHY_CTRL Register, address ZLL_BASE + 0x4) to 1, to enable hardware aborting of the RX operation.
5. Program XCVSEQ=1, to start the RX autosequence
6. When current time equals T3CMP[23:0], the 802.15.4 Sequence Manager aborts the RX autosequence, and the Sequence Manager returns to SEQ_IDLE state. The SEQIRQ interrupt status bit (IRQSTS Register, address ZLL_BASE + 0x0) will be set, and the TMR3IRQ interrupt status bit will also be set. The RXIRQ interrupt status bit will not be set, since no packet was received before the timeout. In the SEQ_CTRL_STATUS register (address ZLL_BASE + 0x78), the TC3_ABORTED status bit will also be asserted to indicate that the type of abort that occurred was a TMR3 timeout. This bit will self-clear at the start of the next autosequence.

As mentioned above, TMR3 with TC3TMOUT=1 can be used to abort an RX operation. Such an RX operation can be entered by launching a Sequence R (XCVSEQ=1), and can also be entered by launching a Sequence TR (XCVSEQ=4); after the TX operation of a Sequence TR completes, an RX operation begins, and can be aborted using this method. In addition, a Continuous CCA autosequence (XCVSEQ=5) can be aborted using this method. When a TMR3 timeout occurs with TC3TMEOUT=1 during transceiver operations other than those listed above, TMR3 will not abort the autosequence, and

TMR3 becomes merely a software timer, capable of setting TMR3IRQ and interrupting the MCU. The table below shows the effect of TMR3 timeouts on the 802.15.4 autosequences:

Table 45-38. TMR3 Hardware Abort Functions

| SEQUENCE | TC3TMOUT=0 | TC3TMOUT=1 |
|----------|------------|---|
| I | S/W timer | S/W timer |
| R | S/W timer | Abort sequence |
| T | S/W timer | S/W timer |
| C | S/W timer | S/W timer |
| TR | S/W timer | Abort sequence, (during receive operation only) |
| CCCA | S/W timer | Abort sequence |

USING T2CMP OR T2PRIMECMP TO TRIGGER TRANSCEIVER OPERATIONS

The Event Timer provides a timer-based mechanism to automatically launch a transceiver autosequence. Using this method, a sequence can be scheduled for time in the future, and the MCU can be put into a reduced power state, without the need to wake up at the appropriate time to start the autosequence. The general procedure is as follows.

1. Read the current time value from EVENT_TMR register.
2. Add an offset to this value to equal desired future time to launch the autosequence.
3. For a 24-bit compare, program register T2CMP[23:0] to value future time, and set TC2PRIME_EN=0. For a 16-bit compare, program register T2PRIMECMP[15:0] to value future time, and set TC2PRIME_EN=1. Set TMRTRIGEN=1 and program the desired autosequence into XCVSEQ[2:0]. The Sequence Manager will not launch the sequence immediately because it sees TMRTRIGEN=1.
4. When current time equals T2CMP[23:0] (for a 24-bit compare), or T2PRIMECMP[15:0] (for a 16-bit compare), the Sequence Manager will launch the scheduled autosequence in accordance with the XCVSEQ[2:0] field. The TMR2IRQ interrupt status bit will become set simultaneous with the autosequence launch.
5. The MCU can wake up at this point (if TMR2MSK=0), or can elect to continue in low-power state until the autosequence completes, at which time SEQIRQ will become set. If SEQMSK=0, then SEQIRQ will interrupt the MCU at the completion of the transceiver operation.

EXTENDED PRECISION EVENT TIMER

For most 802.15.4 transceiver operations referencing the Event Timer, the 24-bit precision and the 62.5KHz update rate (16 μ s period) are sufficient. However, the required precision for maintaining the 802.15.4 timebase is tighter: 1 microsecond, instead of 16.

As long as the 32MHz reference oscillator is running there is no difficulty maintaining that precision. However, when the link layer has to enter low-power state, and the reference oscillator must be switched off, and alternate clock source must be temporarily employed to keep the timebase running. This low power state is known as Deep Sleep Mode, or DSM. The alternate clock source, a 32KHz crystal oscillator, is equally as precise as the reference oscillator, but with a much longer period. At the instant the reference oscillator is turned off and the switchover to the 32KHz is made, the EVENT_TMR becomes frozen at its current state. After a period of DSM, when the precisely-programmed wakeup point is reached, the reference oscillator, which has been previously restarted, is re-engaged by the link layer, and the EVENT_TMR resumes counting where it left off. The precise duration of time for which the EVENT_TMR was frozen, is known to software, based on DSM programming parameters. The EVENT_TMR must be corrected for this "time slept", by adding to it an amount equal to "time slept", in microseconds (hence the requirement for microsecond precision). After the precise correction is made, the EVENT_TMR is now up-to-date, as if the DSM entry/exit had never happened, and all previously scheduled events will occur on time, within 1 μ s precision. See Section [Deep Sleep Mode](#).

To realize the required microsecond precision, the actual Event Timer has been expanded to 28 bits, with 24 integer bits and 4 fractional bits, as shown in the diagram below.

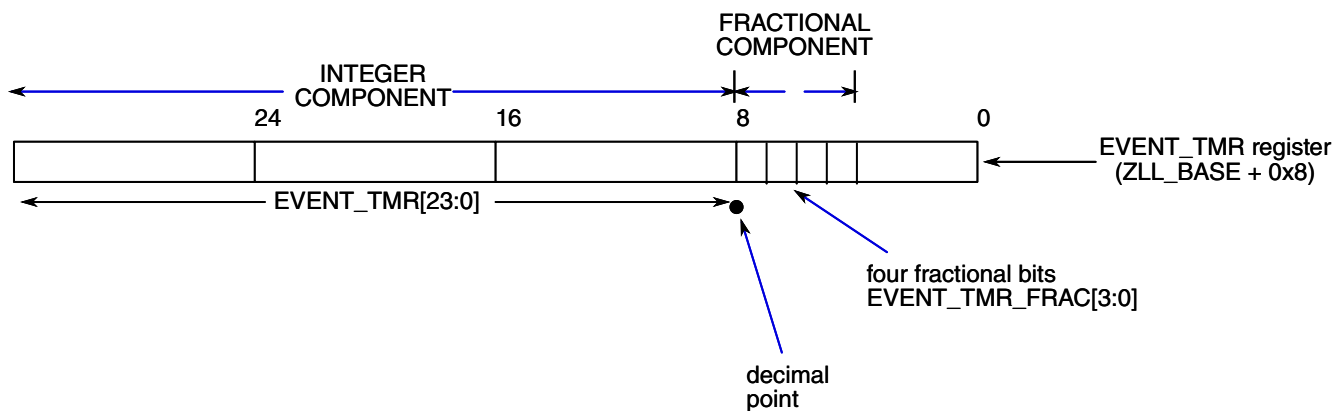

Figure 45-80. Event Timer Integer and Fractional Components

The 24-bit integer component is the EVENT_TMR value that has been referenced earlier in this block guide; most 802.15.4 operations require only the integer component, and the fractional component can be ignored. When the fractional bits are not required, writes to EVENT_TMR register (read-modify-write operations) with EVENT_TMR_LD=1 should leave the fractional bits unchanged. Transceiver operations which reference the EVENT_TMR (i.e., automatic sequence launching, and RX sequence aborting), reference only the integer component, as shown below.

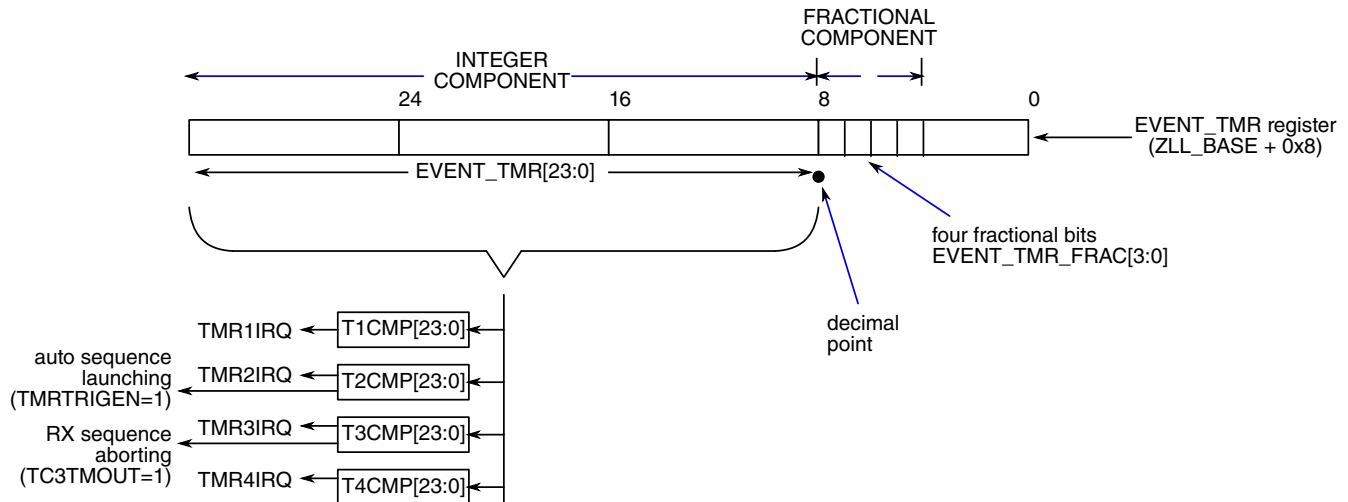

Figure 45-81. Event Timer Hardware Referencing

However, software `EVENT_TMR` updates to correct for "time slept" after a DSM cycle must make use of the full precision, including the fractional bits, in order to maintain microsecond accuracy. For example, say a DSM cycle was just completed in which the `EVENT_TMR` was frozen for exactly $163\mu\text{s}$. The $163\mu\text{s}$ must be "added back" to the `EVENT_TMR`.

In this case the integer component is:

$$\text{integer}(163\mu\text{s} / 16\mu\text{s}) = \mathbf{10}$$

And the fractional component is the remainder x 16:

$$(163\mu\text{s} / 16\mu\text{s}) - \text{integer}(163\mu\text{s} / 16\mu\text{s}) = 3/16 \times 16 = \mathbf{3}$$

So the value written to the `EVENT_TMR` with the `EVENT_TMR_ADD` bit set, accounting for the bit shifts to align to the integer and fractional components of the `EVENT_TMR` register, is:

$$(10 \ll 8) | (3 \ll 4), \text{ or,}$$

$$\text{EVENT_TMR} = (10 \ll 8) | (3 \ll 4) | \text{EVENT_TMR_ADD};$$

This operation adds $163\mu\text{s}$ to the `EVENT_TMR` current time, and after the update has occurred, the 802.15.4 timebase has been restored, as if no DSM cycle had occurred, within $1\mu\text{s}$ accuracy. For more details on DSM procedure, see Section [Deep Sleep Mode](#).

45.6.2.10 Deep Sleep Mode

When the 802.15.4 Link Layer anticipates long periods of inactivity, the Link Layer controller can be put into a Deep Sleep Mode (DSM), where all of its clocks are turned off. In addition, the 802.15.4 Link Layer can be configured to optionally turn off the RF Oscillator, if it is not otherwise needed by the SoC. Deep Sleep Mode results in dramatic power savings.

To make possible Deep Sleep Mode, the transceiver incorporates a low-frequency, high-precision Deep Sleep Timer, DSM_TIMER. This timer is clocked by a crystal-referenced 32.768KHz oscillator. The timer is 24-bit wide, yielding a 8.5 minute rollover (the maximum length of a deep sleep period). The DSM_TIMER resides in the RSIM module.

The hardware to implement DSM within the SoC, is partitioned across several modules, and several power domains. This is to allow the maximum achievable power savings, by retaining full voltage for only those modules which need to be active in DSM, and placing the remaining modules in “state retention” mode. The diagram below depicts the partitioning of DSM hardware across the various modules, including the 802.15.4 Link Layer Controller.

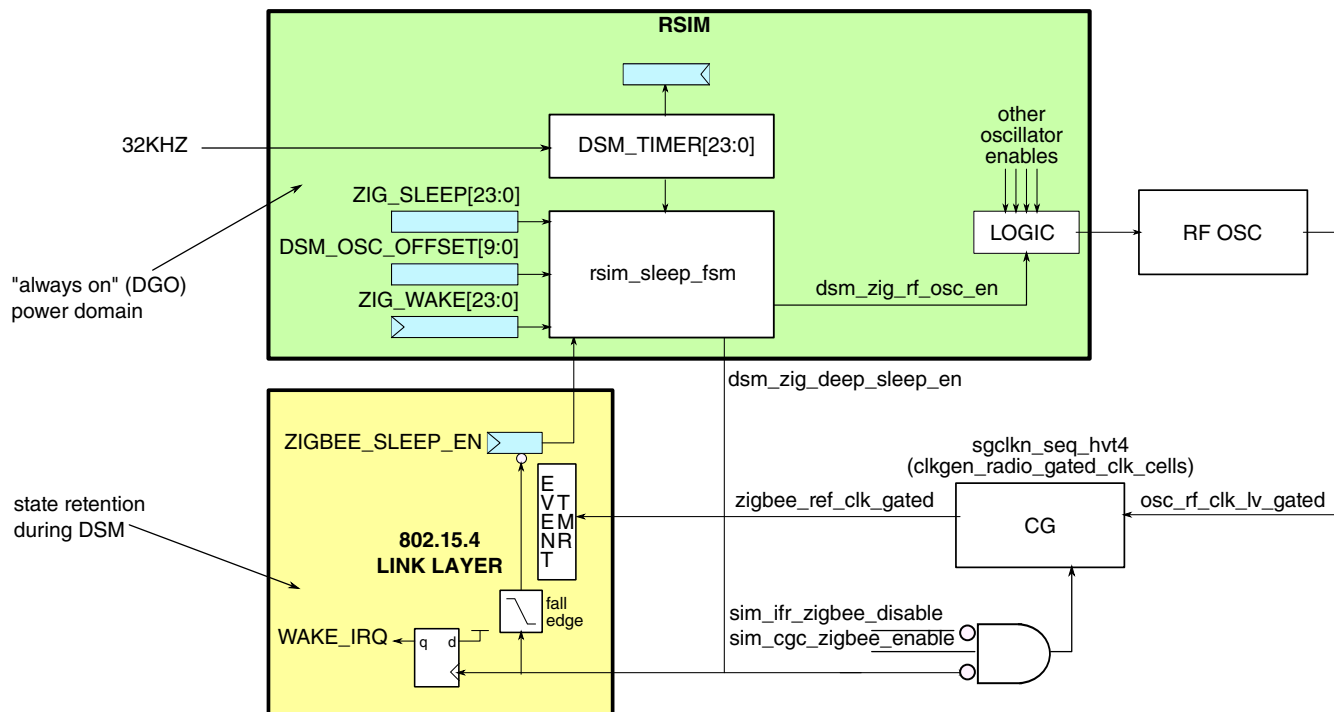

Figure 45-82. Deep Sleep Mode

The concept behind DSM, as it is implemented for 802.15.4, is to allow the 802.15.4 timebase to be maintained for a period of time, while the RF Oscillator is turned off and much of the SoC is placed in state-retention. During DSM, the timebase management is temporarily transferred from the 802.15.4 EVENT_TMR to the low-power

DSM_TIMER, and after DSM exit, timebase management is transferred back to the EVENT_TMR. During DSM, the EVENT_TMR is frozen. The total time spent in DSM is known to software, so that upon exiting DSM, the EVENT_TMR can be updated to correct for the precise amount of time it was frozen.

DSM entry and exit, and RF Oscillator re-start during DSM, are governed by 5 registers, as described in the table below.

| Field | R/W | Description |
|---------------------|-----|--|
| ZIG_SLEEP[23:0] | rw | If DSM_CTRL[ZIGBEE_SLEEP_EN]=1, enter DSM and freeze EVENT_TMR when ZIG_SLEEP matches DSM_TIMER. NOTE: This register resides in RSIM Address Space |
| DSM_OSC_OFFSET[9:0] | rw | Awaken SoC, start the RF Oscillator when: $(ZIG_WAKE - DSM_OSC_OFFSET) = DSM_TIMER$ NOTE: This register resides in RSIM Address Space |
| ZIG_WAKE[23:0] | rw | Exit Deep Sleep Mode, and resume EVENT_TMR, when ZIG_WAKE matches DSM_TIMER NOTE: This register resides in RSIM Address Space |
| ZIGBEE_SLEEP_EN | w | Enable a match on ZIG_SLEEP[23:0] to DSM_TIMER[23:0], to enter Deep Sleep Mode, by writing a 1 to this bit. This bit is write-only, and always reads back 0. Writing a 0 to this bit has no effect. This bit resides in the DSM_CTRL register of 802.15.4 address space. |
| DSM_TIMER[23:0] | r | Current State of the 32KHz Sleep Timer NOTE: This register resides in RSIM Address Space |

Procedure

The procedure to schedule a DSM cycle (entry/exit) as well as to program the desired RF Oscillator re-start time, and the calculation to restore the 802.15.4 EVENT_TMR after a DSM cycle, is described below.

1. Software determines the future time at which it would like to enter DSM, by reading the DSM_TIMER, computing the number of 32 KHz clock cycles remaining until the desired DSM start-time, and writing this value into ZIG_SLEEP register. The value programmed into ZIG_SLEEP should be no fewer than 4 clocks greater (in the future) than the current time as read from DSM_TIMER.

2. Software determines the future time at which it would like to exit DSM, by computing the number of 32KHz clock cycles remaining until the desired DSM exit-time, and writing this value into ZIG_WAKE register.
3. The DSM_OSC_OFFSET register should be pre-programmed with the number of 32 KHz required for oscillator re-start. This should be done during initial SoC configuration and should not need to be updated during this procedure. **Note:** When programming ZIG_WAKE, software must ensure that the following 2 equations are true:

$$\text{ZIG_WAKE} - \text{DSM_OSC_OFFSET} > \text{DSM_TIMER} + 4$$

$$\text{ZIG_WAKE} - \text{DSM_OSC_OFFSET} > \text{ZIG_SLEEP}$$

4. Software writes a 1 to DSM_CTRL[ZIGBEE_SLEEP_EN]. This bit resides in 802.15.4 address space. This bit is write-only and always reads back 0. Writing this bit to 1 enables a DSM cycle to commence using the values programmed into ZIG_SLEEP and ZIG_WAKE.
5. MCU can go into a low power state (e.g., wait-for-interrupt to enter STOP)
6. When DSM_TIMER = ZIG_SLEEP, the EVENT_TMR will be clock-gated so that it will remain frozen at its current count. The RF Oscillator will be turned off (unless overridden due to a non-802.15.4-related SoC requirement)
7. All hardware not in the low-voltage domain will be placed into state-retention (or other low-power state).
8. When DSM_TIMER = (ZIG_WAKE – DSM_OSC_OFFSET), the parts of the SoC in low-power state will be returned to normal operation, and the RF Oscillator will be re-started. (DSM_OSC_OFFSET will be programmed with a sufficient value to allow the oscillator to stabilize before clocks are released to the 802.15.4 Link Layer)
9. When DSM_TIMER = ZIG_WAKE, clocking of the 802.15.4 Link Layer Controller will resume and the EVENT_TMR will be ungated (allowed to resume counting).
10. When DSM_TIMER = ZIG_WAKE, the WAKE_IRQ status bit of IRQSTS register will be asserted, and will generate an interrupt to the MCU if PHY_CTRL[WAKE_MSK]=0. Clear WAKE_IRQ by writing a '1' to the bit location.
11. Software computes the time that the SoC was in DSM (and hence the time the EVENT_TMR was frozen), in microseconds, with the equation:

$$(\text{ZIG_WAKE} - \text{ZIG_SLEEP}) / 32768 * 1000000$$

12. Software increments the EVENT_TMR by this amount, by writing this value to the EVENT_TMR register with EVENT_TMR_ADD=1. The 802.15.4 EVENT_TMR register has both integer and fractional components, in order to achieve microsecond precision for DSM. See Section [Event Timer](#), Sub-section [Extended Precision Event Timer](#) for more details, and an example of restoration of the 802.15.4 EVENT_TMR timebase after a DSM cycle.

13. On the next 1MHz clock edge, the EVENT_TMR has been restored to where it would have been, had no DSM occurred, with microsecond accuracy.

The following timing diagram depicts an 802.15.4-driven DSM entry/exit cycle.

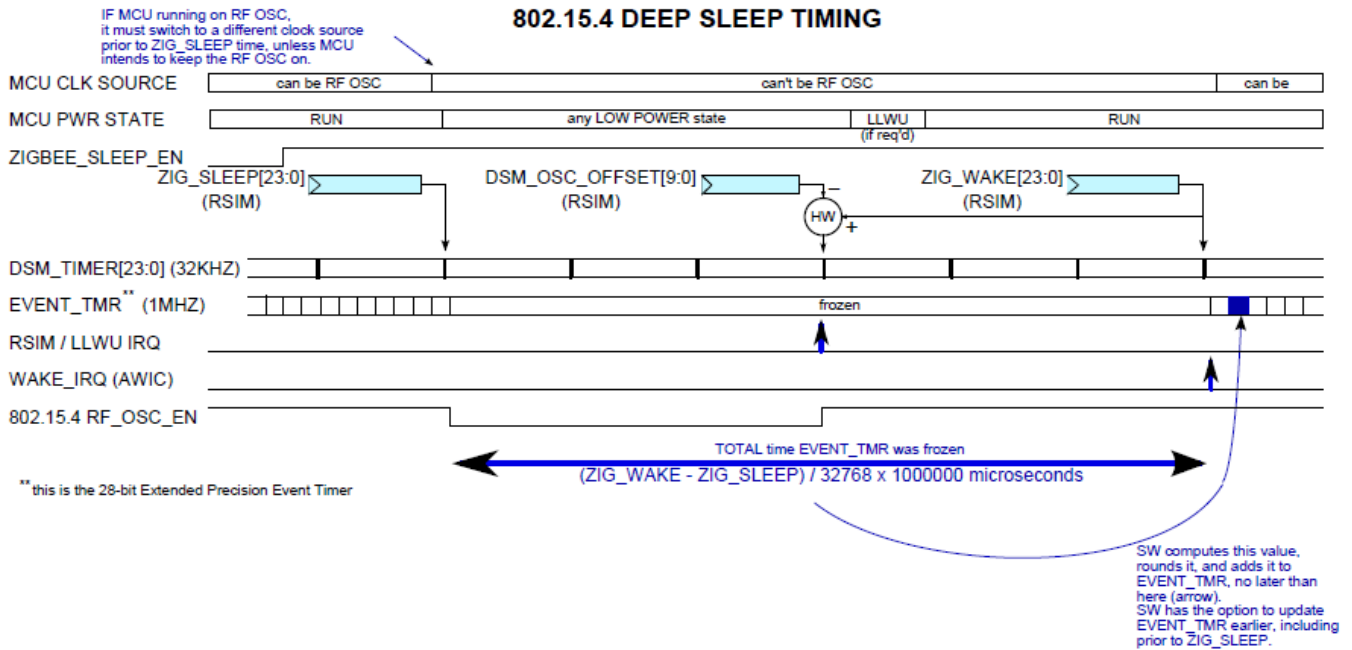

Figure 45-83. 802.15.4 DEEP SLEEP TIMING

Note: If the DSM low power state selected by the SoC is VLLS, the SIM_CGC bit for 802.15.4 will be cleared, and must be re-established in the LLWU ISR (not the WAKE_IRQ ISR, which would be too late)

45.6.2.11 CCA/ED/LQI

45.6.2.11.1 Introduction

CCA/ED/LQI block resides inside 802.15.4 demodulator top. The purpose of this block is to perform the following operations: 1) Clear Channel Assessment: Modes 1, 2 and 3, 2) Energy Detection and 3) Link Quality Indicator.

This block takes RSSI value, as an input, for computations related to CCA modes 1 and 3, Energy Detection and LQI. For CCA2, this block takes output of 802.15.4 correlators for detecting an 802.15.4 signal in the channel of interest.

At the output, it provides a signal called (cca) to indicate if the channel of interest is busy (cca=1) or idle (cca=0), the final computed energy value (cca1_ed_fnl) and Link Quality Indicator (LQI) value. The cca signal is further used to generate cca interrupt, according to the set interrupt mask. The cca1_ed_fnl is a signed 8 bit value that can be read back as a register. LQI is an unsigned 8 bit value that is written at the end of each valid packet that is received and is available to be read in the packet buffer.

45.6.2.11.1.1 Block diagram

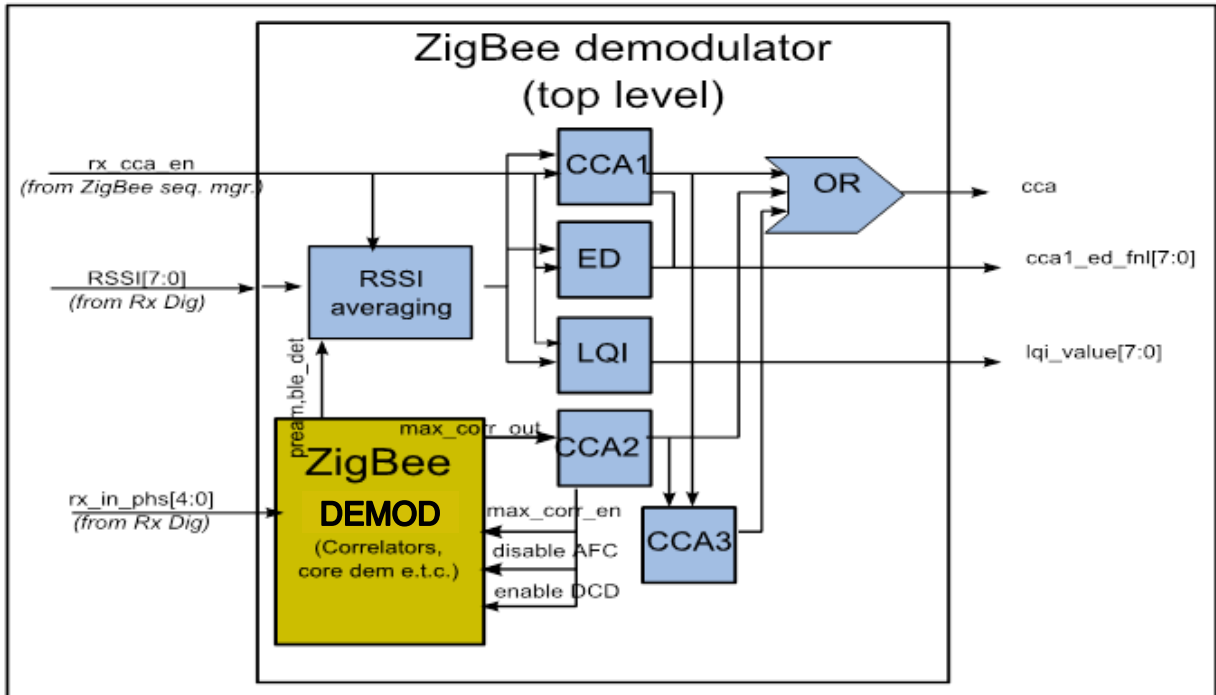

45.6.2.11.2 Memory Map and register definition

| Field | R/W | Description |
|-------------------------------|-----|---|
| LQI_VALUE[7:0] | r | 8-bit LQI value of each Rx packet |
| CCA1_ED_FNL[7:0] | r | 8-bit signed value to indicate last energy detected |
| CCA1_THRESH[7:0] | rw | 8-bit signed value to be compared against averaged signed RSSI value from Rx DIG block, to determine channel busy or idle |
| LQI_OFFSET_COMP[7:0] | rw | 8-bit value to offset average of signed RSSI value coming from Rx DIG, in order to compute 8-bit LQI value. |
| CCA3_AND_NOT_OR | rw | This register bit controls how CCA1 and CCA2 are combined to assert CCA3 mode: 1 : CCA1 AND CCA2 0: CCA1 OR CCA2 |
| CCA2_MIN_NUM_CORR_THRESH[2:0] | rw | 3-bit value to compare against number of correlation peaks within CCA2 time. |
| CCA2_NUM_CORR_PEAKS[3:0] | r | 4-bit value indicating number of correlation peaks detected in last CCA2 run |
| CCA2_CORR_THRESH[7:0] | rw | 8-bit value to be compared against correlation peak value during CCA2 operation. |
| LQI_START_AT_SFD | rw | Defines starting point for LQI computation during packet reception 1: Begin computing LQI at SFD detect (new for KW41) 0: Begin computing LQI at preamble detect (legacy) |

45.6.2.11.3 Functional description

The following sections describe functional details of the module.

45.6.2.11.3.1 RSSI Averaging

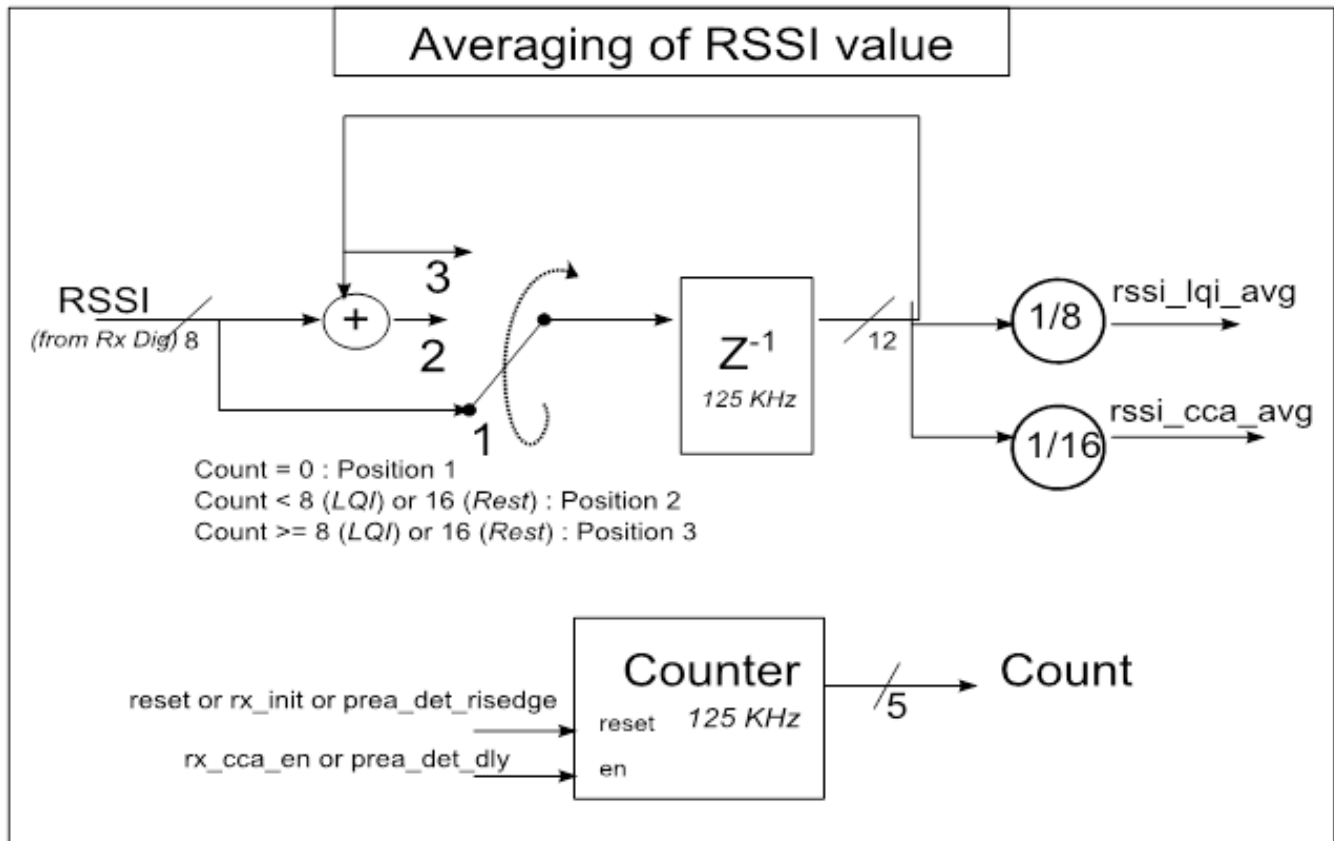

The above picture shows how RSSI is averaged. 8-bit signed RSSI value from Rx Dig block is averaged for 128 us for CCA1/2/3/ED sequences. For LQI, it is averaged for 64 us. In both cases, the RSSI value is sampled at 125 KHz rate.

45.6.2.11.3.2 CCA1

When the 802.15.4 link layer is set up to perform CCA1 operation, rx_cca_en signal is asserted at the end of Rx warm up by the 802.15.4 Sequence Manager. After rx_cca_en is asserted high, at the end of 128 us, i.e. count = 16, rssi_cca_avg is compared against 8-bit signed register cca1_thresh to assess CCA as follows:

If rssi_cca_avg >= cca1_thresh, CCA1 = 1, i.e. channel is busy.

Else CCA1 = 0, i.e. channel is idle.

45.6.2.11.3.3 CCA2

When the 802.15.4 link layer is set up to perform CCA2 operation, rx_cca_en signal is asserted at the end of Rx warm up by the 802.15.4 Sequence Manager. During CCA2 operation, differential chip detection is enabled and automatic frequency correction is

disabled, in order to receive correlation peaks related to all available 16 802.15.4 symbols. The signal `max_corr_en` is held high, in order to refresh maximum correlator value after each symbol period. 128 us after `rx_cca_en` is asserted high, i.e. `count = 16`, the number of maximum correlation peaks are counted which exceeded the value `cca2_corr_thresh` register. If the number of correlation peaks exceeds minimum desired number of correlation peaks (programmable register: `cca2_num_corr_peaks`), `cca2` is asserted high to indicate the channel is busy and low otherwise, to indicate channel is idle.

45.6.2.11.3.4 CCA3

CCA mode 3 is a combination of CCA1 and CCA2. There are 2 combinations in which CCA mode 3 operates, based on the register setting of `CCA3_AND_NOT_OR`: 1) CCA1 OR CCA2 2) CCA1 AND CCA2. When the 802.15.4 link layer is set to perform CCA3, both CCA1 and CCA2 operations, as mentioned above and decides if the channel is busy or idle, according to the desired combination (i.e. AND/OR).

45.6.2.11.3.5 Energy Detection

During Energy Detection operation, the demodulator is expected to average RSSI value (from `Rx_DIG`) for 128 us, as mentioned above in the block diagram. At the end of 128 us, the register `CCA1_ED_FNL` is updated with this average energy value. Energy detection is similar to CCA1. Unlike CCA1, busy/idle signal is not generated.

45.6.2.11.3.6 Link Quality Indicator

LQI maps RSSI value (from `Rx_DIG`) to values between 0x00 and 0xFF, as shown in the following block diagram. Upon preamble detect, RSSI value is averaged for 64 us and mapped to LQI value. This latched LQI value is available in the register `LQI_VALUE`. Packet processor also appends this LQI value at the end of packet buffer.

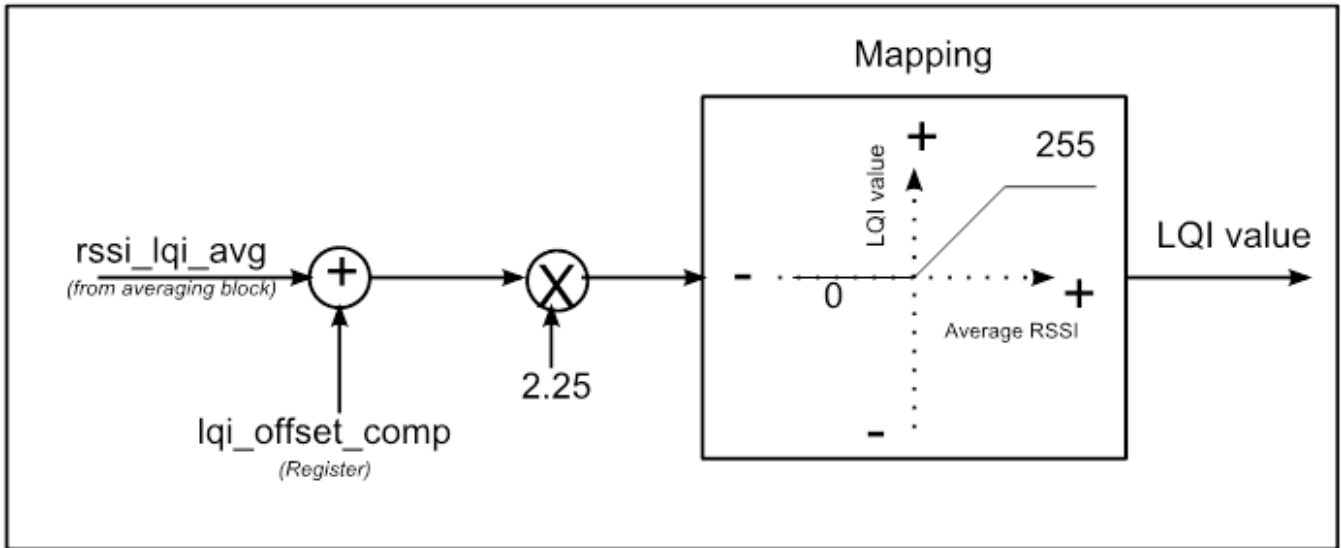

Figure 45-85. LQI Computation

The following picture shows an example of mapped LQI, when the register LQI_OFFSET_COMP is programmed to decimal value of 102.

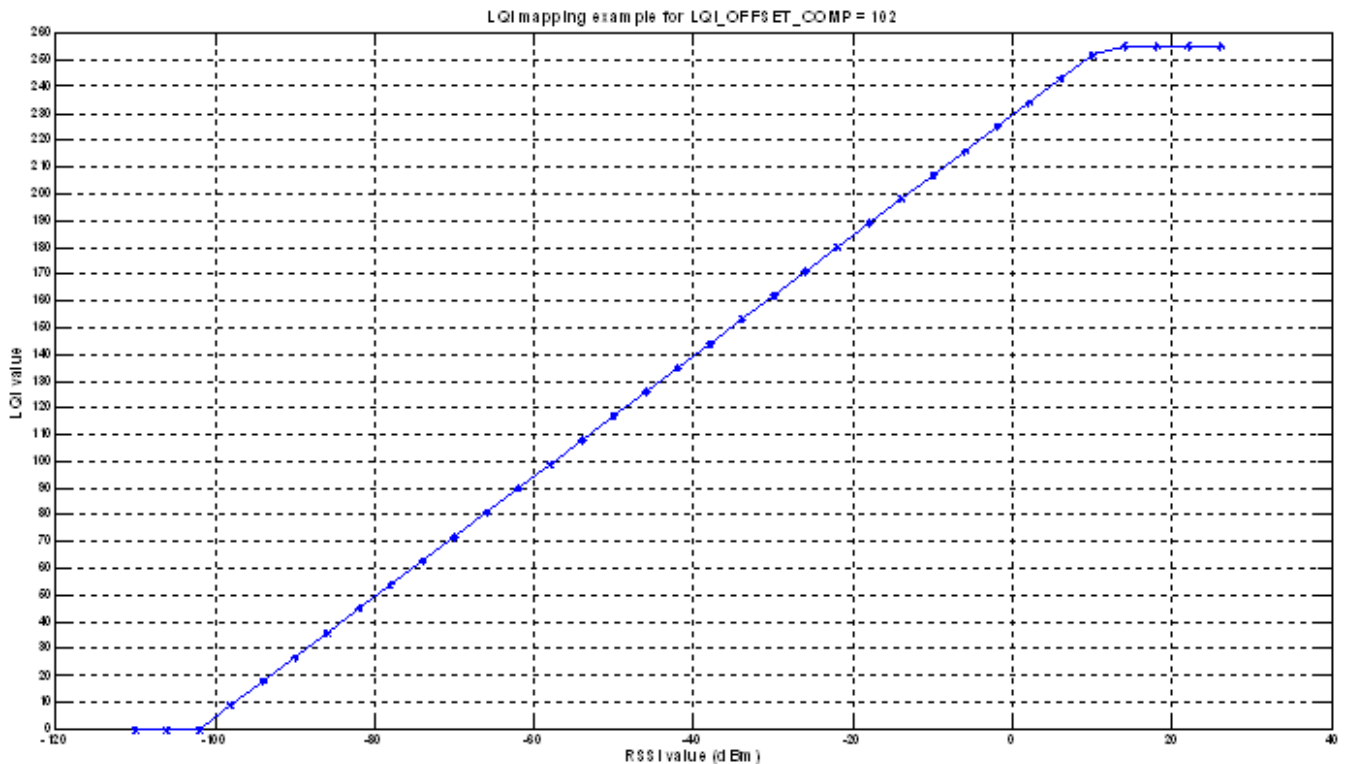

Figure 45-86. Plot of LQI vs. RSSI

45.6.2.11.3.7 Clocks

The CCA/ED/LQI module is a fully synchronous module. It has a single clock input **clk32m**. This clock input is driven by the RF Oscillator. The CCA/ED/LQI module has no asynchronous interfaces or clock domain crossings.

45.6.2.11.3.8 Reset

The CCA/ED/LQI module has a single, active-low, asynchronous reset input: **resetb**. At integration, this reset should be tied to the master reset for the entire transceiver. There are no special reset requirements.

45.6.2.11.3.9 Interrupts

The CCA/ED/LQI module does not generate any interrupts.

45.6.2.12 Fast Antenna Diversity (FAD)

FAD ALGORITHM

The Fast Antenna Diversity (FAD) mode, when enabled, will allow the choice between two antennae to be selected during the preamble search. By continually monitoring the received signal the FAD block will select the first antenna on which the received signal has a correlation factor above a predefined, programmable, threshold. This threshold is register programmable. The FAD accomplishes the antenna selection by sequentially switching between the two antenna testing for the presence of a suitably strong s_0 symbol, the first antenna to reach this condition is then selected for the reception of the packet.

The first antenna is monitored for a period equal to 1 symbol, $T_s = 16\mu\text{s}$, then the antenna monitoring is switched to the second antenna, $T_a = 8\mu\text{s}$. T_a is required to allow for the external pin diodes to turn on/off to select the antenna. $T_s + T_a = 24\mu\text{s}$ which allows enough time to be able to test both antenna within the first 4 preamble symbols, $T_{\text{fad}} = 3 \times T_a + 2 \times T_s = 56\mu\text{s}$, thus $T_{\text{fad}} < 4 \times T_s < 64\mu\text{s}$.

The FAD will continually switch between the two antenna until one is found which a sufficiently strong s_0 detection. By virtue of the fact that the FAD operation covers less than four s_0 symbols before the antenna is selected still allows the symbol demodulator to then detect at least four s_0 symbols before declaring "Preamble Detect".

The symbol correlator runs during the T_a period to calculate the max correlation factor for the antenna C_x . However since T_c is not guaranteed to coincide with 1 unique symbol T_s the correlation must be able to work across symbols. To accomplish this the correlator will rotate the s_0 PN chip code through its 32 combinations in order to find the s_0 symbol split across two adjacent symbols.

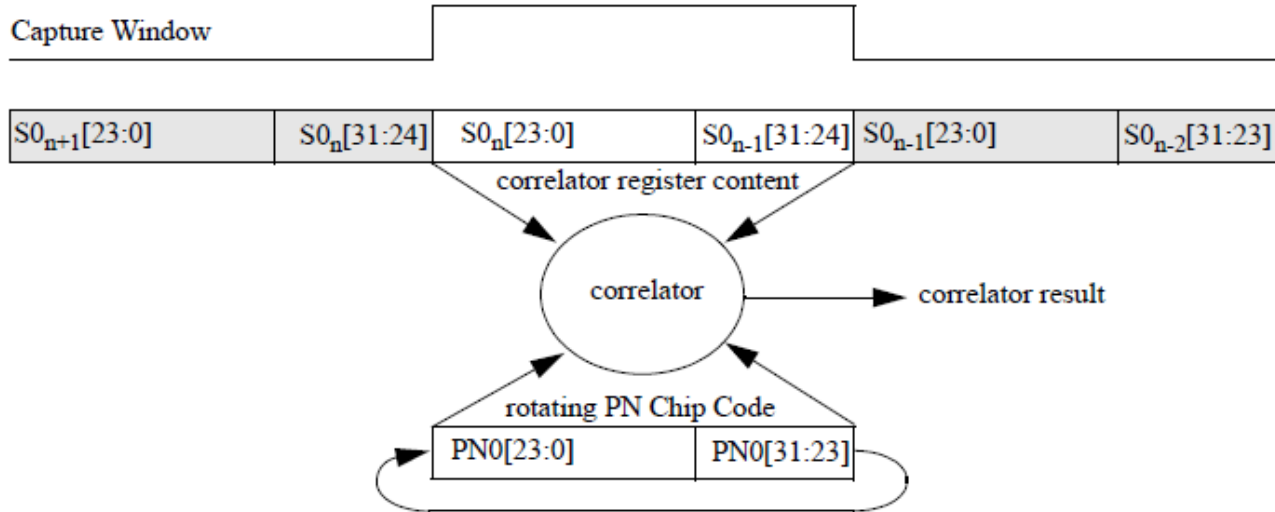

Figure 45-87. S0 Symbol Search

When the S_0 PN Chip code becomes aligned to the Symbol data within the correlator register a correlation peak is produced that is used to determine the Antenna has a sufficiently strong signal to be selected.

It is not possible to choose between Antenna with the highest correlation factor, since indeed 1 antenna could receive no signal and thus is not distinguishable from a clear channel. This being the case, the first antenna that meets the requirements, correlation factor above the defined threshold, is selected.

When a correlator peak is detected, a second check is done $\frac{1}{2}$ symbol later. A new peak should be detected with the rotation equal to $\frac{1}{2}$ symbols ± 2 chips. If it is the case the channel is validated and the classical $CORR_NVAL$ consecutive S_0 is used to certify a correct preamble, where $CORR_NVAL$ is the programmable number of consecutive S_0 symbols required to declare preamble detected.

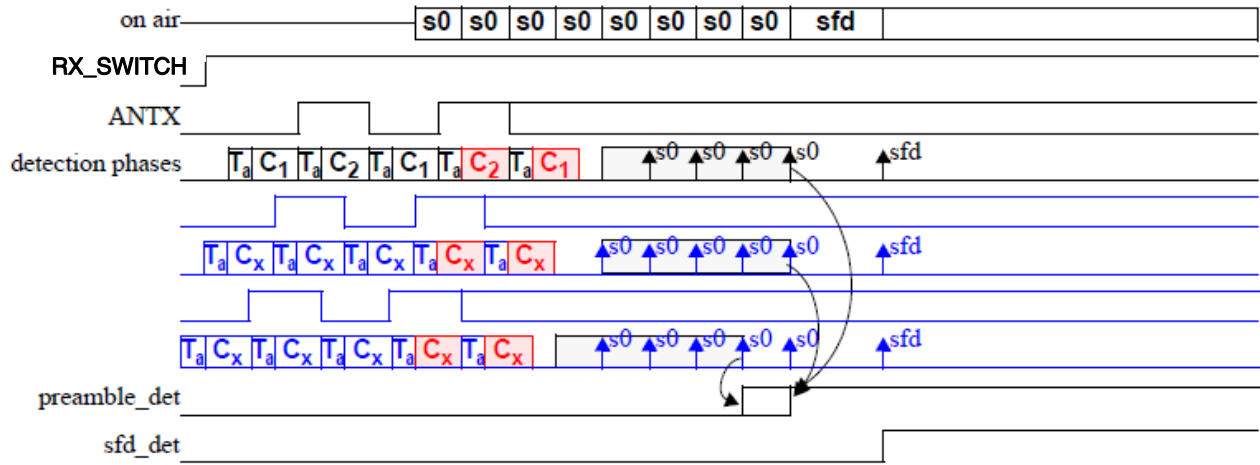
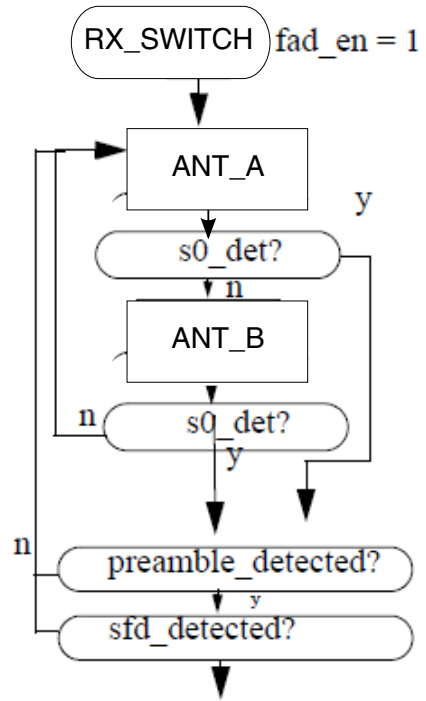
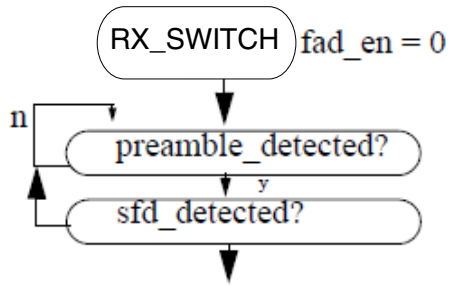

Figure 45-88. FAD Switching



The choice of the antenna is also used for the transmit. Since the `antx_out` value (the last antenna selected by the FAD algorithm) is kept after the end of the receive, the following TX will use the last best antenna found during the last receive. This is true also for any ensuing CCA or ED RX frame; the antenna selected will be the one selected by the FAD algorithm during the last successful preamble search. So a CCA will search for an empty channel on the best antenna chosen at the last RX. When FAD is enabled (`FAD_CTRL[FAD_EN]=1`), the state of the antenna can be ascertained at any time by reading the `FAD_CTRL[ANTX]` bit: 0 = ANT_A, 1 = ANT_B. When `FAD_CTRL[FAD_EN]=0`, antenna selection is placed under direct software control, and the value written to the `FAD_CTRL[ANTX]` bit becomes the selected antenna: 0 = ANT_A, 1 = ANT_B. The `FAD_CTRL` register resides in XCVR space.

FAD PIN INTERFACE

The FAD Pin Interface consists of 4 pins: ANT_A and ANT_B, described above; and TX_SWITCH and RX_SWITCH. All pins are outputs from the device. The switch outputs convey timing information to the external module directly interfacing to the antennae, and they also can be used to control an external LNA or PA, via use of a Front End Module, or FEM. The FAD Pin Interface offers multiple configurations that allow for a wide range of FEM control schemes. Each of the 4 FAD-related outputs can be configured to be in FAD or TSM mode; in FAD mode, ANT_A and ANT_B are controlled by the FAD state machine as described in the previous section; in TSM mode, ANT_A and ANT_B are pure timing outputs with programmable timing configurable in the TSM. The 4-bit register `FAD_CTRL[FAD_NOT_GPIO]` determines whether each FAD-related output is in FAD or TSM mode:

When FAD is enabled (`FAD_EN=1`), programming of the appropriate `TSM_TIMING` registers for TX_SWITCH and RX_SWITCH is mandatory, regardless of which FAD-pin Control Mode is selected, and even if the TX_SWITCH and RX_SWITCH pins are not used by the external module.

In FAD mode (`FAD_NOT_GPIO[0]=1`), ANT_A is controlled by the FAD algorithm, modified by the register settings {`ANTX_CTRLMODE`, `ANTX_EN`, and `ANTX_POL`}.

In FAD mode (`FAD_NOT_GPIO[1]=1`), ANT_B is controlled by the FAD algorithm, modified by the register settings {`ANTX_CTRLMODE`, `ANTX_EN`, and `ANTX_POL`}.

In FAD mode (`FAD_NOT_GPIO[2]=1`), TX_SWITCH output is derived from TSM output **gpio2_trig_en**, modified by the register settings {`ANTX_CTRLMODE`, `ANTX_EN`, and `ANTX_POL`}. Program `TSM_TIMING49` register to obtain the desired timing on the TX_SWITCH pin.

In FAD mode (FAD_NOT_GPIO[3]=1), RX_SWITCH output is derived from TSM output **gpio2_trig_en**, modified by the register settings {ANTX_CTRLMODE, ANTX_EN, and ANTX_POL}. Program TSM_TIMING50 register to obtain the desired timing on the RX_SWITCH pin.

In TSM mode, ANT_A and ANT_B become pure TSM timing-controlled outputs, similar to TX_SWITCH and RX_SWITCH, and with independently-controlled timing and capable of providing signalling in TX mode, RX mode, or both; for pins in TSM mode, the ANTX_CTRLMODE, ANTX_EN, and ANTX_POL register settings have no effect.

In TSM mode (FAD_NOT_GPIO[0]=0), ANT_A output is a pure timing signal, derived from TSM output **gpio0_trig_en**. Thus, program TSM_TIMING47 register to obtain the desired timing on the ANT_A pin.

In TSM mode (FAD_NOT_GPIO[1]=0), ANT_B output is a pure timing signal, derived from TSM output **gpio1_trig_en**. Thus, program TSM_TIMING48 register to obtain the desired timing on the ANT_B pin.

In TSM mode (FAD_NOT_GPIO[2]=0), TX_SWITCH output is derived from TSM output **gpio2_trig_en**. Program TSM_TIMING49 register to obtain the desired timing on the TX_SWITCH pin.

In TSM mode (FAD_NOT_GPIO[3]=0), RX_SWITCH output is derived from TSM output **gpio3_trig_en**. Program TSM_TIMING50 register to obtain the desired timing on the RX_SWITCH pin.

The following diagram illustrates the FAD pinout, register controls, and FAD/TSM-mode multiplexing.

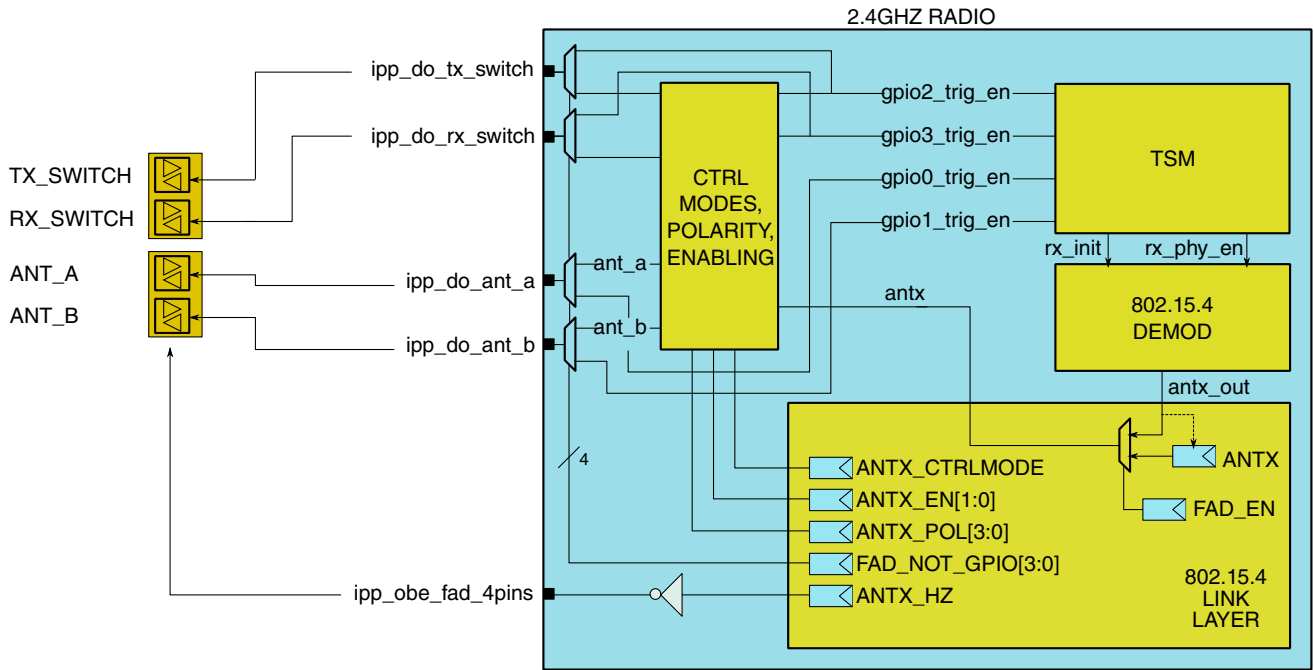

Figure 45-90. FAD Pin Interface

FAD REGISTERS

The following table describes the programmable registers which control FAD

Table 45-39. FAD Registers

| Field | R/W | Description |
|---------------|-----|--|
| ANTX_CTRLMODE | rw | <p>FAD control mode- selects the single or dual mode</p> <p>0 : single mode.</p> <p>ANT_A = antx_out</p> <p>TXSWITCH = gpio2_trig_en</p> <p>RXSWITCH= (gpio2_trig_en OR gpio3_trig_en)</p> <p>1:dual mode:</p> <p>ANTA = antx_out AND (gpio2_trig_en OR gpio3_trig_en)</p> <p>ANTB = NOT(antx_out) AND (gpio2_trig_en OR gpio3_trig_en)</p> <p>TX_SWITCH = gpio2_trig_en</p> <p>RX_SWITCH = gpio3_trig_en</p> |
| ANTX_EN[1:0] | rw | <p>FAD Pin Enable-</p> <p>00: all disabled</p> <p>01:only RX_SWITCH/TX_SWITCH enabled</p> |

Table continues on the next page...

Table 45-39. FAD Registers (continued)

| Field | R/W | Description |
|-------------------|---------|--|
| | | 10: only ANT_A/ANT_B enabled 11: all enabled |
| ANTX_POL[3:0] | rw | Antenna controls mode- Control the polarity of the FAD pins: ANTX_pol<0>=1 : invert the ANT_A output ANTX_pol<1>=1 : invert the ANT_B output ANTX_pol<2>=1 : invert the TX_SWITCH output ANTX_pol<3>=1 : invert the RX_SWITCH output |
| ANTX_HZ | rw | FAD controls high impedance- Set ANTA,ANTB,RXSWITCH and TXSWITCH in high impedance |
| FAD_NOT_GPIO[3:0] | rw | xxx1: The ANT_A pad is controlled by the antenna-selection algorithm, modified by the register settings above {ANTX_CTRLMODE, ANTX_EN, ANTX_POL} xxx0: The ANT_A pad is controlled directly by the TSM output gpio0_trig_en xx1x: The ANT_B pad is controlled by the antenna-selection algorithm, modified by the register settings above {ANTX_CTRLMODE, ANTX_EN, ANTX_POL} xx0x: The ANT_B pad is controlled directly by the TSM output gpio1_trig_en x1xx: The TX_SWITCH pad is controlled by the antenna-selection algorithm, modified by the register settings above {ANTX_CTRLMODE, ANTX_EN, ANTX_POL} x0xx: The TX_SWITCH pad is controlled directly by the TSM output gpio2_trig_en 1xxx: The RX_SWITCH pad is controlled by the antenna-selection algorithm, modified by the register settings above {ANTX_CTRLMODE, ANTX_EN, ANTX_POL} 0xxx: The RX_SWITCH pad is controlled directly by the TSM output gpio3_trig_en |
| FAD_EN | rw | FAD Enable- 1: enables the Fast Antenna Diversity State Machine for 802.15.4, and places the ANTX state output under the control of the FAD algorithm. 0: disables the Fast Antenna Diversity State Machine, and the ANTX state output reflects the value that was last written to the ANTX bit by the host (direct software control). |
| ANTX | special | Antenna Selection State- If FAD_EN=0, the ANTX bit is used to take manual (software) control of the antenna selection, overriding the FAD state machine; in this case, the readback value of ANTX is whatever was last written by the host. |

Table continues on the next page...

Table 45-39. FAD Registers (continued)

| Field | R/W | Description |
|--------------|-----|--|
| | | If FAD_EN=1, the FAD state machine controls antenna selection, and the readback value of ANTX reflects the machine-selected antenna: 0 = ANT_A, 1 = ANT_B. |
| FAD_THR[7:0] | rw | FAD Correlator Threshold- Correlator threshold at which the FAD will select the antenna. |

Note: All register bits and fields listed in the table above, reside in the FAD_CTRL register, except FAD_THR, which resides in a register of the same name. Both FAD_CTRL and FAD_THR registers reside in XCVR address space.

FRONT END MODULE

In 802.15.4 systems, the Radio Frequency (RF) Front-End Module is one of the most critical parts. Acting as an interface between the antenna and RF transceiver, the RF front-end module, or FEM, includes sensitive components such as an antenna Low Noise Amplifier (LNA), power amplifiers (PA), antenna tuning switches, and a power management unit.

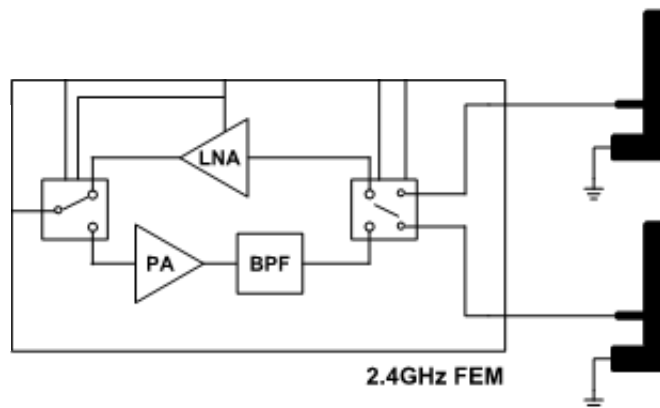
**Figure 45-91. FEM Block Diagram**

To accommodate multiple FEM interfaces and control schemes, Fast Antenna Diversity incorporates 2 Antenna Pin Control Modes, which are governed by the register control bit ANTX_CTRLMODE

Some FEM devices use a single input pin to switch the antenna selection. This is called single-mode operation. Operate Fast Antenna Diversity in this mode by programming ANTX_CTRLMODE=0. A timing diagram of single-mode operation is shown below

(note: FAD output ANT_B is not used). In this example, one packet is received on Antenna A, followed by another packet received on Antenna B. Both packets require an auto-Acknowledge packet to be transmitted immediately following reception.

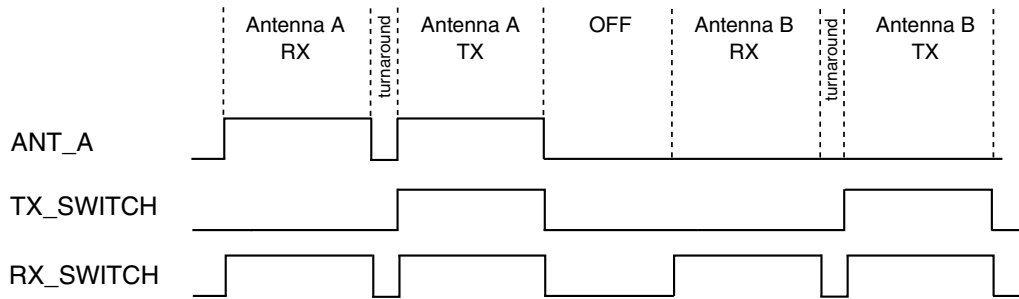

Figure 45-92. FAD Single Mode Timing

An example FEM Interface diagram, with FAD operated in single mode, is shown below.

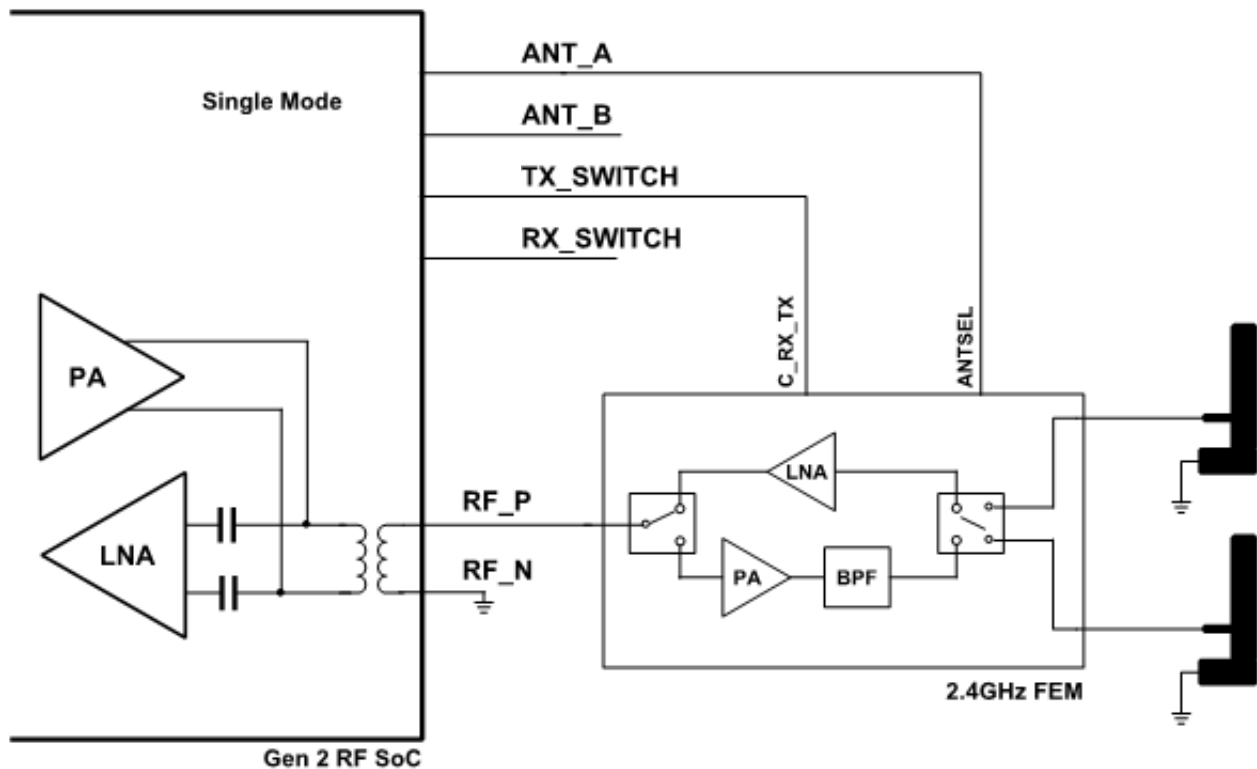

Figure 45-93. FEM Interface Single Mode

Other FEM devices use 2 input pins to switch the antenna selection. This is called dual-mode operation. Operate Fast Antenna Diversity in this mode by programming ANT_X_CTRLMODE=1. A timing diagram of dual-mode operation is shown below. In

this example, one packet is received on Antenna A, followed by another packet received on Antenna B. Both packets require an auto-Acknowledge packet to be transmitted immediately following reception.

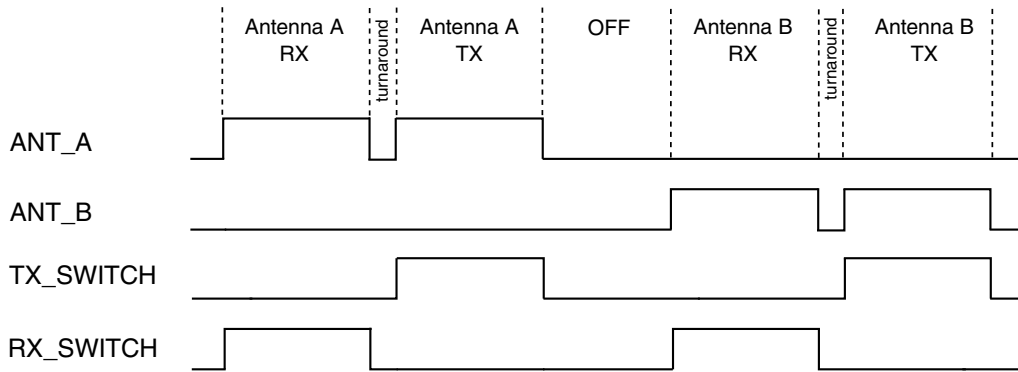

Figure 45-94. FAD Dual Mode Timing

An example FEM Interface diagram, with FAD operated in dual mode, is shown below.

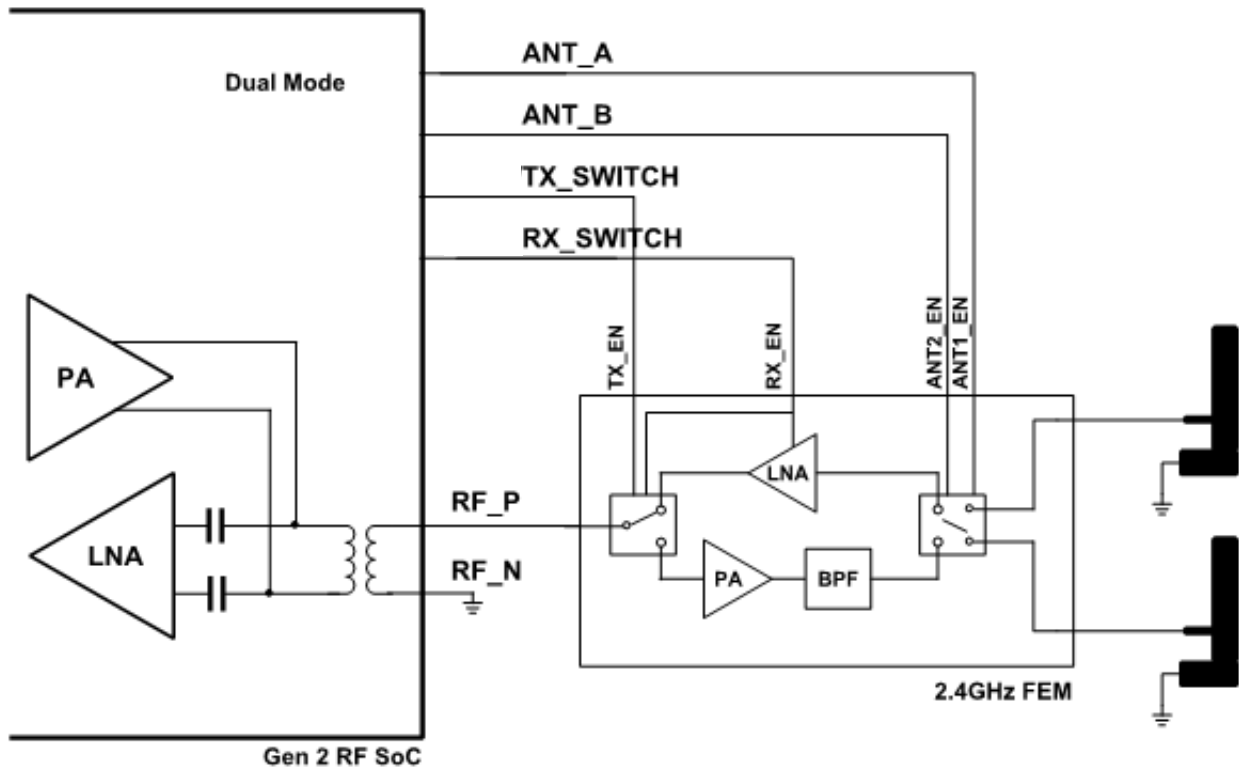

Figure 45-95. FEM Interface Dual Mode

Other FEM use cases, include external PA only, external LNA only, or external PA plus LNA. In such cases, ANT_A and ANT_B are not required, FAD can be disabled, and TX_SWITCH and RX_SWITCH pins can be operated in TSM mode (pure timing signals). This is called Single Antenna configuration. An example FEM interface diagram illustrating such a use case, is shown below.

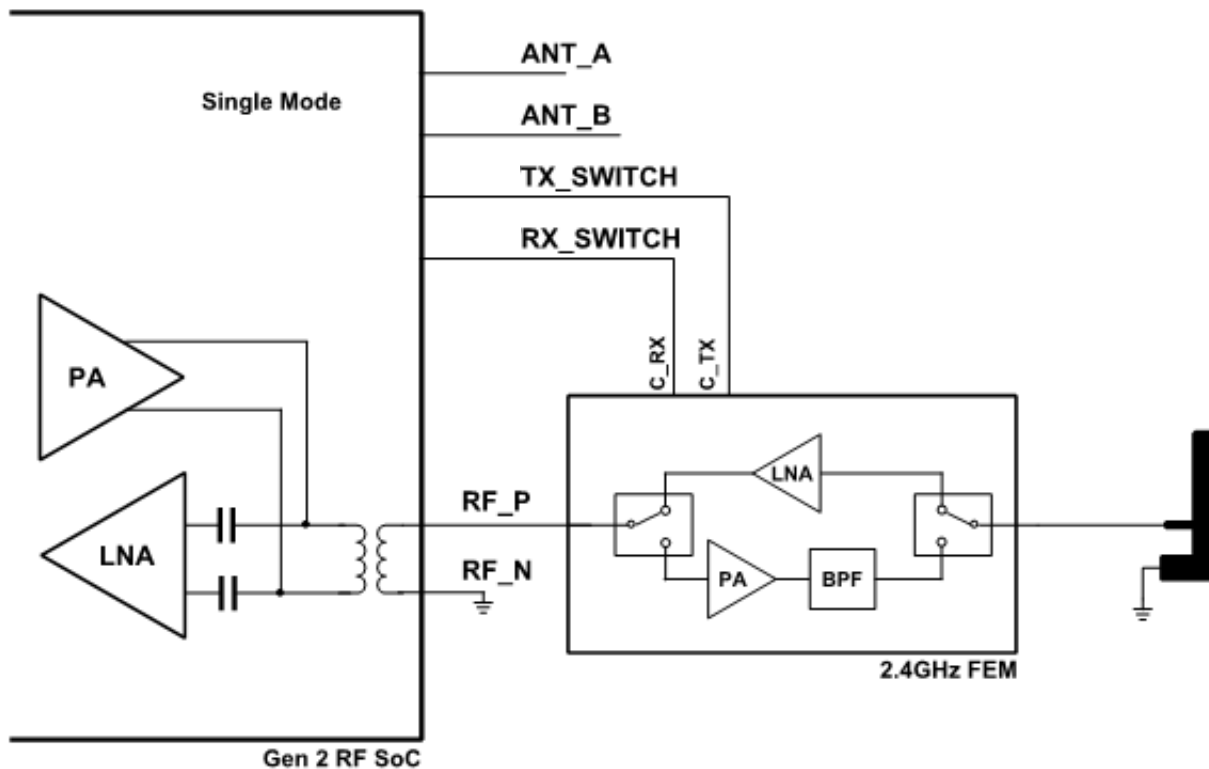

Figure 45-96. FEM Interface Single Antenna Configuration

45.6.2.13 Interrupts

45.6.2.13.1 Introduction

This Block Guide describes the 802.15.4 Interrupt Architecture.

The 802.15.4 Link Layer has a single, active high, interrupt line (ipi_int_zigbee) to the MCU. Internally, the Link Layer has 12 interrupt sources, as shown in the following table:

| 802.15.4 Interrupt Sources |
|----------------------------|
| SEQIRQ |

Table continues on the next page...

| 802.15.4 Interrupt Sources |
|----------------------------|
| TXIRQ |
| RXIRQ |
| CCAIRQ |
| RXWTRMRKIRQ |
| FILTERFAIL_IRQ |
| PLL_UNLOCK_IRQ |
| TMR1IRQ |
| TMR2IRQ |
| TMR3IRQ |
| TMR4IRQ |
| TSM_IRQ |

Any or all of the interrupt sources, can be enabled to cause an assertion on `ipi_int_zigbee`. Each interrupt source has its own interrupt status bit in 802.15.4 register space. Each interrupt source is individually maskable (each has its own MASK bit), so that each interrupt source can be individual enabled to trigger an assertion on `ipi_int_zigbee`. There is also a global interrupt mask, `TRCV_MSK`, which can enable/disable all `ipi_int_zigbee` assertions by programming a single masking bit. All interrupt status bits (except `TSM_IRQ`) use a write-1-to-clear protocol. Interrupt status bits are not affected by reads. The `ipi_int_zigbee` pin is a level-sensitive interrupt indicator to the MCU; on an interrupt, `ipi_int_zigbee` will remain asserted until all active interrupt sources are cleared or masked.

45.6.2.13.1.1 Features

- 12 interrupt sources (interrupt status bits)
- each interrupt source individually maskable
- each interrupt source is individually write-1-to-clear.
- interrupts remain asserted until cleared.

45.6.2.13.2 Memory Map and register definition

Numerous register bits are provided to control 802.15.4 interrupt behaviour. The registers referred to below (`IRQSTS1`, `IRQSTS2`, `IRQSTS3`, `PHY_CTRL2`, `PHY_CTRL3`, and `PHY_CTRL4`) all reside in the 802.15.4 Address space.

| Field | R/W | Description | Default |
|--------|--------|--|---------|
| SEQIRQ | r/w1tc | 1: A Sequencer Interrupt has occurred 0: A Sequencer Interrupt has not occurred | - |
| TXIRQ | r/w1tc | 1: A TX Interrupt has occurred | - |

Table continues on the next page...

Link Layer

| Field | R/W | Description | Default |
|----------------|--------|---|---------|
| | | 0: A TX Interrupt has not occurred | |
| RXIRQ | r/w1tc | 1: A RX Interrupt has occurred 0: A RX Interrupt has not occurred | - |
| CCAIRQ | r/w1tc | 1: A CCA Interrupt has occurred 0: A CCA Interrupt has not occurred | - |
| RXWTRMRKIRQ | r/w1tc | 1: A RX Watermark Interrupt has occurred 0: A RX Watermark Interrupt has not occurred | - |
| FILTERFAIL_IRQ | r/w1tc | 1: A Filter Fail Interrupt has occurred 0: A Filter Fail Interrupt has not occurred | - |
| PLL_UNLOCK_IRQ | r/w1tc | 1: A PLL Unlock Interrupt has occurred 0: A PLL Unlock Interrupt has not occurred | - |
| TMR1IRQ | r/w1tc | 1: A TMR1 Interrupt has occurred 0: A TMR1 Interrupt has not occurred | - |
| TMR2IRQ | r/w1tc | 1: A TMR2 Interrupt has occurred 0: A TMR2 Interrupt has not occurred | - |
| TMR3IRQ | r/w1tc | 1: A TMR3 Interrupt has occurred 0: A TMR3 Interrupt has not occurred | - |
| TMR4IRQ | r/w1tc | 1: A TMR4 Interrupt has occurred 0: A TMR4 Interrupt has not occurred | - |
| TSM_IRQ | r | 1: A TSM Interrupt has occurred 0: A TSM Interrupt has not occurred | - |
| TMR1MSK | rw | 1: Mask TMR1 Interrupt from asserting ipi_int_zigbee 0: Enable TMR1 Interrupt to assert ipi_int_zigbee | 1 |
| TMR2MSK | rw | 1: Mask TMR2 Interrupt from asserting ipi_int_zigbee 0: Enable TMR2 Interrupt to assert ipi_int_zigbee | 1 |
| TMR3MSK | rw | 1: Mask TMR3 Interrupt from asserting ipi_int_zigbee 0: Enable TMR3 Interrupt to assert ipi_int_zigbee | 1 |
| TMR4MSK | rw | 1: Mask TMR4 Interrupt from asserting ipi_int_zigbee 0: Enable TMR4 Interrupt to assert ipi_int_zigbee | 1 |
| SEQMSK | rw | 1: Mask Sequencer Interrupt from asserting ipi_int_zigbee 0: Enable Sequencer Interrupt to assert ipi_int_zigbee | 1 |
| TXMSK | rw | 1: Mask TX Interrupt from asserting ipi_int_zigbee 0: Enable TX Interrupt to assert ipi_int_zigbee | 1 |
| RXMSK | rw | 1: Mask RX Interrupt from asserting ipi_int_zigbee 0: Enable RX Interrupt to assert ipi_int_zigbee | 1 |
| CCAMSK | rw | 1: Mask CCA Interrupt from asserting ipi_int_zigbee 0: Enable CCA Interrupt to assert ipi_int_zigbee | 1 |
| RX_WMRK_MSK | rw | 1: Mask RX Watermark Interrupt from asserting ipi_int_zigbee 0: Enable RX Watermark Interrupt to assert ipi_int_zigbee | 1 |
| FILTERFAIL_MSK | rw | 1: Mask Filter Fail Interrupt from asserting ipi_int_zigbee | 1 |

Table continues on the next page...

| Field | R/W | Description | Default |
|------------------|-----|--|---------|
| | | 0: Enable Filter Fail Interrupt to assert ipi_int_zigbee | |
| PLL_UNLOCK_MSK | rw | 1: Mask PLL Unlock Interrupt from asserting ipi_int_zigbee 0: Enable PLL Unlock Interrupt to assert ipi_int_zigbee | 1 |
| TSM_MSK | rw | 1: Mask TSM Interrupt from asserting ipi_int_zigbee 0: Enable TSM Interrupt to assert ipi_int_zigbee | 1 |
| TRCV_MSK | rw | 1: Mask all Interrupts from asserting ipi_int_zigbee 0: Enable any Interrupt to assert ipi_int_zigbee | 0 |
| T1CMP[23:0] | rw | TMR1 compare value. If TMR1CMP_EN=1 and the Event Timer matches this value, TMR1IRQ is set. | 0xFFF |
| T2CMP[23:0] | rw | TMR2 compare value. If TMR2CMP_EN=1 and the Event Timer matches this value, TMR2IRQ is set. | 0xFFF |
| T2PRIMECMP[15:0] | rw | TMR2-prime compare value. If TMR2CMP_EN=1 and TC2PRIME_EN=1 and the lower 16 bits of Event Timer matches this value, TMR2IRQ is set. | 0xFF |
| T3CMP[23:0] | rw | TMR3 compare value. If TMR3CMP_EN=1 and the Event Timer matches this value, TMR3IRQ is set. | 0xFFF |
| T4CMP[23:0] | rw | TMR4 compare value. If TMR4CMP_EN=1 and the Event Timer matches this value, TMR4IRQ is set. | 0xFFF |
| TMR1CMP_EN | rw | 1: Allow an Event Timer Match to T1CMP to set TMR1IRQ 0: Don't allow an Event Timer Match to T1CMP to set TMR1IRQ | 0 |
| TMR2CMP_EN | rw | 1: Allow an Event Timer Match to T2CMP or T2PRIMECMP to set TMR2IRQ 0: Don't allow an Event Timer Match to T2CMP or T2PRIMECMP to set TMR2IRQ | 0 |
| TMR3CMP_EN | rw | 1: Allow an Event Timer Match to T3CMP to set TMR3IRQ 0: Don't allow an Event Timer Match to T3CMP to set TMR3IRQ | 0 |
| TMR4CMP_EN | rw | 1: Allow an Event Timer Match to T4CMP to set TMR4IRQ 0: Don't allow an Event Timer Match to T4CMP to set TMR4IRQ | 0 |
| TC2PRIME_EN | rw | 1: Allow a match of the lower 16 bits of Event Timer to T2PRIMECMP to set TMR2IRQ 0: Don't allow a match of the lower 16 bits of Event Timer to T2PRIMECMP to set TMR2IRQ | 0 |
| RX_WTR_MARK[7:0] | rw | Receive byte count (octets) needed to trigger a RXWTRMRKIRQ interrupt . A setting of 0 generates an interrupt at end of the Frame Length field (first byte after SFD). A setting of 1 generates an interrupt after the first byte of Frame Control Field, etc. | 0xFF |

45.6.2.13.3 Functional description

45.6.2.13.3.1 Interrupt Status Bit Structure

The 802.15.4 Link Layer has 12 interrupt sources, each represented in the register map by an interrupt status bit. All interrupt status bits share a common, generic structure. If a particular interrupt source is enabled, a “TRIGGERING EVENT” for that interrupt

source, will always set the status bit. A write-1-to-clear input from the IPS bus, will clear the status bit, but only if there is not a simultaneous triggering event. The triggering event prevails over a software clear attempt, if both events coincide. The clock gate guarantees that the status bit only sees a clock when either a triggering event occurs, or a write-1-to-clear pulse arrives from the IPS bus. This reduces interrupt status bit power consumption to an absolute minimum. The common interrupt status bit structure is shown in the following diagram.

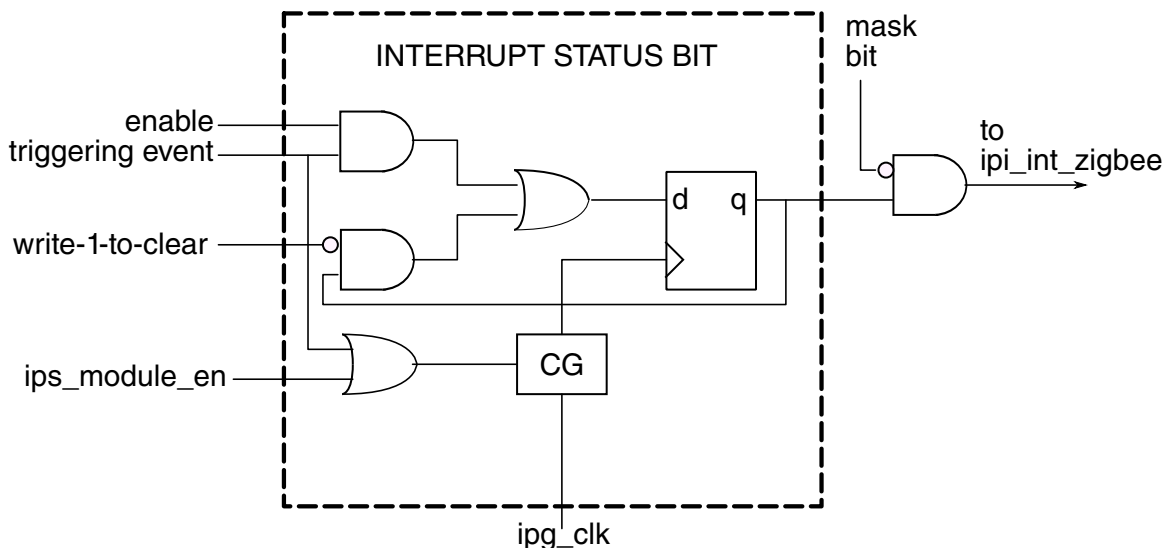

Figure 45-97. Interrupt Status Bit

Note that for any 802.15.4 interrupt source, if the triggering event occurs, the Interrupt Status Bit will be set regardless of the state of the corresponding MASK bit. If any of the 12 interrupts is to be ignored, software should set the corresponding MASK bit, and apply the appropriate bit mask when reading the IRQSTS1, IRQSTS2, or IRQSTS3 register, to mask out the unwanted status bit.

45.6.2.13.3.2 802.15.4 Interrupt Architecture

The 12 802.15.4 interrupt sources (status bits) are combined with their individual MASK bits, and then logically OR'ed together, in sum-of-products fashion, to generate single line to the MCU: ipi_int_zigbee. A global mask bit, TRCV_MSK, can enable or disable ipi_int_zigbee altogether. There is no prioritization of interrupt sources, they all have equal weight. The ipi_int_zigbee output is a level-sensitive indicator and will remain asserted until all interrupt status bits are cleared (or the corresponding mask bits set). The following diagram depicts the 802.15.4 Interrupt Architecture.

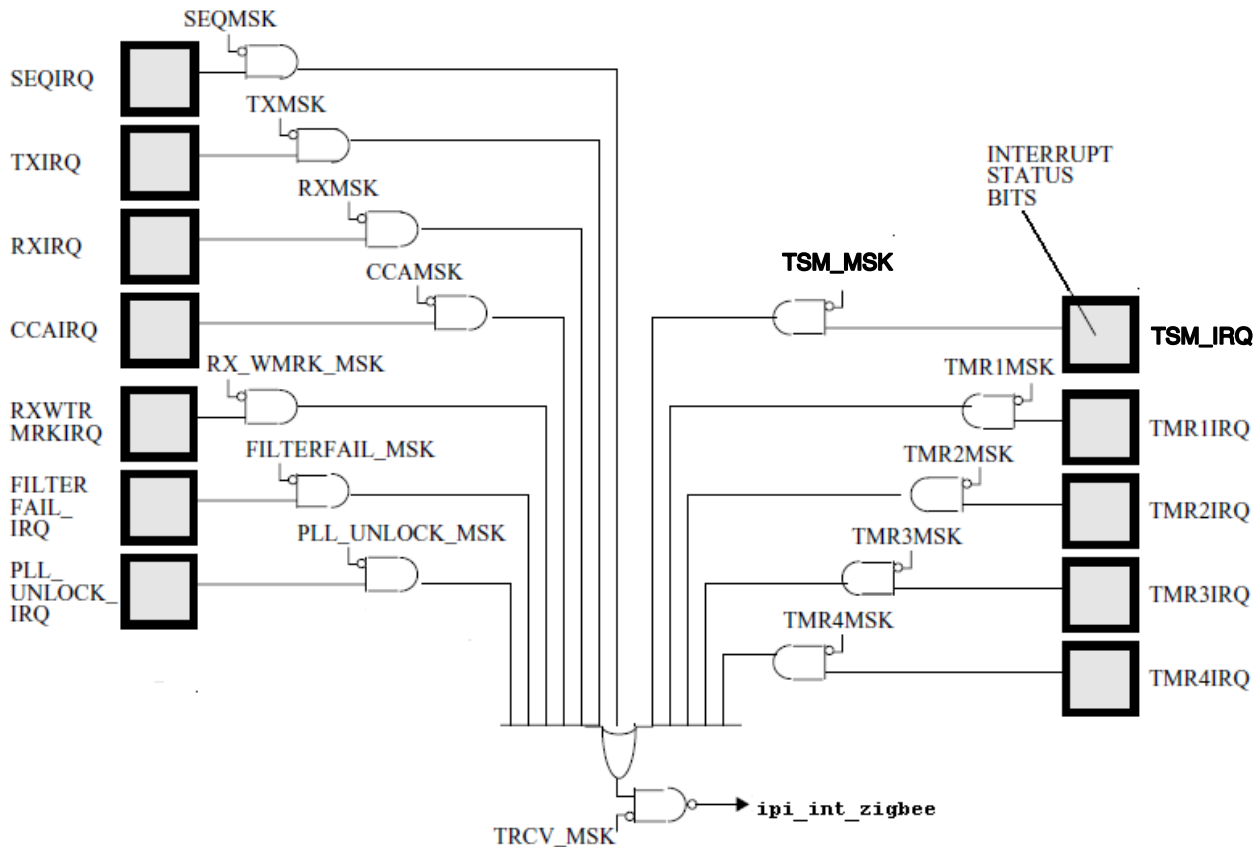

Figure 45-98. 802.15.4 Interrupt Architecture

45.6.2.13.3.3 Clearing Interrupts

All interrupt status bit use a write-1-to-clear protocol. Writing a ‘1’ to the interrupt status bit, in the IRQSTS1, IRQSTS2, or IRQSTS3 register, clears the offending interrupt. Writing a ‘0’ to an interrupt status bit has no effect on the bit. Interrupt status bits are not affected by reads.

Note: The TSM interrupt is an exception from the interrupt-clearing rules stated above. See Section [TSM Interrupt](#) below.

45.6.2.13.3.4 Timer Interrupts

The 802.15.4 Link Layer features a 24-bit Event Timer (see Section [Event Timer](#), of this Block Guide). The Link Layer has 4 Timer interrupts (TMR1IRQ, TMR2IRQ, TMR3IRQ, and TMR4IRQ), each with its own 24-bit compare register (T1CMP, T2CMP, T3CMP, and T4CMP), and each with its own compare enable (TMR1CMP_EN, TMR2CMP_EN, TMR3CMP_EN, and TMR4CMP_EN). For each timer compare enable,

if the bit is set, a match on the respective 24-bit compare value to the Event Timer will cause the corresponding interrupt status bit to become set. If the compare enable is low, Event Timer matches won't cause the corresponding interrupt status bit to become set.

In addition, a 16-bit T2PRIMECMP compare value is provided, along with a compare-enable bit: TC2PRIME_EN. When TC2PRIME_EN is set (and TMR2CMP_EN is also set), a match on T2PRIMECMP with the *lower 16 bits of Event Timer*, will cause TMR2IRQ to become set, rather than a full 24-bit compare.

45.6.2.13.3.5 PLL Unlock Interrupt

When an PLL unlock event occurs during a 802.15.4 autosequence, the PLL_UNLOCK_IRQ status bit will become set. The 802.15.4 Sequence Manager will begin monitoring for PLL unlock only after a complete transceiver warmup has occurred; unlocks which occur during warmup will not cause a PLL_UNLOCK_IRQ. A PLL unlock which occurs after the warmup period, can be enabled to cause a sequence abort. (See the 802.15.4 Sequence Manager Block Guide for more details).

45.6.2.13.3.6 Filterfail Interrupt

Filterfail interrupt will occur during packet reception, when a packet fails filtering rules (see the Packet Processor Block Guide for more details). On a Filterfail interrupt, the FILTERFAIL_CODE register can be read to ascertain more information about the nature of the filter failure. Filterfail interrupt is not expected to be widely used in mission modes; it has been provided primarily for debug purposes.

45.6.2.13.3.7 RX Watermark Interrupt

RX Watermark interrupt will occur during packet reception, when the number of received bytes matches the contents of the RX_WTR_MARK register, minus 1. For the purpose of defining RX_WTR_MARK, the first byte received is the Frame Length field (PHR). The second byte received is the least-significant byte of Frame Control Field, etc. For example, to cause an RX Watermark Interrupt to occur after the 10th received byte, set RX_WTR_MARK=11.

45.6.2.13.3.8 CCA Interrupt

CCA interrupts occur at the end of CCA and ED measurement intervals. The presence, and timing, of CCA interrupts varies based on which autosequence is engaged. See the ZSM Sequence Manager Block Guide for more details on when to expect a CCAIRQ for each of the relevant autosequences (Sequences C, T, TR, and CCA).

45.6.2.13.3.9 RX Interrupt

RX interrupts occur at the end of an RX operation. An RX operation can be a standalone Sequence R, or the “R” portion of a Sequence TR. An RXIRQ, in combination with a SEQIRQ, is considered a “Data Indication”. RX interrupts are not generated on packets which fail FCS (CRC check), or fail packet filtering. Either of these two conditions results in an RX recycle back to the preamble-search state. To prevent RX recycling on packets which fail filtering or FCS, set the NO_RX_RECYCLE bit of the SEQ_MGR_CTRL register to 1. To receive a Data Indication (including RXIRQ) on packets which fail CRC, clear the CRC_MSK bit of the PHY_CTR2 register to 0. To inhibit packet filtering and enable Data Indication on packets which would otherwise fail packet filtering rules, set the PROMISCUOUS bit of the PHY_CTRL4 register to 1.

45.6.2.13.3.10 TX Interrupt

TX interrupts occur at the end of a TX operation. An TX operation can be a standalone Sequence T, the “T” portion of a Sequence TR, or the auto-TXACK portion of a Sequence R with AUTOACK=1.

45.6.2.13.3.11 Sequencer Interrupt

The Sequencer Interrupt (SEQIRQ), indicates that an autosequence has completed, and the 802.15.4 Sequence Manager has returned to its idle state. A SEQIRQ will *always* occur at the end of an autosequence, even if the autosequence terminated abnormally (such as a Software Abort, a TC3 Timeout, or a PLL Unlock Abort). **Note:** the ABORT_STS register can be read to determine which of these abnormal terminations occurred, if any. The SEQIRQ always occurs whenever the Sequence Manager transitions from non-idle to idle state. When SEQIRQ occurs, software can be sure that the Sequence Manager is in its idle state, and a new sequence can be programmed immediately.

45.6.2.13.3.12 TSM Interrupt

TSM_IRQ is a debug feature, enabling the Transceiver Sequence Manager (TSM) to generate an interrupt at any point in a TX or RX Warmup. TSM is a multipurpose hardware resource shared by all of the protocol engines in the SoC. Thus, TSM does not have its own interrupts; its interrupts are assigned to whichever link layer controller is currently executing an RF operation. The 802.15.4 interrupt TSM_IRQ is asserted when the TSM interrupt is enabled in the transceiver's TSM_CTRL register, and the TSM interrupt asserts during an 802.15.4 TX or RX Warmup. The TSM Interrupt status bit in the IRQSTS register of 802.15.4 space is read-only. It is a logical OR of the 2 TSM_IRQ

interrupt status bits of the XCVR_STATUS register in XCVR address space. and the asserted status bit(s) should be cleared there. There is no intended mission-mode use for TSM_IRQ. See the TSM Block Guide for more details.

45.6.2.14 BSM

45.6.2.14.1 Introduction

The 802.15.4 Link Layer features an optional Bit Streaming Mode. When activated, this feature allows all 802.15.4 packet data, received or transmitted, to be serialized and shifted out to external hardware for further processing.

45.6.2.14.1.1 Overview

Bit Streaming Mode (BSM), when activated, allows all 802.15.4 packet data, received or transmitted, to be serialized and shifted out to external hardware for further processing. A simple development system can be crafted to consume the BSM outputs and generate packet trace data for all 802.15.4 traffic appearing on a network, within range of the device. This enables PAN-level monitoring and debugging. BSM uses a simple, synchronous 3-wire interface, consisting of BSM_CLK, BSM_DATA, and BSM_FRAME outputs. Packet data is shifted out serially, at the 802.15.4 bit rate (250 kHz). Signalling is provided on BSM_FRAME to indicate start-of-packet and end-of-packet conditions, and to distinguish between TX and RX packet types. BSM_DATA and BSM_FRAME are synchronous to BSM_CLK. BSM_DATA and BSM_FRAME are shifted out on falling BSM_CLK, and are intended to be captured on rising BSM_CLK. A single control bit activates or deactivates BSM. Aside from controlling this bit, BSM requires no software support, and there is no software insight into BSM status while the mode is engaged. The BSM outputs are multiplexed with GPIO, so that the pins are available for general purpose use when BSM is disabled. BSM does not interfere with 802.15.4 packet processing, or transmit data handling, in any way; it is merely a passive monitoring and debugging tool. BSM, when engaged, will not measurably increase current consumption, since the BSM module operates at a 500 kHz clock rate.

45.6.2.14.1.2 Features

BSM includes the following features:

- Enables monitoring and debugging of all network traffic within range of the device
- Simple, synchronous 3-wire interface facilitates external hardware development
- Low power consumption

- Non-intrusive design.
- Minimal software support required

45.6.2.14.1.3 Block Diagram

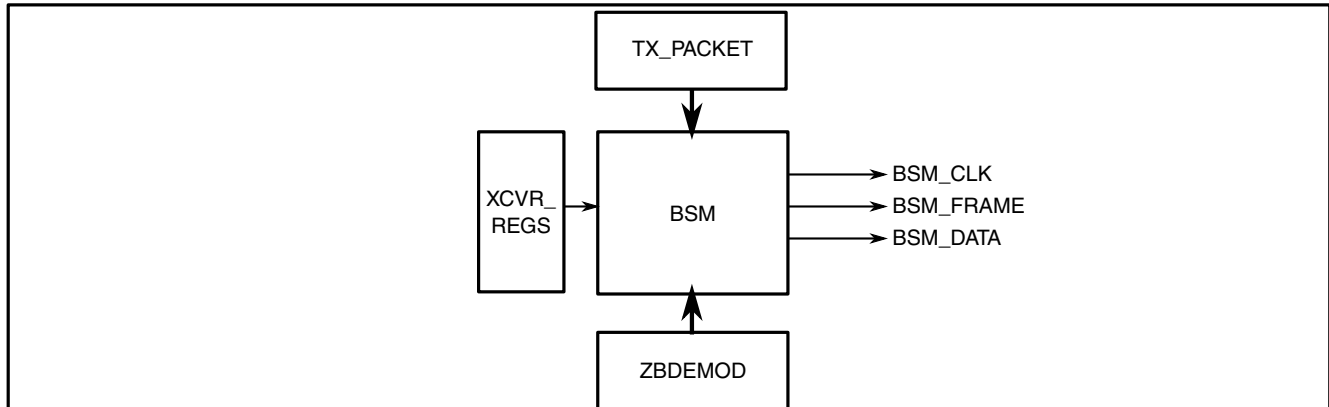

Figure 45-99. Block diagram

45.6.2.14.2 Memory Map and register definition

A single control bit, BSM_EN activates and deactivates BSM.

The control bit BSM_EN, is in the BSM Control Register (BSM_CTRL), which resides in 802.15.4 address space.

BSM_EN activates Bit Streaming Mode. Default is disabled. BSM mode, when enabled, allows all TX and RX packet data to appear on the 3-wire BSM interface as described in the following section.

45.6.2.14.3 Functional description

Bit Streaming Mode is enabled by setting BSM_EN=1 in the BSM_CTRL register. Once engaged, BSM will begin tracking sequence manager state, to determine when a packet is to be transmitted or received. If there is no sequence underway, or the sequence manager is in a state that does not involve transmission or reception (e.g., CCA), there will be no activity on the BSM outputs; they will be held low by hardware. Once a packet transmission or reception begins, the interface will automatically activate. The BSM_CLK will start and a single high pulse (1 BSM_CLK long) on BSM_FRAME, with BSM_DATA also high, will indicate a start-of-packet condition. The state of BSM_DATA, following the BSM_FRAME assertion, will indicate whether the packet which follows, is a TX or RX packet (1=TX, 0 = RX). The packet contents follow, starting with the next BSM_CLK period. The 802.15.4 preamble and SFD (start-of-frame delimiter), are not shifted out on BSM, since they are the same for every packet. A start-

of-packet condition implies that preamble and SFD have been transmitted (for TX packets), or correctly received (for RX packets). After the start-of-packet bit and the TX/RX indicator bit, BSM packet shifting begins with the Frame Length byte (802.15.4 PHR), followed by the packet payload (802.15.4 PSDU). The MAC frame structure is shown here for reference.

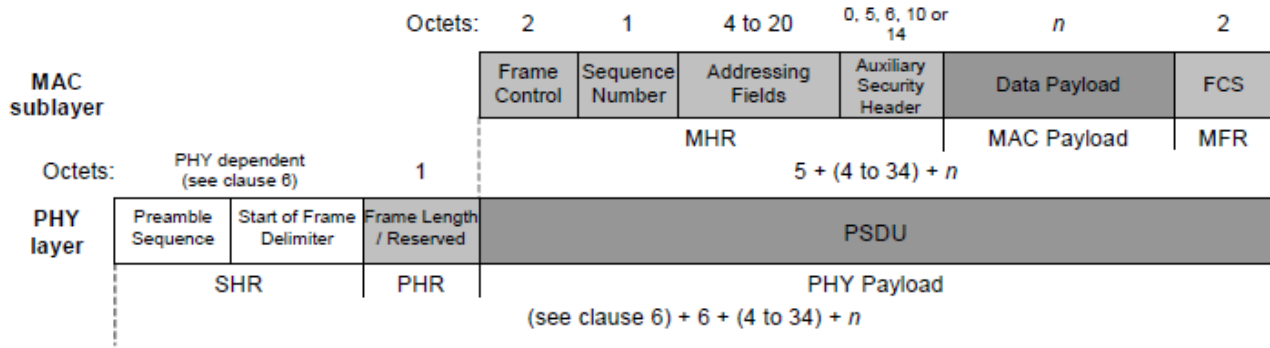
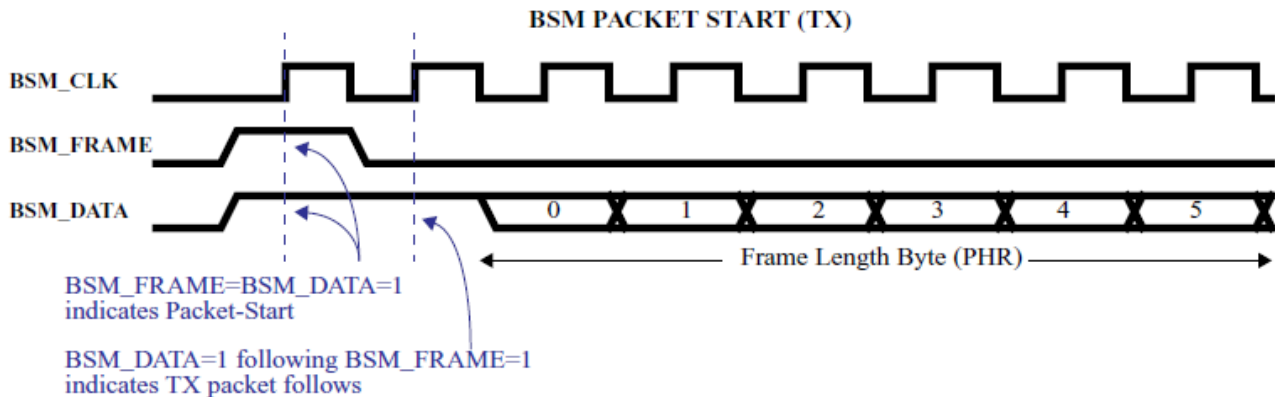

Figure 45-100. MAC Frame Structure

45.6.2.14.3.1 Functional timing

BSM Packet Start (TX)

A simple protocol on BSM_FRAME and BSM_DATA are used to indicate a BSM Packet Start. If BSM_FRAME and BSM_DATA are both high at rising edge of BSM_CLK, this indicates a Packet Start condition. The state of BSM_DATA during the bit period following the BSM_FRAME assertion, is used to indicate whether the ensuing packet is TX or RX. If BSM_DATA is high during this bit period, a TX packet follows, as shown in the following diagram.



BSM Packet Start (RX)

A simple protocol on BSM_FRAME and BSM_DATA is used to indicate a BSM Packet Start. If BSM_FRAME and BSM_DATA are both high at rising edge of BSM_CLK, this indicates a Packet Start condition. The state of BSM_DATA during the bit period following the BSM_FRAME assertion, is used to indicate whether the ensuing packet is TX or RX. If BSM_DATA is low during this bit period, an RX packet follows, as shown in the following diagram.

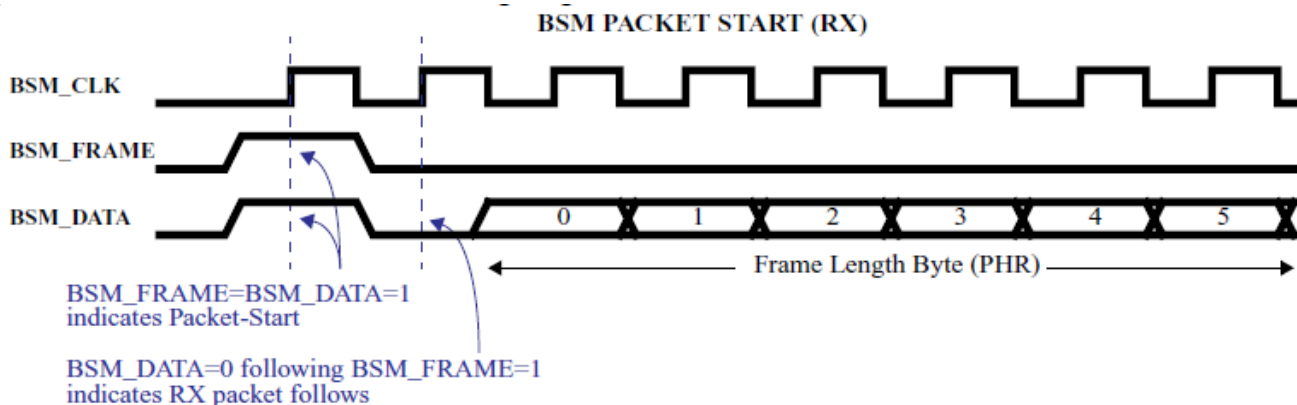

BSM Packet End

A simple protocol on BSM_FRAME and BSM_DATA is used to indicate a BSM Packet End. If BSM_FRAME is high and BSM_DATA is low at the rising edge of BSM_SCLK, this indicates a Packet End condition. Nominally, external hardware can predict the point at which the packet should end, based on the Frame Length (first BSM byte shifted out). However, because a TX or RX sequence could end abnormally, (e.g., a software abort or a hardware timeout), this BSM packet end indicator is provided to convey that information to the external development system. How the external hardware opts to handle an abnormally-terminated sequence, is beyond the scope of this document.

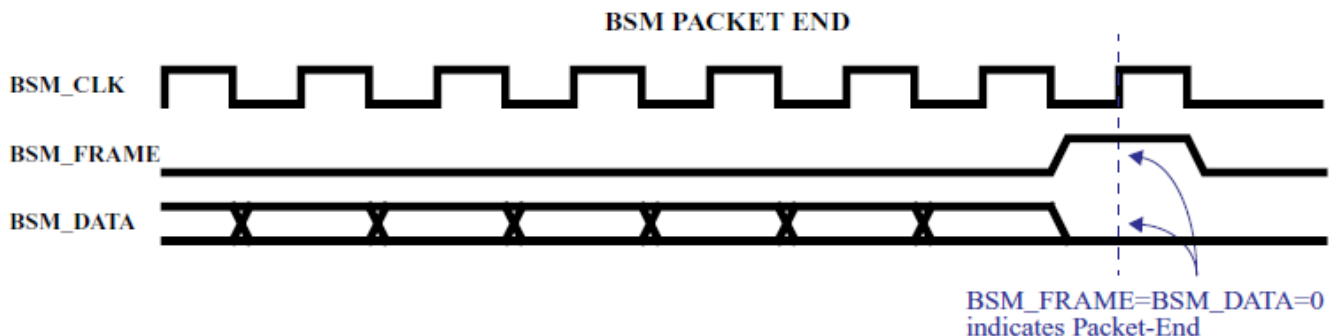

45.6.2.14.3.2 Clocks

BSM is a fully synchronous module. It has a single clock input **bsm_500khz_clk**. This clock is generated in the CGM (Clock Generation Module), and is only active when BSM is enabled. This input clock is divided by 2 to generate the BSM output BSM_CLK, whenever an active TX or RX operation is in progress. BSM has no asynchronous interfaces.

45.6.2.14.3.3 Reset

The BSM module has a single, active-low, asynchronous reset input: **rb**. At integration, this reset should be tied to the master reset for the entire transceiver. There are no special reset requirements.

45.6.2.14.3.4 Interrupts

BSM generates no interrupts.

45.6.2.15 ZLL Register Descriptions

45.6.2.15.1 ZLL Memory Map

| Offset | Register | Width (In bits) | Access | Reset value |
|-----------|---|--------------------|--------|------------------|
| 4005D000h | INTERRUPT REQUEST STATUS (IRQSTS) | 32 | RW | See description. |
| 4005D004h | PHY CONTROL (PHY_CTRL) | 32 | RW | 0805FF00h |
| 4005D008h | EVENT TIMER (EVENT_TMR) | 32 | RW | See description. |
| 4005D00Ch | TIMESTAMP (TIMESTAMP) | 32 | RO | See description. |
| 4005D010h | T1 COMPARE (T1CMP) | 32 | RW | 00FFFFFFh |
| 4005D014h | T2 COMPARE (T2CMP) | 32 | RW | 00FFFFFFh |
| 4005D018h | T2 PRIME COMPARE (T2PRIMECMP) | 32 | RW | 0000FFFFh |
| 4005D01Ch | T3 COMPARE (T3CMP) | 32 | RW | 00FFFFFFh |
| 4005D020h | T4 COMPARE (T4CMP) | 32 | RW | 00FFFFFFh |
| 4005D024h | PA POWER (PA_PWR) | 32 | RW | 00000000h |
| 4005D028h | CHANNEL NUMBER 0 (CHANNEL_NUM0) | 32 | RW | 00000012h |

Table continues on the next page...

| Offset | Register | Width (In bits) | Access | Reset value |
|--------------------------|---|--------------------|--------|------------------|
| 4005D02Ch | LQI AND RSSI (LQI_AND_RSSI) | 32 | RO | See description. |
| 4005D030h | MAC SHORT ADDRESS 0 (MACSHORTADDRS0) | 32 | RW | FFFFFFFFh |
| 4005D034h | MAC LONG ADDRESS 0 LSB (MACLONGADDRS0_LSB) | 32 | RW | FFFFFFFFh |
| 4005D038h | MAC LONG ADDRESS 0 MSB (MACLONGADDRS0_MSB) | 32 | RW | FFFFFFFFh |
| 4005D03Ch | RECEIVE FRAME FILTER (RX_FRAME_FILTER) | 32 | RW | See description. |
| 4005D040h | CCA AND LQI CONTROL (CCA_LQI_CTRL) | 32 | RW | 0866004Bh |
| 4005D044h | CCA2 CONTROL (CCA2_CTRL) | 32 | RW | See description. |
| 4005D04Ch | DSM CONTROL (DSM_CTRL) | 32 | RW | 00000000h |
| 4005D050h | BSM CONTROL (BSM_CTRL) | 32 | RW | 00000000h |
| 4005D054h | MAC SHORT ADDRESS FOR PAN1 (MACSHORTADDRS1) | 32 | RW | FFFFFFFFh |
| 4005D058h | MAC LONG ADDRESS 1 LSB (MACLONGADDRS1_LSB) | 32 | RW | FFFFFFFFh |
| 4005D05Ch | MAC LONG ADDRESS 1 MSB (MACLONGADDRS1_MSB) | 32 | RW | FFFFFFFFh |
| 4005D060h | DUAL PAN CONTROL (DUAL_PAN_CTRL) | 32 | RW | See description. |
| 4005D064h | CHANNEL NUMBER 1 (CHANNEL_NUM1) | 32 | RW | 0000007Fh |
| 4005D068h | SAM CONTROL (SAM_CTRL) | 32 | RW | 80804000h |
| 4005D06Ch | SOURCE ADDRESS MANAGEMENT TABLE (SAM_TABLE) | 32 | RW | See description. |
| 4005D070h | SOURCE ADDRESS MANAGEMENT MATCH (SAM_MATCH) | 32 | RO | See description. |
| 4005D074h | SAM FREE INDEX (SAM_FREE_IDX) | 32 | RO | See description. |
| 4005D078h | SEQUENCE CONTROL AND STATUS (SEQ_CTRL_STS) | 32 | RW | See description. |
| 4005D07Ch | ACK DELAY (ACKDELAY) | 32 | RW | 00000007h |
| 4005D080h | FILTER FAIL CODE (FILTERFAIL_CODE) | 32 | RW | See description. |
| 4005D084h | RECEIVE WATER MARK (RX_WTR_MARK) | 32 | RW | 000000FFh |
| 4005D08Ch | SLOT PRELOAD (SLOT_PRELOAD) | 32 | RW | 00000074h |
| 4005D090h | 802.15.4 SEQUENCE STATE (SEQ_STATE) | 32 | RO | See description. |
| 4005D094h | TIMER PRESCALER (TMR_PRESCALE) | 32 | RW | 00000005h |
| 4005D098h | LENIENCY LSB (LENIENCY_LSB) | 32 | RW | 00000000h |
| 4005D09Ch | LENIENCY MSB (LENIENCY_MSB) | 32 | RW | 00000000h |
| 4005D0A0h | PART ID (PART_ID) | 32 | RO | 00000002h |
| 4005D100h - 4005D17Eh | Packet Buffer TX (PKT_BUFFER_TX0 - PKT_BUFFER_TX63) | 16 | RW | See description. |
| 4005D180h - 4005D1FEh | Packet Buffer RX (PKT_BUFFER_RX0 - PKT_BUFFER_RX63) | 16 | RW | See description. |

45.6.2.15.2 INTERRUPT REQUEST STATUS (IRQSTS)

45.6.2.15.2.1 Address

| Register | Offset |
|----------|-----------|
| IRQSTS | 4005D000h |

45.6.2.15.2.2 Function

The IRQSTS register indicates the status of interrupt requests in the 802.15.4 module.

45.6.2.15.2.3 Diagram

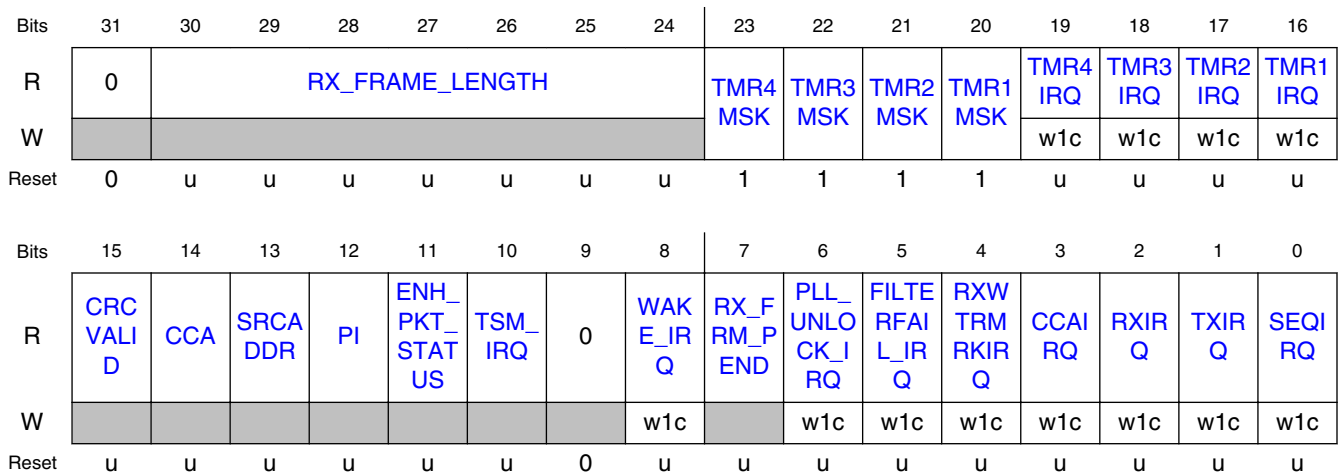

45.6.2.15.2.4 Fields

| Field | Function |
|--------------------------|--|
| 31 — | Reserved. |
| 30-24 RX_FRAME_LENGTH | Receive Frame Length Contents of the PHR (PHY header), or FrameLength field, of the most recently received packet. Read-only. |
| 23 TMR4MSK | Timer Comperator 4 Interrupt Mask bit 0b - allows interrupt when comparator matches event timer count 1b - Interrupt generation is disabled, but a TMR4IRQ flag can be set |
| 22 TMR3MSK | Timer Comperator 3 Interrupt Mask bit 0b - allows interrupt when comparator matches event timer count 1b - Interrupt generation is disabled, but a TMR3IRQ flag can be set |

Table continues on the next page...

| Field | Function |
|----------------|---|
| 21 TMR2MSK | Timer Comperator 2 Interrupt Mask bit 0b - allows interrupt when comparator matches event timer count 1b - Interrupt generation is disabled, but a TMR2IRQ flag can be set |
| 20 TMR1MSK | Timer Comperator 1 Interrupt Mask bit 0b - allows interrupt when comparator matches event timer count 1b - Interrupt generation is disabled, but a TMR1IRQ flag can be set |
| 19 TMR4IRQ | Timer 4 IRQ Timer Comparator 4 Interrupt Status bit: Indicates T4CMP comparator value matched event timer counter. This is write '1' to clear bit |
| 18 TMR3IRQ | Timer 3 IRQ Timer Comparator 3 Interrupt Status bit: Indicates T3CMP comparator value matched event timer counter. This is write '1' to clear bit |
| 17 TMR2IRQ | Timer 2 IRQ Timer Comparator 2 Interrupt Status bit: Indicates comparator value matched event timer counter. This flag is shared between the T2CMP (24-bit) and T2PRIMECMP (16-bit) compare registers. This is write '1' to clear bit |
| 16 TMR1IRQ | Timer 1 IRQ Timer Comparator 1 Interrupt Status bit: Indicates T1CMP comparator value matched event timer counter. This is write '1' to clear bit |
| 15 CRCVALID | CRC Valid Status Code Redundancy Check Valid: This flag indicates the compare result between the FCS field, in the most-recently received frame, and the internally calculated CRC value. This flag is cleared at next receiver warm up. 0b - Rx FCS != calculated CRC (incorrect) 1b - Rx FCS = calculated CRC (correct) |
| 14 CCA | CCA Status Channel IDLE/BUSY indicator. This indicator is valid at CCAIRQ and also at SEQIRQ. This flag is cleared at next receiver warm up. 0b - IDLE 1b - BUSY |
| 13 SRCADDR | Source Address Match Status If Source Address Management is engaged, meaning at least one of the following bits is set: SAP0_EN SAA0_EN SAP1_EN SAA1_EN Then SRCADDR will be set to 1 if the packet just received is a poll request (PI=1), <i>and</i> at least one of the following conditions is met: SAP0_EN and SAP0_ADDR_PRESENT SAA0_EN and SAA0_ADDR_ABSENT SAP1_EN and SAP1_ADDR_PRESENT SAA1_EN and SAA1_ADDR_ABSENT If SRCADDR=1, this indicates to SW that the Packet Processor has determined that an auto-TxACK frame must be transmitted with the FramePending subfield of the FrameControlField set to 1. HW will assemble and transmit this Ack packet. If the above conditions are not met, SRCADDR will be cleared to 0. |
| 12 PI | Poll Indication 0b - the received packet was not a data request |

Table continues on the next page...

Link Layer

| Field | Function |
|----------------------|---|
| | 1b - the received packet was a data request, regardless of whether a Source Address table match occurred, or whether Source Address Management is enabled or not |
| 11 ENH_PKT_STATUS | Enhanced Packet Status 0b - The last packet received was neither 4e- nor 2015-compliant 1b - The last packet received was 4e- or 2015-compliant (RX_FRAME_FILTER register should be queried for additional status bits) |
| 10 TSM_IRQ | TSM IRQ TSM Interrupt Request 0b - A TSM Interrupt has not occurred 1b - A TSM Interrupt has occurred |
| 9 — | Reserved. |
| 8 WAKE_IRQ | WAKE Interrupt Request Wake Interrupt. The RSIM SLEEP_TMR has matched the RSIM ZIGBEE_WAKE register, and DSM has exited. The 802.15.4 EVENT_TMR has resumed counting. 0b - A Wake Interrupt has not occurred 1b - A Wake Interrupt has occurred |
| 7 RX_FRM_PEND | RX Frame Pending Status of the frame pending bit of the frame control field for the most-recently received packet. Read-only. |
| 6 PLL_UNLOCK_IRQ | PLL Unlock IRQ PLL Un-lock Interrupt Status bit. A '1' indicates an unlock event has occurred in the PLL. This is write a '1' to clear bit. 0b - A PLL Unlock Interrupt has not occurred 1b - A PLL Unlock Interrupt has occurred |
| 5 FILTERFAIL_IRQ | Filter Fail IRQ Receiver Packet Filter Fail Interrupt Status bit. A '1' indicates that the most-recently received packet has been rejected due to elements within the packet. This is write a '1' to clear bit. In Dual PAN mode, FILTERFAIL_IRQ applies to either or both networks, as follows: A: If PAN0 and PAN1 occupy different channels and CURRENT_NETWORK=0, FILTERFAIL_IRQ applies to PAN0. B: If PAN0 and PAN1 occupy different channels and CURRENT_NETWORK=1, FILTERFAIL_IRQ applies to PAN1. C: If PAN0 and PAN1 occupy the same channel, FILTERFAIL_IRQ is the logical 'AND' of the individual PANs' Filter Fail status. 0b - A Filter Fail Interrupt has not occurred 1b - A Filter Fail Interrupt has occurred |
| 4 RXWTRMRKIRQ | Receive Watermark IRQ Receiver Byte Count Water Mark Interrupt Status bit. A '1' indicates that the number of bytes specified in the RX_WTR_MARK register has been reached. This is write a '1' to clear bit. 0b - A Receive Watermark Interrupt has not occurred 1b - A Receive Watermark Interrupt has occurred |
| 3 CCAIRQ | CCA IRQ Clear Channel Assessment Interrupt Status bit. A '1' indicates completion of CCA operation. This is write '1' to clear bit. 0b - A CCA Interrupt has not occurred 1b - A CCA Interrupt has occurred |
| 2 | RX IRQ |

Table continues on the next page...

| Field | Function |
|-------------|--|
| RXIRQ | Receiver Interrupt Status bit. A '1' indicates the completion of a receive operation. This is write a '1' to clear bit. 0b - A RX Interrupt has not occurred 1b - A RX Interrupt has occurred |
| 1 TXIRQ | TX IRQ Transmitter Interrupt Status bit. A '1' indicates the completion of a transmit operation. This is write a '1' to clear bit. 0b - A TX Interrupt has not occurred 1b - A TX Interrupt has occurred |
| 0 SEQIRQ | Sequencer IRQ Sequence-end Interrupt Status bit. A '1' indicates the completion of an autosequence. This interrupt will assert whenever the Sequence Manager transitions from non-idle to idle state, for any reason. This is write a '1' to clear bit. 0b - A Sequencer Interrupt has not occurred 1b - A Sequencer Interrupt has occurred |

45.6.2.15.3 PHY CONTROL (PHY_CTRL)

45.6.2.15.3.1 Address

| Register | Offset |
|----------|-----------|
| PHY_CTRL | 4005D004h |

45.6.2.15.3.2 Function

PHY Control Register

45.6.2.15.3.3 Diagram

| | | | | | | | | | | | | | | | | |
|-------|--------------|----------------------------|----------------------------|-------------------------|------------|-----------|---------------------|---------------------|--------------------|--------------------|--------------------|--------------------|-------------|-------------|----|------------------|
| Bits | 31 | 30 | 29 | 28 | 27 | 26 | 25 | 24 | 23 | 22 | 21 | 20 | 19 | 18 | 17 | 16 |
| R | | | | | | 0 | PRO MISC UOUS | TC2P RIME _EN | TMR4 CMP_ EN | TMR3 CMP_ EN | TMR2 CMP_ EN | TMR1 CMP_ EN | 0 | TSM_ MSK | 0 | WAK E_MS K |
| W | TRCV _MSK | TC3T MOU T | PANC ORD NTR0 | CCATYPE | | | | | | | | | | | | |
| Reset | 0 | 0 | 0 | 0 | 1 | 0 | 0 | 0 | 0 | 0 | 0 | 0 | 0 | 1 | 0 | 1 |
| Bits | 15 | 14 | 13 | 12 | 11 | 10 | 9 | 8 | 7 | 6 | 5 | 4 | 3 | 2 | 1 | 0 |
| R | | | | | | | | | TMRT RIGE N | SLOT TED | CCAB FRTX | RXAC KRQ D | AUTO ACK | | | |
| W | CRC_ MSK | PLL_ UNLO CK_M SK | FILTE RFAI L_MS K | RX_ WMR K_MS K | CCA MSK | RXM SK | TXMS K | SEQ MSK | | | | | | | | XCVSEQ |
| Reset | 1 | 1 | 1 | 1 | 1 | 1 | 1 | 1 | 0 | 0 | 0 | 0 | 0 | 0 | 0 | 0 |

45.6.2.15.3.4 Fields

| Field | Function |
|-----------------------|--|
| 31 TRCV_MSK | Transceiver Global Interrupt Mask Transceiver Global Interrupt Mask 0b - Enable any unmasked interrupt source to assert 802.15.4 interrupt 1b - Mask all interrupt sources from asserting 802.15.4 interrupt |
| 30 TC3TMOUT | TMR3 Timeout Enable TMR3 Timeout Enable 0b - TMR3 is a software timer only 1b - Enable TMR3 to abort Rx or CCCA operations. |
| 29 PANCORDNTR 0 | Device is a PAN Coordinator on PAN0 Device is a PAN Coordinator on PAN0. Allows device to receive packets with no destination address, if Source PAN ID matches. |
| 28-27 CCATYPE | Clear Channel Assessment Type Clear Channel Assessment Type. Selects one of four possible functions for CCA or Energy Detect, per below. 00b - ENERGY DETECT 01b - CCA MODE 1 10b - CCA MODE 2 11b - CCA MODE 3 |
| 26 — | Reserved. |
| 25 PROMISCUOUS | Promiscuous Mode Enable Bypasses most packet filtering. 0b - normal mode 1b - all packet filtering except frame length checking (FrameLength >=5 and FrameLength <=127) is bypassed. |
| 24 TC2PRIME_EN | Timer 2 Prime Compare Enable 0b - Don't allow a match of the lower 16 bits of Event Timer to T2PRIMECMP to set TMR2IRQ 1b - Allow a match of the lower 16 bits of Event Timer to T2PRIMECMP to set TMR2IRQ |
| 23 TMR4CMP_EN | Timer 4 Compare Enable 0b - Don't allow an Event Timer Match to T4CMP to set TMR4IRQ 1b - Allow an Event Timer Match to T4CMP to set TMR4IRQ |
| 22 TMR3CMP_EN | Timer 3 Compare Enable 0b - Don't allow an Event Timer Match to T3CMP to set TMR3IRQ 1b - Allow an Event Timer Match to T3CMP to set TMR3IRQ |
| 21 TMR2CMP_EN | Timer 2 Compare Enable 0b - Don't allow an Event Timer Match to T2CMP or T2PRIMECMP to set TMR2IRQ 1b - Allow an Event Timer Match to T2CMP or T2PRIMECMP to set TMR2IRQ |
| 20 TMR1CMP_EN | Timer 1 Compare Enable 0b - Don't allow an Event Timer Match to T1CMP to set TMR1IRQ 1b - Allow an Event Timer Match to T1CMP to set TMR1IRQ |
| 19 — | Reserved. |
| 18 TSM_MSK | Reserved. 0b - allows assertion of a TSM interrupt to generate a 802.15.4 interrupt |

Table continues on the next page...

| Field | Function |
|----------------------|--|
| | 1b - Assertion of a TSM interrupt will set the TSM_IRQ status bit, but a 802.15.4 interrupt is not generated |
| 17 — | Reserved. |
| 16 WAKE_MSK | Reserved. 0b - Allows a wakeup from DSM to generate a 802.15.4 interrupt 1b - Wakeup from DSM will set the WAKE_IRQ status bit, but a 802.15.4 interrupt is not generated |
| 15 CRC_MSK | CRC Mask CRC Mask 0b - sequence manager ignores CRCVALID and considers the receive operation complete after the last octet of the frame has been received. 1b - sequence manager requires CRCVALID=1 at the end of the received frame in order for the receive operation to complete successfully; if CRCVALID=0, sequence manager will return to preamble-detect mode after the last octet of the frame has been received. |
| 14 PLL_UNLOCK_MSK | PLL Unlock Interrupt Mask 0b - allows PLL unlock event to generate a 802.15.4 interrupt 1b - A PLL unlock event will set the PLL_UNLOCK_IRQ status bit, but a 802.15.4 interrupt is not generated |
| 13 FILTERFAIL_MSK | FilterFail Interrupt Mask FilterFail Interrupt Mask 0b - allows Packet Processor Filtering Failure to generate a 802.15.4 interrupt 1b - A Packet Processor Filtering Failure will set the FILTERFAIL_IRQ status bit, but a 802.15.4 interrupt is not generated |
| 12 RX_WMRK_MSK | RX Watermark Interrupt Mask RX Watermark Interrupt Mask 0b - allows a Received Byte Count match to the RX_WTR_MARK threshold register to generate a 802.15.4 interrupt 1b - A Received Byte Count match to the RX_WTR_MARK threshold register will set the RXWTRMRKIRQ status bit, but a 802.15.4 interrupt is not generated |
| 11 CCAMSK | CCA Interrupt Mask CCA Interrupt Mask 0b - allows completion of a CCA operation to generate a 802.15.4 interrupt 1b - Completion of a CCA operation will set the CCA status bit, but a 802.15.4 interrupt is not generated |
| 10 RXMSK | RX Interrupt Mask 0b - allows completion of a RX operation to generate a 802.15.4 interrupt 1b - Completion of a RX operation will set the RXIRQ status bit, but a 802.15.4 interrupt is not generated |
| 9 TXMSK | TX Interrupt Mask 0b - allows completion of a TX operation to generate a 802.15.4 interrupt 1b - Completion of a TX operation will set the TXIRQ status bit, but a 802.15.4 interrupt is not generated |
| 8 SEQMSK | Sequencer Interrupt Mask 0b - allows completion of an autosequence to generate a 802.15.4 interrupt 1b - Completion of an autosequence will set the SEQIRQ status bit, but a 802.15.4 interrupt is not generated |
| 7 TMRTRIGEN | Timer2 Trigger Enable 0b - programmed sequence initiates immediately upon write to XCVSEQ. 1b - allow timer TC2 (or TC2') to initiate a preprogrammed sequence (see XCVSEQ register). |
| 6 | Slotted Mode |

Table continues on the next page...

Link Layer

| Field | Function |
|---------------|--|
| SLOTTED | Slotted Mode, for beacon-enabled networks. Applies only to Sequences T, TR, and R, ignored during all other sequences. Used, in concert with CCABFRTX, to determine how many CCA measurements are required prior to a transmit operation. Also used during R sequence to determine whether the ensuing transmit acknowledge frame (if any) needs to be synchronized to a backoff slot boundary. |
| 5 CCABFRTX | CCA Before TX Applies only to Sequences T and TR, ignored during all other sequences. 0b - no CCA required, transmit operation begins immediately. 1b - at least one CCA measurement is required prior to the transmit operation (see also SLOTTED). |
| 4 RXACKRQD | Receive Acknowledge Frame required Applies only to Sequence TR, ignored during all other sequences. 0b - An ordinary receive frame (any type of frame) follows the transmit frame. 1b - A receive Ack frame is expected to follow the transmit frame (non-Ack frames are rejected). |
| 3 AUTOACK | Auto Acknowledge Enable Applies only to Sequence R and Sequence TR, ignored during other sequences 0b - sequence manager will not follow a receive frame with a Tx Ack frame, under any conditions; the autosequence will terminate after the receive frame. 1b - sequence manager will follow a receive frame with an automatic hardware-generated Tx Ack frame, assuming other necessary conditions are met. |
| 2-0 XCVSEQ | 802.15.4 Transceiver Sequence Selector The Transceiver Sequence Selector register selects an autosequence for the sequence manager to execute. Sequence initiation can be immediate, or scheduled (see TMRTRIGEN). A write of XCVSEQ=IDLE will abort any ongoing sequence. A write of XCVSEQ=IDLE must always be performed after a sequence is complete, and before a new sequence is programmed. Any write to XCVSEQ other than XCVSEQ=IDLE during an ongoing sequence, shall be ignored. The mapping of XCVSEQ to sequence types is as follows: 000b - I (IDLE) 001b - R (RECEIVE) 010b - T (TRANSMIT) 011b - C (CCA) 100b - TR (TRANSMIT/RECEIVE) 101b - CCCA (CONTINUOUS CCA) 110b - Reserved 111b - Reserved |

45.6.2.15.4 EVENT TIMER (EVENT_TMR)

45.6.2.15.4.1 Address

| Register | Offset |
|-----------|-----------|
| EVENT_TMR | 4005D008h |

45.6.2.15.4.2 Diagram

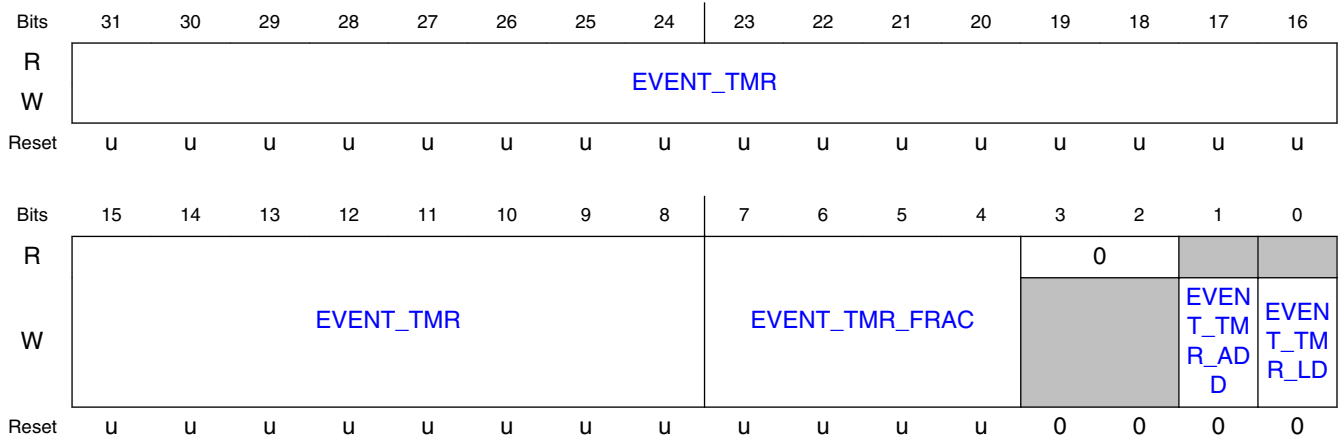

45.6.2.15.4.3 Fields

| Field | Function |
|-----------------------|---|
| 31-8 EVENT_TMR | Event Timer Integer Component The EVENT_TMR represents a 28-bit number with 24 Integer bits and 4 Fractional bits. This field is the integer component, which appears to the left of the decimal point. Most 802.15.4 operations which relate to the Event Timer require only the integer component. |
| 7-4 EVENT_TMR_FRAC | Event Timer Fractional Component The EVENT_TMR represents a 28-bit number with 24 Integer bits and 4 Fractional bits. This field is the fractional component, which appears to the right of the decimal point. The fractional component can be ignored for most 802.15.4 operations which relate to the Event Timer; it has been provided only to allow for microsecond accuracy when software updates the Event Timer after a long period of DSM (sleep) mode |
| 3-2 — | Reserved. |
| 1 EVENT_TMR_ADD | Event Timer Add Enable Increments the Event Timer by the values written to the EVENT_TMR[23:0] and EVENT_TMR_FRAC[3:0] fields of this register. |
| 0 EVENT_TMR_LOAD | Event Timer Load Enable Loads the Event Timer with the values written to the EVENT_TMR[23:0] and EVENT_TMR_FRAC[3:0] fields of this register. |

45.6.2.15.5 TIMESTAMP (TIMESTAMP)

45.6.2.15.5.1 Address

| Register | Offset |
|-----------|-----------|
| TIMESTAMP | 4005D00Ch |

45.6.2.15.5.2 Diagram

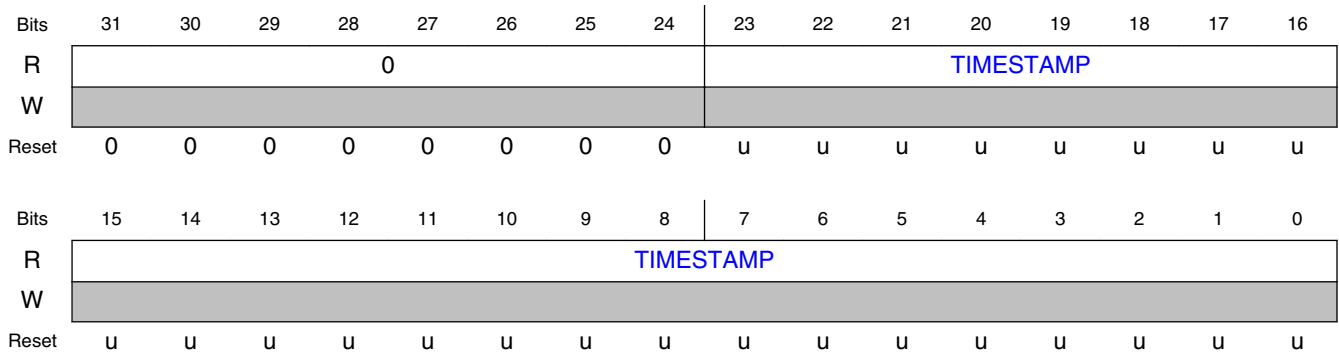

45.6.2.15.5.3 Fields

| Field | Function |
|-------------------|---|
| 31-24 — | Reserved. |
| 23-0 TIMESTAMP | Timestamp Holds the latched value of the Event Timer current time corresponding to the beginning of the most recently received packet, at the point of SFD detection |

45.6.2.15.6 T1 COMPARE (T1CMP)

45.6.2.15.6.1 Address

| Register | Offset |
|----------|-----------|
| T1CMP | 4005D010h |

45.6.2.15.6.2 Function

TMR1 Compare Value

45.6.2.15.6.3 Diagram

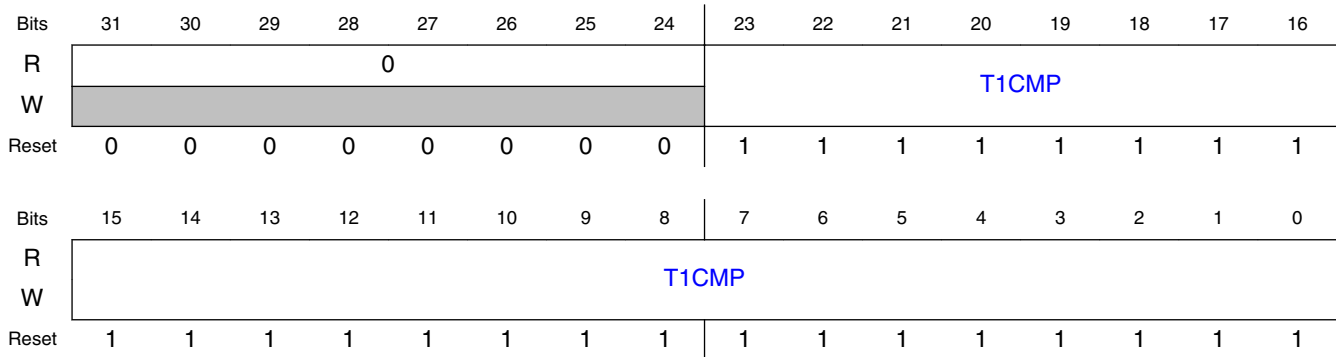

45.6.2.15.6.4 Fields

| Field | Function |
|---------------|---|
| 31-24 — | Reserved. |
| 23-0 T1CMP | TMR1 Compare Value TMR1 compare value. If TMR1CMP_EN=1 and the Event Timer matches this value, TMR1IRQ is set. |

45.6.2.15.7 T2 COMPARE (T2CMP)

45.6.2.15.7.1 Address

| Register | Offset |
|----------|-----------|
| T2CMP | 4005D014h |

45.6.2.15.7.2 Function

TMR2 Compare Value

45.6.2.15.7.3 Diagram

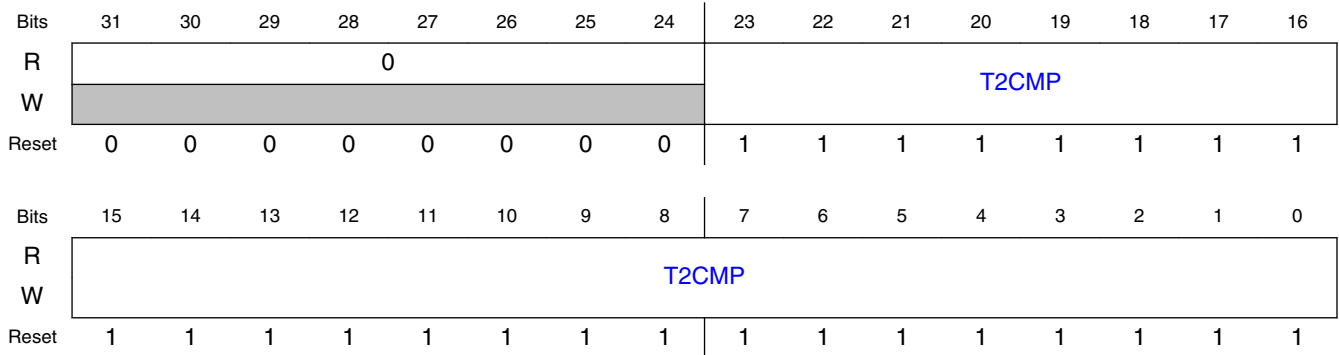

45.6.2.15.7.4 Fields

| Field | Function |
|---------------|---|
| 31-24 — | Reserved. |
| 23-0 T2CMP | TMR2 Compare Value TMR2 compare value. If TMR2CMP_EN=1 and TC2PRIME_EN=0 and the Event Timer matches this value, TMR2IRQ is set. |

45.6.2.15.8 T2 PRIME COMPARE (T2PRIMECMP)

45.6.2.15.8.1 Address

| Register | Offset |
|------------|-----------|
| T2PRIMECMP | 4005D018h |

45.6.2.15.8.2 Function

TMR2 Prime Compare Value

45.6.2.15.8.3 Diagram

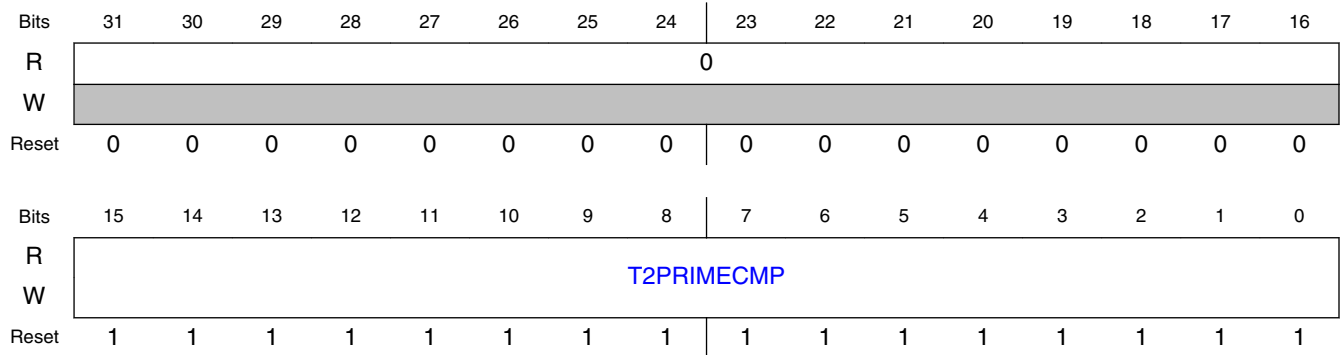

45.6.2.15.8.4 Fields

| Field | Function |
|--------------------|---|
| 31-16 — | Reserved. |
| 15-0 T2PRIMECMP | TMR2 Prime Compare Value TMR2 compare value. If TMR2CMP_EN=1 and TC2PRIME_EN=1 and the Event Timer matches this value, TMR2IRQ is set. |

45.6.2.15.9 T3 COMPARE (T3CMP)

45.6.2.15.9.1 Address

| Register | Offset |
|----------|-----------|
| T3CMP | 4005D01Ch |

45.6.2.15.9.2 Function

TMR3 Compare Value

45.6.2.15.9.3 Diagram

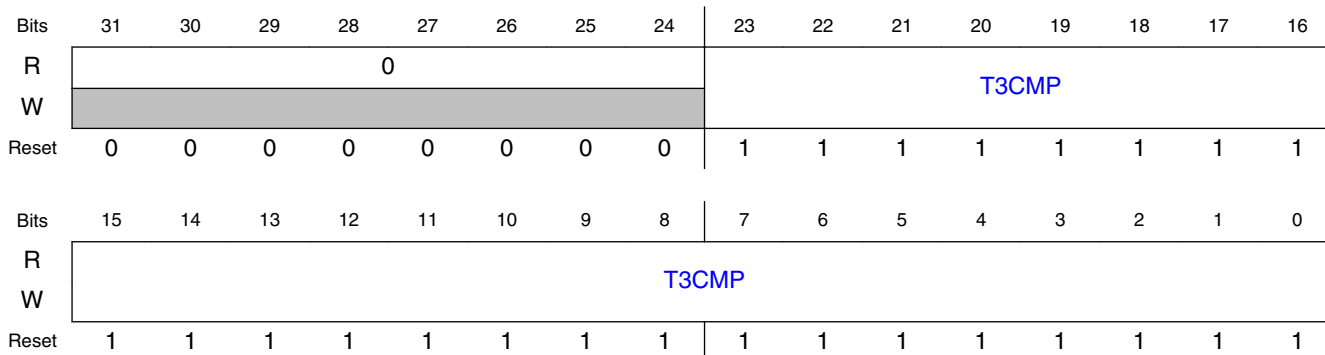

45.6.2.15.9.4 Fields

| Field | Function |
|---------------|---|
| 31-24 — | Reserved. |
| 23-0 T3CMP | TMR3 Compare Value TMR3 compare value. If TMR3CMP_EN=1 and the Event Timer matches this value, TMR3IRQ is set. |

45.6.2.15.10 T4 COMPARE (T4CMP)

45.6.2.15.10.1 Address

| Register | Offset |
|----------|-----------|
| T4CMP | 4005D020h |

45.6.2.15.10.2 Function

TMR4 Compare Value

45.6.2.15.10.3 Diagram

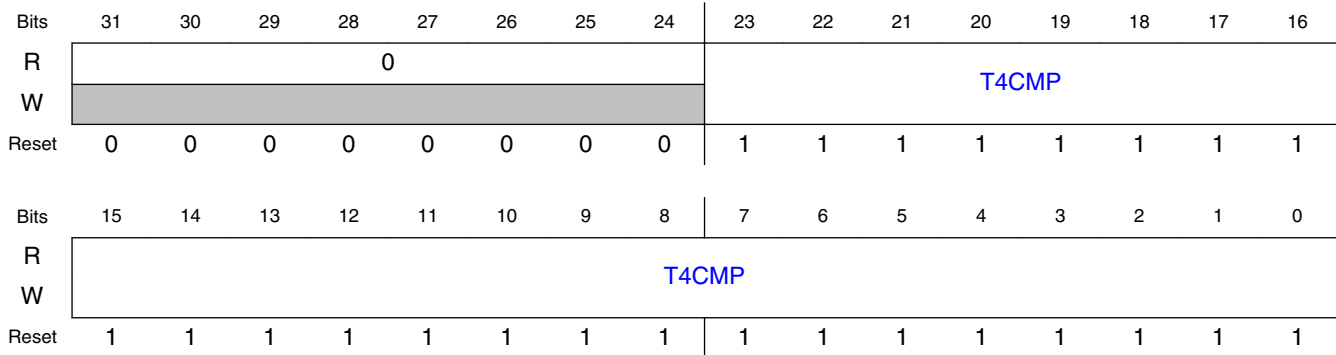

45.6.2.15.10.4 Fields

| Field | Function |
|---------------|---|
| 31-24 — | Reserved. |
| 23-0 T4CMP | TMR4 Compare Value TMR4 compare value. If TMR4CMP_EN=1 and the Event Timer matches this value, TMR4IRQ is set. |

45.6.2.15.11 PA POWER (PA_PWR)

45.6.2.15.11.1 Address

| Register | Offset |
|----------|-----------|
| PA_PWR | 4005D024h |

45.6.2.15.11.2 Diagram

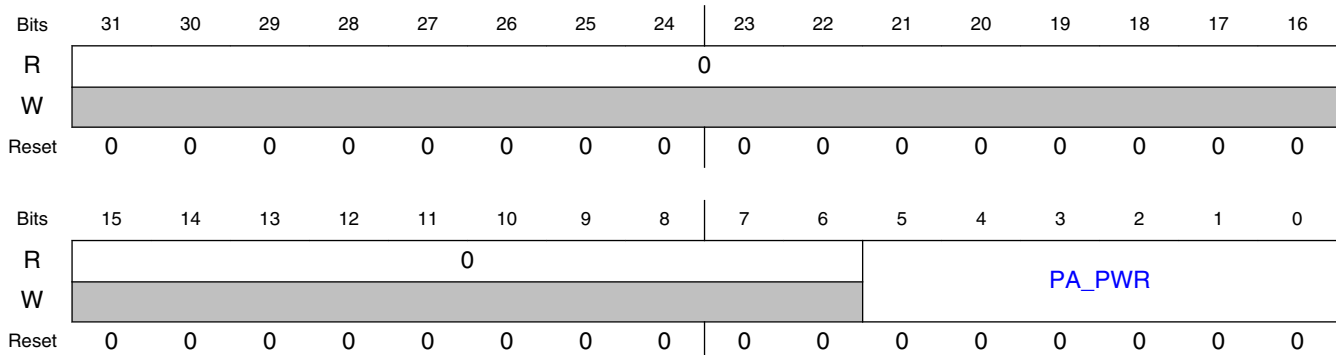

45.6.2.15.11.3 Fields

| Field | Function |
|------------------|-----------|
| 31-6 Reserved | Reserved. |
| 5-0 PA_PWR | PA Power |

45.6.2.15.12 CHANNEL NUMBER 0 (CHANNEL_NUM0)

45.6.2.15.12.1 Address

| Register | Offset |
|--------------|-----------|
| CHANNEL_NUM0 | 4005D028h |

45.6.2.15.12.2 Function

Channel Number for PAN0

45.6.2.15.12.3 Diagram

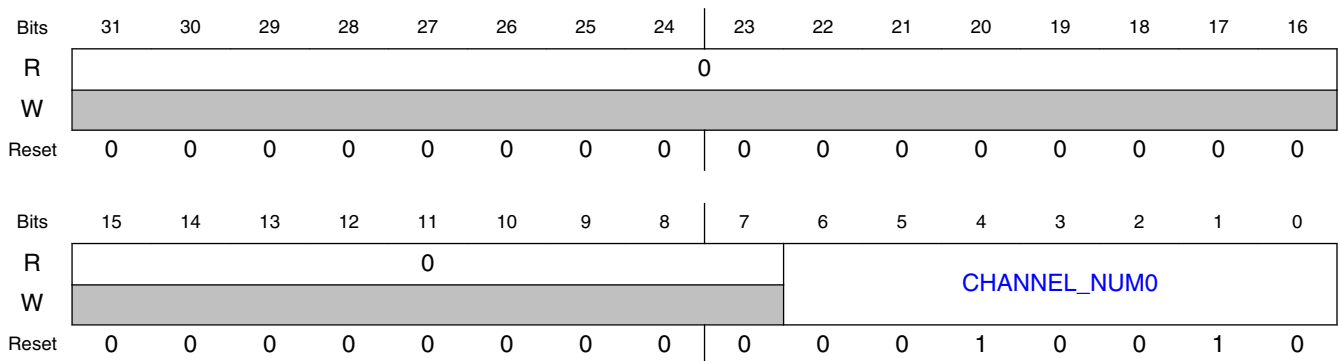

45.6.2.15.12.4 Fields

| Field | Function |
|------------------|-------------------------|
| 31-7 Reserved | Reserved. |
| 6-0 | Channel Number for PAN0 |

| Field | Function |
|--------------|--|
| CHANNEL_NUM0 | This is the mapped channel number used to transmit and receive 802.15.4 packets. If Dual PAN is engaged, this register applies to PAN0. CHANNEL_NUM0 should be in the range: 11 <= CHANNEL_NUM0 <= 26 |

45.6.2.15.13 LQI AND RSSI (LQI_AND_RSSI)

45.6.2.15.13.1 Address

| Register | Offset |
|--------------|-----------|
| LQI_AND_RSSI | 4005D02Ch |

45.6.2.15.13.2 Diagram

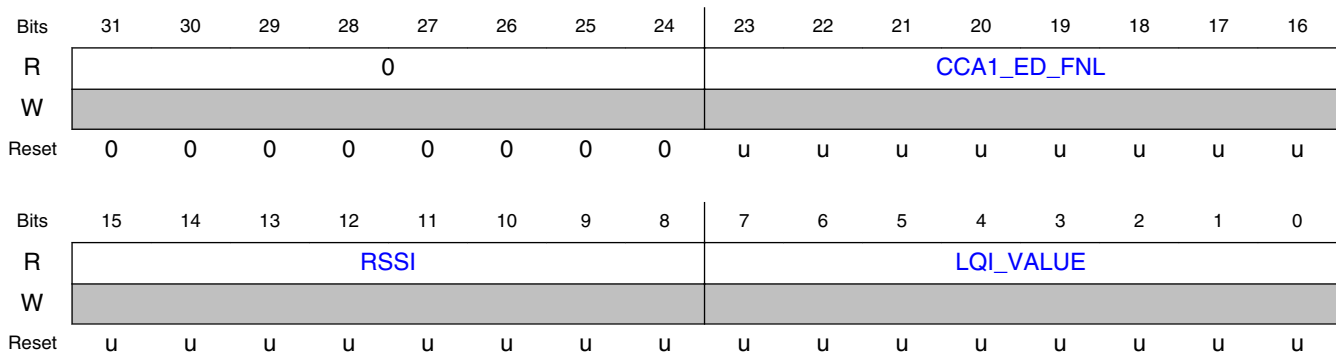

45.6.2.15.13.3 Fields

| Field | Function |
|----------------------|---|
| 31-24 — | Reserved. |
| 23-16 CCA1_ED_FNL | Final Result for CCA Mode 1 and Energy Detect Output register to show final averaged RSSI value or compensated value of the same at the end of a CCA Mode1 or Energy Detect computation. |
| 15-8 RSSI | RSSI Value Received Signal Strength Indicator, in dBm |
| 7-0 LQI_VALUE | LQI Value Link Quality Indicator for the most recently received packet. (LQI is also available in the Packet Buffer, at the end of the received packet data) |

45.6.2.15.14 MAC SHORT ADDRESS 0 (MACSHORTADDRS0)

45.6.2.15.14.1 Address

| Register | Offset |
|----------------|-----------|
| MACSHORTADDRS0 | 4005D030h |

45.6.2.15.14.2 Function

MAC SHORT ADDRESS for PAN0

45.6.2.15.14.3 Diagram



45.6.2.15.14.4 Fields

| Field | Function |
|----------------|--|
| 31-16 | MAC SHORT ADDRESS FOR PAN0 |
| MACSHORTADDRS0 | MAC Short Address for PAN0, for 16-bit destination addressing mode. The packet processor compares the incoming packet's Destination Address against the contents of this register to determine if the packet is addressed to this device. |
| 15-0 | MAC PAN ID for PAN0 |
| MACPANID0 | MAC PAN ID for PAN0. The packet processor compares the incoming packet's Destination PAN ID against the contents of this register to determine if the packet is addressed to this device; or if the incoming packet is a Beacon frame, the packet processor compares the incoming packet Source PAN ID against this register. Also, if PANCORNTRO=1, and the incoming packet has no Destination Address field, and if the incoming packet is a Data or MAC Command frame, the packet processor compares the incoming packet Source PAN ID against this register. |

45.6.2.15.15 MAC LONG ADDRESS 0 LSB (MACLONGADDRS0_LSB)

45.6.2.15.15.1 Address

| Register | Offset |
|------------------------|-----------|
| MACLONGADDRS0_LSB B | 4005D034h |

45.6.2.15.15.2 Function

MAC LONG ADDRESS for PAN0 LSB

45.6.2.15.15.3 Diagram

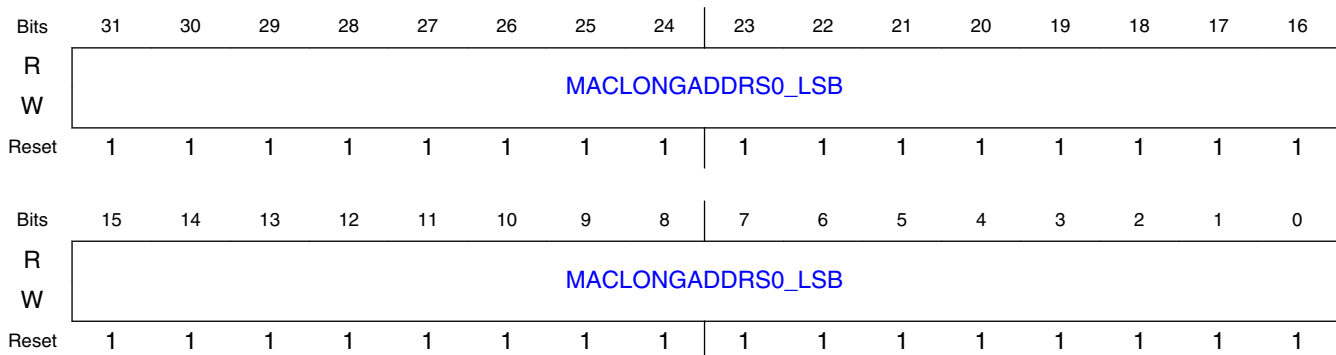

45.6.2.15.15.4 Fields

| Field | Function |
|-----------------------|--|
| 31-0 | MAC LONG ADDRESS for PAN0 LSB |
| MACLONGADD RS0_LSB | MAC Long Address for PAN0, for 64-bit destination addressing mode. The packet processor compares the incoming packet's Destination Address against the contents of this register to determine if the packet is addressed to this device. |

45.6.2.15.16 MAC LONG ADDRESS 0 MSB (MACLONGADDRS0_MSB)

45.6.2.15.16.1 Address

| Register | Offset |
|-----------------------|-----------|
| MACLONGADDRS0_MS B | 4005D038h |

45.6.2.15.16.2 Function

MAC LONG ADDRESS for PAN0 MSB

45.6.2.15.16.3 Diagram

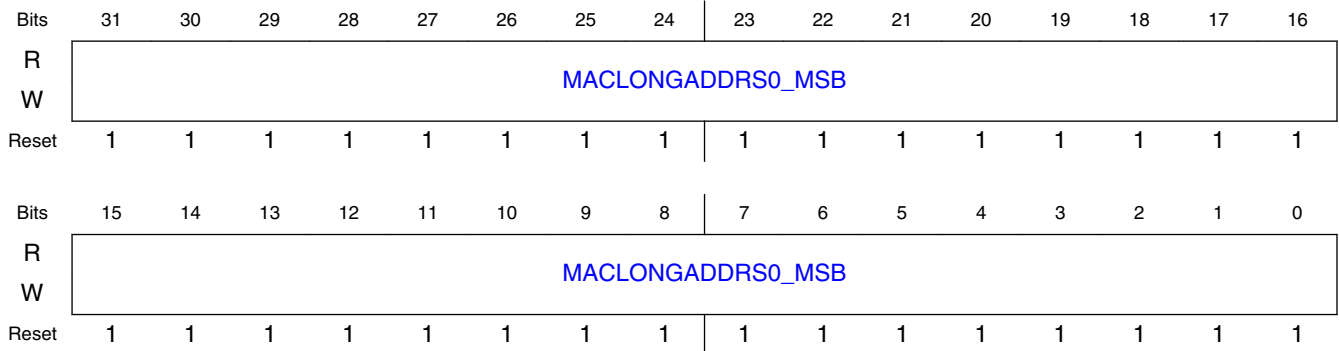

45.6.2.15.16.4 Fields

| Field | Function |
|-----------------------|--|
| 31-0 | MAC LONG ADDRESS for PAN0 MSB |
| MACLONGADD RS0_MSB | MAC Long Address for PAN0, for 64-bit destination addressing mode. The packet processor compares the incoming packet's Destination Address against the contents of this register to determine if the packet is addressed to this device. |

45.6.2.15.17 RECEIVE FRAME FILTER (RX_FRAME_FILTER)

45.6.2.15.17.1 Address

| Register | Offset |
|-----------------|-----------|
| RX_FRAME_FILTER | 4005D03Ch |

45.6.2.15.17.2 Function

RECEIVE FRAME FILTER

45.6.2.15.17.3 Diagram

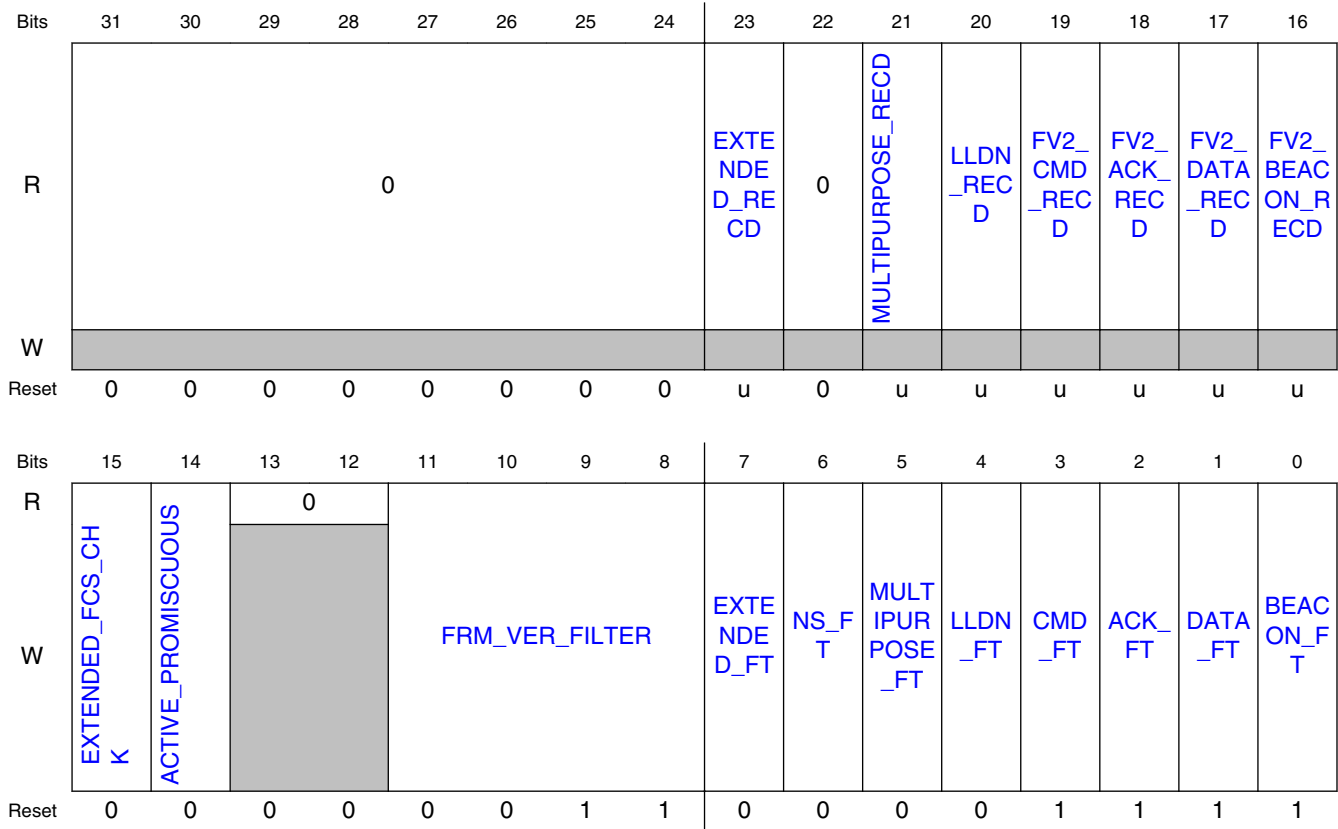

45.6.2.15.17.4 Fields

| Field | Function |
|--------------------------|--|
| 31-24 — | Reserved. |
| 23 EXTENDED_REC'D | Extended Packet Received 0b - The last packet received was not Frame Type EXTENDED 1b - The last packet received was Frame Type EXTENDED, and EXTENDED_FT=1 to allow such packets. |
| 22 — | Reserved. |
| 21 MULTIPURPOSE_REC'D | Multipurpose Packet Received 0b - last packet received was not Frame Type MULTIPURPOSE 1b - The last packet received was Frame Type MULTIPURPOSE, and MULTIPURPOSE_FT=1 to allow such packets. |
| 20 LLDN_REC'D | LLDN Packet Received 0b - The last packet received was not Frame Type LLDN 1b - The last packet received was Frame Type LLDN, and LLDN_FT=1 to allow such packets. |
| 19 | Frame Version 2 MAC Command Packet Received 0b - The last packet received was not Frame Type MAC Command with Frame Version 2 |

Table continues on the next page...

Link Layer

| Field | Function |
|------------------------------|---|
| FV2_CMD_REC D | 1b - The last packet received was Frame Type MAC Command with Frame Version 2, and FRM_VER_FILTER[2]=1 to allow such packets |
| 18 FV2_ACK_REC D | Frame Version 2 Acknowledge Packet Received 0b - The last packet received was not Frame Type Ack with Frame Version 2 1b - The last packet received was Frame Type Ack with Frame Version 2, and FRM_VER_FILTER[2]=1 to allow such packets |
| 17 FV2_DATA_RE CD | Frame Version 2 Data Packet Received 0b - The last packet received was not Frame Type Data with Frame Version 2 1b - The last packet received was Frame Type Data with Frame Version 2, and FRM_VER_FILTER[2]=1 to allow such packets |
| 16 FV2_BEACON_ RECD | Frame Version 2 Beacon Packet Received 0b - The last packet received was not Frame Type Beacon with Frame Version 2 1b - The last packet received was Frame Type Beacon with Frame Version 2, and FRM_VER_FILTER[2]=1 to allow such packets |
| 15 EXTENDED_FC S_CHK | Verify FCS on Frame Type Extended 0b - Packet Processor will not check FCS for Frame Type EXTENDED (default) 1b - Packet Processor will check FCS at end-of-packet based on packet length derived from PHR, for Frame Type EXTENDED |
| 14 ACTIVE_PROMI SCUOUS | Active Promiscuous 0b - normal operation 1b - Provide Data Indication on all received packets under the same rules which apply in PROMISCUOUS mode, however acknowledge those packets under rules which apply in non-PROMISCUOUS mode |
| 13-12 — | Reserved. |
| 11-8 FRM_VER_FILT ER | Frame Version selector. The incoming packet's Frame Control Field is parsed to obtain the FrameVersion subfield, and that value is compared against this register, in accordance with the following: xxx1: Accept received packets with FrameVersion=00 xx1x: Accept received packets with FrameVersion=01 x1xx: Accept received packets with FrameVersion=10 1xxx: Accept received packets with FrameVersion=11 These filtering rules apply to Beacon, Acknowledge, Data, and MAC Command Frame Types, since these frame types require a 2-octet Frame Control Field which embeds a 2-bit FrameVersion subfield. Later frame types introduced in the 802.15.4e addendum (LLDN, Multipurpose) don't guarantee a FrameVersion subfield with the original meaning, so these filtering rules do not apply to these frame types. See registers LLDN_FT and MULTIPURPOSE_FT. For Acknowledge frames, FrameVersion bits are ignored by the Packet Processor, irrespective of FRM_VER_FILTER. |
| 7 EXTENDED_FT | Extended Frame Type Enable 0b - reject all Extended frames 1b - Extended frame type enabled (Frame Type 7). |
| 6 NS_FT | "Not Specified" Frame Type Enable This bit enables reception of all Frame Types not covered by the other _FT bits in this register. 0b - reject all "Not Specified" frames 1b - Not-specified (reserved) frame type enabled. Applies to Frame Type 6. No packet filtering is performed, except for frame length checking (FrameLength >=5 and FrameLength <=127). No AUTOACK is transmitted for this Frame Type |
| 5 | Multipurpose Frame Type Enable 0b - reject all Multipurpose frames |

Table continues on the next page...

| Field | Function |
|-----------------|---|
| MULTIPURPOSE_FT | 1b - Multipurpose frame type enabled (Frame Type 5). |
| 4 LLDN_FT | LLDN Frame Type Enable 0b - reject all LLDN frames 1b - LLDN frame type enabled (Frame Type 4). |
| 3 CMD_FT | MAC Command Frame Type Enable 0b - reject all MAC Command frames 1b - MAC Command frame type enabled. |
| 2 ACK_FT | Ack Frame Type Enable 0b - reject all Acknowledge frames 1b - Acknowledge frame type enabled. |
| 1 DATA_FT | Data Frame Type Enable 0b - reject all Beacon frames 1b - Data frame type enabled. |
| 0 BEACON_FT | Beacon Frame Type Enable 0b - reject all Beacon frames 1b - Beacon frame type enabled. |

45.6.2.15.18 CCA AND LQI CONTROL (CCA_LQI_CTRL)

45.6.2.15.18.1 Address

| Register | Offset |
|--------------|-----------|
| CCA_LQI_CTRL | 4005D040h |

45.6.2.15.18.2 Diagram

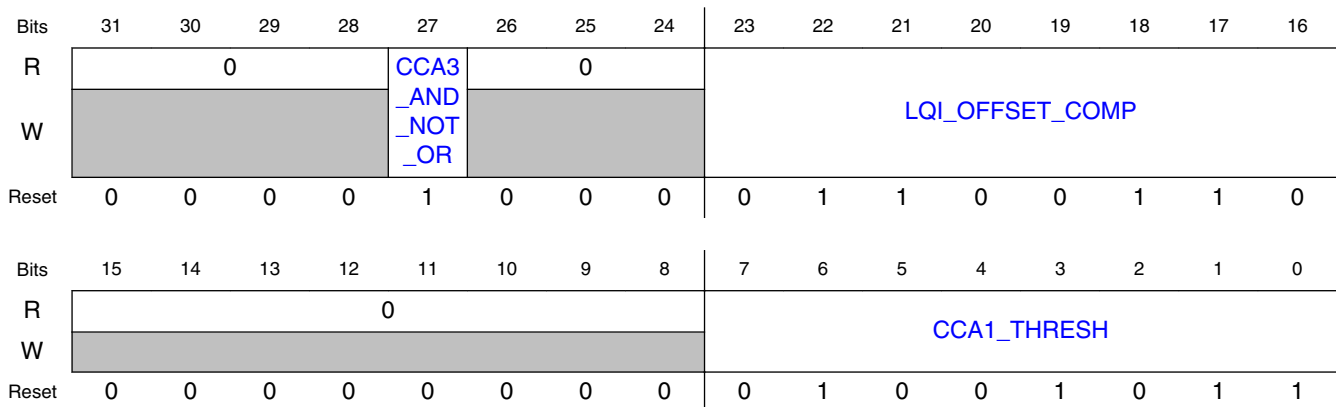

45.6.2.15.18.3 Fields

| Field | Function |
|------------------------------|--|
| 31-28 — | Reserved. |
| 27 CCA3_AND_NO T_OR | CCA Mode 3 AND not OR Determines the way CCA3 is required to be detected 0b - CCA1 or CCA2 1b - CCA1 and CCA2 |
| 26-24 — | Reserved. |
| 23-16 LQI_OFFSET_C OMP | LQI Offset Compensation Programmable amount to offset RSSI based LQI value |
| 15-8 — | Reserved. |
| 7-0 CCA1_THRESH | CCA Mode 1 Threshold Programmable energy threshold register for CCA mode 1. |

45.6.2.15.19 CCA2 CONTROL (CCA2_CTRL)**45.6.2.15.19.1 Address**

| Register | Offset |
|-----------|-----------|
| CCA2_CTRL | 4005D044h |

45.6.2.15.19.2 Function

CCA Mode 2 Control

45.6.2.15.19.3 Diagram

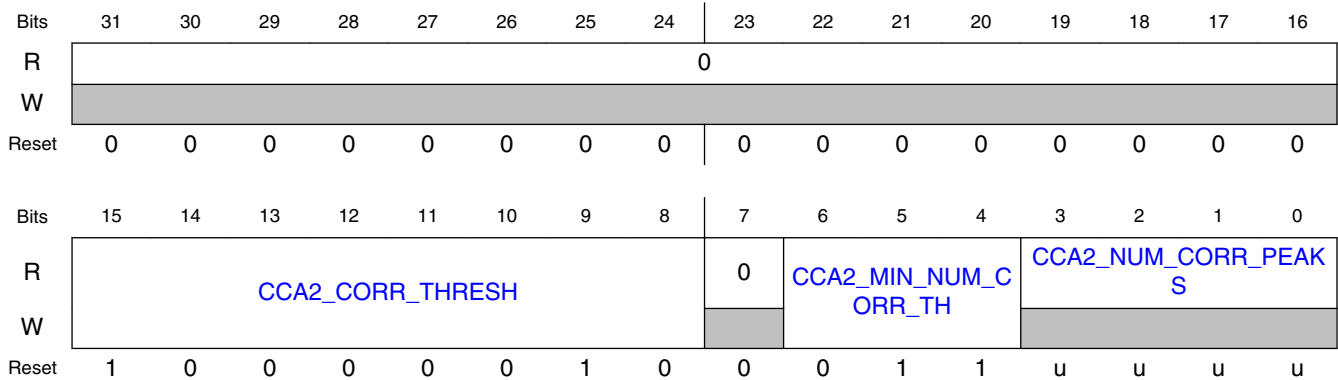

45.6.2.15.19.4 Fields

| Field | Function |
|---------------------------------|---|
| 31-16 — | Reserved. |
| 15-8 CCA2_CORR_T HRESH | CCA Mode 2 Correlation Threshold Correlator threshold used to qualify correlator peaks counted by CCA2_NUM_CORR_PEAKS. Correlator peaks exceeding this value increment CCA2_NUM_CORR_PEAKS. |
| 7 — | Reserved. |
| 6-4 CCA2_MIN_NU M_CORR_TH | CCA Mode 2 Threshold Number of Correlation Peaks Programmable threshold to be compared against number of correlation peaks that exceeded CCA2_CORR_THRESH for detecting CCA mode 2. Number of peaks detected = CCA2_MIN_NUM_CORR_TH + 1; Example: If it is programmed to 3, CCA2 logic looks for at least 4 correlation peaks that crossed the threshold, to indicate channel is idle or busy. |
| 3-0 CCA2_NUM_C ORR_PEAKS | CCA Mode 2 Number of Correlation Peaks Detected Counts of number of peaks that crossed CCA2_CORR_THRESH in CCA Mode 2 operation |

45.6.2.15.20 DSM CONTROL (DSM_CTRL)

45.6.2.15.20.1 Address

| Register | Offset |
|----------|-----------|
| DSM_CTRL | 4005D04Ch |

45.6.2.15.20.2 Diagram

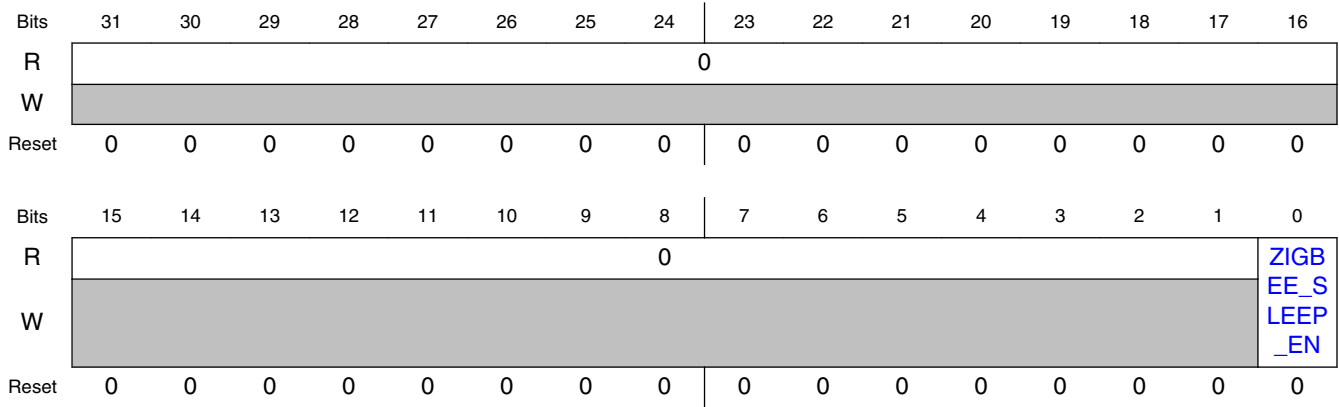

45.6.2.15.20.3 Fields

| Field | Function |
|----------------------|---|
| 31-1 Reserved | Reserved. |
| 0 ZIGBEE_SLEEP_EN | 802.15.4 sleep enable If ZIGBEE_SLEEP_EN=1, enter DSM and freeze EVENT_TMR when ZIG_SLEEP matches DSM_TIMER. Note: ZIG_SLEEP and DSM_TIMER registers reside in RSIM space. |

45.6.2.15.21 BSM CONTROL (BSM_CTRL)

45.6.2.15.21.1 Address

| Register | Offset |
|----------|-----------|
| BSM_CTRL | 4005D050h |

45.6.2.15.21.2 Diagram

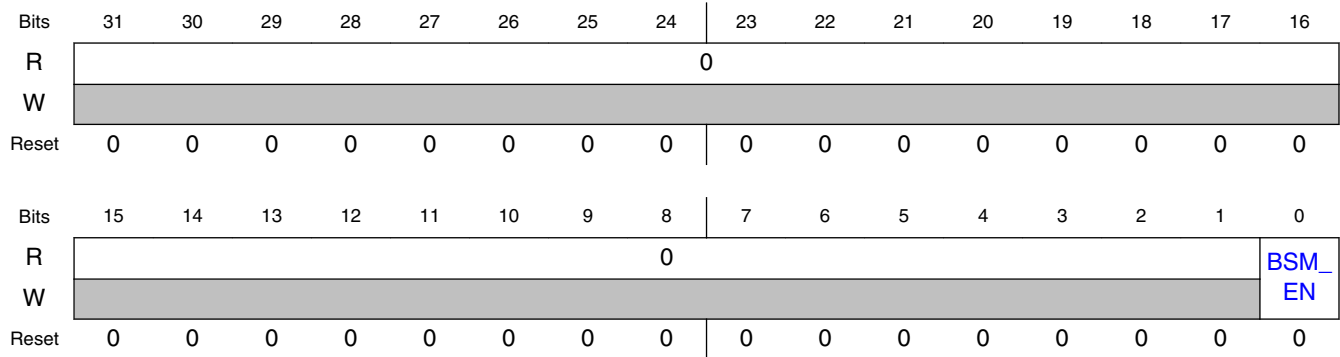

45.6.2.15.21.3 Fields

| Field | Function |
|------------------|---|
| 31-1 Reserved | Reserved. |
| 0 BSM_EN | BSM Enable 0b - 802.15.4 Bit Streaming Mode Disabled 1b - 802.15.4 Bit Streaming Mode Enabled |

45.6.2.15.22 MAC SHORT ADDRESS FOR PAN1 (MACSHORTADDRS1)

45.6.2.15.22.1 Address

| Register | Offset |
|----------------|-----------|
| MACSHORTADDRS1 | 4005D054h |

45.6.2.15.22.2 Function

The MACSHORTADDRS1 register .

45.6.2.15.22.3 Diagram

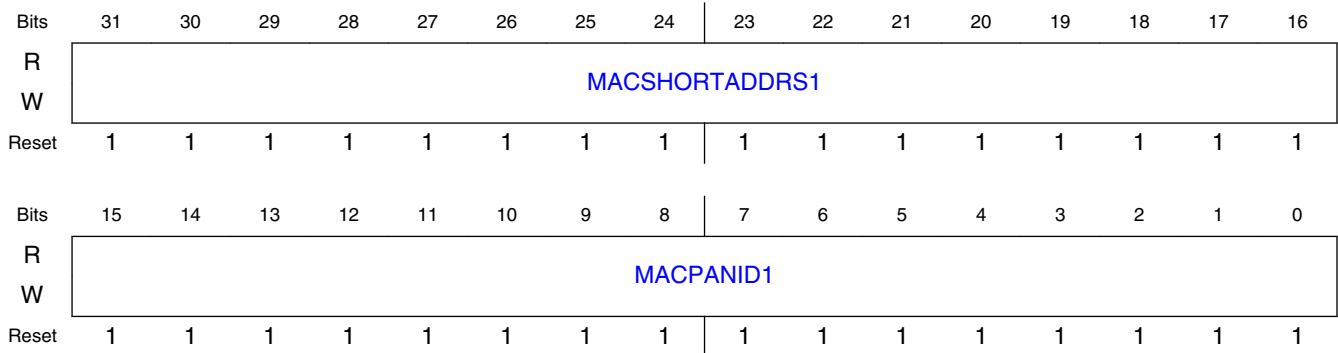

45.6.2.15.22.4 Fields

| Field | Function |
|----------------|---|
| 31-16 | MAC SHORT ADDRESS for PAN1 |
| MACSHORTADDRS1 | MAC Short Address for PAN1, for 16-bit destination addressing mode. The packet processor compares the incoming packet's Destination Address against the contents of this register to determine if the packet is addressed to this device. |
| 15-0 | MAC PAN ID for PAN1 |
| MACPANID1 | MAC PAN ID for PAN1. The packet processor compares the incoming packet's Destination PAN ID against the contents of this register to determine if the packet is addressed to this device; or if the incoming packet is a Beacon frame, the packet processor compares the incoming packet Source PAN ID against this register. Also, if PANCORDNTR1=1, and the incoming packet has no Destination Address field, and if the incoming packet is a Data or MAC Command frame, the packet processor compares the incoming packet Source PAN ID against this register. |

45.6.2.15.23 MAC LONG ADDRESS 1 LSB (MACLONGADDRS1_LSB)

45.6.2.15.23.1 Address

| Register | Offset |
|-------------------|-----------|
| MACLONGADDRS1_LSB | 4005D058h |

45.6.2.15.23.2 Function

MAC Long Address for PAN1, for 64-bit destination addressing mode. The packet processor compares the incoming packet's Destination Address against the contents of this register to determine if the packet is addressed to this device.

45.6.2.15.23.3 Diagram

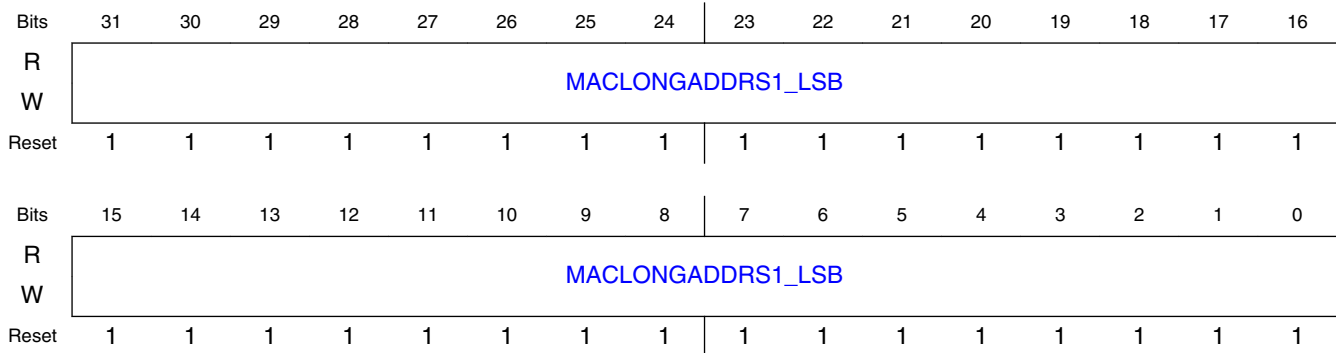

45.6.2.15.23.4 Fields

| Field | Function |
|-------------------|--|
| 31-0 | MAC LONG ADDRESS for PAN1 LSB |
| MACLONGADDRS1_LSB | MAC Long Address for PAN1, for 64-bit destination addressing mode. The packet processor compares the incoming packet's Destination Address against the contents of this register to determine if the packet is addressed to this device. |

45.6.2.15.24 MAC LONG ADDRESS 1 MSB (MACLONGADDRS1_MSB)

45.6.2.15.24.1 Address

| Register | Offset |
|-------------------|-----------|
| MACLONGADDRS1_MSB | 4005D05Ch |

45.6.2.15.24.2 Function

MAC Long Address for PAN1, for 64-bit destination addressing mode. The packet processor compares the incoming packet's Destination Address against the contents of this register to determine if the packet is addressed to this device.

45.6.2.15.24.3 Diagram

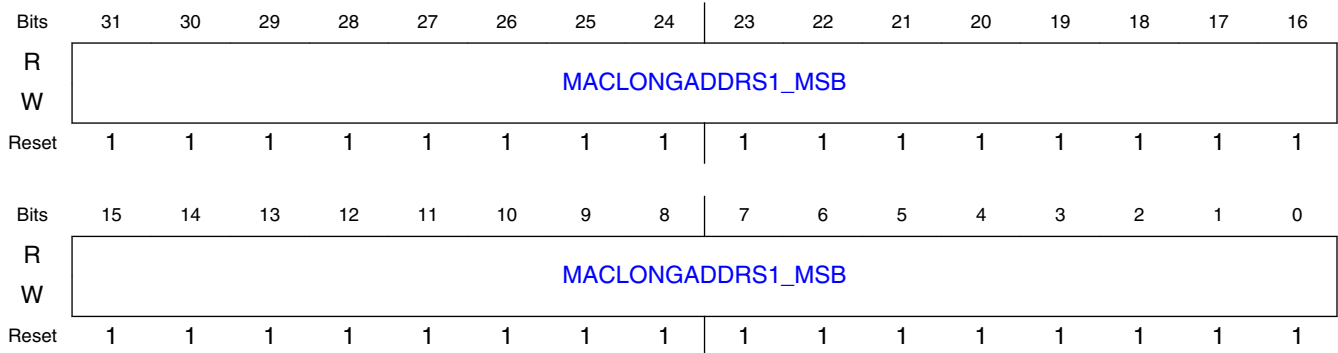

45.6.2.15.24.4 Fields

| Field | Function |
|-----------------------|--|
| 31-0 | MAC LONG ADDRESS for PAN1 MSB |
| MACLONGADD RS1_MSB | MAC Long Address for PAN1, for 64-bit destination addressing mode. The packet processor compares the incoming packet's Destination Address against the contents of this register to determine if the packet is addressed to this device. |

45.6.2.15.25 DUAL PAN CONTROL (DUAL_PAN_CTRL)

45.6.2.15.25.1 Address

| Register | Offset |
|---------------|-----------|
| DUAL_PAN_CTRL | 4005D060h |

45.6.2.15.25.2 Function

Dual PAN Control Register

45.6.2.15.25.3 Diagram

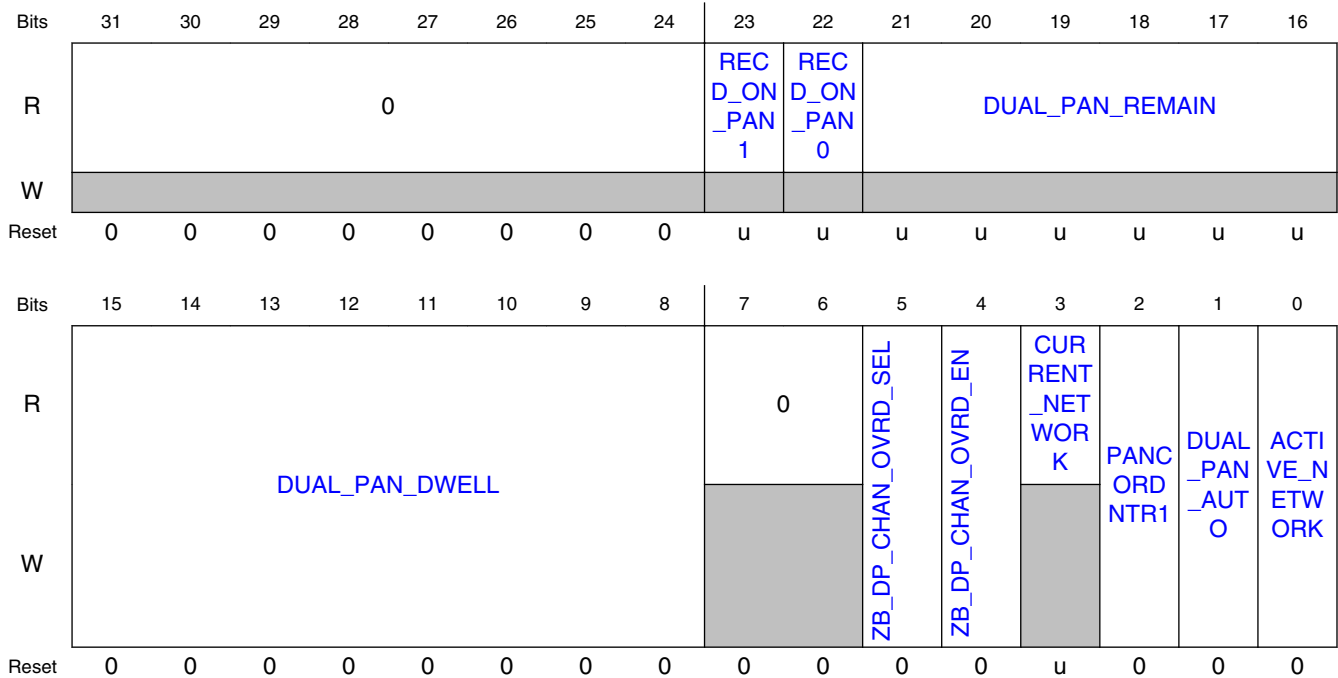

45.6.2.15.25.4 Fields

| Field | Function |
|--------------------------|---|
| 31-24 — | Reserved. |
| 23 RECD_ON_PAN1 | Last Packet was Received on PAN1 Indicates the packet which was just received, was received on PAN1. In Dual PAN mode operating on 2 different channels, RECD_ON_PAN1 will be set if CURRENT_NETWORK=1 when the packet was received, regardless of FILTERFAIL status. In DUAL PAN mode operating with same channel on both networks, CURRENT_NETWORK will be ignored and RECD_ON_PAN1 will be set only if a valid packet was received on PAN1 (PAN1's FILTERFAIL_FLAG is deasserted). RECD_ON_PAN1 remains valid until the start of the next autosequence. |
| 22 RECD_ON_PAN0 | Last Packet was Received on PAN0 Indicates the packet which was just received, was received on PAN0. In Dual PAN mode operating on 2 different channels, RECD_ON_PAN0 will be set if CURRENT_NETWORK=0 when the packet was received, regardless of FILTERFAIL status. In DUAL PAN mode operating with same channel on both networks, CURRENT_NETWORK will be ignored and RECD_ON_PAN0 will be set only if a valid packet was received on PAN0 (PAN0's FILTERFAIL_FLAG is deasserted). RECD_ON_PAN0 remains valid until the start of the next autosequence. |
| 21-16 DUAL_PAN_REMAIN | Time Remaining before next PAN switch in auto Dual PAN mode This read-only register indicates time remaining before next PAN switch in auto Dual PAN mode. The units for this register, depend on the PRESCALER setting (bits [1:0]) in the DUAL_PAN_DWELL register, according to the following table: |

Table continues on the next page...

| Field | Function | | | | | | | | | | | | | | | | |
|--------------------------|---|------------------------------|------------------------|-----------------------|---------------------|----|-------|------------|----|-------|-------------|----|------|------------|----|------|-------------------|
| | DUAL_PAN_DWELL PRESCALER | DUAL_PAN_REMAIN UNITS | | | | | | | | | | | | | | | |
| | 00 | 0.5ms | | | | | | | | | | | | | | | |
| | 01 | 2.5ms | | | | | | | | | | | | | | | |
| | 10 | 10ms | | | | | | | | | | | | | | | |
| | 11 | 50ms | | | | | | | | | | | | | | | |
| | <p>The readback value indicates that between N-1 and N timebase units remain until the next PAN switch. For example, a DUAL_PAN_REMAIN readback value of 3, with a DUAL_PAN_DWELL PRESCALER setting of 2 (10ms), indicates that between 20ms (2*10ms) and 30ms (3*10ms), remain until the next automatic PAN switch.</p> | | | | | | | | | | | | | | | | |
| 15-8 DUAL_PAN_DWELL | <p>Dual PAN Channel Frequency Dwell Time</p> <p>Channel Frequency Dwell Time. In Auto Dual PAN mode, hardware will toggle the PAN, after dwelling on the current PAN for the interval described below (assuming Preamble/SFD not detected). A write to DUAL_PAN_DWELL, always re-initializes the DWELL TIMER to the programmed value. If a write to DUAL_PAN_DWELL occurs during an autosequence, the DWELL TIMER will begin counting down immediately. If a write to DUAL_PAN_DWELL occurs when there is no autosequence underway, the DWELL TIMER will not begin counting until the next autosequence begins; it will begin counting at the start of the sequence warmup.</p> <table border="1"> <thead> <tr> <th>PRESCALER (bits [1:0])</th> <th>TIMEBASE (bits [7:2])</th> <th>RANGE (min) - (max)</th> </tr> </thead> <tbody> <tr> <td>00</td> <td>0.5ms</td> <td>0.5 - 32ms</td> </tr> <tr> <td>01</td> <td>2.5ms</td> <td>2.5 - 160ms</td> </tr> <tr> <td>10</td> <td>10ms</td> <td>10 - 640ms</td> </tr> <tr> <td>11</td> <td>50ms</td> <td>50ms - 3.2seconds</td> </tr> </tbody> </table> <p>A write to DUAL_PAN_DWELL also causes the value of ACTIVE_NETWORK to get latched into the hardware. This latched value will be the starting point for the automatic dual-pan mode (i.e., start on PAN0 or on PAN1). The starting value takes effect immediately (if sequence is underway and DUAL_PAN_AUTO=1), or is otherwise delayed until sequence starts and DUAL_PAN_AUTO=1.</p> | | PRESCALER (bits [1:0]) | TIMEBASE (bits [7:2]) | RANGE (min) - (max) | 00 | 0.5ms | 0.5 - 32ms | 01 | 2.5ms | 2.5 - 160ms | 10 | 10ms | 10 - 640ms | 11 | 50ms | 50ms - 3.2seconds |
| PRESCALER (bits [1:0]) | TIMEBASE (bits [7:2]) | RANGE (min) - (max) | | | | | | | | | | | | | | | |
| 00 | 0.5ms | 0.5 - 32ms | | | | | | | | | | | | | | | |
| 01 | 2.5ms | 2.5 - 160ms | | | | | | | | | | | | | | | |
| 10 | 10ms | 10 - 640ms | | | | | | | | | | | | | | | |
| 11 | 50ms | 50ms - 3.2seconds | | | | | | | | | | | | | | | |
| 7-6 — | Reserved. | | | | | | | | | | | | | | | | |
| 5 ZB_DP_CHAN_OVRD_SEL | <p>Dual PAN Channel Override Selector</p> <p>This bit works with ZB_DP_CHAN_OVRD_EN to allow one of the two Dual PAN channels to use Direct Frequency programming. See description for ZB_DP_CHAN_OVRD_EN.</p> | | | | | | | | | | | | | | | | |
| 4 ZB_DP_CHAN_OVRD_EN | <p>Dual PAN Channel Override Enable</p> <p>In Dual PAN mode, in case there is a need to generate a frequency which may be offset from the 16 prescribed 5MHz-spaced channels, to, for example, avoid interference on one of the Dual PAN channels, a method has been provided to accomplish that, by designating one of the two PAN channels to use the transceiver's set of direct frequency-programming registers, instead of CHANNEL_NUMx. Programming the direct frequency-programming registers -- integer, numerator, and denominator, allows an RF frequency to be selected with much more precision than the 5MHz granularity of the 802.15.4 mapped-channel registers, CHANNEL_NUM0 and CHANNEL_NUM1.</p> | | | | | | | | | | | | | | | | |

Table continues on the next page...

| Field | Function | | | | | | | | | | | | | | | | |
|----------------------|---|----------------------------------|----------------------------------|----------------------------------|----------------------------------|---|---|-------------------|-------------------|---|---|------------------------------|-------------------|---|---|-------------------|------------------------------|
| | <p>Two bits have been provided in 802.15.4 space to realize this feature: ZB_DP_CHAN_OVRD_SEL and ZB_DP_CHAN_OVRD_EN. When ZB_DP_CHAN_OVRD_EN=1, this enables one of the Dual PAN channels to use the direct frequency programming. The ZB_DP_CHAN_OVRD_SEL bit determines which channel uses the direct programming, according to the following table:</p> <table border="1"> <thead> <tr> <th>ZB_DP_CHAN_OVRD_EN</th> <th>ZB_DP_CHAN_OVRD_SEL</th> <th>PAN0 Frequency Determined by ...</th> <th>PAN1 Frequency Determined by ...</th> </tr> </thead> <tbody> <tr> <td>0</td> <td>X</td> <td>CHANNEL_NUM0[6:0]</td> <td>CHANNEL_NUM1[6:0]</td> </tr> <tr> <td>1</td> <td>0</td> <td>DIRECT FREQUENCY PROGRAMMING</td> <td>CHANNEL_NUM1[6:0]</td> </tr> <tr> <td>1</td> <td>1</td> <td>CHANNEL_NUM0[6:0]</td> <td>DIRECT FREQUENCY PROGRAMMING</td> </tr> </tbody> </table> <p>Direct Frequency Programming is accomplished by setting the PLL's Integer, Numerator, and Denominator registers to the appropriate values for the desired RF frequency.</p> | ZB_DP_CHAN_OVRD_EN | ZB_DP_CHAN_OVRD_SEL | PAN0 Frequency Determined by ... | PAN1 Frequency Determined by ... | 0 | X | CHANNEL_NUM0[6:0] | CHANNEL_NUM1[6:0] | 1 | 0 | DIRECT FREQUENCY PROGRAMMING | CHANNEL_NUM1[6:0] | 1 | 1 | CHANNEL_NUM0[6:0] | DIRECT FREQUENCY PROGRAMMING |
| ZB_DP_CHAN_OVRD_EN | ZB_DP_CHAN_OVRD_SEL | PAN0 Frequency Determined by ... | PAN1 Frequency Determined by ... | | | | | | | | | | | | | | |
| 0 | X | CHANNEL_NUM0[6:0] | CHANNEL_NUM1[6:0] | | | | | | | | | | | | | | |
| 1 | 0 | DIRECT FREQUENCY PROGRAMMING | CHANNEL_NUM1[6:0] | | | | | | | | | | | | | | |
| 1 | 1 | CHANNEL_NUM0[6:0] | DIRECT FREQUENCY PROGRAMMING | | | | | | | | | | | | | | |
| 3 CURRENT_NETWORK | <p>Indicates which PAN is currently selected by hardware</p> <p>This read-only bit indicates which PAN is currently selected by hardware in automatic Dual PAN mode</p> <p>0b - PAN0 is selected 1b - PAN1 is selected</p> | | | | | | | | | | | | | | | | |
| 2 PANCORDNTR1 | <p>Device is a PAN Coordinator on PAN1</p> <p>Device is a PAN Coordinator on PAN1. Allows device to receive packets with no destination address, if Source PAN ID matches.</p> | | | | | | | | | | | | | | | | |
| 1 DUAL_PAN_AUTO | <p>Activates automatic Dual PAN operating mode</p> <p>Activates automatic Dual PAN operating mode. In this mode, PAN-switching is controlled by hardware at a pre-programmed rate, determined by DUAL_PAN_DWELL.</p> <p>0: Manual Dual PAN mode (or Single PAN mode). 1: Auto Dual PAN Mode</p> <p>Whenever DUAL_PAN_AUTO=0, CURRENT_NETWORK=ACTIVE_NETWORK at all times. In other words, software directly controls which PAN is selected. Whenever DUAL_PAN_AUTO=1, CURRENT_NETWORK is controlled by hardware.</p> | | | | | | | | | | | | | | | | |
| 0 ACTIVE_NETWORK | <p>Active Network Selector</p> <p>Selects the PAN on which to transceive, by activating a PAN parameter set (PAN0 or PAN1). In Manual Dual PAN mode (or Single PAN mode), this bit selects the active PAN parameter set (channel and addressing parameters) which governs all autosequences. In Auto Dual PAN mode, this bit selects the PAN on which to begin transceiving, latched at the point at which DUAL_PAN_DWELL register is written.</p> <p>0b - Select PAN0 1b - Select PAN1</p> | | | | | | | | | | | | | | | | |

45.6.2.15.26 CHANNEL NUMBER 1 (CHANNEL_NUM1)

45.6.2.15.26.1 Address

| Register | Offset |
|--------------|-----------|
| CHANNEL_NUM1 | 4005D064h |

45.6.2.15.26.2 Diagram

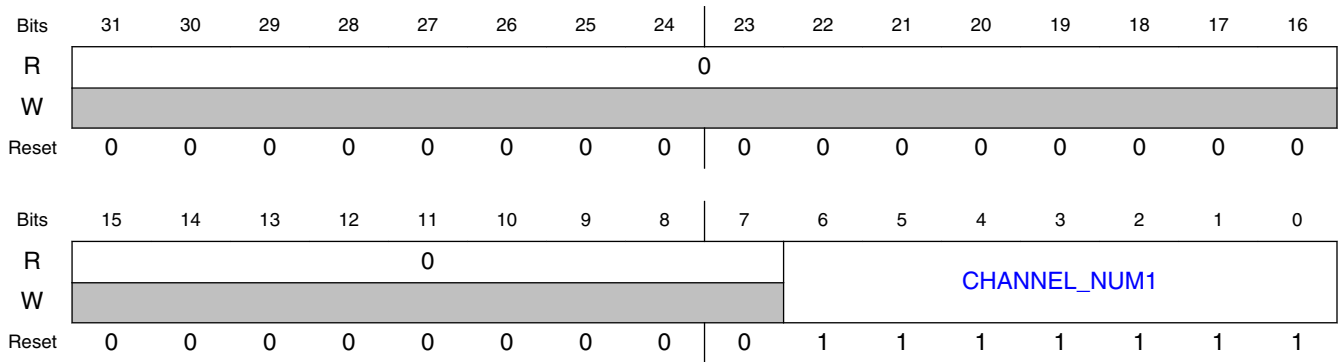

45.6.2.15.26.3 Fields

| Field | Function |
|---------------------|---|
| 31-7 Reserved | Reserved. |
| 6-0 CHANNEL_NUM1 | <p>Channel Number for PAN1</p> <p>This is the mapped channel number used to transmit and receive 802.15.4 packets. This register applies to PAN1 only. CHANNEL_NUM1 should be in the range: $11 \leq \text{CHANNEL_NUM1} \leq 26$</p> <p>Note: This register should not be programmed, and left in its default state, if Dual PAN mode is not in use.</p> |

45.6.2.15.27 SAM CONTROL (SAM_CTRL)

45.6.2.15.27.1 Address

| Register | Offset |
|----------|-----------|
| SAM_CTRL | 4005D068h |

45.6.2.15.27.2 Function

Source Address Management Control Register

45.6.2.15.27.3 Diagram

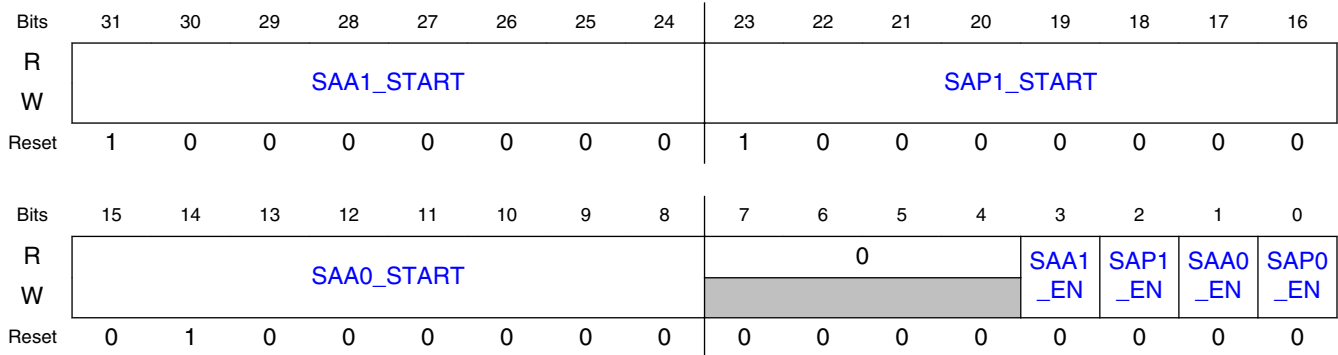

45.6.2.15.27.4 Fields

| Field | Function |
|---------------------|--|
| 31-24 SAA1_START | First Index of SAA1 partition |
| 23-16 SAP1_START | First Index of SAP1 partition |
| 15-8 SAA0_START | First Index of SAA0 partition |
| 7-4 — | Reserved. |
| 3 SAA1_EN | Enables SAA1 Partition of the SAM Table 0b - Disables SAA1 Partition 1b - Enables SAA1 Partition |
| 2 SAP1_EN | Enables SAP1 Partition of the SAM Table 0b - Disables SAP1 Partition 1b - Enables SAP1 Partition |
| 1 SAA0_EN | Enables SAA0 Partition of the SAM Table 0b - Disables SAA0 Partition 1b - Enables SAA0 Partition |
| 0 SAP0_EN | Enables SAP0 Partition of the SAM Table 0b - Disables SAP0 Partition 1b - Enables SAP0 Partition |

45.6.2.15.28 SOURCE ADDRESS MANAGEMENT TABLE (SAM_TABLE)

45.6.2.15.28.1 Address

| Register | Offset |
|-----------|-----------|
| SAM_TABLE | 4005D06Ch |

45.6.2.15.28.2 Function

Source Address Management Table

45.6.2.15.28.3 Diagram

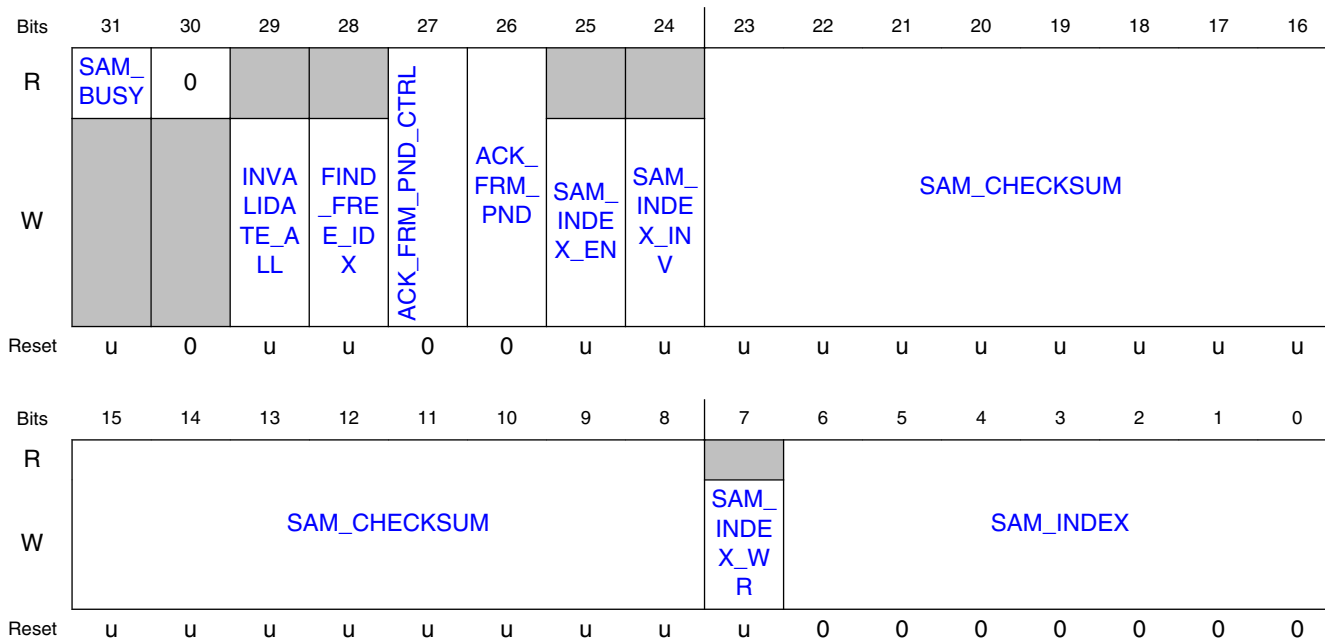

45.6.2.15.28.4 Fields

| Field | Function |
|----------------------|--|
| 31 SAM_BUSY | SAM Table Update Status Bit Hardware is in the process of updating the Source Address table, either in response to a poll indication from the packet processor, or due to software setting FIND_FREE_IDX=1. In the latter case, software should poll SAM_BUSY until low before accessing the "First Free Index" registers. Read-only bit. |
| 30 — | Reserved. |
| 29 INVALIDATE_ALL | Invalidate Entire SAM Table Writing a 1 to this bit clears all 128 Valid bits. Invalidates the entire table. Write-only bit. Writing 0 to this bit has no effect. Readback value is indeterminate. |
| 28 FIND_FREE_IDX | Find First Free Index After modifying Valid bits (enabling or invalidating), write this bit to 1 to force hardware to update the "First Free Index" registers to account for the changed Valid bits. This hardware update process takes 4us. Software can poll SAM_BUSY to determine when the table update is complete. Write-only bit. Writing 0 to this bit has no effect. Readback value is indeterminate. |
| 27 | Manual Control for AutoTxAck FramePending field |

Table continues on the next page...

| Field | Function |
|----------------------|--|
| ACK_FRM_PND_CTRL | 0b - the FramePending field of the Frame Control Field of the next automatic TX acknowledge packet is determined by hardware 1b - the FramePending field of the Frame Control Field of the next automatic TX acknowledge packet tracks ACK_FRM_PEND |
| 26 ACK_FRM_PND | State of AutoTxAck FramePending field when SAM Acceleration is Disabled Software can take manual control of the FramePending field of the Frame Control Field of the next automatic TX acknowledge packet, by setting ACK_FRM_PND_CTRL=1; in that case FramePending will track the state of this bit. The FramePending field also tracks this bit if Source Address Management is completely disabled, i.e., SAP0_EN=SAA0_EN=SAP1_EN=SAA1_EN=0 Otherwise, the FramePending field is determined by Source Address Management (SAM) hardware. |
| 25 SAM_INDEX_EN | Enable the SAM table index selected by SAM_INDEX |
| 24 SAM_INDEX_INV | Invalidate the SAM table index selected by SAM_INDEX |
| 23-8 SAM_CHECKSUM | Software-computed source address checksum, to be installed into a table index Software-computed source address checksum, to be installed into a table index. The value on SAM_CHECKSUM[15:0] can be installed into the table with a single, atomic 32-bit write; in that case, the write data would contain the desired SAM_INDEX[6:0] and SAM_CHECKSUM[15:0], and SAM_INDEX_WR=1. If SAM_INDEX_WR=0, then the SAM_INDEX[6:0] register is written, but the checksum is <i>not</i> written to the table. The readback value of SAM_CHECKSUM[15:0] is the contents of the SAM Table at the location pointed to by SAM_INDEX[6:0]. To readback from a specific table index, software should first write the desired index to SAM_INDEX[6:0], and then read back the checksum from the table on SAM_CHECKSUM[15:0]. |
| 7 SAM_INDEX_WR | Enables SAM Table Contents to be updated For 32-bit writes, SAM_INDEX_WR must be set to indicate that the table entry specified by SAM_INDEX[6:0] is to be written; if SAM_INDEX_WR=0, the table entry is not written, but the SAM_INDEX[6:0] register is updated. For 8-bit writes, this bit is ignored. |
| 6-0 SAM_INDEX | Contains the SAM table index to be enabled or invalidated Contains the table index to be enabled or invalidated. Software must ensure that the index is within the range of the desired partition. |

45.6.2.15.29 SOURCE ADDRESS MANAGEMENT MATCH (SAM_MATCH)

45.6.2.15.29.1 Address

| Register | Offset |
|-----------|-----------|
| SAM_MATCH | 4005D070h |

45.6.2.15.29.2 Diagram

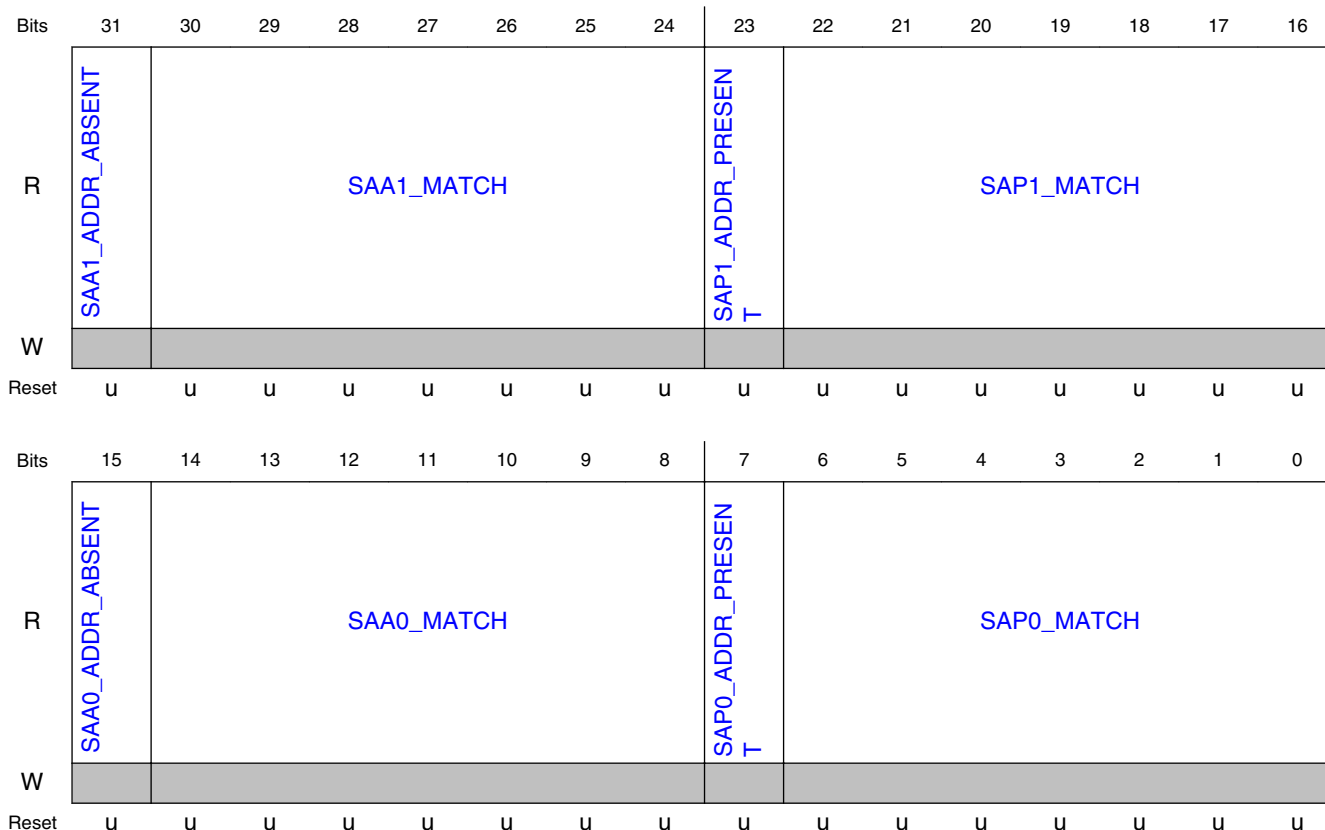

45.6.2.15.29.3 Fields

| Field | Function |
|-----------------------------|--|
| 31 SAA1_ADDR_A BSENT | A Checksum Match is Absent in the SAP1 Partition of the SAM Table |
| 30-24 SAA1_MATCH | Index in the SAA1 Partition of the SAM Table corresponding to the first checksum match |
| 23 SAP1_ADDR_P RESENT | A Checksum Match is Present in the SAP1 Partition of the SAM Table |
| 22-16 SAP1_MATCH | Index in the SAP1 Partition of the SAM Table corresponding to the first checksum match |
| 15 SAA0_ADDR_A BSENT | A Checksum Match is Absent in the SAA0 Partition of the SAM Table |
| 14-8 SAA0_MATCH | Index in the SAA0 Partition of the SAM Table corresponding to the first checksum match |

Table continues on the next page...

| Field | Function |
|----------------------------|--|
| 7 SAP0_ADDR_P RESENT | A Checksum Match is Present in the SAP0 Partition of the SAM Table |
| 6-0 SAP0_MATCH | Index in the SAP0 Partition of the SAM Table corresponding to the first checksum match |

45.6.2.15.30 SAM FREE INDEX (SAM_FREE_IDX)

45.6.2.15.30.1 Address

| Register | Offset |
|--------------|-----------|
| SAM_FREE_IDX | 4005D074h |

45.6.2.15.30.2 Diagram

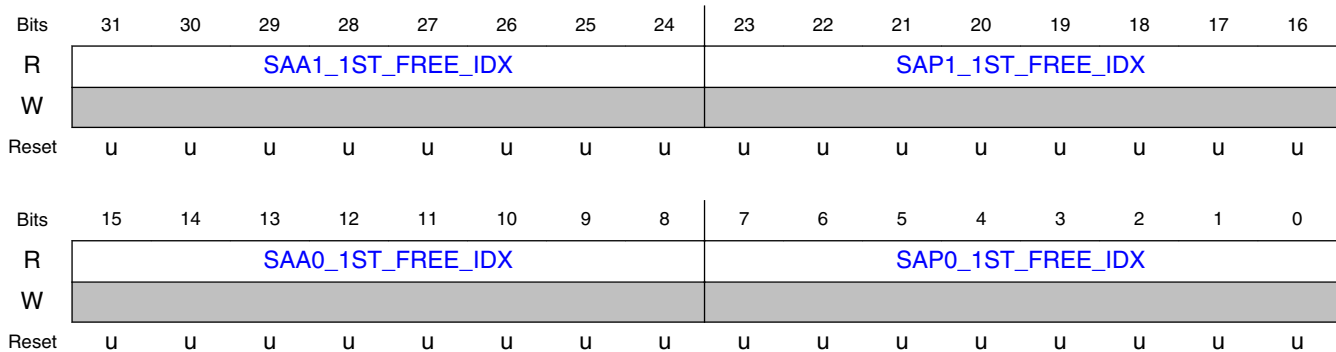

45.6.2.15.30.3 Fields

| Field | Function |
|--------------------------------|---|
| 31-24 SAA1_1ST_FR EE_IDX | First non-enabled (invalid) index in the SAA1 partition |
| 23-16 SAP1_1ST_FR EE_IDX | First non-enabled (invalid) index in the SAP1 partition |
| 15-8 SAA0_1ST_FR EE_IDX | First non-enabled (invalid) index in the SAA0 partition |

Table continues on the next page...

Link Layer

| Field | Function |
|------------------------------|---|
| 7-0 SAP0_1ST_FR EE_IDX | First non-enabled (invalid) index in the SAP0 partition |

45.6.2.15.31 SEQUENCE CONTROL AND STATUS (SEQ_CTRL_STS)

45.6.2.15.31.1 Address

| Register | Offset |
|--------------|-----------|
| SEQ_CTRL_STS | 4005D078h |

45.6.2.15.31.2 Diagram

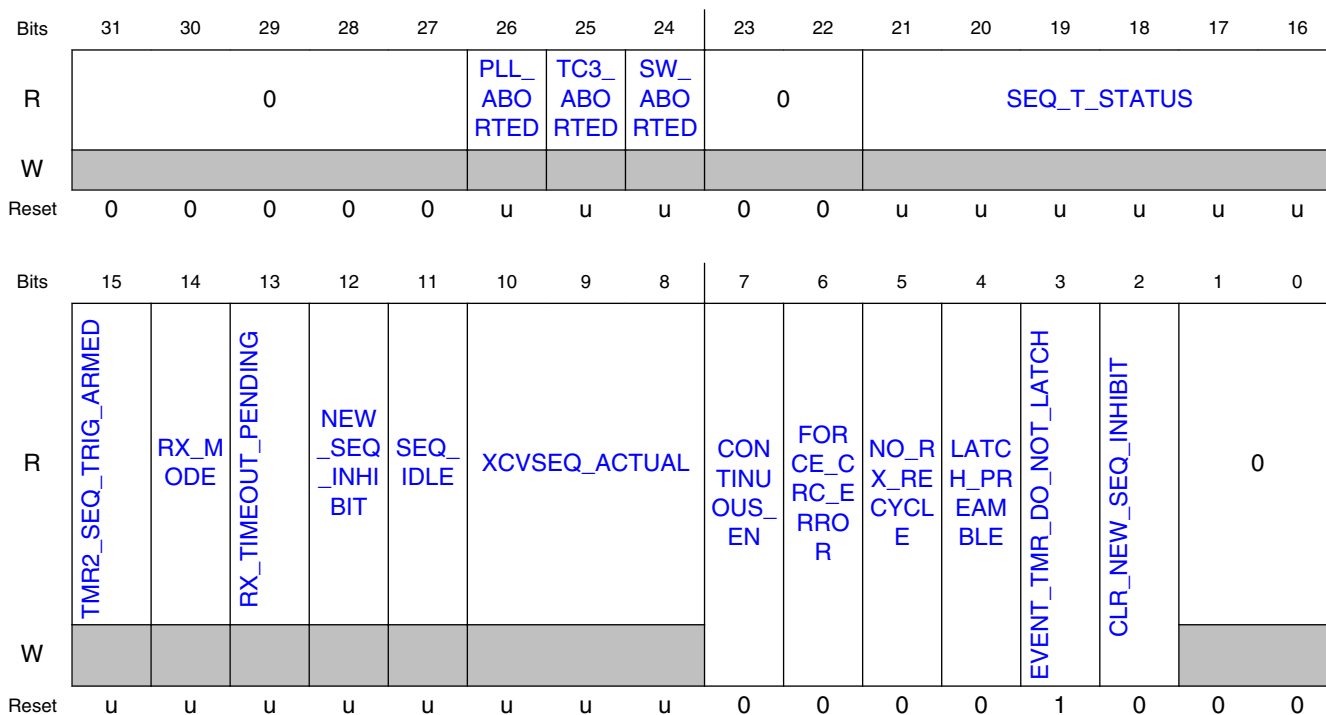

45.6.2.15.31.3 Fields

| Field | Function |
|------------|-----------|
| 31-27 — | Reserved. |

Table continues on the next page...

| Field | Function |
|-------------------------------|--|
| 26 PLL_ABORTED | Autosequence has terminated due to an PLL unlock event when asserted, indicates that the autosequence has terminated due to an PLL unlock event. This bit is valid at the SEQIRQ interrupt. Hardware will maintain this bit asserted until the next autosequence commences. Read-only bit. |
| 25 TC3_ABORTED | autosequence has terminated due to an TMR3 timeout when asserted, indicates that the autosequence has terminated due to an TC3 (TMR3) timeout during a receive operation. This bit is valid at the SEQIRQ interrupt. Hardware will maintain this bit asserted until the next autosequence commences. Read-only bit. |
| 24 SW_ABORTED | Autosequence has terminated due to a Software abort. when asserted, indicates that the autosequence has terminated due to an Software abort. Software can abort any programmed autosequence by writing Sequence I to XCVSEQ. This bit is valid at the SEQIRQ interrupt. Hardware will maintain this bit asserted until the next autosequence commences. Read-only bit. |
| 23-22 — | Reserved. |
| 21-16 SEQ_T_STATU S | Status of the just-completed or ongoing Sequence T or Sequence TR Status of the just-completed (or ongoing) Sequence T or Sequence TR autosequence. This register is valid at all times during, and after, the Sequence T or Sequence TR. Not valid for other types of autosequences. This is a read-only register. The bits of this register map to status, according to the following table: [0] 1st CCA complete (CCABFRTX=1) [1] 2nd CCA complete (SLOTTED=1) [2] Tx operation complete [3] Rx Recycle occurred (Sequence TR only) [4] Rx operation complete (Sequence TR only) [5] TxAck operation complete(Sequence TR only) |
| 15 TMR2_SEQ_TR IG_ARMED | indicates that TMR2 has been programmed and is armed to trigger a new autosequence when asserted, indicates that TMR2 has been programmed and is "armed" to trigger a new autosequence, when 802.15.4 Sequence Manager timer-triggering mode is selected (i.e., TMRTRIGEN=1). When timer-triggering mode is selected, TMR2 must be re-programmed (using either T2CMP or T2PRIMECMP), in advance of each new sequence. Once TMR2 is programmed, this bit will be asserted, and will remain asserted until the new sequence commences (at TMR2 match). Hardware will deassert this bit when the new sequence starts. When TMRTRIGEN=0, this bit should be ignored. Read-only bit. |
| 14 RX_MODE | RX Operation in Progress when asserted, this Sequence Manager Output indicates that an RX operation is in progress. An RX operation can be part of a complex transmit autosequence such as a Sequence TR. CCA and ED operations are considered RX operations, during which rx_mode is asserted. Read-only bit. |
| 13 RX_TIMEOUT_ PENDING | Indicates a TMR3 RX Timeout is Pending when asserted, indicates that a TMR3 timeout (RX timeout) flag has been set by Hardware, but the Sequence Manager has not yet aborted because an RX operation is not currently underway. This would be the case, for example, during a Sequence TR, if a TMR3 timeout were to occur during the transmit operation of this sequence; the sequence would not be aborted by Hardware until the receive operation begins. This bit will always be 0 if TC3TMOUT=0. Read-only bit. |
| 12 NEW_SEQ_INH IBIT | New Sequence Inhibit When asserted, indicates that a new programmed autosequence has commenced (TMR2 match has occurred if TMRTRIGEN=1). Once this bit is asserted, software is blocked from commanding any "new" |

Table continues on the next page...

Link Layer

| Field | Function |
|-----------------------------|---|
| | autosequences (other than Sequence I to abort the current sequence), until the current sequence completes. Hardware will ignore a sequence-change command from software while this bit is asserted. Hardware will automatically deassert this bit once the sequence completes. Read-only bit. |
| 11 SEQ_IDLE | SM Sequence Idle Indicator |
| 10-8 XCVSEQ_ACTUAL | Indicates the programmed sequence that has been recognized by the ZSM Sequence Manager Reflects the programmed sequence that has been recognized by the 802.15.4 Sequence Manager. Takes into account the fact that sequence-change commands from software are ignored while a sequence is underway (see NEW_SEQ_INHIBIT). Read-only bits. |
| 7 CONTINUOUS_EN | Enable Continuous TX or RX Mode Continuous Mode Enable (Continuous TX or RX). Note: Dual PAN mode should not be engaged in Continuous TX or RX modes. 0b - normal operation 1b - Continuous TX or RX mode is enabled (depending on XCVSEQ setting). |
| 6 FORCE_CRC_ERROR | Induce a CRC Error in Transmitted Packets 0b - normal operation 1b - Force the next transmitted packet to have a CRC error |
| 5 NO_RX_RECYCLE | Disable Automatic RX Sequence Recycling when asserted, prevents the 802.15.4 Sequence Manager (ZSM) from automatically re-starting (recycling) the receiver when a packet is received which results in a FilterFail or CRC failure. Normally, on a RX recycle, the ZSM returns to the RX_WU (warmup) state, and then resumes from there with a new, foreshortened, Rx warmup, in search of a new preamble. When this bit is set, the Sequence Manager will instead return to idle state, and issue a SEQIRQ, after a FilterFail or CRC failure. |
| 4 LATCH_PREAMBLE | Stickiness Control for Preamble Detection 0b - Don't make PREAMBLE_DET and SFD_DET bits of PHY_STS (SEQ_STATE) Register "sticky", i.e. these status bits reflect the realtime, dynamic state of preamble_detect and sfd_detect 1b - Make PREAMBLE_DET and SFD_DET bits of PHY_STS (SEQ_STATE) Register "sticky", i.e., occurrences of preamble and SFD detection are latched and held until the start of the next autosequence |
| 3 EVENT_TMR_DO_NOT_LATCH | Overrides the automatic hardware latching of the Event Timer when asserted, overrides the automatic hardware latching of the Event Timer that prevents the timer from updating while software reads the 3 Event Timer bytes. This allows the Event Timer LS byte to continue to update without reading the upper 2 bytes. Overriding the automatic latching of the Event Timer should be used with caution, as it can allow the Event Timer lower bytes to get out-of-sync with the upper bytes. However, it can be useful when polling the Event Timer LS byte for a value that is just a few counts in the future. |
| 2 CLR_NEW_SEQ_INHIBIT | Overrides the automatic hardware locking of the programmed XCVSEQ while an autosequence is underway when asserted, overrides the automatic hardware locking of the programmed XCVSEQ while an autosequence is underway. Asserting this feature will allow software to change the programmed autosequence "on-the-fly", without aborting and returning to idle between sequences. Overriding the hardware lockout of XCVSEQ should be used with caution, since the Sequence Manager is not designed (or verified) for manual state transitions between one type of autosequence and other (i.e., Sequence T -> Sequence R). |
| 1-0 — | Reserved. |

45.6.2.15.32 ACK DELAY (ACKDELAY)

45.6.2.15.32.1 Address

| Register | Offset |
|----------|-----------|
| ACKDELAY | 4005D07Ch |

45.6.2.15.32.2 Function

Provides a fine-tune adjustment of the time delay between Rx warmdown and the beginning of Tx warmup for an autoTxAck packet.

45.6.2.15.32.3 Diagram

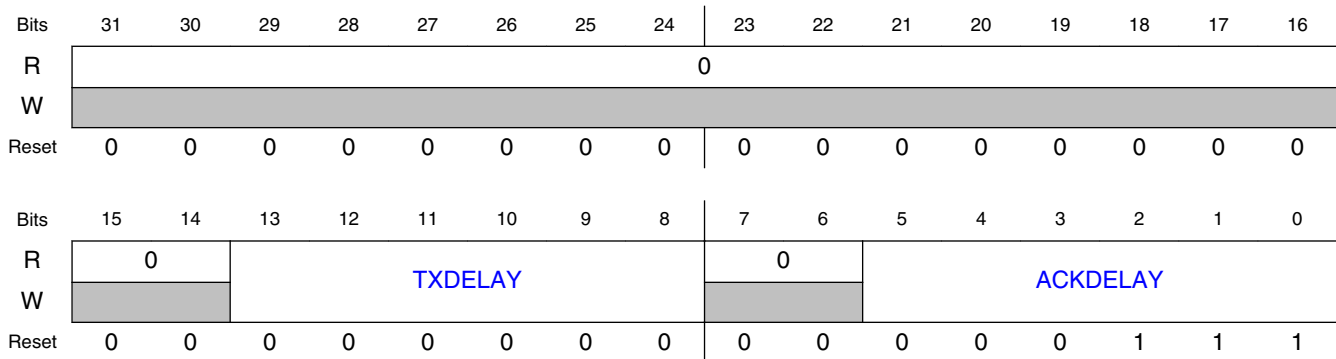

45.6.2.15.32.4 Fields

| Field | Function |
|-------------------|---|
| 31-14 Reserved | Reserved. |
| 13-8 TXDELAY | TX Delay Provides a fine-tune adjustment of the time delay between post-CCA Rx warm-down and the beginning of Tx warm-up for an Tx (non-Ack) packet. TXDELAY register will apply in both SLOTTED and UNSLOTTED modes, but only to T sequences (e.g., T, TR, and T(R)), not TxAck operations. This is a two's complement value. The minimum permissible value is -19 (0x2D). Values less than -19 will lead to unexpected results. Resolution = 2us. Range = +/- 62us. Max TXDELAY = 0x1F. Min TXDELAY = 0x2D. |
| 7-6 | Reserved. |

Table continues on the next page...

Link Layer

| Field | Function |
|-----------------|--|
| — | |
| 5-0 ACKDELAY | <p>ACK Delay</p> <p>Provides a fine-tune adjustment of the time delay between Rx warmdown and the beginning of Tx warmup for an Tx Acknowledge packet. ACKDELAY register will apply to both SLOTTED and UNSLOTTED TxAck, but only to TxAck (not T sequences). This is a two's complement value. The minimum permissible value is -19 (0x2D). Values less than -19 will lead to unexpected results.</p> <p>Resolution = 2us.</p> <p>Range = +/- 62us.</p> <p>Max ACKDELAY = 0x1F.</p> <p>Min ACKDELAY = 0x2D.</p> |

45.6.2.15.33 FILTER FAIL CODE (FILTERFAIL_CODE)

45.6.2.15.33.1 Address

| Register | Offset |
|-----------------|-----------|
| FILTERFAIL_CODE | 4005D080h |

45.6.2.15.33.2 Diagram

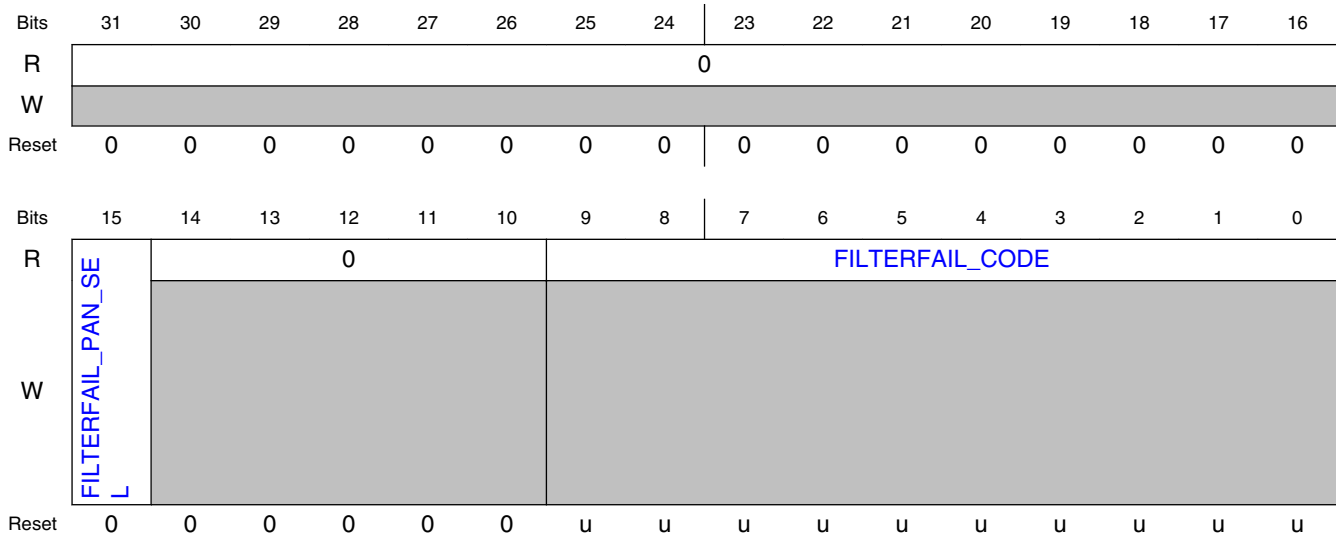

45.6.2.15.33.3 Fields

| Field | Function | | | | | | | | | | | | | | | | | | | | | | |
|--------------------------|--|---------------------|-----------------------|-----|--|-----|--|-----|---|-----|--------------------------------------|-----|---|-----|--|-----|---|-----|---|-----|---|-----|---|
| 31-16 — | Reserved. | | | | | | | | | | | | | | | | | | | | | | |
| 15 FILTERFAIL_PAN_SEL | PAN Selector for Filter Fail Code 0b - FILTERFAIL_CODE[9:0] will report the FILTERFAIL status of PAN0 1b - FILTERFAIL_CODE[9:0] will report the FILTERFAIL status of PAN1 | | | | | | | | | | | | | | | | | | | | | | |
| 14-10 — | Reserved. | | | | | | | | | | | | | | | | | | | | | | |
| 9-0 FILTERFAIL_CODE | Filter Fail Code Code indicating what condition, or conditions, caused the Packet Processor to reject the just-received packet. The bits of FILTERFAIL_CODE indicate the reason for packet rejection according to the table below: | | | | | | | | | | | | | | | | | | | | | | |
| | <table border="1"> <thead> <tr> <th>FILTERFAIL CODE BIT</th> <th>REASON FOR FILTERFAIL</th> </tr> </thead> <tbody> <tr> <td>[0]</td> <td>Fails Stage 1 Frame Length Checking (FL < 5 or FL > MAXFRAMELENGTH) Note: FL < 3 will not generate an SFD, so this bit will not be set</td> </tr> <tr> <td>[1]</td> <td>Fails Stage 1 Section 7.2.1.1.6 or Section 7.2.1.1.8 Checking (DST_ADDR_MODE or SRC_ADDR_MODE = 1)</td> </tr> <tr> <td>[2]</td> <td>Fails Stage 1 Section 7.2.1.1.5 Checking (Illegal PAN_ID_COMPRESSION Usage)</td> </tr> <tr> <td>[3]</td> <td>Fails Stage 1 Frame Version Checking</td> </tr> <tr> <td>[4]</td> <td>Fails Stage 2 Auto-RxAck Checking (Illegal Ack Frame Format in Sequence TR)</td> </tr> <tr> <td>[5]</td> <td>Fails Stage 2 Frame Type Checking (Incorrect Frame Filter Bit setting)</td> </tr> <tr> <td>[6]</td> <td>Fails Stage 2 Frame Length Checking (Illegal Beacon, Data, or Cmd FL)</td> </tr> <tr> <td>[7]</td> <td>Fails Stage 2 Addressing Mode Checking (Illegal Addressing Mode for Beacon, Data, OR Cmd)</td> </tr> <tr> <td>[8]</td> <td>Fails Stage 2 Sequence Number Matching (Sequence TR Only)</td> </tr> <tr> <td>[9]</td> <td>Fails Stage 2 PAN ID or Address Checking (Beacon, Data, or Cmd)</td> </tr> </tbody> </table> | FILTERFAIL CODE BIT | REASON FOR FILTERFAIL | [0] | Fails Stage 1 Frame Length Checking (FL < 5 or FL > MAXFRAMELENGTH) Note: FL < 3 will not generate an SFD, so this bit will not be set | [1] | Fails Stage 1 Section 7.2.1.1.6 or Section 7.2.1.1.8 Checking (DST_ADDR_MODE or SRC_ADDR_MODE = 1) | [2] | Fails Stage 1 Section 7.2.1.1.5 Checking (Illegal PAN_ID_COMPRESSION Usage) | [3] | Fails Stage 1 Frame Version Checking | [4] | Fails Stage 2 Auto-RxAck Checking (Illegal Ack Frame Format in Sequence TR) | [5] | Fails Stage 2 Frame Type Checking (Incorrect Frame Filter Bit setting) | [6] | Fails Stage 2 Frame Length Checking (Illegal Beacon, Data, or Cmd FL) | [7] | Fails Stage 2 Addressing Mode Checking (Illegal Addressing Mode for Beacon, Data, OR Cmd) | [8] | Fails Stage 2 Sequence Number Matching (Sequence TR Only) | [9] | Fails Stage 2 PAN ID or Address Checking (Beacon, Data, or Cmd) |
| FILTERFAIL CODE BIT | REASON FOR FILTERFAIL | | | | | | | | | | | | | | | | | | | | | | |
| [0] | Fails Stage 1 Frame Length Checking (FL < 5 or FL > MAXFRAMELENGTH) Note: FL < 3 will not generate an SFD, so this bit will not be set | | | | | | | | | | | | | | | | | | | | | | |
| [1] | Fails Stage 1 Section 7.2.1.1.6 or Section 7.2.1.1.8 Checking (DST_ADDR_MODE or SRC_ADDR_MODE = 1) | | | | | | | | | | | | | | | | | | | | | | |
| [2] | Fails Stage 1 Section 7.2.1.1.5 Checking (Illegal PAN_ID_COMPRESSION Usage) | | | | | | | | | | | | | | | | | | | | | | |
| [3] | Fails Stage 1 Frame Version Checking | | | | | | | | | | | | | | | | | | | | | | |
| [4] | Fails Stage 2 Auto-RxAck Checking (Illegal Ack Frame Format in Sequence TR) | | | | | | | | | | | | | | | | | | | | | | |
| [5] | Fails Stage 2 Frame Type Checking (Incorrect Frame Filter Bit setting) | | | | | | | | | | | | | | | | | | | | | | |
| [6] | Fails Stage 2 Frame Length Checking (Illegal Beacon, Data, or Cmd FL) | | | | | | | | | | | | | | | | | | | | | | |
| [7] | Fails Stage 2 Addressing Mode Checking (Illegal Addressing Mode for Beacon, Data, OR Cmd) | | | | | | | | | | | | | | | | | | | | | | |
| [8] | Fails Stage 2 Sequence Number Matching (Sequence TR Only) | | | | | | | | | | | | | | | | | | | | | | |
| [9] | Fails Stage 2 PAN ID or Address Checking (Beacon, Data, or Cmd) | | | | | | | | | | | | | | | | | | | | | | |

45.6.2.15.34 RECEIVE WATER MARK (RX_WTR_MARK)

45.6.2.15.34.1 Address

| Register | Offset |
|-------------|-----------|
| RX_WTR_MARK | 4005D084h |

45.6.2.15.34.2 Diagram

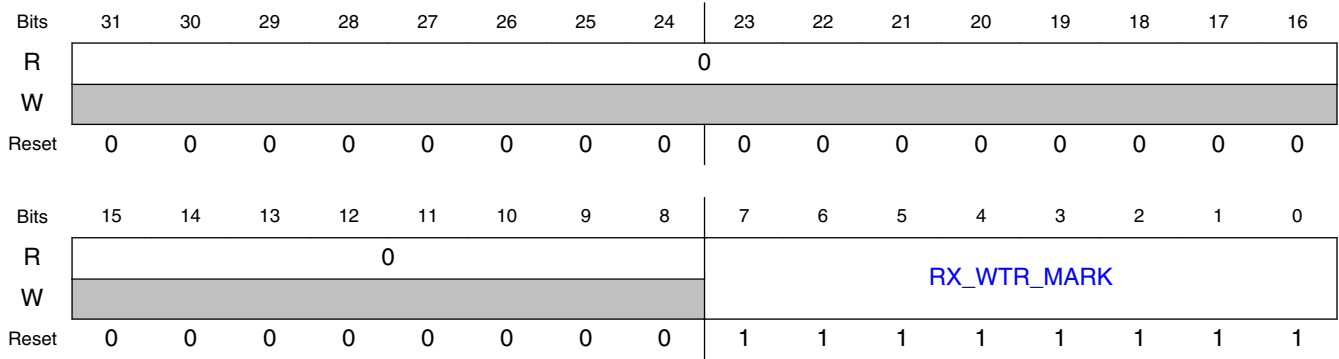

45.6.2.15.34.3 Fields

| Field | Function |
|--------------------|--|
| 31-8 Reserved | Reserved. |
| 7-0 RX_WTR_MARK | RECEIVE WATER MARK Receive byte count (octets) needed to trigger a RXWTRMRKIRQ interrupt . A setting of 0 generates an interrupt at end of the Frame Length field (first byte after SFD). A setting of 1 generates an interrupt after the first byte of Frame Control Field, etc. |

45.6.2.15.35 SLOT PRELOAD (SLOT_PRELOAD)

45.6.2.15.35.1 Address

| Register | Offset |
|--------------|-----------|
| SLOT_PRELOAD | 4005D08Ch |

45.6.2.15.35.2 Function

Slotted Mode Preload

45.6.2.15.35.3 Diagram

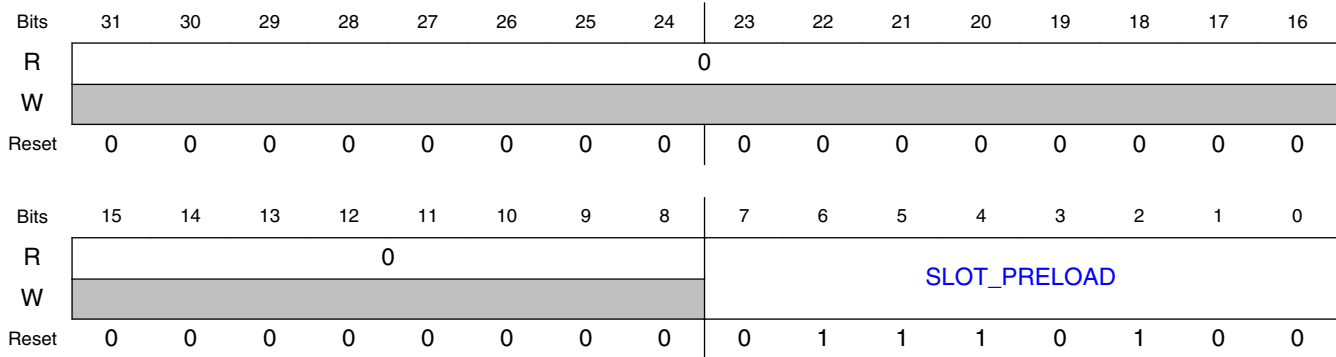

45.6.2.15.35.4 Fields

| Field | Function |
|---------------------|--|
| 31-8 Reserved | Reserved. |
| 7-0 SLOT_PRELOAD | Slotted Mode Preload This register represents the number that gets loaded into the slot_timer at SFD detect, which ultimately determines when the next slot boundary will occur. Due to processing delays within the analog front-end and digital modem, the point at which SFD is detected by the modem, is delayed relative to over-the-air timing. This register setting compensates for that delay. This timing parameter is critical for the Sequence R autosequence in slotted mode, when an automatic TxAck is required. |

45.6.2.15.36 802.15.4 SEQUENCE STATE (SEQ_STATE)

45.6.2.15.36.1 Address

| Register | Offset |
|-----------|-----------|
| SEQ_STATE | 4005D090h |

45.6.2.15.36.2 Function

802.15.4 Sequence State Register

45.6.2.15.36.3 Diagram

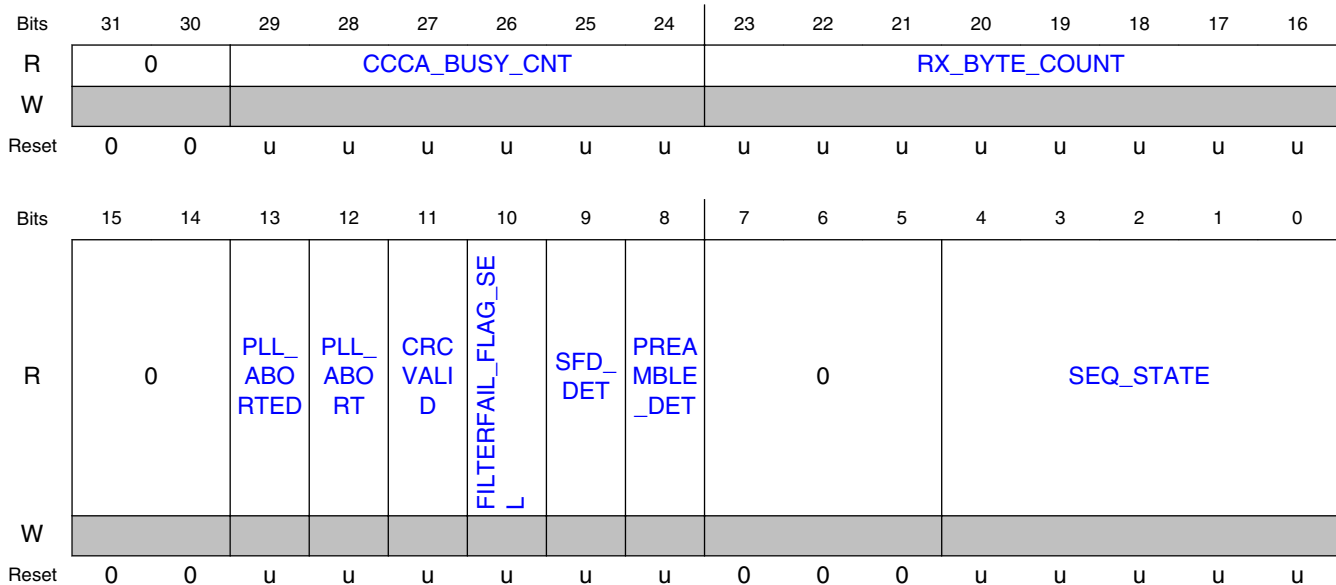

45.6.2.15.36.4 Fields

| Field | Function |
|------------------------|---|
| 31-30 — | Reserved. |
| 29-24 CCCA_BUSY_CNT | Number of CCA Measurements resulting in Busy Channel For Sequence CCA mode only, this register indicates the number of "busy" CCA attempts which occurred during the autosequence, before the channel was detected to be idle. This register can also be read in real-time (during the autosequence) to determine how many busy CCA attempts have occurred to that point. The register saturates at 63 (i.e, if there are more than 63 busy attempts, the register will continue to read 63). This register is automatically cleared to zero by hardware when the next autosequence commences. Read-only register. |
| 23-16 RX_BYTE_COUNT | Realtime Received Byte Count During packet reception, this read-only register is a real-time indicator of the number of bytes that have been received. This register will read 0 until SFD and PHR have been received. It will read 1 after the first byte of Frame Control Field has been received, etc. |
| 15-14 — | Reserved. |
| 13 PLL_ABORTED | Autosequence has terminated due to an PLL unlock event when asserted, indicates that the autosequence has terminated due to an PLL unlock event. This bit is valid at the SEQIRQ interrupt. Hardware will maintain this bit asserted until the next autosequence commences. This bit is a read-only mirror of the register bit of the same name in the ABORT_STS (SEQ_CTRL_STS) register. |
| 12 PLL_ABORT | Raw PLL Abort Signal This bit reflects the instantaneous, consolidated status of the PLL unlock detection circuits; if asserted high, indicates that at least one of the three PLL unlock detect mechanisms is currently reporting an unlocked condition. |

Table continues on the next page...

| Field | Function |
|---------------------------|---|
| 11 CRCVALID | CRC Valid Indicator Cyclic Redundancy Check Valid: This flag indicates the compare result between the FCS field, in the most-recently received frame, and the internally calculated CRC value. This flag is cleared at next receiver warm up. 0b - Rx FCS != calculated CRC (incorrect) 1b - Rx FCS = calculated CRC (correct) |
| 10 FILTERFAIL_FLAG_SEL | Consolidated Filter Fail Flag 0: The incoming, or just-received packet, passed packet filtering rules. 1: The incoming, or just-received packet, failed packet filtering rules When FILTERFAIL_FLAG_SEL=1, a non-zero FILTERFAIL_CODE is present (see FILTERFAIL_CODE registers). In Dual PAN mode, FILTERFAIL_FLAG_SEL applies to either or both networks, as follows: A: If PAN0 and PAN1 occupy different channels and CURRENT_NETWORK=0, FILTERFAIL_FLAG_SEL applies to PAN0. B: If PAN0 and PAN1 occupy different channels and CURRENT_NETWORK=1, FILTERFAIL_FLAG_SEL applies to PAN1. C: If PAN0 and PAN1 occupy the same channel, FILTERFAIL_FLAG_SEL is the logical 'AND' of the individual PANs' FILTERFAIL_FLAG bits. |
| 9 SFD_DET | SFD Detected 0: an 802.15.4 preamble-and-SFD have not been detected. 1: An 802.15.4 preamble-and-SFD have been detected. The function of this read-only bit depends on the setting of the LATCH_PREAMBLE bit of the SEQ_MGR_CTRL register. If LATCH_PREAMBLE=1, any preamble-and-SFD detection during a Sequence R (even false detections), will set this bit, and it will remain set (sticky) until the start of the next autosequence. If LATCH_PREAMBLE=0, this bit is not sticky, and reflects the instantaneous state of the SFD-detection circuit; for false SFD, the bit will clear when the false nature of the SFD is recognized (i.e., an RX recycle). When LATCH_PREAMBLE=0, SFD_DET should be considered valid only while an autosequence is underway. |
| 8 PREAMBLE_DETECT | Preamble Detected 0: an 802.15.4 preamble has not been detected. 1: An 802.15.4 preamble has been detected. The function of this read-only bit depends on the setting of the LATCH_PREAMBLE bit of the SEQ_MGR_CTRL register. If LATCH_PREAMBLE=1, any preamble detection during a Sequence R (even false detections), will set this bit, and it will remain set (sticky) until the start of the next autosequence. If LATCH_PREAMBLE=0, this bit is not sticky, and reflects the instantaneous state of the preamble-detection circuit; for false preambles, the bit will clear when the false nature of the preamble is recognized. When LATCH_PREAMBLE=0, PREAMBLE_DET should be considered valid only while an autosequence is underway. |
| 7-5 — | Reserved. |
| 4-0 SEQ_STATE | ZSM Sequence State This read-only register reflects the instantaneous state of the 802.15.4 Sequence Manager |

45.6.2.15.37 TIMER PRESCALER (TMR_PRESCALE)

45.6.2.15.37.1 Address

| Register | Offset |
|--------------|-----------|
| TMR_PRESCALE | 4005D094h |

45.6.2.15.37.2 Function

Timer Prescaler Control Register

45.6.2.15.37.3 Diagram

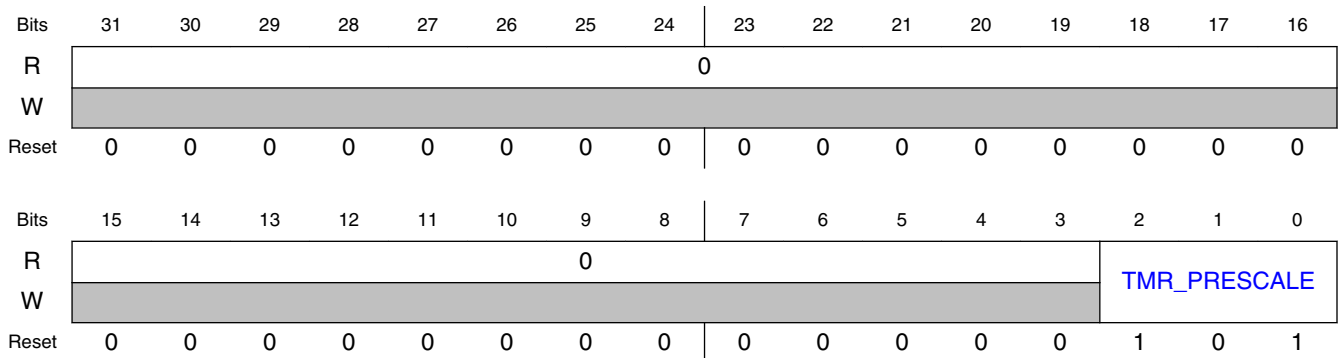

45.6.2.15.37.4 Fields

| Field | Function |
|---------------------|--|
| 31-3 Reserved | Reserved. |
| 2-0 TMR_PRESCALE | <p>Timer Prescaler</p> <p>Timer Prescaler. Establishes the Event Timer clock rate, (maximum timer duration)</p> <p>Note:To take advantage of the EVENT_TMR Fractional bits for 802.15.4 DSM mode, only the default setting ("5", or 62.5KHz) is allowed.</p> <ul style="list-style-type: none"> 000b - Reserved 001b - Reserved 010b - 500kHz (33.55 S) 011b - 250kHz (67.11 S) 100b - 125kHz (134.22 S) 101b - 62.5kHz (268.44 S) -- default 110b - 31.25kHz (536.87 S) 111b - 15.625kHz (1073.74 S) |

45.6.2.15.38 LENIENCY_LSB (LENIENCY_LSB)

45.6.2.15.38.1 Address

| Register | Offset |
|--------------|-----------|
| LENIENCY_LSB | 4005D098h |

45.6.2.15.38.2 Function

Packet Processor Leniency Bits (LSB)

45.6.2.15.38.3 Diagram

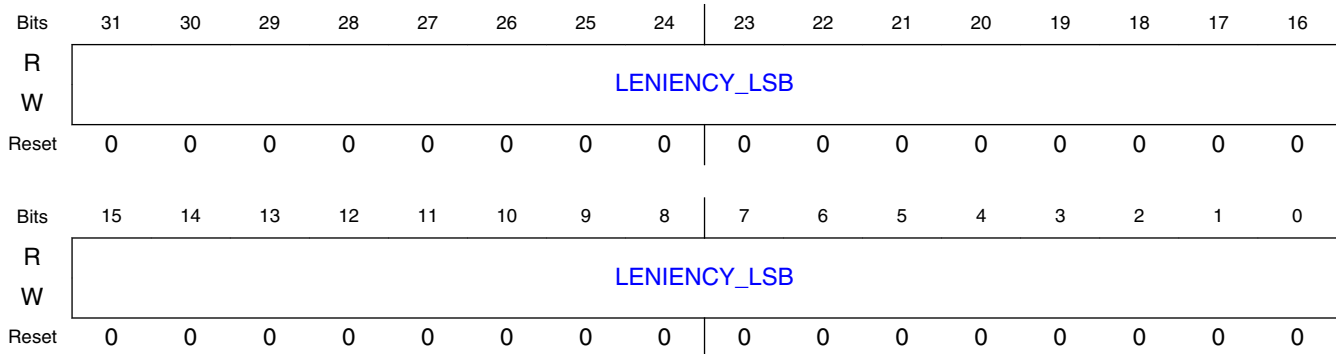

45.6.2.15.38.4 Fields

| Field | Function | | | | | | | | | | |
|--------------|---|--------------|----------------------------------|-------------|--|-------------|---|-------------|---|-------------|--|
| 31-0 | Leniency LSB Register | | | | | | | | | | |
| LENIENCY_LSB | <p>The Packet Processor performs filtering on all received packets, in order to determine whether the packet is intended for the device. The packet filtering is based on rules. In case any of the packet filtering rules need to be overridden, a 40-bit "leniency register" has been provided. When the leniency register is programmed to its default value (0), all hardware packet filtering rules are in effect, and if an incoming packet violates any rule, a "Filter Fail" will occur (packet will be rejected). When a given leniency register bit is asserted, the packet filtering rule assigned to that bit will not be in effect, and if any incoming packet violates that rule (but no other rules), then a "Filter Fail" will not occur, the packet will not be rejected, the packet will be treated as "intended for the device", and software will be notified of the incoming packet. The table below shows the assignment of leniency bits to packet filtering rules.</p> <table border="1"> <thead> <tr> <th>LENIENCY BIT</th> <th>PACKET FILTERING RULE OVERRIDDEN</th> </tr> </thead> <tbody> <tr> <td>leniency[0]</td> <td>Override Stage 1 Frame Length Checking (FL < 5 or FL > MAXFRAMELENGTH)</td> </tr> <tr> <td>leniency[1]</td> <td>Override Stage 1 Section 7.2.1.1.6 Checking (DST_ADDR_MODE = 1)</td> </tr> <tr> <td>leniency[2]</td> <td>Override Stage 1 Section 7.2.1.1.8 Checking (SRC_ADDR_MODE = 1)</td> </tr> <tr> <td>leniency[3]</td> <td>Override Stage 1 Section 7.2.1.1.5 Checking (Illegal PAN_ID_COMPRESSION Usage)</td> </tr> </tbody> </table> | LENIENCY BIT | PACKET FILTERING RULE OVERRIDDEN | leniency[0] | Override Stage 1 Frame Length Checking (FL < 5 or FL > MAXFRAMELENGTH) | leniency[1] | Override Stage 1 Section 7.2.1.1.6 Checking (DST_ADDR_MODE = 1) | leniency[2] | Override Stage 1 Section 7.2.1.1.8 Checking (SRC_ADDR_MODE = 1) | leniency[3] | Override Stage 1 Section 7.2.1.1.5 Checking (Illegal PAN_ID_COMPRESSION Usage) |
| LENIENCY BIT | PACKET FILTERING RULE OVERRIDDEN | | | | | | | | | | |
| leniency[0] | Override Stage 1 Frame Length Checking (FL < 5 or FL > MAXFRAMELENGTH) | | | | | | | | | | |
| leniency[1] | Override Stage 1 Section 7.2.1.1.6 Checking (DST_ADDR_MODE = 1) | | | | | | | | | | |
| leniency[2] | Override Stage 1 Section 7.2.1.1.8 Checking (SRC_ADDR_MODE = 1) | | | | | | | | | | |
| leniency[3] | Override Stage 1 Section 7.2.1.1.5 Checking (Illegal PAN_ID_COMPRESSION Usage) | | | | | | | | | | |

| Field | Function | |
|-------|---------------------|--|
| | LENIENCY BIT | PACKET FILTERING RULE OVERRIDDEN |
| | leniency[4] | Override Stage 2 Auto-RxAck Checking (Illegal Ack Frame Format in Sequence TR) |
| | leniency[5] | Override Stage 2 Frame Length Checking (Illegal Beacon, Data, or Cmd FL) |
| | leniency[6] | Override Stage 2 Beacon Frame Address Mode Violations |
| | leniency[7] | Override Stage 2 Data Frame Address Mode Violations |
| | leniency[8] | Override Stage 2 MAC Command Frame Address Mode Violations |
| | leniency[9] | Override Stage 2 Sequence Number Matching |
| | leniency[10] | Override Stage 2 Filter for DST_ADDR_MODE_NONE/ SRC_ADDR_MODE_SHORT (Beacon Only) |
| | leniency[11] | Override Stage 2 Filter for DST_ADDR_MODE_NONE/ SRC_ADDR_MODE_SHORT (Data and MAC Command Only) |
| | leniency[12] | Override Stage 2 Dst PAN ID Filter for DST_ADDR_MODE_SHORT/ SRC_ADDR_MODE_NONE (Data and MAC Command Only) |
| | leniency[13] | Override Stage 2 Dst Short Addr Filter for DST_ADDR_MODE_SHORT/ SRC_ADDR_MODE_NONE (Data and MAC Command Only) |
| | leniency[14] | Override Stage 2 PAN ID Filter for DST_ADDR_MODE_SHORT/ SRC_ADDR_MODE_SHORT/PAN_ID_COMPRESSION (Beacon Only) |
| | leniency[15] | Override Stage 2 PAN ID Filter for DST_ADDR_MODE_SHORT/ SRC_ADDR_MODE_SHORT/PAN_ID_COMPRESSION (Data and MAC Command Only) |
| | leniency[16] | Override Stage 2 Dst Short Addr Filter for DST_ADDR_MODE_SHORT/ SRC_ADDR_MODE_SHORT/PAN_ID_COMPRESSION (Data and MAC Command Only) |
| | leniency[17] | Override Stage 2 PAN ID Filter for DST_ADDR_MODE_SHORT/ SRC_ADDR_MODE_SHORT/NO_PAN_ID_COMPRESSION (Beacon Only) |
| | leniency[18] | Override Stage 2 PAN ID Filter for DST_ADDR_MODE_SHORT/ SRC_ADDR_MODE_SHORT/NO_PAN_ID_COMPRESSION (Data and MAC Command Only) |
| | leniency[19] | Override Stage 2 Dst Addr Filter for DST_ADDR_MODE_SHORT/ SRC_ADDR_MODE_SHORT/NO_PAN_ID_COMPRESSION (Data and MAC Command Only) |
| | leniency[20] | Override Stage 2 Src PAN ID Filter for DST_ADDR_MODE_NONE/ SRC_ADDR_MODE_LONG/NO_PAN_ID_COMPRESSION (Beacon Only) |
| | leniency[21] | Override Stage 2 Src PAN ID Filter for DST_ADDR_MODE_NONE/ SRC_ADDR_MODE_LONG/NO_PAN_ID_COMPRESSION (Data and MAC Command Only) |
| | leniency[22] | Override Stage 2 Dst PAN ID Filter for DST_ADDR_MODE_LONG/ SRC_ADDR_MODE_NONE (Data and MAC Command Only) |
| | leniency[23] | Override Stage 2 Dst Long Addr Filter for DST_ADDR_MODE_LONG/ SRC_ADDR_MODE_NONE (Data and MAC Command Only) |
| | leniency[24] | Override Stage 2 PAN ID Filter for DST_ADDR_MODE_SHORT/ SRC_ADDR_MODE_LONG/PAN_ID_COMPRESSION (Beacon Only) |
| | leniency[25] | Override Stage 2 PAN ID Filter for DST_ADDR_MODE_SHORT/ SRC_ADDR_MODE_LONG/PAN_ID_COMPRESSION (Data and MAC Command Only) |

| Field | Function | |
|-------|---------------------|--|
| | LENIENCY BIT | PACKET FILTERING RULE OVERRIDDEN |
| | leniency[26] | Override Stage 2 Dst Long Addr Filter for DST_ADDR_MODE_SHORT/ SRC_ADDR_MODE_LONG/PAN_ID_COMPRESSION (Data and MAC Command Only) |
| | leniency[27] | Override Stage 2 PAN ID Filter for DST_ADDR_MODE_LONG/ SRC_ADDR_MODE_SHORT/PAN_ID_COMPRESSION (Beacon Only) |
| | leniency[28] | Override Stage 2 PAN ID Filter for DST_ADDR_MODE_LONG/ SRC_ADDR_MODE_SHORT/PAN_ID_COMPRESSION (Data and Mac Command Only) |
| | leniency[29] | Override Stage 2 Dst Long Addr Filter for DST_ADDR_MODE_LONG/ SRC_ADDR_MODE_SHORT/PAN_ID_COMPRESSION (Data and Mac Command Only) |
| | leniency[30] | Override Stage 2 PAN ID Filter for DST_ADDR_MODE_SHORT/ SRC_ADDR_MODE_LONG/NO_PAN_ID_COMPRESSION (Beacon Only) |
| | leniency[31] | Override Stage 2 PAN ID Filter for DST_ADDR_MODE_SHORT/ SRC_ADDR_MODE_LONG/NO_PAN_ID_COMPRESSION (Data and MAC Command Only) |

45.6.2.15.39 LENIENCY MSB (LENIENCY_MSB)

45.6.2.15.39.1 Address

| Register | Offset |
|--------------|-----------|
| LENIENCY_MSB | 4005D09Ch |

45.6.2.15.39.2 Function

Packet Processor Leniency Bits (MSB)

45.6.2.15.39.3 Diagram

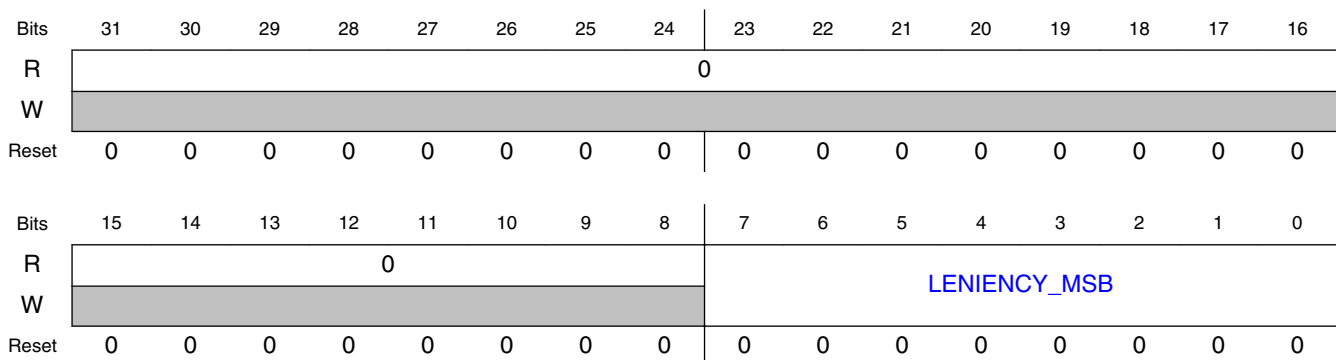

45.6.2.15.39.4 Fields

| Field | Function | | | | | | | | | | | | | | | | | | |
|---------------------|--|--------------|----------------------------------|--------------|---|--------------|---|--------------|---|--------------|--|--------------|--|--------------|--|--------------|---|--------------|---|
| 31-8 Reserved | Reserved. | | | | | | | | | | | | | | | | | | |
| 7-0 LENIENCY_MSB | <p>Leniency MSB Register</p> <p>The Packet Processor performs filtering on all received packets, in order to determine whether the packet is intended for the device. The packet filtering is based on rules. In case any of the packet filtering rules need to be overridden, a 40-bit "leniency register" has been provided. When the leniency register is programmed to its default value (0), all hardware packet filtering rules are in effect, and if an incoming packet violates any rule, a "Filter Fail" will occur (packet will be rejected). When a given leniency register bit is asserted, the packet filtering rule assigned to that bit will not be in effect, and if any incoming packet violates that rule (but no other rules), then a "Filter Fail" will not occur, the packet will not be rejected, the packet will be treated as "intended for the device", and software will be notified of the incoming packet. The table below shows the assignment of leniency bits to packet filtering rules.</p> <table border="1"> <thead> <tr> <th>LENIENCY BIT</th> <th>PACKET FILTERING RULE OVERRIDDEN</th> </tr> </thead> <tbody> <tr> <td>leniency[32]</td> <td>Override Stage 2 Short Addr Filter for DST_ADDR_MODE_SHORT/ SRC_ADDR_MODE_LONG/NO_PAN_ID_COMPRESSION (Data and MAC Command Only)</td> </tr> <tr> <td>leniency[33]</td> <td>Override Stage 2 PAN ID Filter for DST_ADDR_MODE_LONG/ SRC_ADDR_MODE_SHORT/NO_PAN_ID_COMPRESSION (Beacon Only)</td> </tr> <tr> <td>leniency[34]</td> <td>Override Stage 2 PAN ID Filter for DST_ADDR_MODE_LONG/ SRC_ADDR_MODE_SHORT/NO_PAN_ID_COMPRESSION (Data and MAC Command Only)</td> </tr> <tr> <td>leniency[35]</td> <td>Override Stage 2 Long Addr Filter for DST_ADDR_MODE_LONG/ SRC_ADDR_MODE_SHORT/NO_PAN_ID_COMPRESSION (Data and MAC Command Only)</td> </tr> <tr> <td>leniency[36]</td> <td>Override Stage 2 PAN ID Filter for DST_ADDR_MODE_LONG/ SRC_ADDR_MODE_LONG (Beacon Only)</td> </tr> <tr> <td>leniency[37]</td> <td>Override Stage 2 PAN ID Filter for DST_ADDR_MODE_LONG/ SRC_ADDR_MODE_LONG (Data and MAC Command Only)</td> </tr> <tr> <td>leniency[38]</td> <td>Override Stage 2 Long Addr Filter for DST_ADDR_MODE_LONG/ SRC_ADDR_MODE_LONG (Data and MAC Command Only)</td> </tr> <tr> <td>leniency[39]</td> <td> Allow an auto-TxAck frame to be sent, after a receive frame which has all of the following parameters: <ol style="list-style-type: none"> 1. Destination PAN ID = Broadcast (0xFFFF) 2. Destination Address = !Broadcast (not 0xFFFF) 3. Destination Address Mode = Short Nominally, the SEQ_MGR inhibits auto-TxAck on such frames. </td> </tr> </tbody> </table> | LENIENCY BIT | PACKET FILTERING RULE OVERRIDDEN | leniency[32] | Override Stage 2 Short Addr Filter for DST_ADDR_MODE_SHORT/ SRC_ADDR_MODE_LONG/NO_PAN_ID_COMPRESSION (Data and MAC Command Only) | leniency[33] | Override Stage 2 PAN ID Filter for DST_ADDR_MODE_LONG/ SRC_ADDR_MODE_SHORT/NO_PAN_ID_COMPRESSION (Beacon Only) | leniency[34] | Override Stage 2 PAN ID Filter for DST_ADDR_MODE_LONG/ SRC_ADDR_MODE_SHORT/NO_PAN_ID_COMPRESSION (Data and MAC Command Only) | leniency[35] | Override Stage 2 Long Addr Filter for DST_ADDR_MODE_LONG/ SRC_ADDR_MODE_SHORT/NO_PAN_ID_COMPRESSION (Data and MAC Command Only) | leniency[36] | Override Stage 2 PAN ID Filter for DST_ADDR_MODE_LONG/ SRC_ADDR_MODE_LONG (Beacon Only) | leniency[37] | Override Stage 2 PAN ID Filter for DST_ADDR_MODE_LONG/ SRC_ADDR_MODE_LONG (Data and MAC Command Only) | leniency[38] | Override Stage 2 Long Addr Filter for DST_ADDR_MODE_LONG/ SRC_ADDR_MODE_LONG (Data and MAC Command Only) | leniency[39] | Allow an auto-TxAck frame to be sent, after a receive frame which has all of the following parameters: <ol style="list-style-type: none"> 1. Destination PAN ID = Broadcast (0xFFFF) 2. Destination Address = !Broadcast (not 0xFFFF) 3. Destination Address Mode = Short Nominally, the SEQ_MGR inhibits auto-TxAck on such frames. |
| LENIENCY BIT | PACKET FILTERING RULE OVERRIDDEN | | | | | | | | | | | | | | | | | | |
| leniency[32] | Override Stage 2 Short Addr Filter for DST_ADDR_MODE_SHORT/ SRC_ADDR_MODE_LONG/NO_PAN_ID_COMPRESSION (Data and MAC Command Only) | | | | | | | | | | | | | | | | | | |
| leniency[33] | Override Stage 2 PAN ID Filter for DST_ADDR_MODE_LONG/ SRC_ADDR_MODE_SHORT/NO_PAN_ID_COMPRESSION (Beacon Only) | | | | | | | | | | | | | | | | | | |
| leniency[34] | Override Stage 2 PAN ID Filter for DST_ADDR_MODE_LONG/ SRC_ADDR_MODE_SHORT/NO_PAN_ID_COMPRESSION (Data and MAC Command Only) | | | | | | | | | | | | | | | | | | |
| leniency[35] | Override Stage 2 Long Addr Filter for DST_ADDR_MODE_LONG/ SRC_ADDR_MODE_SHORT/NO_PAN_ID_COMPRESSION (Data and MAC Command Only) | | | | | | | | | | | | | | | | | | |
| leniency[36] | Override Stage 2 PAN ID Filter for DST_ADDR_MODE_LONG/ SRC_ADDR_MODE_LONG (Beacon Only) | | | | | | | | | | | | | | | | | | |
| leniency[37] | Override Stage 2 PAN ID Filter for DST_ADDR_MODE_LONG/ SRC_ADDR_MODE_LONG (Data and MAC Command Only) | | | | | | | | | | | | | | | | | | |
| leniency[38] | Override Stage 2 Long Addr Filter for DST_ADDR_MODE_LONG/ SRC_ADDR_MODE_LONG (Data and MAC Command Only) | | | | | | | | | | | | | | | | | | |
| leniency[39] | Allow an auto-TxAck frame to be sent, after a receive frame which has all of the following parameters: <ol style="list-style-type: none"> 1. Destination PAN ID = Broadcast (0xFFFF) 2. Destination Address = !Broadcast (not 0xFFFF) 3. Destination Address Mode = Short Nominally, the SEQ_MGR inhibits auto-TxAck on such frames. | | | | | | | | | | | | | | | | | | |

45.6.2.15.40 PART ID (PART_ID)

45.6.2.15.40.1 Address

| Register | Offset |
|----------|-----------|
| PART_ID | 4005D0A0h |

45.6.2.15.40.2 Diagram

| | | | | | | | | | | | | | | | | | |
|-------|----|----|----|----|----|----|----|----|---------|----|----|----|----|----|----|----|----|
| Bits | 31 | 30 | 29 | 28 | 27 | 26 | 25 | 24 | | 23 | 22 | 21 | 20 | 19 | 18 | 17 | 16 |
| R | 0 | | | | | | | | | | | | | | | | |
| W | | | | | | | | | | | | | | | | | |
| Reset | 0 | 0 | 0 | 0 | 0 | 0 | 0 | 0 | | 0 | 0 | 0 | 0 | 0 | 0 | 0 | 0 |
| Bits | 15 | 14 | 13 | 12 | 11 | 10 | 9 | 8 | | 7 | 6 | 5 | 4 | 3 | 2 | 1 | 0 |
| R | 0 | | | | | | | | PART_ID | | | | | | | | |
| W | | | | | | | | | | | | | | | | | |
| Reset | 0 | 0 | 0 | 0 | 0 | 0 | 0 | 0 | | 0 | 0 | 0 | 0 | 0 | 0 | 1 | 0 |

45.6.2.15.40.3 Fields

| Field | Function |
|------------------|------------------|
| 31-8 Reserved | Reserved. |
| 7-0 PART_ID | 802.15.4 Part ID |

45.6.2.15.41 Packet Buffer TX (PKT_BUFFER_TXa)

45.6.2.15.41.1 Address

For a = 0 to 63:

| Register | Offset |
|----------------|----------------------|
| PKT_BUFFER_TXa | 4005D100h + (a × 2h) |

45.6.2.15.41.2 Function

Packet Buffer TX

45.6.2.15.41.3 Diagram

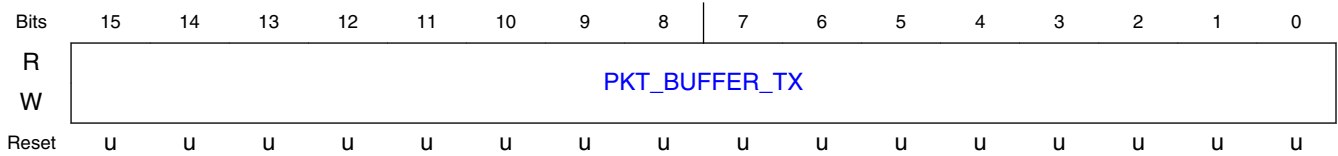

45.6.2.15.41.4 Fields

| Field | Function |
|---------------|---------------------|
| 15-0 | Packet Buffer Entry |
| PKT_BUFFER_TX | Packet Buffer Word |

45.6.2.15.42 Packet Buffer RX (PKT_BUFFER_RXa)

45.6.2.15.42.1 Address

For a = 0 to 63:

| Register | Offset |
|----------------|----------------------|
| PKT_BUFFER_RXa | 4005D180h + (a × 2h) |

45.6.2.15.42.2 Function

Packet Buffer RX

45.6.2.15.42.3 Diagram

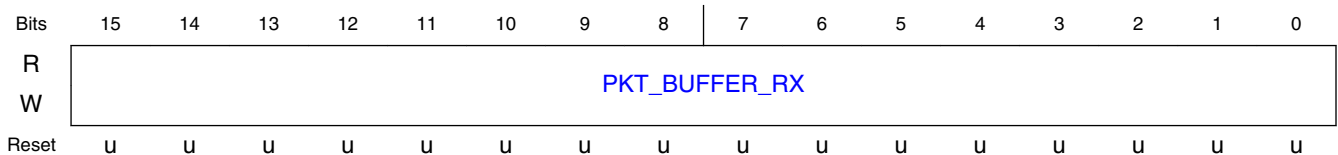

45.6.2.15.42.4 Fields

| Field | Function |
|-------|---------------------|
| 15-0 | Packet Buffer Entry |

| Field | Function |
|---------------|--------------------|
| PKT_BUFFER_RX | Packet Buffer Word |

45.6.3 Generic_FSK Link Layer Controller

45.6.3.1 Introduction

The Generic FSK protocol enables radio operation using a custom GFSK/GMSK or MSK modulation format achieved by programming a set of PHY variables such as BT product, modulation index and modulation filter co-efficients (such that max frequency deviation $\leq 500\text{kHz}$). Generic FSK mode also offers a highly configurable packet structure, variable bit rate transmission and reception, some limited packet (header) processing, and interface to a RAM-based Packet Buffer.

45.6.3.1.1 Overview

The Generic FSK Link Layer Controller provides the interface between Generic FSK software, and the 2.4GHz transceiver hardware. The interface consists of an IP bus-based set of registers, which provide command, control, and status to Generic FSK software. The Link Layer controller features programmability that allows for a highly configurable packet structure, defining the lengths, bit ordering, and contents of individual packet fields, defining the start and end points for whitening, CRC, and Manchester encoding/decoding, and providing for some primitive parsing of the packet header. The controller provides 3 options for bitrate, for both TX and RX. The Link Layer Controller implements a Sequence Command Set consisting of 12 commands; a command decoder to interpret the commands in realtime as they are received from Generic FSK software, and to provide the necessary control signals to the radio's Transceiver Sequence Manager (TSM); a high-precision timebase based on an external crystal-based oscillator; an Interrupt Control Unit; finite state machines to control the transmission and reception of Generic FSK packets; controls for CRC generation (TX) and verification (RX); controls for data whitening; Manchester encoding; interface to RAM-based Packet Buffer for packet storage; and provisions for entering and exiting low-power Deep Sleep Mode.

45.6.3.1.2 Features

Link Layer

- Highly configurable packet structure
- Optimized 12-entry Sequence Command Set
- High-precision timebase to maintain network timing
- Two timer-compare mechanisms for Interrupt Generation and Sequence Launching
- Hardware automation for packet transmit and receive, CRC, Whitening, and Manchester encoding
- Up to 4 Network Addresses to synchronize to, each can be 8-bit, 16-bit or 32-bit
- Packet Lengths up to 2047 Bytes
- Deep Sleep Mode support
- Highly configurable packet structure
- Optimized 12-entry Sequence Command Set
- High-precision timebase to maintain network timing
- Two timer-compare mechanisms for Interrupt Generation and Sequence Launching
- Hardware automation for packet transmit and receive, CRC, Whitening, and Manchester encoding
- Up to 4 Network Addresses to synchronize to, each can be 8-bit, 16-bit or 32-bit
- Packet Lengths up to 2047 Bytes
- Deep Sleep Mode support

45.6.3.1.3 Block Diagram

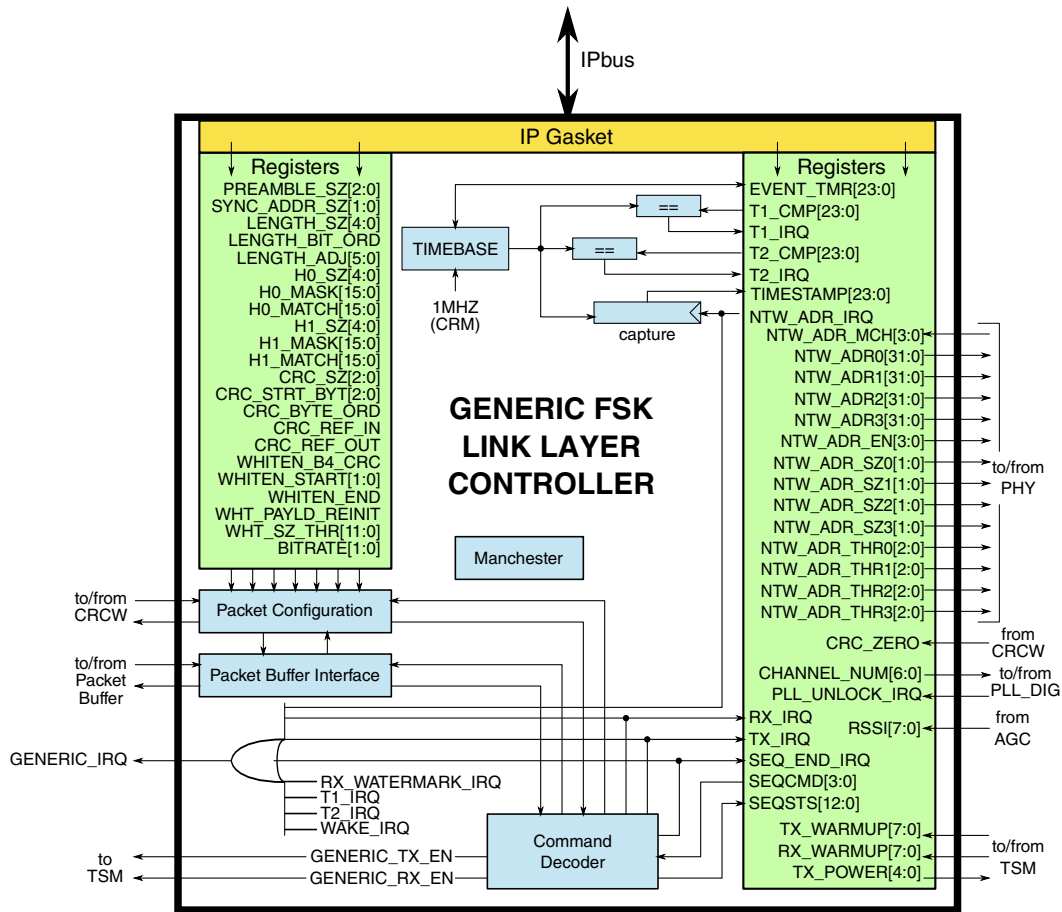

45.6.3.2 Memory Map and Register Definition

45.6.3.2.1 Memory Map

45.6.3.2.2 GENERIC_FSK Register Descriptions

45.6.3.2.2.1 FSK Memory Map

| Offset | Register | Width (In bits) | Access | Reset value |
|--------------------------|--|--------------------|--------|------------------|
| 4005F000h | IRQ CONTROL (IRQ_CTRL) | 32 | RW | See description. |
| 4005F004h | EVENT TIMER (EVENT_TMR) | 32 | RW | See description. |
| 4005F008h | T1 COMPARE (T1_CMP) | 32 | RW | 00FFFFFFh |
| 4005F00Ch | T2 COMPARE (T2_CMP) | 32 | RW | 00FFFFFFh |
| 4005F010h | TIMESTAMP (TIMESTAMP) | 32 | RO | See description. |
| 4005F014h | TRANSCEIVER CONTROL (XCVR_CTRL) | 32 | RW | See description. |
| 4005F018h | TRANSCEIVER STATUS (XCVR_STS) | 32 | RO | See description. |
| 4005F01Ch | TRANSCEIVER CONFIGURATION (XCVR_CFG) | 32 | RW | See description. |
| 4005F020h | CHANNEL NUMBER (CHANNEL_NUM) | 32 | RW | 00000000h |
| 4005F024h | TRANSMIT POWER (TX_POWER) | 32 | RW | 00000000h |
| 4005F028h | NETWORK ADDRESS CONTROL (NTW_ADR_CTRL) | 32 | RW | See description. |
| 4005F02Ch | NETWORK ADDRESS 0 (NTW_ADR_0) | 32 | RW | 55555555h |
| 4005F030h | NETWORK ADDRESS 1 (NTW_ADR_1) | 32 | RW | 55555555h |
| 4005F034h | NETWORK ADDRESS 2 (NTW_ADR_2) | 32 | RW | 55555555h |
| 4005F038h | NETWORK ADDRESS 3 (NTW_ADR_3) | 32 | RW | 55555555h |
| 4005F03Ch | RECEIVE WATERMARK (RX_WATERMARK) | 32 | RW | See description. |
| 4005F040h | DSM CONTROL (DSM_CTRL) | 32 | WO | See description. |
| 4005F044h | PART ID (PART_ID) | 32 | RO | 00000000h |
| 4005F060h | PACKET CONFIGURATION (PACKET_CFG) | 32 | RW | See description. |
| 4005F064h | H0 CONFIGURATION (H0_CFG) | 32 | RW | 00000000h |
| 4005F068h | H1 CONFIGURATION (H1_CFG) | 32 | RW | 00000000h |
| 4005F06Ch | CRC CONFIGURATION (CRC_CFG) | 32 | RW | 00000002h |
| 4005F070h | CRC INITIALIZATION (CRC_INIT) | 32 | RW | 00000000h |
| 4005F074h | CRC POLYNOMIAL (CRC_POLY) | 32 | RW | 10210000h |
| 4005F078h | CRC XOR OUT (CRC_XOR_OUT) | 32 | RW | 00000000h |
| 4005F07Ch | WHITENER CONFIGURATION (WHITEN_CFG) | 32 | RW | 01FF0918h |
| 4005F080h | WHITENER POLYNOMIAL (WHITEN_POLY) | 32 | RW | 00000021h |
| 4005F084h | WHITENER SIZE THRESHOLD (WHITEN_SZ_THR) | 32 | RW | 00000800h |
| 4005F088h | BIT RATE (BITRATE) | 32 | RW | 00000000h |
| 4005F08Ch | PACKET BUFFER PARTITION POINT (PB_PARTITION) | 32 | RW | 00000220h |
| 4005F700h - 4005FF7Eh | PACKET BUFFER (PACKET_BUFFER_0 - PACKET_BUFFER_10 87) | 16 | RW | See description. |

45.6.3.2.2.2 IRQ CONTROL (IRQ_CTRL)

45.6.3.2.2.2.1 Address

| Register | Offset |
|----------|-----------|
| IRQ_CTRL | 4005F000h |

45.6.3.2.2.2.2 Diagram

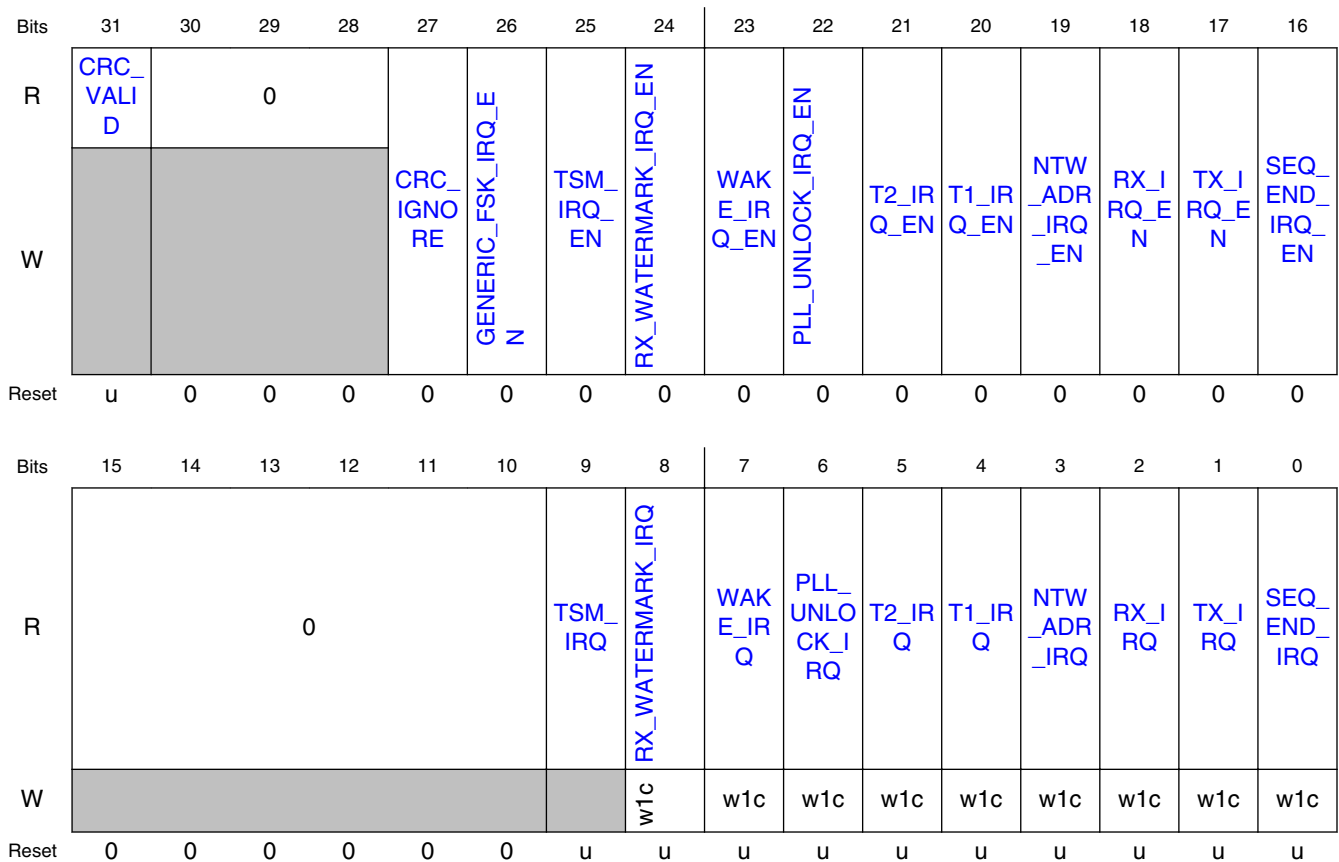

45.6.3.2.2.2.3 Fields

| Field | Function |
|-----------------|--|
| 31 CRC_VALID | CRC Valid CRC Valid indicator for RX packets. This bit becomes valid at RX_IRQ, and remains valid until the start of the next RX TSM sequence. 0b - CRC of RX packet is not valid. |

Table continues on the next page...

Link Layer

| Field | Function |
|---------------------------|---|
| | 1b - CRC of RX packet is valid. |
| 30-28 — | Reserved. |
| 27 CRC_IGNORE | CRC Ignore If set, assert RX_IRQ even for a received packet which fails CRC verification. 0b - RX_IRQ will not be asserted for a received packet which fails CRC verification. 1b - RX_IRQ will be asserted even for a received packet which fails CRC verification. |
| 26 GENERIC_FSK_IRQ_EN | GENERIC_FSK_IRQ Master Enable Master enable for the GENERIC_FSK_IRQ interrupt line to the MCU. 0b - All GENERIC_FSK Interrupts are disabled. 1b - All GENERIC_FSK Interrupts can be enabled. |
| 25 TSM_IRQ_EN | TSM_IRQ Enable 0b - TSM Interrupt is not enabled. 1b - TSM Interrupt is enabled. |
| 24 RX_WATERMARK_IRQ_EN | RX_WATERMARK_IRQ Enable 0b - RX Watermark Interrupt is not enabled. 1b - RX Watermark Interrupt is enabled. |
| 23 WAKE_IRQ_EN | WAKE_IRQ Enable 0b - Wake Interrupt is not enabled. 1b - Wake Interrupt is enabled. |
| 22 PLL_UNLOCK_IRQ_EN | PLL_UNLOCK_IRQ Enable 0b - PLL Unlock Interrupt is not enabled. 1b - PLL Unlock Interrupt is enabled. |
| 21 T2_IRQ_EN | T2_IRQ Enable 0b - Timer1 (T2) Compare Interrupt is not enabled. 1b - Timer1 (T2) Compare Interrupt is enabled. |
| 20 T1_IRQ_EN | T1_IRQ Enable 0b - Timer1 (T1) Compare Interrupt is not enabled. 1b - Timer1 (T1) Compare Interrupt is enabled. |
| 19 NTW_ADR_IRQ_EN | NTW_ADR_IRQ Enable 0b - Network Address Match Interrupt is not enabled. 1b - Network Address Match Interrupt is enabled. |
| 18 RX_IRQ_EN | RX_IRQ Enable 0b - RX Interrupt is not enabled. 1b - RX Interrupt is enabled. |
| 17 TX_IRQ_EN | TX_IRQ Enable 0b - TX Interrupt is not enabled. 1b - TX Interrupt is enabled. |
| 16 SEQ_END_IRQ_EN | SEQ_END_IRQ Enable 0b - Sequence End Interrupt is not enabled. 1b - Sequence End Interrupt is enabled. |
| 15-10 — | Reserved. |
| 9 TSM_IRQ | TSM Interrupt Indicates TSM0_IRQ or TSM1_IRQ is set in XCVR_STATUS. Clear the bits there. For debug purposes. 0b - TSM0_IRQ and TSM1_IRQ are both clear. 1b - Indicates TSM0_IRQ or TSM1_IRQ is set in XCVR_STATUS. |

Table continues on the next page...

| Field | Function |
|---------------------------|--|
| 8 RX_WATERMARK_IRQ | RX Watermark Interrupt Asserts when RX Byte Counter == RX_WATERMARK[12:0] 0b - RX Watermark Interrupt is not asserted. 1b - RX Watermark Interrupt is asserted. |
| 7 WAKE_IRQ | Wake Interrupt Wake Interrupt. The SLEEP_TMR has matched GENERIC_FSK_WAKE and DSM has exited. The GENERIC_FSK_EVENT_TMR has resumed counting. 0b - Wake Interrupt is not asserted. 1b - Wake Interrupt is asserted. |
| 6 PLL_UNLOCK_INTERRUPT | PLL Unlock Interrupt An unlock event has occurred. 0b - PLL Unlock Interrupt is not asserted. 1b - PLL Unlock Interrupt is asserted. |
| 5 T2_IRQ | Timer2 (T2) Compare Interrupt 0b - Timer2 (T2) Compare Interrupt is not asserted. 1b - Timer2 (T2) Compare Interrupt is asserted. |
| 4 T1_IRQ | Timer1 (T1) Compare Interrupt 0b - Timer1 (T1) Compare Interrupt is not asserted. 1b - Timer1 (T1) Compare Interrupt is asserted. |
| 3 NTW_ADDR_IRQ | Network Address Match Interrupt A Network Address Match has occurred. 0b - Network Address Match Interrupt is not asserted. 1b - Network Address Match Interrupt is asserted. |
| 2 RX_IRQ | RX Interrupt The RX sequence has completed with a successful packet reception. 0b - RX Interrupt is not asserted. 1b - RX Interrupt is asserted. |
| 1 TX_IRQ | TX Interrupt The TX sequence has completed with a successful packet transmission. 0b - TX Interrupt is not asserted. 1b - TX Interrupt is asserted. |
| 0 SEQ_END_IRQ | Sequence End Interrupt Will assert when any TX or RX sequence ends for any reason. 0b - Sequence End Interrupt is not asserted. 1b - Sequence End Interrupt is asserted. |

45.6.3.2.2.3 EVENT TIMER (EVENT_TMR)

45.6.3.2.2.3.1 Address

| Register | Offset |
|-----------|-----------|
| EVENT_TMR | 4005F004h |

45.6.3.2.2.3.2 Diagram

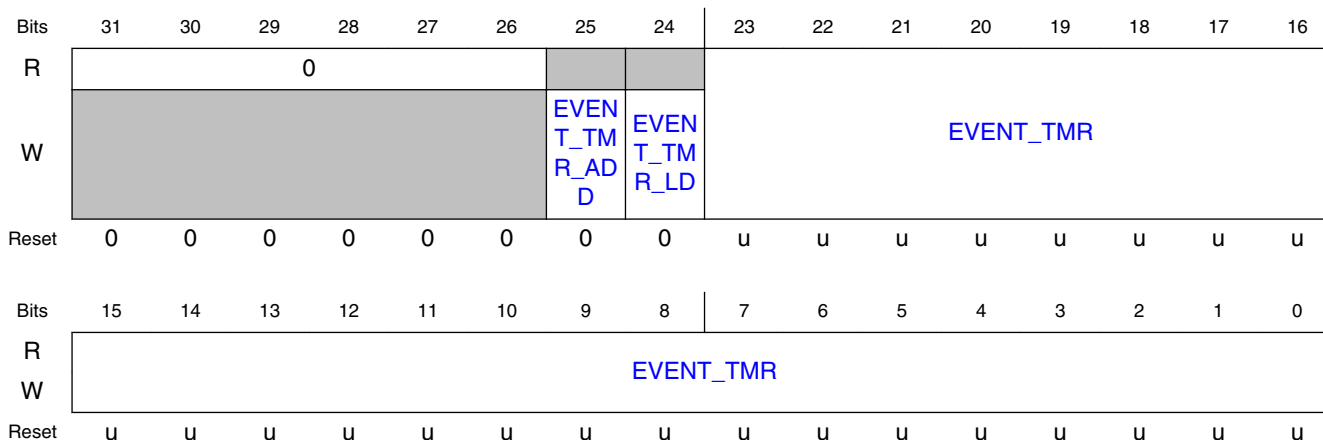

45.6.3.2.2.3.3 Fields

| Field | Function |
|---------------------|--|
| 31-26 — | Reserved. |
| 25 EVENT_TMR_ADD | Event Timer Add A write access with this bit increments EVENT_TMR by the contents of EVENT_TMR[23:0]. This is a signed addition. |
| 24 EVENT_TMR_LD | Event Timer Load A write access with this bit set loads EVENT_TMR with the contents of EVENT_TMR[23:0] |
| 23-0 EVENT_TMR | Event Timer Event Timer can be read in these byte locations. To update the Event Timer, either: 1. Write the desired EVENT_TMR to these bytes and set EVENT_TMR_LD=1, or, 2. Write the desired EVENT_TMR increment amount to these bytes and set EVENT_TMR_ADD=1. Note: for EVENT_TMR_ADD, EVENT_TMR[23:0] is a signed, two's-complement value. |

45.6.3.2.2.4 T1 COMPARE (T1_CMP)

45.6.3.2.2.4.1 Address

| Register | Offset |
|----------|-----------|
| T1_CMP | 4005F008h |

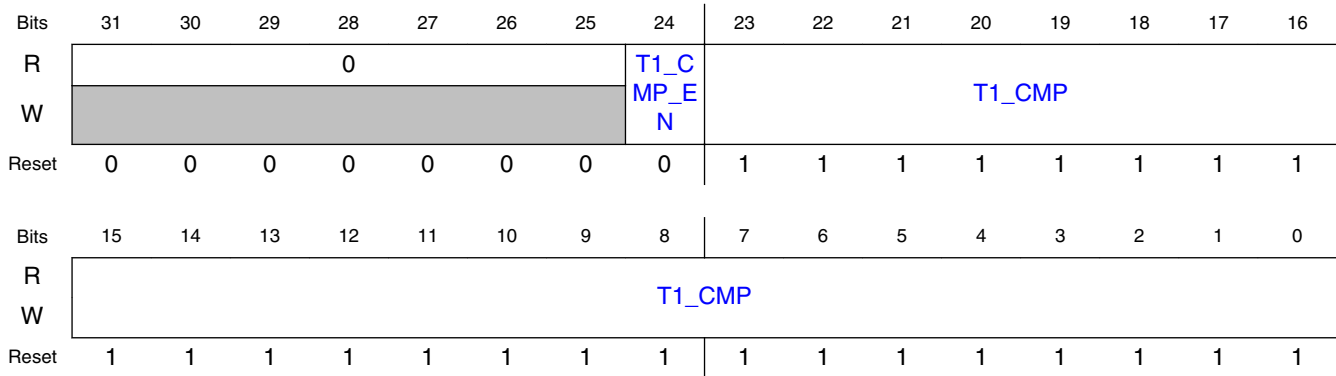
45.6.3.2.2.4.2 *Diagram*45.6.3.2.2.4.3 *Fields*

| Field | Function |
|-----------------|--|
| 31-25 — | Reserved. |
| 24 T1_CMP_EN | Timer1 (T1) Compare Enable Enable Timer Compare #1 (T1_CMP) to generate T1_IRQ and/or execute Sequence Commands. |
| 23-0 T1_CMP | Timer1 (T1) Compare Value Timer1 (T1) Compare Value. Can be used to generate T1_IRQ and/or launch Sequence Commands |

45.6.3.2.2.5 **T2 COMPARE (T2_CMP)**45.6.3.2.2.5.1 *Address*

| Register | Offset |
|----------|-----------|
| T2_CMP | 4005F00Ch |

Link Layer

45.6.3.2.2.5.2 Diagram

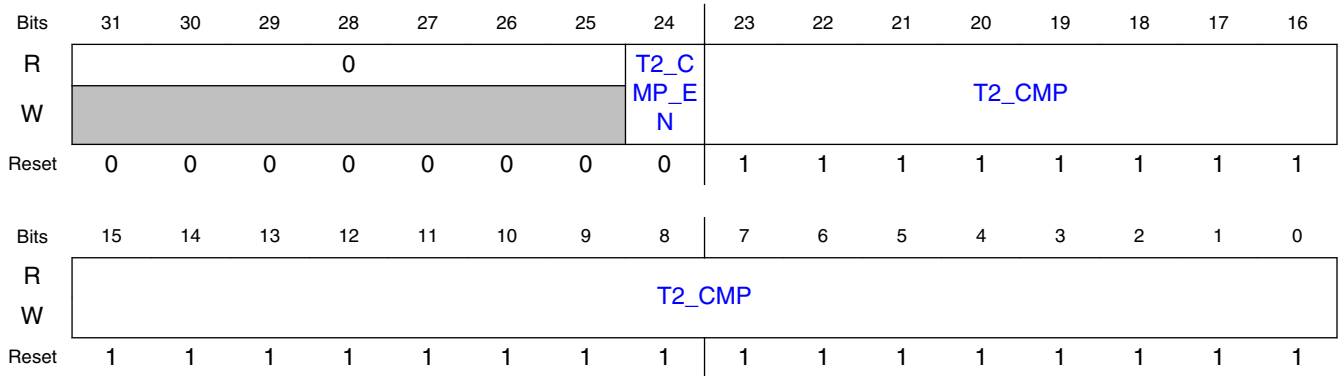

45.6.3.2.2.5.3 Fields

| Field | Function |
|-----------------|--|
| 31-25 — | Reserved. |
| 24 T2_CMP_EN | Timer2 (T2) Compare Enable Enable Timer Compare #2 (T2_CMP) to generate T2_IRQ and/or execute Sequence Commands. |
| 23-0 T2_CMP | Timer2 (T2) Compare Value Timer2 (T2) Compare Value. Can be used to generate T2_IRQ and/or launch Sequence Commands |

45.6.3.2.2.6 TIMESTAMP (TIMESTAMP)

45.6.3.2.2.6.1 Address

| Register | Offset |
|-----------|-----------|
| TIMESTAMP | 4005F010h |

45.6.3.2.2.6.2 Diagram

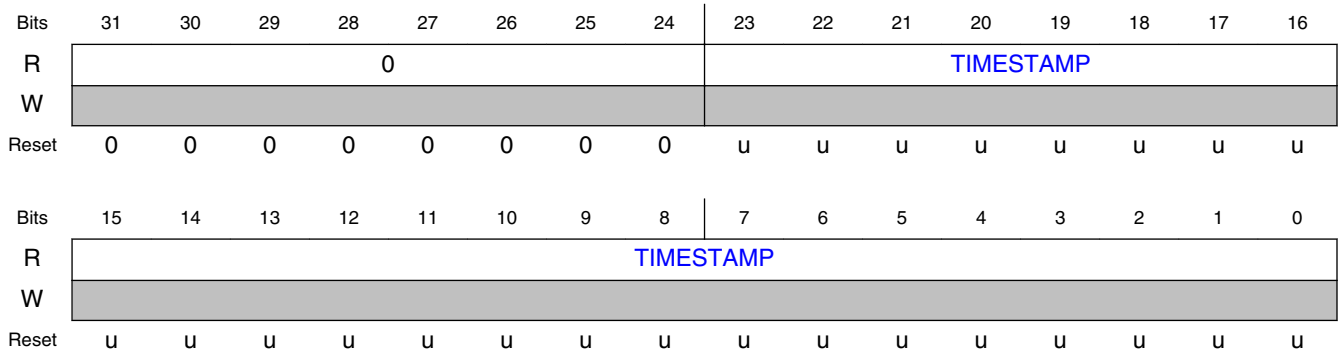

45.6.3.2.2.6.3 Fields

| Field | Function |
|-------------------|--|
| 31-24 — | Reserved. |
| 23-0 TIMESTAMP | Received Packet Timestamp Received Packet Timestamp. Captured at NTW_ADR_IRQ. |

45.6.3.2.2.7 TRANSCEIVER CONTROL (XCVR_CTRL)

45.6.3.2.2.7.1 Address

| Register | Offset |
|-----------|-----------|
| XCVR_CTRL | 4005F014h |

45.6.3.2.2.7.2 Diagram

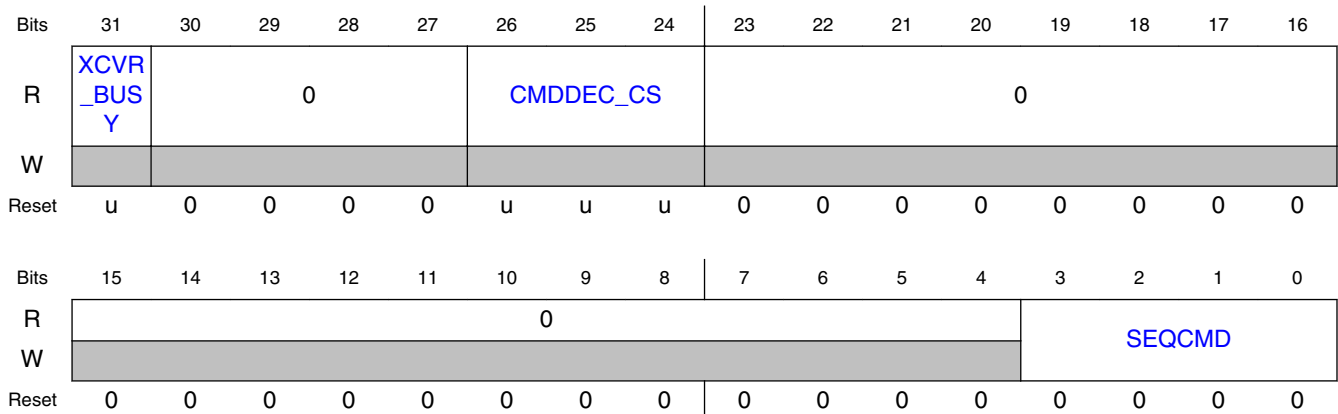

45.6.3.2.2.7.3 Fields

| Field | Function |
|--------------------|---|
| 31 XCVR_BUSY | Transceiver Busy For multi-protocol arbitration, XCVR_BUSY=1 indicates an RX or TX operation is underway, by either GENERIC_FSK, or some other protocol. 0b - IDLE 1b - BUSY |
| 30-27 — | Reserved. |
| 26-24 CMDDEC_CS | Command Decode Current State of the Command Decoder FSM (debug only) |
| 23-4 Reserved | Reserved. |
| 3-0 SEQCMD | Sequence Commands 0000b - No Action 0001b - TX Start Now 0010b - TX Start @ T1 Timer Compare Match (EVENT_TMR = T1_CMP) 0011b - TX Start @ T2 Timer Compare Match (EVENT_TMR = T2_CMP) 0100b - TX Cancel -- Cancels pending TX events but do not abort a TX-in-progress 0101b - RX Start Now 0110b - RX Start @ T1 Timer Compare Match (EVENT_TMR = T1_CMP) 0111b - RX Start @ T2 Timer Compare Match (EVENT_TMR = T2_CMP) 1000b - RX Stop @ T1 Timer Compare Match (EVENT_TMR = T1_CMP) 1001b - RX Stop @ T2 Timer Compare Match (EVENT_TMR = T2_CMP) 1010b - RX Cancel -- Cancels pending RX events but do not abort a RX-in-progress 1011b - Abort All - Cancels all pending events and abort any sequence-in-progress 1100b - Reserved 1101b - Reserved 1110b - Reserved 1111b - Reserved |

45.6.3.2.2.8 TRANSCEIVER STATUS (XCVR_STS)

45.6.3.2.2.8.1 Address

| Register | Offset |
|----------|-----------|
| XCVR_STS | 4005F018h |

45.6.3.2.2.8.2 Diagram

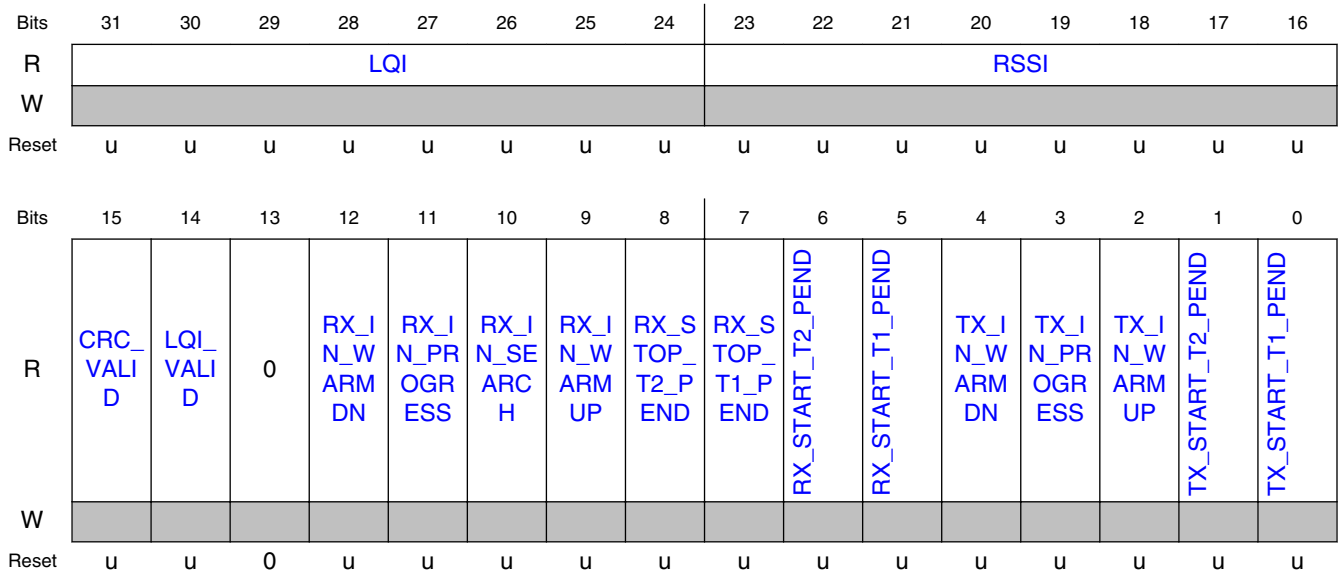

45.6.3.2.2.8.3 Fields

| Field | Function |
|----------------------|--|
| 31-24 LQI | Link Quality Indicator This field is valid when LQI_VALID=1. LQI is a unsigned, unitless value. |
| 23-16 RSSI | Received Signal Strength Indicator, in dBm |
| 15 CRC_VALID | CRC Valid Indicator CRC Valid indicator for RX packets. 0b - CRC is not valid for RX packet. 1b - CRC is valid for RX packet. |
| 14 LQI_VALID | LQI Valid Indicator LQI Valid indicator for RX packets. This bit becomes set when the LQI computation completes for the packet currently being received, and remains set for the remainder of the packet. 0b - LQI is not yet valid for RX packet. 1b - LQI is valid for RX packet. |
| 13 — | Reserved. |
| 12 RX_IN_WARMDOWN | RX Warmdown Status RX Sequence in TSM Warmdown |
| 11 RX_IN_PROGRESS | RX in Progress Status RX Packet Reception Currently Underway |
| 10 | RX Search Status |

Table continues on the next page...

Link Layer

| Field | Function |
|------------------|---|
| RX_IN_SEARCH | RX Sequence in Network Address Search |
| 9 | RX Warmup Status |
| RX_IN_WARMUP | RX Sequence in TSM Warmup |
| 8 | RX T2 Start Pending Status |
| RX_STOP_T2_PEND | RX Sequence will stop @ next T2 Match |
| 7 | RX T1 Stop Pending Status |
| RX_STOP_T1_PEND | RX Sequence will stop @ next T1 Match |
| 6 | RX T2 Start Pending Status |
| RX_START_T2_PEND | RX Sequence will start @ next T2 Match |
| 5 | RX T1 Start Pending Status |
| RX_START_T1_PEND | RX Sequence will start @ next T1 Match |
| 4 | TX Warmdown Status |
| TX_IN_WARMDOWN | TX Sequence in TSM Warmdown |
| 3 | TX in Progress Status |
| TX_IN_PROGRESS | TX Packet Transmission Currently Underway |
| 2 | TX Warmup Status |
| TX_IN_WARMUP | TX Sequence in TSM Warmup |
| 1 | TX T2 Start Pending Status |
| TX_START_T2_PEND | TX Sequence will start @ next T2 Match |
| 0 | TX T1 Start Pending Status |
| TX_START_T1_PEND | TX Sequence will start @ next T1 Match |

45.6.3.2.2.9 TRANSCEIVER CONFIGURATION (XCVR_CFG)

45.6.3.2.2.9.1 Address

| Register | Offset |
|----------|-----------|
| XCVR_CFG | 4005F01Ch |

45.6.3.2.2.9.2 Diagram

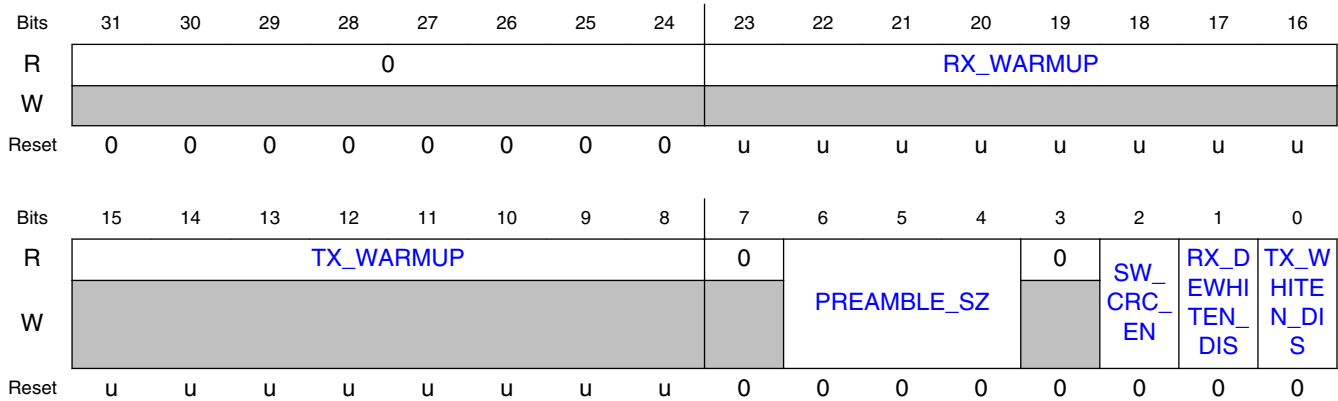

45.6.3.2.2.9.3 Fields

| Field | Function |
|---------------------------|---|
| 31-24 — | Reserved. |
| 23-16 RX_WARMUP | Receive Warmup Time RX warmup time, in microseconds, provided to Link Layer software, so that warmup time can be accounted for when scheduling over-the-air transactions. |
| 15-8 TX_WARMUP | Transmit Warmup Time TX warmup time, in microseconds, provided to Link Layer software, so that warmup time can be accounted for when scheduling over-the-air transactions. |
| 7 — | Reserved. |
| 6-4 PREAMBLE_SZ | Preamble Size Number of Octets = PREAMBLE_SZ + 1, where 0 <= PREAMBLE_SZ <= 7 |
| 3 — | Reserved. |
| 2 SW_CRC_EN | Software CRC Enable Software override of the HW-computed CRC for TX. Software must write CRC to Packet Buffer (RAM) |
| 1 RX_DEWHITEN_DIS | RX De-Whitening Disable Disable all de-whitening on RX packets |
| 0 TX_WHITENING_DISABLE | TX Whitening Disable Disable all whitening on TX packets |

45.6.3.2.2.10 CHANNEL NUMBER (CHANNEL_NUM)

Link Layer

45.6.3.2.2.10.1 Address

| Register | Offset |
|-------------|-----------|
| CHANNEL_NUM | 4005F020h |

45.6.3.2.2.10.2 Diagram

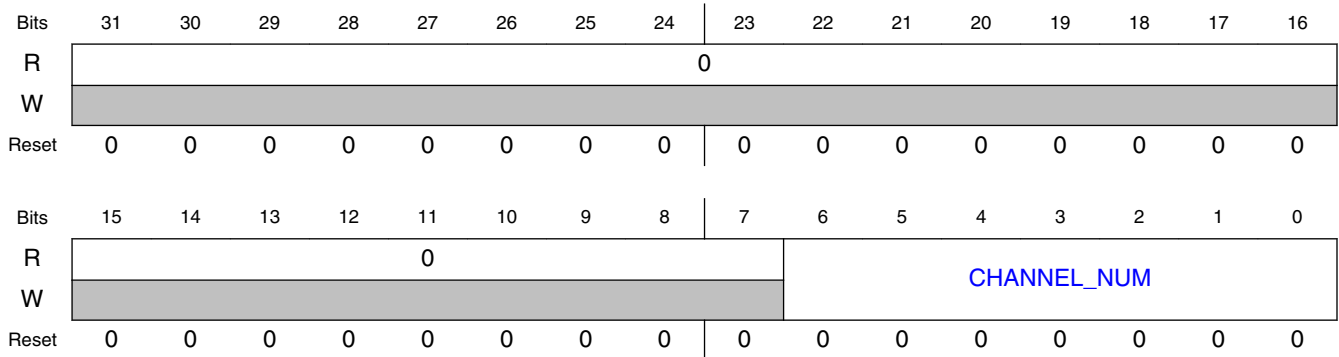

45.6.3.2.2.10.3 Fields

| Field | Function |
|-------------------------|--|
| 31-7 Reserved | Reserved. |
| 6-0 CHANNEL_NUM M | Channel Number RF Channel Select: 0 <= CHANNEL_NUM <= 127; Formula: F = (2360 + CHANNEL_NUM) [in MHz] |

45.6.3.2.2.11 TRANSMIT POWER (TX_POWER)

45.6.3.2.2.11.1 Address

| Register | Offset |
|----------|-----------|
| TX_POWER | 4005F024h |

45.6.3.2.2.11.2 Diagram

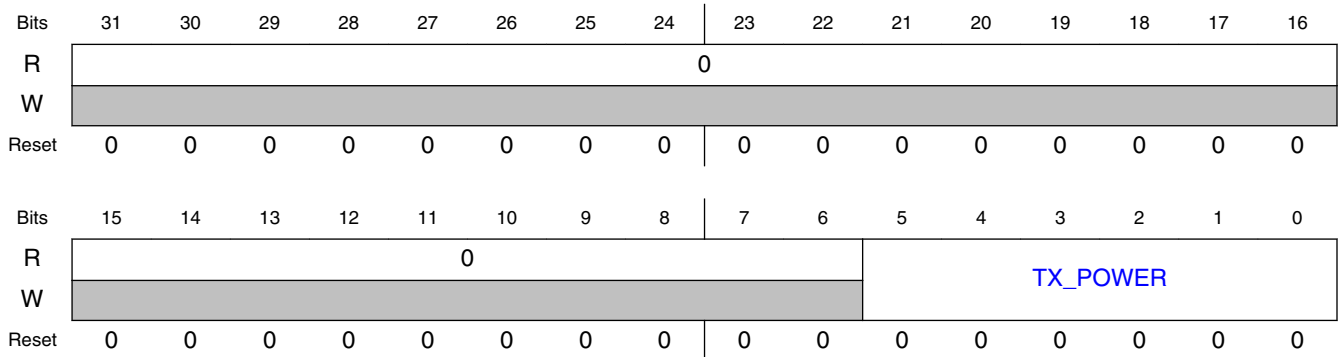

45.6.3.2.2.11.3 Fields

| Field | Function |
|------------------|-----------------------------------|
| 31-6 Reserved | Reserved. |
| 5-0 TX_POWER | Transmit Power PA Power Level. |

45.6.3.2.2.12 NETWORK ADDRESS CONTROL (NTW_ADR_CTRL)

45.6.3.2.2.12.1 Address

| Register | Offset |
|--------------|-----------|
| NTW_ADR_CTRL | 4005F028h |

45.6.3.2.2.12.2 Diagram

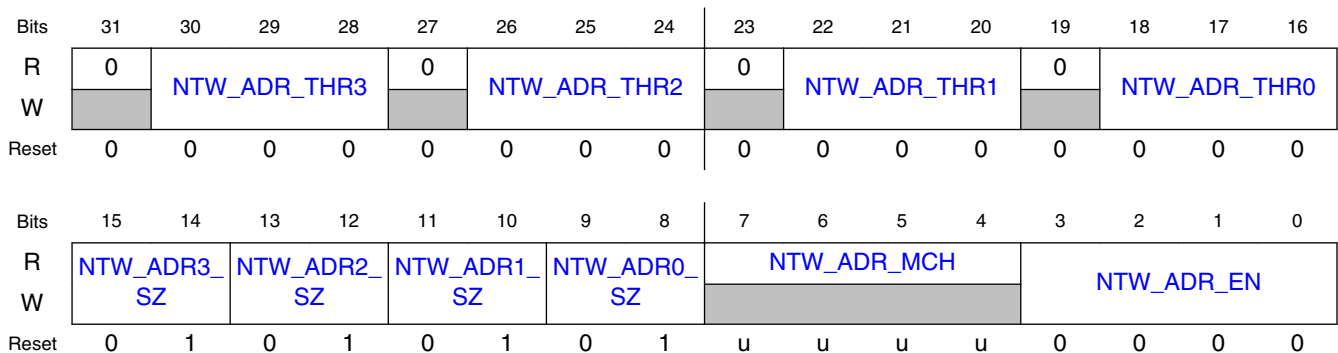

45.6.3.2.2.12.3 Fields

| Field | Function |
|---------------------------|---|
| 31 — | Reserved. |
| 30-28 NTW_ADR_TH R3 | Network Address 3 Threshold Number of Tolerated bit errors for Network Address 3 |
| 27 — | Reserved. |
| 26-24 NTW_ADR_TH R2 | Network Address 2 Threshold Number of Tolerated bit errors for Network Address 2 |
| 23 — | Reserved. |
| 22-20 NTW_ADR_TH R1 | Network Address 1 Threshold Number of Tolerated bit errors for Network Address 1 |
| 19 — | Reserved. |
| 18-16 NTW_ADR_TH R0 | Network Address 0 Threshold Number of Tolerated bit errors for Network Address 0 |
| 15-14 NTW_ADR3_SZ | Network Address 3 Size 00b - Network Address 3 requires a 8-bit correlation 01b - Network Address 3 requires a 16-bit correlation 10b - Network Address 3 requires a 24-bit correlation 11b - Network Address 3 requires a 32-bit correlation |
| 13-12 NTW_ADR2_SZ | Network Address 2 Size 00b - Network Address 2 requires a 8-bit correlation 01b - Network Address 2 requires a 16-bit correlation 10b - Network Address 2 requires a 24-bit correlation 11b - Network Address 2 requires a 32-bit correlation |
| 11-10 NTW_ADR1_SZ | Network Address 1 Size 00b - Network Address 1 requires a 8-bit correlation 01b - Network Address 1 requires a 16-bit correlation 10b - Network Address 1 requires a 24-bit correlation 11b - Network Address 1 requires a 32-bit correlation |
| 9-8 NTW_ADR0_SZ | Network Address 0 Size 00b - Network Address 0 requires a 8-bit correlation 01b - Network Address 0 requires a 16-bit correlation 10b - Network Address 0 requires a 24-bit correlation 11b - Network Address 0 requires a 32-bit correlation |
| 7-4 NTW_ADR_MC H | Network Address Match Indicates which of the 4 Network Addresses has matched in the PHY. Valid during an RX sequence at the point of match, and remains asserted until either: |

Table continues on the next page...

| Field | Function |
|-------------------|--|
| | 1. The next RX sequence begins (if the current packet passed CRC and header filtering), or, 2. An RX recycle to Network Address search (if the current packet failed CRC or header filtering) 0001b - Network Address 0 has matched 0010b - Network Address 1 has matched 0100b - Network Address 2 has matched 1000b - Network Address 3 has matched |
| 3-0 NTW_ADR_EN | Network Address Enable Enable Network Address N for PHY correlation, where $0 \leq N \leq 3$. Any bit combination can be set. 0001b - Enable Network Address 0 for correlation 0010b - Enable Network Address 1 for correlation 0100b - Enable Network Address 2 for correlation 1000b - Enable Network Address 3 for correlation |

45.6.3.2.2.13 NETWORK ADDRESS 0 (NTW_ADR_0)

45.6.3.2.2.13.1 Address

| Register | Offset |
|-----------|-----------|
| NTW_ADR_0 | 4005F02Ch |

45.6.3.2.2.13.2 Diagram

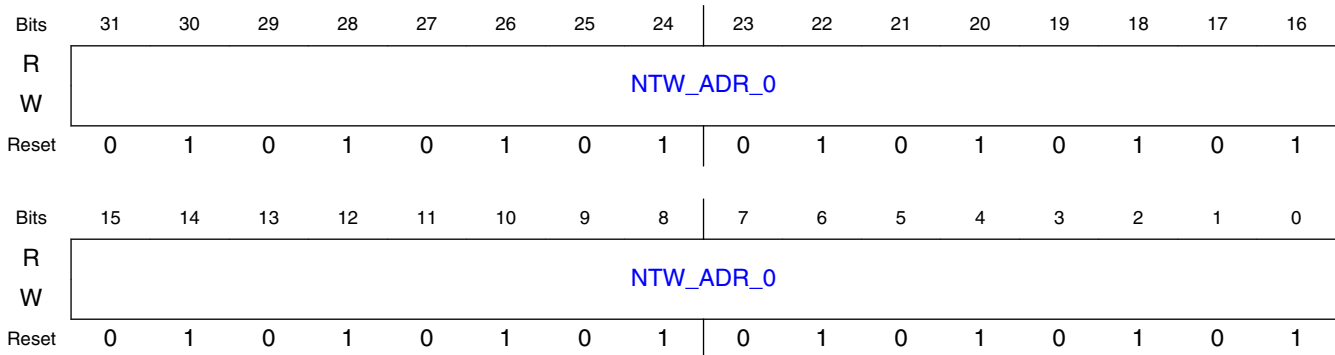

45.6.3.2.2.13.3 Fields

| Field | Function |
|-------------------|--|
| 31-0 NTW_ADR_0 | Network Address 0 The PHY will search for this Network Address if $NTW_ADR_CTRL[NTW_ADR_EN[0]] = 1$ |

45.6.3.2.2.14 NETWORK ADDRESS 1 (NTW_ADR_1)

45.6.3.2.2.14.1 Address

| Register | Offset |
|-----------|-----------|
| NTW_ADR_1 | 4005F030h |

45.6.3.2.2.14.2 Diagram

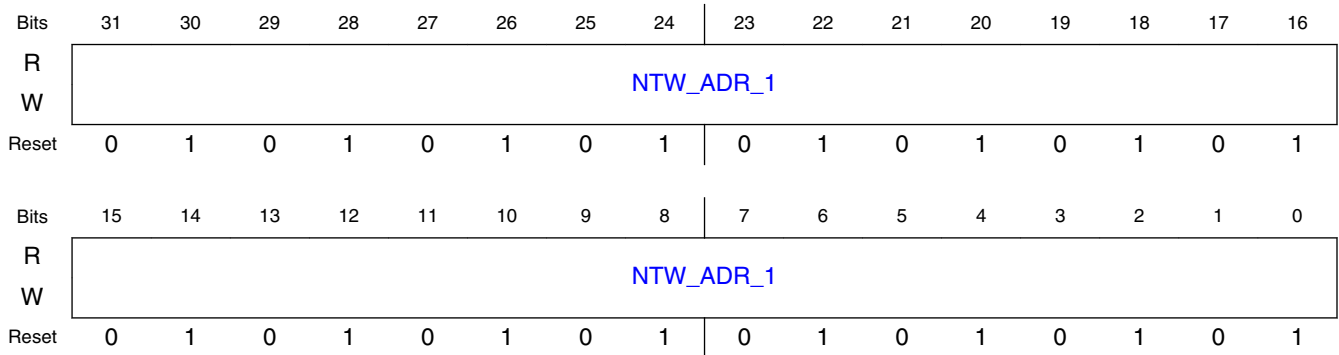

45.6.3.2.2.14.3 Fields

| Field | Function |
|-----------|---|
| 31-0 | Network Address 1 |
| NTW_ADR_1 | The PHY will search for this Network Address if NTW_ADR_CTRL[NTW_ADR_EN[1]] = 1 |

45.6.3.2.2.15 NETWORK ADDRESS 2 (NTW_ADR_2)

45.6.3.2.2.15.1 Address

| Register | Offset |
|-----------|-----------|
| NTW_ADR_2 | 4005F034h |

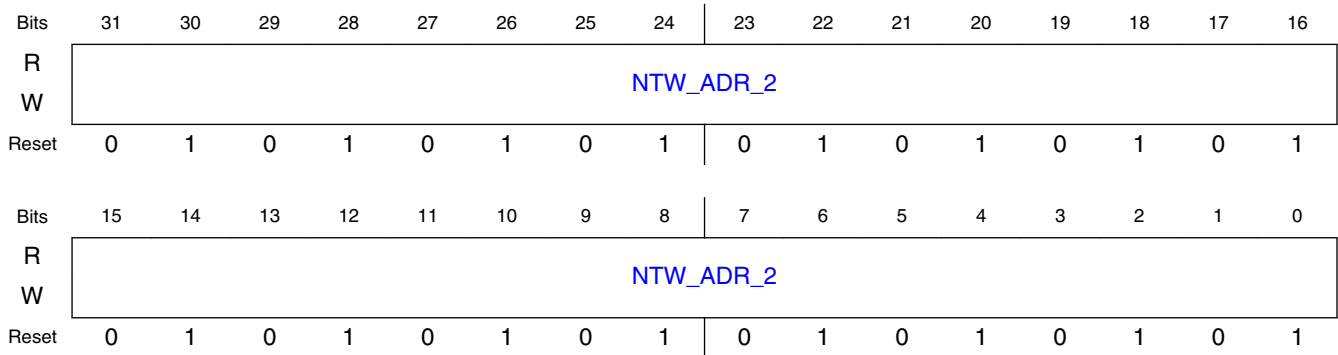
45.6.3.2.2.15.2 *Diagram*45.6.3.2.2.15.3 *Fields*

| Field | Function |
|-----------|---|
| 31-0 | Network Address 2 |
| NTW_ADR_2 | The PHY will search for this Network Address if NTW_ADR_CTRL[NTW_ADR_EN[2]] = 1 |

45.6.3.2.2.16 NETWORK ADDRESS 3 (NTW_ADR_3)

45.6.3.2.2.16.1 *Address*

| Register | Offset |
|-----------|-----------|
| NTW_ADR_3 | 4005F038h |

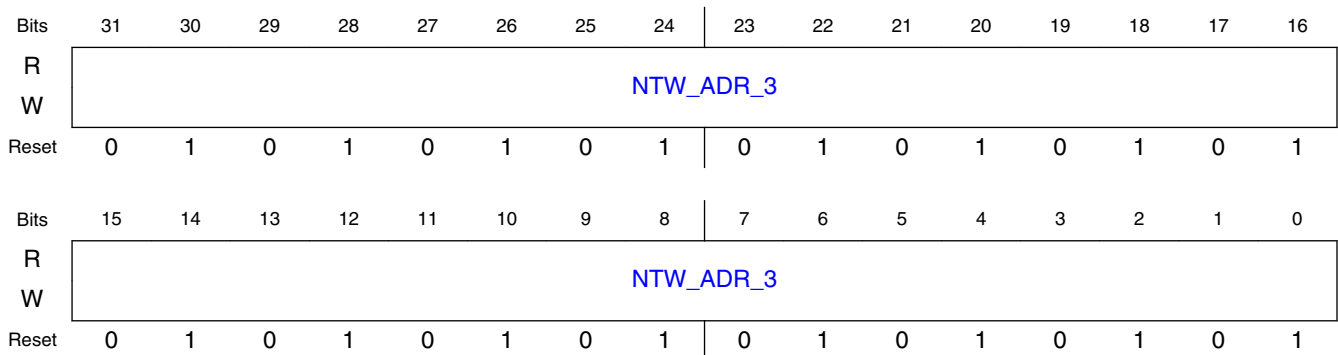
45.6.3.2.2.16.2 *Diagram*

45.6.3.2.2.16.3 Fields

| Field | Function |
|-------------------|--|
| 31-0 NTW_ADR_3 | Network Address 2 The PHY will search for this Network Address if NTW_ADR_CTRL[NTW_ADR_EN[3]] = 1 |

45.6.3.2.2.17 RECEIVE WATERMARK (RX_WATERMARK)

45.6.3.2.2.17.1 Address

| Register | Offset |
|--------------|-----------|
| RX_WATERMARK | 4005F03Ch |

45.6.3.2.2.17.2 Diagram

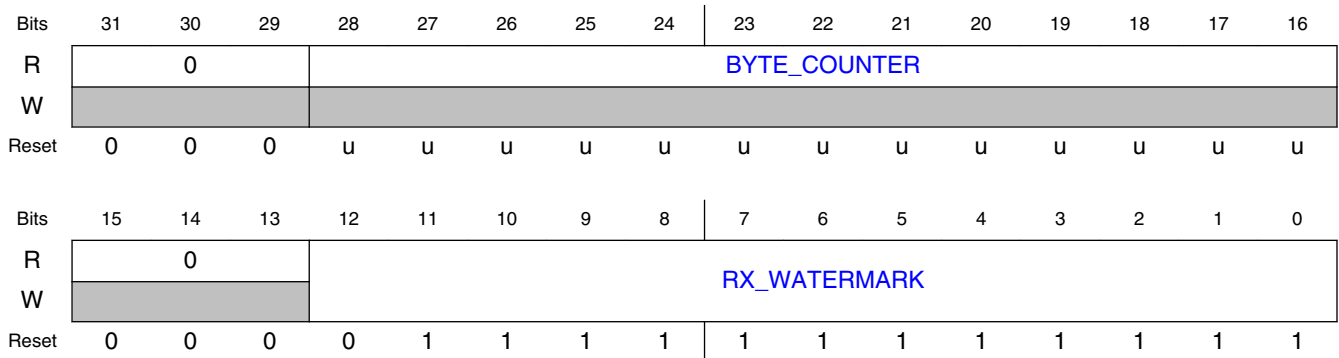

45.6.3.2.2.17.3 Fields

| Field | Function |
|----------------------------|--|
| 31-29 — | Reserved. |
| 28-16 BYTE_COUNTEN R | Byte Counter Reflects the current Byte Count, for TX and RX. This is a signed, twos-complement value. For values less than zero, indicates the preamble transmission is underway (TX only). A value of 0 indicates the first octet of Network Address is being transmitted or received. A value of 1 indicates the second octet of Network Address is being transmitted or received. Etc. |
| 15-13 — | Reserved. |
| 12-0 RX_WATERMA RK | Receive Watermark Sets the trigger for RX_WATERMARK_IRQ. Trigger the RX_WATERMARK_IRQ when: RX Byte Counter == RX_WATERMARK[12:0] |

45.6.3.2.2.18 DSM CONTROL (DSM_CTRL)

45.6.3.2.2.18.1 Address

| Register | Offset |
|----------|-----------|
| DSM_CTRL | 4005F040h |

45.6.3.2.2.18.2 Diagram

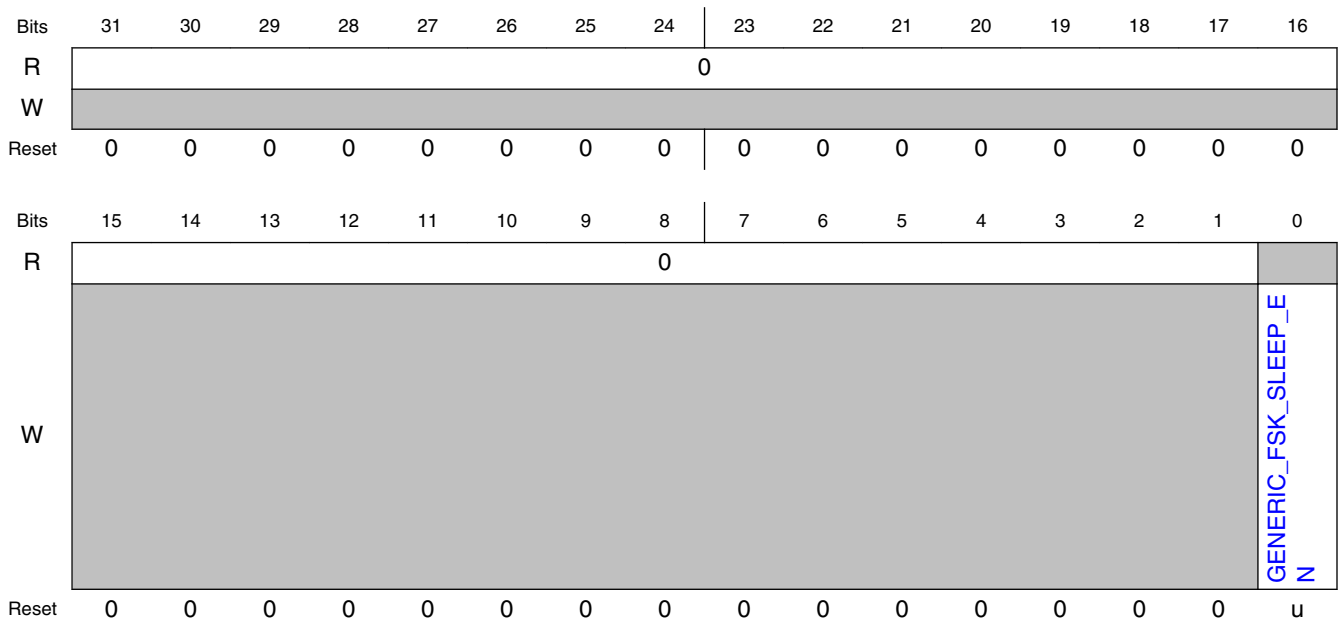

45.6.3.2.2.18.3 Fields

| Field | Function |
|---------------------------|---|
| 31-1 Reserved | Reserved. |
| 0 GENERIC_FSK_SLEEP_EN | GENERIC_FSK DSM Sleep Enable If GENERIC_FSK_SLEEP_EN=1, enter DSM and freeze EVENT_TMR when GEN_SLEEP matches DSM_TIMER. Note: GEN_SLEEP and DSM_TIMER registers reside in RSIM space. |

45.6.3.2.2.19 PART ID (PART_ID)

45.6.3.2.2.19.1 Address

| Register | Offset |
|----------|-----------|
| PART_ID | 4005F044h |

45.6.3.2.2.19.2 Diagram

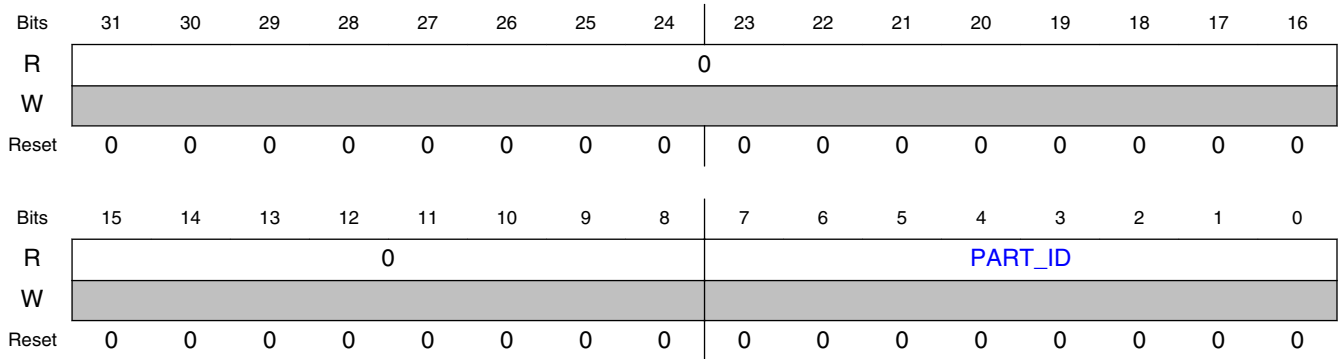

45.6.3.2.2.19.3 Fields

| Field | Function |
|------------------|--|
| 31-8 Reserved | Reserved. |
| 7-0 PART_ID | Part ID Part ID to identify HW revision of the Generic FSK Link Layer |

45.6.3.2.2.20 PACKET CONFIGURATION (PACKET_CFG)

45.6.3.2.2.20.1 Address

| Register | Offset |
|------------|-----------|
| PACKET_CFG | 4005F060h |

45.6.3.2.2.20.2 Diagram

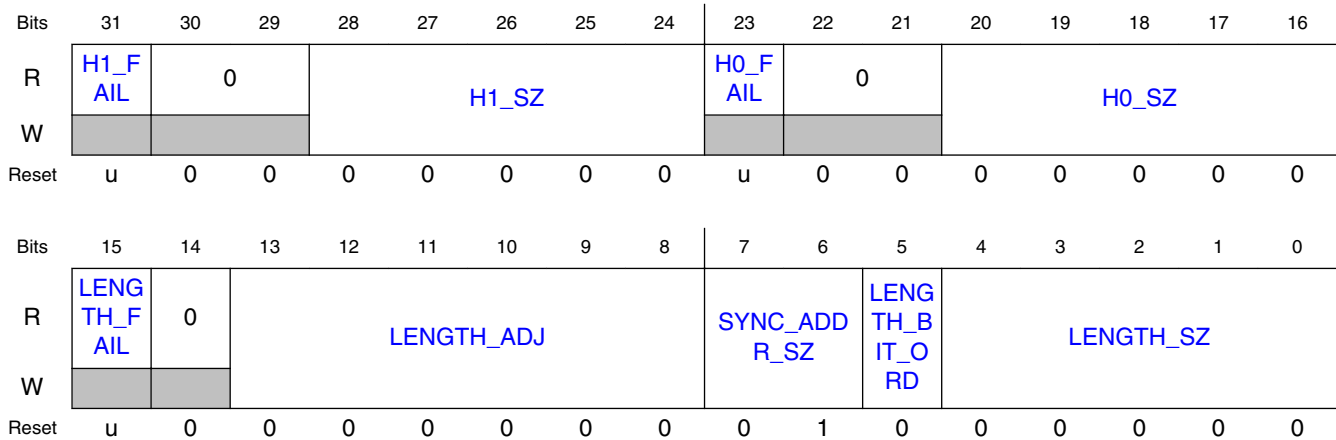

45.6.3.2.2.20.3 Fields

| Field | Function |
|---------------------|--|
| 31 H1_FAIL | H1 Violated Status Bit For packets received with REC_BAD_PKT=1, H1_FAIL indicates the received H1 header field violates the H1_MASK/H1_MATCH pattern |
| 30-29 — | Reserved. |
| 28-24 H1_SZ | H1 Size Length of H1 in bits; 0 <= H1_SZ <= 16 |
| 23 H0_FAIL | H0 Violated Status Bit For packets received with REC_BAD_PKT=1, H0_FAIL indicates the received H0 header field violates the H0_MASK/H0_MATCH pattern |
| 22-21 — | Reserved. |
| 20-16 H0_SZ | H0 Size Size of H0 in bits; 0 <= H0_SZ <= 16 |
| 15 LENGTH_FAIL | Maximum Length Violated Status Bit For packets received with REC_BAD_PKT=1, LENGTH_FAIL indicates the extracted LENGTH header field exceeded LENGTH_MAX |
| 14 — | Reserved. |
| 13-8 LENGTH_ADJ | Length Adjustment Signed Adjustment to the LENGTH field for TX and RX. A value of 0 (default) means LENGTH is interpreted as PAYLOAD + CRC |
| 7-6 SYNC_ADDR_SZ | Sync Address Size Number of Octets = SYNC_ADDR_SZ + 1, 0 <= SYNC_ADDR_SZ <= 3. |

Table continues on the next page...

Link Layer

| Field | Function |
|---------------------|--|
| 5 LENGTH_BIT_ORD | LENGTH Bit Order Bit order for the LENGTH field of the header 0b - LS Bit First 1b - MS Bit First |
| 4-0 LENGTH_SZ | LENGTH Size Size of LENGTH field of the header, in bits; 0 <= LENGTH_SZ <= 16 |

45.6.3.2.2.21 H0 CONFIGURATION (H0_CFG)

45.6.3.2.2.21.1 Address

| Register | Offset |
|----------|-----------|
| H0_CFG | 4005F064h |

45.6.3.2.2.21.2 Diagram

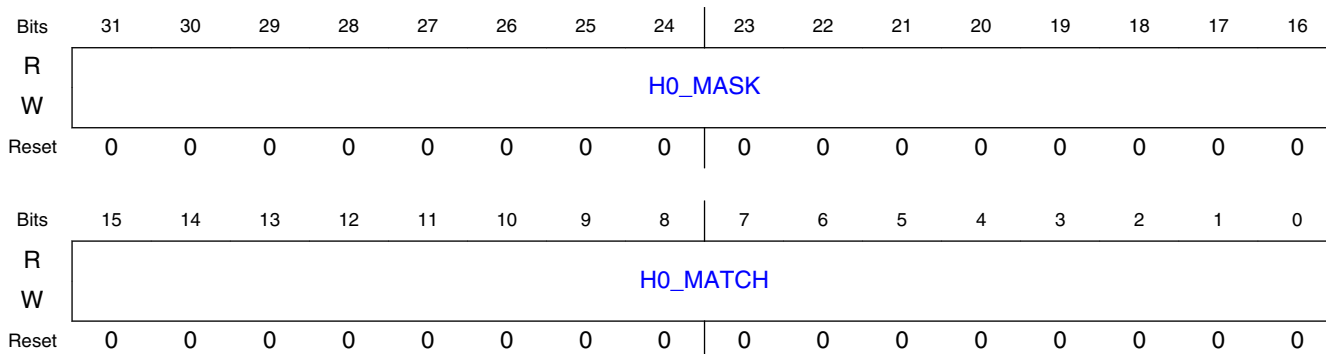

45.6.3.2.2.21.3 Fields

| Field | Function |
|------------------|--|
| 31-16 H0_MASK | H0 Mask Register For each bit that is set to 1, the received H0 field must match the corresponding bit of H0_MATCH[15:0], else the received packet is rejected. |
| 15-0 H0_MATCH | H0 Match Register For each bit of H0_MASK[15:0] that is set to 1, the received H0 field must match this register, else the received packet is rejected. |

45.6.3.2.2.22 H1 CONFIGURATION (H1_CFG)

45.6.3.2.2.22.1 Address

| Register | Offset |
|----------|-----------|
| H1_CFG | 4005F068h |

45.6.3.2.2.22.2 Diagram

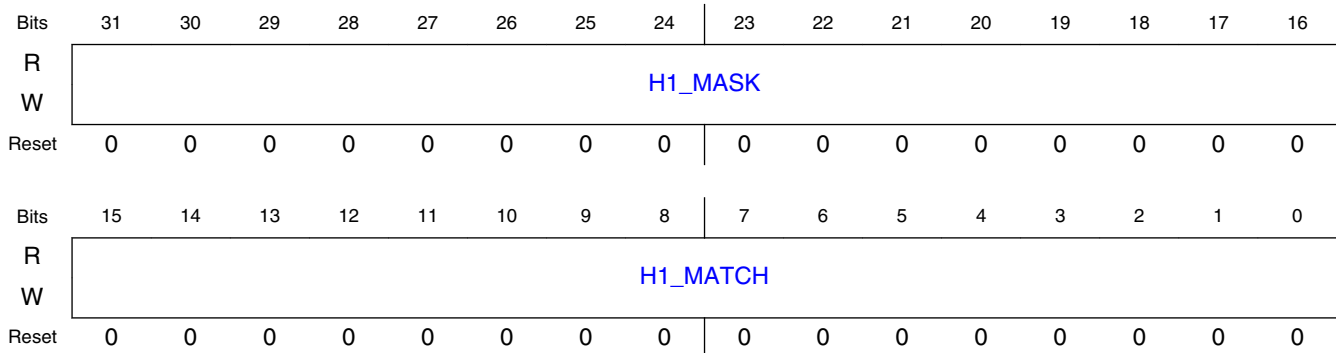

45.6.3.2.2.22.3 Fields

| Field | Function |
|------------------|--|
| 31-16 H1_MASK | H1 Mask Register For each bit that is set to 1, the received H1 field must match the corresponding bit of H1_MATCH[15:0], else the received packet is rejected. |
| 15-0 H1_MATCH | H1 Match Register For each bit of H1_MASK[15:0] that is set to 1, the received H1 field must match this register, else the received packet is rejected. |

45.6.3.2.2.23 CRC CONFIGURATION (CRC_CFG)

45.6.3.2.2.23.1 Address

| Register | Offset |
|----------|-----------|
| CRC_CFG | 4005F06Ch |

Link Layer

45.6.3.2.2.23.2 Diagram

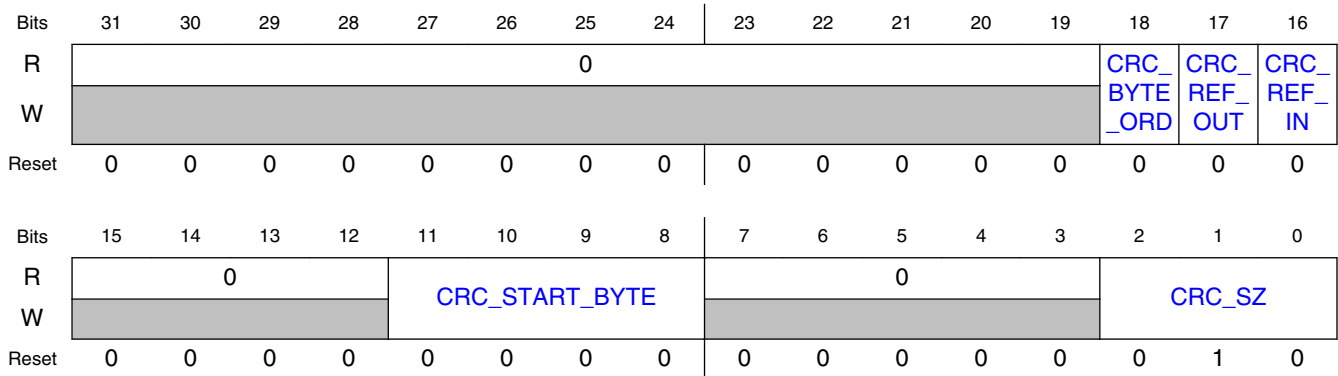

45.6.3.2.2.23.3 Fields

| Field | Function |
|------------------------|--|
| 31-19 — | Reserved. |
| 18 CRC_BYTE_ORD | CRC Byte Order 0b - LS Byte First 1b - MS Byte First |
| 17 CRC_REF_OUT | CRC Reflect Out 0b - do not manipulate CRC result 1b - CRC result is to be reflected bitwise (operated on entire word) |
| 16 CRC_REF_IN | CRC Reflect In 0b - do not manipulate input data stream 1b - reflect each byte in the input stream bitwise |
| 15-12 — | Reserved. |
| 11-8 CRC_START_BYTE | Configure CRC Start Point Start CRC with this byte position. Byte #0 is the first byte of Sync Address |
| 7-3 — | Reserved. |
| 2-0 CRC_SZ | CRC Size (in octets) Number of CRC Octets = CRC_SZ, 0 <= CRC_SZ <= 4. |

45.6.3.2.2.24 CRC INITIALIZATION (CRC_INIT)

45.6.3.2.2.24.1 Address

| Register | Offset |
|----------|-----------|
| CRC_INIT | 4005F070h |

45.6.3.2.2.24.2 Diagram

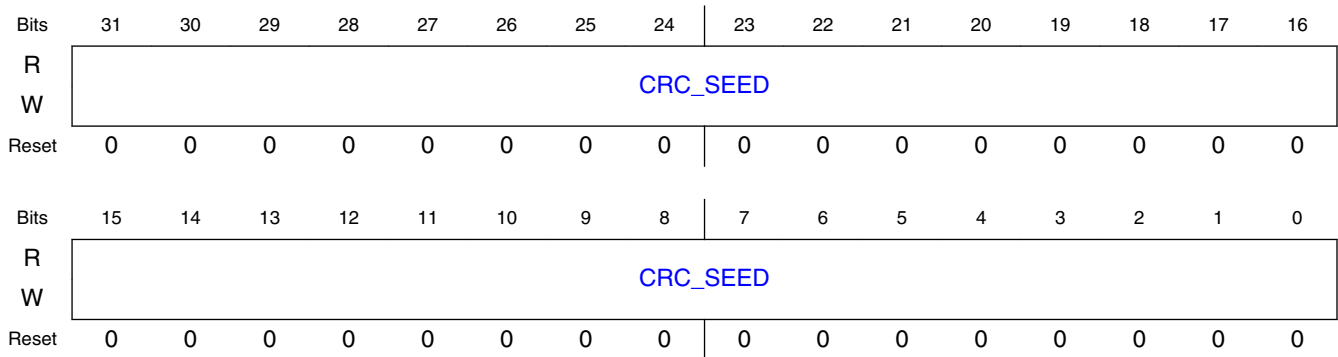

45.6.3.2.2.24.3 Fields

| Field | Function |
|----------|----------------------------|
| 31-0 | CRC Seed Value |
| CRC_SEED | Initial Value for CRC LFSR |

45.6.3.2.2.25 CRC POLYNOMIAL (CRC_POLY)

45.6.3.2.2.25.1 Address

| Register | Offset |
|----------|-----------|
| CRC_POLY | 4005F074h |

Link Layer

45.6.3.2.2.25.2 Diagram

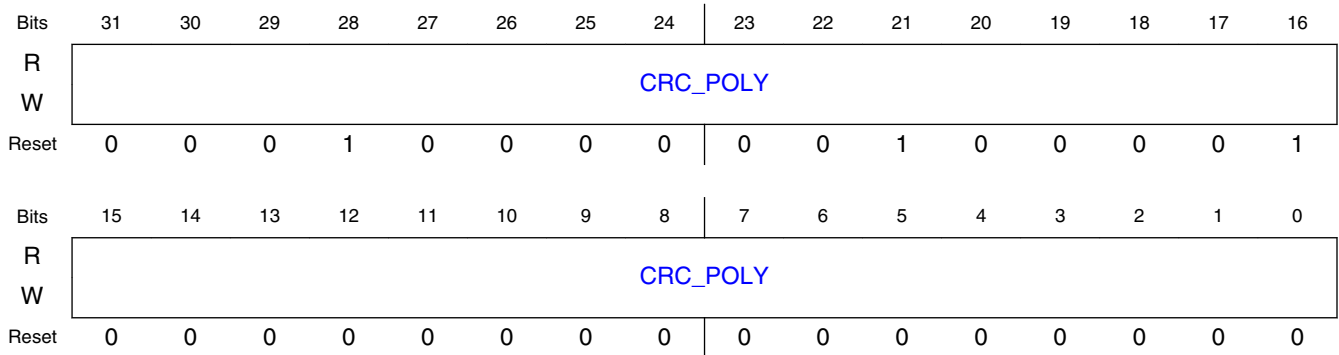

45.6.3.2.2.25.3 Fields

| Field | Function |
|------------------|-----------------|
| 31-0 CRC_POLY | CRC Polynomial. |

45.6.3.2.2.26 CRC XOR OUT (CRC_XOR_OUT)

45.6.3.2.2.26.1 Address

| Register | Offset |
|-------------|-----------|
| CRC_XOR_OUT | 4005F078h |

45.6.3.2.2.26.2 Diagram

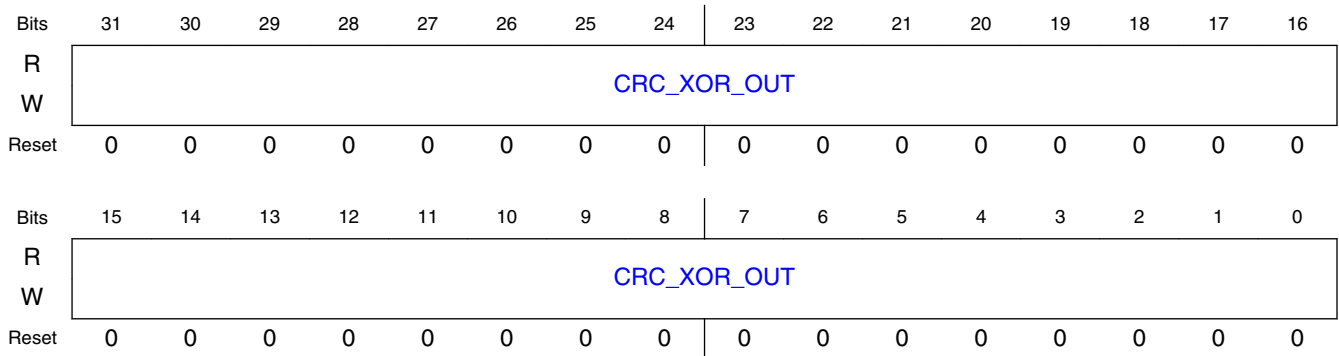

45.6.3.2.2.26.3 Fields

| Field | Function |
|-------------|--|
| 31-0 | CRC XOR OUT Register |
| CRC_XOR_OUT | XOR mask for CRC result (for no mask, should be 0) |

45.6.3.2.2.27 WHITENER CONFIGURATION (WHITEN_CFG)

45.6.3.2.2.27.1 Address

| Register | Offset |
|------------|-----------|
| WHITEN_CFG | 4005F07Ch |

45.6.3.2.2.27.2 Diagram

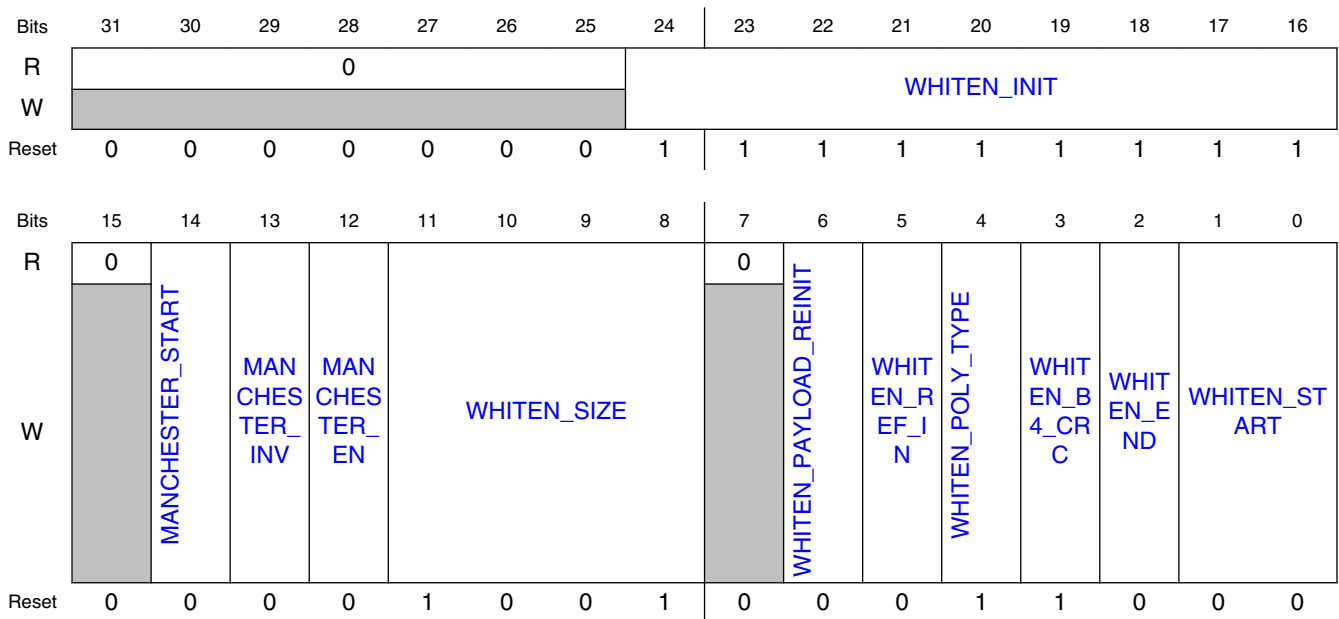

45.6.3.2.2.27.3 Fields

| Field | Function |
|-------|---|
| 31-25 | Reserved. |
| — | |
| 24-16 | Initialization Value for Whitening/De-whitening |

Table continues on the next page...

Link Layer

| Field | Function |
|--------------------------------|--|
| WHITEN_INIT | |
| 15 — | Reserved. |
| 14 MANCHESTER _START | Configure Manchester Encoding Start Point 0b - Start Manchester coding at start-of-payload 1b - Start Manchester coding at start-of-header |
| 13 MANCHESTER _INV | Configure for Inverted Manchester Encoding 0b - Manchester coding as per 802.3 1b - Manchester coding as per 802.3 but with the encoding signal inverted |
| 12 MANCHESTER _EN | Configure for Manchester Encoding/Decoding 0b - Disable Manchester encoding (TX) and decoding (RX) 1b - Enable Manchester encoding (TX) and decoding (RX) |
| 11-8 WHITEN_SIZE | Length of Whitener LFSR |
| 7 — | Reserved. |
| 6 WHITEN_PAYL OAD_REINIT | Configure for Whitener re-initialization 0b - Don't re-initialize Whitener LFSR at start-of-payload 1b - Re-initialize Whitener LFSR at start-of-payload |
| 5 WHITEN_REF_I N | Whiten Reflect Input The input data stream is reflected, bit-wise, per byte, if this register bit is asserted. Bit 7 becomes bit 0, bit 6 becomes bit 1, etc. This register bit will only cause the reflection of the payload data bits as they are used in the whiten calculation and will not cause any change in the output bit order. |
| 4 WHITEN_POLY _TYPE | Whiten Polynomial Type A Fibonacci type LFSR is used with the whiten polynomial if this register bit is asserted. Otherwise, a Galois type LFSR is used. |
| 3 WHITEN_B4_C RC | Configure for Whitening-before-CRC Sets the order of Bit Stream Processing for TX and RX. 0b - CRC before whiten/de-whiten 1b - Whiten/de-whiten before CRC |
| 2 WHITEN_END | Configure end-of-whitening 0b - end whiten at end-of-payload 1b - end whiten at end-of-crc |
| 1-0 WHITEN_STAR T | Configure Whitener Start Point 00b - no whitening 01b - start whitening at start-of-H0 10b - start whitening at start-of-H1 but only if LENGTH > WHITEN_SZ_THR 11b - start whitening at start-of-payload but only if LENGTH > WHITEN_SZ_THR |

45.6.3.2.2.28 WHITENER POLYNOMIAL (WHITEN_POLY)

45.6.3.2.2.28.1 Address

| Register | Offset |
|-------------|-----------|
| WHITEN_POLY | 4005F080h |

45.6.3.2.2.28.2 Diagram

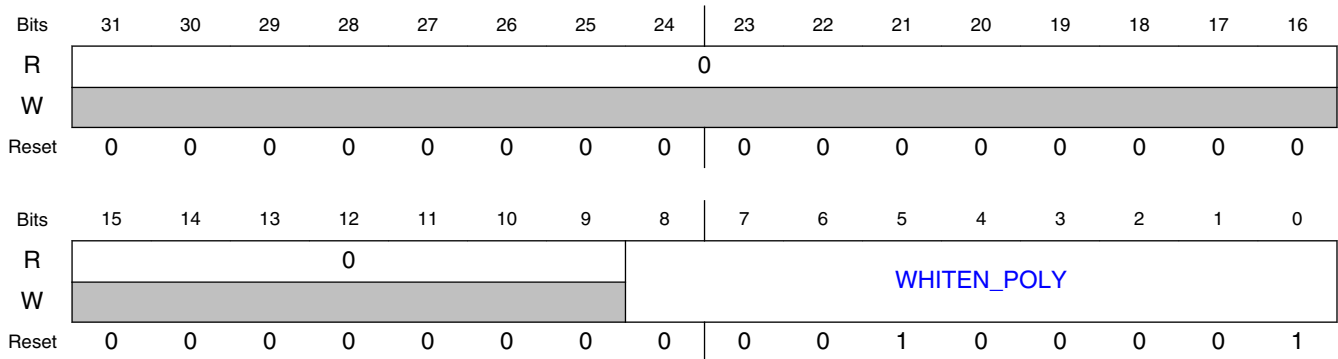

45.6.3.2.2.28.3 Fields

| Field | Function |
|--------------------|--|
| 31-9 Reserved | Reserved. |
| 8-0 WHITEN_POLY | Whitener Polynomial The 9-bit polynomial used in the whiten calculation. The polynomial value must be right-justified if smaller than 9-bits. |

45.6.3.2.2.29 WHITENER SIZE THRESHOLD (WHITEN_SZ_THR)

45.6.3.2.2.29.1 Address

| Register | Offset |
|---------------|-----------|
| WHITEN_SZ_THR | 4005F084h |

Link Layer

45.6.3.2.2.29.2 Diagram

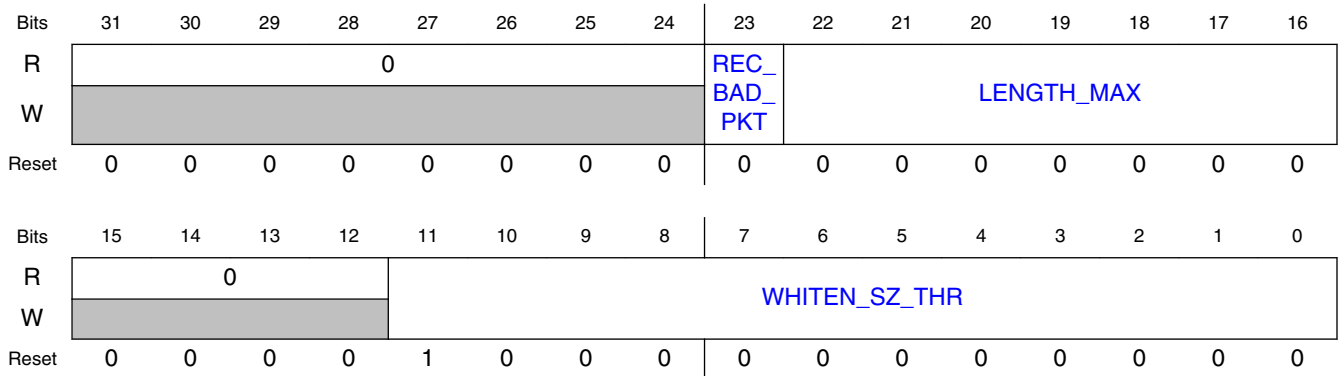

45.6.3.2.2.29.3 Fields

| Field | Function |
|---------------------------|--|
| 31-24 — | Reserved. |
| 23 REC_BAD_PKT | Receive Bad Packets Enable Packets which fail H0-filtering, H1-filtering, or Maximum Length-filtering, to be fully received without an RX recycle (intended for debug purposes) 0b - packets which fail H0, H1, or LENGTH_MAX result in an automatic recycle after the header is received and parsed 1b - packets which fail H0, H1, or LENGTH_MAX are received in their entirety |
| 22-16 LENGTH_MAX | Maximum Length for Received Packets Sets the Maximum Length Packet that can be received, in multiples of 16 bytes. LENGTH_MAX is compared directly against the extracted LENGTH field of the header (not the adjusted length). LENGTH_MAX=0 (default) is a special case that implies no limit. |
| 15-12 — | Reserved. |
| 11-0 WHITEN_SZ_T HR | Whitener Size Threshold Minimum Packet Length (extracted LENGTH field) required to enable whiten. Requires WHITEN_START=2 or 3 |

45.6.3.2.2.30 BIT RATE (BITRATE)

45.6.3.2.2.30.1 Address

| Register | Offset |
|----------|-----------|
| BITRATE | 4005F088h |

45.6.3.2.2.30.2 Diagram

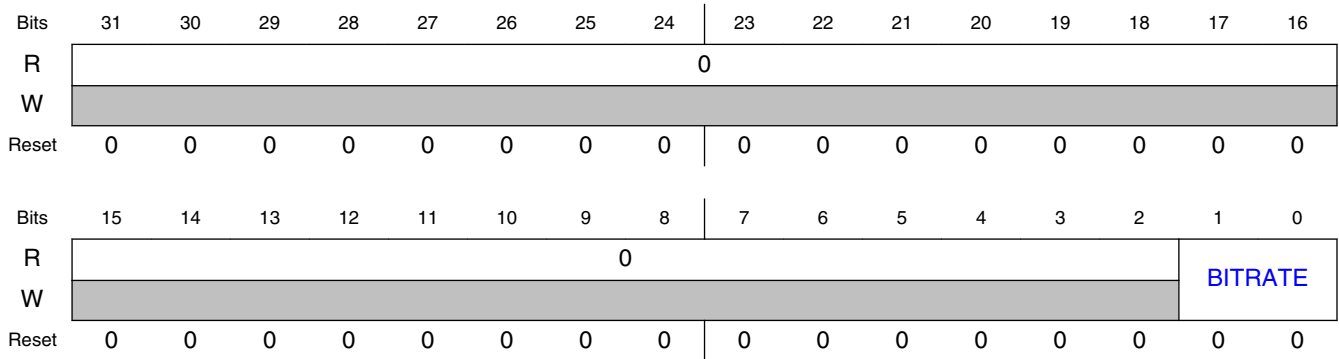

45.6.3.2.2.30.3 Fields

| Field | Function |
|------------------|--|
| 31-2 Reserved | Reserved. |
| 1-0 BITRATE | Bit Rate 00b - 1Mbit/sec 01b - 500Kbit/sec 10b - 250Kbit/sec (not supported if WHITEN_CFG[MANCHESTER_EN]=1) 11b - Reserved |

45.6.3.2.2.31 PACKET BUFFER PARTITION POINT (PB_PARTITION)

45.6.3.2.2.31.1 Address

| Register | Offset |
|--------------|-----------|
| PB_PARTITION | 4005F08Ch |

45.6.3.2.2.31.2 Diagram

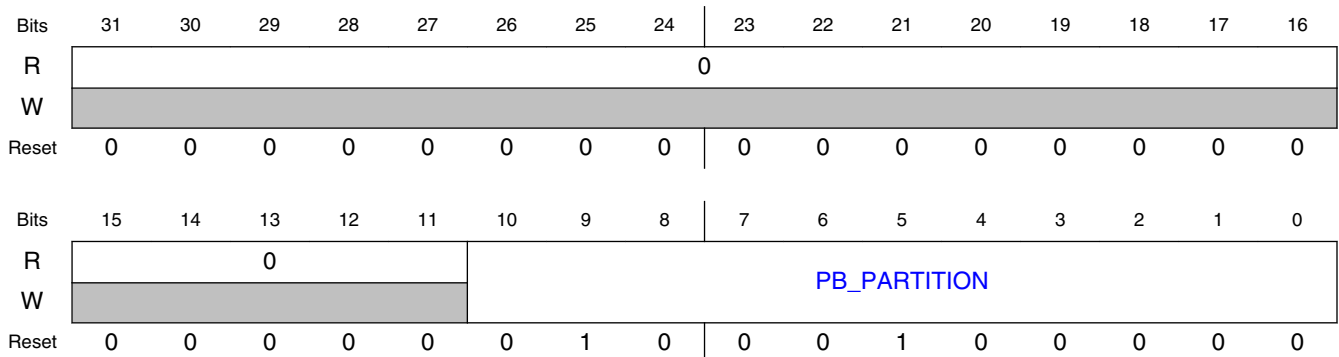

45.6.3.2.2.31.3 Fields

| Field | Function |
|----------------------|---|
| 31-11 Reserved | Reserved. |
| 10-0 PB_PARTITION | Packet Buffer Partition Point The Packet Buffer Partition Point defines the starting point for the RX segment of the Packet Buffer. The partitioning of the consolidated RAM between TX and RX is controlled by this configurable TX/RX Partition Point. PB_PARTITION can be programmed with any value between 0 (base of RAM0) and 1088 (after the last address of RAM1). The consolidated RAM is partitioned such that the TX buffer resides before the Partition Point (RAM entries 0 to (PB_PARTITION-1)), and the RX buffer resides after it (RAM entries PB_PARTITION to 1087). Programming the Partition Point register to 0 dedicates the entire consolidated RAM to RX; programming the Partition Point register to 1088 dedicates the entire consolidated RAM to TX; programming the Partition Point register to any value between 1 and 1087 yields a split TX/RX buffer. The TX segment (if any) is always first in the Packet Buffer, starting at Packet RAM address 0 of RAM0. Since the Packet Buffer RAM word-width is 2 bytes, the units for PB_PARTITION is "words". (Multiply by 2 to convert to byte addressing) |

45.6.3.2.2.32 PACKET BUFFER (PACKET_BUFFER_a)

45.6.3.2.2.32.1 Address

For a = 0 to 1087:

| Register | Offset |
|-----------------|----------------------|
| PACKET_BUFFER_a | 4005F700h + (a × 2h) |

45.6.3.2.2.32.2 Diagram

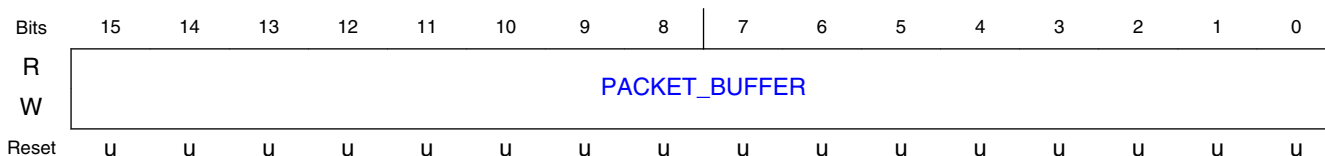

45.6.3.2.2.32.3 Fields

| Field | Function |
|-----------------------|---|
| 15-0 PACKET_BUFFER | PACKET BUFFER RAM Storage for packet data. |

45.6.3.2.3 Register Summary

45.6.3.2.4 Register Descriptions

| Field | R/W | Description |
|--------------------|-----|---|
| SEQCMD[3:0] | w | Sequence Command Register. See Section Sequence Commands and Status for details |
| SEQSTS[12:0] | r | Sequence Status Register. See Section Sequence Commands and Status for details |
| CMDDEC_CS[2:0] | r | Current State of the Command Decoder FSM (debug only) |
| TX_WHITEN_DIS | rw | Disable all whitening on TX packets |
| RX_DEWHITEN_DIS | rw | Disable all de-whitening on RX packets |
| SW_CRC_EN | rw | SW override of the HW-computed CRC for TX. SW must include CRC in the Packet Buffer TX buffer |
| CRC_VALID | r | CRC Valid indicator for RX packets. 1: good CRC 0: bad CRC |
| TX_WARMUP[7:0] | r | TX warmup time, in microseconds, provided to LL SW |
| RX_WARMUP[7:0] | r | RX warmup time, in microseconds, provided to LL SW |
| CHANNEL_NUM[6:0] | rw | RF Channel Select: $0 \leq \text{CHANNEL_NUM} \leq 127$; Formula: $F = (2360 + \text{CHANNEL_NUM})$ [in MHz] |
| TX_POWER[5:0] | rw | PA Power Level. Refer Data Sheet for mapping to dBm. |
| RSSI[7:0] | r | Received Signal Strength Indicator, signed value |
| LQI[7:0] | r | Link Quality Indicator, signed value |
| PREAMBLE_SZ[2:0] | rw | Number of Octets = PREAMBLE_SZ + 1, where $0 \leq \text{PREAMBLE_SZ} \leq 7$ |
| BYTE_COUNTER[12:0] | r | Signed value, reflects the current Byte Count, for TX and RX. < 0: Preamble byte(s), TX only 0: First Byte of Network Address; 1: Second Byte of Network Address |

Table continues on the next page...

Link Layer

| Field | R/W | Description |
|------------------|---------------|---|
| | | ... |
| XCVR_BUSY | r | For multi-protocol arbitration, XCVR_BUSY=1 indicates an RF channel access is underway (TSM is busy) |
| EVENT_TMR[23:0] | r +load + add | Event Timer can be read in these byte locations. To update the Event Timer, either: <ol style="list-style-type: none"> 1. Write the desired EVENT_TMR to these bytes and set EVENT_TMR_LD=1, or, 2. Write the desired EVENT_TMR <i>increment</i> amount to these bytes and set EVENT_TMR_ADD=1 Note for EVENT_TMR_ADD, EVENT_TMR[23:0] is a signed value. |
| EVENT_TMR_LD | w | A write access with this bit sets loads EVENT_TMR with the contents of EVENT_TMR[23:0] |
| EVENT_TMR_ADD | w | A write access with this bit sets increments EVENT_TMR by the contents of EVENT_TMR[23:0]. This is a signed addition. |
| TIMESTAMP[23:0] | r | Received Packet Timestamp, Captured from EVENT_TMR at NTW_ADR_IRQ. |
| T1_CMP[23:0] | rw | Timer1 (T1) Compare Value. Can be used to generate T1_IRQ and/or launch Sequence Commands |
| T2_CMP[23:0] | rw | Timer2 (T2) Compare Value. Can be used to generate T2_IRQ and/or launch Sequence Commands |
| T1_CMP_EN | rw | Enable Timer Compare #1 (T1_CMP) to generate T1_IRQ and/or launch Sequence Commands |
| T2_CMP_EN | rw | Enable Timer Compare #2 (T2_CMP) to generate T2_IRQ and/or launch Sequence Commands |
| NTW_ADR_MCH[3:0] | r | Indicates which of the 4 Network Addresses has matched in the PHY. Valid during a RX sequence at the point of match, and remains valid until either: <ol style="list-style-type: none"> 1. The next RX sequence begins (if the current packet passed CRC and header filtering), or, 2. An RX recycle to Network Address search (if the current packet failed CRC or header filtering) |
| NTW_ADR0[31:0] | rw | Network Address 0, to PHY for correlation |

Table continues on the next page...

| Field | R/W | Description |
|-------------------|-----|---|
| NTW_ADR1[31:0] | rw | Network Address 1, to PHY for correlation |
| NTW_ADR2[31:0] | rw | Network Address 2, to PHY for correlation |
| NTW_ADR3[31:0] | rw | Network Address 3, to PHY for correlation |
| NTW_ADR_EN[3:0] | rw | Enable Network Address N for PHY correlation, where $0 \leq N \leq 3$. Any bit combination can be set. |
| NTW_ADR0_SZ[1:0] | rw | 3: Network Address 0 requires a 32-bit correlation 2: Network Address 0 requires a 24-bit correlation 1: Network Address 0 requires a 16-bit correlation 0: Network Address 0 requires a 8-bit correlation |
| NTW_ADR1_SZ[1:0] | rw | 3: Network Address 1 requires a 32-bit correlation 2: Network Address 1 requires a 24-bit correlation 1: Network Address 1 requires a 16-bit correlation 0: Network Address 1 requires a 8-bit correlation |
| NTW_ADR2_SZ[1:0] | rw | 3: Network Address 2 requires a 32-bit correlation 2: Network Address 2 requires a 24-bit correlation 1: Network Address 2 requires a 16-bit correlation 0: Network Address 2 requires a 8-bit correlation |
| NTW_ADR3_SZ[1:0] | rw | 3: Network Address 3 requires a 32-bit correlation 2: Network Address 3 requires a 24-bit correlation 1: Network Address 3 requires a 16-bit correlation 0: Network Address 3 requires a 8-bit correlation |
| NTW_ADR_THR0[2:0] | rw | Number of Tolerated bit errors for Network Address 0 |
| NTW_ADR_THR1[2:0] | rw | Number of Tolerated bit errors for Network Address 1 |
| NTW_ADR_THR2[2:0] | rw | Number of Tolerated bit errors for Network Address 2 |

Table continues on the next page...

Link Layer

| Field | R/W | Description |
|---------------------|----------|--|
| NTW_ADR_THR3[2:0] | rw | Number of Tolerated bit errors for Network Address 3 |
| RX_WATERMARK_IRQ | r / w1tc | Asserts when Byte Counter == RX_WATERMARK[12:0] |
| NTW_ADR_IRQ | r / w1tc | Network Address Match Interrupt. A NA Match has occurred |
| TX_IRQ | r / w1tc | TX Interrupt. The TX sequence has completed with a successful packet transmission. |
| RX_IRQ | r / w1tc | RX Interrupt. The RX sequence has completed with a successful packet reception. |
| PLL_UNLOCK_IRQ | r / w1tc | PLL Unlock Interrupt. An unlock event has occurred. |
| SEQ_END_IRQ | r / w1tc | Sequence End Interrupt. Will assert when any TX or RX sequence ends for any reason. |
| T1_IRQ | r / w1tc | Timer Compare #1 (T1) Interrupt |
| T2_IRQ | r / w1tc | Timer Compare #2 (T2) Interrupt |
| WAKE_IRQ | r / w1tc | Wake Interrupt. The DSM_TIMER has matched GEN_WAKE and DSM has exited. The GENERIC_FSK EVENT_TMR has resumed counting. |
| TSM_IRQ | r | TSM Interrupt. Indicates TSM0_IRQ or TSM1_IRQ is set in XCVR_STATUS. For debug purposes. |
| RX_WATERMARK_IRQ_EN | rw | Enable for RX_WATERMARK_IRQ |
| NTW_ADR_IRQ_EN | rw | Enable for NTW_ADR_IRQ |
| TX_IRQ_EN | rw | Enable for TX_IRQ |
| RX_IRQ_EN | rw | Enable for RX_IRQ |
| PLL_UNLOCK_IRQ_EN | rw | Enable for PLL_UNLOCK_IRQ |
| SEQ_END_IRQ_EN | rw | Enable for SEQ_END_IRQ |
| T1_IRQ_EN | rw | Enable for T1_IRQ |
| T2_IRQ_EN | rw | Enable for T2_IRQ |
| WAKE_IRQ_EN | rw | Enable for WAKE_IRQ |
| TSM_IRQ_EN | rw | Enable for TSM_IRQ |
| GENERIC_FSK_IRQ_EN | rw | Master enable for the GENERIC_FSK_IRQ interrupt line to the MCU. |
| CRC_IGNORE | rw | If set, assert RX_IRQ even for a received packet which fails CRC verification, and do not recycle. |
| RX_WATERMARK[12:0] | rw | Sets the trigger for RX_WATERMARK_IRQ. Trigger the RX_WATERMARK_IRQ when: |

Table continues on the next page...

| Field | R/W | Description |
|----------------------|-----|--|
| | | RX Byte Counter == RX_WATERMARK[12:0] |
| GEN_SLEEP[23:0] | rw | If GENERIC_FSK_SLEEP_EN=1, enter DSM & freeze EVENT_TMR when GEN_SLEEP matches DSM_TIMER. NOTE: This register resides in RSIM Address Space |
| DSM_OSC_OFFSET[9:0] | rw | Awaken SoC, start the RF Oscillator when: $(GEN_WAKE - DSM_OSC_OFFSET) = DSM_TIMER$ NOTE: This register resides in RSIM Address Space |
| GEN_WAKE[23:0] | rw | Exit Deep Sleep Mode, and resume EVENT_TMR, when GEN_WAKE matches DSM_TIMER NOTE: This register resides in RSIM Address Space |
| GENERIC_FSK_SLEEP_EN | w | Enable a match on GENERIC_FSK_SLEEP[23:0] to DSM_TIMER[23:0], to enter Deep Sleep Mode |
| DSM_TIMER[23:0] | r | Current State of the 32 KHz Sleep Timer NOTE: This register resides in RSIM Address Space |
| PART_ID[7:0] | r | Part ID to identify HW revision |
| SYNC_ADDR_SZ[1:0] | rw | Number of Octets = SYNC_ADDR_SZ + 1, $0 \leq SYNC_ADDR_SZ \leq 3$. Applies to TX only. |
| H0_SZ[4:0] | rw | Size of H0 in bits; $0 \leq H0_SZ \leq 16$ |
| H0_MASK[15:0] | rw | For each bit that is set to 1, the received H0 field must match the corresponding bit of H0_MATCH[15:0], else the received packet is rejected. |
| H0_MATCH[15:0] | rw | For each bit of H0_MASK[15:0] that is set to 1, the received H0 field must match this register, else the received packet is rejected. |
| LENGTH_SZ[4:0] | rw | Size of Packet Length in bits; $0 \leq LENGTH_SZ \leq 16$ |
| LENGTH_BIT_ORD | rw | Bit order for the LENGTH field 0: LS Bit First; 1: MS Bit First |
| LENGTH_ADJ[5:0] | rw | Signed Adjustment to the LENGTH field for TX and RX. A value of 0 (default) means LENGTH is interpreted as PAYLOAD + CRC |

Table continues on the next page...

Link Layer

| Field | R/W | Description |
|---------------------|-----|--|
| LENGTH_MAX[6:0] | rw | Sets the Maximum Length Packet that can be received, in multiples of 16 bytes. LENGTH_MAX is compared directly against the extracted LENGTH field of the header (not the adjusted length). LENGTH_MAX=0 (default) is a special case that implies no limit. |
| REC_BAD_PKT | rw | 1: packets which fail H0, H1, or LENGTH_MAX are received in their entirety 0: packets which fail H0, H1, or LENGTH_MAX result in a recycle after the header is fully received |
| LENGTH_FAIL | r | For packets received with REC_BAD_PKT=1, LENGTH_FAIL indicates the extracted LENGTH header field exceeded LENGTH_MAX |
| H0_FAIL | r | For packets received with REC_BAD_PKT=1, H0_FAIL indicates the received H0 header field violates the H0_MASK/H0_MATCH pattern |
| H1_FAIL | r | For packets received with REC_BAD_PKT=1, H1_FAIL indicates the received H1 header field violates the H1_MASK/H1_MATCH pattern |
| H1_SZ[4:0] | rw | Length of H1 in bits; 0 <= H1_SZ <= 16 |
| H1_MASK[15:0] | rw | For each bit that is set to 1, the received H1 field must match the corresponding bit of H1_MATCH[15:0], else the received packet is rejected. |
| H1_MATCH[15:0] | rw | For each bit of H1_MASK[15:0] that is set to 1, the received H1 field must match this register, else the received packet is rejected. |
| CRC_SZ[2:0] | rw | Number of CRC Octets = CRC_SZ, 0 <= CRC_SZ <= 4. |
| CRC_POLY[31:0] | rw | CRC Polynomial. 1: XOR exists in the bit's feedback path; 0: no XOR in the bit's feedback path |
| CRC_SEED[31:0] | rw | CRC Seed Value |
| CRC_START_BYTE[3:0] | rw | Start CRC with this byte position. Byte #0 is the first byte of Sync Address |
| CRC_BYTE_ORD | rw | 0: LS Byte First 1: MS Byte First |
| CRC_REF_IN | rw | 0: do not manipulate input data stream; 1: reflect each byte in the input stream bitwise |
| CRC_REF_OUT | rw | 0: do not manipulate CRC result; |

Table continues on the next page...

| Field | R/W | Description |
|-----------------------|-----|---|
| | | 1: CRC result is to be reflected bitwise (operated on entire word) |
| CRC_XOR_OUT[31:0] | rw | XOR mask for CRC result (for no mask, should be 0) |
| WHITEN_B4_CRC | rw | Order of Bit Stream Processing for TX and RX: 1: Whiten/de-whiten before CRC 0: CRC before whiten/de-whiten |
| WHITEN_SEED[8:0] | rw | Initialization Value for Whitening/De-whitening |
| WHITEN_POLY[8:0] | rw | Polynomial Value for Whitening/De-whitening |
| WHITEN_POLY_TYPE | rw | Whiten polynomial type. A Fibonacci type LFSR is used with the whiten polynomial if this bit is asserted. Otherwise, a Galois type LFSR is used. |
| WHITEN_SIZE[3:0] | rw | Whitener Length |
| WHITEN_REF_IN | rw | The input data stream is reflected, bit-wise, per byte, if this bit is asserted. Bit 7 becomes bit 0, bit 6 becomes bit 1, etc. This bit will only cause the reflection of the payload data bits as they are used in the whiten calculation and will not cause any change in the output bit order |
| WHITEN_START[1:0] | rw | 0: no whiten; 1: start whiten @ start-of-H0; 2: start whiten @ start-of-H1 but only if LENGTH > WHITEN_SZ_THR 3: start whiten @ start-of-payload but only if LENGTH > WHITEN_SZ_THR |
| WHITEN_END | rw | 0: end whiten at end-of-payload 1: end whiten at end-of-crc |
| WHITEN_PAYLOAD_REINIT | rw | 1: re-assert whiten_init at start-of-payload 0 = don't re-assert whiten_init |
| WHITEN_SZ_THR[11:0] | rw | Minimum Packet Length (extracted LENGTH field) required to enable whiten. Requires WHITEN_START=2 or 3 |
| BITRATE[1:0] | rw | 0: 1 Mbs 1: 500 Kbs 2: 250 Kbs |
| MANCHESTER_EN | rw | 1: Enable Manchester encoding (TX) and decoding (RX) 0: Disable Manchester Encoding and Decoding |
| MANCHESTER_INV | rw | 0: Manchester coding as per 802.3 |

Table continues on the next page...

Link Layer

| Field | R/W | Description |
|------------------|-----|---|
| | | 1: Manchester coding as per 802.3 but with the encoding signal inverted |
| MANCHESTER_START | rw | 0: Start Manchester coding @ start-of-payload 1: Start Manchester coding @ start-of-header |

45.6.3.3 Functional Description

45.6.3.3.1 Packet Configuration

The Generic FSK Link Layer Controller provides the capability to configure the over-the-air packet structure by way of a set of programmable registers. The Generic FSK packet has a consistent structure, which consists of various elements which are transmitted and received in fixed order. Most of the packet elements have associated configurability, which allows software to pre-configure, for example, the size of the element (in number of bits, or octets), or bit ordering of the element. Other configuration options apply to the entire packet, such as bitrate. In addition, the generic structure defines a variable-length header, for which some (optional) primitive parsing is provided, allowing hardware to differentiate packets based on header-bit settings, into compliant and non-compliant packets. Data Indication is provided on compliant packets only. Non-compliant packets are discarded. For transmitting and receiving, 3 bitrate options are provided. By default, all packet elements are transmitted and received LSB-first.

The Generic FSK Link Layer Controller supports a packet structure based on the following template:

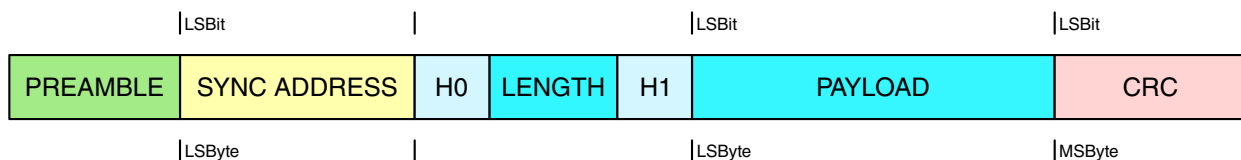

Figure 45-101. GENERIC_FSK Packet Structure

The Generic_FSK Link Layer controller transmits and receives packets which conform to the format shown above. The elements of the packet are transmitted in received in the order shown, although some of the packet elements may be optionally skipped, depending on the configuration options chosen.

The following diagram depicts the register configurability associated with the Preamble, Sync Address, H0, Length, and H1 elements of the packet structure.

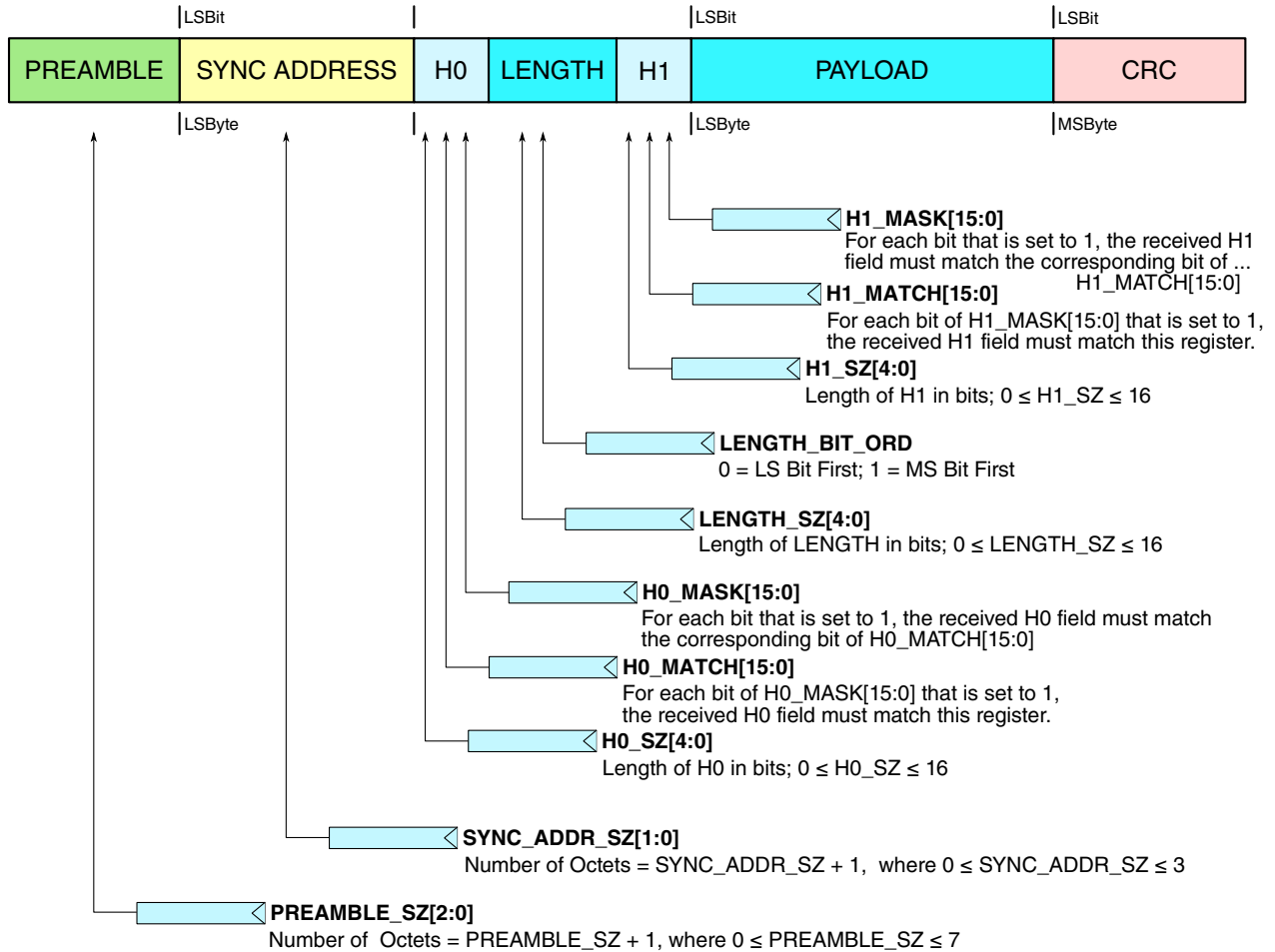

Figure 45-102. Packet Structure Definitions (Part 1)

The following diagram depicts the register configurability associated with the Payload and CRC elements of the packet structure.

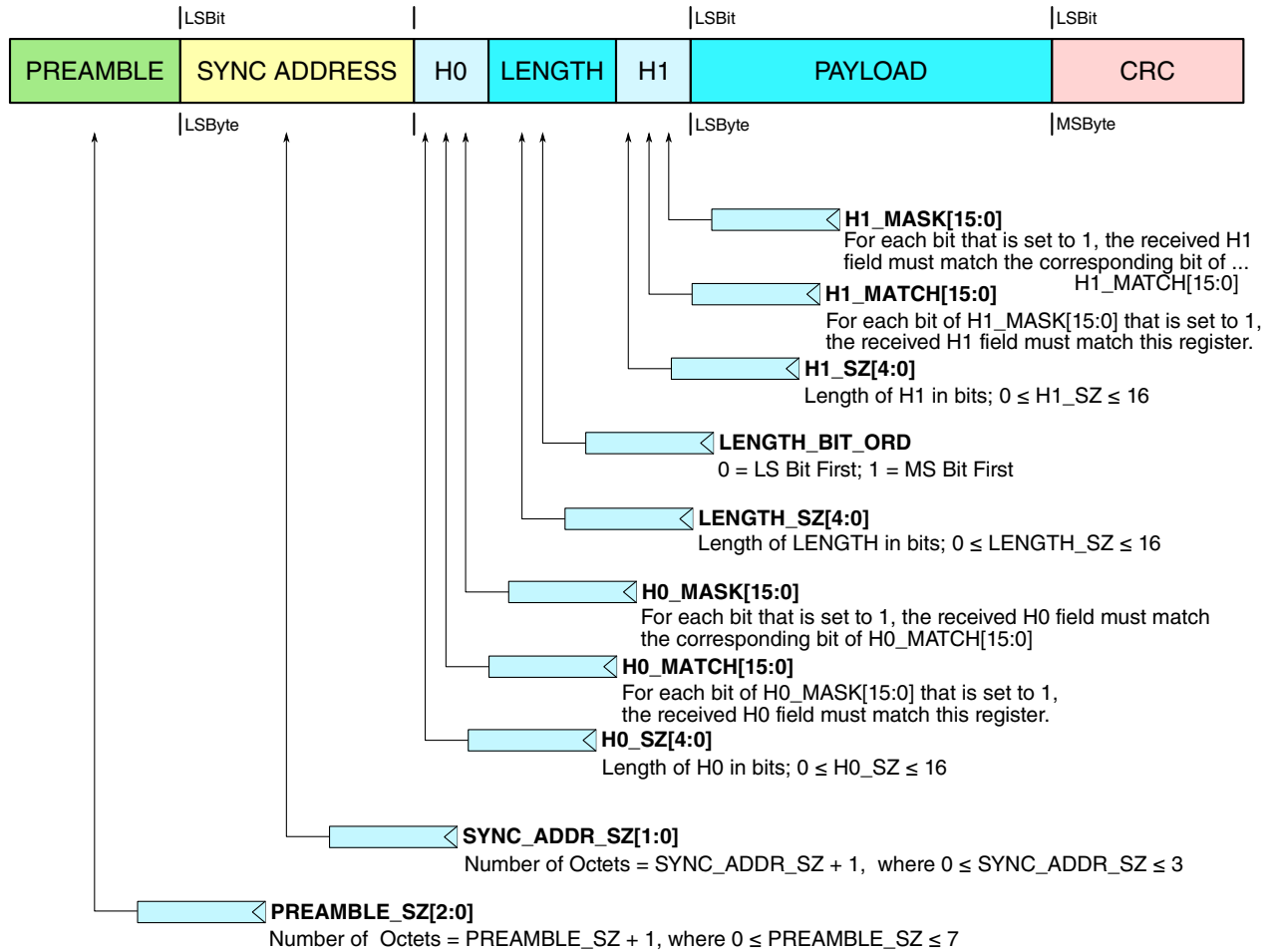

Figure 45-103. Packet Structure Definitions (Part 2)

The following subsections describe each of the packet elements, and the configurability associated with each.

PREAMBLE

The preamble pattern is 0x55 or 0xAA. Like all packet elements, preamble is transmitted LSB first. The Sync Address, which immediately follows the preamble, determines which of the 2 preamble options is selected by hardware: the controller hardware selects the preamble pattern based on the first transmitted bit of Network Address, such that the last bit of preamble is the opposite polarity from the first bit of Network Address, forcing a bit transition at this boundary. The number of octets of preamble is programmable, via the PREAMBLE_SZ[2:0] register, with a range from 1 to 8 octets. A setting of PREAMBLE_SZ=0 yields a single preamble octet, whereas a setting of PREAMBLE_SZ=7 yields 8 octets. For transmission, the Generic FSK

BYTE_COUNTER will be negative during preamble transmission. If `PREAMBLE_SZ=0` (1 preamble octet), `BYTE_COUNTER` will be -1 while the single preamble octet is being transmitted. If `PREAMBLE_SZ=7` (8 octets), `BYTE_COUNTER` will be -8 during the first preamble octet, -7 during the next, and so on and so forth, until the eighth and final octet, during which the `BYTE_COUNTER` will be -1. Unlike most packet elements, the preamble is generated and shifted out by hardware (only preamble and CRC are hardware-generated); there is no software setup required, and preamble does not appear in the Packet Buffer TX buffer. During reception, the Link Layer controller does not receive preamble, since preamble detection is performed by the PHY; preamble does not appear in the Packet Buffer RX buffer.

SYNC (NETWORK) ADDRESS

Sync Address, known synonymously as Network Address or Access Address depending on the protocol in use, is the second packet element transmitted by the Link Layer controller, and the first element received. In a network of associated devices, all devices generally share a common Network Address. The first bit of Network Address determines the preamble selection for transmission, as noted above. For TX, Network Address is the first packet element programmed into the Packet Buffer TX buffer, in LSB-first format. For RX, Network Address is also the first element stored into the Packet Buffer RX buffer, in LSB-first format. The register `NTW_ADRx_SZ[1:0]` determines the length, in octets, of the Network Address field in the packet structure. A setting of `NTW_ADRx_SZ=0` yields a single-octet Network Address, whereas a setting of `NTW_ADRx_SZ=3` yields 4 octets. For reception, up to four unique Network Addresses are supported. Any combination of the 4 can be simultaneously searched for. Network Address correlation is performed in the PHY. Multiple Network Address capability allows `GENERIC_FSK` devices to be associated to more than one network simultaneously, if the network topology supports it; this feature also enables multi-protocol operation. Each of the 4 Network Address options has its own enable bit, `NTW_ADR_EN[x]`; when the enable bit for a Network Address is set to 1, the PHY is instructed to search for that Network Address pattern in the demodulated data, and when the enable bit is set to 0, the PHY will disregard that pattern. Each of the 4 Network Address options has its own `NTW_ADRx_SZ` register, to program its octet size during reception. Additionally, each of the 4 Network Address options has a register, `NTW_ADR_THRx[2:0]`, which determine the number of bit errors that can be tolerated by the PHY during Network Address correlation to the respective Network Address option. Finally, when the PHY detects a match to one of the 4 Network Address options, with a number of bit errors less than or equal to the threshold programmed into `NTW_ADR_THRx`, a read only status bit, `NTW_ADR_MCH[x]` becomes set, indicating which of the 4 patterns matched. After a match has been detected, the PHY shall hold `NTW_ADR_MCH[x]` valid (sticky), until the next receiver warmup, or the next RX recycle. (Specifically, the TSM output `rx_init` clears the `NTW_ADR_MCH[x]` bits; TSM

will assert this signal during either an RX warmup or a recycle). A table listing the registers which apply to Network Address Management, for each of the 4 Network Address options, is shown below.

| NTW_ADR_PATTERN REGISTER | NTW_ADR_ENABLE BIT | NTW_ADR_SIZE REGISTER | NTW_ADR_THRESHOLD REGISTER | NTW_ADR_PATTERN-MATCH STATUS BIT |
|--------------------------|--------------------|-----------------------|----------------------------|----------------------------------|
| NTW_ADR_0[31:0] | NTW_ADR_EN[0] | NTW_ADR0_SZ[1:0] | NTW_ADR_THR0[2:0] | NTW_ADR_MCH[0] |
| NTW_ADR_1[31:0] | NTW_ADR_EN[1] | NTW_ADR1_SZ[1:0] | NTW_ADR_THR1[2:0] | NTW_ADR_MCH[1] |
| NTW_ADR_2[31:0] | NTW_ADR_EN[2] | NTW_ADR2_SZ[1:0] | NTW_ADR_THR2[2:0] | NTW_ADR_MCH[2] |
| NTW_ADR_3[31:0] | NTW_ADR_EN[3] | NTW_ADR3_SZ[1:0] | NTW_ADR_THR3[2:0] | NTW_ADR_MCH[3] |

For Network Addresses of size less than 4 octets, the PHY expects the desired pattern to occupy the least-significant byte positions of the NTW_ADR_x register. Unused byte positions may be filled with any value.

NOTE

When programming the NTW_ADR_x, NTW_ADR_EN[x], NTW_ADRx_SZ, and NTW_ADR_THRx for any RX operation, the following software restrictions apply:

1. All NTW_ADR_x patterns which are enabled by their respective NTW_ADR_EN[x]=1 must be unique (disabled NTW_ADR_x registers need not follow this restriction).
2. Given restriction #1 above, not only must the patterns be unique, but the bit patterns of NTW_ADR_x and NTW_ADR_y must differ by an amount greater than the sum of the bit-error thresholds for each pattern, i.e., NTW_ADR_THRx + NTW_ADR_THRy.
3. Given all combinations of NTW_ADR_x and NTW_ADR_y, where (x != y) and both Network Addresses are enabled by NTW_ADR_EN[x]=NTW_ADR_EN[y]=1, if the sizes of the Network Address patterns differ because NTW_ADRx_SZ != NTW_ADRy_SZ, then the “matching portion” of NTW_ADR_x and NTW_ADR_y, that is, the octets of the pattern which the PHY is instructed to correlate to for each pattern, programmed into the lower byte positions of NTW_ADR_x or NTW_ADR_y for patterns of size less than 4 octets, must be unique.
4. Given restriction #3 above, not only must the “matching portion” of the patterns be unique, but bit patterns of the matching portions of NTW_ADR_x and NTW_ADR_y must differ by greater than the sum of the bit-error thresholds for each pattern, i.e., NTW_ADR_THRx + NTW_ADR_THRy.

These restrictions are designed to preclude multiple, simultaneous pattern matches during a pattern search. Results are indeterminate if the restrictions are violated.

When the PHY detects a pattern match on any enabled `NTW_ADR_x` during reception, and asserts `NTW_ADR_MCH[x]`, the `GENERIC_FSK` Link Layer Controller shall assert `NTW_ADR_IRQ`. The `NTW_ADR_IRQ` is the Link Layer's first indication that a packet is being received. After any `NTW_ADR_IRQ` assertion, a packet will be received and stored into the Packet Buffer RX buffer.

HEADER

The packet header is comprised of `H0`, `LENGTH`, and `H1`, in that order. Each of the 3 fields of the header has programmable length, from 0 to 16 bits. A size of zero for any of the header components infers that that component is skipped in the packet structure. Although the size of the individual `H0`, `LENGTH`, and `H1` components need not be aligned to a byte boundary, the overall header must be byte-aligned. That is, the sum of the sizes (in bits) of `H0`, `LENGTH`, and `H1`, must be a integer multiple of 8 bits. This is a software restriction, a violation of which may result in indeterminate behavior.

For `GENERIC_FSK` protocol, the purpose of the header is twofold:

1. To frame the `LENGTH` field, so that `LENGTH` can be extracted and interpreted by the `GENERIC_FSK` packet processor, so as to determine how and when perform the required bit-stream processing on the data. In most wireless protocols with regular structures, the `LENGTH` field is embedded within the packet header, but its positioning, number of `LENGTH` bits, bit ordering, and interpretation can differ. The `GENERIC_FSK` configurability thus provides support for a wide range of header formats, yielding a high likelihood that most current and future packet formats and `LENGTH` fields will be parsable by the `GENERIC_FSK` Link Layer controller.
2. To provide rudimentary packet filtering on the non-`LENGTH` header bits, namely `H0` and `H1`. Screening of packets based on `H0` and/or `H1` bit comparisons can reduce power consumption, by avoiding notification to the host processor on received packets that do not comply with pre-configured `H0` and/or `H1` bitmasks, enabling longer MCU sleep durations.

The header components, and their configurability options, are further described below.

H0

`H0` is an optional header packet element. Its length in bits is determined by register `H0_SZ[4:0]`. Legal values for `H0_SZ` are:

$$0 \leq H0_SZ \leq 16$$

If `H0` is present (non-zero size), it can be filtered-on by the `GENERIC_FSK` packet processor; each bit of `H0` can be forced to match a programmable bitmask, or ignored. Every bit of `H0` that is forced to match the bitmask, must match; otherwise, the packet is rejected. The registers `H0_MATCH[15:0]` and `H0_MASK[15:0]` control `H0` filtering. For every bit of `H0_MASK` that is set to one, the received bit in the `H0` portion of the header

must match the corresponding bit of H0_MATCH. Bits of H0_MASK which are cleared, do not require a match of received data bits to H0_MATCH bits. If any bit of received data which is qualified with H0_MASK[x]=1 fails to match its corresponding H0_MATCH[x] bit, the H0_FAIL register status bit will be set, an RX recycle will occur, and the host processor will not be notified. (The recycle operation will self-clear the H0_FAIL bit). For debug purposes, the control bit REC_BAD_PKT has been provided. If REC_BAD_PKT=1 and a H0-mismatch occurs, the RX recycle is prevented, the full packet is received, the MCU is notified, and the H0_FAIL flag stays asserted. In this case, the H0-fail flag will stay asserted until the next RX warmup (specifically, rx_init clears the bit).

The equation for H0_FAIL is thus:

$$H0_FAIL = [H0_{received} \wedge H0_MATCH[15:0]) \& H0_MASK > 0$$

LENGTH

LENGTH is an optional header packet element. Its length in bits is determined by the register LENGTH_SZ[4:0]. Legal values for LENGTH_SZ are:

$$0 \leq LENGTH_SZ \leq 16$$

If LENGTH is present (non-zero size), its value determines the number of octets remaining in the packet after the header is complete, that is, PAYLOAD octets plus CRC octets, as depicted below.

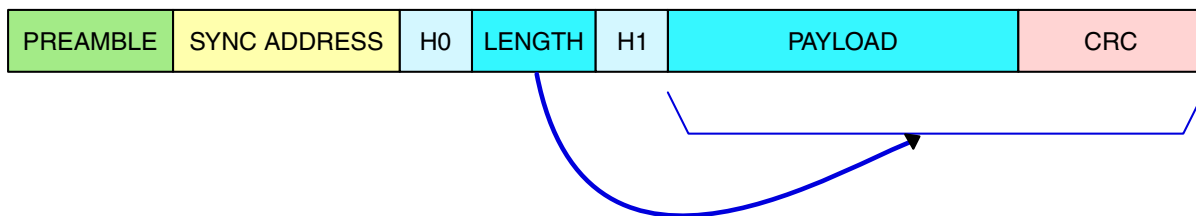

Figure 45-104. LENGTH Field Interpretation with No LENGTH_ADJ

For example, if the payload consists of 16 octets, and CRC is 4 octets, the LENGTH field of the header should be set to 20. The packet processor will extract the packet length from the LENGTH field of the header, and use this information to determine the timing of the CRC, Whitening, and Manchester control signals, as well as end-of-packet interrupt triggering.

In case a protocol exists for which the LENGTH field is to be interpreted differently, a configurability option has been provided to compensate for this. Hypothetically, this could happen, for example, in a proprietary packet structure, in which LENGTH is to be

defined to represent PAYLOAD only, excluding CRC. The register LENGTH_ADJ[4:0], allows a fixed offset to be applied to the extracted LENGTH field, such that the sum of LENGTH + LENGTH_ADJ represents the number of PAYLOAD + CRC octets, as depicted below:

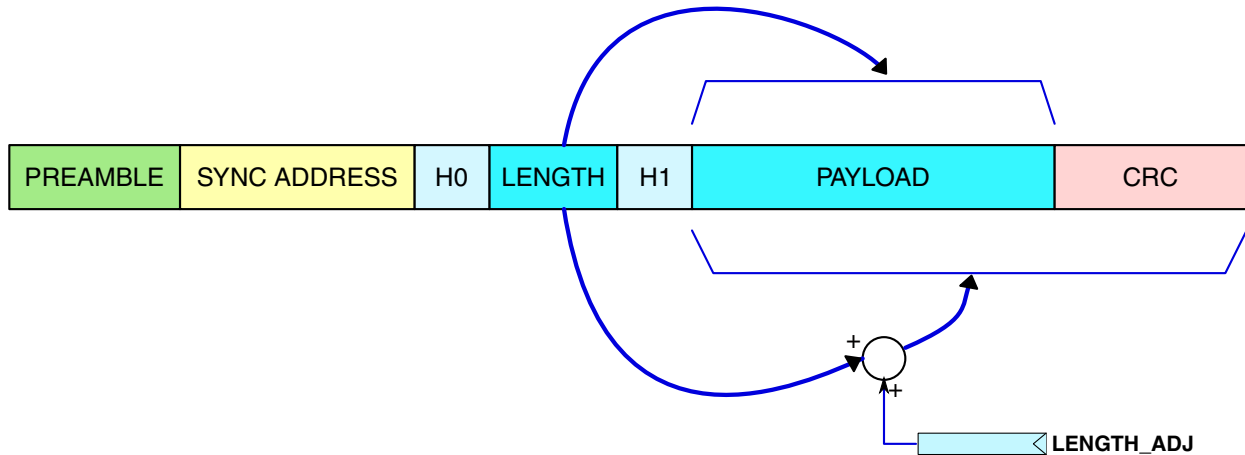

Figure 45-105. LENGTH Field Interpretation with LENGTH_ADJ

Applying the previous example, if, using a proprietary format, LENGTH were to be defined as payload-length only, LENGTH would be set to 16. In order for the packet processor to correctly time the CRC and Whitening control signals, etc., the LENGTH_ADJ register should be programmed to 4 in this case, so that the packet processor would operate on a 20-octet “PAYLOAD + CRC” PDU. The LENGTH_ADJ register represents a signed value, so that negative offsets can be applied. The legal range for LENGTH_ADJ is:

$$-31 \leq \text{LENGTH_ADJ} \leq 31$$

The LENGTH field could be ordered MSB first or LSB first. The packet processor must be able to accommodate either case, in order to extract the LENGTH field properly from the header, so a configurability option has been provided. The register bit LENGTH_BIT_ORD specifies the bit order. If LENGTH_BIT_ORD=0, ordering is LSB-first, as shown below.

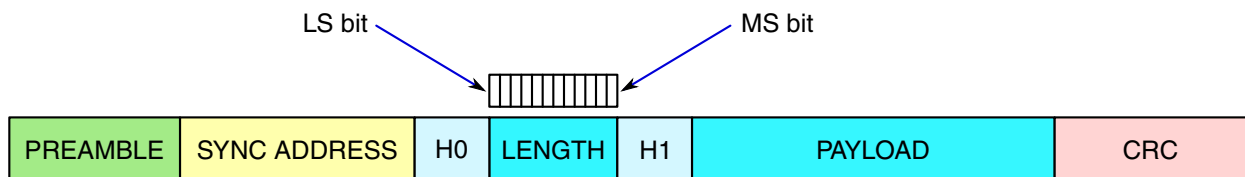

Figure 45-106. LENGTH Bit Ordering (LSB First)

If LENGTH_BIT_ORD=1, ordering is MSB-first, as shown below.

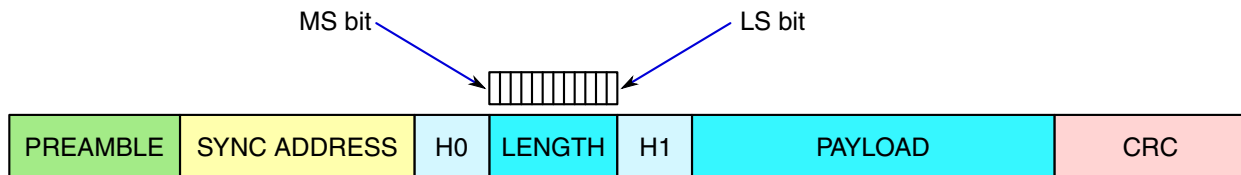

Figure 45-107. LENGTH Bit Ordering (MSB First)

If $LENGTH_SZ=0$, then $LENGTH$ is not present in the header. The packet processor interprets this as $LENGTH=0$. If, in this case, $LENGTH_ADJ=0$ also, the packet processor interprets this to mean that the packet ends with the last bit of $H1$, and there are no $PAYLOAD$ or CRC octets (CRC_SZ should be programmed to 0 in this case). There is no CRC verification in this scenario. If, in this case, $LENGTH_SZ=0$, meaning an empty payload field, but a CRC check is desired, CRC_SZ should be programmed to the desired number of CRC octets, and $LENGTH_ADJ$ should be programmed to the same value: $LENGTH_ADJ = CRC_SZ$.

For $GENERIC_FSK$, valid payload lengths are from 0 to 2047 octets, i.e.,

$$0 \leq LENGTH \leq 2047$$

If $LENGTH_ADJ$ is non-zero, then the maximum limit of 2047 applies to the sum of $LENGTH$ and $LENGTH_ADJ$, i.e.,

$$0 \leq (LENGTH + LENGTH_ADJ) \leq 2047$$

A restriction on $LENGTH_ADJ$ follows:

If the packet ends immediately after the $LENGTH$ field of the header, i.e., $H1_SZ=0$ and there is neither payload nor CRC , then $LENGTH_ADJ$ must be set to 0.

Although the $LENGTH$ field has a maximum size of 16 bits, since the maximum receivable packet size is 2047 bytes, any received $LENGTH$ bits above bit [10] are ignored by the packet processor, which effectively clamps $LENGTH$ at 2047 bytes. There may be cases where it is desirable to limit the maximum received packet length to values less than 2047, so that received packets whose extracted $LENGTH$ field indicates to be larger than a pre-set limit, are rejected by the packet processor. A configurability option has been provided for this, the register $LENGTH_MAX[6:0]$. The $LENGTH_MAX$ setting configures a pre-set limit on the extracted $LENGTH$ field, in multiples of 16 octets. A special case exists for $LENGTH_MAX=0$ (the register default), which implies no hardware-limiting; this setting should be used to allow reception of full-length 2047-octet packets. If $LENGTH_MAX=1$, packets with $LENGTH \geq 16$ octets are rejected. If $LENGTH_MAX=2$, packets with $LENGTH \geq 32$ octets are rejected. If $LENGTH_MAX=127$ (the maximum setting) packets with $LENGTH \geq 2032$ octets are rejected. To determine compliance with $LENGTH_MAX$, the packet processor compares

the LENGTH_MAX register with the extracted LENGTH field directly, not the adjusted length (LENGTH + LENGTH_ADJ). If a packet is received during which the extracted LENGTH field exceeds the LENGTH_MAX setting, the LENGTH_FAIL register status bit will be set, an RX recycle will occur, and the host processor will not be notified. (The recycle will self-clear the LENGTH_FAIL bit). For debug purposes, the control bit REC_BAD_PKT has been provided. If REC_BAD_PKT=1 and a LENGTH_MAX violation occurs, the RX recycle is prevented, the full packet is received, the MCU is notified, and the LENGTH_FAIL flag stays asserted. In this case, the LENGTH_FAIL flag will stay asserted until the next RX warmup (specifically, rx_init clears the bit).

H1

H1 is an optional header packet element. Its length in bits is determined by register H1_SZ[4:0]. Legal values for H1_SZ are $0 \leq H1_SZ \leq 16$. If H1 is present (non-zero size), it can be filtered-on by the GENERIC_FSK packet processor; each bit of H1 can be forced to match a programmable bitmask, or ignored. Every bit of H1 that is forced to match the bitmask, must match; otherwise, the packet is rejected. The registers H1_MATCH[15:0] and H1_MASK[15:0] control H1 filtering. For every bit of H1_MASK that is set to one, the received bit in the H1 portion of the header must match the corresponding bit of H1_MATCH. Bits of H1_MASK which are cleared, do not require a match of received data bits to H1_MATCH bits. If any bit of received data which is qualified with H1_MASK[x]=1 fails to match its corresponding H1_MATCH[x] bit, the H1_FAIL register status bit will be set, an RX recycle will occur, and the host processor will not be notified. (The recycle will self-clear the H1_FAIL bit). For debug purposes, the control bit REC_BAD_PKT has been provided. If REC_BAD_PKT=1 and a H1-mismatch occurs, the RX recycle is prevented, the full packet is received, the MCU is notified, and the H1_FAIL flag stays asserted. In this case, the H1-fail flag will stay asserted until the next RX warmup (specifically, rx_init clears the bit).

The equation for H1_FAIL is thus:

$$H1_FAIL = [H1_{received} \wedge H1_MATCH[15:0]) \& H1_MASK > 0$$

PAYLOAD

In the GENERIC_FSK packet structure, the payload directly followed the header. For transmission, payload bytes are serialized, and transmitted, LSB first, in order, as they are received from the Packet Buffer interface. During reception, payload bytes are received LSB first, undergo serial-to-parallel conversion to octets, 4 octets are packed into a 32-bit word, and the word is transferred to memory via Packet Buffer. For both TX and RX, since the packet processor interprets the extracted LENGTH to represent the number of Payload + CRC octets, the actual number of payload octets is computed from the following equation:

$$\text{Number_of_Payload_Octets} = (\text{LENGTH}_{\text{extracted}} + \text{LENGTH_ADJ} - \text{CRC_SZ})$$

For TX, payload bytes are subjected to whitening or Manchester encoding. They are also shifted through CRC to compute a CRC checksum value. Whitening, encoding, and CRC computing are all optional. Whitening and Manchester encoding are mutually exclusive. For RX, payload bytes are subjected to de-whitening, Manchester decoding, and CRC verification. De-whitening, Manchester decoding, and CRC verification are all optional. De-whitening and Manchester decoding are mutually exclusive. For both TX and RX, (de-)whitening can precede CRC, or follow it. Manchester encoding always operates on post-CRC bitstream for transmission, and Manchester decoding always precedes CRC verification for reception. For more details on CRC, whitening, and Manchester encoding, see Section Bitstream Processing.

CRC

In the GENERIC_FSK packet structure, the CRC field directly followed the payload. The size of the CRC field, in octets, is set by the CRC_SZ register. The valid range for CRC_SZ is:

$$0 \leq \text{CRC_SZ} \leq 4$$

For both TX and RX, the portion of the packet which are subjected to CRC is programmable, via the register CRC_START_BYTE[3:0]. The register CRC_START_BYTE programs the absolute byte count of the first byte for which CRC shifting is desired. The CRC_START_BYTE value is referenced to the GENERIC_FSK Byte Counter. The Byte Counter starts at 0 for the first octet of Sync Address, and increments octet-for-octet henceforth, until the last octet of CRC is transmitted or received. An example of CRC_START_BYTE programming is shown below.

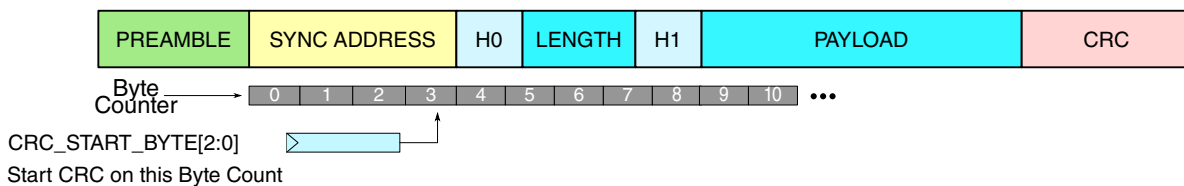

Figure 45-108. CRC Start Byte

In this example

$$\text{SYNC_ADDR_SZ} = 4$$

$$\text{Header Size} = 4 \text{ i.e. } (\text{H0_SZ} + \text{LENGTH_SZ} + \text{H1_SZ})/8 = 4$$

To initiate CRC shifting at the start of Sync Address, program $\text{CRC_START_BYTE} = 0$

To initiate CRC shifting at the start of Header, program $\text{CRC_START_BYTE} = 4$

To initiate CRC shifting at the start of Payload, program `CRC_START_BYTE=8`

The `CRC_START_BYTE` should not be programmed so large as to exceed the length of the PDU; that is, larger than extracted `LENGTH - CRC_SZ`. If `CRC_SZ=0`, program `CRC_START_BYTE=0`.

For more details on how the `GENERIC_FSK` packet processor controls the CRC generation and verification processes, see Section Bitstream Processing of this Block Guide.

EXAMPLE

A real-world example follows, describing how the `GENERIC_FSK` Link Layer packet configuration can be applied to transmit and receive packets which conform to IEEE 802.15.4g. For this example, please refer to IEEE Std 802.15.4g™-2012, Part 15.4: Low-Rate Wireless Personal Area Networks (LR-WPANs), Amendment 3: Physical Layer (PHY) Specifications for Low-Data-Rate, Wireless, Smart Metering Utility Networks.

Section 18.1.1.3 of 802.15.4g describes the packet header (PHR), which is replicated below as it appears in that standard:

Table 45-40. Format of the PHR(without mode switching) for MR-FSK

| Bit string index | 0 | 1-2 | 3 | 4 | 5-15 |
|------------------|-------------|--------------------------------|----------|----------------|---------------------------------|
| Bit mapping | MS | R ₁ -R ₀ | FCS | DW | L ₁₀ -L ₀ |
| Field Name | Mode Switch | Reserved | FCS Type | Data Whitening | Frame Length |

The `GENERIC_FSK` Link Layer controller supports such a header format, and can be programmed to transmit and receive packets which conform to it. To correctly size and order the `GENERIC_FSK` header elements so as to conform with this header format:

1. The `LENGTH` field ends the header, so there is no `H1` (`H1_SZ=H1_MASK=0`)
2. The 5 bits which precede `LENGTH` in the header, are grouped into `H0` (`H0_SZ=5`)
3. The size of the `LENGTH` field is 11 bits (`LENGTH_SZ=11`)
4. The `LENGTH` is specified as MSB-first (`LENGTH_BIT_ORD=1`)

For this example, we would like to leverage the `H0`-filtering capability built into the `GENERIC_FSK` Link Layer to screen the 802.15.4g header, to require that the bit fields in the received packet comply with the following conditions:

1. MS (Mode Switch, bit [0] of header) = 0
2. DW (Data Whitening, bit [4]) = 1
3. FCS (FCS Type, bit [3]) = 1 (Four-octet FCS)
4. Bits [1] and [2] are marked as Reserved, to be ignored on reception

Given these parameters, the following diagram shows how we would program the GENERIC_FSK Link Layer controller to accept this packet configuration, and then screen H0 accordingly:

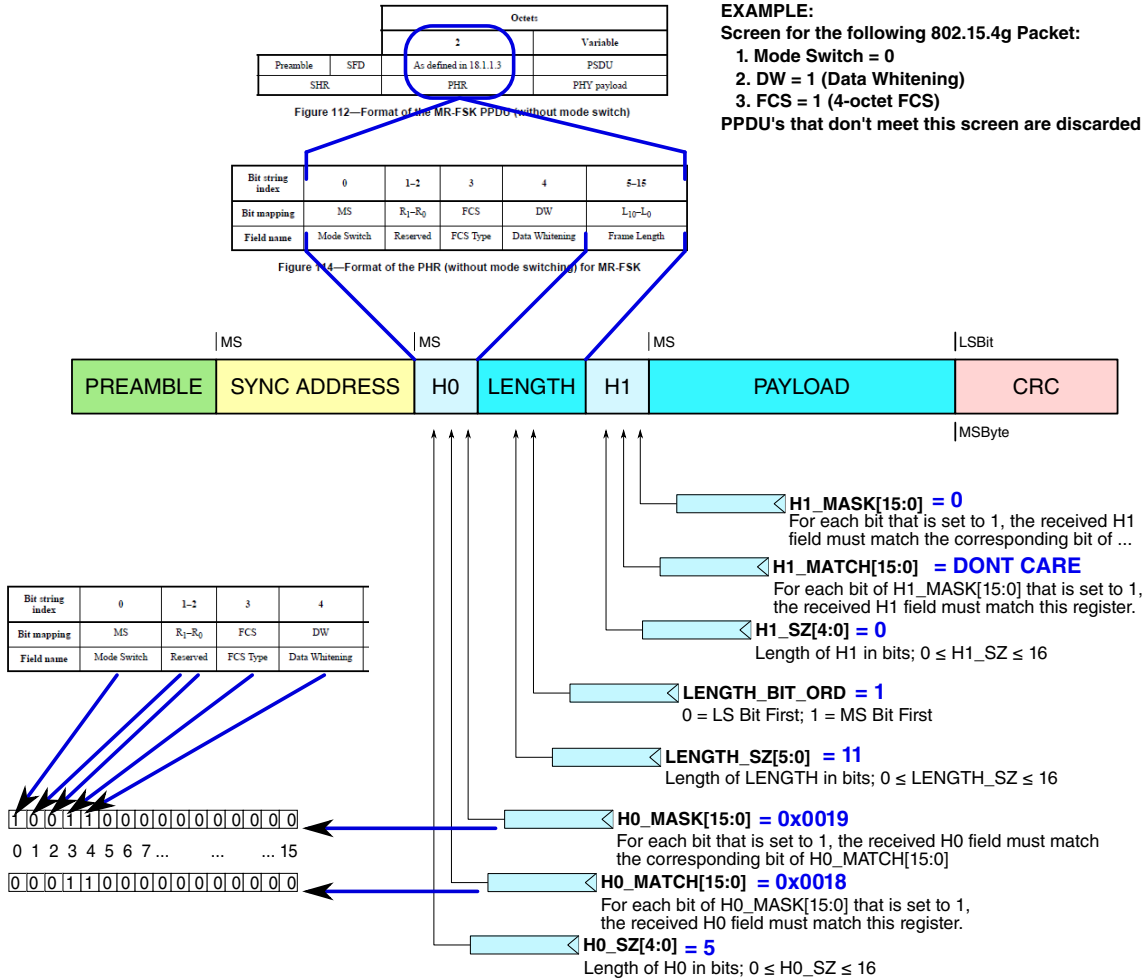

Received packets which meet the H0 filtering screen are fully received, and Data Indication is provided to the host processor. Packets which fail the screen result in an RX recycle, and no notification to the host.

45.6.3.3.2 Bitstream Processing

The GENERIC_FSK Link Layer controller provides a number of options to allow for control and modification of the serial bitstream as the packet is being transmitted and received. From a high-level point-of-view, these 4 options are provided:

1. CRC generation (TX) and CRC verification (RX)
2. Data Whitening (TX) and De-whitening (RX)
3. Manchester Encoding (TX) and Decoding (RX)
4. Variable Bit Rate

The following diagram provides another perspective of bitstream processing.

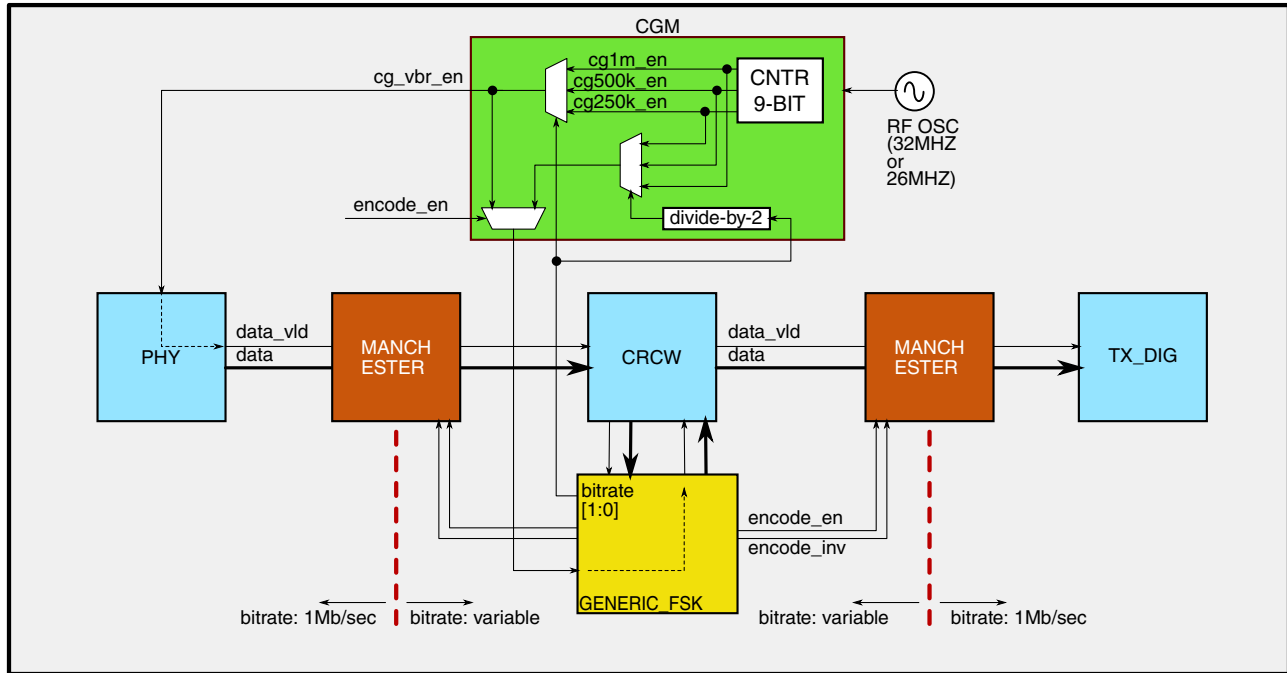

Figure 45-110. BITSTREAM PROCESSING WITH MANCHESTER ENCODING

For GENERIC_FSK, CRC and Whitening are somewhat consolidated, and are performed in a separate module external to the Link Layer Controller. The CRC/Whitener block performs these functions. (See the CRC/Whitener Block Guide for more details). Manchester encoding is also performed externally, and is described later in this section. Bitrate configurability is managed jointly by the GENERIC_FSK Link Layer controller and the 2.4GHz Radio's Clock Generation Module (CGM). The following sections provide more detail on how CRC, whitening, Manchester encoding, and bitrate, are controlled by the GENERIC_FSK Link Layer, and describes the configuration options associated with each.

CRC & WHITENING

The GENERIC_FSK Link Layer controller dynamically manages the CRC generation process (for TX), and CRC verification process (for RX), by way of 3 timing signals that it asserts to the CRC/Whitener module.

For GENERIC_FSK, the CRC engine in the CRC/Whitener block shall only shift incoming bits (`data_in`) through its LFSR when all the following conditions are met:

Link Layer

1. `crcw_init=0`
2. `crc_en=1`
3. `tx_data_in_vld=1` (signal is `data_in_vld` at the CRC/Whitener)

The CRC/Whitener shall only shift bits out of its CRC LFSR, to the TX digital block, when all the following conditions are met:

1. `crcw_init=0`
2. `crc_comp=1`
3. `tx_data_in_vld=1` (signal is `data_in_vld` at the CRC/Whitener)

The packet processor uses the extracted LENGTH field of the packet, as well as the registers which control the size of the individual packet elements, in order to determine when to assert the CRC-related control signals, **`crc_en`** and **`crc_comp`**. This is true for both transmission and reception. The calculations used by the packet processor to determine when to assert the CRC-related control signals are summarized in the following diagram.

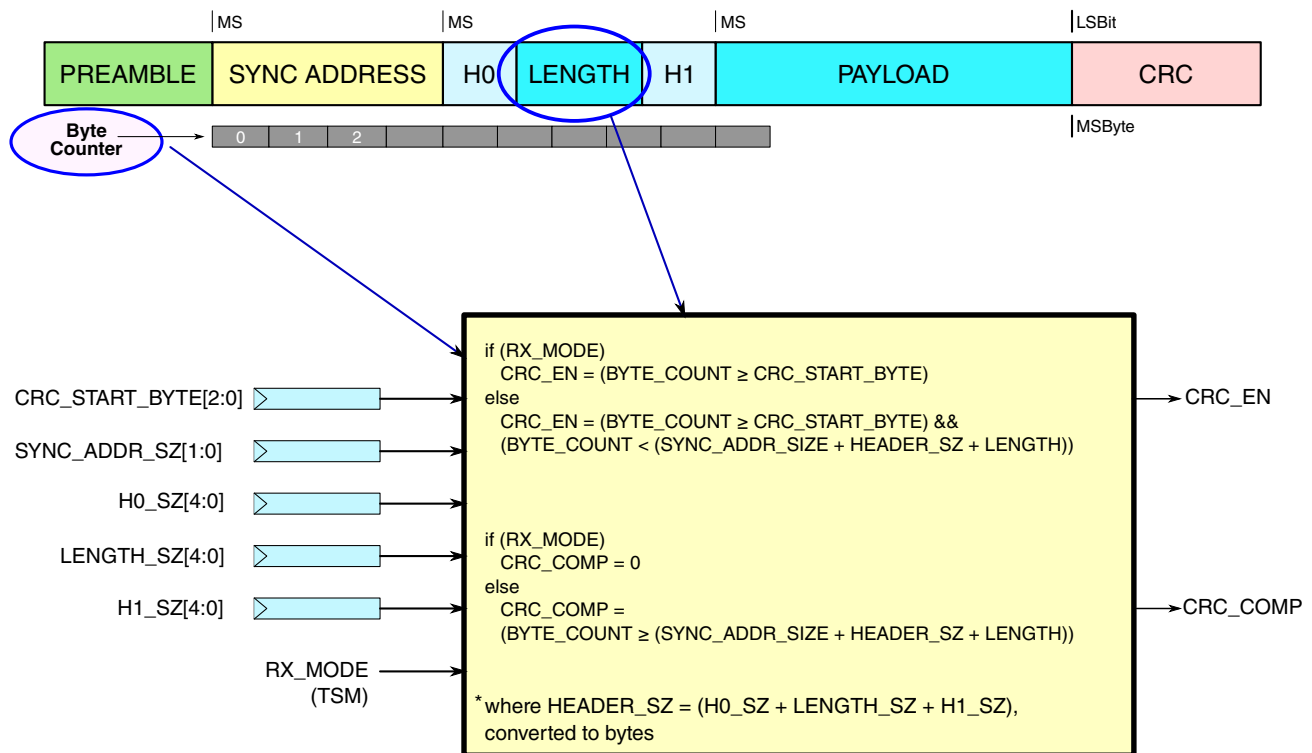

Figure 45-111. GENERIC FSK: CONTROL OF CRC

Likewise, the GENERIC_FSK Link Layer controller optionally enables whitening and de-whitening of the packet bitstream, and controls the portions of the packet which are subjected to whitening. For both TX and RX, the portion of the packet which are

subjected to whitening/de-whitening is programmable; the following table describes the 3 registers which determine which elements of the packet bitstream are whitened/de-whitened.

| REGISTER NAME | FUNCTIONAL DESCRIPTION |
|---------------------|--|
| WHITEN_START[1:0] | <p>0: No whitening/de-whitening</p> <p>1: Begin whitening/de-whitening at the start of the header (H0) field, regardless of packet length.</p> <p>2: Begin whitening/de-whitening at the start of the header H1 field, but only if the extracted length field meets or exceeds WHITEN_SZ_THR, i.e., (LENGTH_{extracted} >= WHITEN_SZ); otherwise, there is no whitening/de-whitening of the bitstream</p> <p>3: Begin whitening/de-whitening at the start of the PAYLOAD, but only if the extracted length field meets or exceeds WHITEN_SZ_THR, i.e., (LENGTH_{extracted} >= WHITEN_SZ); otherwise, there is no whitening/de-whitening of the bitstream</p> |
| WHITEN_END | <p>0: Whitening/de-whitening ends with the last bit of the last PAYLOAD byte</p> <p>1: Whitening/de-whitening ends with the last bit of the last CRC byte</p> |
| WHITEN_SZ_THR[12:0] | <p>If WHITEN_START=2 or WHITEN_START=3, apply whitening/de-whitening at the point determined by WHITEN_START, but only if the extracted LENGTH field of the packet meets or exceeds this WHITEN_SZ_THR threshold; if LENGTH_{extracted} < WHITEN_SZ_THR, there is no whitening/de-whitening of the bitstream. If WHITEN_START < 2, this register has no effect.</p> |

The GENERIC_FSK Link Layer controller dynamically manages the data whitening process (for TX), and de-whitening (for RX), via 2 timing signals that it asserts to the CRC/Whitener module.

For GENERIC_FSK, the Whitening/de-whitening engine in the CRC/Whitener block shall only shift incoming bits (data_in) through its LFSR when all the following conditions are met:

1. crcw_init=0
2. whiten_en=1
3. tx_data_in_vld=1 (signal is data_in_vld at the CRC/Whitener)

Link Layer

The packet processor uses the extracted LENGTH field of the packet, as well as the registers which control the size of the individual packet elements, in order to determine when to assert the whitening-related control signal, `whiten_en`. This is true for both transmission and reception. The calculations used by the packet processor to determine when to assert `whiten_en` control signals are summarized in the following diagram.

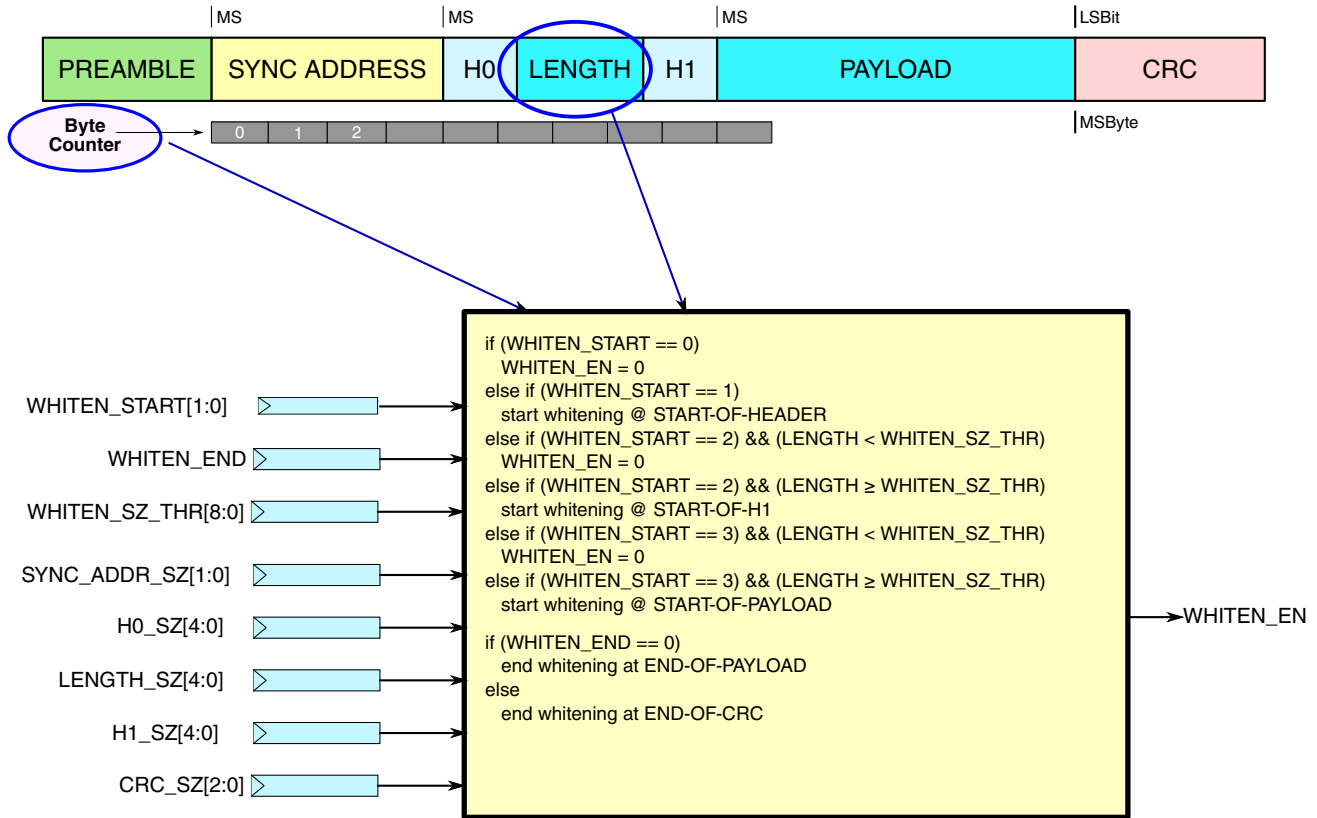

Figure 45-112. GENERIC FSK: CONTROL OF WHITENING

The order in which CRC and whitening are performed, is configurable, via the static register bit `WHITEN_B4_CRC`. This bit is programmed in the `GENERIC_FSK` Link Layer, and sent to the CRC/Whitening engine to control the ordering. The following table describes how the bitstream is processed for both settings of `WHITEN_B4_CRC`, for both TX and RX.

| | TX | RX |
|------------------------------|---|---|
| <code>WHITEN_B4_CRC=1</code> | In the CRC/Whitener, the CRC engine shifts in data bits which have been whitened first through the whitener LFSR. The entire post-whitened bitstream is then transmitted to the TX Digital. | Since the entire bitstream, including CRC, has been pre-whitened, the incoming bitstream from the PHY is shifted directly through the CRC LFSR to verify the checksum. The entire bitstream is simultaneously de-whitened by the whitener LFSR and shifted out to the Link Layer. |

Table continues on the next page...

| | TX | RX |
|-----------------|--|---|
| WHITEN_B4_CRC=0 | In the CRC/Whitener, the CRC engine shifts in data bits which have not been whitened. Whitening is performed on the CRC LFSR output. The entire post-whitened bitstream is then transmitted to the TX Digital. | The entire bitstream is de-whitened first by the whitener LFSR, and then shifted through the CRC LFSR to verify the checksum. The entire de-whitened bitstream is simultaneously shifted out to the Link Layer. |

A diagram depicting an example of bitstream processing flow during packet transmission, with WHITEN_B4_CRC=1 (the register default), is shown below.

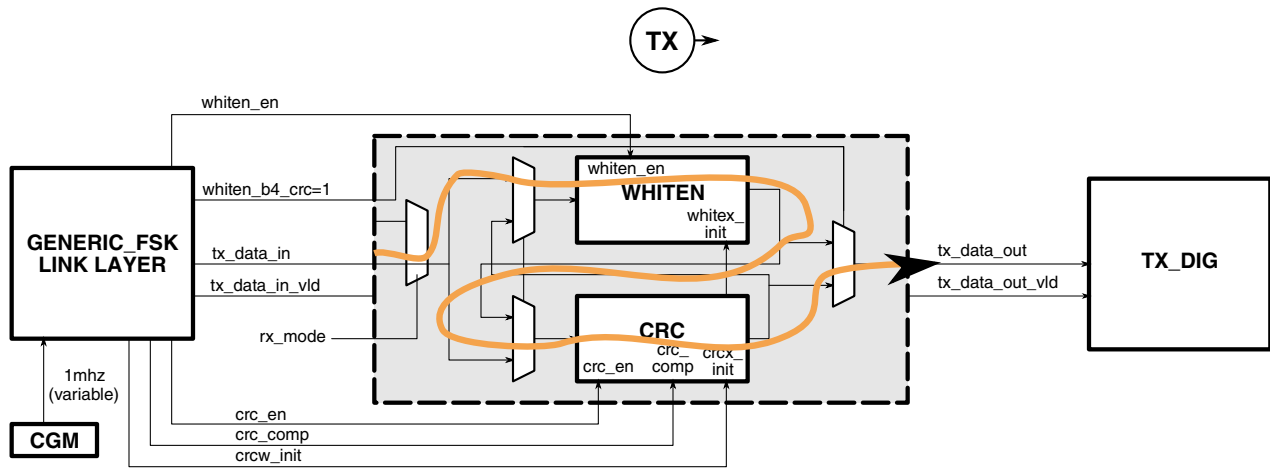

Figure 45-113. Whitening Before CRC (TX)

A diagram depicting an example of bitstream processing flow during packet reception, with WHITEN_B4_CRC=1, is shown below.

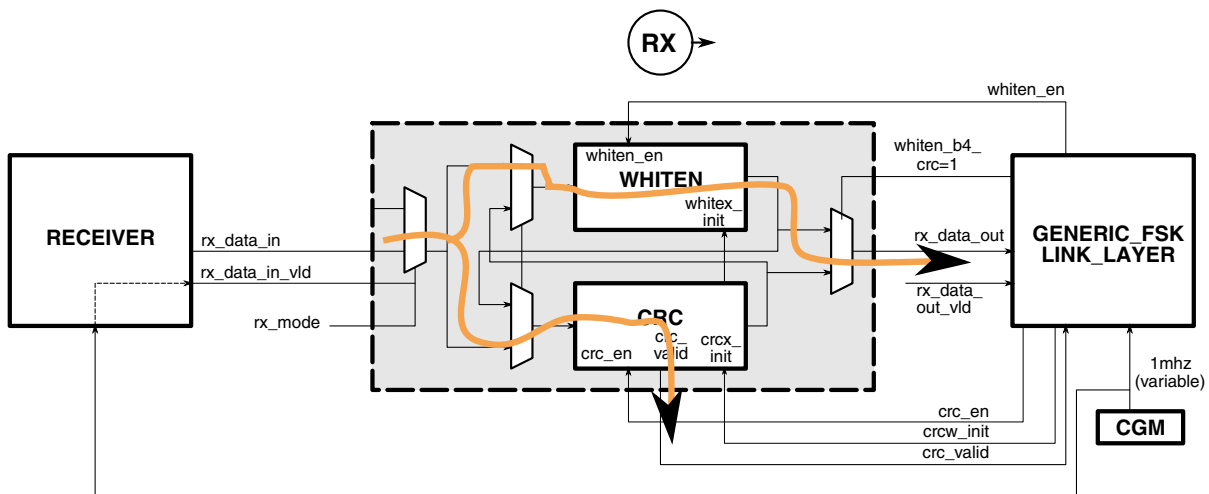

Figure 45-114. Whitening Before CRC (RX)

A timing diagram depicting a real-world example of TX bitstream processing timing is shown below. In this example, the desired start point for CRC shifting is the start of Network Address, so CRC_START_BYTE=0. The desired start point for whitening is the start of the header (H0), so WHITEN_START=1. It is also desired to stop whitening after the last bit of the last PAYLOAD byte, so WHITEN_END=0.

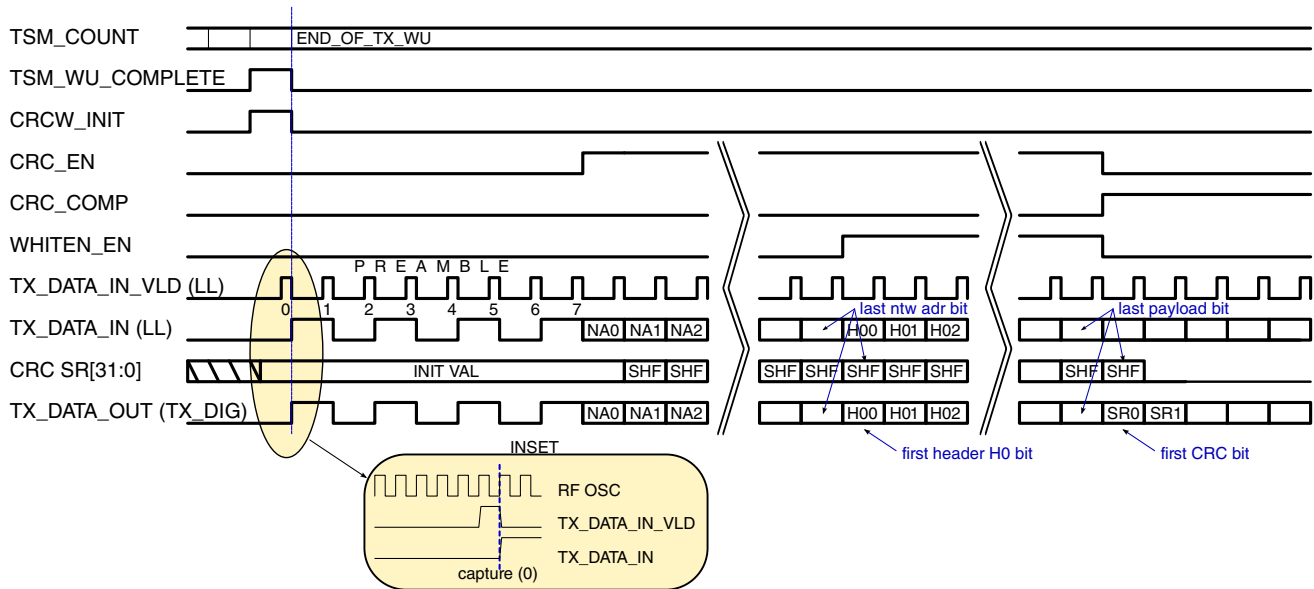

Figure 45-115. BIT STREAM PROCESSING CRC AND WHITENING TX TIMING

The bitstream depicted in the previous timing diagram, with CRC and whitening applied, is shifted out to the TX digital block, and transmitted over the air. A receiving device, will receive and process this same bitstream, by applying de-whitening, and verifying CRC on the de-whitened bitstream. The CRC and whitening parameters (registers) would be programmed to the receiving device, identically to how they are programmed for the transmitting device, specifically:

CRC_START_BYTE=0

WHITEN_START=1

WHITEN_END=0

A similar timing diagram depicting this RX bitstream processing timing, is shown below.

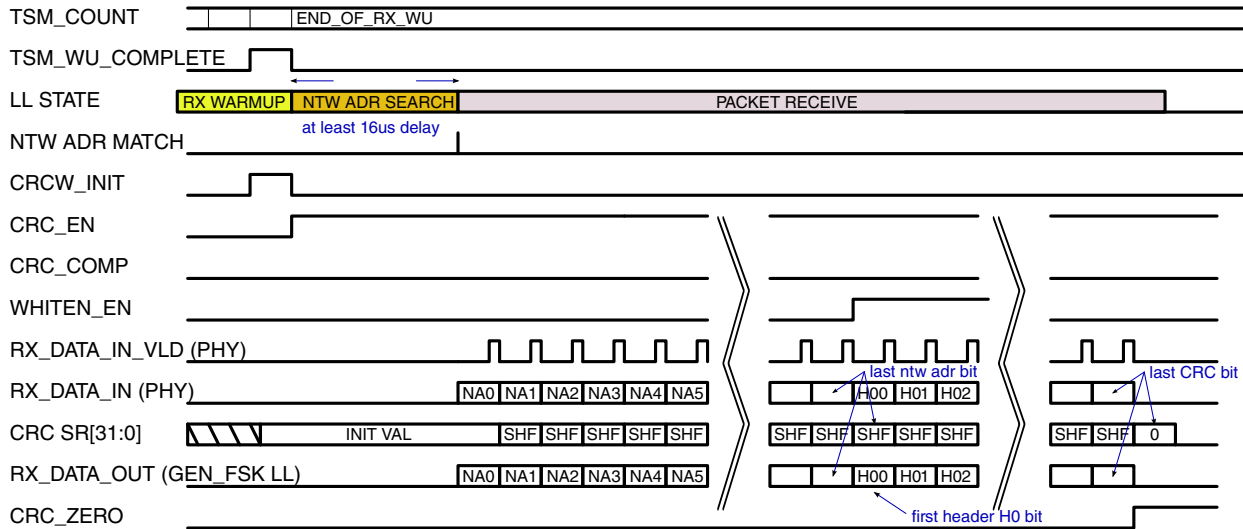

Figure 45-116. BIT STREAM PROCESSING CRC AND WHITENING RX TIMING

The GENERIC_FSK Link Layer controller provides a special whitening option, that causes the whitening LFSR to be re-initialized at the start of the PAYLOAD. The register bit WHITEN_PAYLOAD_REINIT, when 1, will result in the LFSR being re-initialized to its programmed initial state, determined by WHITEN_SEED[8:0], coincident with the first bit of the first byte of PAYLOAD. This applies to both TX and RX. When WHITEN_PAYLOAD_REINIT=0, there is no such re-initialization. This feature is only relevant when whitening/de-whitening is programmed to start before the PAYLOAD, i.e., WHITEN_START=1 or WHITEN_START=2.

The GENERIC_FSK Link Layer controller provides a number of other configurability options, which affect the internal operation of the CRC engine, and not the Link Layer controller itself. A listing of these registers which affect CRC internal operation, appears in the table below. For more details on how these registers affect CRC operation, see the CRC/Whitener Block Guide.

| CRC-related Register | Brief Description |
|----------------------|--|
| CRC_POLY[31:0] | CRC Polynomial 1: XOR exists in the bit's feedback path 0: no XOR in the bit's feedback path |
| CRC_SEED[31:0] | CRC Initialization Value |
| CRC_BYTE_ORD | 0: LS Byte First 1: MS Byte First |
| CRC_REF_IN | 0: do not manipulate input data stream 1: reflect each byte in the input stream bitwise |
| CRC_REF_OUT | 0: do not manipulate CRC result |

Table continues on the next page...

Link Layer

| CRC-related Register | Brief Description |
|----------------------|--|
| | 1: CRC result is to be reflected bitwise (operated on entire word) |
| CRC_XOR_OUT[31:0] | XOR mask for CRC result (for no mask, should be 0) |

Similarly, there are a number of configurable whitening options provided by the Link Layer controller, which affect the internal operation of the whitening engine, and not the Link Layer controller itself. A listing of these registers which affect whitener internal operation, appears in the table below. For more details on how these registers affect whitener operation, see the CRC/Whitener Block Guide.

| Whitener-related Register | Brief Description |
|---------------------------|--|
| WHITEN_POLY[8:0] | Polynomial Value for Whitening/De-whitening |
| WHITEN_POLY_TYPE | Whiten polynomial type. A Fibonacci type LFSR is used with the whiten polynomial if this bit is asserted. Otherwise, a Galois type LFSR is used. |
| WHITEN_SEED[31:0] | Initialization Value for Whitening/De-whitening |
| WHITEN_SIZE[3:0] | Whitener Length |
| WHITEN_REF_IN | The input data stream is reflected, bit-wise, per byte, if this bit is asserted. Bit 7 becomes bit 0, bit 6 becomes bit 1, etc. This bit will only cause the reflection of the payload data bits as they are used in the whiten calculation and will not cause any change in the output bit order. |

BITRATE

The GENERIC_FSK Link Layer controller provides 3 bitrate options. The register BITRATE[1:0] selects the bitrate, according to the following table.

| BITRATE[1:0] Register | BITRATE |
|-----------------------|--------------|
| 0 | 1 Mbit/sec |
| 1 | 500 Kbit/sec |
| 2 | 250 Kbit/sec |
| 3 | Reserved |

For transmission, BITRATE affects the rate at which the Link Layer controller shifts out bits, through the CRC/Whitener, and ultimately to the TX Digital Block. For reception, BITRATE affects the rate at which the PHY shifts out bits, through the CRC/Whitener, and ultimately to the Link Layer controller, which receives and processes the bitstream. The Link Layer is the originator of the packet bitstream for transmission; the PHY is the originator of the bitstream for reception. The Link Layer controller determines the bitrate by sending the **bitrate[1:0]** signal to the CGM (Clock Generation Module). The CGM decodes this signal and adjusts the rate at which pulses appear on **cg_vbr_en** to track the

programmed BITRATE. (Note: the vbr in **cg_vbr_en** is an acronym for ‘variable bit rate’.) The CGM divides down the reference oscillator frequency to generate the frequency of the desired BITRATE, and then sends out pulses on **cg_vbr_en** which are one reference oscillator clock wide, at that rate. The **cg_vbr_en** shall be used as a gating signal (clock gating and/or data gating) inside the blocks which originate the bitstream (Link Layer, PHY), and those that consume it (CRC/Whitener, TX digital). The timing on **cg_vbr_en** manifests itself on the respective *_data_in_vld and *_data_out_vld signals to and from the 4 blocks that operate on the bitstream. This way, all 4 blocks operate in unison at all times at a single, desired bitrate.

The following diagram depicts how bitrate is controlled by the Link Layer and CGM, and how the respective blocks involved in bitstream processing stay in sync using **cg_vbr_en**.

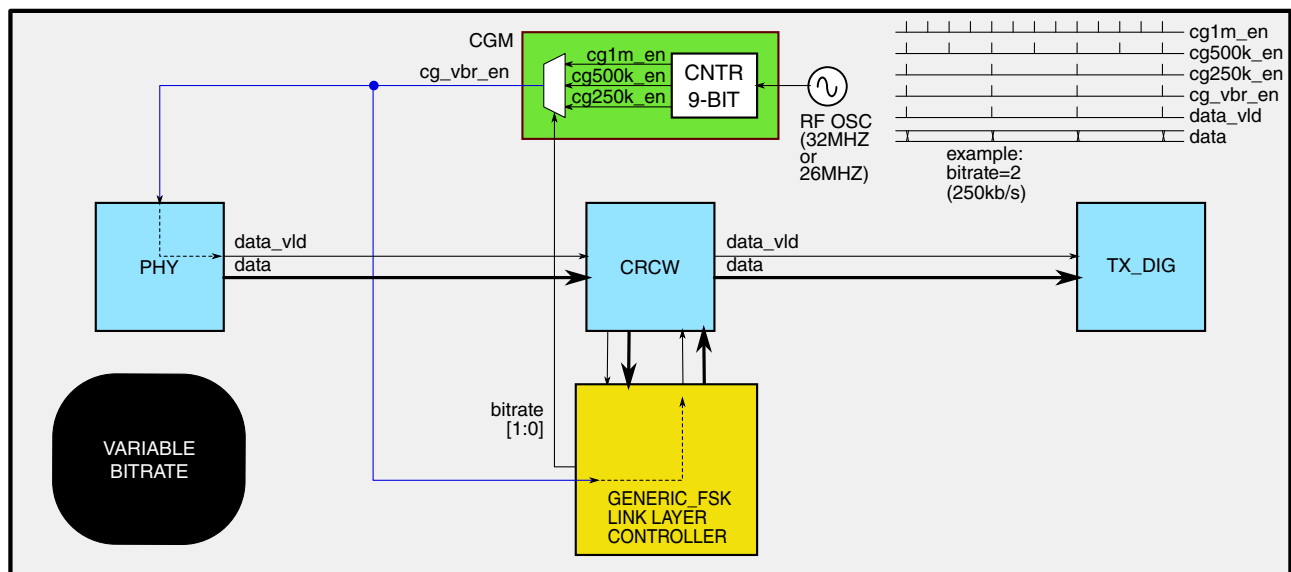

Figure 45-117. BITSTREAM PROCESSING WITH VARIABLE BIT RATE

MANCHESTER ENCODING AND DECODING

The GENERIC_FSK Link Layer controller allows the packet bitstream to be Manchester-encoded for transmission, and decoded for reception. The Manchester encoding used by the controller conforms to IEEE 802.3, which is shown in the following diagram.

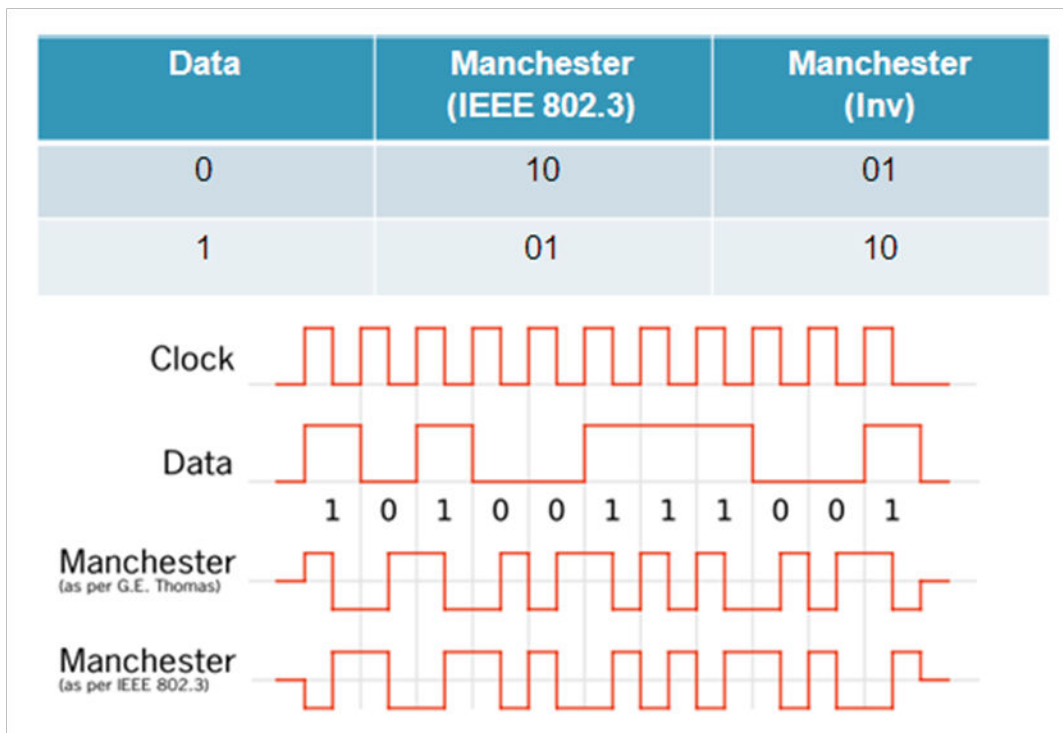

Figure 45-118. Manchester Encoding

Three programmable registers enable and control Manchester encoding and decoding, as described in the following table.

| | TX | RX |
|------------------|---|---|
| MANCHESTER_EN | 1: the entire packet bitstream, including CRC, is Manchester-encoded as it is transmitted to the TX digital block. CRC operates on the original, non-encoded bitstream. 0: No encoding applied | 1: the entire packet bitstream, including CRC, is Manchester-decoded, and the output of the decoder is transmitted simultaneously to the CRC engine and the Link Layer. 0: No decoding applied |
| MANCHESTER_INV | 1: Encoding is per 802.3, but with the coding signal inverted 0: Encoding is as per 802.3 | 1: Decoding is per 802.3, but with the coding signal inverted 0: Decoding is as per 802.3 |
| MANCHESTER_START | 1: Begin encoding at start-of-header 0: Begin encoding at start-of-payload | 1: Begin decoding at start-of-header 0: Begin decoding at start-of-payload |

As the encoding diagram implies, the post-encoded process bitstream has a bitrate of twice that of the pre-encoded data. The over-the-air bitrate must, of course, be constant. Thus, for transmission, the source of the bitstream data, i.e., the GENERIC_FSK Link Layer controller, must halve its bitrate whenever Manchester encoding is engaged. Since the CRC engine is also upstream of the encoder, it will also see the half bitrate. The output of the Manchester encoder, which feeds the TX digital block, will see the full bitrate. For reception, the source of the bitstream data, i.e., the PHY, will see the full

bitrate. After the PHY feeds the Manchester decoder with the full-rate data, the blocks downstream of the decoder, i.e., the Link Layer controller and the CRC engine, will need to operate at half bitrate. When Manchester encoding is used, the over-the-air bitrate, that is, the bitrate programmed via the BITRATE register, is restricted to either 1Mbit/sec (BITRATE=0), or 500Kbit/sec (BITRATE=1); The 250Kbit/sec option is not supported with Manchester. The following table summarizes the supported over-the-air bitrates, and specifies the effective bit rates seen by the 4 blocks involved in bitstream processing while Manchester is engaged.

| | PHY | GENERIC_FSK Link Layer | CRC LFSR | TX Digital |
|---------------------------------------|--------------|------------------------|--------------|--------------|
| BITRATE=0 (ota bitrate = 1 Mbit/sec) | 1 Mbit/sec | 500 Kbit/sec | 500 Kbit/sec | 1 Mbit/sec |
| BITRATE=1 (ota bitrate = 500Kbit/sec) | 500 Kbit/sec | 250 Kbit/sec | 250 Kbit/sec | 500 Kbit/sec |

Because the Manchester encoding and decoding is not performed over the entire packet, e.g., the Network Address is never encoded, the Link Layer controller must switch its bitrate *dynamically*, reducing its own bitrate by half whenever Manchester is engaged, and restoring full bitrate when Manchester is disengaged. Since the PHY and TX digital must process bits at the full rate at all times, the bitstream-pacing signal, **cg_vbr_en**, must be split, such that the PHY and TX digital get the full rate gating signal, and the Link Layer and CRC get the variable rate gating signal. The following diagram describes how the CGM generates a special half-rate rendition of **cg_vbr_en** when Manchester is engaged (**encode_en=1**), and feeds this to the Link Layer (and indirectly, the CRC engine). The diagram assumes the default setting of BITRATE=0 (over-the-air rate is 1Mb/sec).

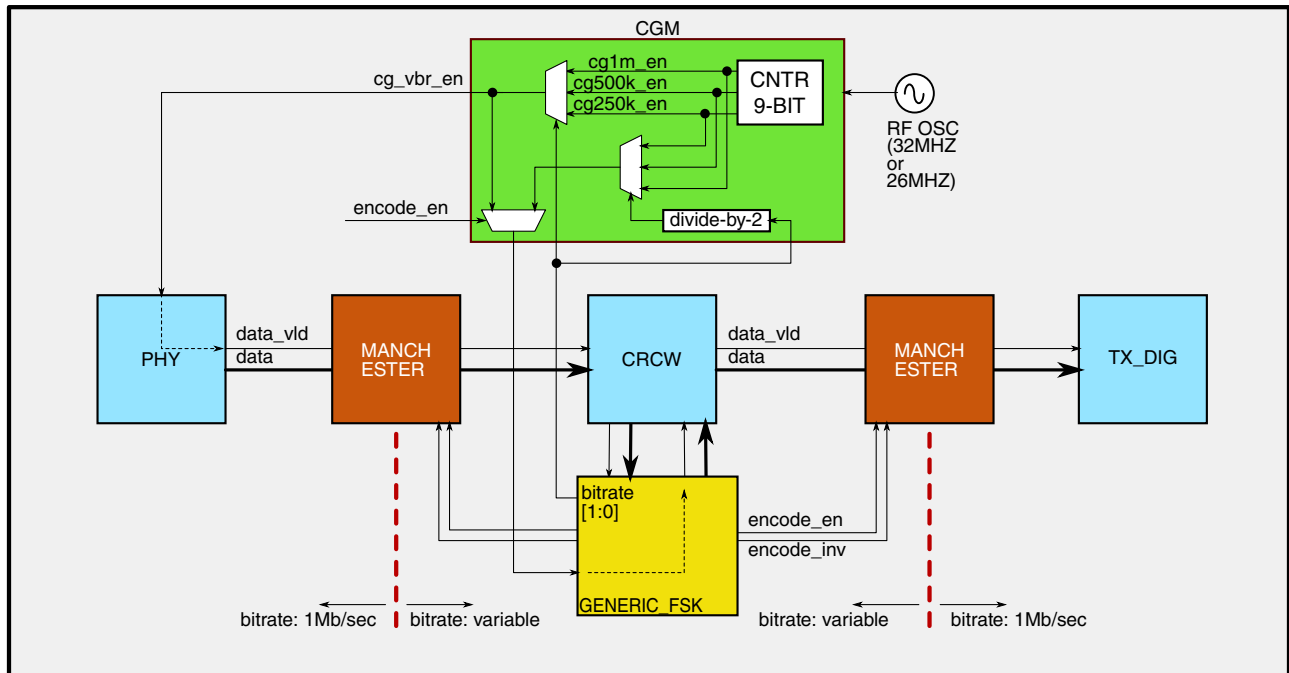

Figure 45-119. BITSTREAM PROCESSING WITH MANCHESTER ENCODING

A timing diagram depicting an example of bitstream processing, including Manchester encoding, for a packet transmission, is included below. The diagram shows the mid-packet switching of the encoding-enable signal, encode_en, and the halving of the bitrate as seen by the Link Layer controller. This example uses MANCHESTER_START=0, to initiate encoding at the start-of-payload.

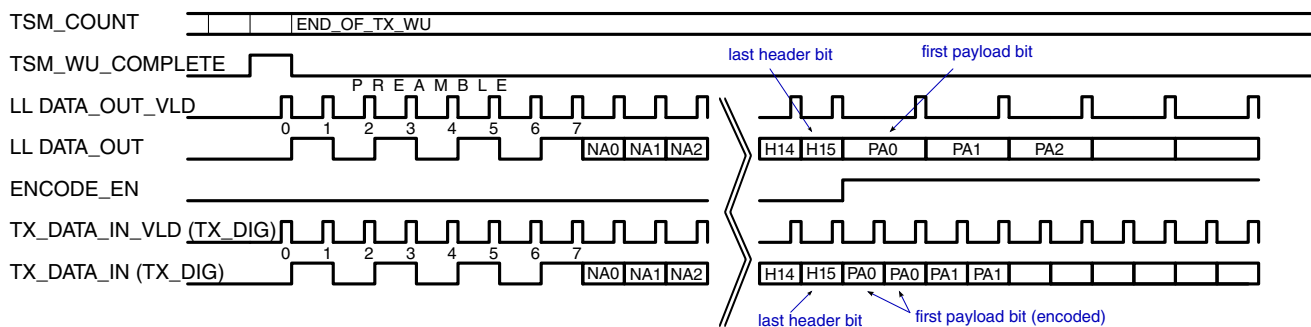

Figure 45-120. BIT STREAM PROCESSING (WITH MANCHESTER) TX TIMING -- 1MBIT/SEC OTA

An example of bitstream processing, including Manchester encoding, for a packet reception, is included below. The diagram shows the mid-packet switching of the decoding-enable signal, encode_en, and the halving of the bitrate as seen by the Link Layer controller. This example uses MANCHESTER_START=0, to initiate encoding at the start-of-payload.

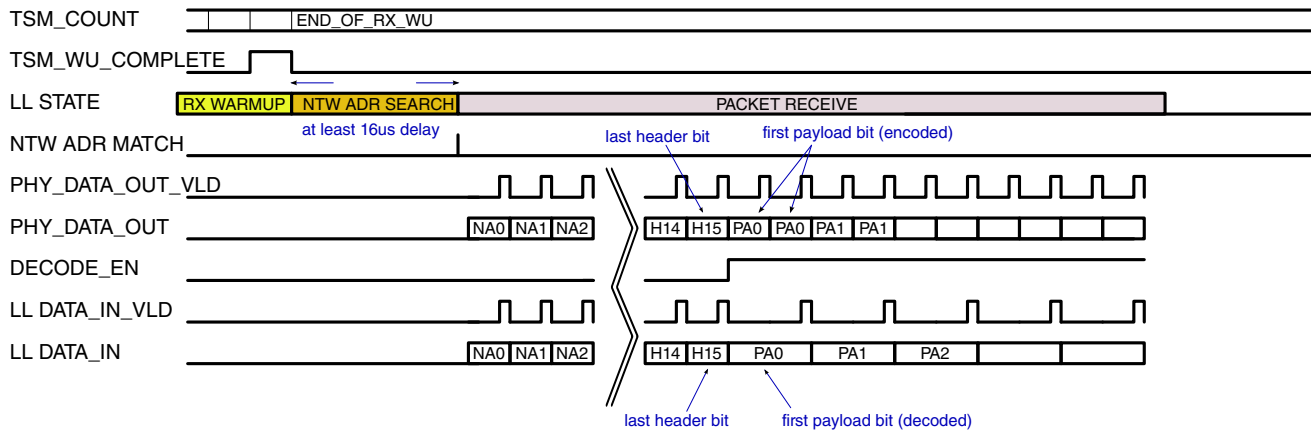

Figure 45-121. BIT STREAM PROCESSING (WITH MANCHESTER) RX TIMING -- 1MBIT/SEC OTA

NOTE

Whitening and Manchester encoding are mutually exclusive, and must not be enabled simultaneously. This is a software restriction on the setting of the register bits `WHITEN_START` and `MANCHESTER_EN`. Both may not be simultaneously non-zero. Failure to heed this restriction may lead to indeterminate behavior.

45.6.3.3.3 Packet Storage

The `GENERIC_FSK` Link Layer has access to a Packet Buffer (also known as Packet RAM), to store data to be transmitted, and to receive incoming packet data. The `GENERIC_FSK` Link Layer software prepares data to be transmitted, by loading the octets, in order, into the Packet Buffer. After reception, the octets received over the air are stored into the Packet Buffer, in the order they are received. The Packet Buffer contains separate spaces for TX and RX data, so incoming receive octets don't overwrite previously-loaded content intended for transmission. The Packet Buffer is large enough to accommodate the longest `GENERIC_FSK` packet, 2047 octets, plus header and CRC octets, for either transmit or receive.

The `GENERIC_FSK` Packet Buffer is contained within the multi-protocol Packet RAM. When operating in `GENERIC_FSK` mode, the entire Packet RAM is allocated to the `GENERIC_FSK` packet buffer. Because of the potentially large size of the `GENERIC_FSK` packets, and taking into account the high likelihood of asymmetry between the required lengths of packets for TX and RX, the 2 normally-separated RAM components of the Packet RAM are adjoined sequentially to form a double-depth (1088-entry) single storage space, still 16-bits wide. In addition, the consolidated RAM can be dedicated entirely to TX, entirely to RX, or split between TX and RX. The partitioning of

the consolidated RAM between TX and RX is controlled by a configurable TX/RX Partition Point. A Partition Point register, PB_PARTITION[10:0], has been provided. The Register can be programmed with any value between 0 and 1087. The consolidated RAM is partitioned such that the TX buffer resides before the Partition Point (RAM entries 0 -> (Partition_Point-1)), and the RX buffer resides after it (RAM entries Partition_Point -> 1087). Programming the Partition Point register to 0 dedicates the entire consolidated RAM to RX; programming the Partition Point register to 1088 dedicates the entire consolidated RAM to TX; programming the Partition Point register to any value between 1 and 1087 yields a split TX/RX buffer. Separate TX and RX buffers within the consolidated RAM means that incoming RX packets don't overwrite TX packet data. Because the Packet RAM is 16 bits wide, the GENERIC_FSK Link Layer controller hardware will address the consolidated RAM in an interleaved fashion as it stores octets to, or fetches octets from, the RAM-based packet buffer.

The partitioning of the consolidated RAM between transmit and receive sections for GENERIC_FSK is shown in the diagram below:

1. RAM0 and RAM1 abutted sequentially to form 1 contiguous space from Entry #0 - #1087
2. A Programmable Partition Point is defined: TX data before the partition, RX data after
3. The partition point can be programmed to any value from Entry #0 - #1087
4. Full 2 KB packet can be allowed
5. TX and RX packets are separated (RX does not overwrite TX)
6. Host access restricted to 16-bit
7. Retention: If retaining, both RAM may be retained (depends on partition point)

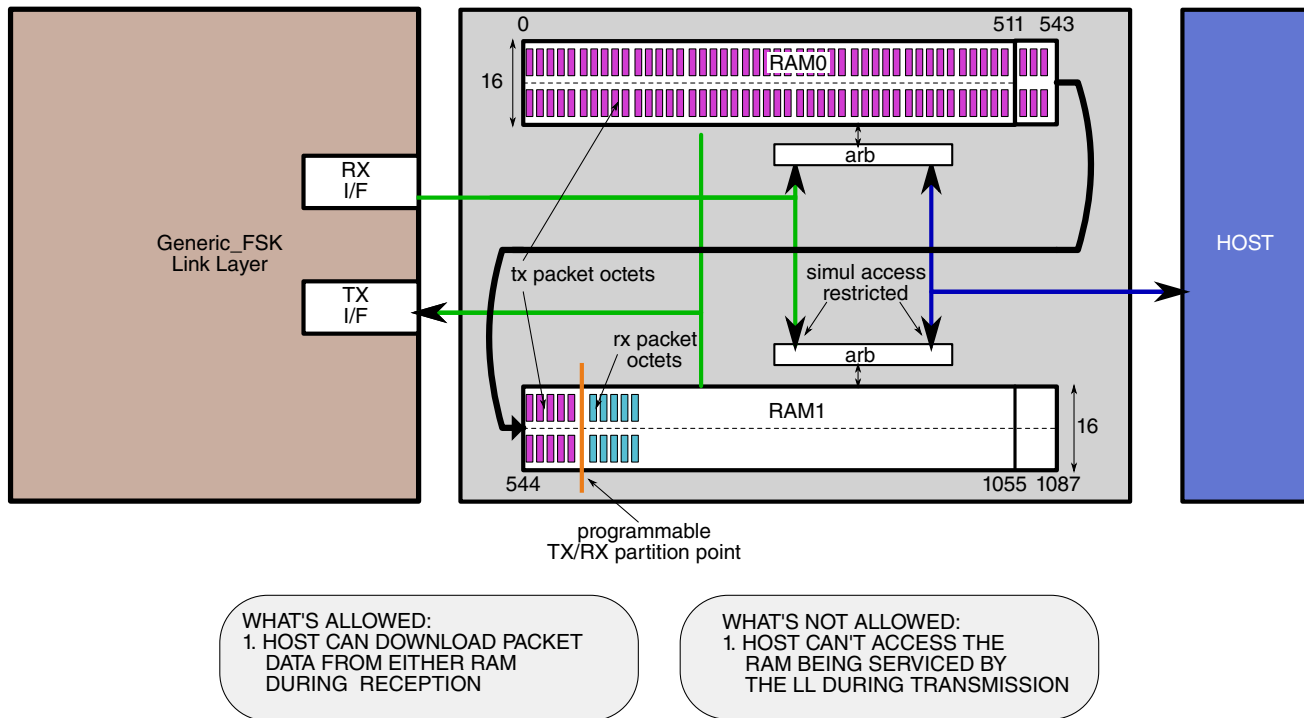

Figure 45-122. RAM ALLOCATIONS FOR GENERIC_FSK

During packet reception, the MCU is allowed to access the RX packet buffer of the consolidated RAM, in order to download the packet while it's being received, if so desired. In cases where both the MCU and the GENERIC_FSK Link Layer controller attempt to simultaneously access the RAM during reception, internal hardware arbitration is provided to delay the MCU access until the GENERIC_FSK Link Layer completes its access to the RAM. Link Layer accesses complete in a single reference oscillator clock period, so one and only 1 wait state shall be inserted on the IPS bus whenever access attempts coincide.

During packet transmission, MCU access to the consolidated RAM is not allowed. The GENERIC_FSK software must program the TX buffer before commanding a TX operation, and must not access the RAM during the transmission.

As mentioned previously, incoming receive data lands in the RX section of the Packet Buffer. Nominally, a newly received packet will overwrite the contents of the previously received packet (the TX section of the Packet Buffer remains intact). Software can inhibit receive-packet overwriting of the RX section of the Packet Buffer contents by setting the PB_PROTECT bit in the PACKET_RAM_CTRL register, in XCVR address space. When this bit is set, incoming receive data will be blocked from overwriting the existing contents of the RX section of the Packet Buffer. This will block RX packet overwriting, but will not inhibit TX content loading of the TX section of the Packet Buffer.

In the 2.4GHz Radio, the GENERIC_FSK Link Layer is the controlling Link Layer whenever the XCVR_CTRL[PROTOCOL] register is set to 8 or 9. GENERIC_FSK software must not attempt to access the Packet RAM unless XCVR_CTRL[PROTOCOL] is set to 8 or 9. When XCVR_CTRL[PROTOCOL] is set to one of the following: {0, 1, 2, 3, 4, or 5}, another Protocol Engine besides GENERIC_FSK, has exclusive access to the Packet RAM. That means also, that the IPS bus assigned to that Protocol Engine, is the only IPS bus allowed to access the Packet RAM. If the GENERIC_FSK Link Layer software attempts to access the Packet RAM via the GENERIC_FSK IPS bus, when XCVR_CTRL[PROTOCOL] is set to one of the above settings, the access attempt will fail, as described below:

1. RAM contents shall not be altered on a GENERIC_FSK write attempt
2. Readback data on a GENERIC_FSK read attempt shall be indeterminate
3. The **ips_xfr_err** shall be asserted on the GENERIC_FSK IPS bus

If XCVR_CTRL[PROTOCOL] is set to neither {8 or 9}, nor {0, 1, 2, 3, 4, or 5}, this means no Protocol Engine has exclusive access to the Packet RAM. GENERIC_FSK software should not attempt to access the Packet RAM under such conditions; results are indeterminate.

45.6.3.3.4 Timebase

The GENERIC_FSK Link Layer includes a dedicated, 24-bit multi-purpose Event Timer (EVENT_TMR), that is updated at a 1 MHz rate. The EVENT_TMR maintains the timebase for all GENERIC_FSK-related activities, except during intervals of Deep Sleep Mode. The clock source for the EVENT_TMR is a high-precision, crystal-referenced RF Oscillator, which can be either 32MHz or 26MHz. The RF Oscillator is divided down to 1MHz for GENERIC_FSK in the Clocks Generation Module (CGM). To reduce power consumption to a minimum, most of the GENERIC_FSK Link Layer Controller runs off this 1MHz clock. The exceptions are the Register IP bus interface, Command Decoder, and Interrupt Control Unit, parts of which must run at the IP bus frequency.

The 24-bit EVENT_TMR running at 1 MHz rolls over (wraps around) approximately every 16.8 seconds.

The EVENT_TMR count can be read at any time, via the register of the same name. A 32-bit read is recommended to ensure coherency of the 3 bytes that make up the counter. No synchronization to the IP bus is required.

If the EVENT_TMR needs to be updated (changed), this can be done by writing the new, desired EVENT_TMR value to the register of the same name, and setting the EVENT_TMR_LD bit to 1. The update to EVENT_TMR will take effect at the next

1MHz clock edge. The EVENT_TMR[23:0] and EVENT_TMR_LD are all part of the same 32-bit register, and loading of the EVENT_TMR using this method should be performed as an atomic, 32-bit write.

If it is desired to increment the EVENT_TMR by a known amount, this can be done by writing the desired increment value to the EVENT_TMR register, and setting the EVENT_TMR_ADD bit to 1. The increment value is 24-bit signed, thus enabling a decrement function as well. The update to EVENT_TMR will take effect immediately. The EVENT_TMR_ADD avoids the necessity to perform a read-modify-write operation to the EVENT_TMR to adjust its value; this facilitates accurate restoration of the EVENT_TMR state after a period of Deep Sleep Mode. The EVENT_TMR[23:0] and EVENT_TMR_ADD are all part of the same 32-bit register, and incrementing of the EVENT_TMR using this method should be performed as an atomic, 32-bit write.

Two 24-bit timer-compare registers are provided, T1_CMP and T2_CMP.

GENERIC_FSK software may load T1_CMP with a future EVENT_TMR count value. When EVENT_TMR reaches the T1_CMP value, either (or both) of the following events can be triggered:

1. T1_IRQ (Interrupt)
2. Sequence Command Trigger (can automatically launch or stop a transceiver operation)

Similarly, GENERIC_FSK software may load T2_CMP with a future EVENT_TMR count value. When EVENT_TMR reaches the T2_CMP value, either (or both) of the following events can be triggered:

1. T2_IRQ(Interrupt)
2. Sequence Command Trigger (can automatically launch or stop a transceiver operation)

For either type of T1-triggered events to be enabled, i.e., interrupt or sequence-launch, set T1_CMP_EN=1 after loading T1_CMP with the desired value. If T1_CMP_EN=1, the T1_IRQ interrupt status bit will always become set on a T1 timer match. (Whether or not T1_IRQ generates an GENERIC_FSK Interrupt to the MCU depends on the settings of T1_IRQ_EN and GENERIC_FSK_IRQ_EN, see section: Interrupts). If T1_CMP_EN=0, neither an interrupt nor a sequence command can be triggered by a T1 match.

For either T2-triggered events to be enabled, i.e., interrupt or sequence launch, set T2_CMP_EN=1 after loading T2_CMP with the desired value. If T2_CMP_EN=1, the T2_IRQ interrupt status bit will always become set on a T2 timer match. (Whether or not T2_IRQ generates a GENERIC_FSK Interrupt to the MCU depends on the settings of T2_IRQ_EN and GENERIC_FSK_IRQ_EN, see Section: Interrupts). If T2_CMP_EN=0, neither an interrupt nor a sequence command can be triggered by a T2 match.

See Section [Interrupts](#) for a description of how the Link Layer Controller manages the T1 and T2 interrupts, and how software can clear them.

See Section [Sequence Commands and Status](#) for a description on how to launch and stop sequences on T1 and T2 timer matches.

45.6.3.3.5 Sequence Commands and Status

The GENERIC_FSK Link Layer Controller provides a command set of 12 transceiver commands, which can be used to launch and stop sequences. GENERIC_FSK software can issue sequence commands by writing to the SEQCMD[3:0] field of the XCVR_CTRL register. The SEQCMD field always reads back what was previously written by software, enabling software to quickly recall the last command written. The sequence commands are as listed in the table below:

| SEQCMD[3:0] | COMMAND | DESCRIPTION |
|-------------|--------------|---|
| 0x0 | NULL | No Action |
| 0x1 | TX_START_NOW | TX Start Now |
| 0x2 | TX_START_T1 | TX Start @ T1 Timer Compare Match (EVENT_TMR = T1_CMP) |
| 0x3 | TX_START_T2 | TX Start @ T2 Timer Compare Match (EVENT_TMR = T2_CMP) |
| 0x4 | TX_CANCEL | TX Cancel -- Cancels pending TX events but do not abort TX-in-progress ¹ |
| 0x5 | RX_START_NOW | RX Start Now |
| 0x6 | RX_START_T1 | RX Start @ T1 Timer Compare Match (EVENT_TMR = T1_CMP) |
| 0x7 | RX_START_T2 | RX Start @ T2 Timer Compare Match (EVENT_TMR = T2_CMP) |
| 0x8 | RX_STOP_T1 | RX Stop @ T1 Timer Compare Match (EVENT_TMR = T1_CMP) |
| 0x9 | RX_STOP_T2 | RX Stop @ T2 Timer Compare Match (EVENT_TMR = T2_CMP) |
| 0xA | RX_CANCEL | RX Cancel -- Cancels pending RX events but do not abort RX-in-progress ² |
| 0xB | ABORT | Abort All - Cancels all pending events and abort any sequence-in-progress |

1. TX-in-progress implies TX Warmup is complete, and packet transmission is underway (i.e., command decoder state = IN_TX)
2. RX-in-progress implies RX Warmup is complete, and Network Address search or packet reception is underway (i.e., command decoder state = IN_RX)

As described above, sequences can be launched immediately (actually on the next 1MHz clock edge) by issuing one of the following commands:

- TX_START_NOW
- RX_START_NOW

Alternatively, sequences can be scheduled to launch (or stop) in the future on a T1 timer compare, by loading T1_CMP with the desired launch time (relative to the EVENT_TMR), setting T1_CMP_EN=1, and then issuing one of the following commands:

- TX_START_T1
- RX_START_T1
- RX_STOP_T1

Similarly, sequences can be scheduled to launch (or stop) in the future on a T2 timer compare, by loading T2_CMP with the desired launch time (relative to the EVENT_TMR), setting T2_CMP_EN=1, and then issuing one of the following commands:

- TX_START_T2
- RX_START_T2
- RX_STOP_T2

Any transceiver sequence that has been launched, either immediately (by way of the *_NOW commands), or in the future (by way of the *_T1 or *_T2 commands), can be terminated immediately by issuing the ABORT command. This is true whether or not the sequence has actually begun, or is merely pending because the T1- (or T2-) match has not yet occurred. In either case, this is called a software abort. The ABORT command will terminate any active sequence and cancel any pending events.

Regarding the issuance of sequence commands, both immediate and timer-triggered, GENERIC_FSK software should be mindful of the following Guidelines and Restrictions:

| PROGRAMING GUIDELINES AND RESTRICTIONS | |
|--|--|
| 1 | T1 can only be assigned to 1 function at a time {TX_START, RX_START, RX_STOP}. Once assigned to a function, attempts to change the assignment will be ignored |
| 2 | T2 can only be assigned to 1 function at a time {TX_START, RX_START, RX_STOP}. Once assigned to a function, attempts to change the assignment will be ignored |
| 3 | To change a T1- or T2- assignment, do one of the following first: a. issue an ABORT command |

Table continues on the next page...

| PROGRAMING GUIDELINES AND RESTRICTIONS | |
|--|--|
| | <p>b. issue an TX_CANCEL command if T1 (or T2) is already assigned to TX_START, and the sequence has not yet started</p> <p>c. issue an RX_CANCEL command if T1 (or T2) is already assigned to RX_START or RX_STOP, and the sequence has not yet started</p> |
| 4 | T1 and T2 should not be assigned to the same function (results are indeterminate) |
| 5 | If T1 and T2 are both assigned to functions, then T1_CMP shall not be equal to T2_CMP (results are indeterminate) |
| 6 | <p>If any TX or RX sequence is underway (e.g., TSM not idle), the ongoing sequence will not be interrupted or perturbed by any of the following:</p> <p>a. a T1 timer-match with T1 assigned to a function. The sequence trigger will be ignored, but the associated "pending" status bit will be cleared.</p> <p>b. a T2 timer-match with T2 assigned to a function. The sequence trigger will be ignored, but the associated "pending" status bit will be cleared.</p> <p>c. a TX_START_NOW or RX_START_NOW command. Both commands will be ignored</p> |

To perform operations on an RF channel, the GENERIC_FSK Link Layer Controller interacts with the Transceiver Sequence Manager (TSM), which is responsible for the low-level signaling required to activate the individual RF blocks. To do this, the Link Layer Controller includes a Command Decoder. The Command Decoder translates sequence commands (e.g., TX_START_NOW, RX_STOP_T1) into TSM inputs required to start and stop sequences. Then, the TSM executes the warmup, TX, RX, and warmdown functions on the channel. The GENERIC_FSK Command Decoder sends 2 signals (mutually exclusive) to the TSM:

- generic_fsk_tx_en
- generic_fsk_rx_en

Upon receiving an assertion on either of these signals, TSM will launch into warmup on either a TX or RX sequence. When the TSM completes its warmup, it asserts the signal **tsm_wu_complete** back to the Command Decoder, which uses that signal to transition into full-on packet transmit or packet receive. When the packet transmission or reception is complete, the Command Decoder will deassert **generic_fsk_tx_en** (or **generic_fsk_rx_en**), and wait for the TSM to assert **tsm_idle**. At that point, the Command Decoder will return to its IDLE state.

To implement these functions, the Command Decoder includes a small (6-state) finite state machine. The state diagram is shown below, including the TSM interactions.

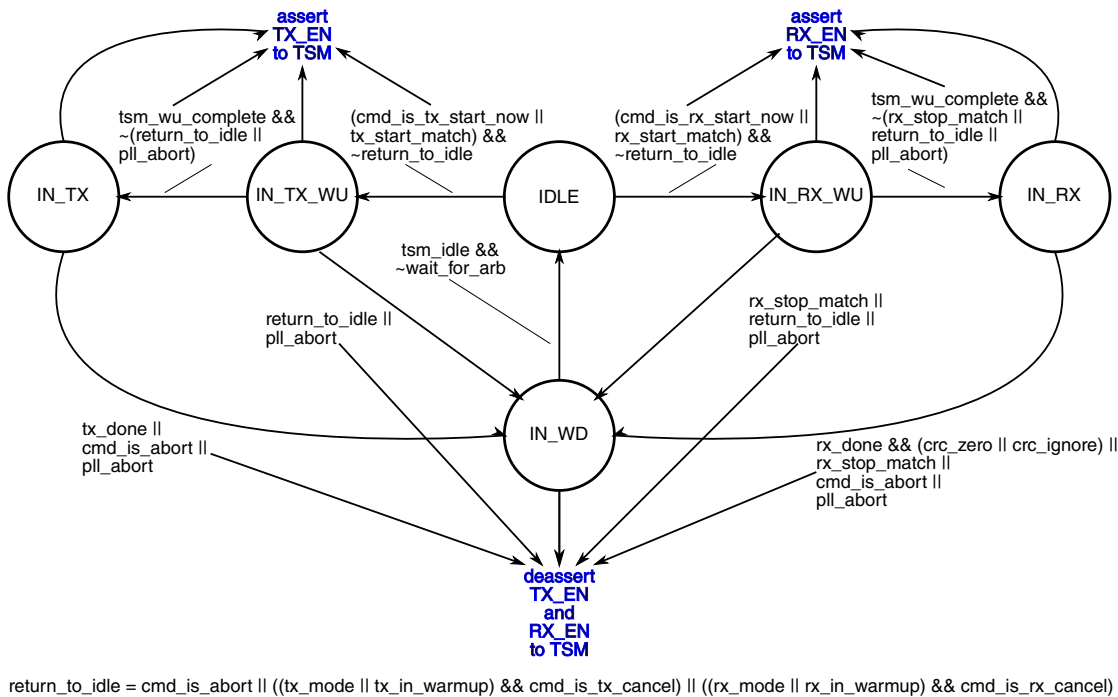

Figure 45-123. GENERIC COMMAND DECODER FSM

The state of the Command Decoder is carried by the state vector CMDDEC_CS[2:0]. The state can be monitored at all times by reading the CMDDEC_CS field of the XCVR_STATUS register, or via DTEST. The mapping of states to state vector is shown in the table below.

| CMDDEC_CS[2:0] | STATE NAME |
|----------------|------------|
| 0b000 | IDLE |
| 0b001 | IN_TX_WU |
| 0b011 | IN_TX |
| 0b101 | IN_RX_WU |
| 0b111 | IN_RX |
| 0b010 | IN_WD |

The Command Decoder also maintains an set of 13 status bits, that make it easy for Link Layer software to track, not only state, but pending events; that is, timer-linked events scheduled for future triggering. These status bits reside in the XCVR_STS register. A description of these bits is provided in the table below.

| SEQSTS[12:0] | BIT | DESCRIPTION |
|------------------|-----|--|
| TX_START_T1_PEND | [0] | TX Sequence will start @ next T1 Match |

Table continues on the next page...

Link Layer

| SEQSTS[12:0] | BIT | DESCRIPTION |
|------------------|------|---|
| TX_START_T2_PEND | [1] | TX Sequence will start @ next T2 Match |
| TX_IN_WARMUP | [2] | TX Sequence in TSM Warmup |
| TX_IN_PROGRESS | [3] | TX Packet Transmission Currently Underway |
| TX_IN_WARMDN | [4] | TX Sequence in TSM Warmdown |
| RX_START_T1_PEND | [5] | RX Sequence will start @ next T1 Match |
| RX_START_T2_PEND | [6] | RX Sequence will start @ next T2 Match |
| RX_STOP_T1_PEND | [7] | RX Sequence will stop @ next T1 Match |
| RX_STOP_T2_PEND | [8] | RX Sequence will stop @ next T2 Match |
| RX_IN_WARMUP | [9] | RX Sequence in TSM Warmup |
| RX_IN_SEARCH | [10] | RX Sequence in Network Address Search |
| RX_IN_PROGRESS | [11] | RX Packet Reception Currently Underway |
| RX_IN_WARMDN | [12] | RX Sequence in TSM Warmdown |

45.6.3.3.6 Interrupts

Interrupt Status Bit Structure

The Generic FSK Link Layer Controller has 10 interrupt sources, each represented in the register map by an interrupt status bit. All interrupt status bits share a common, generic structure. If a particular interrupt source is enabled, a “TRIGGERING EVENT” for that interrupt source, will always set the status bit. A write-1-to-clear input from the IPS bus, will clear the status bit, but only if there is not a simultaneous triggering event. The triggering event prevails over a software clear attempt, if both events coincide. An integrated clock gate guarantees that the status bit only sees a clock when either a triggering event occurs, or a write-1-to-clear pulse arrives from the IPS bus. This reduces interrupt status bit power consumption to an absolute minimum. (Note: the TSM_IRQ does not have an associated status bit in the Link Layer Controller; its status bit resides in the Transceiver Sequence Manager, or TSM).

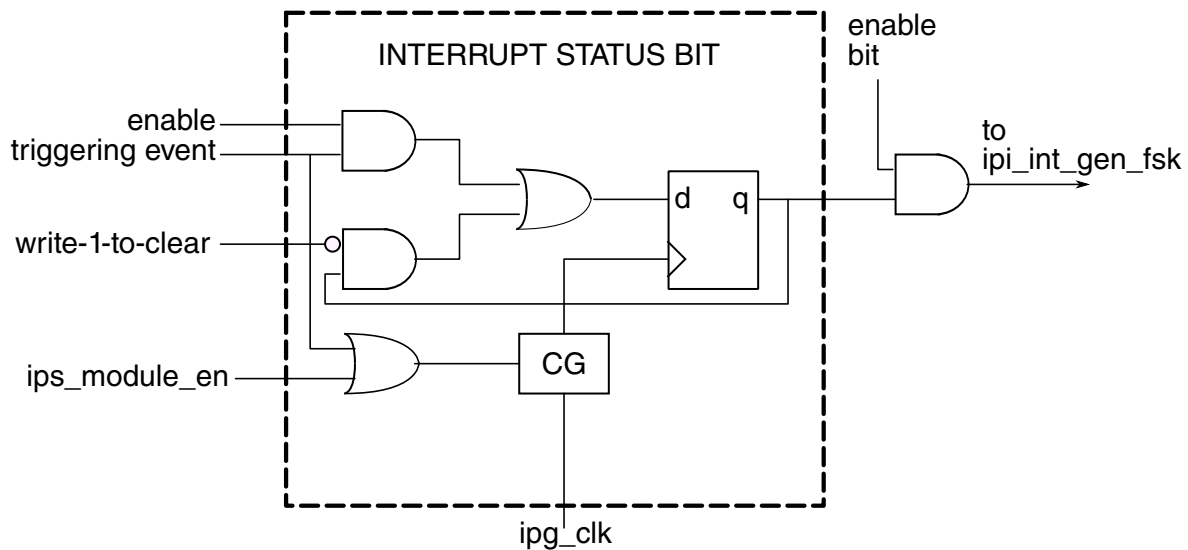

Figure 45-124. Interrupt Status Bit

Each GENERIC_FSK interrupt status bit, has an ENABLE bit associated with it. The name of the enable bit tracks the name of the interrupt source, with the string “_EN” appended at the end. Note that for any GENERIC_FSK interrupt source, if the triggering event occurs, the Interrupt Status Bit will be set regardless of the state of the corresponding ENABLE bit. If any of the 10 interrupts is to be ignored, software should clear the corresponding ENABLE bit, and apply the appropriate bit mask when reading the IRQ_CTRL register, to mask out the unwanted status bit.

GENERIC_FSK Interrupt Architecture

The 10 interrupt sources (status bits) are combined with their individual ENABLE bits, and then logically OR’ed together, in sum-of-products fashion, to generate single interrupt line to the MCU: **ipi_int_gen_fsk**. A global mask bit, **GENERIC_FSK_IRQ_EN**, can enable or disable **ipi_int_gen_fsk** altogether. There is no prioritization of interrupt sources; they have equal weight. The **ipi_int_gen_fsk** output is a level-sensitive indicator and will remain asserted until all interrupt status bits are cleared (or the corresponding ENABLE bits cleared). The following diagram depicts the GENERIC_FSK Interrupt Architecture.

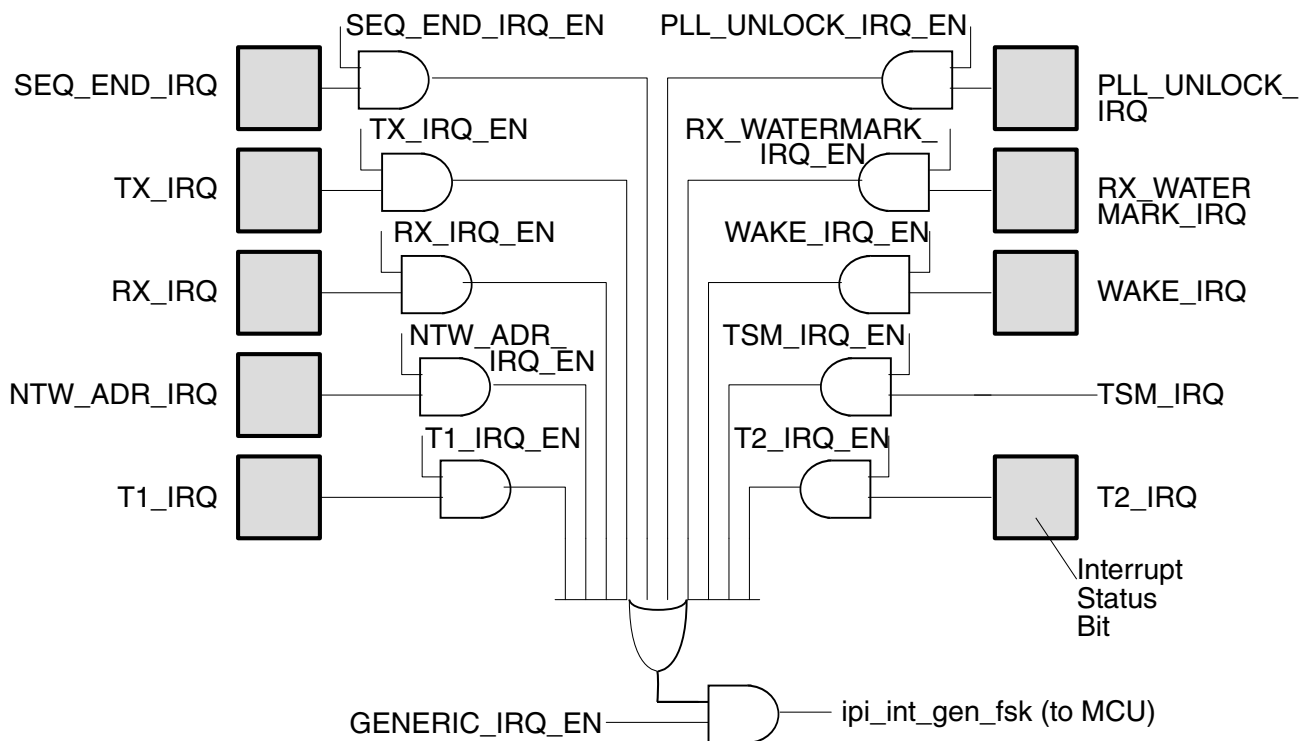

Figure 45-125. GENERIC_FSK Interrupt Architecture

Clearing Interrupts

All interrupt status bit use a write-1-to-clear protocol. Writing a ‘1’ to the interrupt status bit, in the IRQ_CTRL register, clears the offending interrupt. Writing a ‘0’ to an interrupt status bit has no effect on the bit. Interrupt status bits are not affected by reads.

GENERIC FSK Interrupt Sources

The following table describes the 10 GENERIC_FSK Interrupt Sources

| Interrupt | Description |
|----------------|---|
| T1_IRQ, T2_IRQ | The GENERIC_FSK Link Layer features a 24-bit Event Timer, which runs at a rate of 1MHz. The Link Layer has 2 Timer interrupts (T1_IRQ, T2_IRQ), each with its own 24-bit compare register (T1_CMP, T2_CMP), and each with its own compare enable (T1_CMP_EN, T2_CMP_EN). For each timer compare enable, if the bit is set, a match on the respective 24-bit compare value to the Event Timer will cause the corresponding interrupt status bit to become set. If the compare enable is not set, Event Timer matches won't cause the corresponding interrupt status bit to become set. |
| TX_IRQ | TX interrupt occurs at the end of a TX operation. |
| RX_IRQ | RX interrupt occurs at the end of a successful RX packet reception. A successful packet reception implies CRC was verified to be good, H0 matching passed, H1 matching passed, and received packet length did not violate pre-set |

Table continues on the next page...

| Interrupt | Description |
|------------------|--|
| | limits. Nominally, RX interrupts are not generated on packets which fail CRC check, or which failure the H0, H1 or LENGTH limits. A received packet with a failed CRC check or a H0, H1, or LENGTH violation, results in an RX recycle back to the Network Address Search state. To receive a Data Indication (RX_IRQ) on packets which fail CRC, set the bit CRC_IGNORE=1. H0 and H1 matching, and LENGTH limiting, are under SW control. |
| NTW_ADR_IRQ | A Network Address Match has occurred on an enabled Network Address. At NTW_ADR_IRQ, a timestamp is captured by transferring the current contents of the EVENT_TMR into the TIMESTAMP register. Software can determine which Network Address matched by querying the NTW_ADR_MCH[3:0] field of the NTW_ADR_CTRL register. |
| SEQ_END_IRQ | The Sequence End Interrupt (SEQ_END_IRQ), indicates that a transceiver operation (TX or RX) has completed, and the Command Decoder State Machine, and the Transceiver Sequence Manager (TSM), have returned to their respective IDLE states. A SEQ_END_IRQ will always occur at the end of a sequence, even if the sequence terminated abnormally (such as a Software Abort, or a PLL Unlock Abort). A SEQ_END_IRQ always occurs whenever the Command Decoder FSM transitions from any non-idle to IDLE state. When SEQ_END_IRQ occurs, software can be sure that the Command Decoder and TSM are in their idle state, and a new sequence can be programmed. |
| RX_WATERMARK_IRQ | RX Watermark interrupt will occur during packet reception, when the number of received bytes, as indicated by the read-only BYTE_COUNTER register, matches the contents of the RX_WATERMARK register. For the purpose of defining RX_WTR_MARK, the first byte received (BYTE_COUNTER = 0) is the first byte of Network Address; the second byte received (BYTE_COUNTER = 1) is the second byte of Network Address, etc. To cause an RX Watermark Interrupt to occur after a 2-byte Network Address has been received, set RX_WTR_MARK=1. By default, RX_WATERMARK is set to a value larger than the longest supported GENERIC_FSK packet length, so an RX_WATERMARK_IRQ won't be triggered under these conditions. |
| PLL_UNLOCK_IRQ | When an PLL unlock event occurs during an transceiver operation, and the transceiver has been configured to automatically abort sequences on PLL unlock events, the PLL_UNLOCK_IRQ status bit will become set. The Transceiver Sequence Manager (TSM) will begin monitoring for PLL unlock only after the PLL has been given sufficient time to achieve lock; A PLL unlock which occurs after the warmup period, can be enabled to cause a sequence abort. Individual enables are provided for TX and RX sequences. (See the TSM Block Guide for more details). |
| WAKE_IRQ | A WAKE_IRQ will be triggered when the GENERIC_FSK Link Layer Controller has awoken from a DSM (Deep Sleep Mode) cycle. WAKE_IRQ indicates that the RF Oscillator has been restarted, and the GENERIC_FSK EVENT_TMR has resumed counting. |

Table continues on the next page...

| Interrupt | Description |
|-----------|---|
| TSM_IRQ | TSM_IRQ is a debug feature, enabling the Transceiver Sequence Manager (TSM) to generate an interrupt at any point in a TX or RX Warmup. TSM is a multipurpose hardware resource shared by all of the protocol engines in the SoC. Thus, TSM does not have its own interrupts; its interrupts are assigned to whichever link layer controller is currently executing an RF operation. TSM Interrupt Status bits reside in Transceiver (XCVR) Address Space, and can be cleared there. There is no intended mission-mode use for TSM_IRQ. See the TSM Block Guide for more details. |

45.6.3.3.7 Memory Mapping

In the SoC memory map, space has been allocated to GENERIC_FSK. Within the SoC, peripherals are allocated memory space in 4KB blocks, called IPS slots. GENERIC_FSK occupies one such slot. GENERIC_FSK address space consists of the GENERIC_FSK registers. The partitioning of address space for GENERIC_FSK is shown in the diagram below.

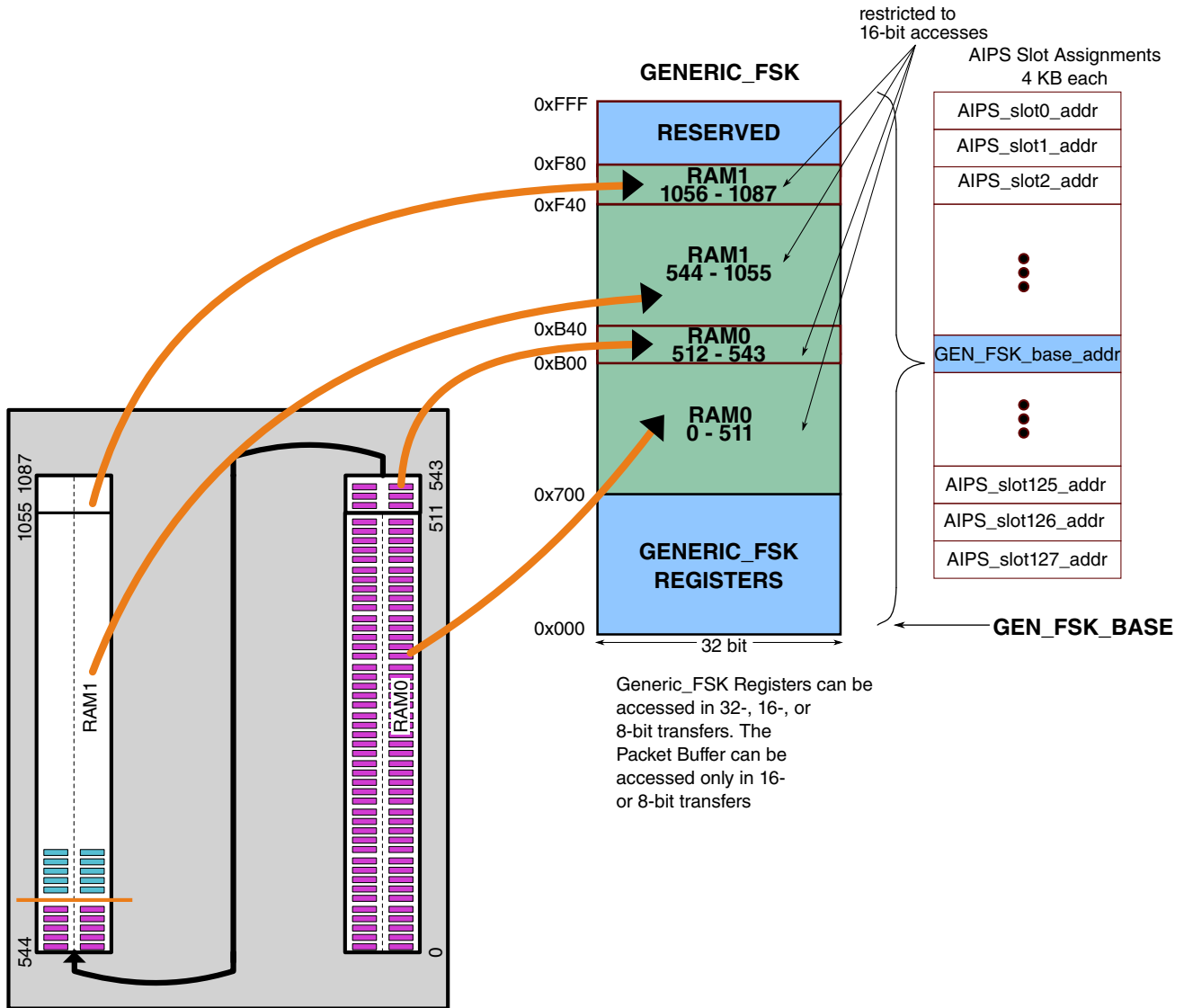

Figure 45-126. GENERIC_FSK MEMORY MAPPING

NOTE

See AIPS Memory Map for specific memory assignments details.

All registers within GENERIC_FSK memory space, are accessible by the MCU in 8-, 16-, or 32-bit accesses. For efficiency, 32-bit accesses are recommended.

45.6.3.3.8 Sequence Timing Diagrams

The following timing diagram depicts an example of GENERIC_FSK packet transmission, highlighting the following events:

1. Software stores packet octets into Packet Buffer, to be transmitted

Link Layer

2. Software loads T1_CMP with desired TX start time, sets T1_CMP_EN=1
3. Software schedules TX sequence with TX_START_T1 command
4. EVENT_TMR matches T1_CMP, TX sequence starts automatically
5. Generic_FSK Link Layer reads octets from Packet Buffer. Packet is transmitted
6. TX_IRQ asserts after last bit of packet transmitted
7. SEQ_END_IRQ asserts after TSM returns to IDLE (TX warmdown complete)

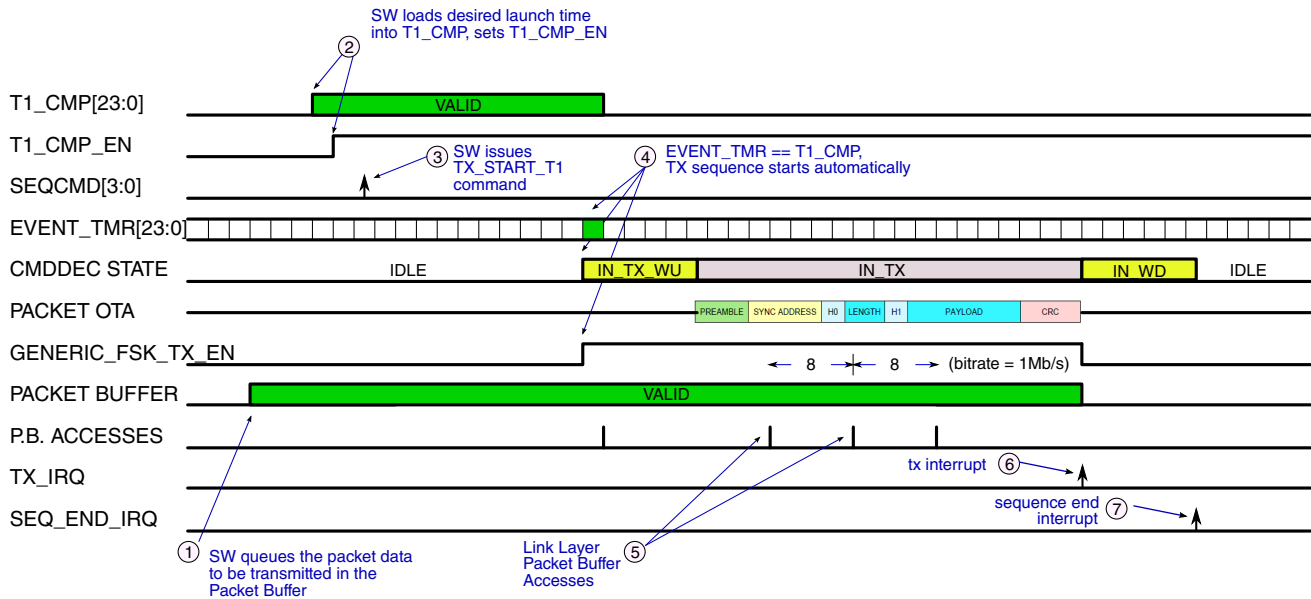

Figure 45-127. GENERIC FSK TX SEQUENCE: LAUNCH VIA T1 TIMER

The following timing diagram depicts an example of GENERIC_FSK “good” packet reception, highlighting the following events:

1. Software loads T2_CMP with desired RX start time, sets T2_CMP_EN=1
2. Software schedules RX sequence with RX_START_T2 command
3. EVENT_TMR matches T2_CMP, RX sequence starts automatically
4. Network Address search, followed by NTW_ADR_IRQ interrupt, TIMESTAMP capture
5. Packet reception, Generic_FSK LL write octets to Packet Buffer
6. CRC verification passes, and no H0, H1, or LENGTH_MAX violations, RX_IRQ asserted, Packet RX Buffer valid, RSSI valid
7. SEQ_END_IRQ asserts after TSM returns to IDLE (RX warmdown complete)

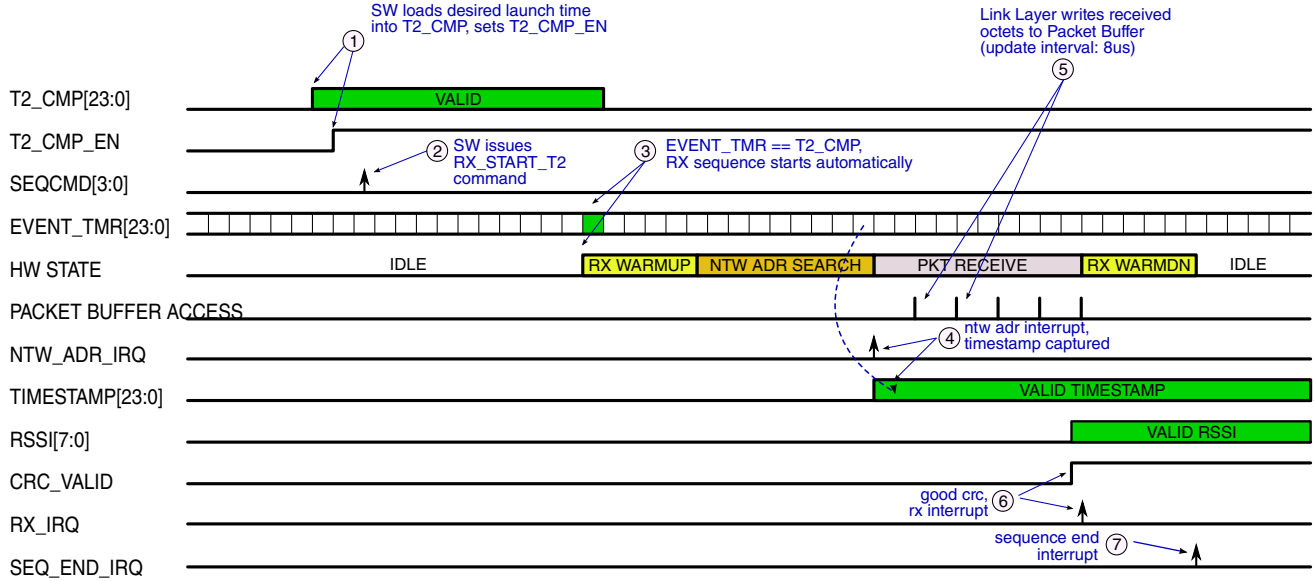

Figure 45-128. GENERIC FSK RX SEQUENCE: LAUNCH VIA T2 TIMER, GOOD PACKET

The following timing diagram depicts an example of GENERIC_FSK “bad” packet reception, highlighting the following events:

1. Software loads T2_CMP with desired RX start time, sets T2_CMP_EN=1
2. Software schedules RX sequence with RX_START_T2 command
3. EVENT_TMR matches T2_CMP, RX sequence starts automatically
4. Network Address search, followed by NTW_ADR_IRQ interrupt, TIMESTAMP capture
5. Packet reception, Generic_FSK LL write octets to Packet Buffer
6. CRC verification fails, no CRC_VALID, no RX_IRQ, RX Recycle
7. No SEQ_END_IRQ, return to Network Address Search

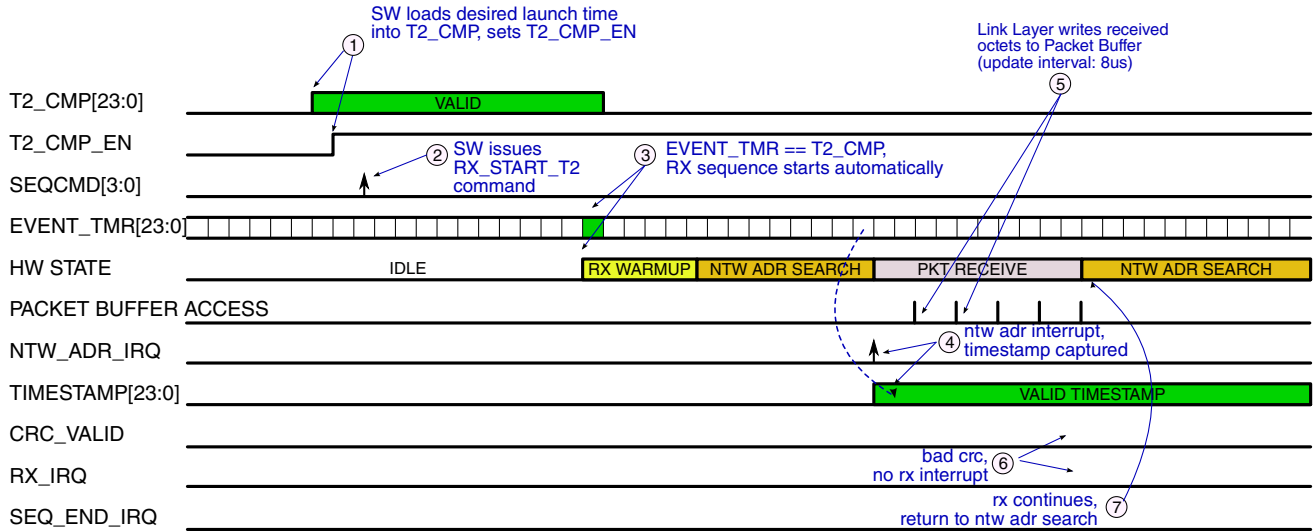

Figure 45-129. GENERIC FSK RX SEQUENCE: LAUNCH VIA T2 TIMER, BAD PACKET, RX RECYCLE

The following timing diagram depicts a GENERIC_FSK RX search operation, which fails to detect a Network Address before timing out. The following events are highlighted:

1. Software loads T1_CMP with desired RX start time, sets T1_CMP_EN=1
2. Software loads T2_CMP with desired RX stop time, sets T2_CMP_EN=1
3. Software schedules RX sequence start with RX_START_T1 command
4. Software schedules RX sequence end with RX_START_T2 command
5. EVENT_TMR matches T1_CMP, RX sequence starts automatically
6. EVENT_TMR matches T2_CMP, RX sequence goes into warmdown automatically
7. SEQ_END_IRQ asserts to indicate TSM has returned to IDLE. No NTW_ADR_IRQ, No RX_IRQ.

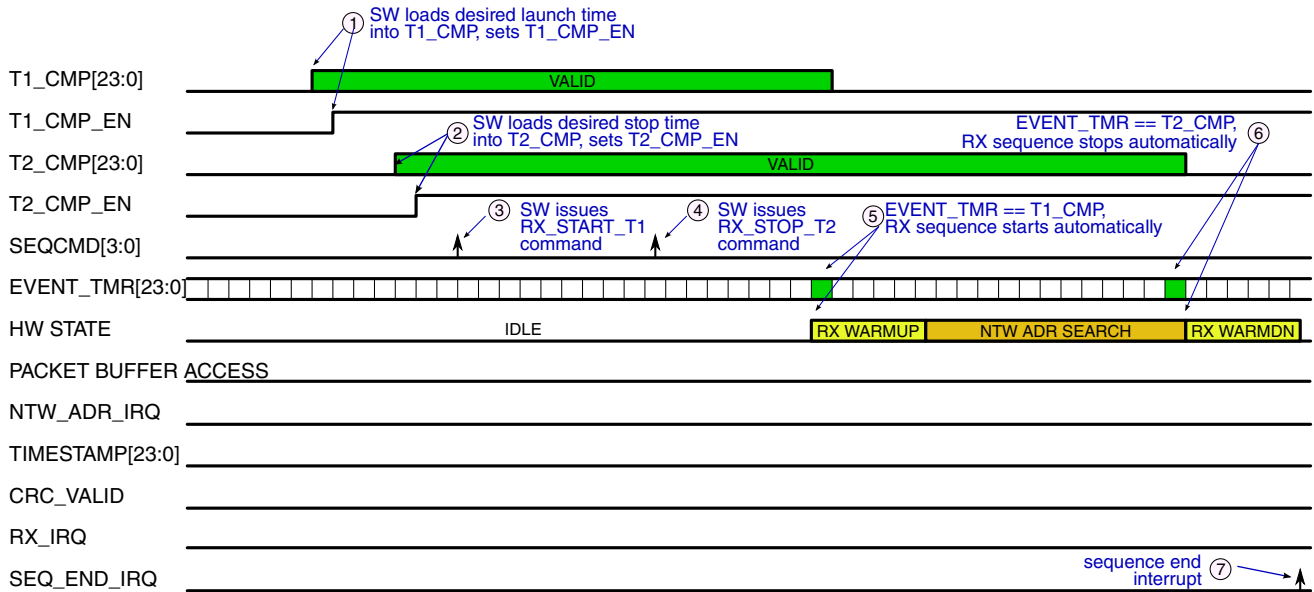

Figure 45-130. GENERIC FSK RX SEQUENCE: SLAVE CHANNEL SEARCH, LAUNCH VIA T1, STOP VIA T2

45.6.3.3.9 Deep Sleep Mode

When the GENERIC_FSK Link Layer anticipates long periods of inactivity, the Link Layer controller can be put into a Deep Sleep Mode (DSM), where all of its clocks are turned off. In addition, the GENERIC_FSK Link Layer can be configured to optionally turn off the RF Oscillator, if it is not otherwise needed by the SoC. Deep Sleep Mode results in dramatic power savings.

To make possible Deep Sleep Mode, the transceiver incorporates a low-frequency, high-precision Deep Sleep Timer, DSM_TIMER. This timer is clocked by a crystal-referenced 32.768KHz oscillator. The timer is 24-bit wide, yielding a 8.5 minute rollover (the maximum length of a deep sleep period). The DSM_TIMER resides in the RSIM module.

The hardware to implement DSM within the SoC, is partitioned across several modules, and several power domains. This is to allow the maximum achievable power savings, by retaining full voltage for only those modules which need to be active in DSM, and placing the remaining modules in “state retention” mode. The diagram below depicts the partitioning of DSM hardware across the various modules, including the GENERIC_FSK Link Layer Controller.

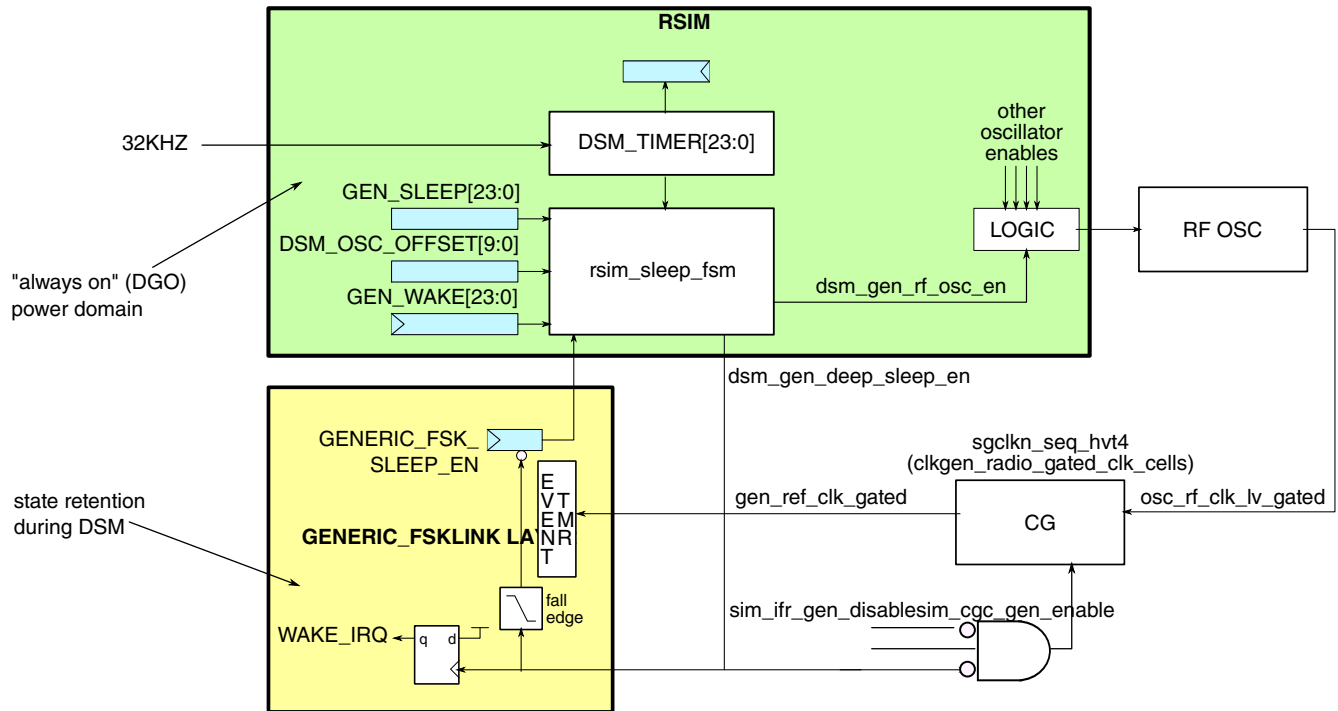

Figure 45-131. Deep Sleep Mode

The concept behind DSM, as it is implemented for GENERIC_FSK, is to allow the GENERIC_FSK timebase to be maintained for a period of time, while the RF Oscillator is turned off and much of the SoC is placed in state-retention. During DSM, the timebase management is temporarily transferred from the GENERIC_FSK EVENT_TMR to the low-power DSM_TIMER, and after DSM exit, timebase management is transferred back to the EVENT_TMR. During DSM, the EVENT_TMR is frozen. The total time spent in DSM is known to software, so that upon exiting DSM, the EVENT_TMR can be updated to correct for the precise amount of time it was frozen.

DSM entry and exit, and RF Oscillator re-start during DSM, are governed by 5 registers, as described in the table below.

| Field | R/W | Description |
|---------------------|-----|---|
| GEN_SLEEP[23:0] | rw | If DSM_CTRL[GENERIC_FSK_SLEEP_EN]=1, enter DSM and freeze EVENT_TMR when GEN_SLEEP matches DSM_TIMER. NOTE: This register resides in RSIM Address Space |
| DSM_OSC_OFFSET[9:0] | rw | Awaken SoC, start the RF Oscillator when: $(GEN_WAKE - DSM_OSC_OFFSET) = DSM_TIMER$ |

Table continues on the next page...

| Field | R/W | Description |
|----------------------|-----|---|
| | | NOTE: This register resides in RSIM Address Space |
| GEN_WAKE[23:0] | rw | Exit Deep Sleep Mode, and resume EVENT_TMR, when GEN_WAKE matches DSM_TIMER NOTE: This register resides in RSIM Address Space |
| GENERIC_FSK_SLEEP_EN | w | Enable a match on GEN_SLEEP[23:0] to DSM_TIMER[23:0], to enter Deep Sleep Mode, by writing a 1 to this bit. This bit is write-only, and always reads back 0. Writing a 0 to this bit has no effect. This bit resides in the DSM_CTRL register of GENERIC_FSK address space. |
| DSM_TIMER[23:0] | r | Current State of the 32KHz Sleep Timer NOTE: This register resides in RSIM Address Space |

Procedure

The procedure to schedule a DSM cycle (entry/exit) as well as to program the desired RF Oscillator re-start time, and the calculation to restore the GENERIC_FSK EVENT_TMR after a DSM cycle, is described below.

1. Software determines the future time at which it would like to enter DSM, by reading the DSM_TIMER, computing the number of 32KHz clock cycles remaining until the desired DSM start-time, and writing this value into GEN_SLEEP register. The value programmed into GEN_SLEEP should be no fewer than 4 clocks greater (in the future) than the current time as read from DSM_TIMER.
2. Software determines the future time at which it would like to exit DSM, by computing the number of 32KHz clock cycles remaining until the desired DSM exit-time, and writing this value into GEN_WAKE register.
3. The DSM_OSC_OFFSET register should be pre-programmed with the number of 32KHz required for oscillator re-start. This should be done during initial SoC configuration and should not need to be updated during this procedure. **Note:** When programming GEN_WAKE, software must ensure that the following 2 equations are true:

$$\text{GEN_WAKE} - \text{DSM_OSC_OFFSET} > \text{DSM_TIMER} + 4$$

$$\text{GEN_WAKE} - \text{DSM_OSC_OFFSET} > \text{GEN_SLEEP}$$

4. Software writes a 1 to DSM_CTRL[GENERIC_FSK_SLEEP_EN]. This bit resides in GENERIC_FSK address space. This bit is write-only and always reads back 0. Writing this bit to 1 enables a DSM cycle to commence using the values programmed into GEN_SLEEP and GEN_WAKE.

5. MCU can go into a low power state (e.g., wait-for-interrupt to enter STOP)
6. When `DSM_TIMER = GEN_SLEEP`, the `EVENT_TMR` will be clock-gated so that it will remain frozen at its current count. The RF Oscillator will be turned off (unless overridden due to a non-`GENERIC_FSK`-related SoC requirement)
7. All hardware not in the low-voltage domain will be placed into state-retention (or other low-power state).
8. When `DSM_TIMER = (GEN_WAKE – DSM_OSC_OFFSET)`, the parts of the SoC in low-power state will be returned to normal operation, and the RF Oscillator will be re-started. (`DSM_OSC_OFFSET` will be programmed with a sufficient value to allow the oscillator to stabilize before clocks are released to the `GENERIC_FSK` Link Layer)
9. When `DSM_TIMER = GEN_WAKE`, clocking of the `GENERIC_FSK` Link Layer Controller will resume and the `EVENT_TMR` will be ungated (allowed to resume counting).
10. When `DSM_TIMER = GEN_WAKE`, the `WAKE_IRQ` status bit of `IRQ_CTRL` bit will be asserted, and will generate an interrupt to the MCU if `IRQ_CTRL[WAKE_IRQ_EN]=1`. Clear `WAKE_IRQ` by writing a '1' to the bit location.
11. Software computes the time that the SoC was in DSM (and hence the time the `EVENT_TMR` was frozen), in microseconds, with the equation:
$$(\text{GEN_WAKE} - \text{GEN_SLEEP}) / 32768 * 1000000$$
12. Software increments the `EVENT_TMR` by this amount, by writing this value to `EVENT_TMR[23:0]` register with `EVENT_TMR_ADD=1`.
13. On the next 1MHz clock edge, the `EVENT_TMR` has been restored to where it would have been, had no DSM occurred, with 0.5-microsecond accuracy.

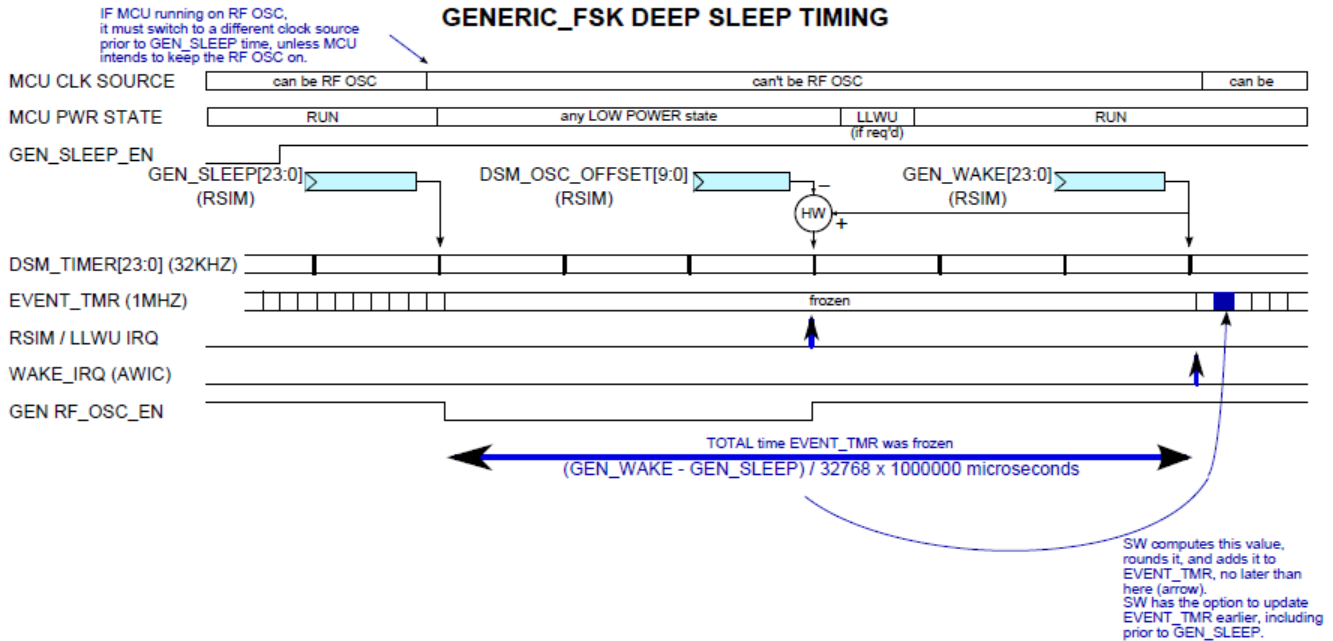

Figure 45-132. GENERIC FSK Deep Sleep Mode Timing

Note: If the DSM low power state selected by the SoC is VLLS, the SIM_CGC bit for GENERIC_FSK will be cleared, and must be re-established in the LLWU ISR (not the WAKE_IRQ ISR, which would be too late)

45.6.3.3.10 Multi-protocol Arbitration

The GENERIC_FSK Link Layer controller may be included in an SoC that includes similar controllers for other protocols (e.g., Bluetooth Low Energy). GENERIC_FSK may be required to operate simultaneously with other protocols on the SoC, and there are scenarios where both protocol engines require access to the RF channel at the same time.

To assist in software arbitration between GENERIC_FSK and other protocols, the read-only status bit XCVR_BUSY has been included in the XCVR_STS register. When this bit is set, this indicates that the RF channel is currently in use (TSM is busy), by one of the Radio's four link layer controllers. When this bit is clear, the RF channel is available to GENERIC_FSK (TSM is idle).

Chapter 46

Revision History

46.1 Revision History

Table 46-1. MKW41Z Revision History

| Rev. No. | Date | Substantial Changes |
|----------|---------|---|
| 3 | 03/2018 | <ul style="list-style-type: none"> • Added Flashloader chapter • Updated Figure 3-9. Boost Power Tree • Added Flash Access Control Introduction chapter • Updated section 3.6.1.5 Erase All Flash Contents • Updated Flash Mass Erase in Progress description in Table 10-3. MDM-AP Control register assignments • Updated Flash Mass Erase Acknowledge description in Table 10-4. MDM-AP Status register assignments • Updated PSWITCH information in section 15.4 Functional description • Updated DCDC_VDD1P5CTRL_TRG_BOOST bit field description in section 15.7.5 DCDC register 3 (DCDC_REG3) to match datasheet updates • Updated DCDC_VDD1P8CTRL_TRG bit field description in section 15.7.5 DCDC register 3 (DCDC_REG3) to match datasheet updates |
| 2 | 07/2017 | <ul style="list-style-type: none"> • Added WLCSP details. • Updated DCDC chapter. |
| 1 | 10/2016 | Initial Public Release |

How to Reach Us:

Home Page:

nxp.com

Web Support:

nxp.com/support

Information in this document is provided solely to enable system and software implementers to use NXP products. There are no express or implied copyright licenses granted hereunder to design or fabricate any integrated circuits based on the information in this document. NXP reserves the right to make changes without further notice to any products herein.

NXP makes no warranty, representation, or guarantee regarding the suitability of its products for any particular purpose, nor does NXP assume any liability arising out of the application or use of any product or circuit, and specifically disclaims any and all liability, including without limitation consequential or incidental damages. "Typical" parameters that may be provided in NXP data sheets and/or specifications can and do vary in different applications, and actual performance may vary over time. All operating parameters, including "typicals" must be validated for each customer application by customer, customer's technical experts. NXP does not convey any license under its patent rights nor the rights of others. NXP sells products pursuant to standard terms and conditions of sale, which can be found at the following address: nxp.com/SalesTermsandConditions.

NXP, the NXP logo, NXP SECURE CONNECTIONS FOR A SMARTER WORLD, Freescale, the Freescale logo, and Kinetis are trademarks of NXP B.V. All other product or service names are the property of their respective owners. Arm, the Arm Powered logo, and Cortex, AMBA, Thumb, TrustZone, and NEON are registered trademarks of Arm Limited (or its subsidiaries) in the EU and/or elsewhere. All rights reserved.

© 2016-2018 NXP B.V.

Document Number MKW41Z512RM
Revision 3, 03/2018

