

Ultralow capacitance ESD protection for high speed interface

Features

- 2-line TVS diodes
- Ultralow capacitance 0.6 pF typ.
- 1.0 x 0.8 mm package
- 0.4 mm pitch
- Lead-free package

Benefits

- Flow-through layout
- Easy to implement
- Low profile: 0.55mm height max
- Very low PCB space: only 0.8 mm²

Complies with following standards

- IEC 61000-4-2 level 4:
 - 15 kV (air discharge)
 - 8 kV (contact discharge)

Applications

Where transient over-voltage protection in ESD sensitive equipment is required, such as:

- Computers
- Printers
- Communication systems
- Cellular phone handsets and accessories
- Video equipment

Description

The USBULC6-2N4 is a monolithic application specific discrete device dedicated to ESD protection of high speed data buses.

The device is available in the μ QFN-4L package.



Figure 1. Configuration (top view)

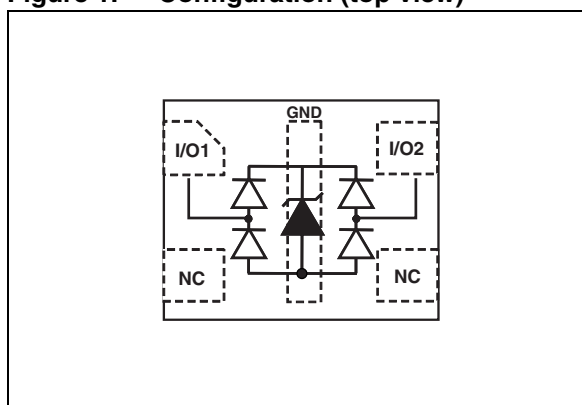
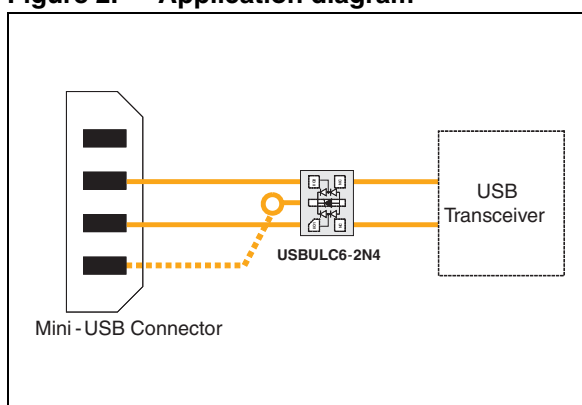

Figure 2. Application diagram



1 Characteristics

Table 1. Absolute maximum ratings $T_{amb} = 25\text{ }^{\circ}\text{C}$

Symbol	Parameter	Value	Unit
V_{PP}	ESD discharge IEC 61000-4-2, level 4		
	Contact discharge	12	kV
	Air discharge	15	
I_{pp}	Peak pulse current (8/20 μs)	4	A
P_{pp}	Peak pulse power dissipation (8/20 μs)	50	W
T_j	Operating temperature range	-40 to + 150	$^{\circ}\text{C}$
T_{stg}	Storage temperature range	-65 to +150	$^{\circ}\text{C}$
T_L	Maximum lead temperature for soldering during 10 s	260	$^{\circ}\text{C}$

Table 2. Electrical characteristics $T_{amb} = 25\text{ }^{\circ}\text{C}$, otherwise specified

Symbol	Parameter	Test conditions	Min.	Typ.	Max.	Unit
V_{BR}	LV diode breakdown voltage	$I_R = 1\text{ mA}$	6			V
I_{RM}	LV diode leakage current	$V_{RM} = 3\text{ V}$			100	nA
C	LV diode input capacitance	$V_R = 0\text{ V}$, F= 240 MHz to 3 GHz Any I/O pin to ground		0.6	0.75	pF
V_{CL}	LV diode clamping voltage	$I_{PP} = 1\text{ A}$, $t_p = 8/20\text{ }\mu\text{s}$ Any I/O pin to ground			10	V

Figure 3. Junction capacitance versus frequency ($V_R = 0\text{ V}$, typical values)

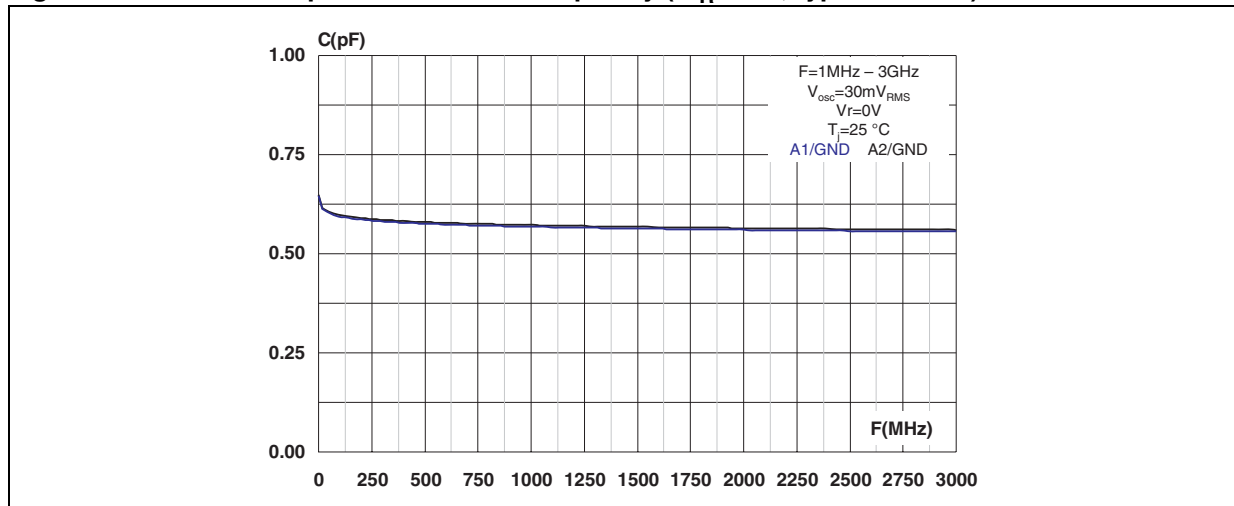

Figure 4. Variation of leakage current versus junction temperature (typical values)

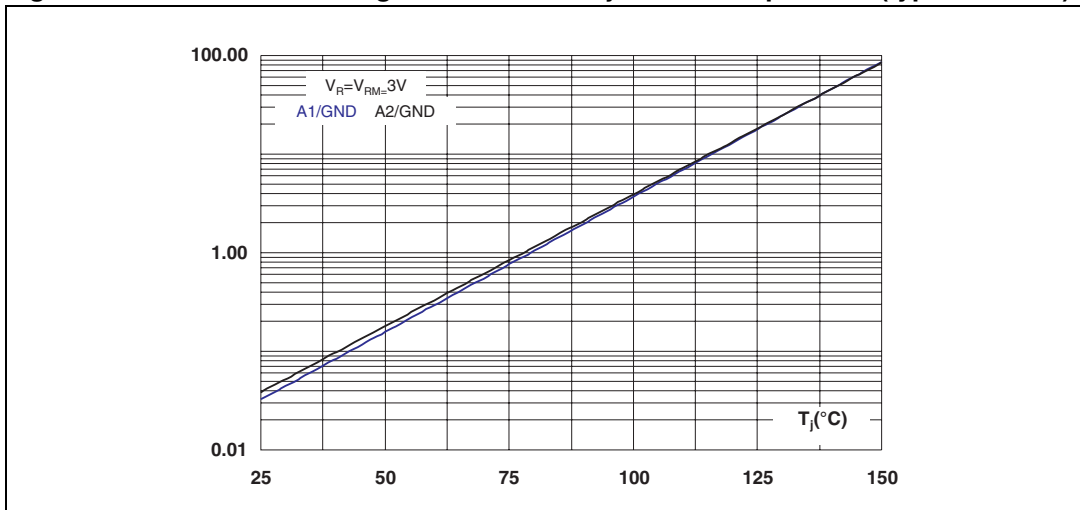

Figure 5. Attenuation measurement

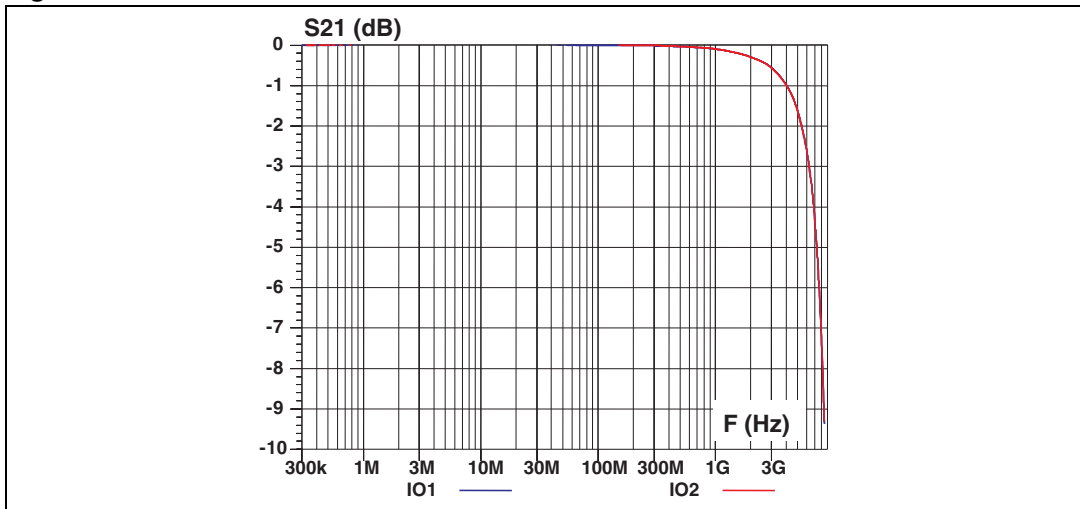

Figure 6. Eye diagram PCB only
400 mV amplitude, $F = 480$ Mbps

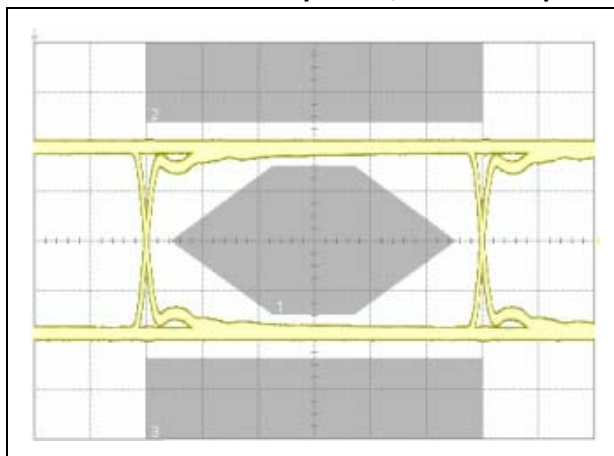

Figure 7. Eye diagram PCB + USBULC6-2N4
400 mV amplitude, $F = 480$ Mbps

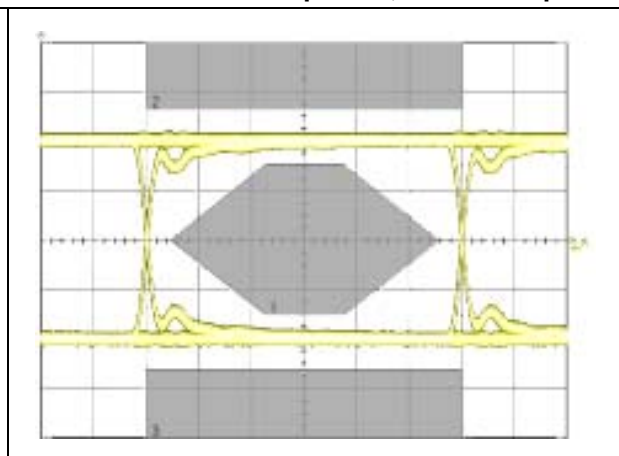

Figure 8. ESD response to IEC 61000-4-2 (+8 kV contact discharge) on one output $V_{(OUT)}$ and one input $V_{(IN)}$

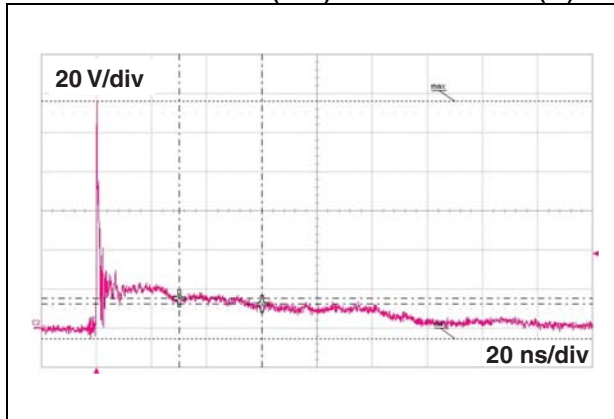
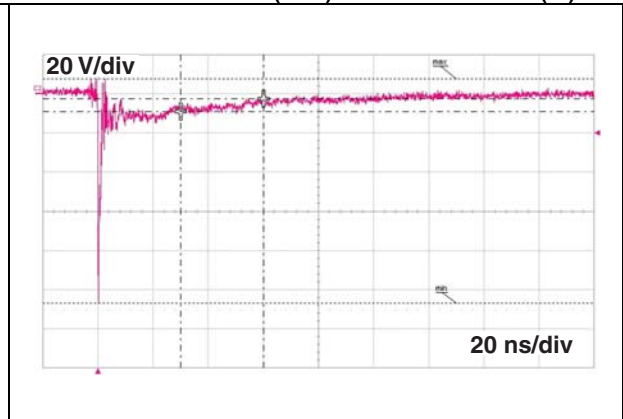
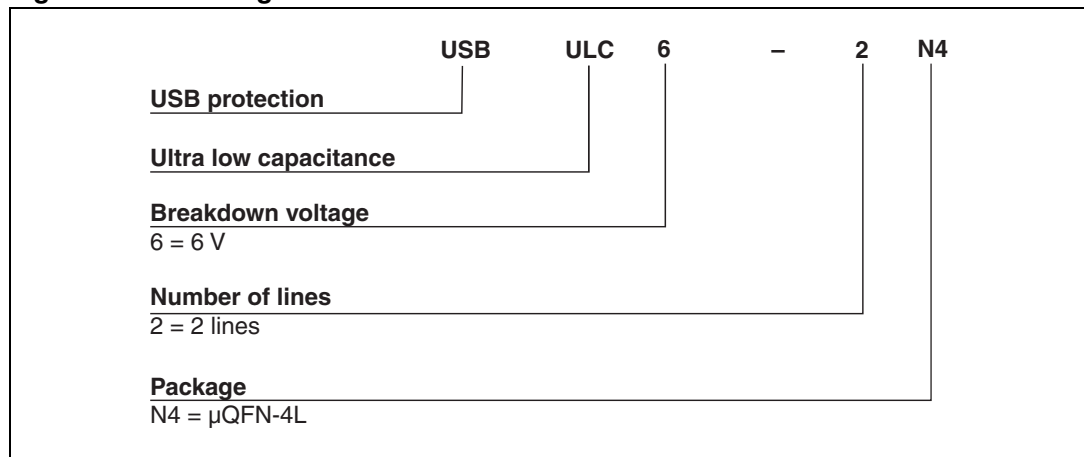

Figure 9. ESD response to IEC 61000-4-2 (-8 kV contact discharge) on one output $V_{(OUT)}$ and one input $V_{(IN)}$



2 Ordering information scheme

Figure 10. Ordering information scheme



3 Package information

- Epoxy meets UL94, V0
- Lead-free package

In order to meet environmental requirements, ST offers these devices in different grades of ECOPACK® packages, depending on their level of environmental compliance. ECOPACK® specifications, grade definitions and product status are available at: www.st.com. ECOPACK® is an ST trademark.

Table 3. μQFN-4L dimensions

Ref.	Dimensions					
	Millimeters			Inches		
	Min.	Typ.	Max.	Min.	Typ.	Max.
A	0.45	0.50	0.55	0.018	0.020	0.022
A1	0.00	0.02	0.05	0.000	0.001	0.002
b	0.15	0.20	0.25	0.006	0.008	0.010
D	0.75	0.80	0.85	0.030	0.031	0.033
D2	0.55	0.6	0.65	0.022	0.024	0.026
e	0.35	0.40	0.45	0.014	0.016	0.018
E	0.95	1.00	1.05	0.037	0.039	0.041
E2	0.15	0.20	0.25	0.006	0.008	0.010
k	0.17	0.20	0.23	0.007	0.008	0.009
L	0.15	0.20	0.25	0.006	0.008	0.010

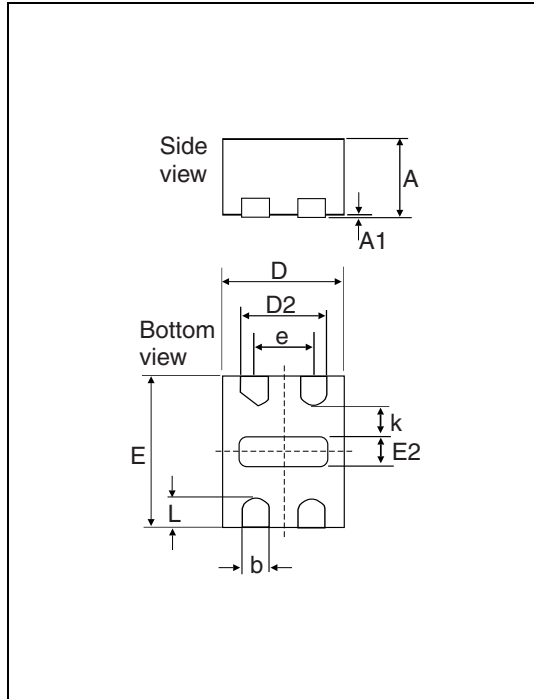

Figure 11. Footprint recommendations (dimensions in mm)

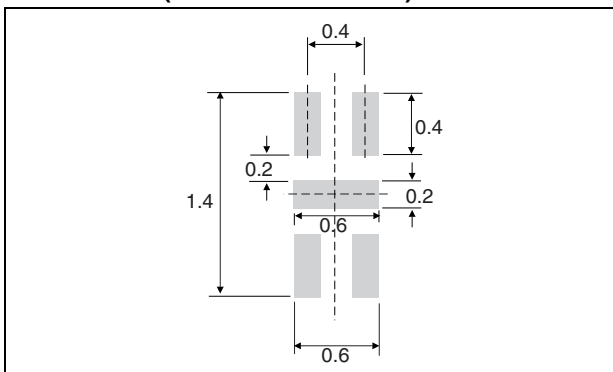
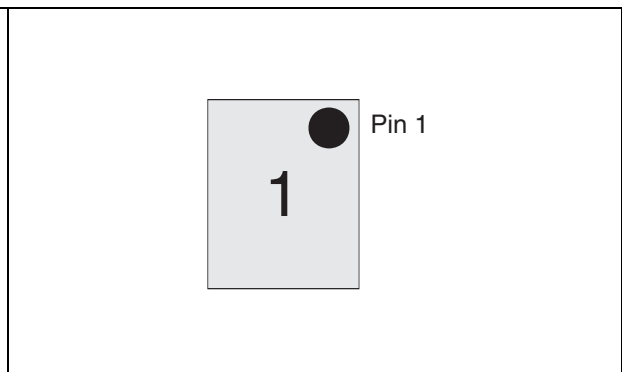
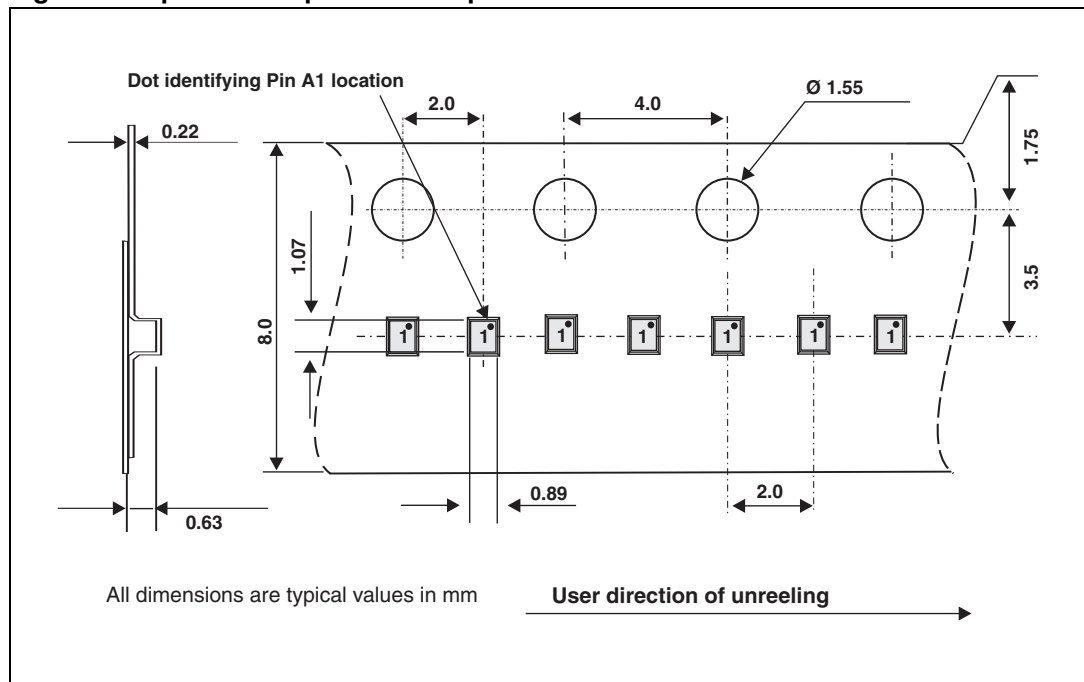

Figure 12. Marking



Note: Product marking may be rotated by 90° for assembly plant differentiation. In no case should this product marking be used to orient the component for its placement on a PCB. Only pin 1 mark is to be used for this purpose.

Figure 13. μ QFN-4L tape and reel specifications



4 Recommendation on PCB assembly

4.1 Stencil opening design

1. Reference design
 - a) Stencil opening thickness: 100 μm
 - b) Stencil opening for central exposed pad: Opening to footprint ratio is 50%.
 - c) Stencil opening for leads: Opening to footprint ratio is 90%.

Figure 14. Recommended stencil window position

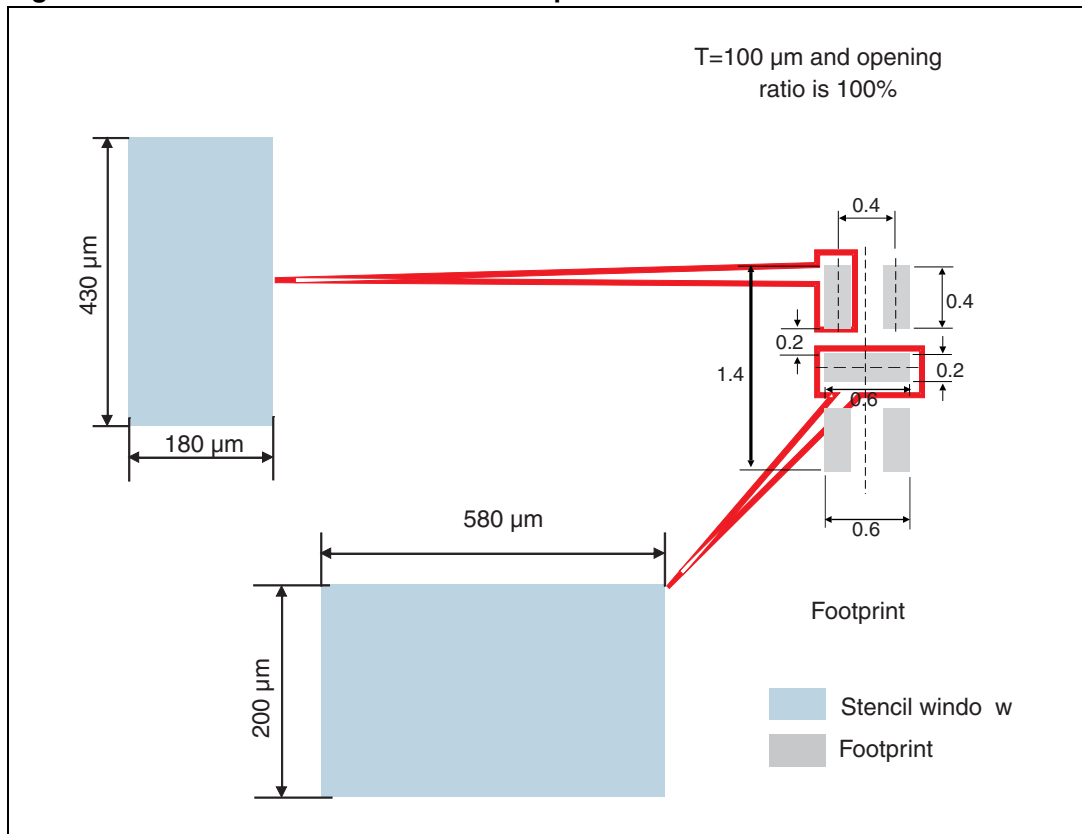

4.2 Solder paste

1. Halide-free flux qualification ROL0 according to ANSI/J-STD-004.
2. "No clean" solder paste is recommended.
3. Offers a high tack force to resist component movement during high speed.
4. Solder paste with fine particles: powder particle size is 20-45 μm .

4.3 Placement

1. Manual positioning is not recommended.
2. It is recommended to use the lead recognition capabilities of the placement system, not the outline centering.
3. Standard tolerance of ± 0.05 mm is recommended.
4. 3.5 N placement force is recommended. Too much placement force can lead to squeezed out solder paste and cause solder joints to short. Too low placement force can lead to insufficient contact between package and solder paste that could cause open solder joints or badly centered packages.
5. To improve the package placement accuracy, a bottom side optical control should be performed with a high resolution tool.
6. For assembly, a perfect supporting of the PCB (all the more on flexible PCB) is recommended during solder paste printing, pick and place and reflow soldering by using optimized tools.

4.4 PCB design preference

1. To control the solder paste amount, the closed via is recommended instead of open vias.
2. The position of tracks and open vias in the solder area should be well balanced. The symmetrical layout is recommended, in case any tilt phenomena caused by asymmetrical solder paste amount due to the solder flow away.

4.5 Reflow profile

Figure 15. ST ECOPACK® recommended soldering reflow profile for PCB mounting

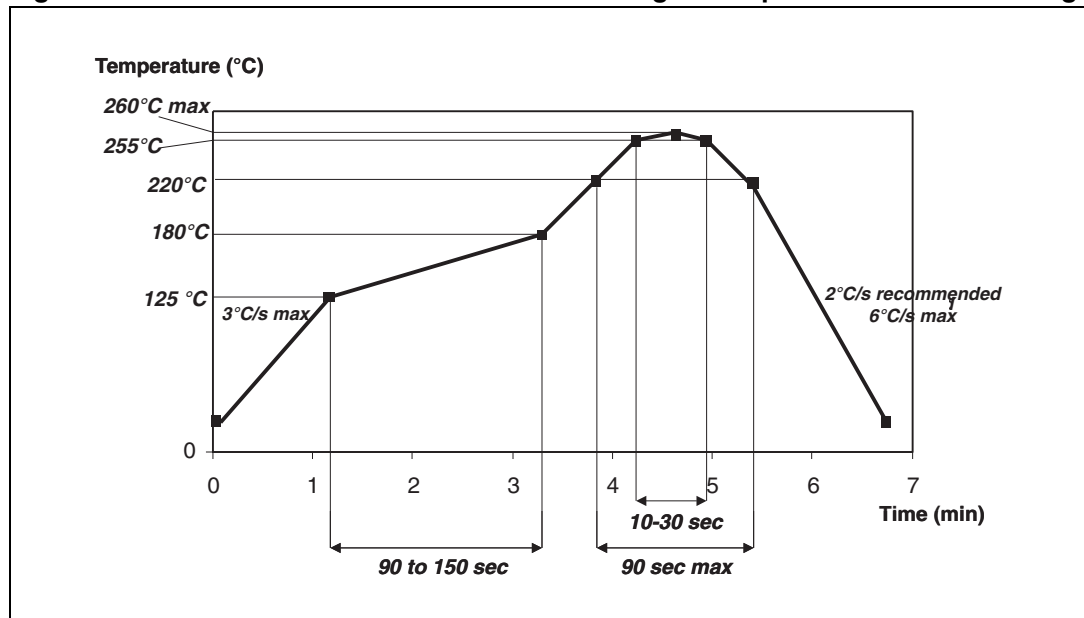

Note: Minimize air convection currents in the reflow oven to avoid component movement.

5 Ordering information

Table 4. Ordering information

Order code	Marking	Package	Weight	Base qty	Delivery mode
USBULC6-2N4	1 ⁽¹⁾	μQFN	1.17 mg	10000	Tape and reel (7")

1. The marking can be rotated by 90° to differentiate assembly location

6 Revision history

Table 5. Document revision history

Date	Revision	Changes
14-Sep-2011	1	Initial release.

Please Read Carefully:

Information in this document is provided solely in connection with ST products. STMicroelectronics NV and its subsidiaries ("ST") reserve the right to make changes, corrections, modifications or improvements, to this document, and the products and services described herein at any time, without notice.

All ST products are sold pursuant to ST's terms and conditions of sale.

Purchasers are solely responsible for the choice, selection and use of the ST products and services described herein, and ST assumes no liability whatsoever relating to the choice, selection or use of the ST products and services described herein.

No license, express or implied, by estoppel or otherwise, to any intellectual property rights is granted under this document. If any part of this document refers to any third party products or services it shall not be deemed a license grant by ST for the use of such third party products or services, or any intellectual property contained therein or considered as a warranty covering the use in any manner whatsoever of such third party products or services or any intellectual property contained therein.

UNLESS OTHERWISE SET FORTH IN ST'S TERMS AND CONDITIONS OF SALE ST DISCLAIMS ANY EXPRESS OR IMPLIED WARRANTY WITH RESPECT TO THE USE AND/OR SALE OF ST PRODUCTS INCLUDING WITHOUT LIMITATION IMPLIED WARRANTIES OF MERCHANTABILITY, FITNESS FOR A PARTICULAR PURPOSE (AND THEIR EQUIVALENTS UNDER THE LAWS OF ANY JURISDICTION), OR INFRINGEMENT OF ANY PATENT, COPYRIGHT OR OTHER INTELLECTUAL PROPERTY RIGHT.

UNLESS EXPRESSLY APPROVED IN WRITING BY TWO AUTHORIZED ST REPRESENTATIVES, ST PRODUCTS ARE NOT RECOMMENDED, AUTHORIZED OR WARRANTED FOR USE IN MILITARY, AIR CRAFT, SPACE, LIFE SAVING, OR LIFE SUSTAINING APPLICATIONS, NOR IN PRODUCTS OR SYSTEMS WHERE FAILURE OR MALFUNCTION MAY RESULT IN PERSONAL INJURY, DEATH, OR SEVERE PROPERTY OR ENVIRONMENTAL DAMAGE. ST PRODUCTS WHICH ARE NOT SPECIFIED AS "AUTOMOTIVE GRADE" MAY ONLY BE USED IN AUTOMOTIVE APPLICATIONS AT USER'S OWN RISK.

Resale of ST products with provisions different from the statements and/or technical features set forth in this document shall immediately void any warranty granted by ST for the ST product or service described herein and shall not create or extend in any manner whatsoever, any liability of ST.

ST and the ST logo are trademarks or registered trademarks of ST in various countries.

Information in this document supersedes and replaces all information previously supplied.

The ST logo is a registered trademark of STMicroelectronics. All other names are the property of their respective owners.

© 2011 STMicroelectronics - All rights reserved

STMicroelectronics group of companies

Australia - Belgium - Brazil - Canada - China - Czech Republic - Finland - France - Germany - Hong Kong - India - Israel - Italy - Japan - Malaysia - Malta - Morocco - Philippines - Singapore - Spain - Sweden - Switzerland - United Kingdom - United States of America

www.st.com