

Antenna Switch Module: BGSF1717MN26

Antenna Switch Module with integrated MIPI RFFE Interface, 2 GSMTX Ports for multi-mode GSM/EDGE, WCDMA or LTE Applications and Carrier Aggregation

Application Note AN384

About this document

Scope and purpose

This application note describes Infineon's Antenna Switch Module BGSF1717MN26 as main antenna switch module for multi-mode GSM/EDGE, WCDMA or LTE Applications and Carrier Aggregation applications.

1. This application notes gives an overview about main purpose of this SP7T Low Band + SP7T High Band Antenna Switch Module.
2. Multi-mode GSM/EDGE, WCDMA or LTE Applications and Carrier Aggregation are the primary application of this document.
3. The Printed Circuit Board (PCB) design as well as antenna matching network proposed in this note provides a customer oriented approach where a single ASM enables multi-mode GSM/EDGE, WCDMA or LTE and Carrier Aggregation applications
4. Key performance parameters include higher Isolation between input channels (~ 32 dB), integrated SAW Filter for LB and HB GSM Tx inputs, very low IL of the TX channels (0.5dB), integration of SP7T LB and SP7T HB in one module and an integrated MIPI RFFE Interface.

Table of Content

About this document	1
1 Introduction of BGSF1717MN26	5
1.1 Main Features	5
1.2 Functional Diagram.....	6
1.3 Pin Configuration	7
1.4 Pin Description	7
2 Application.....	9
3 Application Circuit of BGSF1717MN26	10
3.1 Application Board	10
3.2 Deembedding.....	11
3.2.1 Deembedding concept with a “prepared” SMA connector and a “Half-Thru” boardPort Extension	11
3.2.2 Deembedding control process	12
4 Small Signal Characteristics of BGSF1717MN26	13
4.1 Small Signal Parameters LB switch.....	13
4.1.1 Insertion Loss from LB Antenna to the respective RF TRX Port	13
4.1.2 Insertion Loss TX LB port	14
4.1.3 Insertion Loss high linearity ultra low IL TRx10 port	14
4.1.4 Return Loss from LB Antenna to the respective RF Port	15
4.1.5 Return Loss of LB TRX RF ports to LB Antenna	16
4.1.6 Return Loss TX LB RF port.....	16
4.1.7 Antenna to port and Port to Port Isolation LB path	18
4.2.6 Antenna to port and Port to Port Isolation HB path.....	25
5 Non-Linear performance of BGSF1717MN26.....	28
5.1 Intermodulation	28
5.1.1 Intermodulation Measurement Setup.....	29
5.1.2 Intermodulation Measurement conditions for Band I.....	30
5.1.3 Intermodulation Measurement Results for Band I	30
5.1.4 Intermodulation Measurement conditions for Band V.....	31
5.1.5 Intermodulation Measurement Results for Band V	31
5.2 Harmonic Distortion.....	32
5.2.1 Harmonic Generation Measurement conditions.....	32
5.2.2 Harmonic Generation Measurement Results of Low Band inputs	33
5.2.3 Harmonic Generation Measurement Results of High Band inputs	35
6 Switching time.....	36
7 Appendix: Switch Controller Unit.....	37
7.1 Operating Guide.....	37
7.2 Display Settings of the Controller Unit	38
8 Authors	39
Revision History	40

List of Figures

Figure 1	BGSF1717MN26 in TSNP-26-3.....	5
Figure 2	BGSF1717MN26 Functional Diagram.....	6
Figure 3	BGSF1717MN26 Pin Configuration	7
Figure 4	BGSF1717MN26 in mobile phone cellular frontend (typical discrete LTE-A feature set)	9
Figure 5	Layout of the application board	10
Figure 6	PCB Layer stack-up	10
Figure 7	“Half-Thru” deembedding board	12
Figure 8	“Full-Thru” deembedding board	12
Figure 9	Application circuit BGSF1717MN26	13
Figure 10	Forward transmission from LB Antenna to TX LB port	13
Figure 11	Forward transmission from LB Antenna to TX LB port	14
Figure 12	Forward transmission from LB Antenna to TRX10 port	15
Figure 13	Return Loss from LB Antenna to the respective TRX LB RF port	15
Figure 14	Return Loss of LB TRX RF ports to LB Antenna	16
Figure 15	Return Loss port TX LB RF port	17
Figure 16	Return Loss of high linearity ultra low IL TRX10 RF port	17
Figure 17	Worst case Antenna to Port Isolation Low Band part.....	20
Figure 18	Worst case Port to Port Isolation Low Band part ¹	20
Figure 19	Forward transmission from HB Antenna to the respective TRX HB RF port	21
Figure 20	Forward transmission from HB Antenna to the respective TX HB RF port	22
Figure 21	Return Loss from HB Antenna to the respective TRX HB RF port.....	23
Figure 22	Return Loss from HB TRX RF ports to HB Antenna.....	24
Figure 23	Return Loss of HB TX RF port	24
Figure 24	Worst case Antenna to Port Isolation High Band part	27
Figure 25	Worst case Port to Port Isolation High Band part ¹	27
Figure 26	Block diagram of RF Switch intermodulation	29
Figure 27	Intermodulation Measurement Test Setup.....	29
Figure 28	Intermodulation measurement results for Band I.....	30
Figure 29	Intermodulation measurement results for Band V.....	31
Figure 30	Harmonic Generation Measurement setup.....	32
Figure 31	Measurements of Harmonic power over Carrier power of Low-Band inputs to LB Antenna.....	33
Figure 32	Harmonic power measurements of high linear LB input TRX10 over the Band 17 carrier.....	34
Figure 33	Measurements of Harmonic power over Carrier power of High-Band inputs to HB Antenna	35
Figure 34	Switching time measurements of the TX_LB input to the LB Antenna	36
Figure 35	Switch Controller Unit Board.....	37

List of Tables

Table 1	Pin Description (top view).....	7
Table 2	Insertion Loss from LB Antenna to TX LB port	13
Table 3	Insertion loss from LB Antenna to TX LB port	14
Table 4	Insertion loss from LB Antenna to TRx10 port	14
Table 5	Return loss from LB Antenna to the respective TRX LB RF port	15
Table 6	Return loss from respective TRX LB RF port to LB Antenna	16
Table 7	Return loss from TR LB RF port.....	16
Table 8	Return loss from TRX10 RF port.....	17
Table 9	Worst case Antenna to Port Isolation High Band part	18
Table 10	Worst case Port to Port Isolation Low Band part.....	19
Table 11	Insertion Loss from HB Antenna to the respective TRX HB RF port	21
Table 12	Insertion Loss from HB Antenna to the respective TX HB RF	22
Table 13	Return Loss from HB Antenna to the respective TRX HB RF port	23
Table 14	Return Loss from HB TRX RF ports to HB Antenna	23
Table 15	Return Loss of HB TX RF port	24
Table 16	Worst case Antenna to Port Isolation High Band part	25
Table 17	Worst case Port to Port Isolation High Band part.....	26
Table 18	Test conditions and specifications of IMD measurements.....	30
Table 19	Typical and maximal value of intermodulation products in dBm for Band I.....	30
Table 20	Test conditions and specifications of IMD measurements.....	31
Table 21	Typical and maximal value of intermodulation products in dBm for Band V.....	31
Table 22	Harmonic Generation measurement Conditions	32
Table 23	Switching time values	36
Table 24	Seeting Display of Active RF Path, Power UP, Power Down and Isolation State.....	38

1 Introduction of BGSF1717MN26

For RF Front-End solutions that integrate new features such as downlink inter-band carrier aggregation to increase Downlink data rates, Antenna Switch Modules (ASMs) are facing new challenges. Two RF signals being transmitted in different frequency bands have to be routed from two different antennas – one dedicated for low frequency band and one for high frequency band - to the RF Transceiver at the same time. For this kind of application, the new switch which combines two SP7T ICs and the MIPI control interface, the so-called DP14T, have been introduced to the market.

The BGSF1717MN26 is a double Pole Fourteen Throw (DP14T / SP7T+SP7T) ASM optimized for wireless applications up to 2.7 GHz. It is a perfect solution for multi-mode handsets based on quad-band GSM, WCDMA, LTE and ideal for carrier aggregation solutions. TRX10 is designed to achieve ultra-high linearity. The ASM configuration is shown in the [Figure 2](#).

The module comes in a miniature TSNP package shown in the [Figure 1](#) and comprises of two high power SP7T switches with integrated MIPI RFFE interface and harmonic filters for GSM high and low band transmitter signal paths. The on-chip MIPI RFFE interface supports both 1.2 V and 1.8 V supply voltages. No external DC blocking capacitors are required in typical applications as long as no DC is applied to any RF port. The pin assignment can be found in the [Figure 3](#).

1.1 Main Features

- Suitable for multi-mode GSM / EDGE / C2K / WCDMA / LTE applications and carrier aggregation
- Operating from 0.1 to 2.7 GHz coverage
- Ultra-low insertion loss and harmonics generation
- Integrated GSM transmit filters
- 12 interchangeable, high-linearity WCDMA TRX ports
- Port TRX10 designed for ultra-high linearity

- 2 high-linearity GSM TX paths
- High port-to-port isolation
- Integrated MIPI RFFE interface
- No decoupling DC capacitors required, if no DC applied on RF lines
- Small form factor: 3.2 mm x 2.8 mm x 0.73 mm



Figure 1 BGSF1717MN26 package in TSNP-26-3

1.2 Functional Diagram

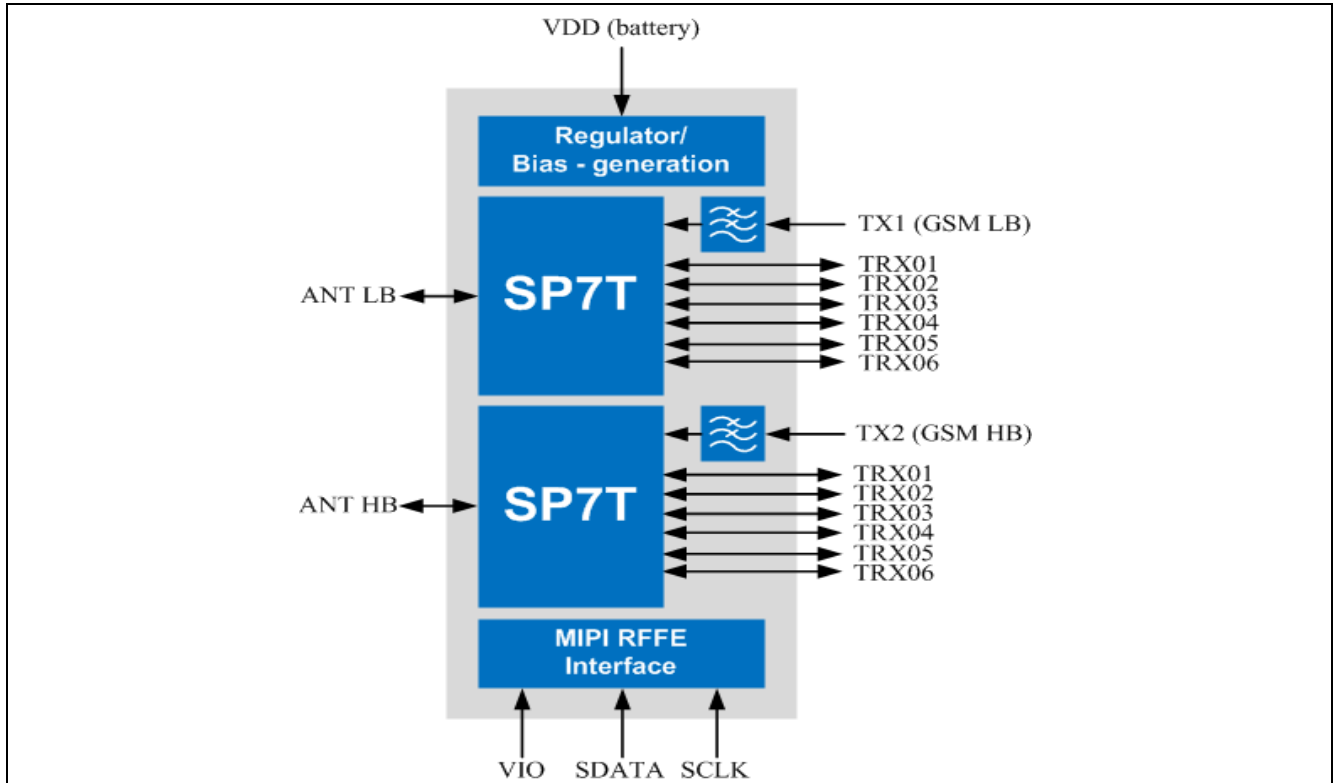

Figure 2 BGSF1717MN26 Functional Diagram

1.3 Pin Configuration

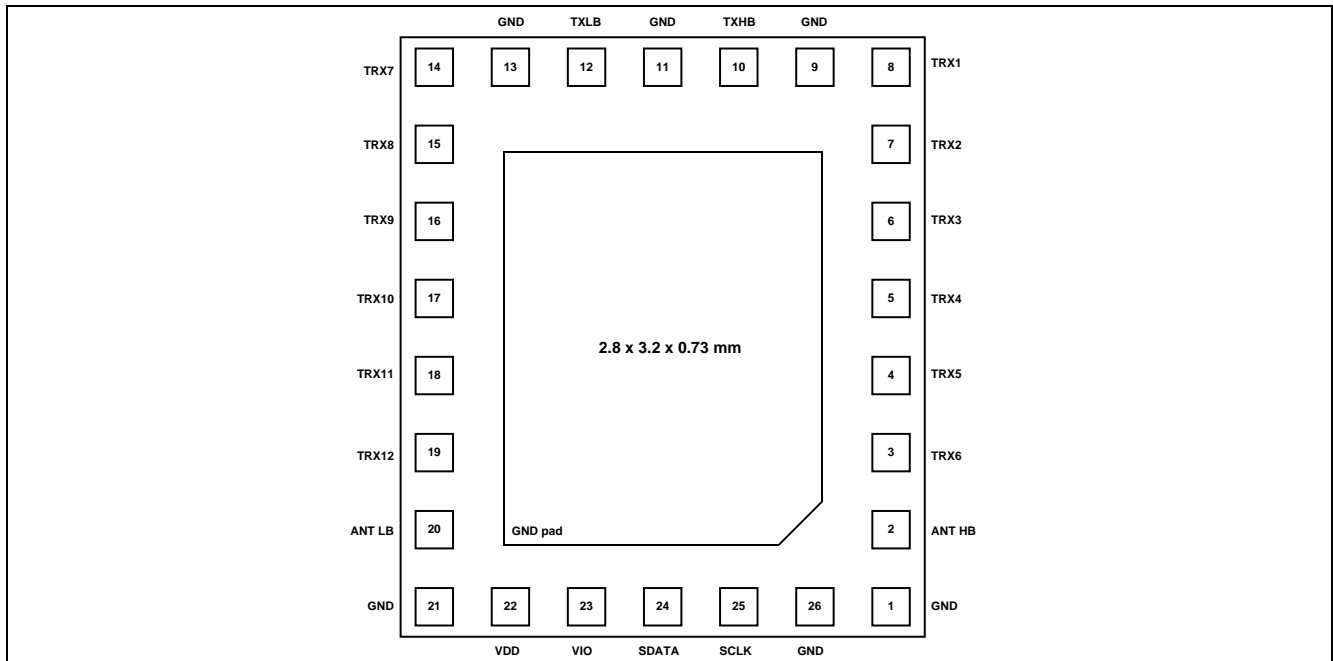

Figure 3 BGSF1717MN26 Pin Configuration

1.4 Pin Description

Table 1 Pin Description (top view)

Pin NO	Name	Pin Type	Function
0	GND	GND	Ground, die pad
1	GND	GND	DC ground
2	ANT HB	I/O	High band antenna port
3	TRX6	I/O	WCDMA TRX port
4	TRX5	I/O	WCDMA TRX port
5	TRX4	I/O	WCDMA TRX port
6	TRX3	I/O	WCDMA TRX port
7	TRX2	I/O	WCDMA TRX port
8	TRX1	I/O	WCDMA TRX port
9	GND	GND	RF ground
10	TXHB	I	GSM HB port
11	GND	GND	RF ground
12	TXLB	I	GSM LB port
13	GND	GND	RF ground



Table 1 Pin Description (top view)

Pin NO	Name	Pin Type	Function
14	TRX7	I/O	WCDMA TRX port
15	TRX8	I/O	WCDMA TRX port
16	TRX9	I/O	WCDMA TRX port
17	TRX10	I/O	WCDMA TRX port
18	TRX11	I/O	WCDMA TRX port
19	TRX12	I/O	WCDMA TRX port
20	ANT LB	I/O	Low band antenna port
21	GND	GND	DC ground
22	VDD	PWR	Supply Voltage
23	VIO	PWR	RFFE supply voltage
24	SDATA	I/O	Data
25	SCLK	I	Clock
26	GND	GND	DC ground

2 Application

A typical application of BGSF1717MN26 ASM in a mobile phone is shown in the **Figure 4**. At the main antenna path of the RF Front-End the BGSF1717MN26 switches signals from the high band and low band antenna to the different transceiver IC input and outputs. For the diversity path different Infineon RF switches can be used e.g. BGS16MN14, BGS18MN14. Infineon offers also besides ASMs, general purpose RF Switches and a broad portfolio of **Low Noise Amplifiers** and Antenna Tuner Devices. All of Infineon Products concerning mobile phone applications can be found in our newest [Application Guide for RF & Protection Devices/ Mobile Communication](#).

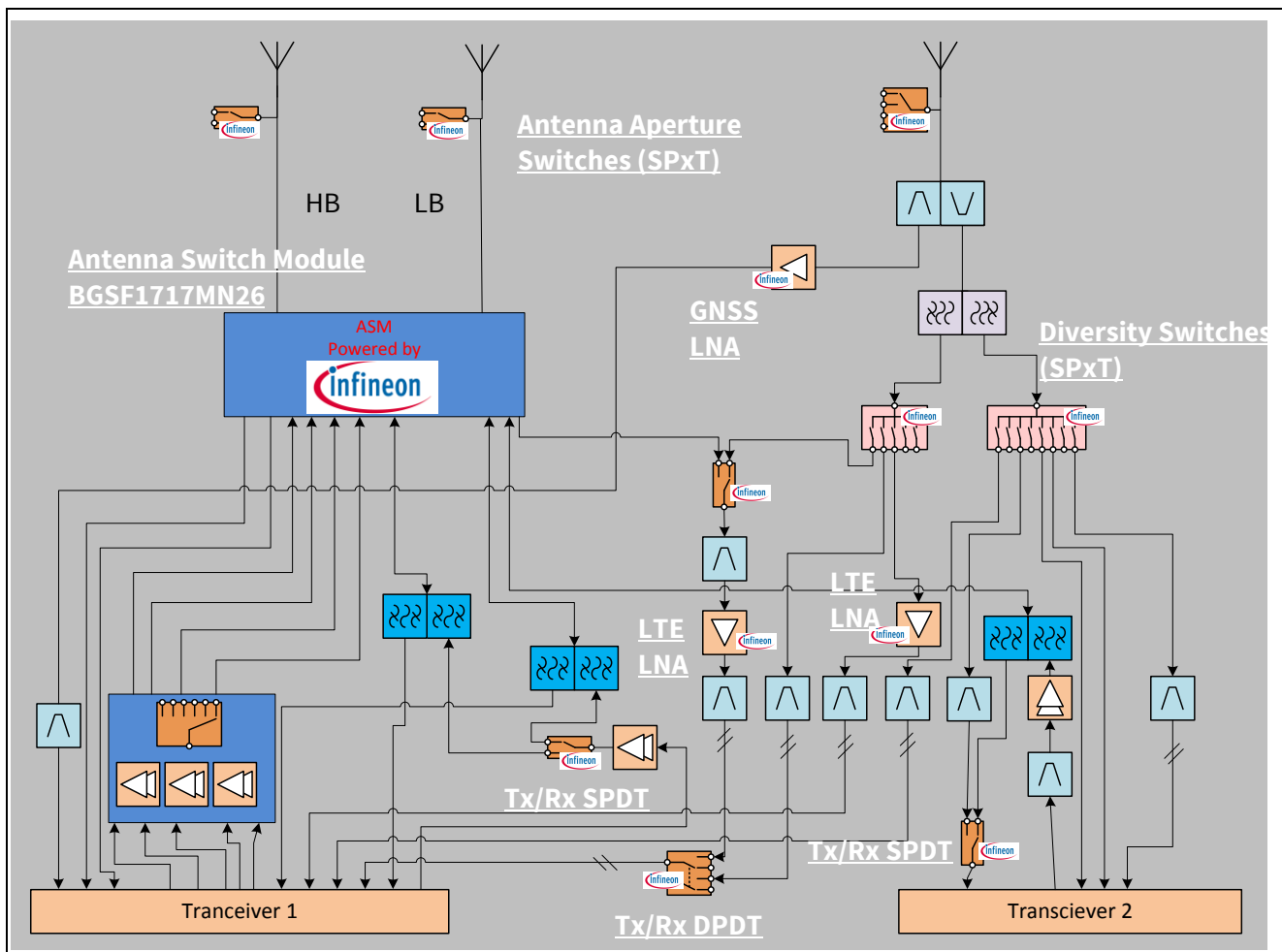

Figure 4 BGSF1717MN26 in mobile phone cellular frontend (typical discrete LTE-A feature set)

3 Application Circuit of BGSF1717MN26

In this chapter the evaluation board with application circuit including matching passive elements is presented. Afterwards, the deembedding process required for S-Parameter measurements is described.

Device: BGSF1717MN26
Application: Antenna Switch Module
PCB Marking: BGSF1717MN26 v1.1
EVB Order No.: BGSF1717MN26 BOARD SP001136296

3.1 Application Board

The EVAluation Board (EVB) used for the RF measurements is shown in the [Figure 5](#). The EVB is designed so that every 50 Ohm signal lines have the same length. The layer stack-up of the PCB is presented in [Figure 6](#).

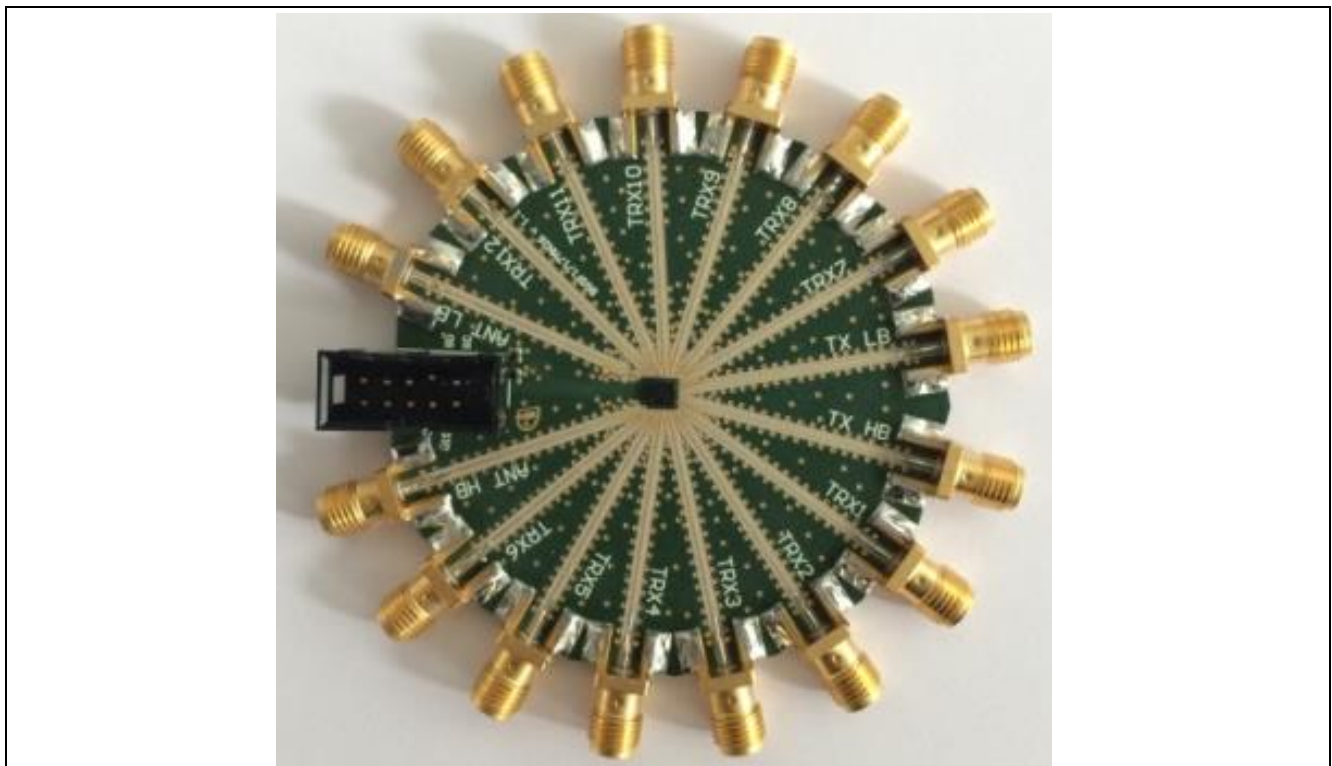

Figure 5 Layout of the application board

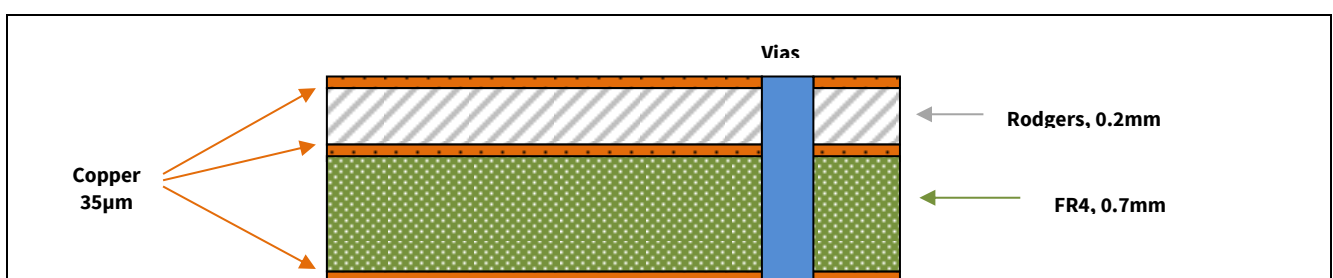

Figure 6 PCB cross section with layer stack-up

3.2 Deembedding

The device (BGSF1717MN26) is deembedded from influence of the application circuit and coaxial connectors by at first measuring a coaxial connector and a “half-board” micro strip line and then by loading this data in the fixture simulator of the network analyzer. In the **Figure 7** this deembedding concept is given. The deembedding of this RF device is performed in several steps explained in the next subchapters.

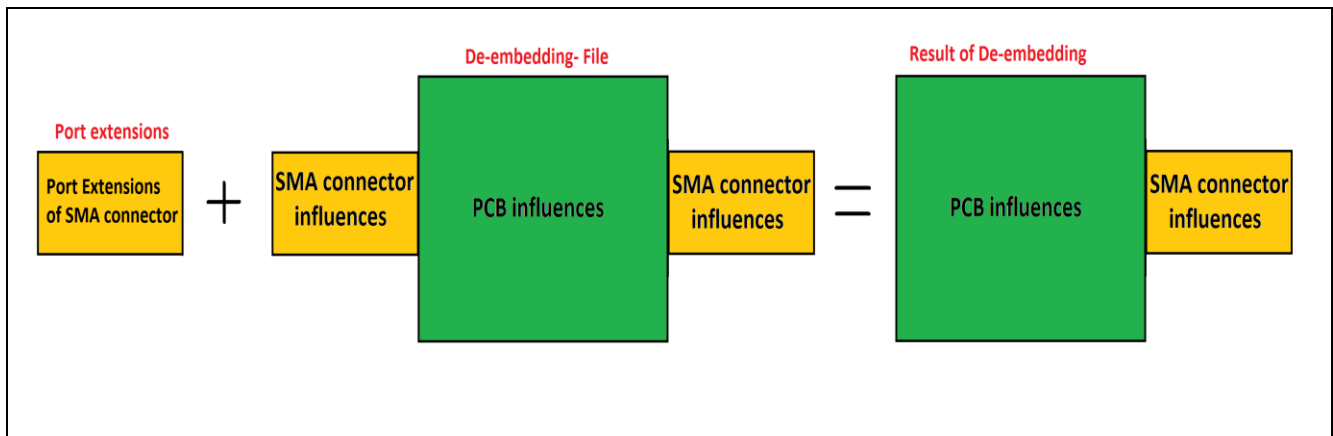

Figure 7 Deembedding concept with a “prepared” SMA connector and a “Half-Thru” board

3.2.1 Port Extension

In order to shift the reference plane of the network analyzer to the PCB signal line connect a SMA connector with a cut pin of the inner conductor to one port of the Vector Network Analyzer (VNA) and measure port extensions at this port.

Figure 8 shows such a “prepared” SMA connector with an outer pin cut with a wire cutter.

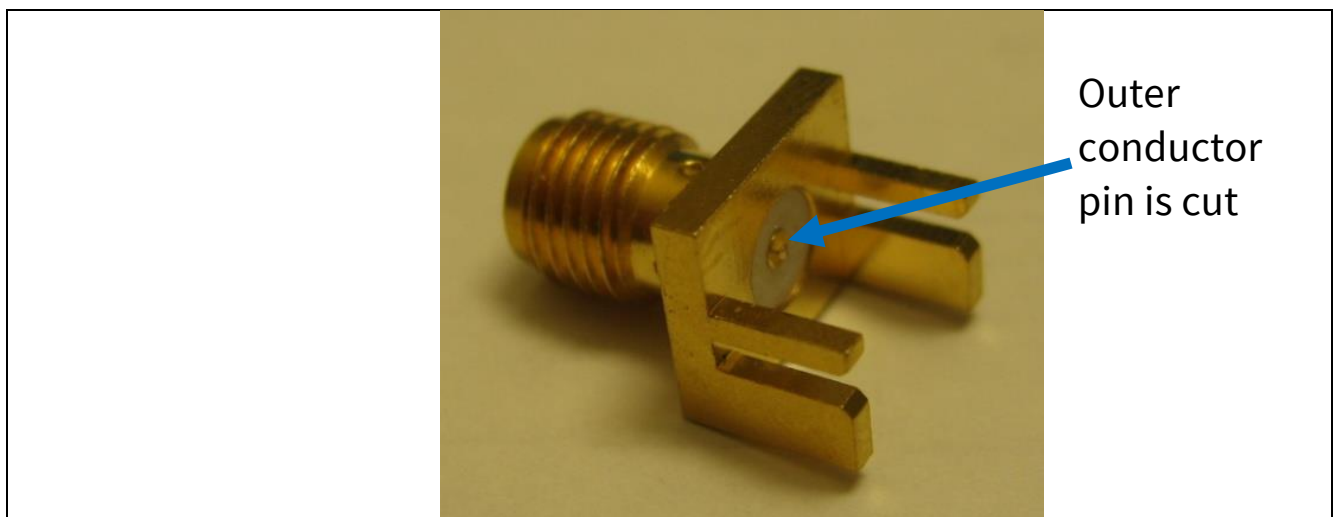

Figure 8 SMA connector with cut inner pin

After the measurement of the S21 of the half-thru board (given in [Figure 9](#)) with port extension turned on is completed, the s2p-data ought to be loaded in the fixture simulator. This measurement result includes the insertion loss and the phase shift of the one SMA connector and the transmission line to the chip. After all the port extension has to be deactivated.

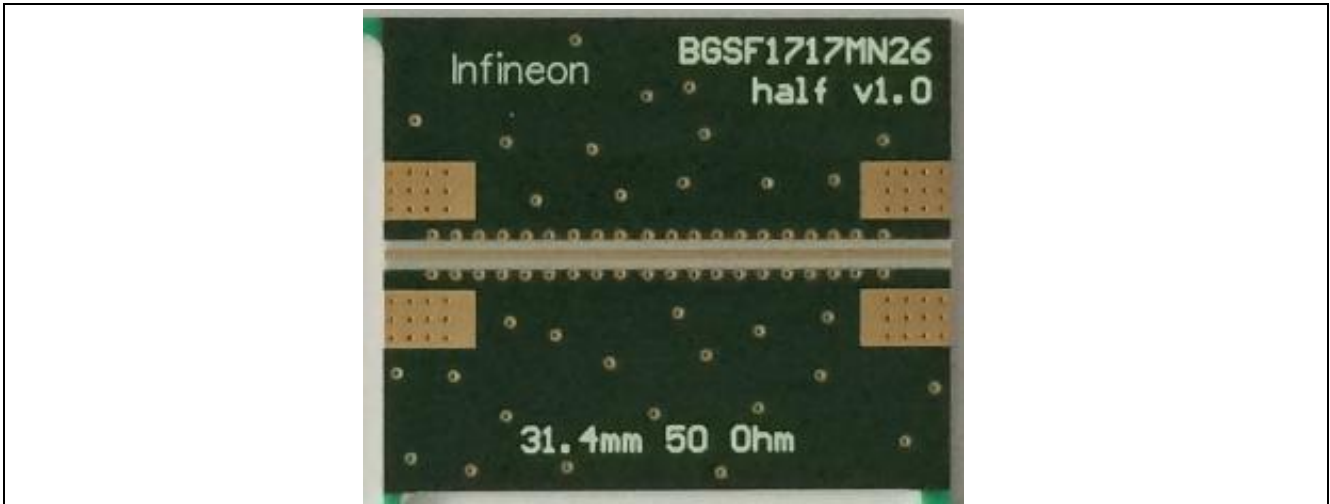

Figure 9 “Half-Thru” deembedding board

3.2.2 Deembedding control process

Measure this full-thru PCB (given in the [Figure 10](#)) to verify your deembedding having the fixture simulator turned on for each port of the VNA, whereas port extension must be off. If the insertion loss is close to 0 dB and S11 reflection has a considerable value, further RF measurements can be done.

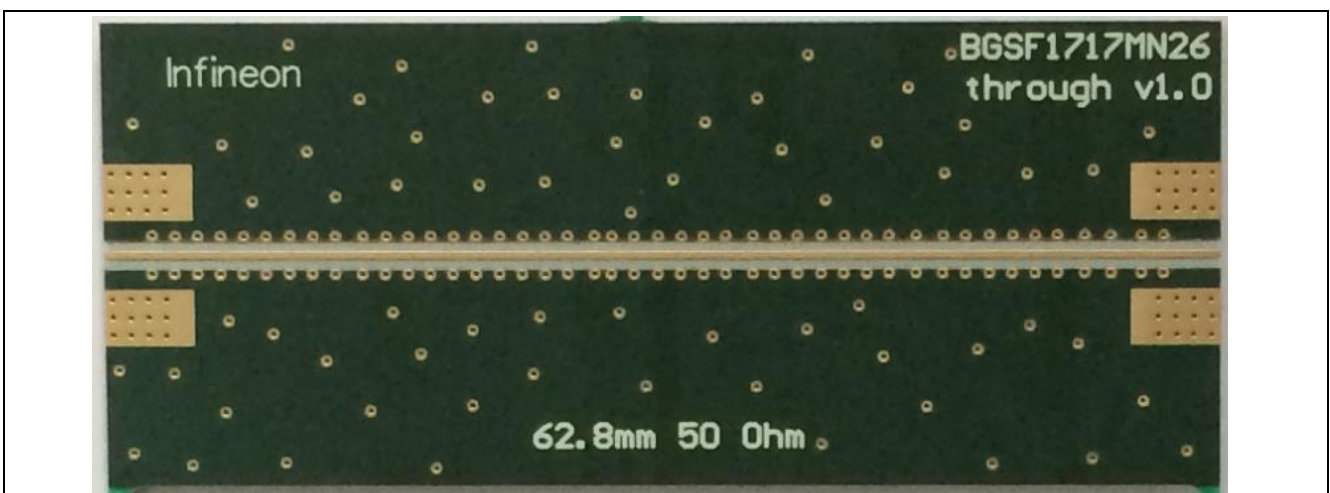

Figure 10 “Full-Thru” deembedding board

4 Small Signal Characteristics of BGSF1717MN26

The S-Parameters are measured at 25 °C with a VNA in an application circuit shown in **Figure 11**.

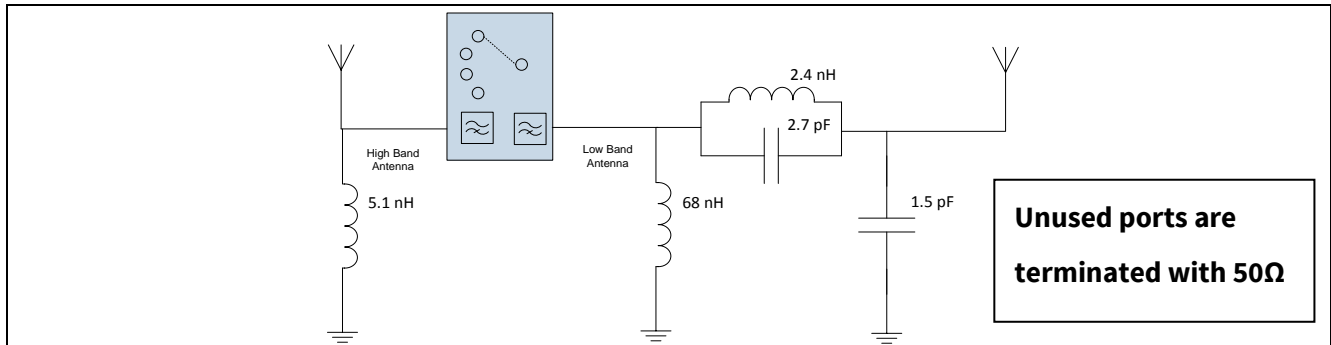

Figure 11 Application circuit BGSF1717MN26

4.1 Small Signal Parameters LB switch

4.1.1 Insertion Loss from LB Antenna to the respective RF TRX Port

Table 2 Insertion Loss from LB Antenna to TX LB port

Frequency (MHz)	704	716	740	751	824	881	915	942
TRx7	-0.76	-0.76	-0.74	-0.74	-0.75	-0.75	-0.75	-0.76
TRx8	-0.74	-0.74	-0.72	-0.73	-0.73	-0.74	-0.74	-0.74
TRx9	-0.72	-0.71	-0.69	-0.7	-0.7	-0.71	-0.71	-0.71
TRx11	-0.67	-0.66	-0.64	-0.65	-0.66	-0.66	-0.66	-0.66
TRx12	-0.65	-0.65	-0.63	-0.64	-0.64	-0.64	-0.64	-0.64

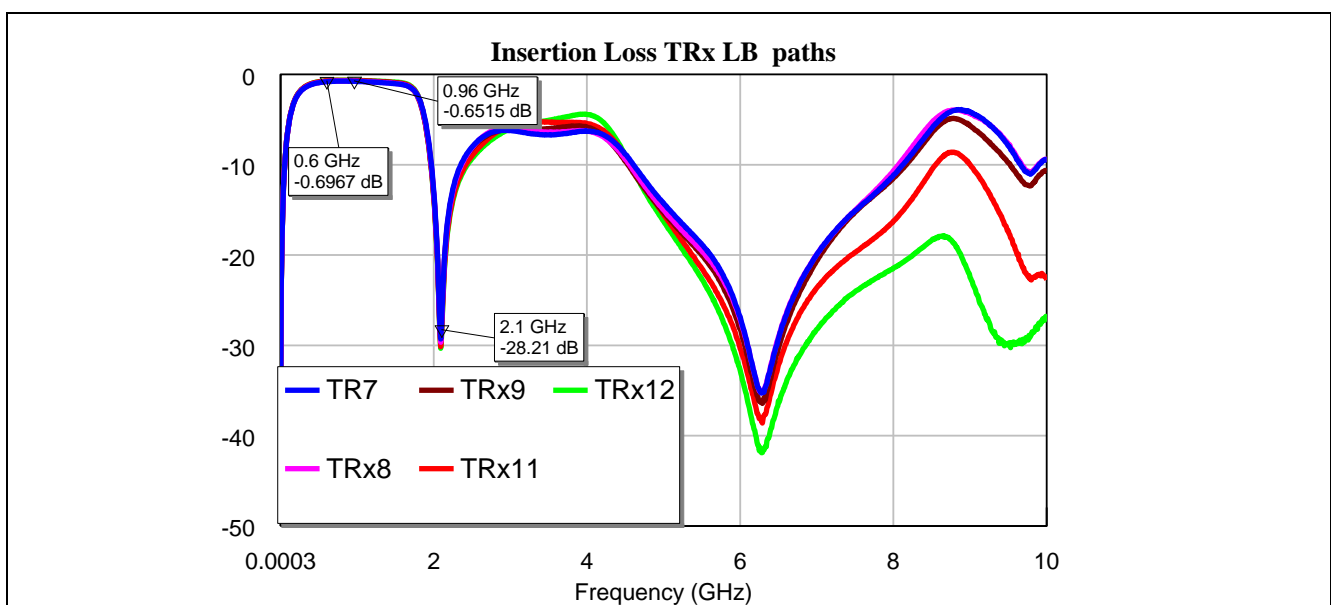

Figure 12 Forward transmission from LB Antenna to TX LB port

4.1.2 Insertion Loss TX LB port

Table 3 Insertion loss from LB Antenna to TX LB port

Frequency (MHz)	704	716	740	751	824	881	915	942
TR LB	-1.37	-1.39	-1.42	-1.45	-1.51	-1.52	-1.51	-1.51

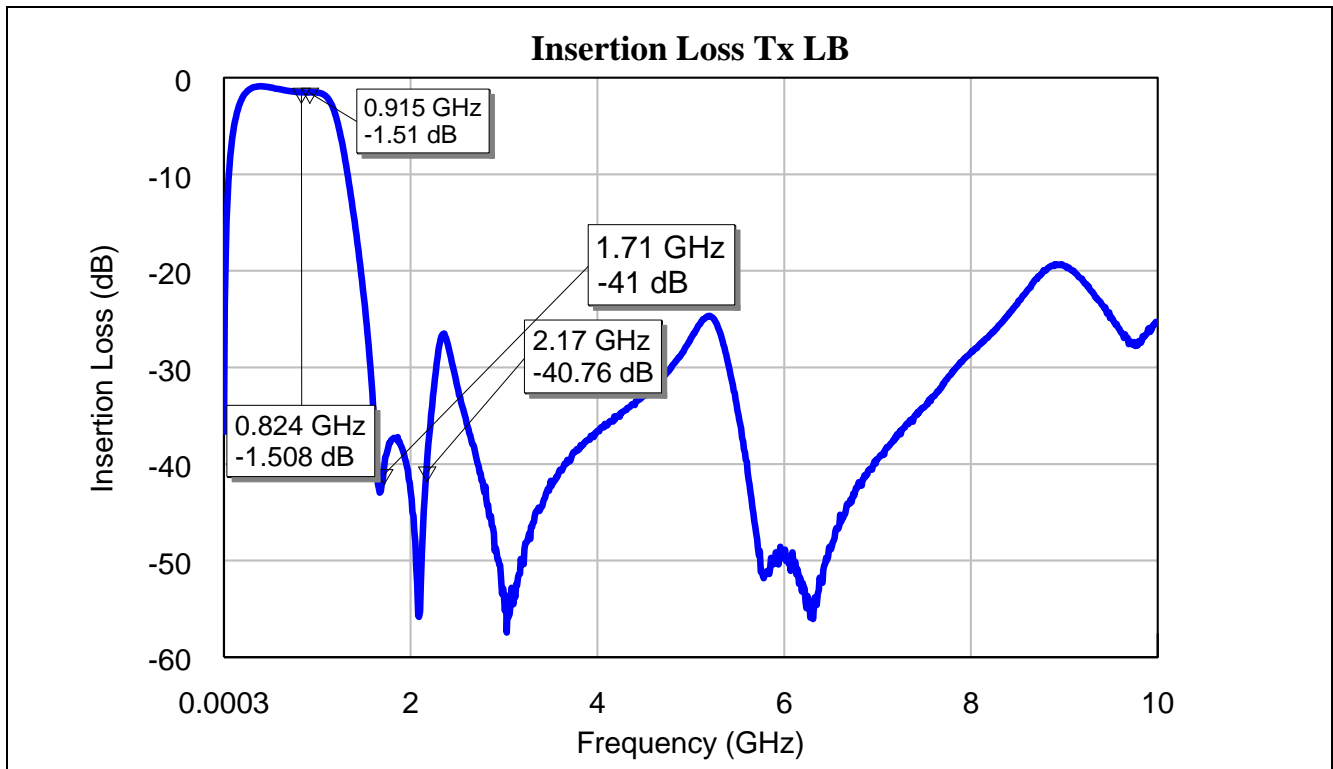

Figure 13 Forward transmission from LB Antenna to TX LB port

4.1.3 Insertion Loss high linearity ultra-low IL TRx10 port

Table 4 Insertion loss from LB Antenna to TRx10 port

Frequency (MHz)	704	716	740	751	824	881	915	942
TR LB	-0.56	-0.56	-0.54	-0.55	-0.55	-0.56	-0.55	-0.56

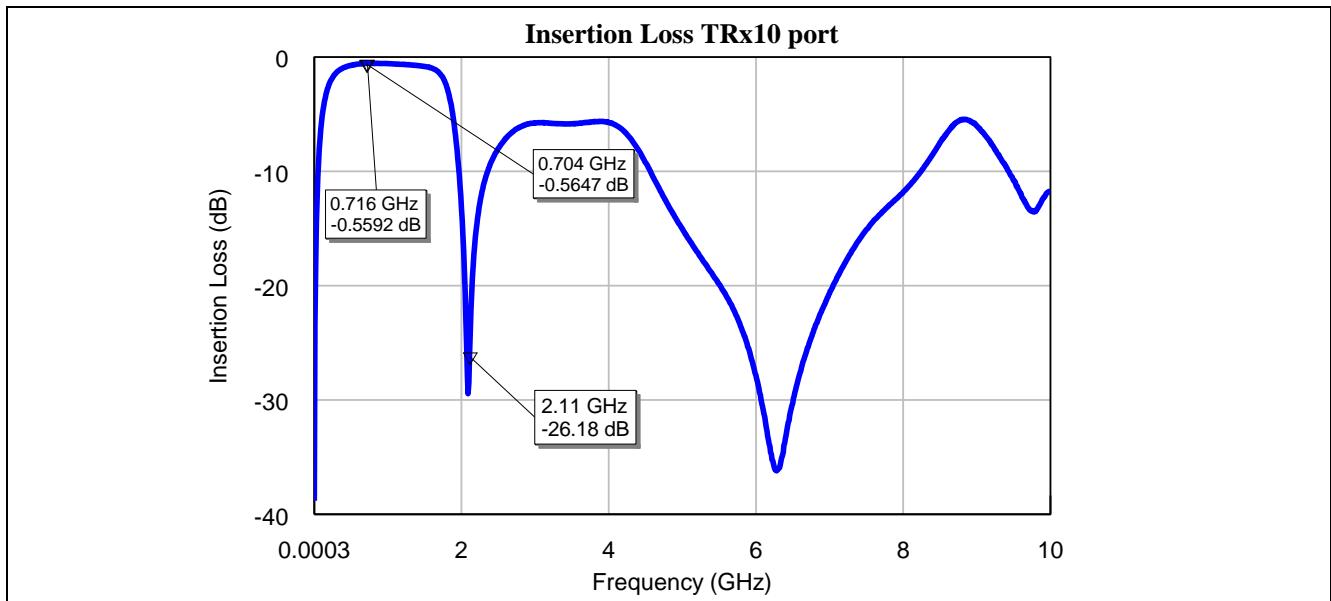

Figure 14 Forward transmission from LB Antenna to TRX10 port

4.1.4 Return Loss from LB Antenna to the respective RF Port

Table 5 Return loss from LB Antenna to the respective TRX LB RF port

Frequency (MHz)	704	716	740	751	824	881	915	942
TRx7	-13.4	-13.5	-13.7	-13.7	-13.8	-13.8	-13.7	-13.6
TRx8	-14	-14.1	-14.3	-14.4	-14.5	-14.5	-14.4	-14.4
TRx9	-14.2	-14.4	-14.6	-14.6	-14.8	-14.9	-14.9	-14.9
TRx10	-14.5	-14.6	-14.9	-15	-15.2	-15.4	-15.4	-15.4
TRx11	-15.4	-15.5	-15.7	-15.8	-16.1	-16.1	-16.1	-16.1
TRx12	-15.5	-15.6	-15.8	-15.9	-16.2	-16.2	-16.2	-16.2

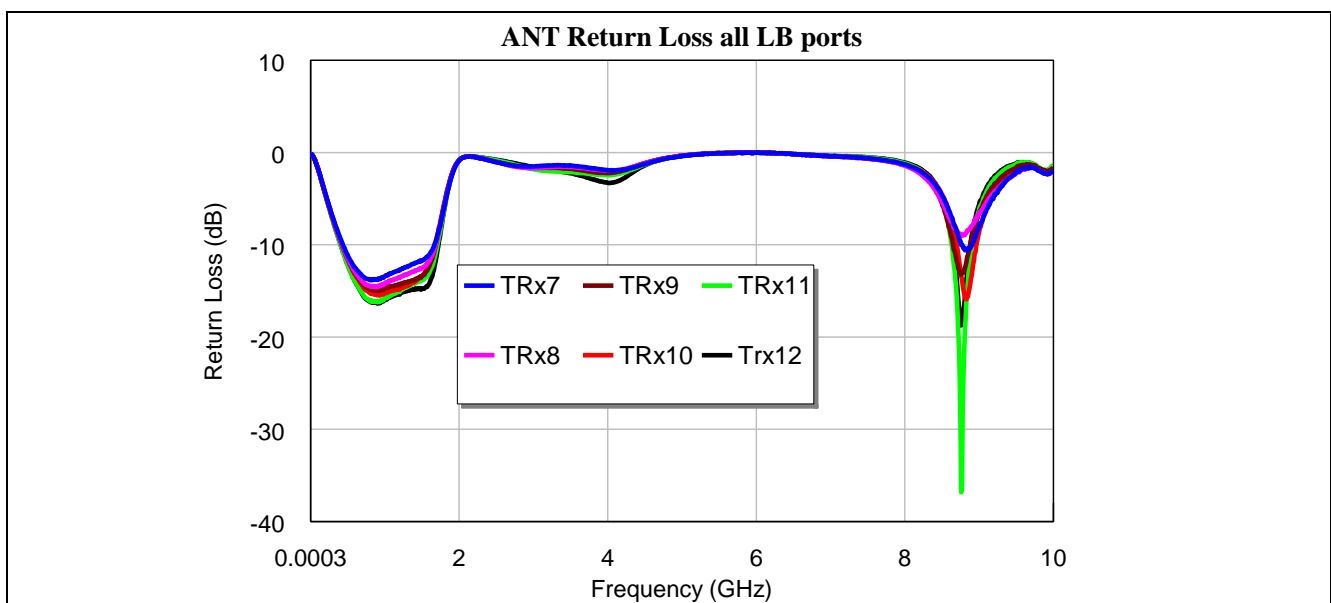

Figure 15 Return Loss from LB Antenna to the respective TRX LB RF port

4.1.5 Return Loss of LB TRX RF ports to LB Antenna

Table 6 Return loss from respective TRX LB RF port to LB Antenna

Frequency (MHz)	704	716	740	751	824	881	915	942
TRx7	-13.7	-13.8	-13.9	-14	-14.3	-14.4	-14.3	-14.4
TRx8	-14.3	-14.5	-14.6	-14.6	-15	-15.2	-15.1	-15.3
TRx9	-14.8	-14.9	-15.1	-15.2	-15.7	-16	-15.9	-16.1
TRx10	-14.8	-15	-15.1	-15.2	-15.8	-16	-15.9	-16.1
TRx11	-15.8	-15.9	-16.1	-16.2	-16.9	-17.2	-17.1	-17.3
TRx12	-16.2	-16.4	-16.6	-16.8	-17.5	-17.9	-17.9	-18.1

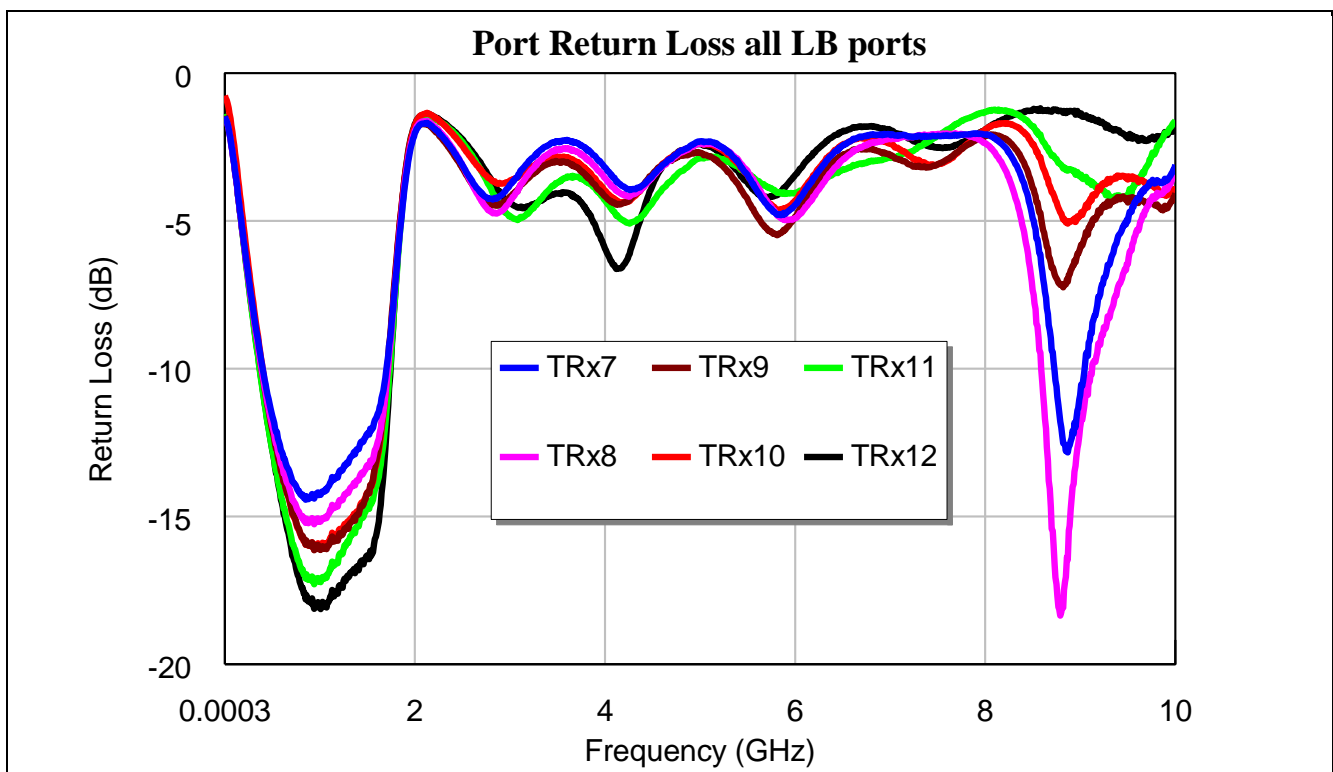

Figure 16 Return Loss of LB TRX RF ports to LB Antenna

4.1.6 Return Loss TX LB RF port

Table 7 Return loss from TR LB RF port

Frequency (MHz)	704	716	740	751	824	881	915	942
ANT LB port	-11.9	-11.8	-11.8	-11.8	-12.1	-13	-13.9	-14.9
TX LB port	-10.1	-10.1	-10.1	-10.1	-10.1	-10.7	-11.4	-12.3

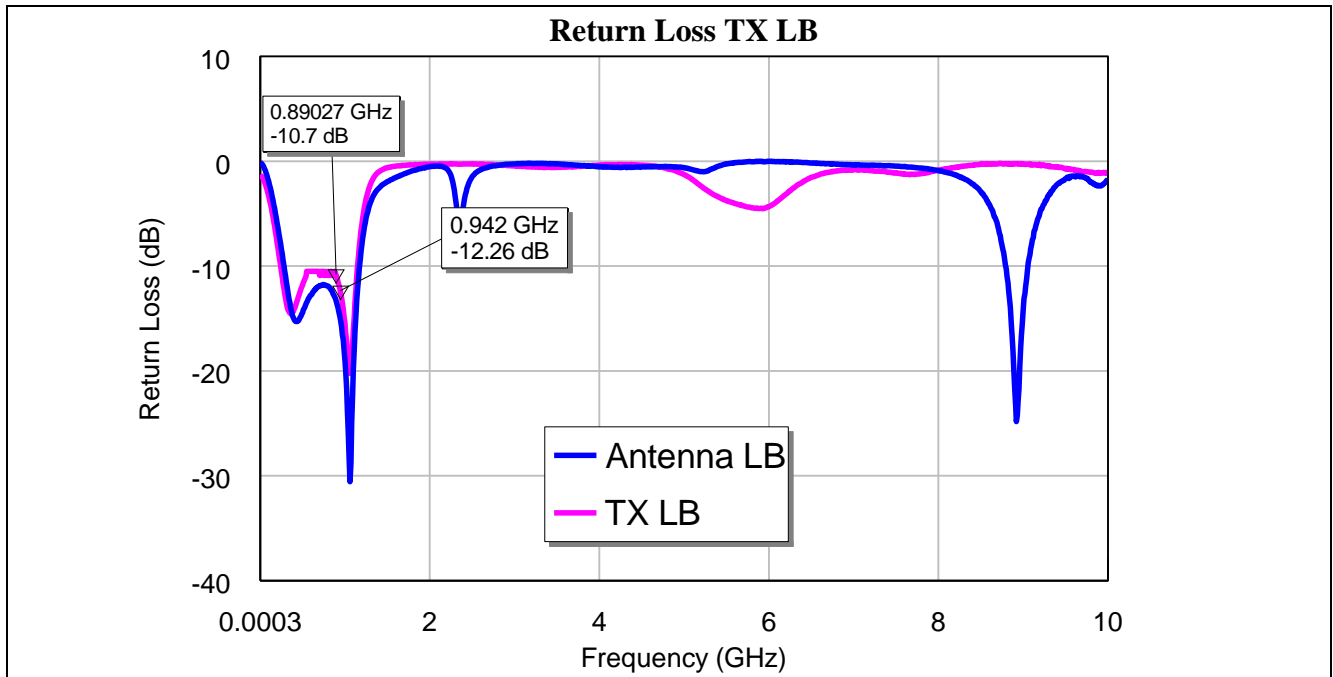

Figure 17 Return Loss port TX LB RF port

Table 8 Return loss from TRX10 RF port

Frequency (MHz)	704	716	740	751	824	881	915	942
ANT LB port	-14.5	-14.6	-14.9	-15	-15.2	-15.4	-15.4	-15.4
TRX10 port	-14.8	-15	-15.1	-15.2	-15.8	-16	-15.9	-16.1

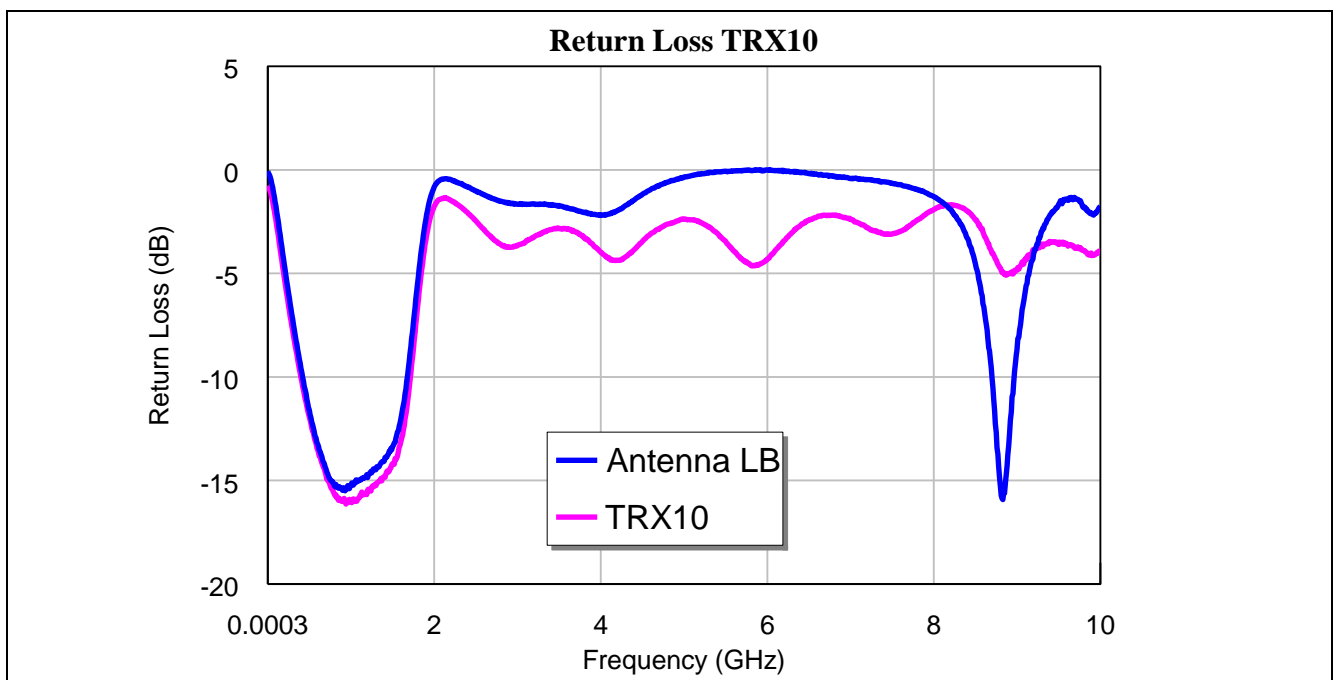

Figure 18 Return Loss of high linearity ultra-low IL TRX10 RF port

4.1.7 Antenna to port and Port to Port Isolation LB path

Apply to the [Table 9](#) and [Table 10](#) on the next page.

Table 9 Worst case Antenna to Port Isolation High Band part¹

Frequency (GHz)	TX HB active		TRX1 active		TRX2 active		TRX3 active		TRX4 active		TRX5 active		TRX6 active	
	ANTHB TRX1	ANTHB TX LB	ANTHB TRX2	ANTHB TX HB	ANTHB TRX3	ANTHB TRX1	ANTHB TRX4	ANTHB TRX2	ANTHB TRX5	ANTHB TRX3	ANTHB TRX6	ANTHB TRX4	ANTHB ANT LB	ANTHB TRX5
0.704	-39.5	-39.7	-47.2	-34.2	-37.3	-35.5	-34.1	-35	-33.4	-38.3	-42.7	-43.2	-39.3	-37
0.716	-39.3	-39.6	-46.9	-33.9	-37.1	-35.4	-34	-34.8	-33.3	-38.4	-42.3	-42.9	-39.1	-36.8
0.74	-38.9	-39.8	-47	-33.8	-36.6	-35.2	-33.8	-34.6	-33	-38	-42.3	-42.6	-39	-36.5
0.751	-38.6	-39.6	-46.4	-33.7	-36.7	-35.1	-33.7	-34.4	-32.9	-37.9	-42	-42.1	-38.7	-36.2
0.824	-37.4	-39.3	-45.2	-32.9	-35.9	-34.3	-32.9	-33.8	-32.3	-37.1	-41.3	-40.5	-37.9	-35.3
0.881	-36.3	-39.4	-44.1	-32.5	-35.2	-33.9	-32.5	-33.4	-31.8	-36.6	-40.5	-39.2	-37.3	-34.5
0.915	-35.8	-39.9	-43.6	-32.2	-35.1	-33.5	-32.2	-33.1	-31.5	-36.3	-40.2	-38.6	-36.9	-34.1
0.942	-35.4	-40.2	-43.5	-31.9	-34.8	-33.2	-32	-32.8	-31.3	-36	-39.8	-38.2	-36.8	-33.8
1.71	-45.4	-30.2	-45	-29.9	-33.1	-30.6	-29.5	-30	-28.6	-32.4	-35.7	-29.8	-32.7	-29.1
1.842	-46.5	-32.7	-48	-31.3	-34.3	-32	-31	-31.5	-30.2	-34	-37.1	-30.9	-34.3	-31.1
1.96	-50	-36.8	-53.3	-36.5	-39.6	-37.3	-36.3	-36.8	-35.3	-39.3	-42.9	-36.7	-40	-37.5
1.97	-50.2	-37.2	-54.5	-37.3	-40.2	-38	-37	-37.5	-36	-39.9	-43.8	-37.4	-40.5	-38.4
2.017	-52.8	-40.4	-60.7	-41.8	-44.9	-42.2	-41.4	-41.8	-40.5	-44.2	-48.9	-42.4	-45.4	-42.9
2.14	-54.6	-41.1	-61.9	-46.5	-48.6	-47	-46.2	-47.1	-45.3	-48.9	-51.4	-44.1	-49.7	-48.2
2.17	-49.8	-36	-63.9	-43.7	-46	-44.1	-43.1	-43.2	-41.9	-45.8	-49.1	-41.5	-46.6	-45.6
2.35	-34.7	-19.9	-53.2	-35.1	-37.6	-36	-34.6	-35.1	-33.7	-37.5	-42.2	-34.5	-39.2	-38.8
2.593	-40.9	-24.8	-49.3	-30.7	-32.9	-31.3	-29.9	-30.5	-29.3	-33.1	-38	-30.1	-34.5	-36.3
2.69	-42.4	-26	-47.9	-29.5	-31.5	-29.9	-28.7	-29.2	-28.1	-31.6	-36.5	-28.9	-33.1	-35.6
3.5	-56.4	-28.9	-44.2	-26.2	-27.6	-26.2	-25.2	-25.5	-24.9	-27	-29.7	-22.9	-25.6	-30.4

¹ Worst case isolation: Isolation between neighbor port of the active port, any other port have better (higher) Isolation

Antenna Switch Module with integrated MIPI RFFE Interface

Small Signal Characteristics of BGSF1717MN26



Table 10 Worst case Port to Port Isolation Low Band part¹

Frequency (GHz)	TX LB active		TRX7 active		TRX8 active		TRX9 active		TRX10 active		TRX11 active		TRX12 active	
	ANTLB TX HB	ANTLB TRX7	ANTLB TX LB	ANTLB TRX8	ANTLB TRX7	ANTLB TRX9	ANTLB TRX8	ANTLB TRX10	ANTLB TRX9	ANTLB TRX11	ANTLB TRX10	ANTLB TRX12	ANTLB TRX11	ANTLB ANTHB
0.704	-39.6	-39.8	-40.9	-32.3	-34.9	-33.5	-32.1	-30.5	-31.4	-35.8	-35.2	-39.7	-36.2	-37.8
0.716	-39.6	-39.9	-41.1	-32.2	-34.7	-33.3	-31.9	-30.4	-31.3	-35.7	-35	-39.8	-36.2	-37.6
0.74	-39	-39.8	-40.5	-31.9	-34.4	-33	-31.7	-30.1	-31	-35.3	-34.8	-39.2	-35.9	-37.3
0.751	-39	-39.9	-40.5	-31.7	-34.4	-32.9	-31.7	-30	-30.9	-35.3	-34.7	-39.1	-35.8	-37.1
0.824	-37.8	-39.7	-40.4	-31.1	-33.7	-32.1	-30.9	-29.3	-30.2	-34.6	-33.9	-38	-34.9	-36.2
0.881	-36.7	-39.8	-40.7	-30.5	-33.1	-31.6	-30.3	-28.7	-29.6	-33.9	-33.4	-37.2	-34.2	-35.6
0.915	-36	-39.6	-40.8	-30.2	-32.7	-31.3	-30	-28.4	-29.3	-33.6	-33.1	-36.7	-33.9	-35.3
0.942	-35.6	-39.5	-41.2	-30.1	-32.6	-31.1	-29.8	-28.2	-29.1	-33.4	-32.8	-36.2	-33.7	-34.9
1.71	-35	-37.8	-46.1	-28	-28.8	-27.4	-27.3	-24.9	-26.7	-29.7	-28	-27.2	-29.5	-26.8
1.842	-35.2	-37.7	-48.1	-25.3	-26.3	-24.7	-24.9	-22.9	-24.5	-26.8	-25.8	-23.7	-26.6	-24.7
1.96	-35.2	-37.4	-43.4	-21.9	-23.5	-21.8	-21.6	-20.2	-21	-23.9	-23.9	-21.9	-24	-24.6
1.97	-35	-37.3	-43.5	-21.7	-23.4	-21.6	-21.4	-20.1	-20.8	-23.7	-23.9	-21.9	-23.9	-24.7
2.017	-35.2	-37.3	-42.2	-21	-22.8	-20.9	-20.5	-19.3	-19.9	-23.1	-23.5	-21.8	-23.4	-25.1
2.14	-35.1	-36.2	-40.3	-19.8	-22	-20	-19.3	-18.2	-18.4	-22.1	-23.1	-21.9	-22.6	-26.8
2.17	-35.4	-35.8	-40.2	-19.7	-21.9	-19.9	-19.1	-18	-18.2	-22	-23.1	-22	-22.5	-27.3
2.35	-34.3	-35.9	-39.2	-19	-21.5	-19.4	-18.2	-17.1	-17.3	-21.4	-22.7	-22.4	-21.9	-29.7
2.593	-33.2	-39.2	-38.8	-18.5	-21.6	-19.2	-17.6	-16.5	-16.5	-21	-22.4	-22.9	-21.1	-32.5
2.69	-32.8	-38.2	-38.9	-18.7	-21.9	-19.3	-17.7	-16.6	-16.5	-21	-22.3	-23.4	-20.8	-33.9
3.5	-30.9	-38.5	-45.8	-26.4	-25.5	-25.7	-25.8	-22.2	-24.6	-27.2	-24.9	-22.5	-26.3	-30.8

¹ Worst case isolation: Isolation between neighbor port of the active port, any other port have better (higher) Isolation

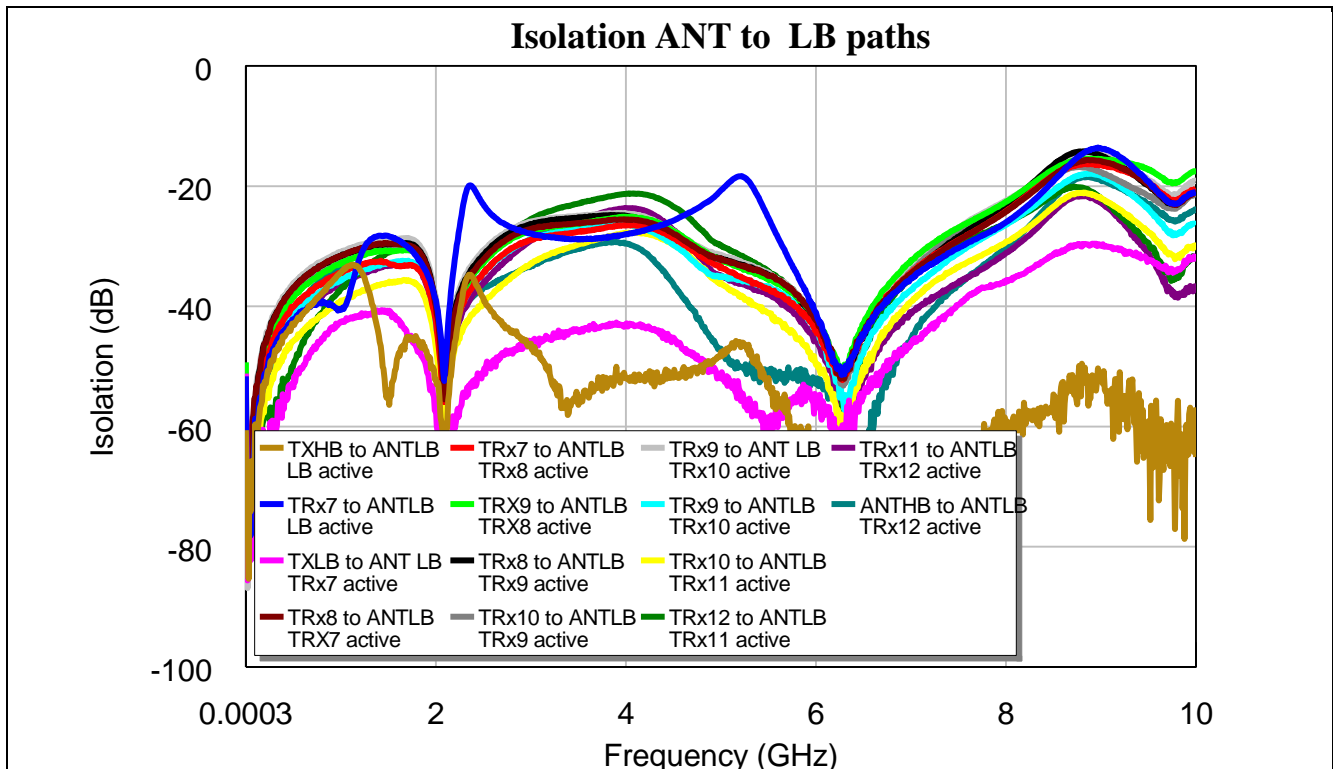

Figure 19 Worst case Antenna to Port Isolation Low Band part¹

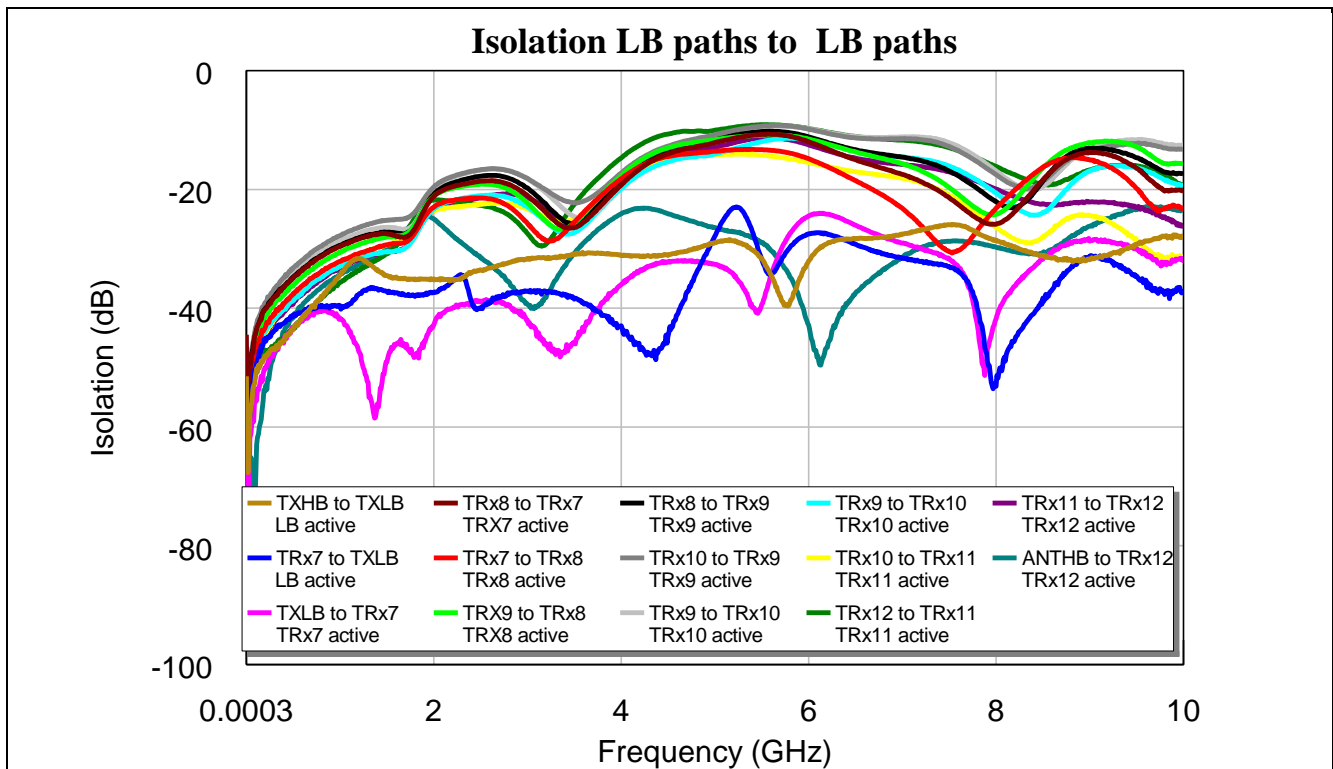

Figure 20 Worst case Port to Port Isolation Low Band part¹

¹ Worst case isolation: Isolation between neighbor port of the active port, any other port have better (higher) Isolation

4.2 Small Signal Parameters HB switch

4.2.1 Insertion Loss from HB Antenna to the respective TRX HB RF Port

Table 11 Insertion Loss from HB Antenna to the respective TRX HB RF port

Frequency (MHz)	1710	1842	1960	1970	2017	2140	2170	2350	2593	2690	3500
TRx1	-0.6	-0.66	-0.72	-0.72	-0.76	-0.82	-0.86	-0.99	-0.92	-0.89	-0.98
TRx2	-0.63	-0.71	-0.78	-0.79	-0.82	-0.9	-0.93	-1.1	-0.99	-0.96	-0.95
TRx3	-0.64	-0.73	-0.81	-0.83	-0.87	-0.97	-1	-1.2	-1.1	-1.1	-1
TRx4	-0.66	-0.78	-0.92	-0.93	-0.99	-1.2	-1.2	-1.5	-1.4	-1.4	-1.1
TRx5	-0.64	-0.75	-0.85	-0.86	-0.9	-1	-1	-1.2	-1.2	-1.1	-0.95
TRx6	-0.71	-0.84	-0.96	-0.96	-1	-1.1	-1.2	-1.4	-1.4	-1.3	-1.1

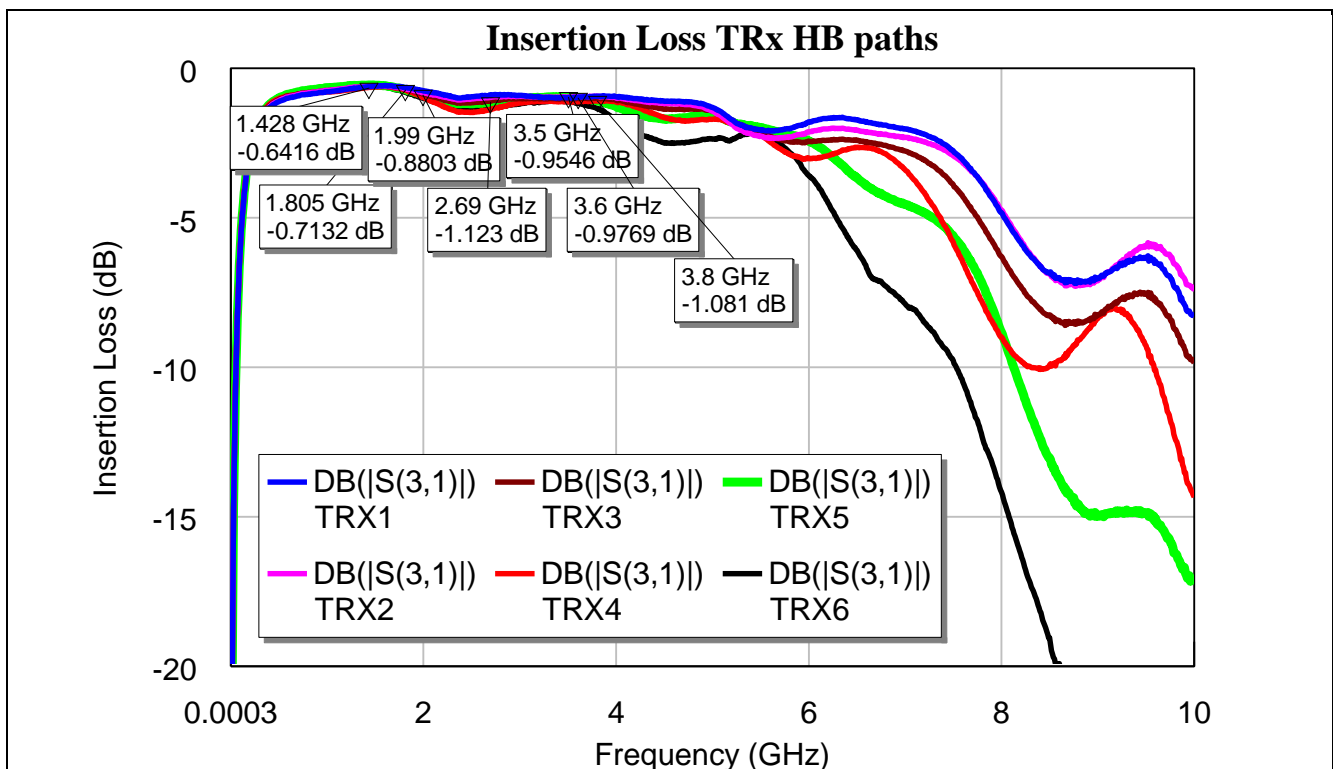

Figure 21 Forward transmission from HB Antenna to the respective TRX HB RF port

4.2.2 Insertion Loss TX HB port

Table 12 Insertion Loss from HB Antenna to the respective TX HB RF

Frequency (MHz)	1710	1842	1960	1970	2017	2140	2170	2350	2593	2690	3500
TRx1	-1.7	-1.5	-1.4	-1.4	-1.5	-	-	-	-	-	-

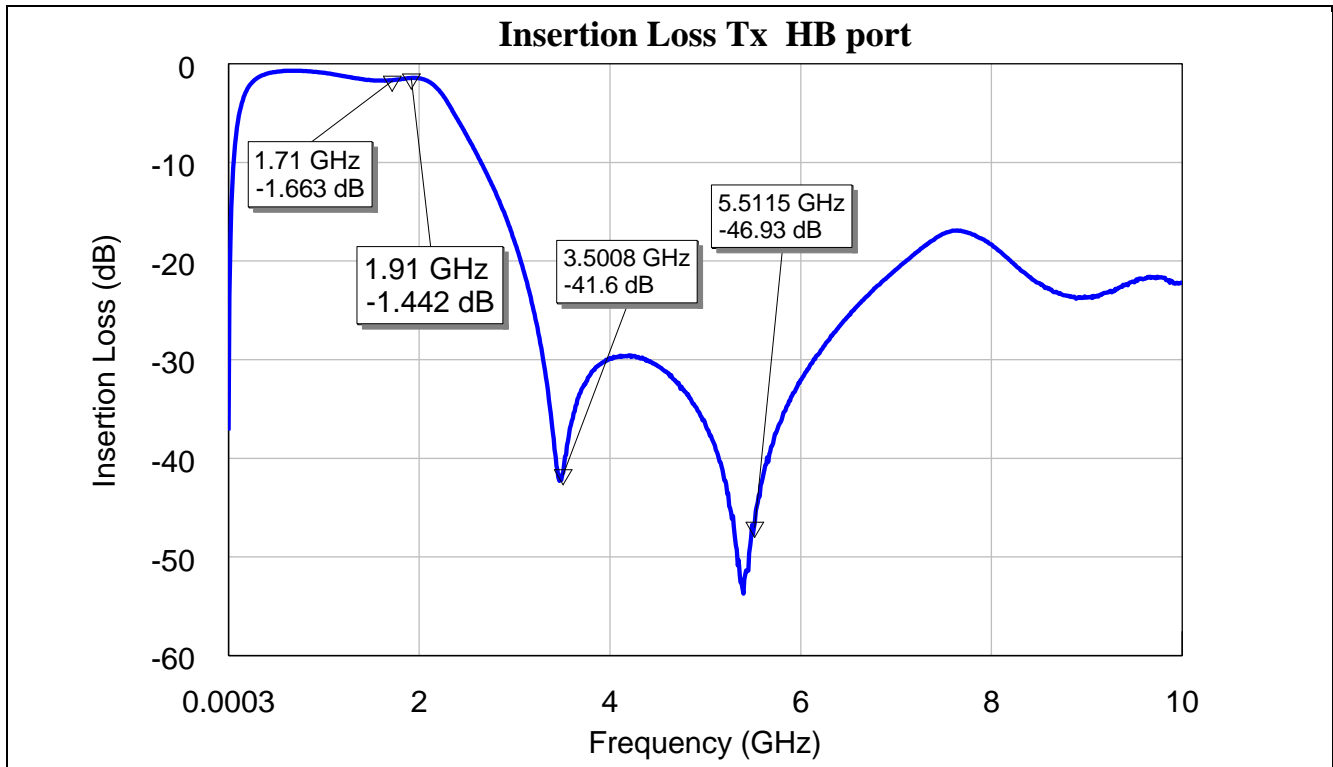

Figure 22 Forward transmission from HB Antenna to the respective TX HB RF port

4.2.3 Return Loss from HB Antenna to the respective TRX HB RF Port

Table 13 Return Loss from HB Antenna to the respective TRX HB RF port

Frequency (MHz)	1710	1842	1960	1970	2017	2140	2170	2350	2593	2690	3500
TRx1	-27.8	-20	-16.6	-16.5	-15.6	-14.2	-14	-13.5	-15	-16.6	-15.6
TRx2	-24.3	-18.1	-15.3	-15.2	-14.5	-13.2	-13	-12.7	-14.1	-15.6	-20.3
TRx3	-23.4	-17.2	-14.3	-14.2	-13.4	-12	-11.7	-11.1	-12	-13.1	-23.4
TRx4	-21.4	-15.7	-12.6	-12.5	-11.6	-10	-10	-10	-10	-10	-19.4
TRx5	-19.5	-15.3	-13.1	-13	-12.4	-11.1	-10.9	-10.2	-10.5	-11	-19.5
TRx6	-17.5	-14	-12	-11.9	-11.3	-10.2	-10	-10	-10	-10	-14.9

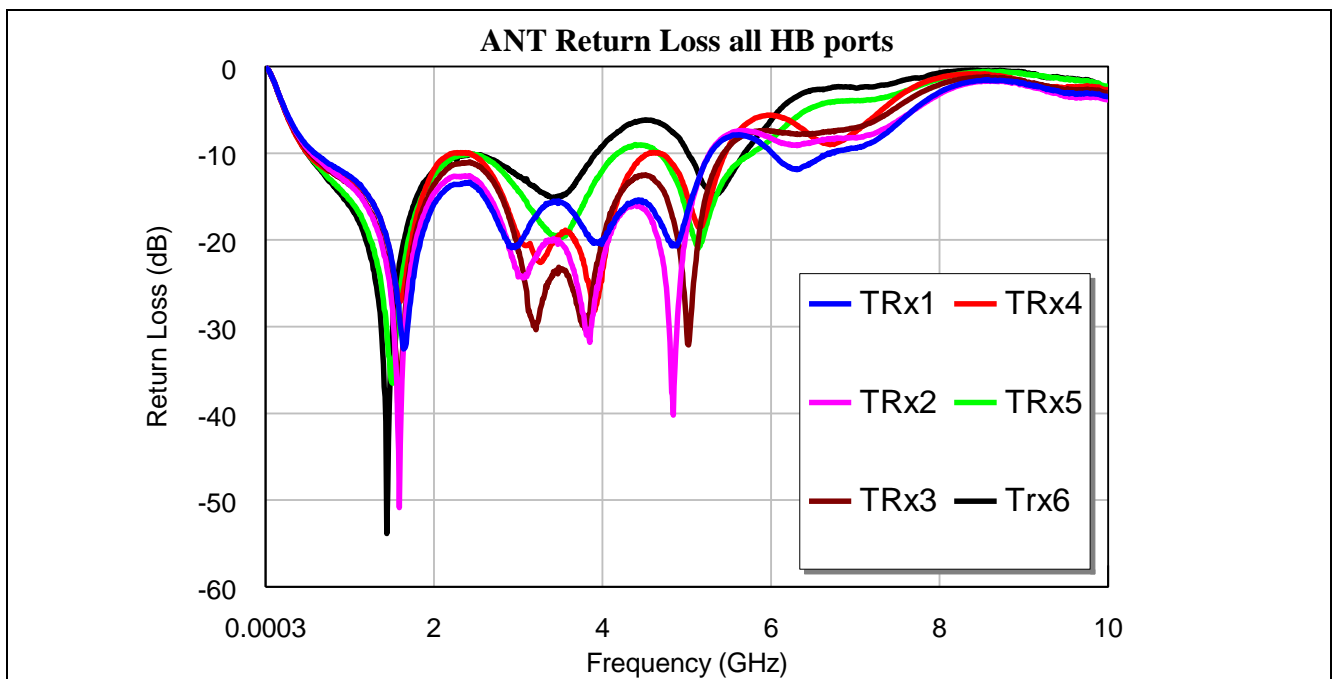

Figure 23 Return Loss from HB Antenna to the respective TRX HB RF port

4.2.4 Return Loss of HB TRX RF Ports

Table 14 Return Loss from HB TRX RF ports to HB Antenna

Frequency (MHz)	1710	1842	1960	1970	2017	2140	2170	2350	2593	2690	3500
TRx1	-40.6	-22.7	-18.3	-18.1	-17.1	-15.5	-15.2	-14.4	-17.4	-20.2	-14.5
TRx2	-25.8	-19.4	-16.4	-16.2	-15.4	-14.2	-13.9	-13.3	-15.6	-17.5	-18.2
TRx3	-27.5	-19.1	-15.6	-15.4	-14.5	-13	-12.6	-11.7	-13.1	-14.4	-17.7
TRx4	-24.6	-17	-13.4	-13.1	-12.2	-10.4	-10	-10	-10	-10	-13.1
TRx5	-20.5	-16.4	-14	-13.9	-13.3	-12.1	-11.8	-11	-11.8	-12.5	-24.4
TRx6	-18.2	-14.7	-12.6	-12.5	-11.9	-10.8	-10.5	-10	-10.2	-10.7	-18.1

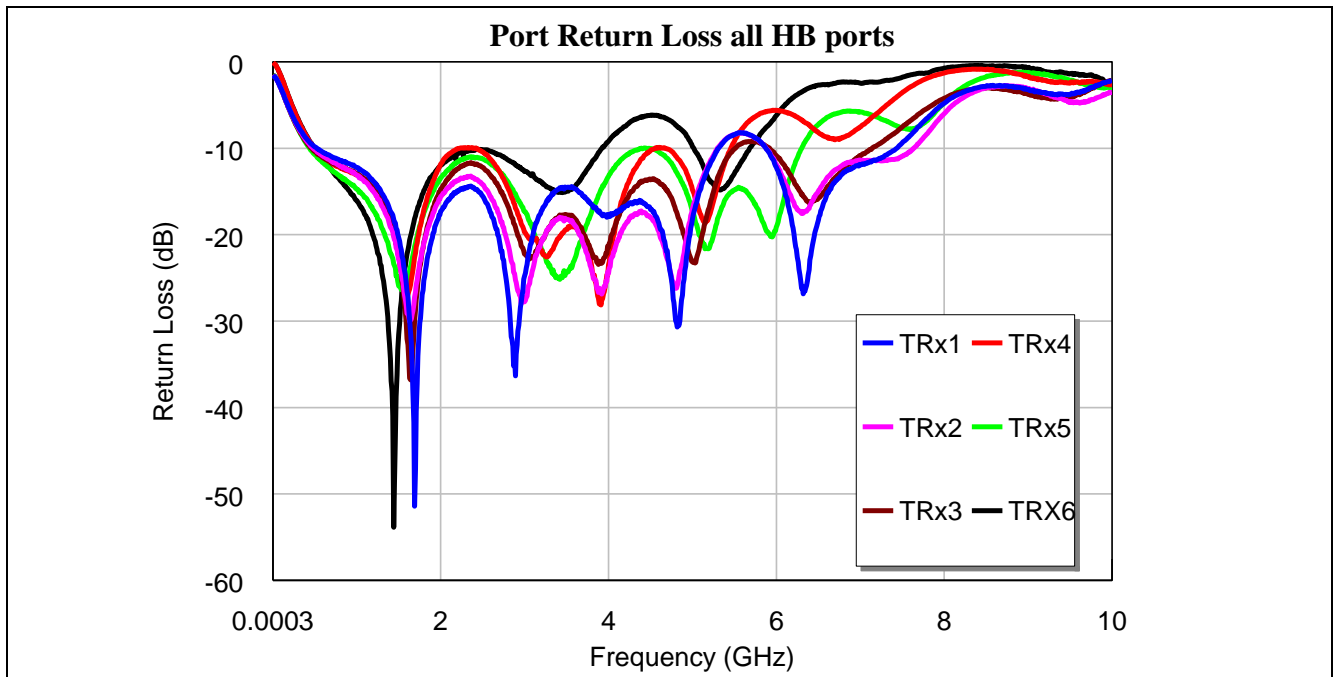

Figure 24 Return Loss from HB TRX RF ports to HB Antenna

4.2.5 Return Loss of HB TX RF Port

Table 15 Return Loss of HB TX RF port

Frequency (MHz)	1710	1842	1960	1970	2017	2140	2170	2350	2593	2690	3500
ANTHB	-20.1	-23.7	-17	-16.6	-14.5	-	-	-	-	-	-
TX HB	-24.5	-16.1	-14.5	-14.2	-12.9	-	-	-	-	-	-

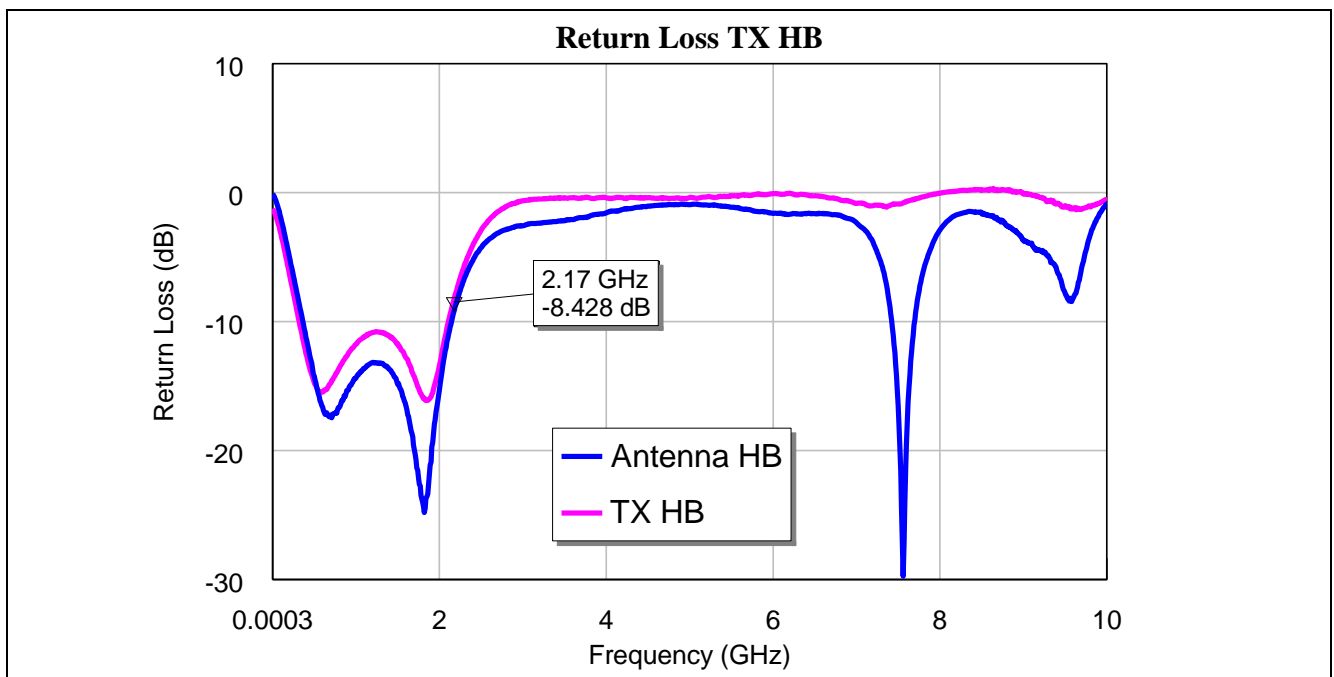

Figure 25 Return Loss of HB TX RF port



4.2.6 Antenna to port and Port to Port Isolation HB path

Apply to the [Table 16](#) and [Table 17](#) on the next page.

Table 16 Worst case Antenna to Port Isolation High Band part¹

Frequency (GHz)	TX HB active		TRX1 active		TRX2 active		TRX3 active		TRX4 active		TRX5 active		TRX6 active	
	ANTHB TRX1	ANTHB TX LB	ANTHB TRX2	ANTHB TX HB	ANTHB TRX3	ANTHB TRX1	ANTHB TRX4	ANTHB TRX2	ANTHB TRX5	ANTHB TRX3	ANTHB TRX6	ANTHB TRX4	ANTHB ANT LB	ANTHB TRX5
0.704	-39	-41	-35	-45	-35	-37	-34	-33	-41	-34	-43	-38	-43	-38
0.716	-39	-41	-34	-45	-35	-37	-34	-33	-41	-34	-42	-37	-43	-38
0.74	-39	-41	-34	-45	-34	-36	-34	-32	-40	-34	-42	-37	-43	-38
0.751	-39	-40	-34	-45	-34	-36	-34	-32	-40	-33	-42	-37	-43	-38
0.824	-38	-38	-33	-44	-33	-36	-33	-32	-39	-33	-40	-36	-42	-37
0.881	-37	-37	-33	-43	-33	-35	-33	-31	-38	-32	-39	-36	-41	-37
0.915	-37	-36	-32	-43	-33	-35	-32	-31	-38	-32	-38	-35	-40	-36
0.942	-37	-36	-32	-43	-32	-35	-32	-31	-38	-32	-38	-35	-40	-36
1.71	-31	-39	-29	-37	-29	-31	-29	-27	-31	-29	-29	-32	-39	-31
1.842	-30	-39	-29	-37	-28	-31	-29	-27	-30	-28	-28	-32	-40	-30
1.96	-29	-40	-28	-38	-28	-30	-29	-26	-30	-28	-27	-31	-44	-30
1.97	-29	-39	-28	-38	-28	-30	-29	-26	-30	-28	-27	-31	-45	-30
2.017	-29	-40	-28	-38	-28	-30	-29	-26	-30	-28	-26	-31	-48	-30
2.14	-30	-40	-27	-39	-27	-29	-28	-26	-29	-28	-26	-31	-47	-29
2.17	-30	-41	-27	-40	-27	-29	-28	-26	-29	-28	-25	-31	-42	-29
2.35	-33	-35	-26	-39	-26	-28	-27	-25	-29	-28	-24	-30	-26	-28
2.593	-50	-33	-25	-40	-25	-26	-26	-23	-28	-26	-23	-28	-31	-26
2.69	-46	-32	-24	-40	-24	-26	-25	-23	-28	-26	-22	-27	-32	-25
3.5	-26	-32	-22	-44	-22	-26	-20	-20	-23	-21	-18	-23	-32	-21

¹ Worst case isolation: Isolation between neighbor port of the active port, any other port have better (higher) Isolation

Antenna Switch Module with integrated MIPI RFFE Interface

Small Signal Characteristics of BGSF1717MN26



Table 17 Worst case Port to Port Isolation High Band part¹

Frequency (GHz)	TX HB active		TRX1 active		TRX2 active		TRX3 active		TRX4 active		TRX5 active		TRX6 active	
	TX HB TRX1	TX HB TX LB	TRX1 TRX2	TRX1 TX HB	TRX2 TRX3	TRX2 TRX1	TRX3 TRX4	TRX3 TRX2	TRX4 TRX5	TRX4 TRX3	TRX5 TRX6	TRX5 TRX4	TRX6 ANT LB	TRX6 TRX5
0.704	-37.3	-34	-33.1	-39.3	-33.2	-35	-32.9	-31.6	-38.8	-32.9	-41.5	-35.6	-49.1	-36.1
0.716	-37.2	-33.8	-32.9	-39.2	-33	-35	-32.7	-31.5	-38.7	-32.7	-41.4	-35.4	-49.1	-36.1
0.74	-36.9	-33.6	-32.6	-39.1	-32.7	-34.7	-32.6	-31.2	-38.4	-32.6	-41.1	-35.2	-48.8	-36.1
0.751	-37	-33.6	-32.6	-38.9	-32.6	-34.5	-32.5	-31.2	-38.2	-32.4	-40.8	-34.9	-47.6	-35.5
0.824	-36.3	-33	-32	-38.1	-32	-34	-31.8	-30.6	-37.2	-31.8	-39.5	-34.5	-46.6	-34.9
0.881	-35.8	-32.5	-31.5	-37.6	-31.5	-33.5	-31.3	-30.1	-36.6	-31.4	-38.4	-33.9	-44.9	-34.6
0.915	-35.4	-32.3	-31.3	-37.3	-31.2	-33.2	-31.2	-29.9	-36.3	-31.1	-37.9	-33.7	-44.1	-34.1
0.942	-35.3	-32	-31.2	-37	-31	-33	-30.9	-29.7	-36	-30.8	-37.4	-33.4	-43.4	-34
1.71	-30.3	-38.5	-25.8	-31.3	-25.3	-27.3	-26	-24.2	-28.4	-25.3	-28	-28.1	-41.7	-27.3
1.842	-29.3	-38.6	-24.8	-31.6	-24.4	-26.5	-25.1	-23.2	-27.5	-24.4	-27	-27.3	-42.8	-26.3
1.96	-28.5	-38.2	-24.1	-32.3	-23.6	-25.6	-24.4	-22.4	-26.8	-23.7	-26.1	-26.6	-46.2	-25.4
1.97	-28.5	-38.4	-24	-32.3	-23.5	-25.5	-24.4	-22.3	-26.7	-23.6	-26	-26.4	-47.2	-25.3
2.017	-28.3	-38.6	-23.7	-32.8	-23.2	-25.2	-24.1	-22	-26.4	-23.3	-25.7	-26.2	-50.9	-24.9
2.14	-28.4	-38.7	-22.9	-33.9	-22.3	-24.4	-23.3	-21.2	-25.6	-22.5	-24.9	-25.4	-49.8	-24.1
2.17	-28.6	-38.6	-22.7	-34.3	-22.2	-24.2	-23.1	-21	-25.6	-22.4	-24.8	-25.2	-44.6	-23.9
2.35	-31	-35.6	-21.7	-37.4	-21.1	-23.3	-21.9	-20	-24.7	-21.3	-23.8	-24	-28.4	-22.7
2.593	-35.5	-35.5	-20.4	-39.1	-19.8	-21.9	-20.3	-18.6	-23.6	-19.9	-22.4	-22.4	-33.1	-21.5
2.69	-38.1	-35.3	-19.9	-39.9	-19.4	-21.5	-19.6	-18.2	-23.2	-19.4	-22	-21.8	-34.4	-21
3.5	-42.7	-31.1	-19.6	-45.6	-18.5	-20.9	-17.7	-17.9	-21.1	-18.4	-18.8	-19.6	-33.3	-18.7

¹ Worst case isolation: Isolation between neighbor port of the active port, any other port have better (higher) Isolation

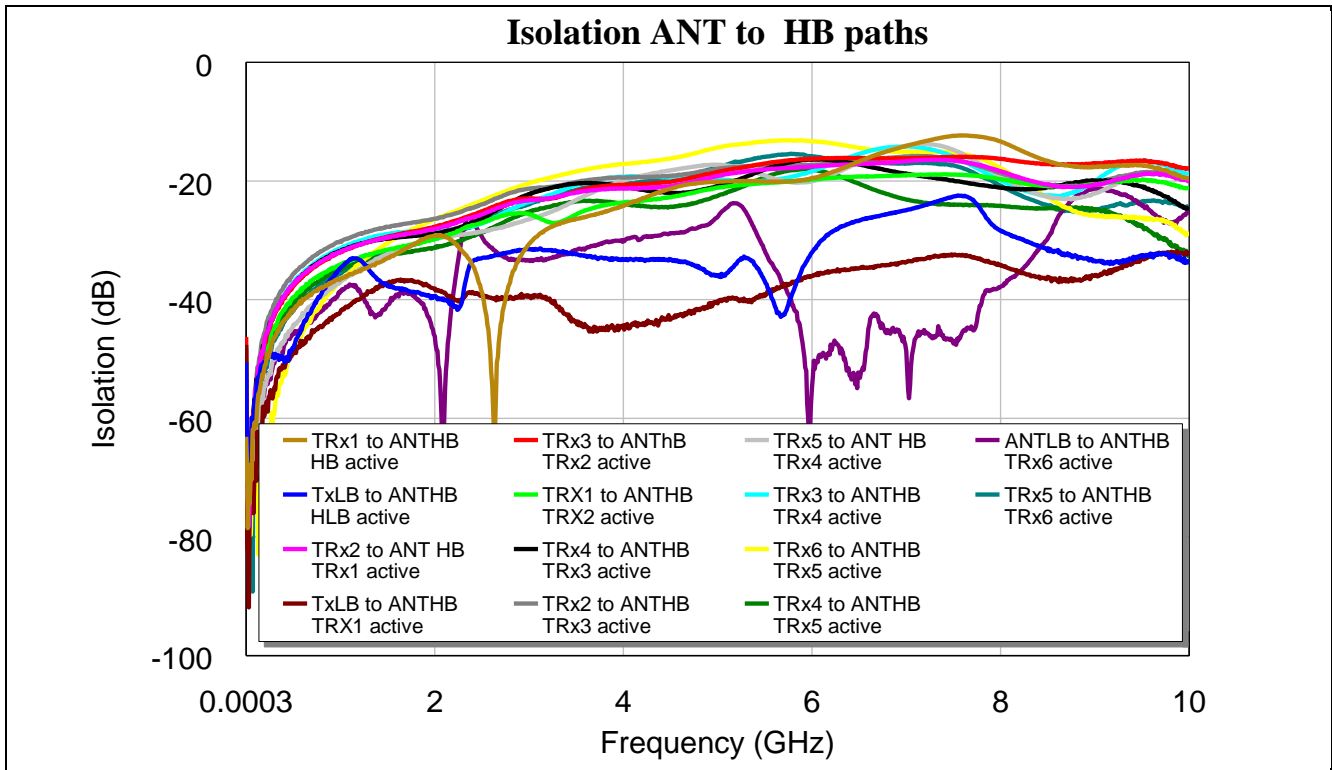

Figure 26 Worst case Antenna to Port Isolation High Band part¹

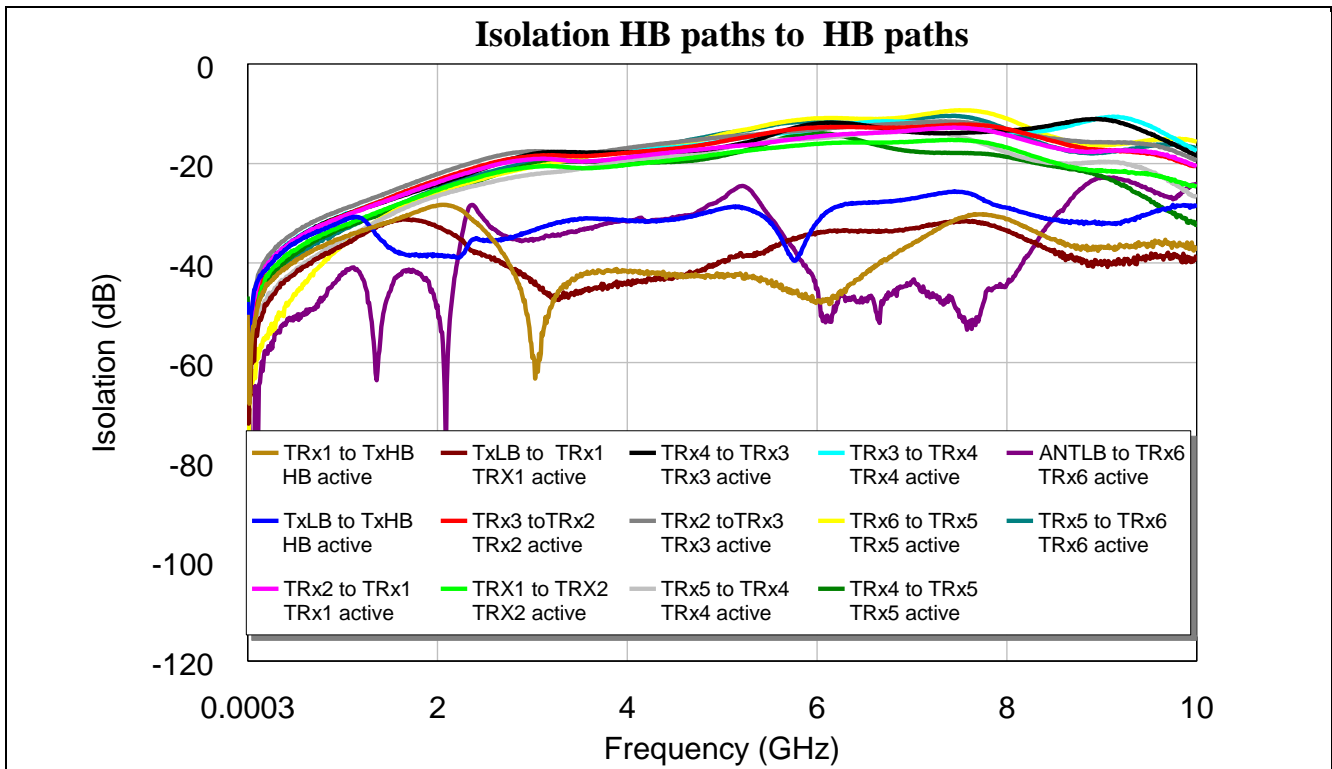

Figure 27 Worst case Port to Port Isolation High Band part¹

¹Worst case isolation: Isolation between neighbor port of the active port, any other port have better (higher) Isolation

5 Non-Linear performance of BGSF1717MN26

Smart phones today can operate across several cellular bands covering GSM / EDGE / CDMA / UMTS / WCDMA / LTE/TD-SCDMA / TD-LTE / LTE-A. The design of the RF front-end part in modern cellular phones is becoming increasingly complex and demanding due to the increasing number of frequency bands and modes that the phone needs to support. One of the main components of the RF front-end is the antenna switch that selects which transmitter (TX)/receiver (RX) path can be connected to the antenna. The RF switch has to satisfy high linearity requirements. The following material describes some of the main challenges of antenna switches in mobile applications.

Modern smartphones are multi-mode devices that are capable of connecting to 2G, 3G and 4G networks. These networks often use different frequency bands. The smartphone's RF frontend must therefore include band-specific components. In order to appropriately route signals for a given mode and band of operation, a high-performance RF switch is an essential component of the front-end circuitry. The performance requirements of the RF switch are discussed in the following sections.

5.1 Intermodulation

Intermodulation Distortion (IMD2 and IMD3) is a parameter that describes the linearity of a device under multi-tone conditions. The intermodulation between different frequency components generates undesired output frequencies at the sum and difference frequencies of the input tones, and at multiples of those sum and difference frequencies. Some of these possible intermodulation scenarios are shown in the [Figure 28](#).

In this example, the transmitted (Tx) signal from the main antenna is coupled into the diversity antenna with high power. This signal (20 dBm) and a received jammer signal (-15 dBm) are entering the switch. Certain combinations of the TX and jammer frequencies are producing second- and third-order intermodulation products that fall into the desired reception band, and reduce the sensitivity of the receiver.

In [Table 18](#) and [Table 20](#) test conditions Band I and V and the linearity specifications for an undisturbed communication are given.

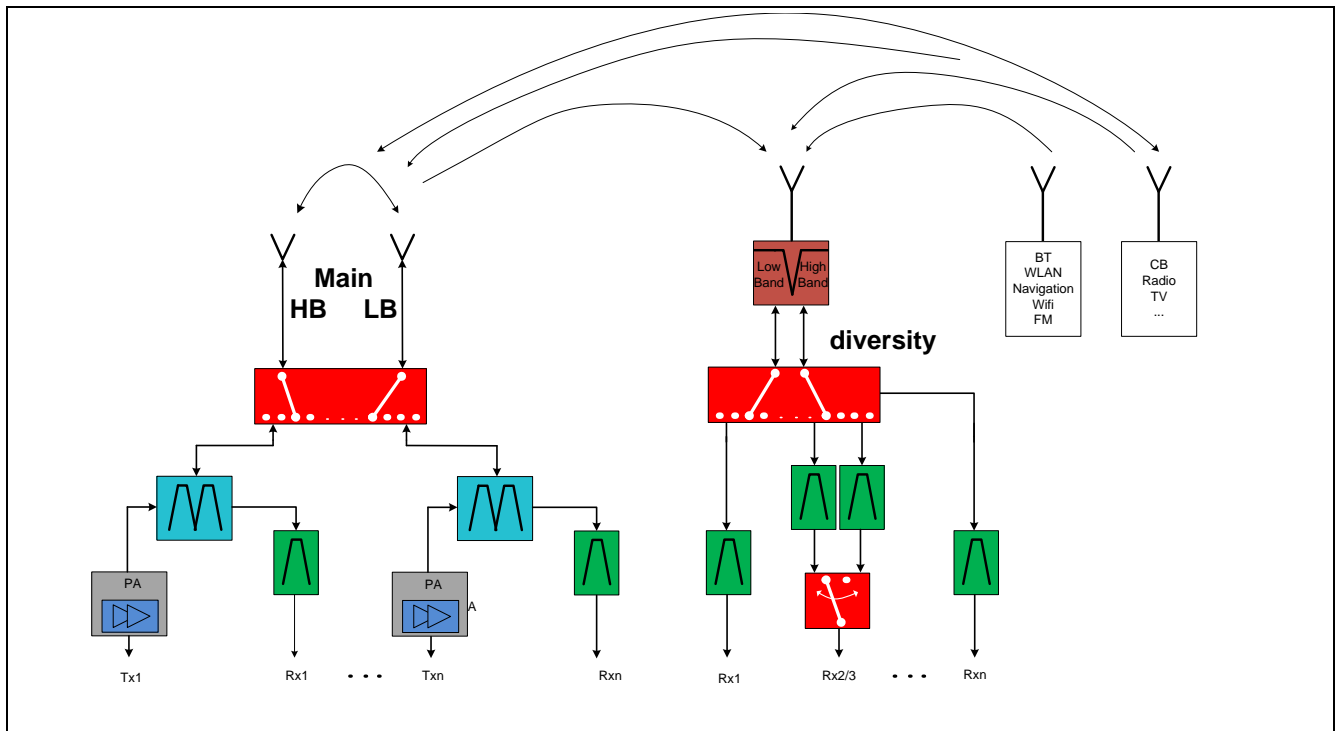

Figure 28 Block diagram of RF Switch intermodulation

5.1.1 Intermodulation Measurement Setup

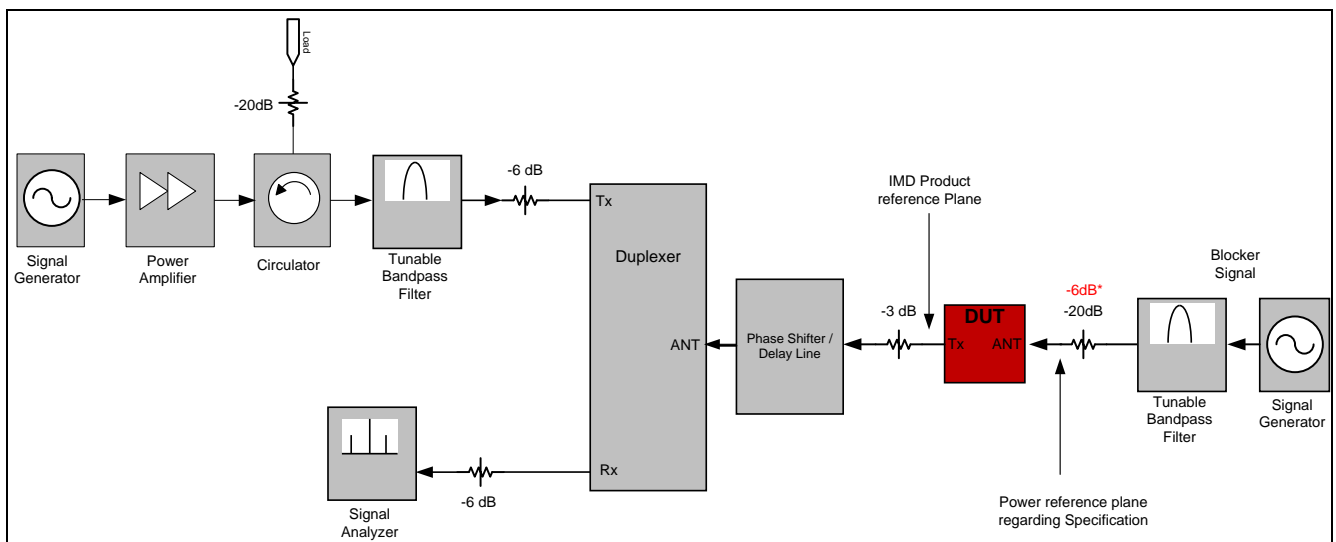

Figure 29 Intermodulation Measurement Test Setup

The test setup for the IMD measurements has to provide a very high isolation between RX and TX signals. As an example the test set-up for the high band is shown in the [Figure 29](#). In practice, a laboratory-graded duplexer with an isolation of 80 dB is used. In the [Figure 30](#) and [Figure 31](#) the results for IMD measurements in Band I and V are given. For each distortion scenario there is a minimum and a maximum value given. This variation is caused by a phase shifter connected between the switch and the duplexer. In the test set-up a phase shifter represents a not ideal matching of the switch to a 50 Ohm load.

5.1.2 Intermodulation Measurement conditions for Band I

Table 18 Test conditions and specifications of IMD measurements

Band 1					
	TX		Interferer		IMD product
Test case	F _{IN} (MHz)	P _{IN} (dBm) CW	F _{IN} (MHz)	P _{IN} (dBm) CW	F _{IMD} (MHz)
IMD3	1950	20	1760	-15	2140
IMD2 low			190		
IMD2 high			4090		

5.1.3 Intermodulation Measurement Results for Band I

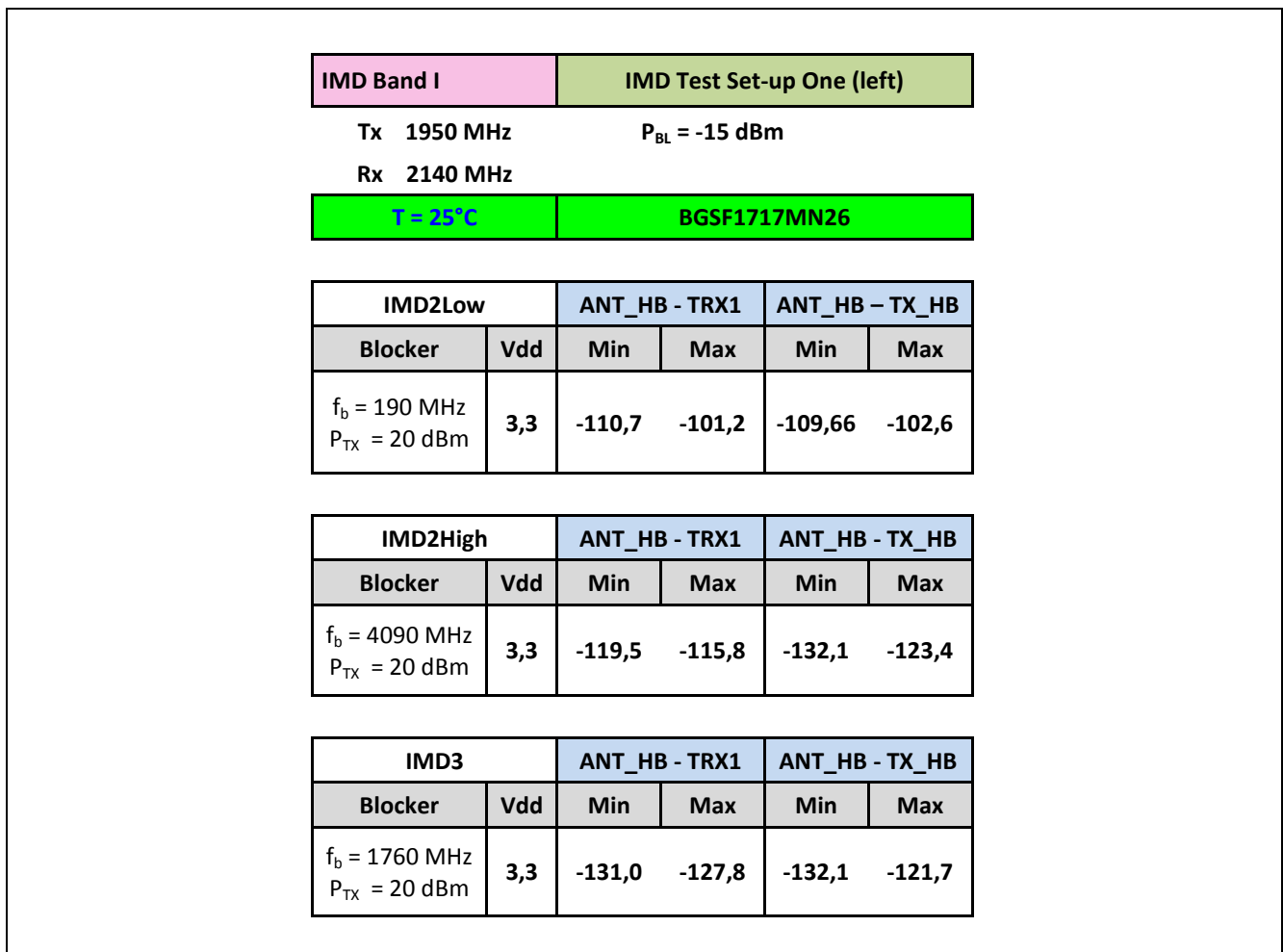

Figure 30 Intermodulation measurement results for Band I

Table 19 Typical and maximal value of intermodulation products in dBm for Band I

IMD2 Low		IMD2 High		IMD3	
Typ.	Max.	Typ.	Max.	Typ.	Max.
-106,0	-101,2	-122,7	-115,8	-128,2	-121,7

5.1.4 Intermodulation Measurement conditions for Band V

Table 20 Test conditions and specifications of IMD measurements

Band 1					
	TX		Interferer		IMD product
Testcase	F _{IN} (MHz)	P _{IN} (dBm) CW	F _{IN} (MHz)	P _{IN} (dBm) CW	F _{IMD} (MHz)
IMD3	835	20	790	-15	880
IMD2 low			45		
IMD2 high			1715		

5.1.5 Intermodulation Measurement Results for Band V

IMD Band V		IMD Test Set-up One (left)									
Tx 835 MHz		P _{BL} = -15 dBm									
Rx 880 MHz											
T = 25°C		BGSF1717MN26									
IMD2Low		ANT_HB - TRX1		ANT_HB - TX_HB		ANT_LB - TX_LB		ANT_LB - TRX7		ANT_LB - TRX10	
Blocker	Vdd	Min	Max	Min	Max	Min	Max	Min	Max	Min	Max
f _b = 45 MHz P _{TX} = 20 dBm	3,3	-105,7	-102,4	-103,7	-102,1	-108,9	-104,5	-106,9	-102,6	-107,4	-103,6
IMD2High		ANT_HB - TRX1		ANT_HB - TX_HB		ANT_LB - TX_LB		ANT_LB - TRX7		ANT_LB - TRX10	
Blocker	Vdd	Min	Max	Min	Max	Min	Max	Min	Max	Min	Max
f _b = 790 MHz P _{TX} = 20 dBm	3,3	-134,1	-127,8	-134,4	-127,5	-133,9	-126,3	-135,7	-128,1	-134,9	-127,8
IMD3		ANT_HB - TRX1		ANT_HB - TX_HB		ANT_LB - TX_LB		ANT_LB - TRX7		ANT_LB - TRX10	
Blocker	Vdd	Min	Max	Min	Max	Min	Max	Min	Max	Min	Max
f _b = 1715 MHz P _{TX} = 20 dBm	3,3	-132,4	-127,6	-136,0	-129,9	-132,4	-128,5	-135,7	-125,7	-134,0	-127,2

Figure 31 Intermodulation measurement results for Band V

Table 21 Typical and maximal value of intermodulation products in dBm for Band V

IMD2 Low		IMD2 High		IMD3	
Typ.	Max.	Typ.	Max.	Typ.	Max.
-104,8	-102,4	-131,1	-126,3	-130,9	-125,7

5.2 Harmonic Distortion

Harmonic distortion is another important parameter for the characterization of an RF switch. RF switches have to withstand high RF levels, up to 36 dBm. This high RF power at the input of a switch generates harmonics of the waveform that is present. These harmonics (2nd and 3rd) can interfere with other reception bands or can cause distortion in other RF applications (GPS, WLAN) within the mobile phone.

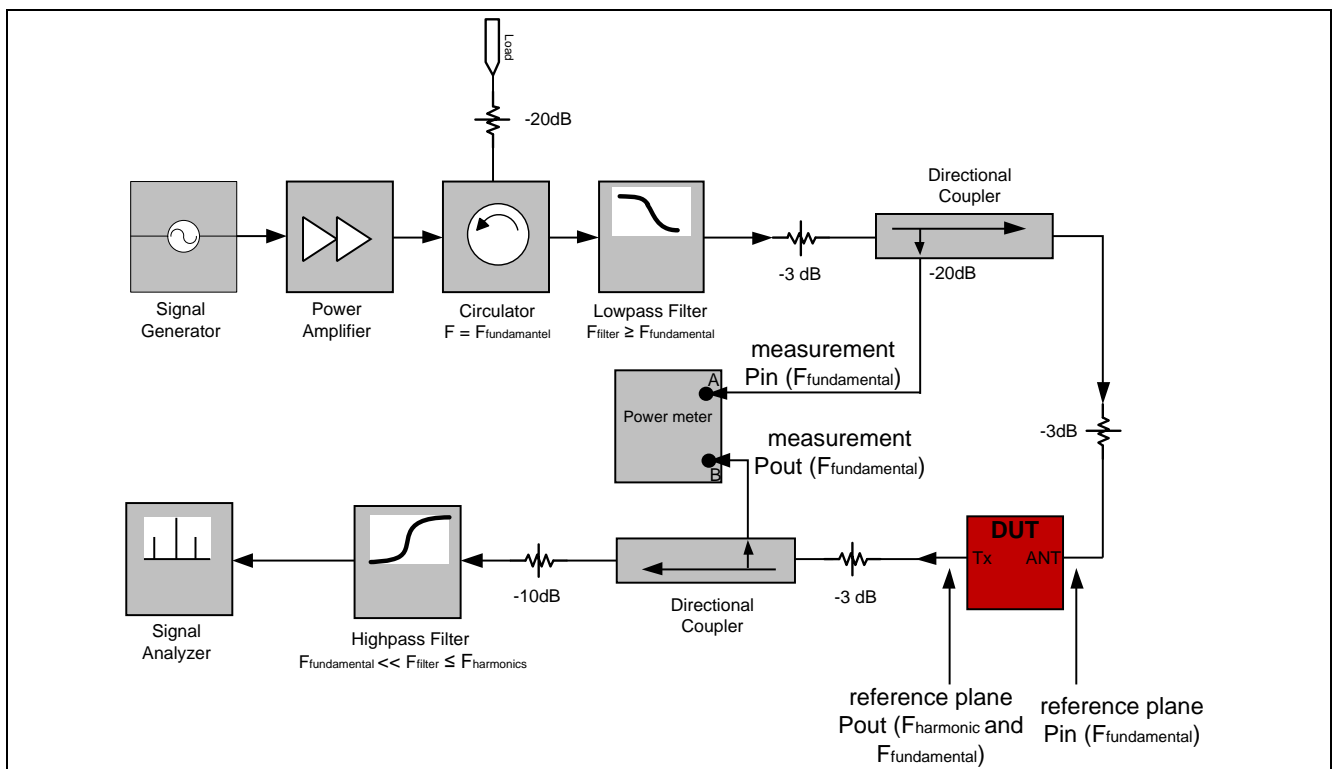

Figure 32 Harmonic Generation Measurement setup

5.2.1 Harmonic Generation Measurement conditions

Table 22 Harmonic Generation measurement Conditions

Tx		Harmonic Products	
F_{IN} (MHz)	P_{IN} (dBm), 50% DC	F_{H2} (MHz)	F_{H3} (MHz)
824	20...36 TX LB port	1648	2472
	20...27 TRX LB ports		
1800	20...36 TX HB port	3600	3600
	20...27 TRX HB ports		

The result for the harmonic generation at 824 MHz and 1800 MHz is shown in the [Figure 33](#) and [Figure 35](#). The input power (P_{IN}) is plotted on the X-Axis, and the generated harmonic amplitude is given in **dBm** on the Y-Axis.

5.2.2 Harmonic Generation Measurement Results of Low Band inputs

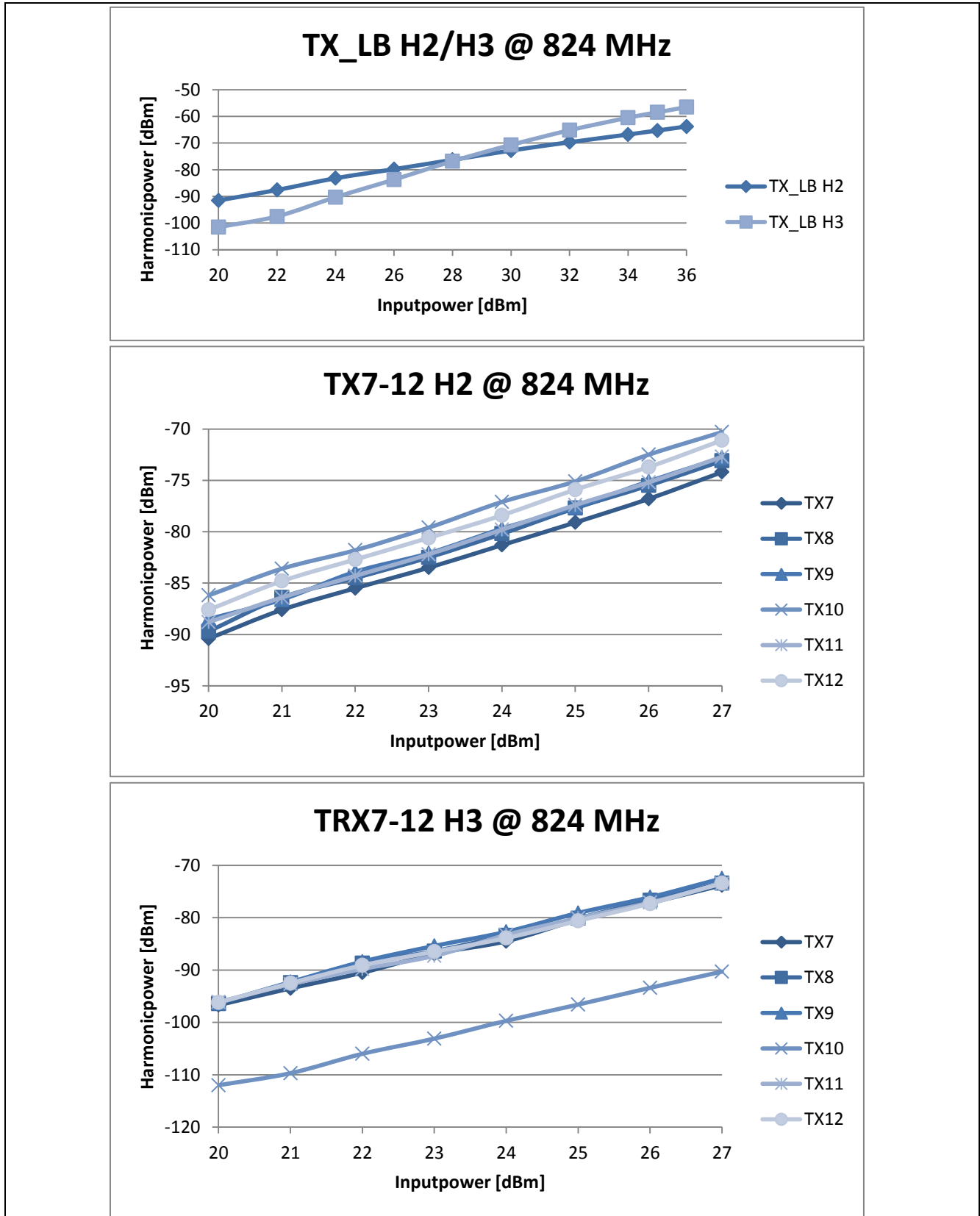

Figure 33 Measurements of Harmonic power over Carrier power of Low-Band inputs to LB Antenna

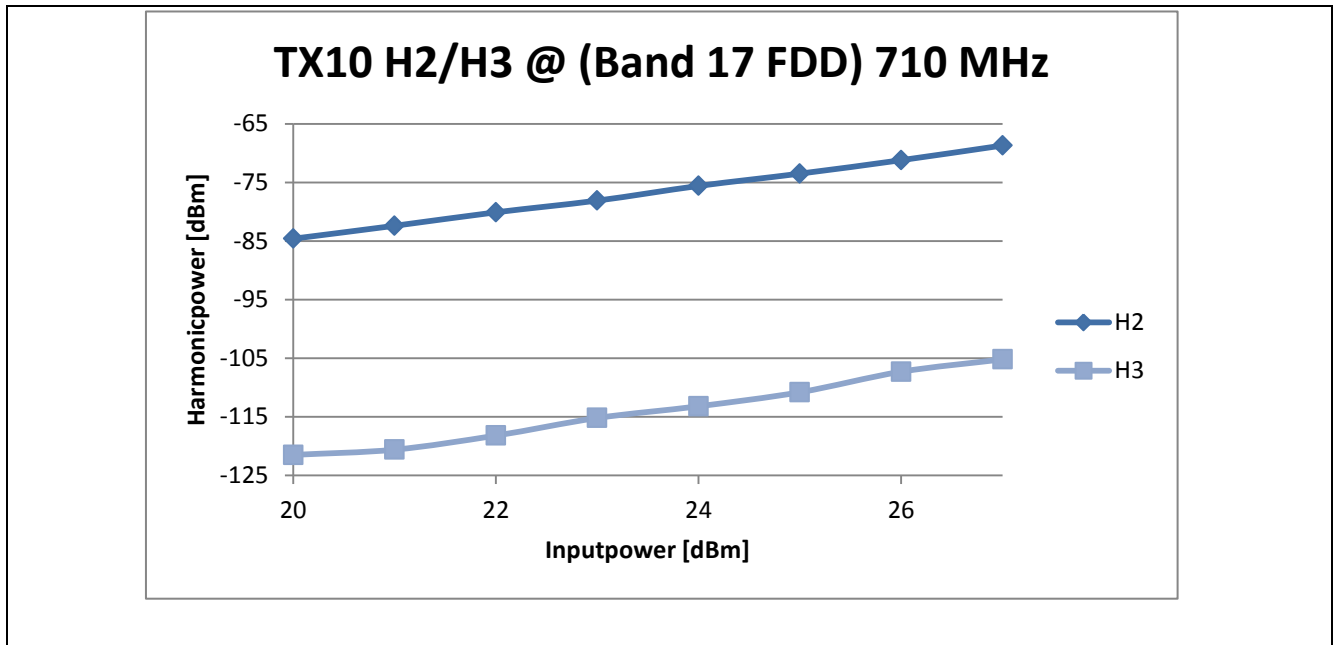

Figure 34 Harmonic power measurements of high linear LB input TRX10 over the Band 17 carrier

In **Figure 34** the generated harmonic power of a very high linear input TX10 is shown measured at the operating frequency of Band 17 FDD (710 MHz). The spacing between the carrier frequency and the generated harmonic at the maximum operated power sets up **to 98 dBc for H2 and 133 dBc for H3**. This is an outstanding performance among other competitors.

5.2.3 Harmonic Generation Measurement Results of High Band inputs

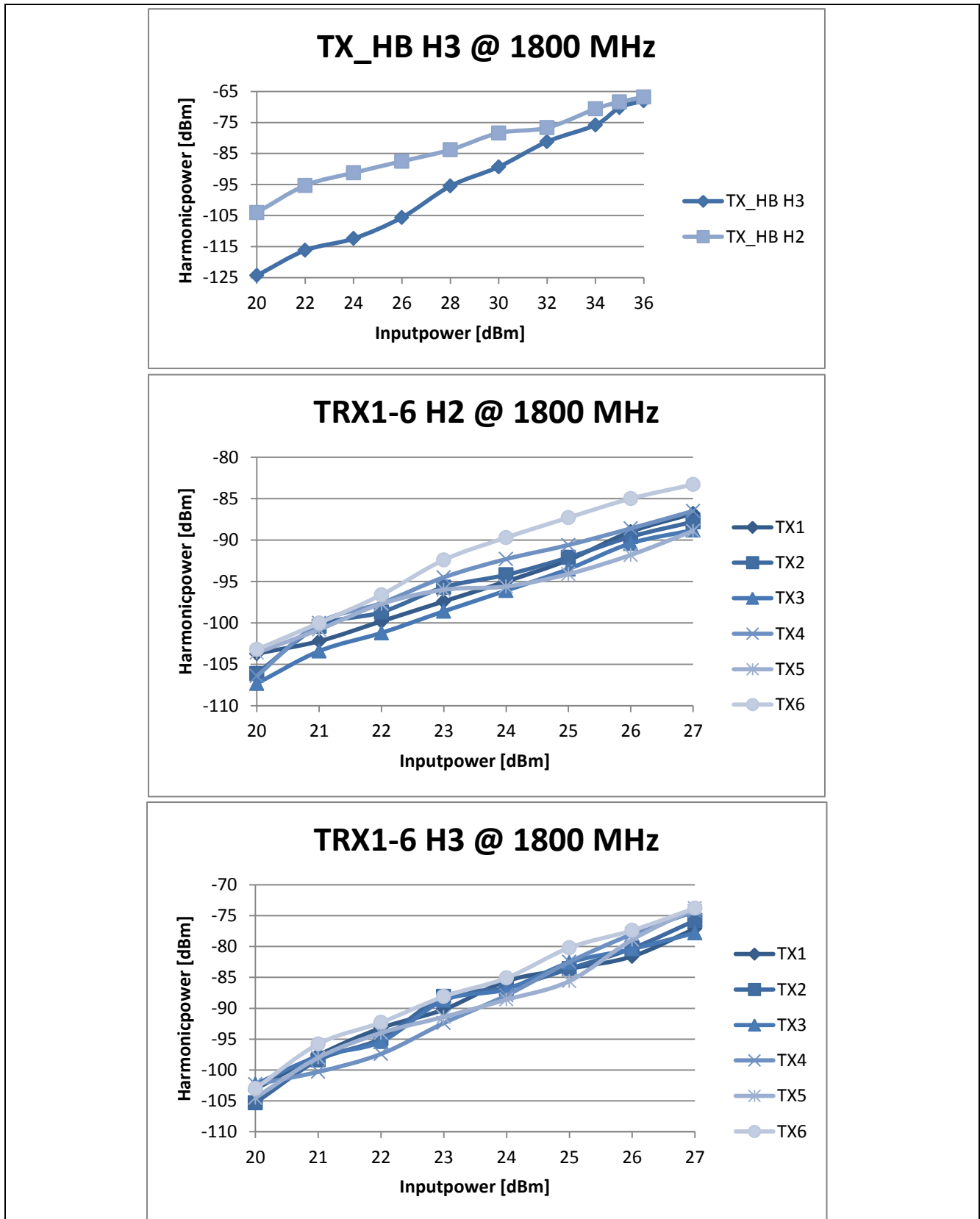

Figure 35 Measurements of Harmonic power over Carrier power of High-Band inputs to HB Antenna

6 Switching time

Table 23 Switching time values

Parameter	Symbol	Values			Unit	Note / Test Conditions
		Min.	Typ.	Max.		
Switching Time						
On/Off	$t_{on/off}$	-	1	-	μs	10% ON to 90% ON; 90% OFF to 10% OFF
Boost Converter Settling Time	t_{BC}	-	-	25	μs	After power down mode

For a “switching time” measurement a signal generator and a digital oscilloscope is used. A 100 MHz continuous sine signal with 0 dBm signal level was switched to all LB and HB inputs one after another. The output of the switch connected from one side either to HB Antenna or to LB Antenna and from the other side to a digital oscilloscope. Typical time required to raise the signal power from 10% ON Mode up to 90 % ON of the Signal Level lies by 1 μs . In the **Figure 36** the switching time of the TX_LB input is shown. Maximum time required between switch power-up till being able to switch to desired RF-path is 25 μs .

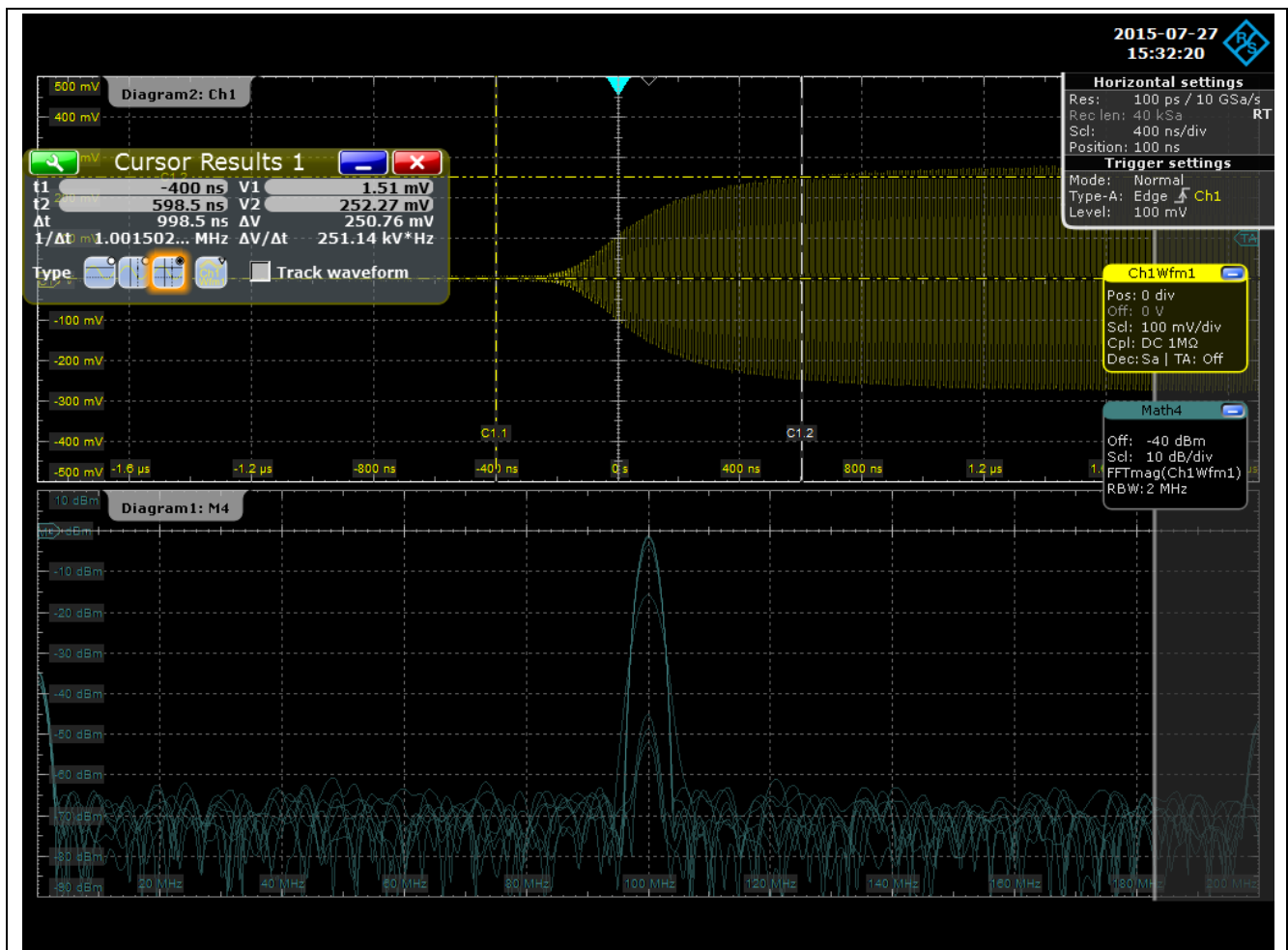

Figure 36 Switching time measurements of the TX_LB input to the LB Antenna

7 Appendix: Switch Controller Unit

The BGSF1717MN26 is controlled via MIPI interface and Infineon offers a MIPI-Controller unit to ease the evaluation of its BGSF1717MN26 on application board. The unit is very simple to use with a few buttons to select the right device and different states. This section helps as a short user guide for the controller unit shown in **Figure 37**. The controller unit requires a DC supply of 5.5V with a current capability of ~50mA.

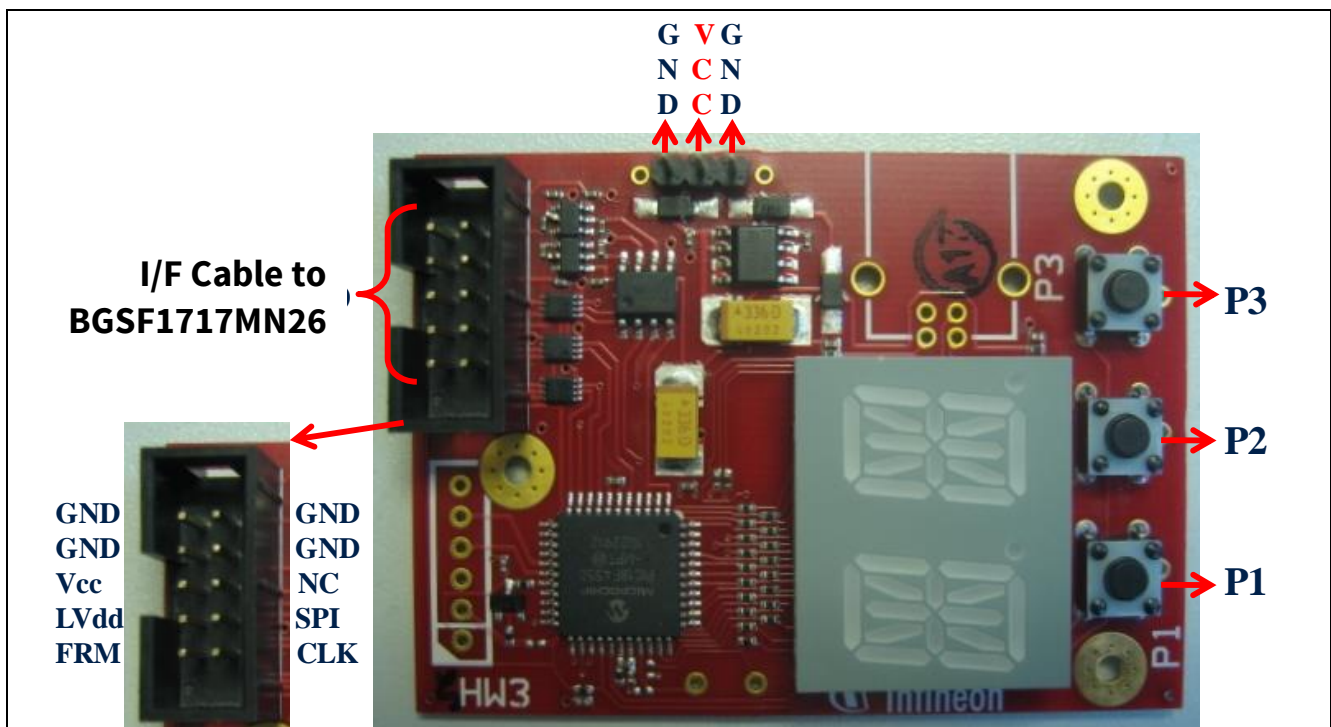

Figure 37 Switch Controller Unit Board

7.1 Operating Guide

Please observe the following steps to use the controller unit:

1. Connect evaluation board and control unit via controller cable
2. Connect control unit to power supply
3. Press P1 and P3 simultaneously until desired switch type is displayed
 - “77” for BGSF1717MN26
4. Press P1 or P3 to enable active mode “PU” is displayed
5. Press P1 or P3 to alter switch state
 - IS ... Isolation Mode (all channels off)
 - PD ... Power Down Mode (low current consumption)
 - PU ... Power Up Mode (active mode)
 - T1 – TC and LB, HB ... TRX1 – TRX12 and TX LB and TXHB are enabled



7.2 Display Settings of the Controller Unit

Table 24 Setting Display of Active RF Path, Power UP, Power Down and Isolation State

LED Display	State of BGSF1717MN26
T1	TRX1
T2	TRX2
T3	TRX3
T4	TRX4
T5	TRX5
T6	TRX6
T7	TRX7
T8	TRX8
T9	TRX9
TA	TRX10
TB	TRX11
TC	TRX12
LB	TX LB
HB	TX LB
IS	Isolation State
PU	Power Up State
PD	Power Down State



8 Authors

Andre Dewai, Senior Application Engineer of the Business Unit “RF and Sensors”

Sergey Karpov, Application Engineer of the Business Unit “RF and Sensors”



Remark

- 1) The graphs are generated with the simulation program AWR Microwave Office®.

Revision History

Major changes since the last revision

Page or Reference	Description of change
	This is 1 st version (Rev. 1.0)

Trademarks of Infineon Technologies AG

AURIX™, C166™, CanPAK™, CIPOS™, CIPURSE™, CoolGaN™, CoolMOS™, CoolSET™, CoolSiC™, CORECONTROL™, CROSSAVE™, DAVE™, DI-POL™, DrBLADE™, EasyPIM™, EconoBRIDGE™, EconoDUAL™, EconoPACK™, EconoPIM™, EiceDRIVER™, eupec™, FCOS™, HITFET™, HybridPACK™, ISOFACE™, IsoPACK™, i-Wafer™, MIPAQ™, ModSTACK™, my-d™, NovalithIC™, OmniTune™, OPTIGA™, OptiMOS™, ORIGA™, POWERCODE™, PRIMARION™, PrimePACK™, PrimeSTACK™, PROFET™, PRO-SiL™, RASIC™, REAL3™, ReverSave™, SatRIC™, SIEGET™, SIPMOS™, SmartLEWIS™, SOLID FLASH™, SPOC™, TEMPFET™, thinQ!™, TRENCHSTOP™, TriCore™.

Other Trademarks

Advance Design System™ (ADS) of Agilent Technologies, AMBA™, ARM™, MULTI-ICE™, KEIL™, PRIMECELL™, REALVIEW™, THUMB™, µVision™ of ARM Limited, UK. ANSI™ of American National Standards Institute. AUTOSAR™ of AUTOSAR development partnership. Bluetooth™ of Bluetooth SIG Inc. CAT-ig™ of DECT Forum. COLOSSUS™, FirstGPS™ of Trimble Navigation Ltd. EMV™ of EMVCo, LLC (Visa Holdings Inc.). EPCOS™ of Epcos AG. FLEXGO™ of Microsoft Corporation. HYPERTERMINAL™ of Hilgraeve Incorporated. MCS™ of Intel Corp. IEC™ of Commission Electrotechnique Internationale. IrDA™ of Infrared Data Association Corporation. ISO™ of INTERNATIONAL ORGANIZATION FOR STANDARDIZATION. MATLAB™ of MathWorks, Inc. MAXIM™ of Maxim Integrated Products, Inc. MICROTEC™, NUCLEUS™ of Mentor Graphics Corporation. MIPI™ of MIPI Alliance, Inc. MIPS™ of MIPS Technologies, Inc., USA. muRata™ of MURATA MANUFACTURING CO., MICROWAVE OFFICE™ (MWO) of Applied Wave Research Inc., OmniVision™ of OmniVision Technologies, Inc. Openwave™ of Openwave Systems Inc. RED HAT™ of Red Hat, Inc. RFMD™ of RF Micro Devices, Inc. SIRIUS™ of Sirius Satellite Radio Inc. SOLARIS™ of Sun Microsystems, Inc. SPANSION™ of Spansion LLC Ltd. Symbian™ of Symbian Software Limited. TAIYO YUDEN™ of Taiyo Yuden Co. TEAKLITE™ of CEVA, Inc. TEKTRONIX™ of Tektronix Inc. TOKO™ of TOKO KABUSHIKI KAISHA TA. UNIX™ of X/Open Company Limited. VERILOG™, PALLADIUM™ of Cadence Design Systems, Inc. VLYNQ™ of Texas Instruments Incorporated. VXWORKS™, WIND RIVER™ of WIND RIVER SYSTEMS, INC. ZETEX™ of Diodes Zetex Limited.

Last Trademarks Update 2014-07-17

www.infineon.com

Edition 2015-10-03

Published by

Infineon Technologies AG

81726 Munich, Germany

© 2016 Infineon Technologies AG.

All Rights Reserved.

Do you have a question about any aspect of this document?

Email: erratum@infineon.com

Document reference

AN_2014_11_PL32_003

Legal Disclaimer

THE INFORMATION GIVEN IN THIS APPLICATION NOTE (INCLUDING BUT NOT LIMITED TO CONTENTS OF REFERENCED WEBSITES) IS GIVEN AS A HINT FOR THE IMPLEMENTATION OF THE INFINEON TECHNOLOGIES COMPONENT ONLY AND SHALL NOT BE REGARDED AS ANY DESCRIPTION OR WARRANTY OF A CERTAIN FUNCTIONALITY, CONDITION OR QUALITY OF THE INFINEON TECHNOLOGIES COMPONENT. THE RECIPIENT OF THIS APPLICATION NOTE MUST VERIFY ANY FUNCTION DESCRIBED HEREIN IN THE REAL APPLICATION. INFINEON TECHNOLOGIES HEREBY DISCLAIMS ANY AND ALL WARRANTIES AND LIABILITIES OF ANY KIND (INCLUDING WITHOUT LIMITATION WARRANTIES OF NON-INFRINGEMENT OF INTELLECTUAL PROPERTY RIGHTS OF ANY THIRD PARTY) WITH RESPECT TO ANY AND ALL INFORMATION GIVEN IN THIS APPLICATION NOTE.

Information

For further information on technology, delivery terms and conditions and prices, please contact the nearest Infineon Technologies Office (www.infineon.com).

Warnings

Due to technical requirements, components may contain dangerous substances. For information on the types in question, please contact the nearest Infineon Technologies Office. Infineon Technologies components may be used in life-support devices or systems only with the express written approval of Infineon Technologies, if a failure of such components can reasonably be expected to cause the failure of that life-support device or system or to affect the safety or effectiveness of that device or system. Life support devices or systems are intended to be implanted in the human body or to support and/or maintain and sustain and/or protect human life. If they fail, it is reasonable to assume that the health of the user or other persons may be endangered.