



Is Now Part of



ON Semiconductor®

To learn more about ON Semiconductor, please visit our website at
www.onsemi.com

ON Semiconductor and the ON Semiconductor logo are trademarks of Semiconductor Components Industries, LLC dba ON Semiconductor or its subsidiaries in the United States and/or other countries. ON Semiconductor owns the rights to a number of patents, trademarks, copyrights, trade secrets, and other intellectual property. A listing of ON Semiconductor's product/patent coverage may be accessed at www.onsemi.com/site/pdf/Patent-Marking.pdf. ON Semiconductor reserves the right to make changes without further notice to any products herein. ON Semiconductor makes no warranty, representation or guarantee regarding the suitability of its products for any particular purpose, nor does ON Semiconductor assume any liability arising out of the application or use of any product or circuit, and specifically disclaims any and all liability, including without limitation special, consequential or incidental damages. Buyer is responsible for its products and applications using ON Semiconductor products, including compliance with all laws, regulations and safety requirements or standards, regardless of any support or applications information provided by ON Semiconductor. "Typical" parameters which may be provided in ON Semiconductor data sheets and/or specifications can and do vary in different applications and actual performance may vary over time. All operating parameters, including "Typicals" must be validated for each customer application by customer's technical experts. ON Semiconductor does not convey any license under its patent rights nor the rights of others. ON Semiconductor products are not designed, intended, or authorized for use as a critical component in life support systems or any FDA Class 3 medical devices or medical devices with a same or similar classification in a foreign jurisdiction or any devices intended for implantation in the human body. Should Buyer purchase or use ON Semiconductor products for any such unintended or unauthorized application, Buyer shall indemnify and hold ON Semiconductor and its officers, employees, subsidiaries, affiliates, and distributors harmless against all claims, costs, damages, and expenses, and reasonable attorney fees arising out of, directly or indirectly, any claim of personal injury or death associated with such unintended or unauthorized use, even if such claim alleges that ON Semiconductor was negligent regarding the design or manufacture of the part. ON Semiconductor is an Equal Opportunity/Affirmative Action Employer. This literature is subject to all applicable copyright laws and is not for resale in any manner.

1N4148WS, 1N4448WS, 1N914BWS

Small Signal Diodes

Features

- General Purpose Diodes
- Fast Switching Device ($T_{RR} < 4.0$ ns)
- Very Small and Thin SMD Package
- Moisture Level Sensitivity 1
- Matte Tin (Sn) Lead Finish
- Green Mold Compound
- Pb-free Version and RoHS Compliant

ABSOLUTE MAXIMUM RATINGS

Parameter	Symbol	Value	Unit
Non-Repetitive Peak Reverse Voltage	V_{RSM}	100	V
Repetitive Peak Reverse Voltage	V_{RRM}	75	V
Repetitive Peak Forward Current	I_{FRM}	300	mA
Continuous Forward Current	I_O	150	mA
Non-repetitive Peak Forward Surge Current Pulse Width = 1.0 s Pulse Width = 1.0 μ s	I_{FSM}	1.0 4.0	A
Operating Junction Temperature	T_J	+150	$^{\circ}$ C
Storage Temperature Range	T_{STG}	-55 to +150	$^{\circ}$ C

Stresses exceeding those listed in the Maximum Ratings table may damage the device. If any of these limits are exceeded, device functionality should not be assumed, damage may occur and reliability may be affected.

ORDERING INFORMATION

Part Number	Top Mark	Package	Packing Method
1N4148WS	S1	SOD-323F 2L	Tape and Reel
1N4448WS	S2	SOD-323F 2L	Tape and Reel
1N914BWS	S3	SOD-323F 2L	Tape and Reel



ON Semiconductor™

www.onsemi.com

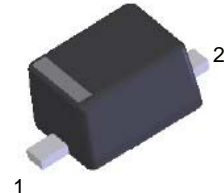

SOD-323
Flat Lead
CASE 477AB

Band Indicates Cathode

ELECTRICAL SYMBOL

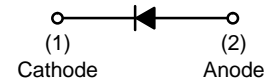

1N4148WS, 1N4448WS, 1N914BWS

THERMAL CHARACTERISTICS (Values are at $T_A = 25^\circ\text{C}$ unless otherwise noted.)

Symbol	Parameter	Value	Unit
P_D	Power Dissipation ($T_C = 25^\circ\text{C}$)	200	mW
$R_{\theta JA}$	Thermal Resistance, Junction-to-Ambient (Note 1)	500	$^\circ\text{C}/\text{W}$

1. Device mounted on FR-4 PCB minimum land pad.

ELECTRICAL CHARACTERISTICS (Values are at $T_A = 25^\circ\text{C}$ unless otherwise noted.)

Symbol	Parameter		Conditions	Min	Max	Unit
BV_R	Breakdown Voltage		$I_R = 100 \mu\text{A}$	100		V
			$I_R = 5 \mu\text{A}$	75		
I_R	Reverse Current		$V_R = 20 \text{ V}$		25	nA
			$V_R = 75 \text{ V}$		5	μA
V_F	Forward Voltage	1N4448WS / 1N914BWS	$I_F = 5 \text{ mA}$	0.62	0.72	V
		1N4148WS	$I_F = 10 \text{ mA}$		1	
		1N4448WS / 1N914BWS	$I_F = 100 \text{ mA}$		1	
C_O	Diode Capacitance		$V_R = 0, f = 1.0 \text{ MHz}$		4	pF
T_{RR}	Reverse Recovery Time		$I_F = 10 \text{ mA}, I_R = 60 \text{ mA}, I_{RR} = 1 \text{ mA}, R_L = 100 \Omega$		4	ns

Product parametric performance is indicated in the Electrical Characteristics for the listed test conditions, unless otherwise noted. Product performance may not be indicated by the Electrical Characteristics if operated under different conditions.

1N4148WS, 1N4448WS, 1N914BWS

TYPICAL CHARACTERISTICS

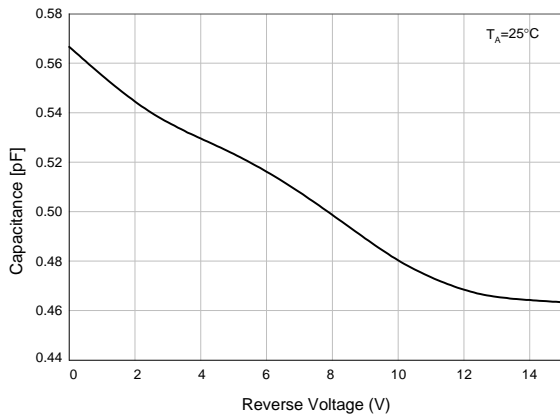

Figure 1. Total Capacitance

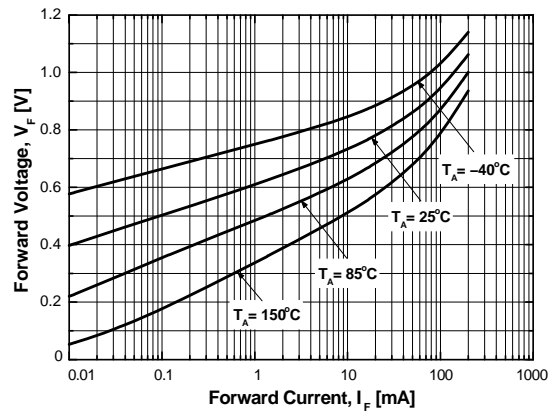

Figure 2. Forward Voltage vs. Ambient Temperature

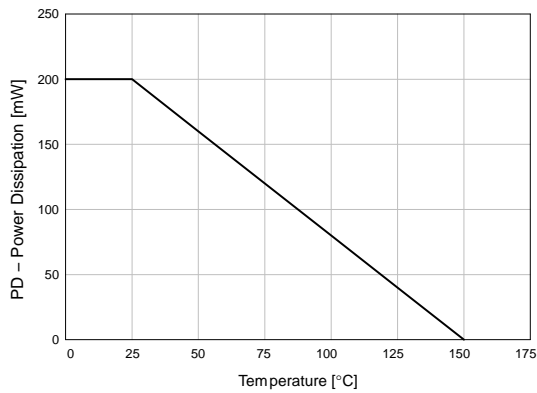

Figure 3. Power Derating Curve

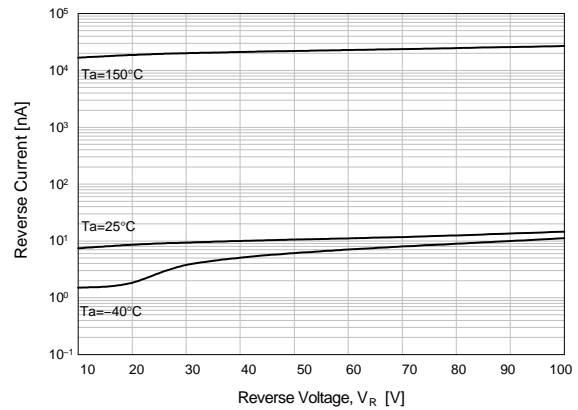

Figure 4. Reverse Current vs. Reverse Voltage

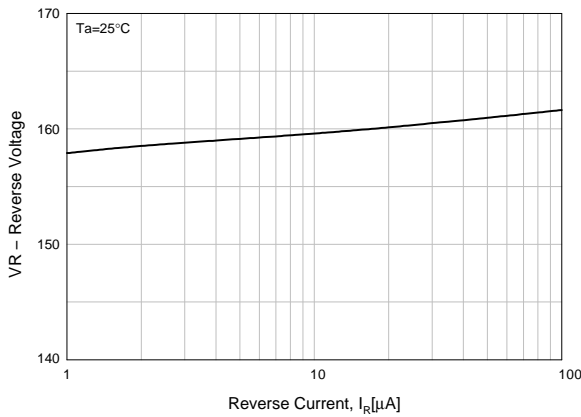
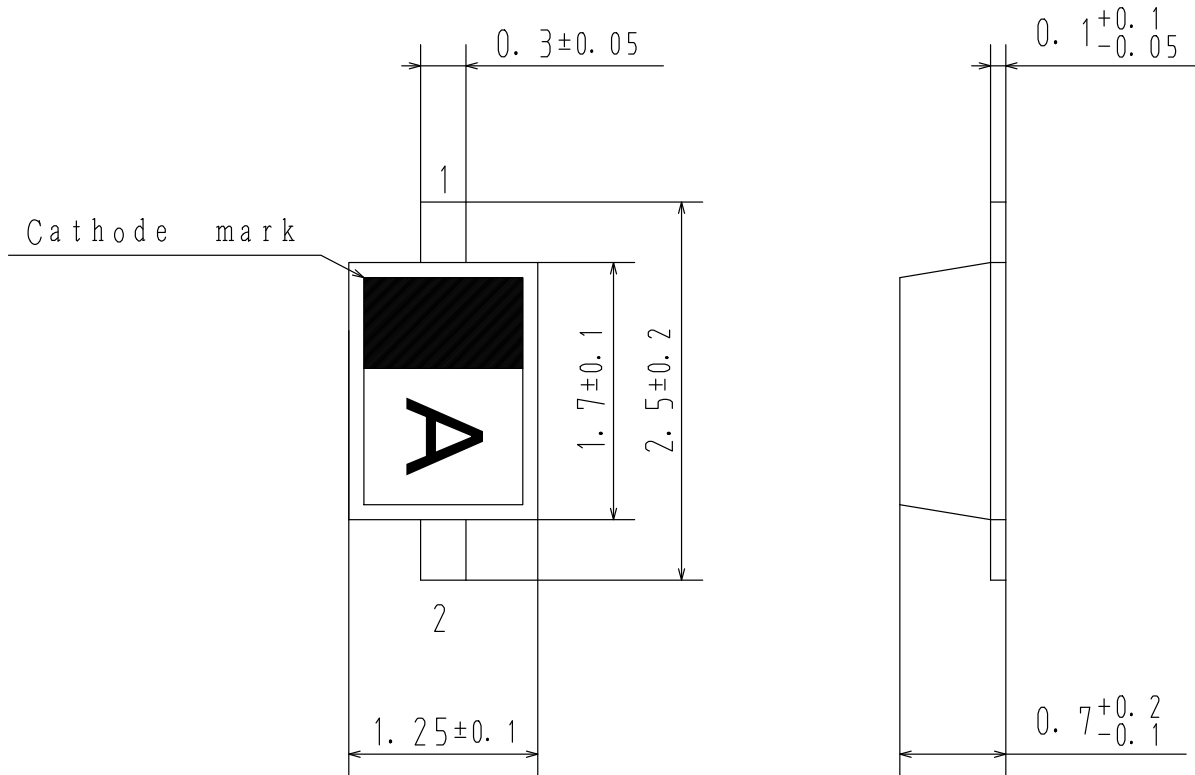



Figure 5. Reverse Voltage vs. Reverse Current

1N4148WS, 1N4448WS, 1N914BWS

PACKAGE DIMENSIONS

SOD-323FL
CASE 477AB
ISSUE O



ON Semiconductor and  are trademarks of Semiconductor Components Industries, LLC dba ON Semiconductor or its subsidiaries in the United States and/or other countries. ON Semiconductor owns the rights to a number of patents, trademarks, copyrights, trade secrets, and other intellectual property. A listing of ON Semiconductor's product/patent coverage may be accessed at www.onsemi.com/site/pdf/Patent-Marking.pdf. ON Semiconductor reserves the right to make changes without further notice to any products herein. ON Semiconductor makes no warranty, representation or guarantee regarding the suitability of its products for any particular purpose, nor does ON Semiconductor assume any liability arising out of the application or use of any product or circuit, and specifically disclaims any and all liability, including without limitation special, consequential or incidental damages. Buyer is responsible for its products and applications using ON Semiconductor products, including compliance with all laws, regulations and safety requirements or standards, regardless of any support or applications information provided by ON Semiconductor. "Typical" parameters which may be provided in ON Semiconductor data sheets and/or specifications can and do vary in different applications and actual performance may vary over time. All operating parameters, including "Typicals" must be validated for each customer application by customer's technical experts. ON Semiconductor does not convey any license under its patent rights nor the rights of others. ON Semiconductor products are not designed, intended, or authorized for use as a critical component in life support systems or any FDA Class 3 medical devices or medical devices with a same or similar classification in a foreign jurisdiction or any devices intended for implantation in the human body. Should Buyer purchase or use ON Semiconductor products for any such unintended or unauthorized application, Buyer shall indemnify and hold ON Semiconductor and its officers, employees, subsidiaries, affiliates, and distributors harmless against all claims, costs, damages, and expenses, and reasonable attorney fees arising out of, directly or indirectly, any claim of personal injury or death associated with such unintended or unauthorized use, even if such claim alleges that ON Semiconductor was negligent regarding the design or manufacture of the part. ON Semiconductor is an Equal Opportunity/Affirmative Action Employer. This literature is subject to all applicable copyright laws and is not for resale in any manner.

PUBLICATION ORDERING INFORMATION

LITERATURE FULFILLMENT:

Literature Distribution Center for ON Semiconductor
19521 E. 32nd Pkwy, Aurora, Colorado 80011 USA
Phone: 303-675-2175 or 800-344-3860 Toll Free USA/Canada
Fax: 303-675-2176 or 800-344-3867 Toll Free USA/Canada
Email: orderlit@onsemi.com

N. American Technical Support: 800-282-9855 Toll Free
USA/Canada
Europe, Middle East and Africa Technical Support:
Phone: 421 33 790 2910
Japan Customer Focus Center
Phone: 81-3-5817-1050

ON Semiconductor Website: www.onsemi.com

Order Literature: <http://www.onsemi.com/orderlit>

For additional information, please contact your local Sales Representative

ON Semiconductor and  are trademarks of Semiconductor Components Industries, LLC dba ON Semiconductor or its subsidiaries in the United States and/or other countries. ON Semiconductor owns the rights to a number of patents, trademarks, copyrights, trade secrets, and other intellectual property. A listing of ON Semiconductor's product/patent coverage may be accessed at www.onsemi.com/site/pdf/Patent-Marking.pdf. ON Semiconductor reserves the right to make changes without further notice to any products herein. ON Semiconductor makes no warranty, representation or guarantee regarding the suitability of its products for any particular purpose, nor does ON Semiconductor assume any liability arising out of the application or use of any product or circuit, and specifically disclaims any and all liability, including without limitation special, consequential or incidental damages. Buyer is responsible for its products and applications using ON Semiconductor products, including compliance with all laws, regulations and safety requirements or standards, regardless of any support or applications information provided by ON Semiconductor. "Typical" parameters which may be provided in ON Semiconductor data sheets and/or specifications can and do vary in different applications and actual performance may vary over time. All operating parameters, including "Typicals" must be validated for each customer application by customer's technical experts. ON Semiconductor does not convey any license under its patent rights nor the rights of others. ON Semiconductor products are not designed, intended, or authorized for use as a critical component in life support systems or any FDA Class 3 medical devices or medical devices with a same or similar classification in a foreign jurisdiction or any devices intended for implantation in the human body. Should Buyer purchase or use ON Semiconductor products for any such unintended or unauthorized application, Buyer shall indemnify and hold ON Semiconductor and its officers, employees, subsidiaries, affiliates, and distributors harmless against all claims, costs, damages, and expenses, and reasonable attorney fees arising out of, directly or indirectly, any claim of personal injury or death associated with such unintended or unauthorized use, even if such claim alleges that ON Semiconductor was negligent regarding the design or manufacture of the part. ON Semiconductor is an Equal Opportunity/Affirmative Action Employer. This literature is subject to all applicable copyright laws and is not for resale in any manner.

PUBLICATION ORDERING INFORMATION

LITERATURE FULFILLMENT:

Literature Distribution Center for ON Semiconductor
19521 E. 32nd Pkwy, Aurora, Colorado 80011 USA
Phone: 303-675-2175 or 800-344-3860 Toll Free USA/Canada
Fax: 303-675-2176 or 800-344-3867 Toll Free USA/Canada
Email: orderlit@onsemi.com

N. American Technical Support: 800-282-9855 Toll Free
USA/Canada
Europe, Middle East and Africa Technical Support:
Phone: 421 33 790 2910
Japan Customer Focus Center
Phone: 81-3-5817-1050

ON Semiconductor Website: www.onsemi.com
Order Literature: <http://www.onsemi.com/orderlit>
For additional information, please contact your local
Sales Representative