

80mm sq.

San Ace 80



General Specifications

- Material Frame: Plastics (Flammability: UL94V-0),
Impeller: Plastics (Flammability: UL94V-0)
- Expected Life Refer to specifications (L10:Survival rate:90% at 60°C ,
rated voltage, and continuously run in a free air state)
- Lead Wire Inlet ⊕red ⊖black (Sensor) yellow (Control) brown
Outlet ⊕orange ⊖gray (Sensor) purple (Control) white
- Storage Temperature -30°C to +70°C (Non-condensing)

80×80×80mm (Mass : 430g) **9CRB type**

Specifications

The following nos. **have PWM controls and pulse sensors.**

Model No.	Rated Voltage [V]	Operating Voltage Range [V]	PWM duty cycle ^{Note#} [%]	Rated Current [A]	Rated Input [W]	Rated Speed [min ⁻¹]	Max. Airflow [m ³ /min] [CFM]	Max. Static Pressure [Pa] [inchH ₂ O]	SPL [dB(A)]	Operating Temperature [°C]	Expected Life [h]
9CRB0812P8G001	12	10.8 to 13.2	100	9.2	110.4	14,600 12,200	5.5 194	1,150 4.6	80	-20 to +70	40,000/60°C (70,000/40°C)
			20	0.17	2.04	2,000 1,670	0.7 24.7	21.6 0.09	24		

Note: Fan does not rotate when PWM duty cycle is 0%.

※PWM Frequency : 25kHz

Dimensions (unit: mm)

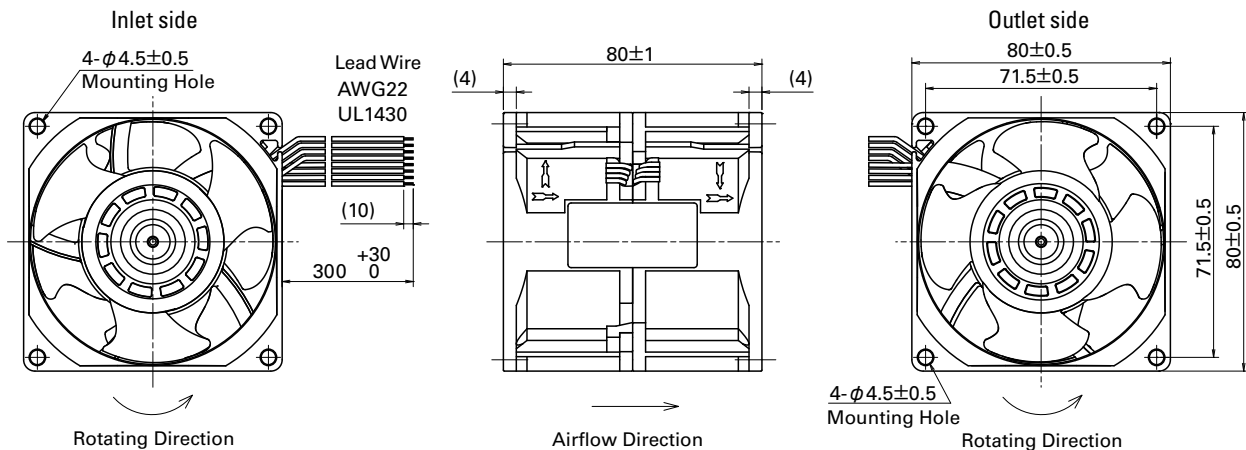

Reference Dimensions of Mounting Holes and Vent Opening (unit: mm)

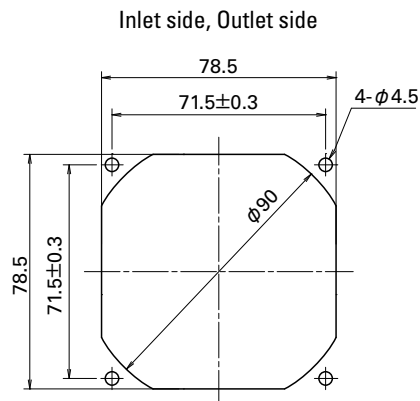

Options (unit: mm)

Finger Guards

Model : 109-049E Surface treatment : Nickel-chrome plating (silver) Color
: 109-049H : Cation electropainting (black)

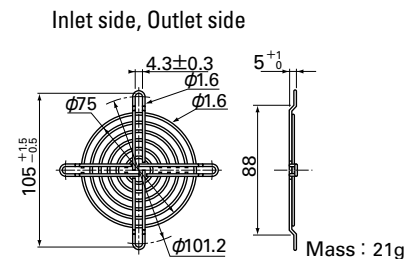

Options (unit: mm)

Resin Finger Guards

Model : 109-1002G

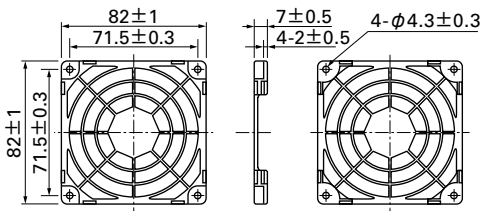

Mass : 10g

Resin Filter Kits

Model : 109-1002F13 (13PPI), 109-1002F20 (20PPI)
: 109-1002F30 (30PPI), 109-1002F40 (40PPI)

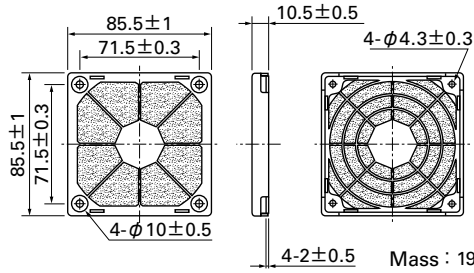

Mass : 19g

Airflow - Static Pressure Characteristics

PWM Duty Cycle

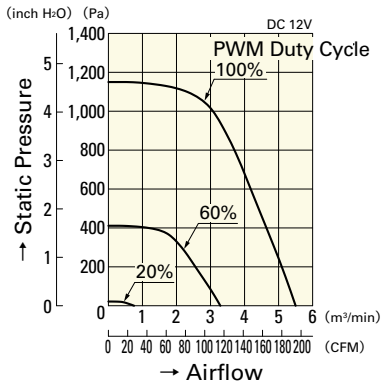

9CRB0812P8G001

Operating Voltage Range

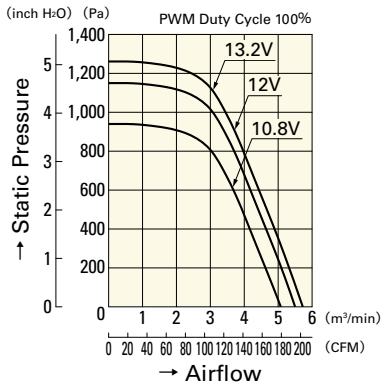

9CRB0812P8G001

PWM Duty - Speed Characteristics Example

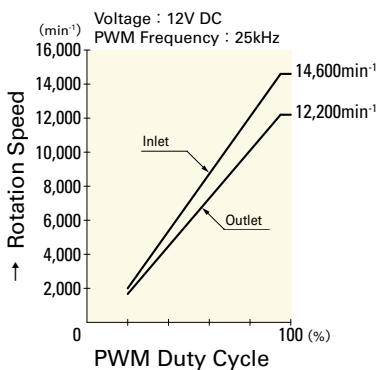

9CRB0812P8G001