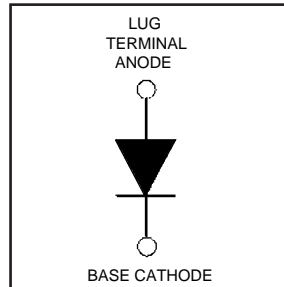


**Features**

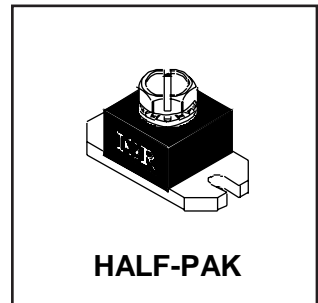
- Reduced RFI and EMI
- Reduced Snubbing
- Extensive Characterization of Recovery Parameters



$V_R = 600V$
$V_F(\text{typ.})^{\textcircled{3}} = 1.2V$
$I_{F(AV)} = 105A$
$Q_{rr}(\text{typ.}) = 450nC$
$I_{RRM}(\text{typ.}) = 10A$
$t_{rr}(\text{typ.}) = 35ns$
$di_{(rec)M}/dt(\text{typ.})^{\textcircled{3}} = 240A/\mu s$

**Description**

HEXFRED™ diodes are optimized to reduce losses and EMI/RFI in high frequency power conditioning systems. An extensive characterization of the recovery behavior for different values of current, temperature and di/dt simplifies the calculations of losses in the operating conditions. The softness of the recovery eliminates the need for a snubber in most applications. These devices are ideally suited for power converters, motors drives and other applications where switching losses are significant portion of the total losses.



**Absolute Maximum Ratings**

	Parameter	Max.	Units
$V_R$	Cathode-to-Anode Voltage	600	V
$I_F @ T_C = 25^\circ C$	Continuous Forward Current	171	A
$I_F @ T_C = 100^\circ C$	Continuous Forward Current	85	
$I_{FSM}$	Single Pulse Forward Current <sup>①</sup>	600	
$E_{AS}$	Non-Repetitive Avalanche Energy <sup>②</sup>	220	μJ
$P_D @ T_C = 25^\circ C$	Maximum Power Dissipation	463	W
$P_D @ T_C = 100^\circ C$	Maximum Power Dissipation	185	
$T_J$	Operating Junction and	-55 to +150	°C
$T_{STG}$	Storage Temperature Range		

**Thermal - Mechanical Characteristics**

	Parameter	Min.	Typ.	Max.	Units
$R_{thJC}$	Junction-to-Case	—	—	0.27	°C/W
$R_{thCS}$	Case-to-Sink, Flat, Greased Surface	—	0.15	—	K/W
$Wt$	Weight	—	26 (0.9)	—	g (oz)
	Mounting Torque <sup>④</sup>	15 (1.7)	—	25 (2.8)	lbf•in
	Terminal Torque	30 (3.4)	—	40 (4.6)	(N•m)
	Vertical Pull	—	—	35	lbf•in
	2 inch Lever Pull	—	—	35	

**Note:** <sup>①</sup> Limited by junction temperature  
<sup>②</sup> L = 100μH, duty cycle limited by max  $T_J$   
<sup>③</sup> 125°C

<sup>④</sup> Mounting surface must be smooth, flat, free of burrs or other protrusions. Apply a thin even film of thermal grease to mounting surface. Gradually tighten each mounting bolt in 5-10 lbf•in steps until desired or maximum torque limits are reached. Module

# HFA105NH60

PD-2.444 rev. B 02/99

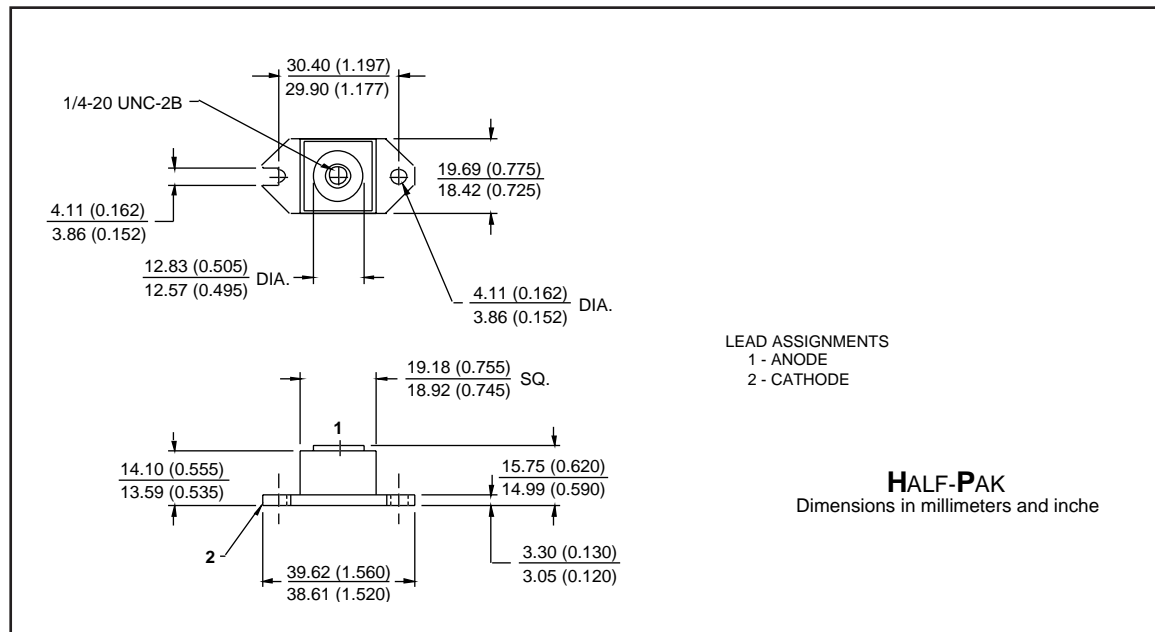
International  
**IOR** Rectifier

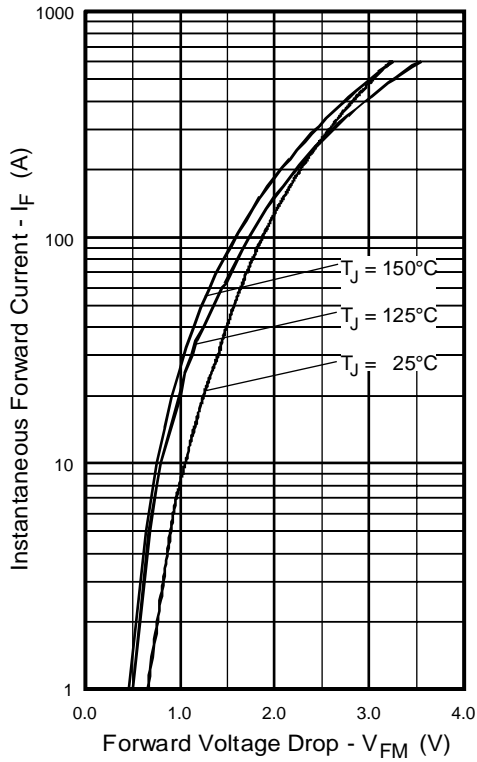
## Electrical Characteristics (per Leg) @ $T_J = 25^\circ\text{C}$ (unless otherwise specified)

Parameter	Min.	Typ.	Max.	Units	Test Conditions
$V_{BR}$ Cathode Anode Breakdown Voltage	600	—	—	V	$I_R = 100\mu\text{A}$
$V_{FM}$ Max Forward Voltage See Fig. 1	—	1.3	1.5	V	$I_F = 105\text{A}$
	—	1.5	1.7		$I_F = 210\text{A}$
	—	1.2	1.4		$I_F = 105\text{A}, T_J = 125^\circ\text{C}$
$I_{RM}$ Max Reverse Leakage Current See Fig. 2	—	6.0	30	$\mu\text{A}$	$V_R = V_R$ Rated
	—	1.5	6.0	$\text{mA}$	$T_J = 125^\circ\text{C}, V_R = 480\text{V}$
$C_T$ Junction Capacitance See Fig. 3	—	200	300	$\text{pF}$	$V_R = 200\text{V}$
$L_S$ Series Inductance	—	6.0	—	$\text{nH}$	From top of terminal hole to mounting plane

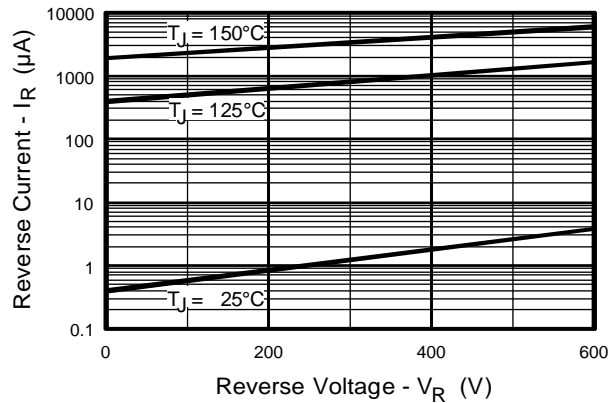
## Dynamic Recovery Characteristics (per Leg) @ $T_J = 25^\circ\text{C}$ (unless otherwise specified)

Parameter	Min.	Typ.	Max.	Units	Test Conditions	
$t_{rr}$ Reverse Recovery Time	—	35	—	ns	$I_F = 1.0\text{A}, di_f/dt = 200\text{A}/\mu\text{s}, V_R = 30\text{V}$ $T_J = 25^\circ\text{C}$	
$t_{rr1}$ See Fig. 5	—	90	140			$T_J = 125^\circ\text{C}$
$t_{rr2}$	—	160	240			$T_J = 125^\circ\text{C}$
$I_{RRM1}$ Peak Recovery Current See Fig. 6	—	10	18	A	$T_J = 25^\circ\text{C}$ $T_J = 125^\circ\text{C}$	
	$I_{RRM2}$	—	15			30
$Q_{rr1}$ Reverse Recovery Charge See Fig. 7	—	450	1300	nC	$T_J = 25^\circ\text{C}$ $T_J = 125^\circ\text{C}$	
	$Q_{rr2}$	—	1200			3600
$di_{(rec)M}/dt1$ Peak Rate of Fall of Recovery Current	—	310	—	$\text{A}/\mu\text{s}$	$T_J = 25^\circ\text{C}$ $T_J = 125^\circ\text{C}$	
$di_{(rec)M}/dt2$ During $t_b$ See Fig. 8	—	240	—			

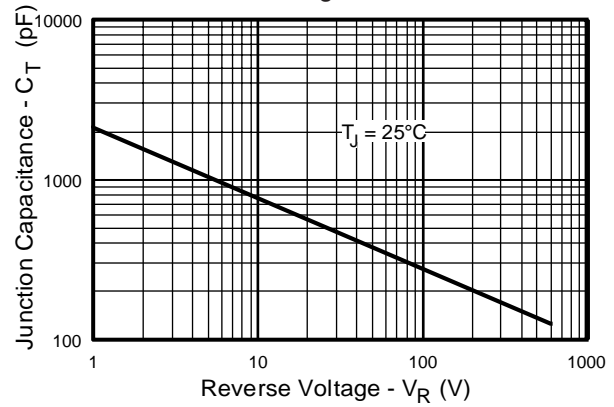




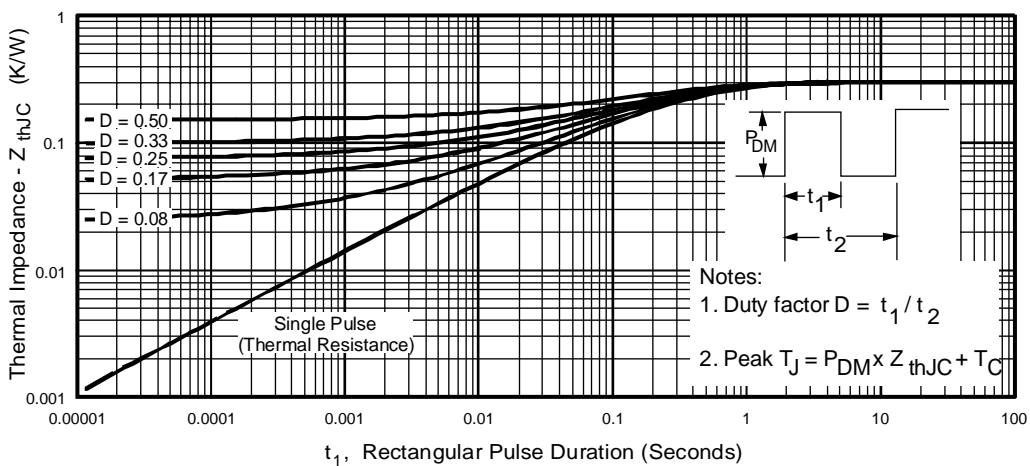
**Fig. 1 - Maximum Forward Voltage Drop vs. Instantaneous Forward Current**



**Fig. 2 - Typical Reverse Current vs. Reverse Voltage**



**Fig. 3 - Typical Junction Capacitance vs. Reverse Voltage**



**Fig. 4 - Maximum Thermal Impedance  $Z_{thJC}$  Characteristics**

# HFA105NH60

PD-2.444 rev. B 02/99

International  
IOR Rectifier

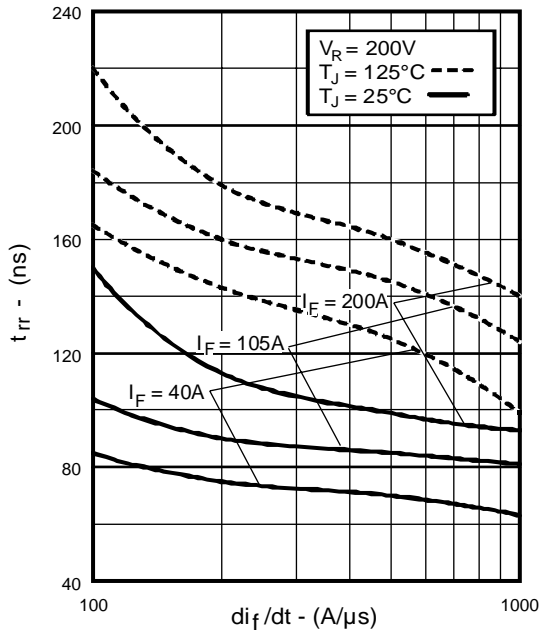


Fig. 5 - Typical Reverse Recovery vs.  $di_f/dt$

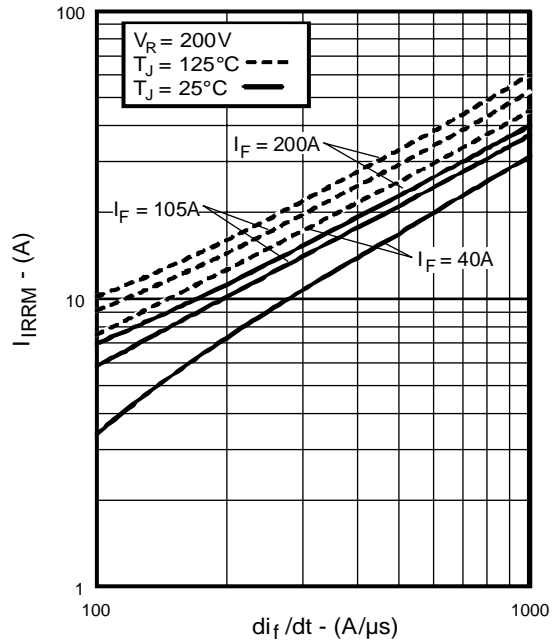


Fig. 6 - Typical Recovery Current vs.  $di_f/dt$

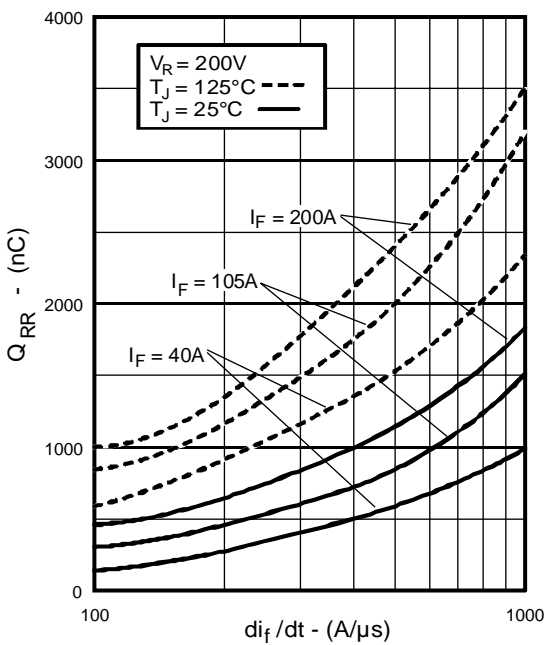


Fig. 7 - Typical Stored Charge vs.  $di_f/dt$

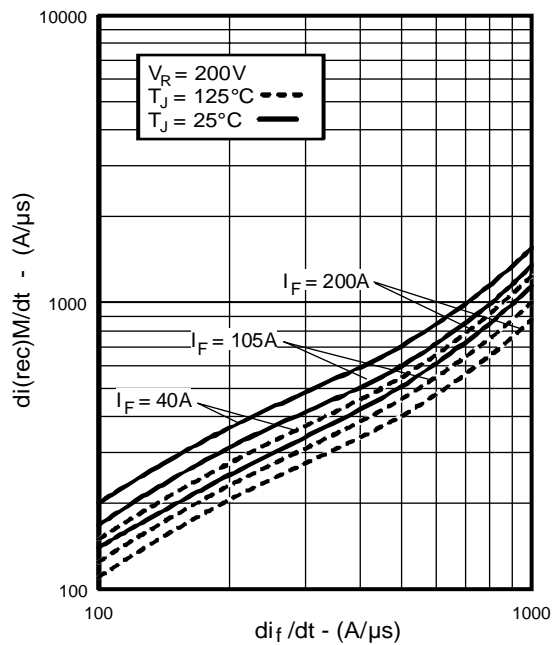
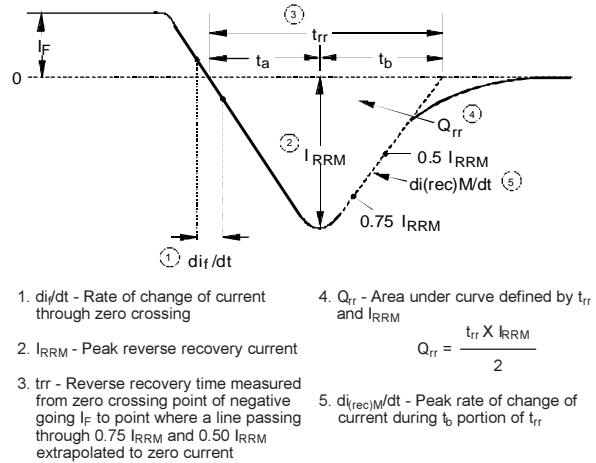
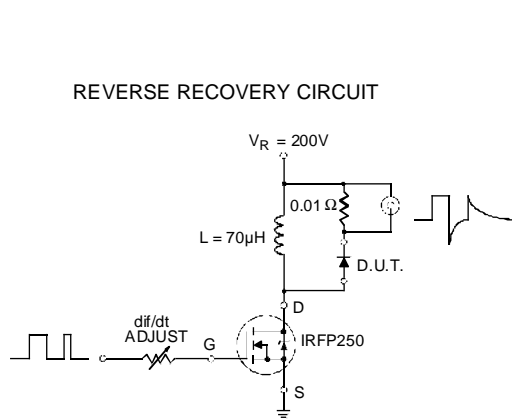
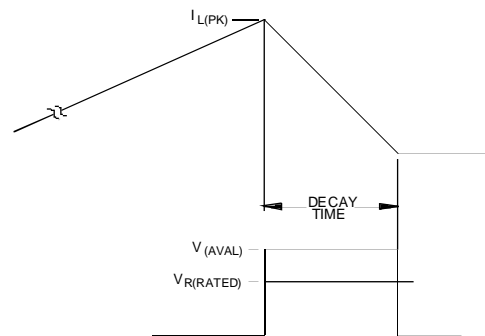
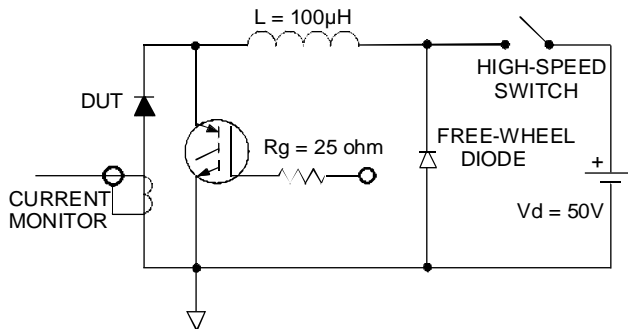


Fig. 8 - Typical  $di_{(rec)M}/dt$  vs.  $di_f/dt$



**Fig. 9** - Reverse Recovery Parameter Test Circuit

**Fig. 10** - Reverse Recovery Waveform and Definitions



**Fig. 11** - Avalanche Test Circuit and Waveforms