

## 5V, SUPER MINIMOLD SI MMIC WIDEBAND AMPLIFIER

### FEATURES

- **WIDEBAND RESPONSE:**  
 $f_u = 2.9$  GHz TYP at 3dB bandwidth
- **NOISE FIGURE:**  
 $NF = 2.3$  dB TYP at  $f = 1.5$  GHz
- **POWER GAIN:**  
 $G_P = 20.5$  dB TYP at  $f = 1.5$  GHz
- **SUPPLY VOLTAGE:**  
 $V_{CC} = 4.5$  to  $5.5$  V
- **HIGH DENSITY SURFACE MOUNTING:**  
 6-pin super mini-mold package

### DESCRIPTION

The UPC3215TB is a Silicon Monolithic IC designed as a wideband amplifier. The UPC3215TB is suitable for systems requiring wideband operation from HF to L band.

This IC is manufactured using a 30 GHz  $f_{max}$  UHS0 (Ultra High Speed Process) silicon bipolar process. The package is 6-pin super minimold suitable for surface mount.

The UPC3215TB is manufactured according to stringent quality assurance standards to ensure highest reliability and consistent superior performance.

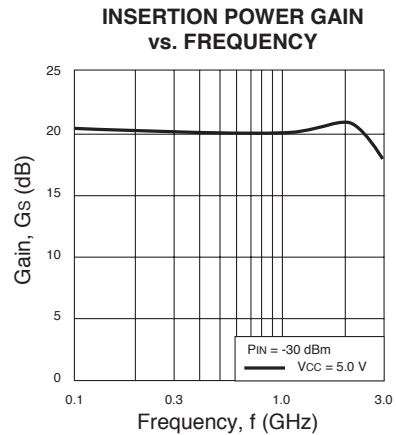

### APPLICATIONS

- Systems requiring wideband operation from HF to L band.
- DBS receivers and tuners

### ELECTRICAL CHARACTERISTICS ( $T_A = 25^\circ\text{C}$ , $V_{CC} = 5.0$ V, $Z_S = Z_L = 50 \Omega$ )

PART NUMBER PACKAGE OUTLINE			UPC3215TB S06		
SYMBOLS	PARAMETERS AND CONDITIONS	UNITS	MIN	TYP	MAX
$I_{CC}$	Circuit Current (no signal)	mA	10.5	14.0	17.5
$G_P$	Power Gain, $f = 1.5$ GHz, $P_{IN} = -30$ dBm	dB	18.5	20.5	-
NF	Noise Figure, $f = 1.5$ GHz	dB	-	2.3	3.0
$f_u$	Upper Limit Operating Frequency (The gain at $f_u$ is 3 dB down from the gain at 100 MHz)	GHz	2.5	2.9	-
ISOL	Isolation, $f = 1.5$ GHz	dB	39	44	-
RLIN	Input Return Loss, $f = 1.5$ GHz	dB	10	15	-
RLOUT	Output Return Loss, $f = 1.5$ GHz	dB	6.5	9.5	-
$P_{1dB}$	1 dB Compression Point, $f = 1.5$ GHz	dBm	-4	-1.5	-

### ELECTRICAL CHARACTERISTICS ( $T_A = 25^\circ\text{C}$ , $V_{CC} = 5.0$ V, $Z_S = Z_L = 50 \Omega$ )

PART NUMBER PACKAGE OUTLINE			UPC3215TB S06	
SYMBOLS	STANDARD CHARACTERISTICS		REFERENCE VALUES	
$P_{SAT}$	Saturated Output Power, $P_{IN} = 0$ dBm	dBm	+3.5	
OIP <sub>3</sub>	Output Intercept Point $f_1 = 1.5$ GHz, $f_2 = 1.501$ GHz	dBm	+10	
$\Delta G_P$	Gain Flatness, $f = 0.1$ to $2.15$ GHz	dB	1.0	

**ABSOLUTE MAXIMUM RATINGS<sup>1</sup>** (TA = 25°C)

SYMBOLS	PARAMETERS	UNITS	RATINGS
VCC	Supply Voltage	V	6.0
ICC	Total Supply Current	mA	30
PIN	Input Power	dBm	+10
PT	Total Power Dissipation <sup>2</sup>	mW	270
TOP	Operating Temperature	°C	-40 to +85
TSTG	Storage Temperature	°C	-55 to +150

Notes:

1. Operation in excess of any one of these parameters may result in permanent damage.
2. Mounted on a 50 X 50 X 1.6 mm epoxy glass PWB, with copper patterning on both sides. (TA = 85°C).

**RECOMMENDED OPERATING CONDITIONS**

SYMBOLS	PARAMETERS	UNITS	MIN	TYP	MAX
VCC	Supply Voltage	V	4.5	5.0	5.5
TA	Operating Ambient Temperature	°C	-40	+25	+85
PIN	Input Power	dBm			0
fIN	Input Frequency	GHz			2.9

**TYPICAL PERFORMANCE CURVES** (TA = 25°C)

**TEST CIRCUIT**

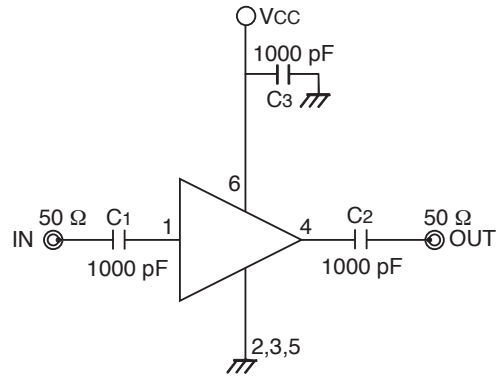

**CIRCUIT CURRENT vs. VOLTAGE**

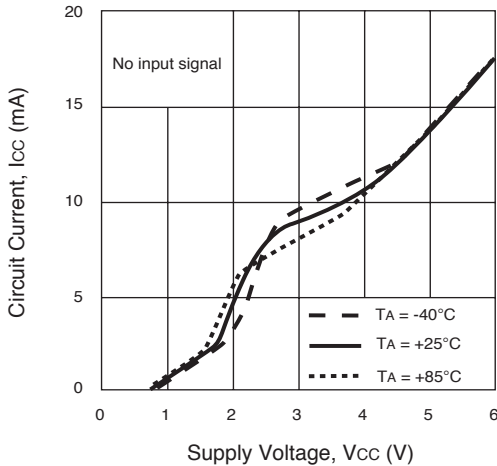

**CIRCUIT CURRENT vs. OPERATING AMBIENT TEMPERATURE**

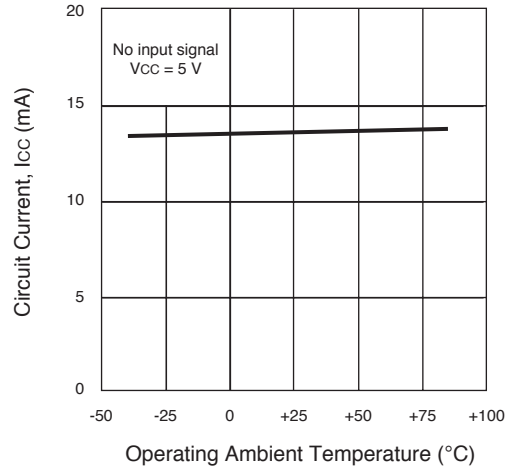

**INSERTION POWER GAIN vs. FREQUENCY**

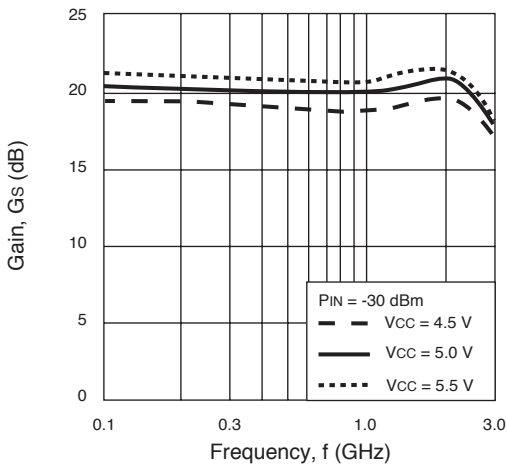

**INSERTION POWER GAIN vs. FREQUENCY**

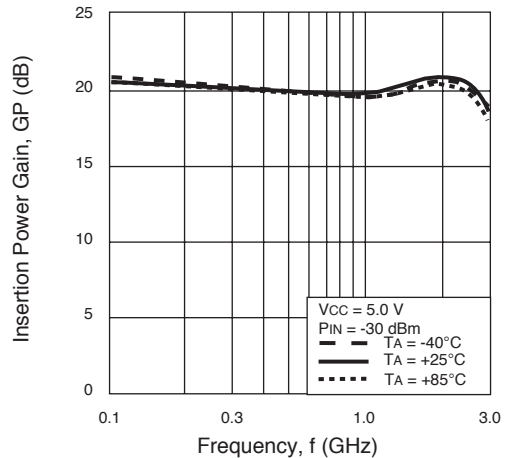

TYPICAL PERFORMANCE CURVES (TA = 25°)

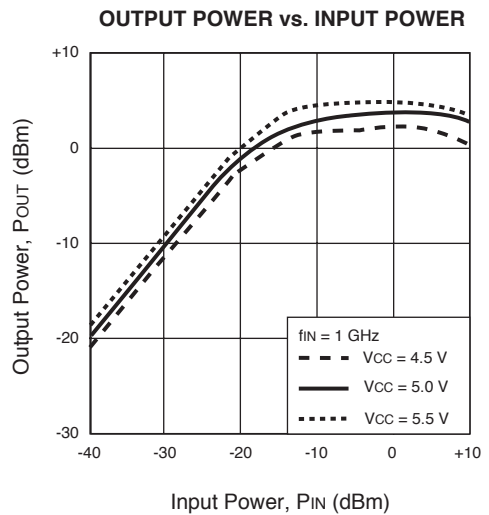
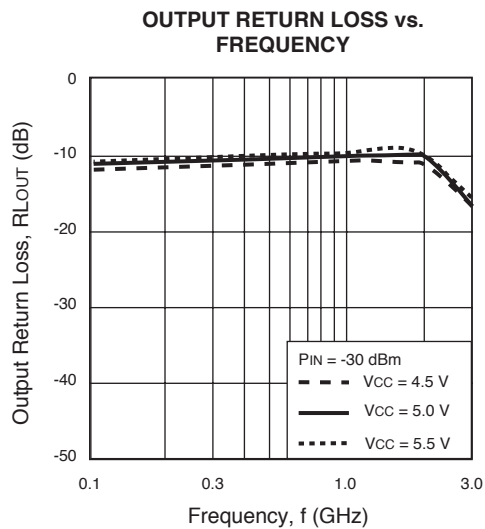
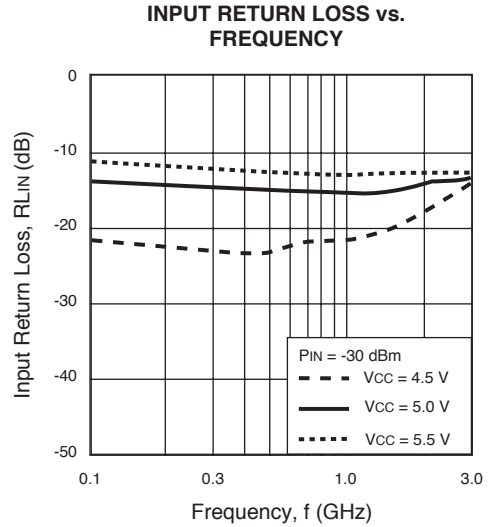
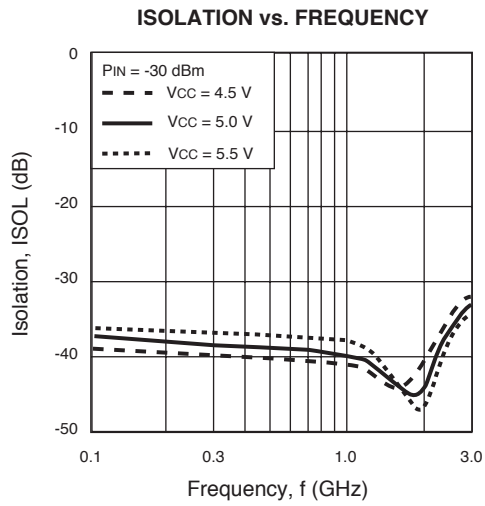
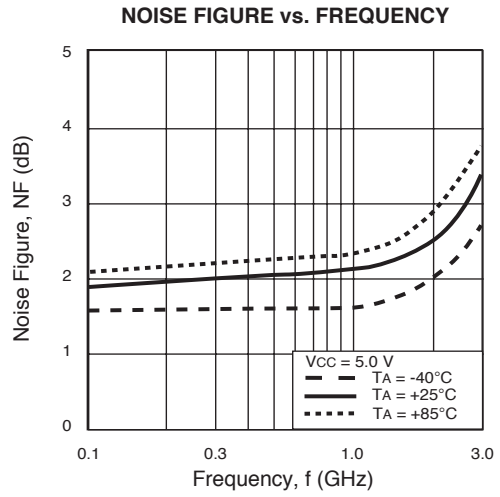
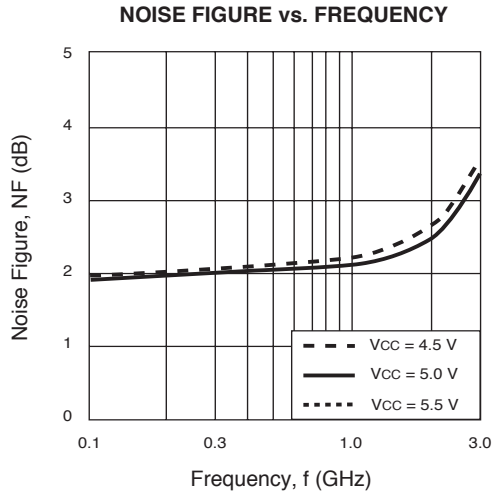

TYPICAL PERFORMANCE CURVES (TA = 25°)

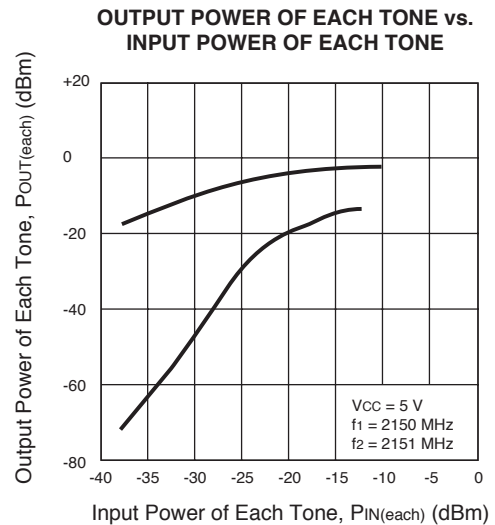
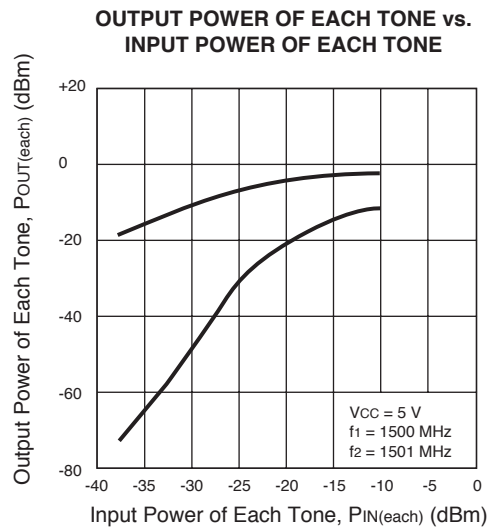
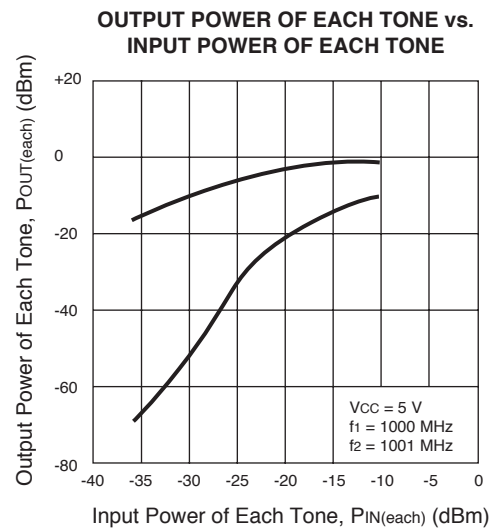
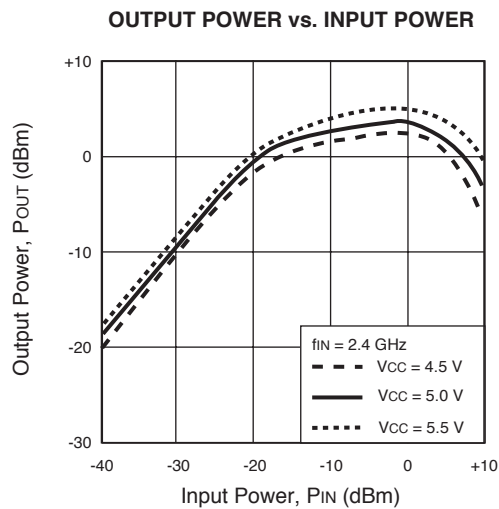
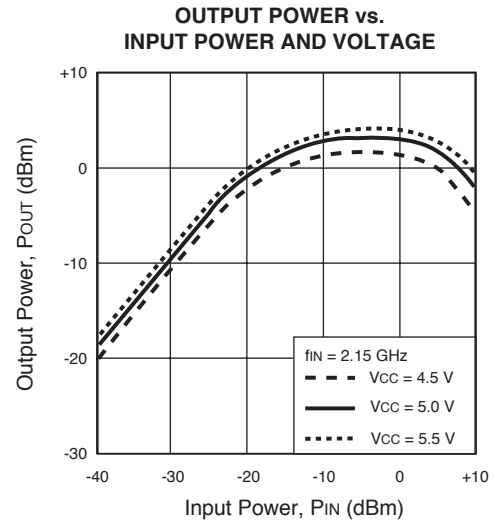
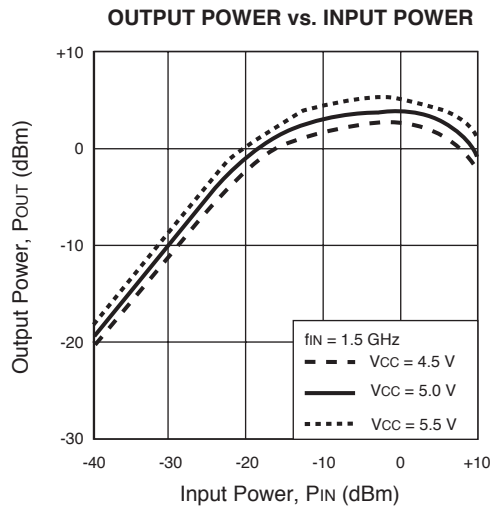

**TYPICAL PERFORMANCE CURVES** ( $T_A = 25^\circ$ )

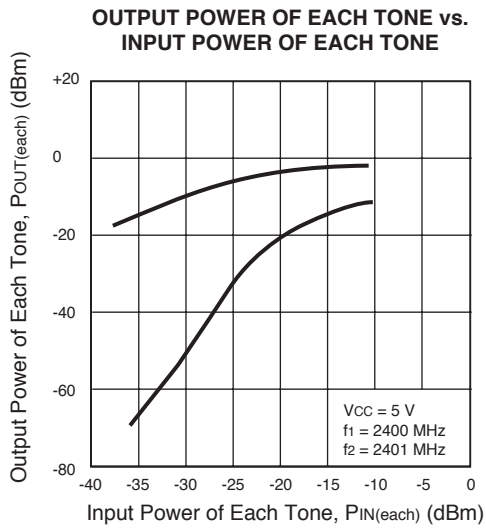

**EXAMPLE OF APPLICATION CIRCUIT**

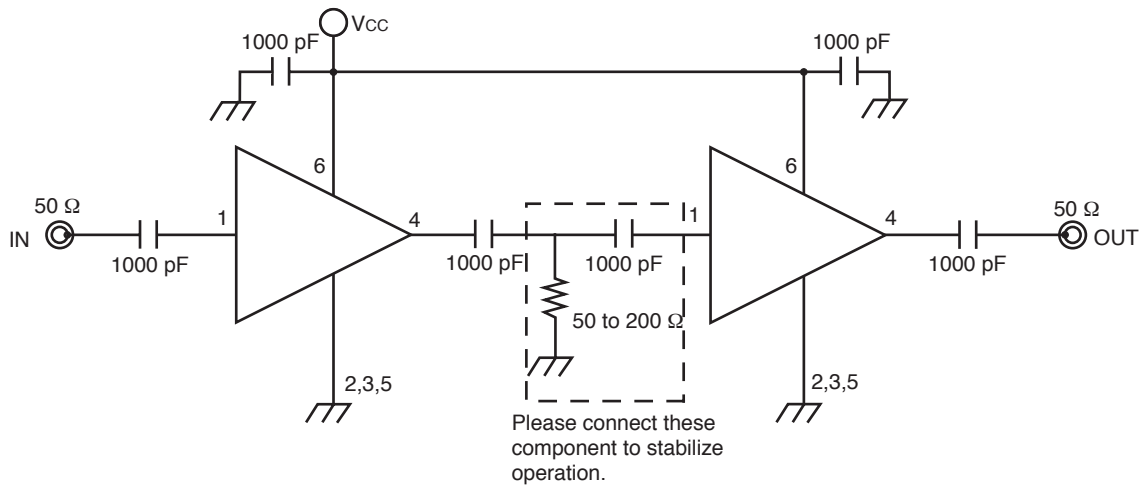

**TYPICAL SCATTERING PARAMETERS** (T<sub>A</sub> = 25°C)

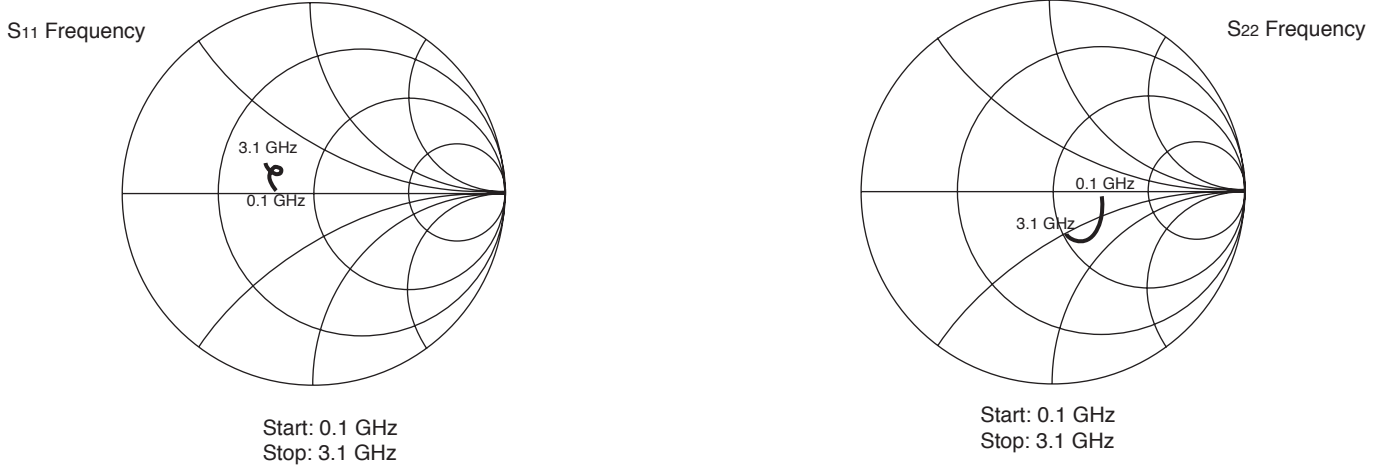

V<sub>CC</sub> = V<sub>OUT</sub> = 5.0 V, I<sub>CC</sub> = 16 mA

FREQUENCY GHz	S <sub>11</sub>		S <sub>21</sub>		S <sub>12</sub>		S <sub>22</sub>		K
	MAG	ANG	MAG	ANG	MAG	ANG	MAG	ANG	
0.1	0.207	174.1	10.788	-4.6	0.013	6.3	0.285	-3.3	3.38
0.2	0.190	173.1	10.714	-9.8	0.013	-0.5	0.282	-3.7	3.39
0.3	0.186	174.3	10.565	-14.3	0.013	2.7	0.283	-4.6	3.37
0.4	0.192	173.8	10.359	-18.3	0.014	4.7	0.285	-6.2	3.92
0.5	0.200	174.5	10.225	-21.7	0.013	5.3	0.286	-7.6	3.96
0.6	0.201	173.0	10.116	-24.9	0.013	2.1	0.286	-8.8	3.69
0.7	0.204	173.0	10.116	-28.0	0.011	1.6	0.288	-10.4	3.91
0.8	0.206	172.4	10.122	-31.1	0.011	12.9	0.289	-11.7	4.17
0.9	0.210	172.7	10.186	-34.5	0.011	5.1	0.290	-13.5	3.99
1.0	0.212	171.4	10.182	-37.7	0.009	4.1	0.285	-14.9	4.28
1.1	0.218	169.4	10.208	-14.6	0.011	4.9	0.299	-16.8	4.19
1.2	0.217	168.4	10.296	-45.6	0.009	11.0	0.300	-18.0	4.65
1.3	0.221	165.9	10.248	-49.7	0.006	20.5	0.299	-20.2	5.78
1.4	0.228	164.7	10.438	-53.9	0.008	1.6	0.307	-23.1	6.97
1.5	0.233	162.3	10.369	-58.0	0.006	20.5	0.299	-16.8	4.19
1.6	0.238	159.5	10.554	-62.7	0.005	31.6	0.316	-27.5	11.54
1.7	0.244	157.2	10.492	-67.2	0.004	48.5	0.317	-30.5	11.75
1.8	0.246	153.9	10.483	-72.2	0.003	87.2	0.318	-33.3	13.52
1.9	0.248	150.6	10.408	-76.9	0.004	93.4	0.323	-36.9	8.46
2.0	0.246	147.4	10.405	-82.2	0.007	114.5	0.323	-40.6	7.46
2.1	0.241	144.9	10.267	-87.2	0.008	115.4	0.319	-44.9	6.20
2.2	0.236	142.2	10.039	-92.7	0.011	124.0	0.312	-48.9	4.50
2.3	0.229	142.2	9.896	-97.7	0.012	121.6	0.306	-52.6	4.12
2.4	0.219	143.5	9.684	-102.4	0.014	124.9	0.292	-56.3	3.40
2.5	0.215	145.7	-9.348	-107.5	0.015	117.8	0.279	-59.3	3.42
2.6	0.213	149.3	9.068	-112.0	0.018	117.3	0.270	-61.7	3.02
2.7	0.221	150.1	8.673	-116.6	0.017	114.4	0.256	-63.7	3.17
2.8	0.234	151.3	8.437	-121.1	0.020	114.0	0.248	-65.1	2.85
2.9	0.253	152.1	8.080	-124.9	0.021	111.6	0.237	-67.3	2.98
3.0	0.264	150.7	7.791	-129.4	0.020	112.5	0.232	-68.0	2.90
3.1	0.283	148.7	7.458	-132.7	0.022	113.7	0.229	-70.2	3.02

**OUTLINE DIMENSIONS** (Units in mm)

**UPC3215TB  
PACKAGE OUTLINE S06**

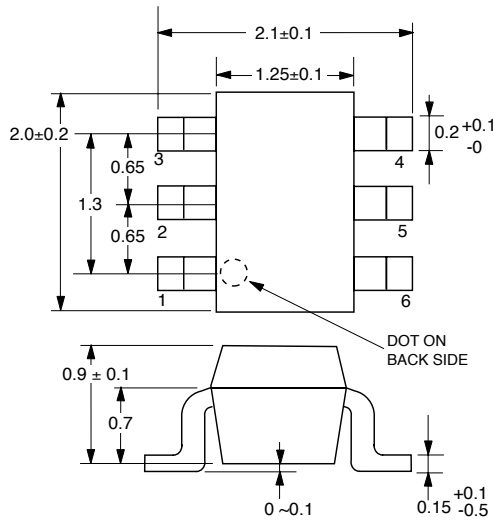

**LEAD CONNECTIONS**

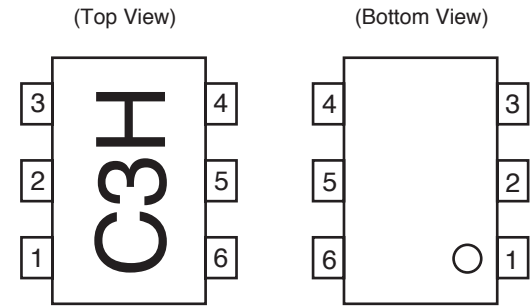

- 1. INPUT
- 2. GND
- 3. GND
- 4. OUTPUT
- 5. GND
- 6. Vcc

**PIN DESCRIPTION**

Pin No.	Pin Name (V)	Applied Voltage	Pin Voltage	Description Circuit	Internal Equivalent
1	Input	—	0.82	Signal input pin. An internal matching circuit, configured with resistors, enables 50 Ω connection over a wide band. A multi-feedback circuit is designed to cancel the deviations of h <sub>FE</sub> and resistance. This pin must be coupled to the signal source with capacitor for DC cut.	
2 3 5	GND	0	—	Ground pins. These pins should be connected to system ground with minimum inductance. Ground pattern on the board should be formed as wide as possible. All the ground pins must be connected together with wide ground pattern to decrease impedance difference.	
4	Output	—	3.8	Signal output pin. An internal matching circuit, configured with resistors, enables 50 Ω connection over a wide band. This pin must be coupled to next stage with capacitor for DC cut.	
6	VCC	4.5 to 5.5	—	Power supply pin. This pin should be externally equipped with a bypass capacitor to minimize ground impedance.	

**ORDERING INFORMATION**

PART NUMBER	QTY
UPC3215TB-E3-A	3K/Reel

Note: Embossed Tape, 8 mm wide. Pins 1, 2 and 3 face perforated side of tape.

EXCLUSIVE NORTH AMERICAN AGENT FOR RF, MICROWAVE & OPTOELECTRONIC SEMICONDUCTORS

**CEL** CALIFORNIA EASTERN LABORATORIES • Headquarters • 4590 Patrick Henry Drive • Santa Clara, CA 95054-1817 • (408) 988-3500 • Telex 34-6393 • FAX (408) 988-0279  
DATA SUBJECT TO CHANGE WITHOUT NOTICE

Internet: <http://WWW.CEL.COM>

09/04/2001