

D

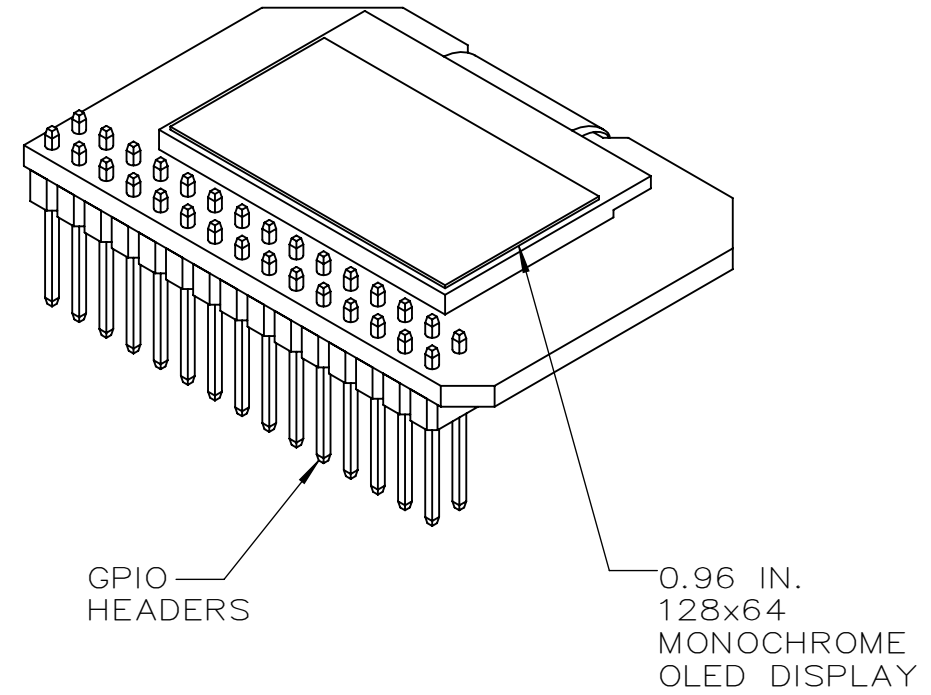

C

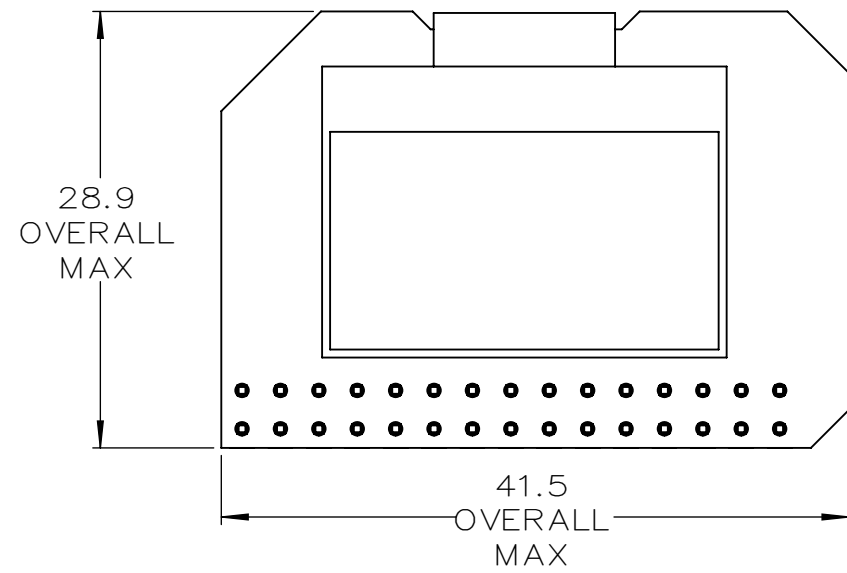
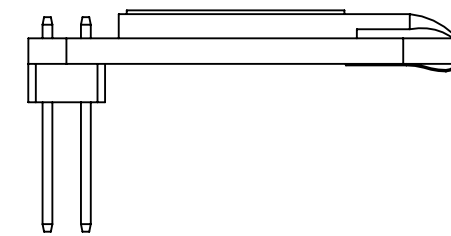
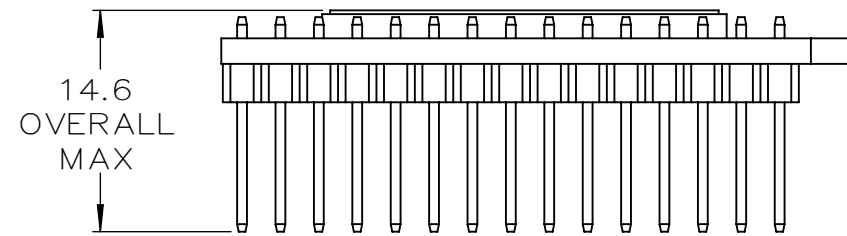

B

IMPORTANT NOTE:
EXPANSION BOARDS
CANNOT BE STACKED
ABOVE THIS UNIT.

A

ONLY MAJOR AND INTERFACING COMPONENTS SHOWN.
THRU-HOLE PINS MAY HAVE SOLDER AT THEIR BASES.
SLIGHT VARIATIONS MAY OCCUR DUE TO MFG AND ASSY.
SEE DOCUMENTATION FOR HOW TO USE.
FOR REFERENCE ONLY. THIS IS NOT A DESIGN GUIDE.

GENERAL DESCRIPTION

		DIMENSION IN MM UNLESS NOTED	THE INFORMATION CONTAINED IN THIS DRAWING IS THE SOLE PROPERTY OF ONION CORPORATION. ANY REPRODUCTION IN PART OR AS A WHOLE WITHOUT THE WRITTEN PERMISSION OF ONION CORPORATION IS PROHIBITED.	
		TOLERANCES	AUTHOR	DATE
		.X ±0.1	GO	2016-03-31
		.XX ±0.06	CHECKED	DATE
		.XXX ±0.010		
		ANG.	APPROVED	DATE
		MACH ±0.5°		
		BEND ±1°		
		MATERIAL	PROJECTION TYPE	TITLE
				OLED EXPANSION
				PART NO.
				OM-E-OLE
				SCALE
				2:1
				SIZE
				B
				SHEET
				1 OF 4
		DO NOT SCALE DRAWING		REV.
				A

8 7 6 5 4 3 2 1

D

D

C

C

B

B

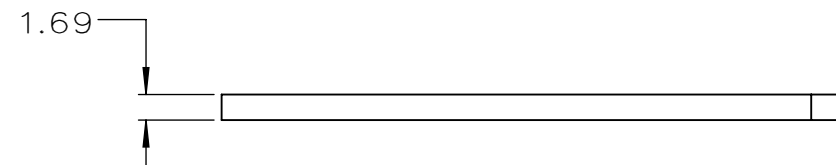
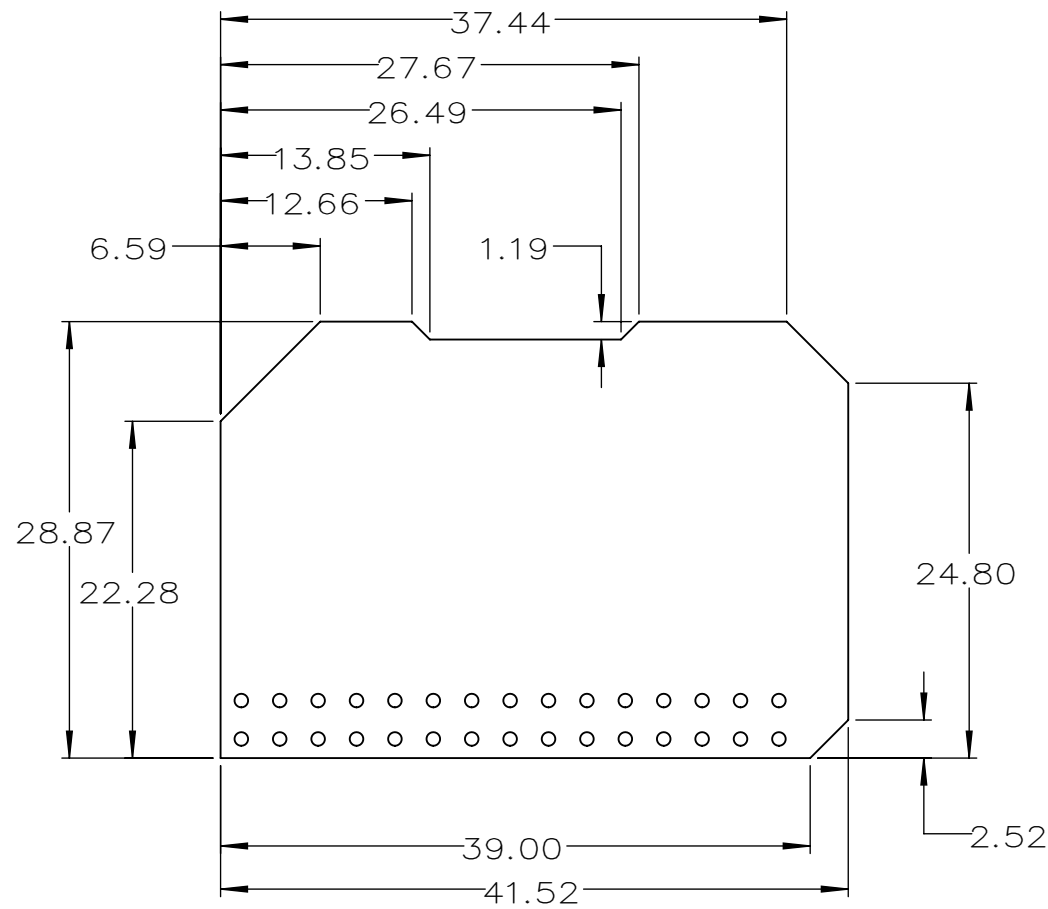

BOARD
OUTLINE

ONLY MAJOR AND INTERFACING COMPONENTS SHOWN.
 THRU-HOLE PINS MAY HAVE SOLDER AT THEIR BASES.
 SLIGHT VARIATIONS MAY OCCUR DUE TO MFG AND ASSY.
 SEE DOCUMENTATION FOR HOW TO USE.
 FOR REFERENCE ONLY. THIS IS NOT A DESIGN GUIDE.

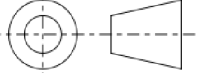
		DIMENSION IN MM UNLESS NOTED	THE INFORMATION CONTAINED IN THIS DRAWING IS THE SOLE PROPERTY OF ONION CORPORATION. ANY REPRODUCTION IN PART OR AS A WHOLE WITHOUT THE WRITTEN PERMISSION OF ONION CORPORATION IS PROHIBITED.		
		TOLERANCES	AUTHOR	DATE	
		.X ±0.1 .XX ±0.06 .XXX ±0.010 ANG. MACH ±0.5° BEND ±1°	GO	2016-03-31	
		MATERIAL	CHECKED	DATE	TITLE
					OLED EXPANSION
			APPROVED	DATE	PART NO.
					OM-E-OLE
			PROJECTION TYPE		REV.
					A
		DO NOT SCALE DRAWING	SCALE	SIZE	SHEET
			2:1	B	2 OF 4

NEXT ASSY

USED ON

8 7 6 5 4 3 2 1

A

A

8 7 6 5 4 3 2 1

D

D

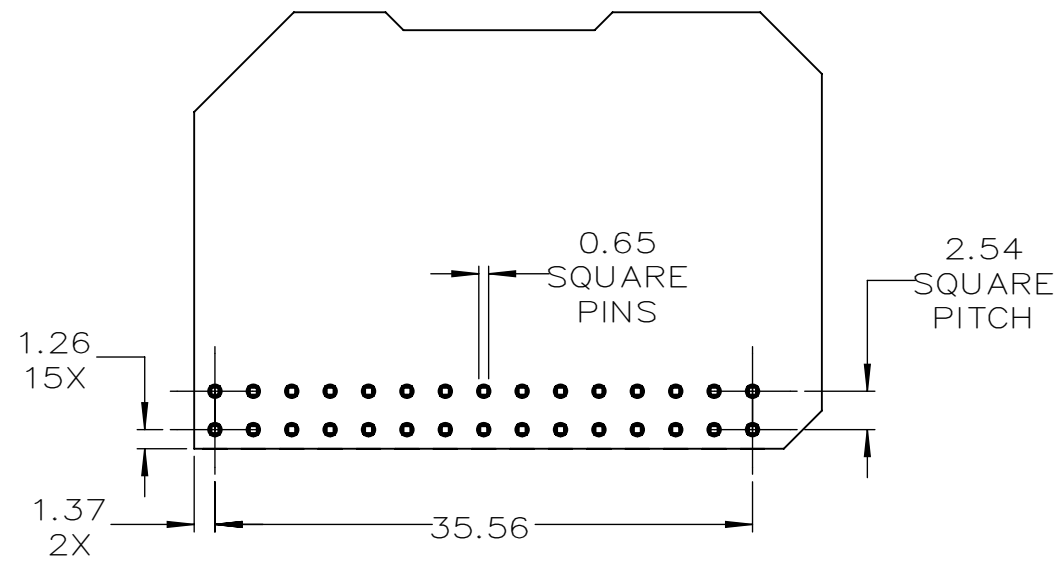

TOP VIEW

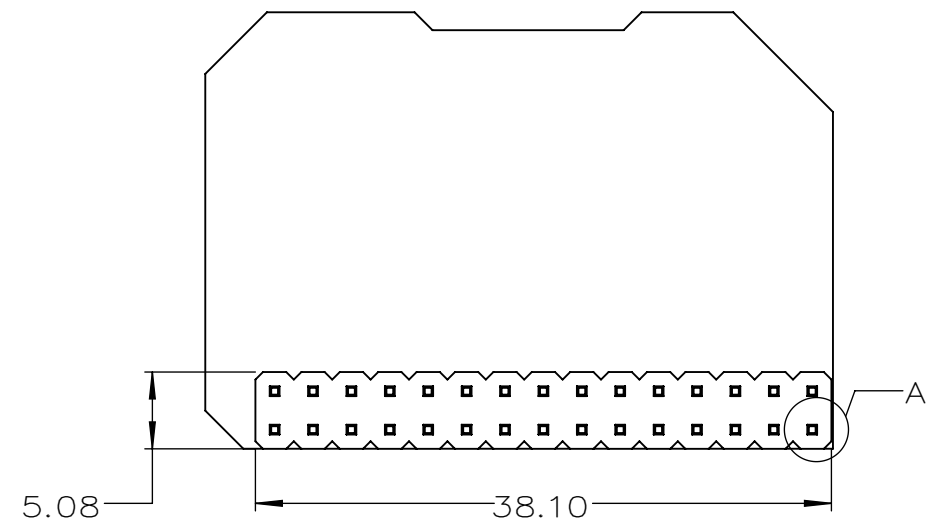

BOTTOM VIEW

C

C

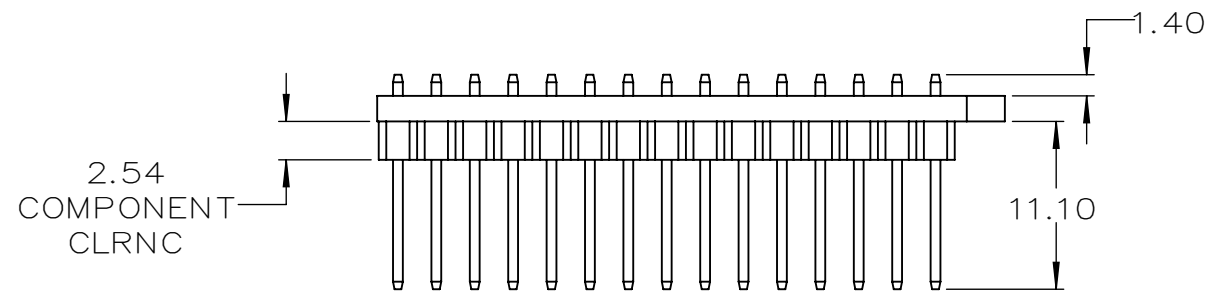

FRONT VIEW

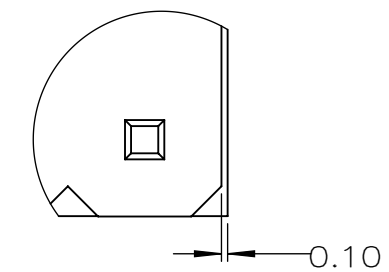

DETAIL A
HEADER OFFSET
SCALE 8 : 1

B

B

GPIO DETAIL
(BOARD AND GPIO HEADER ONLY)

ONLY MAJOR AND INTERFACING COMPONENTS SHOWN.
THRU-HOLE PINS MAY HAVE SOLDER AT THEIR BASES.
SLIGHT VARIATIONS MAY OCCUR DUE TO MFG AND ASSY.
SEE DOCUMENTATION FOR HOW TO USE.
FOR REFERENCE ONLY. THIS IS NOT A DESIGN GUIDE.

		DIMENSION IN MM UNLESS NOTED	THE INFORMATION CONTAINED IN THIS DRAWING IS THE SOLE PROPERTY OF ONION CORPORATION. ANY REPRODUCTION IN PART OR AS A WHOLE WITHOUT THE WRITTEN PERMISSION OF ONION CORPORATION IS PROHIBITED.		
		TOLERANCES	AUTHOR	DATE	
		.X ±0.1 .XX ±0.06 .XXX ±0.010 ANG. MACH ±0.5° BEND ±1°	GO	2016-03-31	
		MATERIAL	CHECKED	DATE	TITLE
					OLED EXPANSION
			APPROVED	DATE	PART NO.
					OM-E-OLE
			PROJECTION TYPE		REV.
					A
NEXT ASSY	USED ON	DO NOT SCALE DRAWING	SCALE	SIZE	SHEET
			2:1	B	3 OF 4

A

A

8 7 6 5 4 3 2 1

D

D

C

C

B

B

A

A

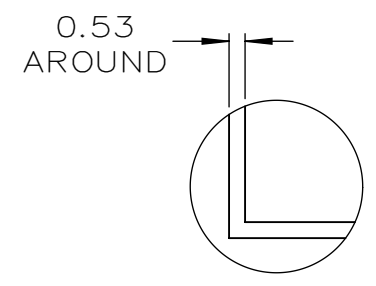
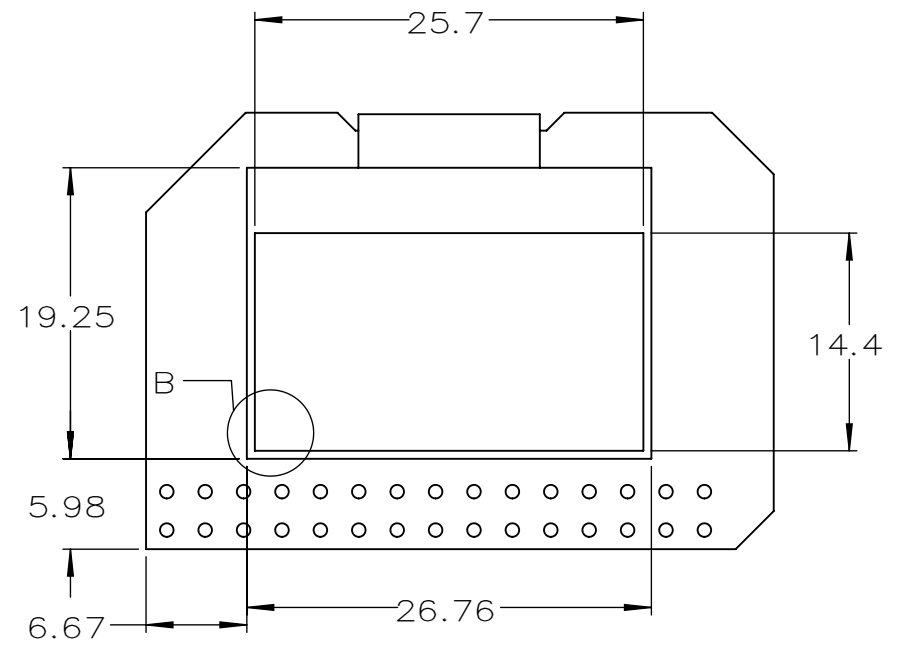

DETAIL B
SCALE 4 : 1

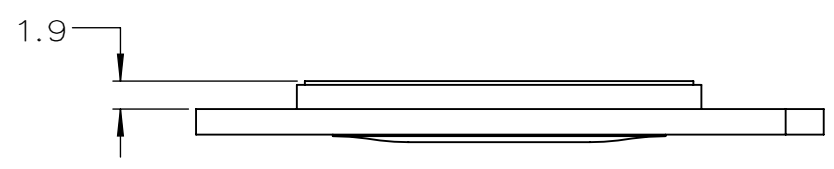

OLED DETAIL
(BOARD AND OLED DISPLAY ONLY)

ONLY MAJOR AND INTERFACING COMPONENTS SHOWN.
 THRU-HOLE PINS MAY HAVE SOLDER AT THEIR BASES.
 SLIGHT VARIATIONS MAY OCCUR DUE TO MFG AND ASSY.
 SEE DOCUMENTATION FOR HOW TO USE.
 FOR REFERENCE ONLY. THIS IS NOT A DESIGN GUIDE.

		DIMENSION IN MM UNLESS NOTED	THE INFORMATION CONTAINED IN THIS DRAWING IS THE SOLE PROPERTY OF ONION CORPORATION. ANY REPRODUCTION IN PART OR AS A WHOLE WITHOUT THE WRITTEN PERMISSION OF ONION CORPORATION IS PROHIBITED.	
		TOLERANCES	AUTHOR GO	DATE 2016-03-31
		.X ±0.1	CHECKED	DATE
		.XX ±0.06		
		.XXX ±0.010	APPROVED	DATE
		ANG.		
		MACH ±0.5°	PROJECTION TYPE	TITLE OLED EXPANSION
		BEND ±1°		PART NO. OM-E-OLE
		MATERIAL		REV. A
NEXT ASSY	USED ON	DO NOT SCALE DRAWING	SCALE 2:1	SIZE B
			SHEET 4 OF 4	