

Features

- Four unidirectional ESD protections
- RoHS compliant*
- Low capacitance
- Surge protection



This model is currently available, but not recommended for new designs.

CDSOT353-T05 - TVS Diode Quad Array

General Information

The CDSOT353-T05 device provides ESD, EFT and Surge protection for high speed data ports meeting IEC 61000-4-2 (ESD), IEC 61000-4-4 (EFT) and IEC 61000-4-5 (Surge) requirements. The Transient Voltage Suppressor array offers a Working Peak Reverse Voltage of 5.0 V and Minimum Breakdown Voltage of 6.0 V.

The SOT353 packaged device will mount directly onto the industry standard SOT353 footprint. Bourns® Chip Diodes are easy to handle with standard pick and place equipment and their flat configuration minimizes roll away.

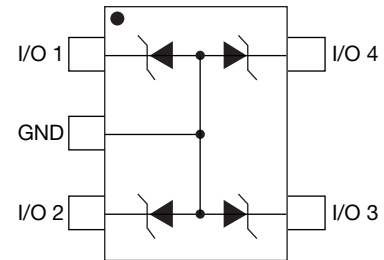

Electrical & Thermal Characteristics (@ T_A = 25 °C Unless Otherwise Noted)

Parameter	Symbol	CDSOT353-T05	Unit
Peak Pulse Power (t _p = 8/20 μs) (NOTE 1)	P _{PK}	25	W
Storage Temperature	T _{STG}	-55 to +150	°C
Operating Temperature	T _{OPR}	-55 to +125	°C
Minimum Breakdown Voltage @ 1 mA	V _{BR}	6.0	V
Working Peak Voltage	V _M	5.0	V
Maximum Clamping Voltage @ I _p = 2 A	V _P	13	V
Maximum Leakage Current @ 3 V	I _L	1	μA
Typical Capacitance 2.5 V @ 1 MHz	C	9.5	pF

Notes:

1. See Peak Pulse Power vs. Pulse Time.

BOURNS®

Asia-Pacific: Tel: +886-2 2562-4117 • Fax: +886-2 2562-4116

EMEA: Tel: +36 88 520 390 • Fax: +36 88 520 211

The Americas: Tel: +1-951 781-5500 • Fax: +1-951 781-5700

www.bourns.com

*RoHS Directive 2002/95/EC Jan. 27, 2003 including annex and RoHS Recast 2011/65/EU June 8, 2011.

Specifications are subject to change without notice.

The device characteristics and parameters in this data sheet can and do vary in different applications and actual device performance may vary over time. Users should verify actual device performance in their specific applications.

Applications

- High speed data ports
- Mobile phones & accessories
- Video/graphics cards
- Set top boxes
- Communication systems

CDSOT353-T05 - TVS Diode Quad Array

BOURNS®

Product Dimensions

This is an RoHS compliant molded SOT353 package with 100 % Matte Sn on the lead frame. It weighs approximately 15 mg and has a flammability rating of UL 94V-0.

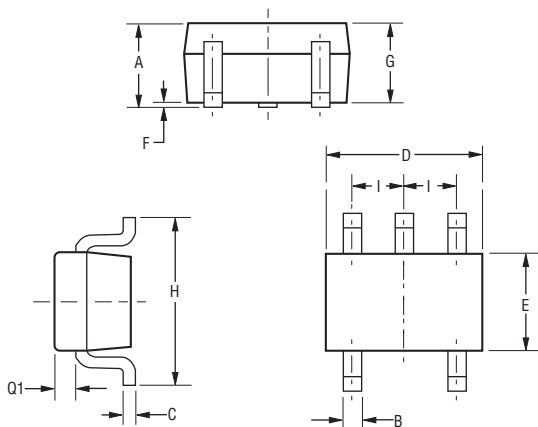

DIMENSIONS: $\frac{\text{MM}}{\text{(INCHES)}}$

Dimension	Min.	Max.
A	$\frac{0.80}{(0.031)}$	$\frac{1.10}{(0.043)}$
B	$\frac{0.15}{(0.006)}$	$\frac{0.30}{(0.012)}$
C	$\frac{0.10}{(0.004)}$	$\frac{0.18}{(0.007)}$
D	$\frac{1.80}{(0.071)}$	$\frac{2.20}{(0.087)}$
E	$\frac{1.15}{(0.045)}$	$\frac{1.35}{(0.053)}$
F	-	$\frac{0.10}{(0.004)}$
G	$\frac{0.80}{(0.031)}$	$\frac{1.00}{(0.039)}$
H	$\frac{1.80}{(0.071)}$	$\frac{2.40}{(0.094)}$
I	$\frac{0.65}{(0.026)}$ TYP.	
Q1	$\frac{0.10}{(0.004)}$	$\frac{0.40}{(0.016)}$

Recommended Footprint

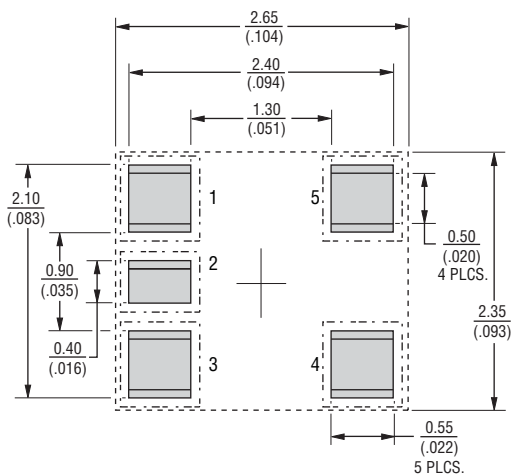

Typical Part Marking

CDSOT353-T05..... D5

How to Order

CD SOT353 - T 05

Common Diode _____
 Chip Diode _____
 Package _____
 SOT353 = SOT353 Package
 Model _____
 T = Transient Voltage Suppressor
 Working Peak Reverse Voltage _____
 05 = 5 V_{RWM} (Volts)

CDSOT353-T05 - TVS Diode Quad Array

BOURNS®

Rating & Characteristic Curves

Non-Repetitive Peak Pulse Power vs. Pulse Time

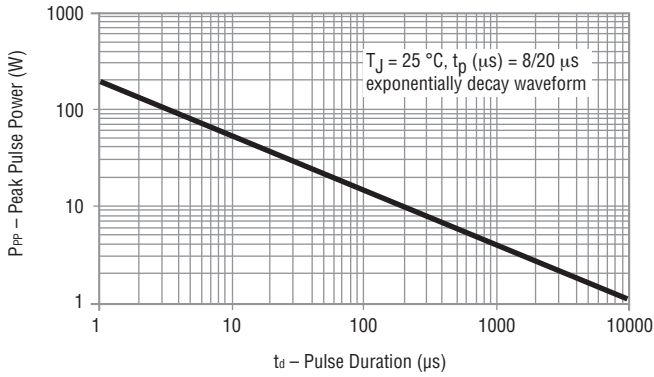

Pulse Waveform

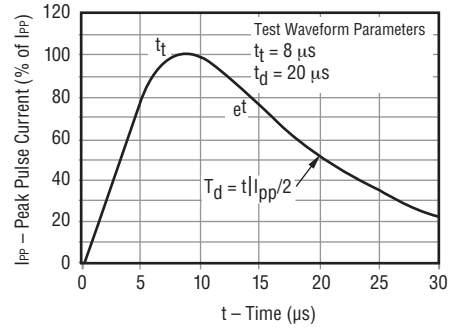

Peak Pulse Power vs. Junction Temperature

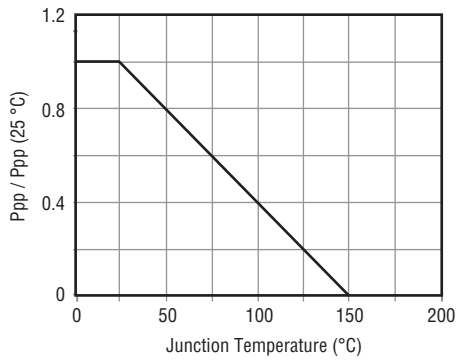

Typical Junction Capacitance

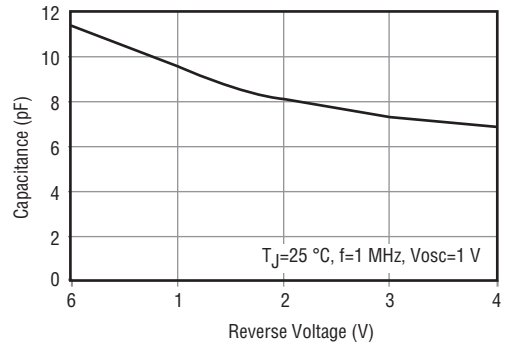

Specifications are subject to change without notice.
The device characteristics and parameters in this data sheet can and do vary in different applications and actual device performance may vary over time.
Users should verify actual device performance in their specific applications.

CDSOT353-T05 - TVS Diode Quad Array

BOURNS®

Packaging Information

The product will be dispensed in tape and reel format (see diagram below).

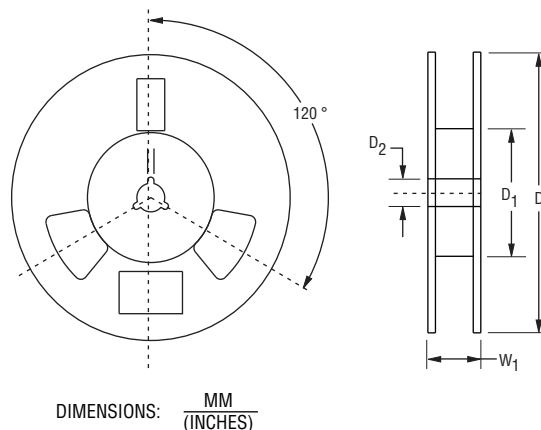
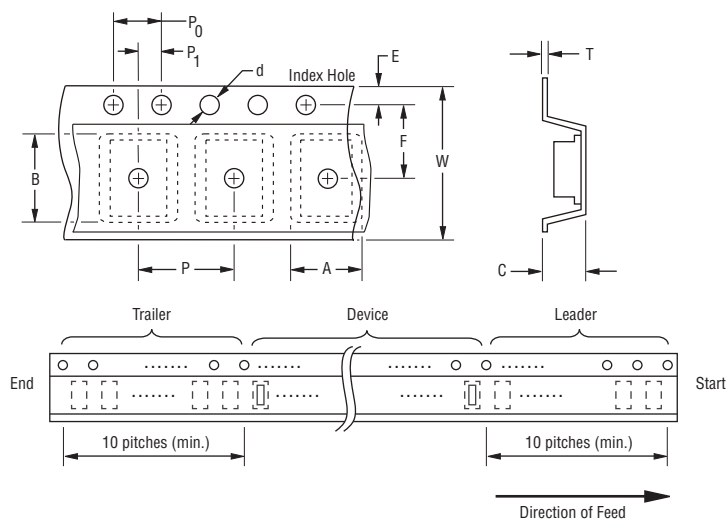

Devices are packed in accordance with EIA standard RS-481-A.

Item	Symbol	CDSOT353
Carrier Width	A	$\frac{2.25 \pm 0.10}{(0.088 \pm 0.004)}$
Carrier Length	B	$\frac{2.34 \pm 0.10}{(0.092 \pm 0.004)}$
Carrier Depth	C	$\frac{1.22 \pm 0.10}{(0.048 \pm 0.004)}$
Sprocket Hole	d	$\frac{1.55 \pm 0.05}{(0.061 \pm 0.002)}$
Reel Outside Diameter	D	$\frac{178}{(7.008)}$
Reel Inner Diameter	D ₁	$\frac{50.0}{(1.969)}$ MIN.
Feed Hole Diameter	D ₂	$\frac{13.0 \pm 0.20}{(0.512 \pm 0.008)}$
Sprocket Hole Position	E	$\frac{1.75 \pm 0.10}{(0.069 \pm 0.004)}$
Punch Hole Position	F	$\frac{3.50 \pm 0.05}{(0.138 \pm 0.002)}$
Punch Hole Pitch	P	$\frac{4.00 \pm 0.10}{(0.157 \pm 0.004)}$
Sprocket Hole Pitch	P ₀	$\frac{4.00 \pm 0.10}{(0.157 \pm 0.004)}$
Embossment Center	P ₁	$\frac{2.00 \pm 0.05}{(0.079 \pm 0.002)}$
Overall Tape Thickness	T	$\frac{0.20 \pm 0.10}{(0.008 \pm 0.004)}$
Tape Width	W	$\frac{8.00 \pm 0.20}{(0.315 \pm 0.008)}$
Reel Width	W ₁	$\frac{14.4}{(0.567)}$ MAX.
Quantity per Reel	--	3000

REV. 07/15

Specifications are subject to change without notice. The device characteristics and parameters in this data sheet can and do vary in different applications and actual device performance may vary over time. Users should verify actual device performance in their specific applications.