

DELPHI SERIES

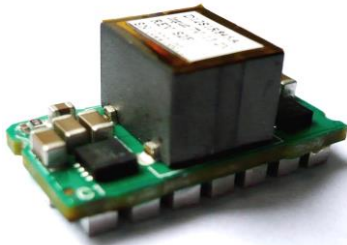

FEATURES

- High efficiency:
95.3% @ 11Vin, 3.3V/35A out
94.3% @ 11Vin, 2.5V/40A out
93.0% @ 11Vin, 1.8V/45A out
89.3% @ 11Vin, 1.0V/45A out
- Small size and low profile:
- 25.4x12.7x12.2mm
(1.00" x 0.50" x 0.48") (SMD)
- Surface mount
- No minimum load required
- Input UVLO, Output OCP/SCP, OVP
- Parallel Units
- ISO 9000, TL 9000, ISO 14001 certified manufacturing facility

D12S1R845D, Non-Isolated, Power Block DC/DC Power Modules: 7.0~13.2Vin, 0.6V~1.8V/45A, 2.5V/40A, 3.3V/35A

The Delphi D12S1R845D, surface mounted, power block is the latest offering from a world leader in power systems technology and manufacturing — Delta Electronics, Inc. The D12S1R845D is the latest offering in the DXP45 family which was developed to address the ever-growing demands of increased current and power densities in networking applications while providing maximum flexibility for system configuration, its benefits can easily be applied to other applications transcending various market segments. The DXP45 family, containing all necessary power components and boasting of a USABLE (55°C, 200LFM) current density of 90A/in² and a power density of up to 231W/in³, is a building block for a new open Digital Power Architecture developed to work with either digital or analog controllers. Measured at 0.5"Wx1.0"Lx0.48"H and rated at 45A of output current, the D12S1R845D is designed to operate with an input voltage from 7V to 13.2V and provide an output voltage adjustable from 0.6V to 3.3V. Each D12S1R845 contains two power trains which can provide either an interleaved single output, or two independent outputs. Multiple D12S1R845D can be used in parallel to serve applications where output currents are in excess of 45A with limitation imposed only by the control circuit, analog or digital. Designed for superior price/performance, the D12S1R845D can provide 3.3V and 35A full load in ambient temperature up to 55°C with 200LFM airflow.

APPLICATIONS

- Telecom / DataCom
- Distributed power architectures
- Servers and workstations
- LAN / WAN applications
- Data processing applications

TECHNICAL SPECIFICATIONS

T_A = 25°C, airflow rate = 200 LFM, V_{in} = 7~13.2Vdc, nominal V_{out} and F_{sw}=400kHz unless otherwise noted.

PARAMETER	NOTES and CONDITIONS	D12S1R845D			
		Min.	Typ.	Max.	Units
ABSOLUTE MAXIMUM RATINGS					
Input Voltage (Continuous)		0		15	Vdc
Operating Temperature	Environment temperature	-40		85	°C
Storage Temperature		-40		125	°C
INPUT CHARACTERISTICS					
Operating Input Voltage		7.0	11.0	13.2	V
Maximum Input Current	V _{in} =7V, V _{out} =3.3V, I _{out} =35A			18.0	A
PWM Rising Threshold	Pin 3		3.0		V
PWM Falling Threshold			2.0		
Typical Tri_state Shutdown Window			1.8		2.4
Gate Voltage	Pin 5 (reference to ground)	6.7	7.0	7.5	Vdc
OUTPUT CHARACTERISTICS					
Output Voltage Adjustable Range	V _{in} =11.0V	0.6		3.3	V
Total Output Voltage Regulation	Total Regulation over load, line and temperature	-1		+1	%V
Output Voltage Ripple and Noise	6x 330µF Tan Capacitor and 220µF ceramic capacitor, BW=20MHz		15		mVpp
Output Voltage Overshoot	@ turn on		0	0.5	%V
Output Current Range	0.6V~1.8V _{out} , single output/ dual output	0		45/22.5	A
	2.5V _{out} , single output/ dual output	0		40/20	A
	3.3V _{out} , single output/ dual output	0		35/17.5	A
Transient Response	V _{in} = 11.0V; I _{out} Step:50%~100%~50%I _{out} ; Slew/Rate: 1A/uS C _{out} : 6x 330µF Tan Capacitor and 220µF ceramic capacitor,		200		mVpp
Inductor Value			340		nH
Inductor DCR			0.52		mΩ
Inductor Peak Current	Inductor temperature of 125°C			24.5	A
EFFICIENCY					
	V _{in} =7V, V _o =1.0V, I _o =45A		89.5		%
	V _{in} =11.0V, V _o =1.0V, I _o =45A		89.3		%
	V _{in} =13.2V, V _o =1.0V, I _o =45A		89.0		%
	V _{in} =7.0V, V _o =3.3V, I _o =35A		95.6		%
	V _{in} =11.0V, V _o =3.3V, I _o =35A		95.3		%
	V _{in} =13.2V, V _o =3.3V, I _o =35A		94.9		%
FEATURE CHARACTERISTICS					
Operating Frequency			400		kHz
GENERAL SPECIFICATIONS					
MTBF	Normal input, I _o =I _{o,max} , T _a =40°C, 100LFM		5.69		M hours
Weight			7.5		grams

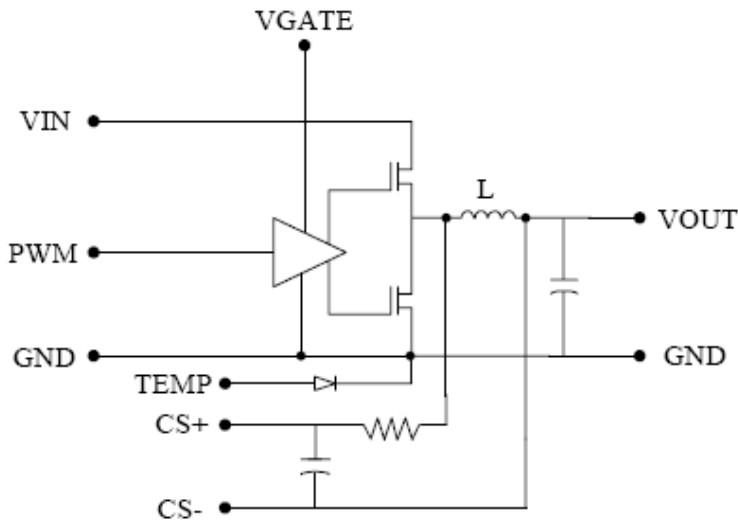

Block diagram of D12S1R845D



ELECTRICAL CHARACTERISTICS CURVES

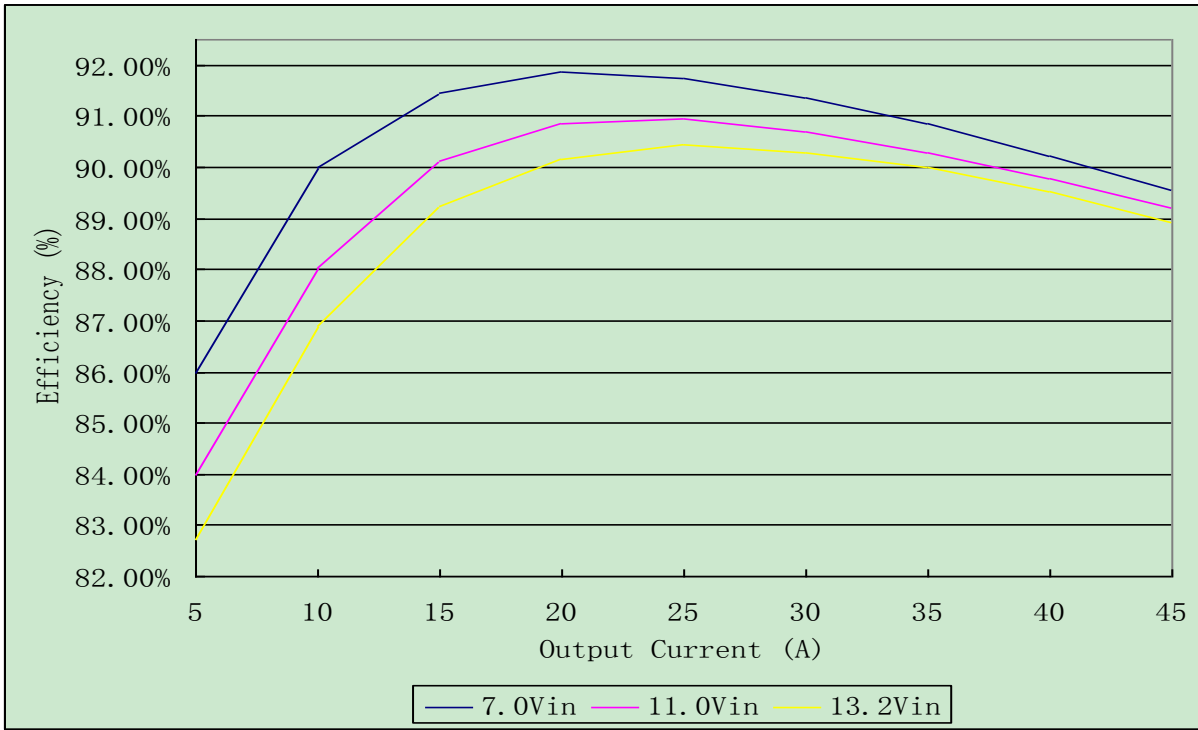

Figure 1: Efficiency vs. load current for minimum, nominal, and maximum input voltage, 1.0V output voltage at 25°C., F_{sw}=400kHz

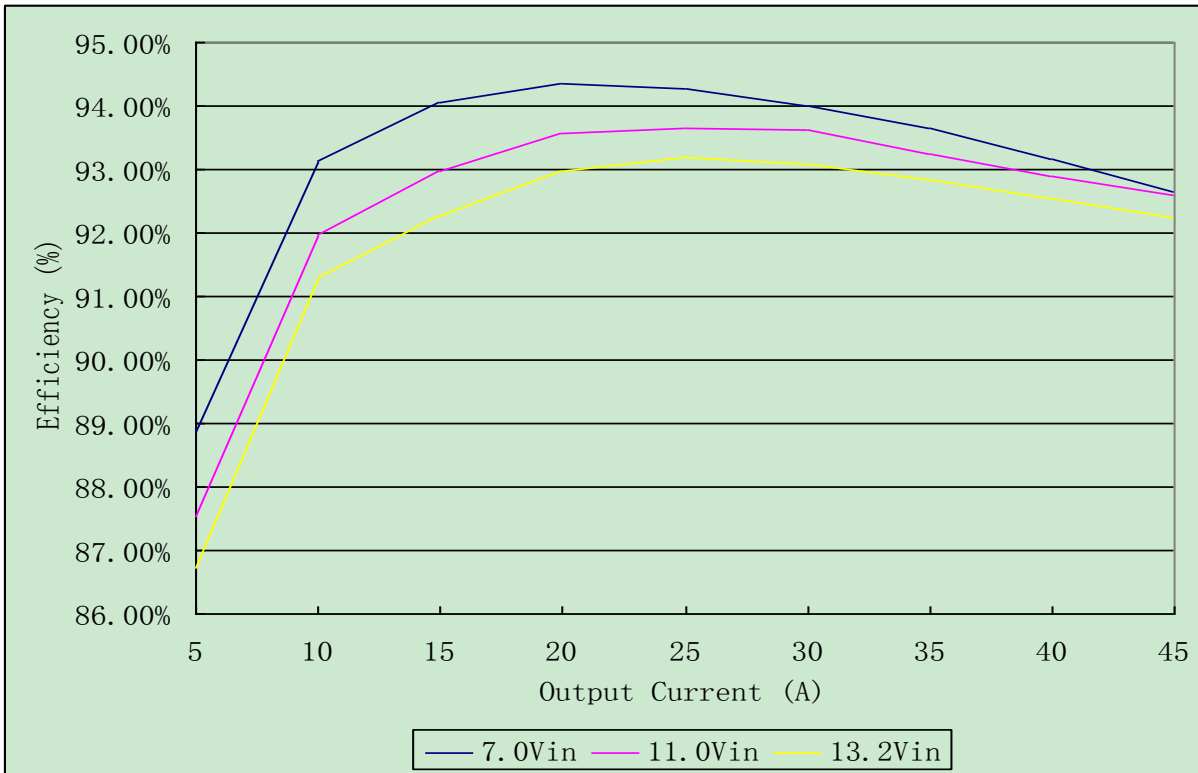

Figure 2: Efficiency vs. load current for minimum, nominal, and maximum input voltage, 1.8V output voltage at 25°C. F_{sw}=400kHz

ELECTRICAL CHARACTERISTICS CURVES

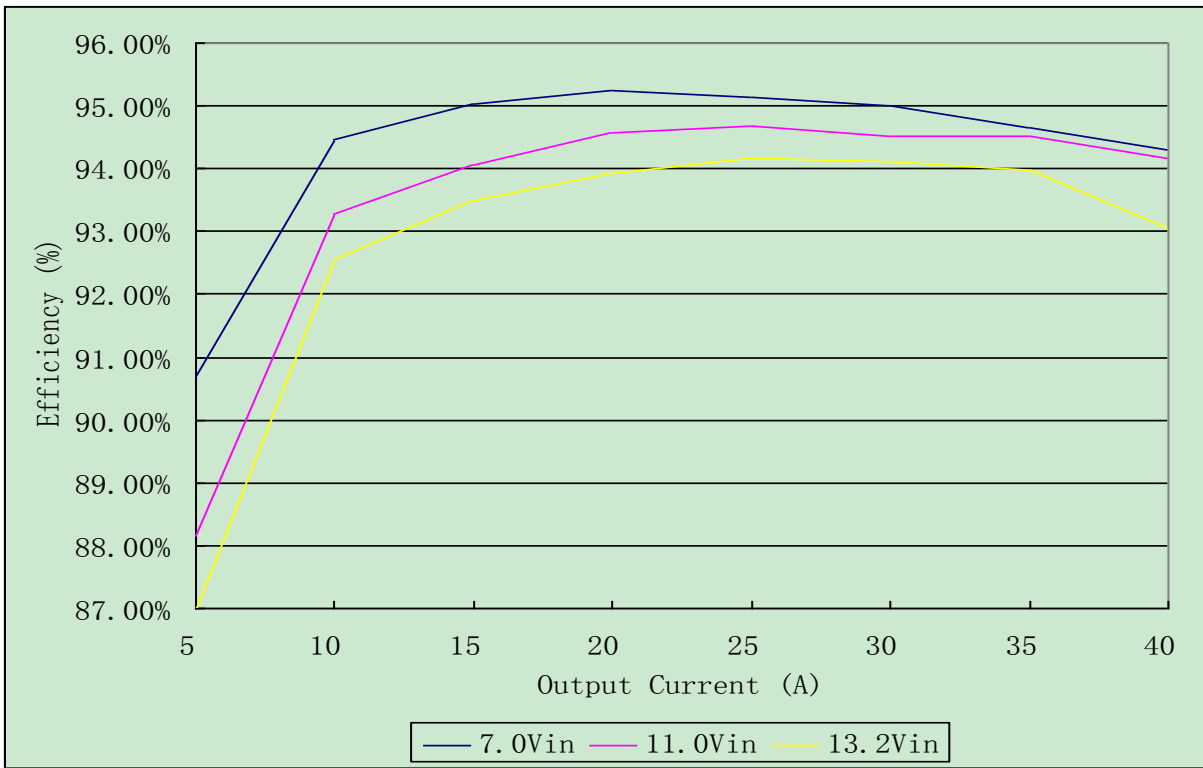

Figure 3: Efficiency vs. load current for minimum, nominal, and maximum input voltage, 2.5V output voltage at 25°C. $F_{sw}=400\text{kHz}$

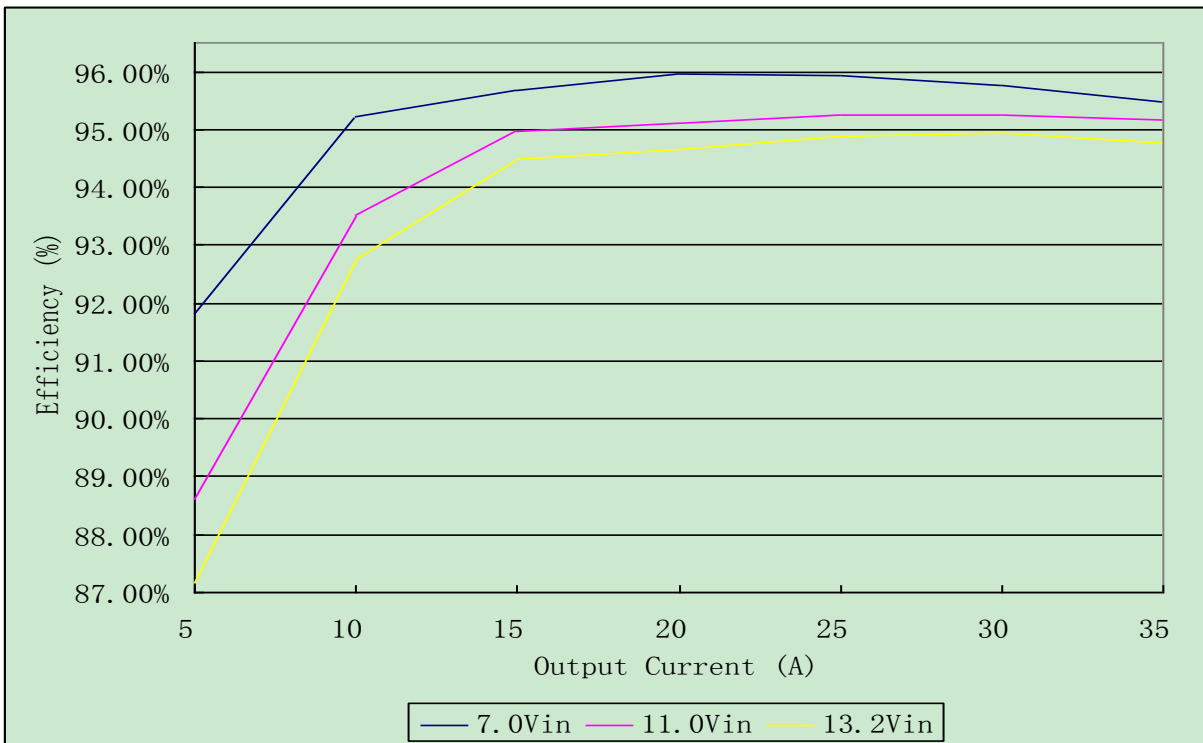

Figure 4: Efficiency vs. load current for minimum, nominal, and maximum input voltage, 3.3V output voltage at 25°C. $F_{sw}=400\text{kHz}$

ELECTRICAL CHARACTERISTICS CURVES

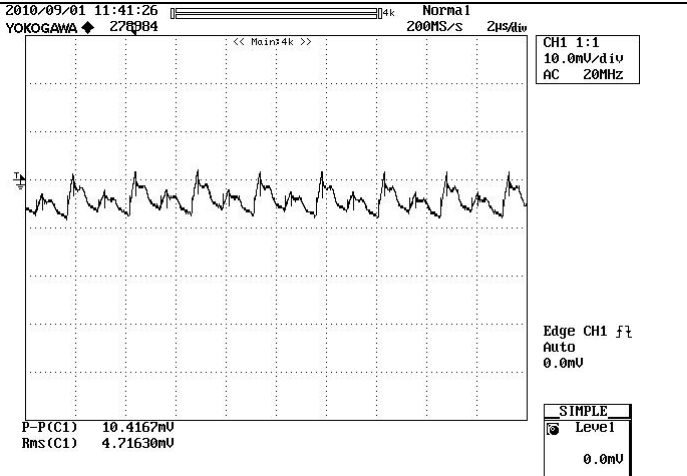

Figure 5: Output Ripple & Noise
Input Voltage=11V, Vout=1.0V, Iout=0 A,

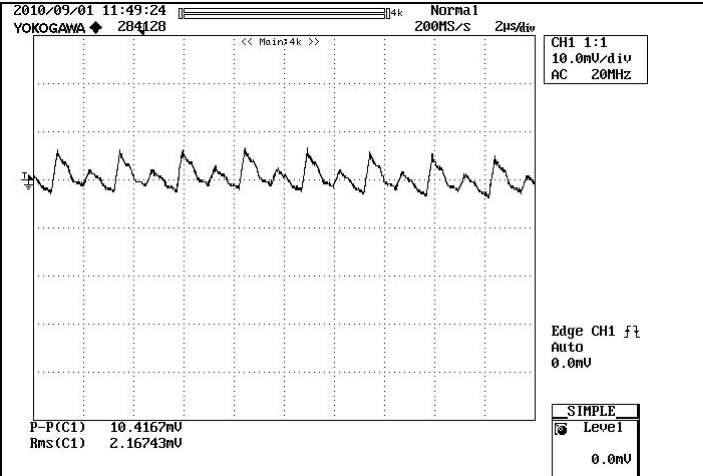

Figure 6: Output Ripple & Noise
Input Voltage=11V, Vout=1.0V, Iout=45 A

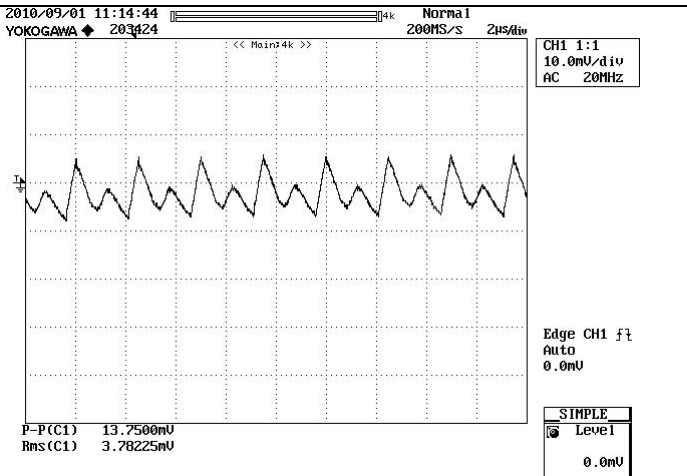

Figure 7: Output Ripple & Noise
Input Voltage=11V, Vout=1.8V, Iout=0 A,

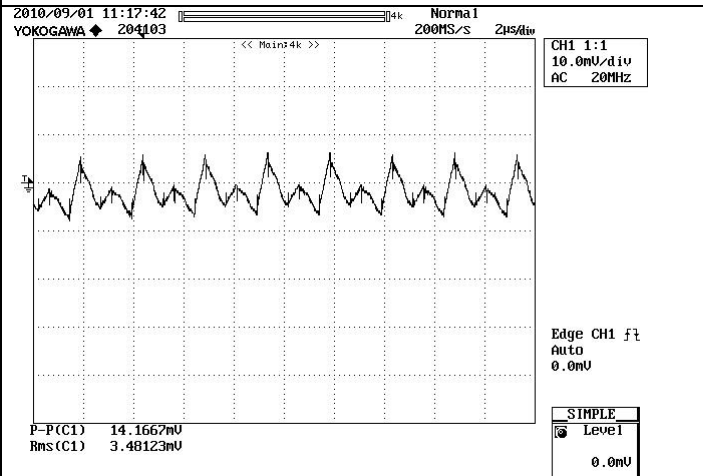

Figure 8: Output Ripple & Noise
Input Voltage=11V, Vout=1.8V, Iout=45 A

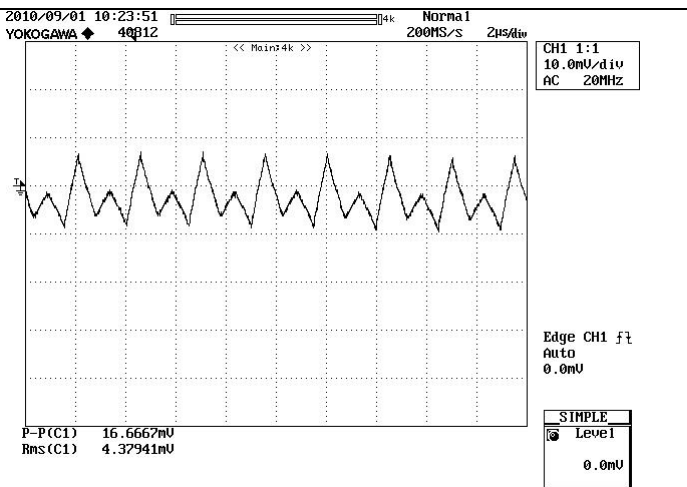

Figure 9: Output Ripple & Noise
Input Voltage=11V, Vout=2.5V, Iout=0 A,

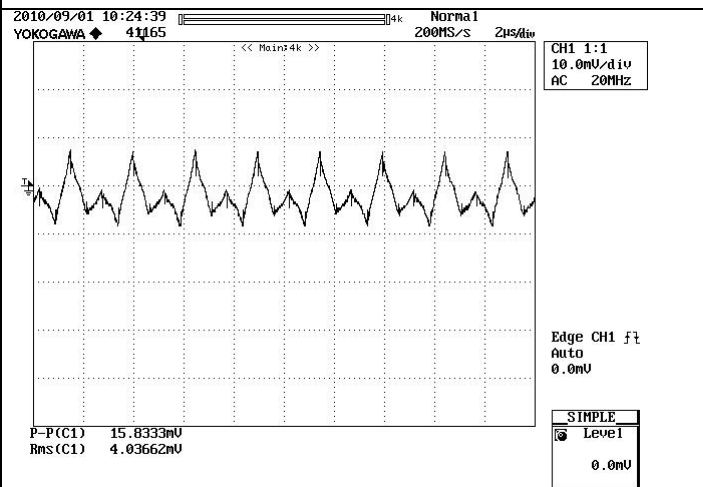

Figure 10: Output Ripple & Noise
Input Voltage=11V, Vout=2.5V, Iout=40 A

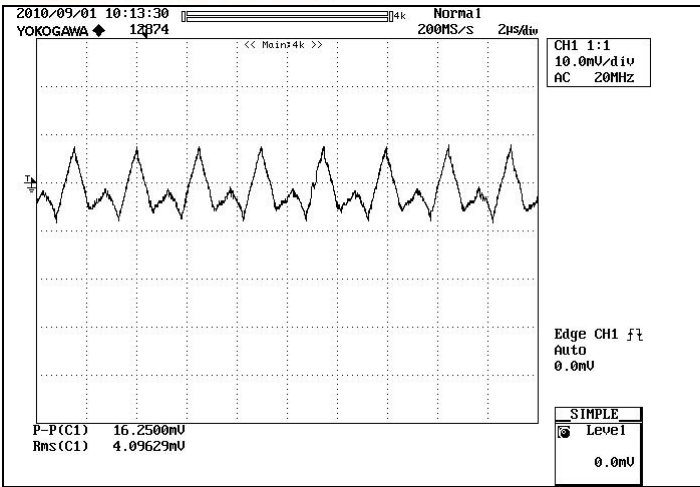

Figure 11: Output Ripple & Noise
 Input Voltage=11V, Vout=3.3V, Iout=0 A,

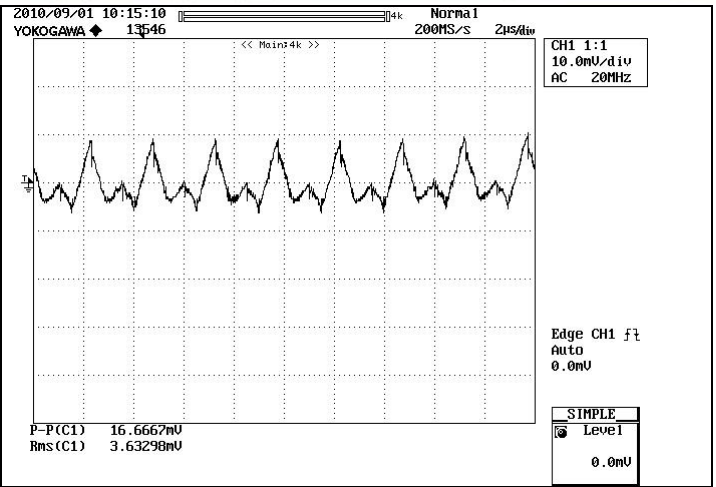

Figure 12: Output Ripple & Noise
 Input Voltage=11V, Vout=3.3V, Iout=35 A

ELECTRICAL CHARACTERISTICS CURVES

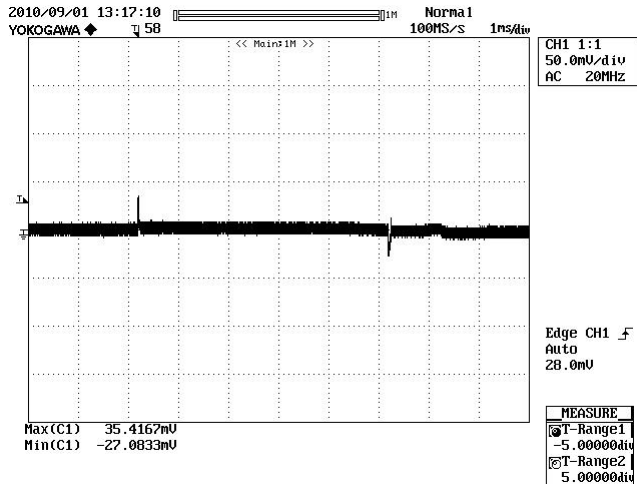

Figure 13: Dynamic response: Load Step: 100% ~ 50%~100%
 (Vin =11.0V; 1.0V Output Voltage; slew rate=1A/uS)

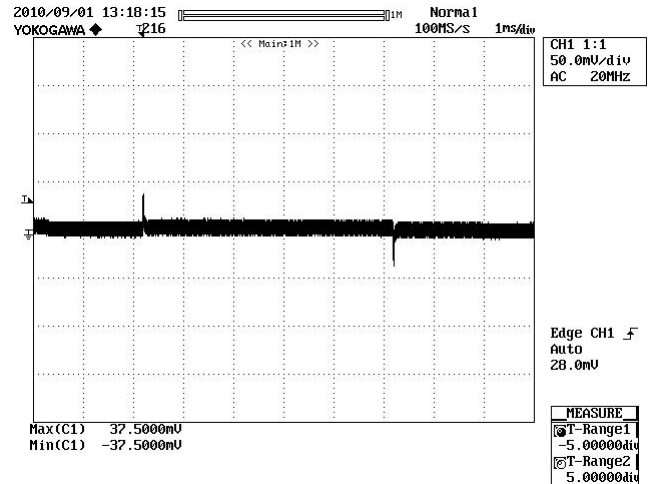

Figure 14: Dynamic response: Load Step: 100% ~ 50%~100%
 (Vin =11.0V; 1.8V Output Voltage; slew rate=1A/uS)

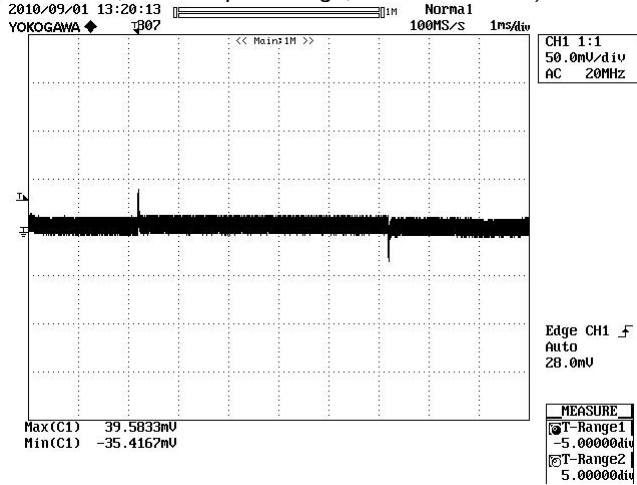

Figure 15: Dynamic response: Load Step: 100% ~ 50%~100%
 (Vin =11.0V; 2.5V Output Voltage; slew rate=1A/uS)

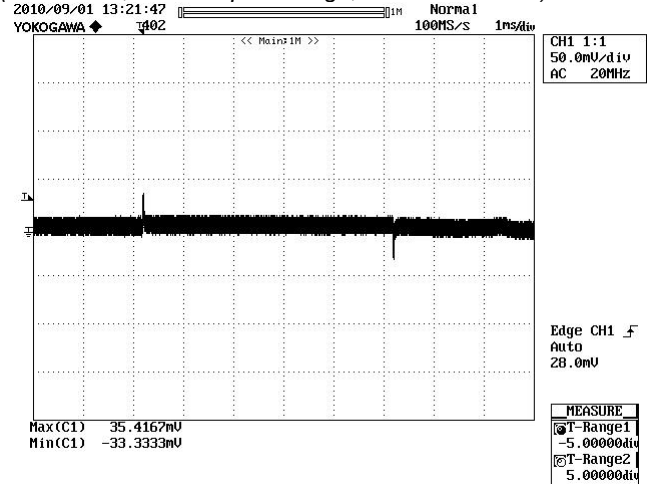

Figure 16: Output Fall Time: 1 pcs Converter on test board.
 (Vin =11.0V; 3.3V Output Voltage; Iout = 35A)

TEST CONFIGURATIONS

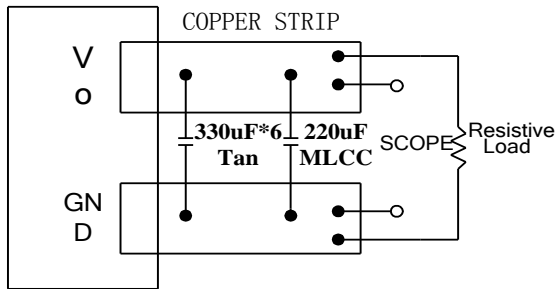

Figure 17: Peak-peak output ripple & noise and startup transient measurement test setup

Note: 6pcs 330 μ F TAN and 220 μ F MLCC capacitor in the module output. Scope measurement should be made by using a BNC connector.

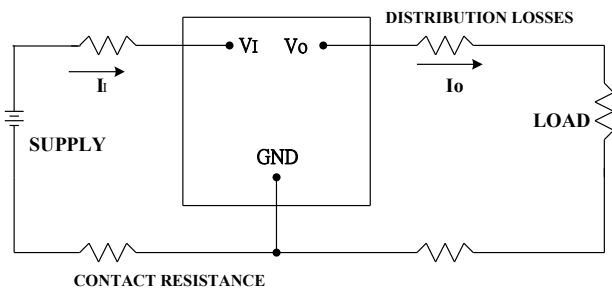

Figure 18: Output voltage and efficiency measurement test setup

Note: All measurements are taken at the module terminals. When the module is not soldered (via socket), place Kelvin connections at module terminals to avoid measurement errors due to contact resistance.

$$\eta = \left(\frac{V_o \times I_o}{V_i \times I_i + V_{driver} * I_{driver}} \right) \times 100 \%$$

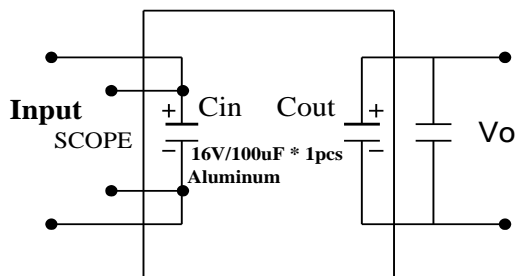

Figure 19: Peak-peak Input ripple & noise measurement test setup

Note: 1pcs 1,00 μ F Aluminum in the module input. Scope measurement should be made by using a BNC connector.

DESIGN CONSIDERATIONS

The power module should be connected to a low ac-impedance input source. Highly inductive source impedances can affect the stability of the module. An input capacitance must be placed close to the modules input pins to filter ripple current and ensure module stability in the presence of inductive traces that supply the input voltage to the module.

FEATURES DESCRIPTIONS

Over-Current Protection

To provide protection in an output over load fault condition, the unit is equipped with internal over-current protection. When the over-current protection is triggered, the unit will be shutdown and restart after a period of time. The units operate normally once the fault condition is removed.

THERMAL CONSIDERATIONS

Thermal management is an important part of the system design. To ensure proper, reliable operation, sufficient cooling of the power module is needed over the entire temperature range of the module. Convection cooling is usually the dominant mode of heat transfer.

Hence, the choice of equipment to characterize the thermal performance of the power module is a wind tunnel.

Thermal Testing Setup

Delta's DC/DC power modules are characterized in heated wind tunnels that simulate the thermal environments encountered in most electronics equipment.

The following figures show the wind tunnel characterization setup. The power module is mounted on delta test board and is vertically positioned within the wind tunnel.

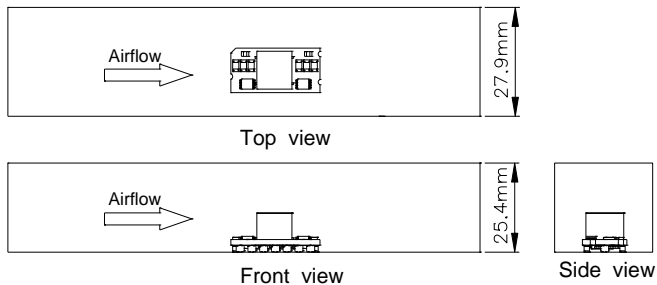

Figure 20: Wind Tunnel Test Setup

Thermal De-rating

The module's maximum hot spot temperature is +115°C. To enhance system reliability, the power module should always be operated below the maximum operating temperature. If the temperature exceeds the maximum module temperature, reliability of the unit may be affected.

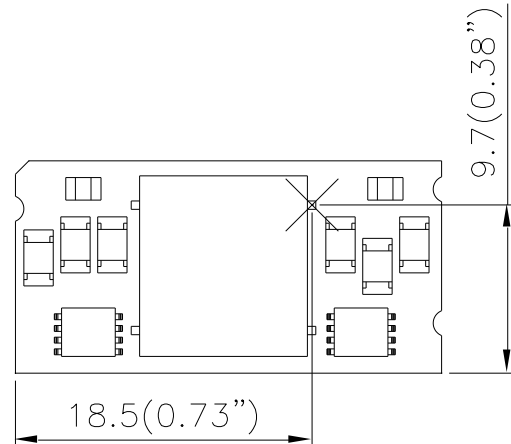

Figure 21: Temperature measurement location
The allowed maximum hot spot temperature is defined at 115°C



THERMAL CURVES

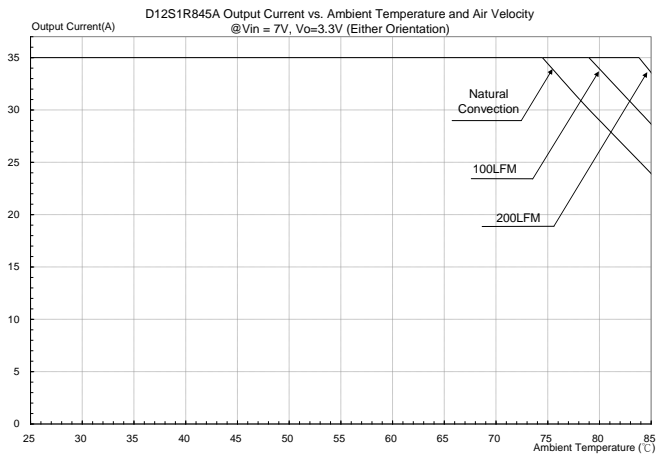

Figure 22: Output current vs. ambient temperature and air velocity @ Vin=7V, Vout=3.3V (Either Orientation)

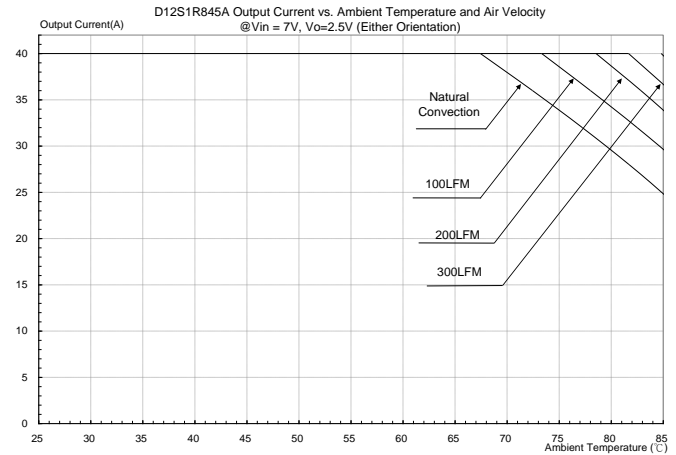

Figure 25: Output current vs. ambient temperature and air velocity @ Vin=7V, Vout=2.5V (Either Orientation)

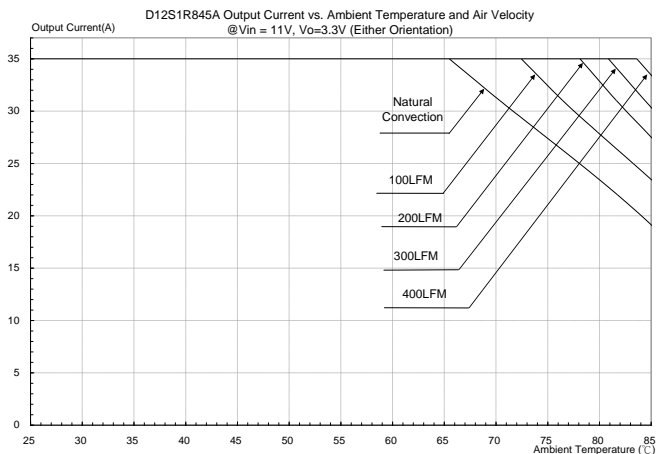

Figure 23: Output current vs. ambient temperature and air velocity @ Vin=11V, Vout=3.3V (Either Orientation)

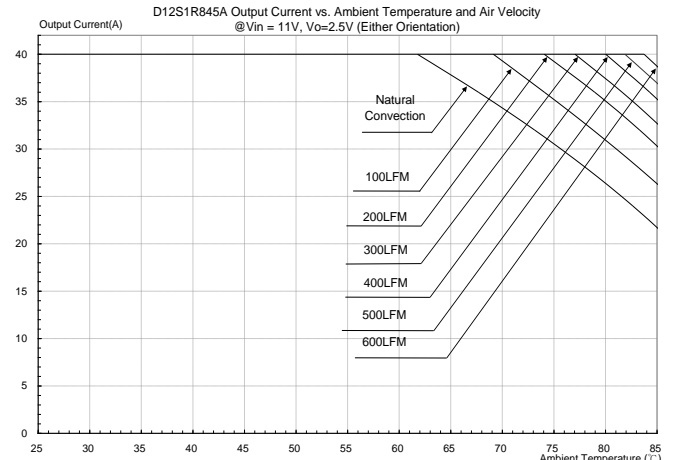

Figure 26: Output current vs. ambient temperature and air velocity @ Vin=11V, Vout=2.5V (Either Orientation)

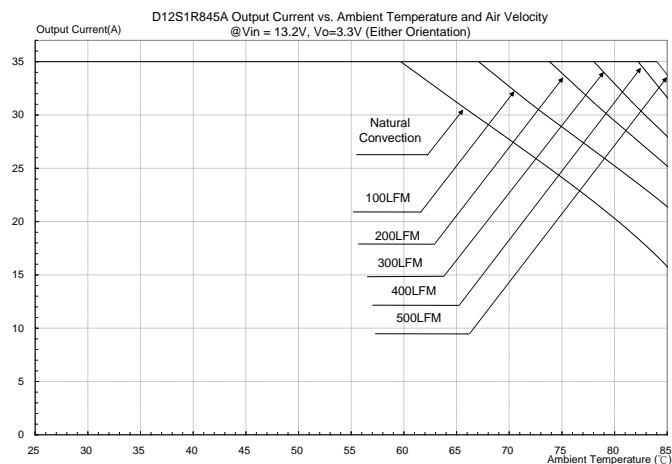

Figure 24: Output current vs. ambient temperature and air velocity @ Vin=13.2V, Vout=3.3V (Either Orientation)

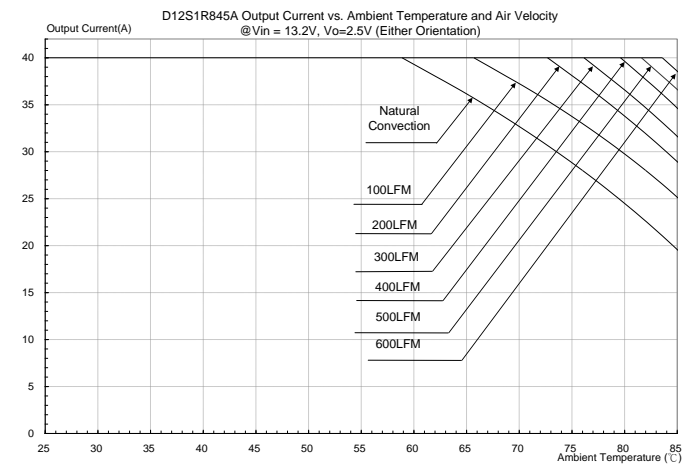

Figure 27: Output current vs. ambient temperature and air velocity @ Vin=13.2V, Vout=2.5V (Either Orientation)

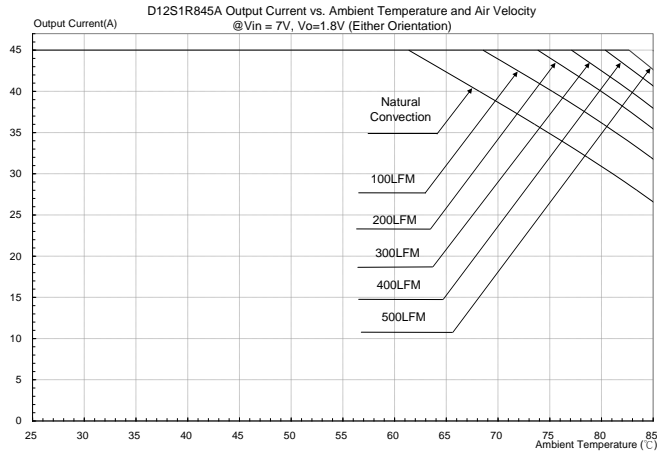

Figure 28: Output current vs. ambient temperature and air velocity @ $V_{in}=7V$, $V_{out}=1.8V$ (Either Orientation)

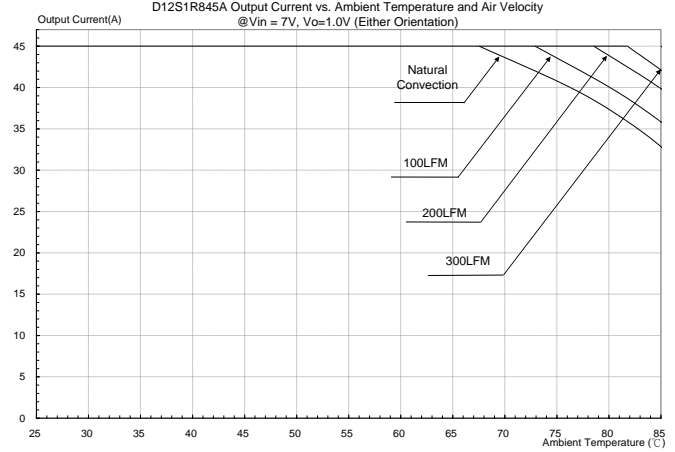

Figure 31: Output current vs. ambient temperature and air velocity @ $V_{in}=7V$, $V_{out}=1.0V$ (Either Orientation)

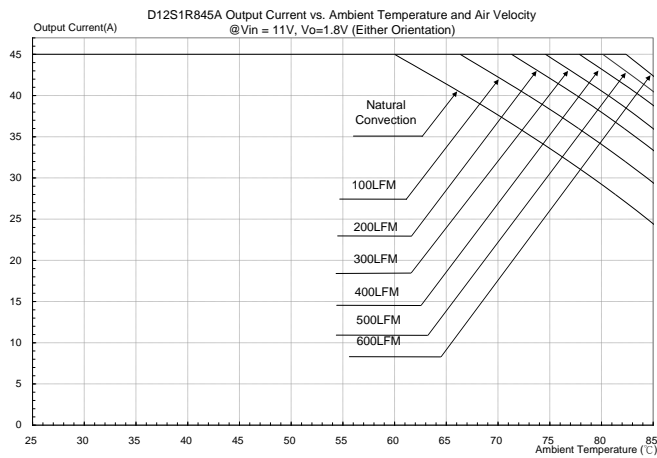

Figure 29: Output current vs. ambient temperature and air velocity @ $V_{in}=11V$, $V_{out}=1.8V$ (Either Orientation)

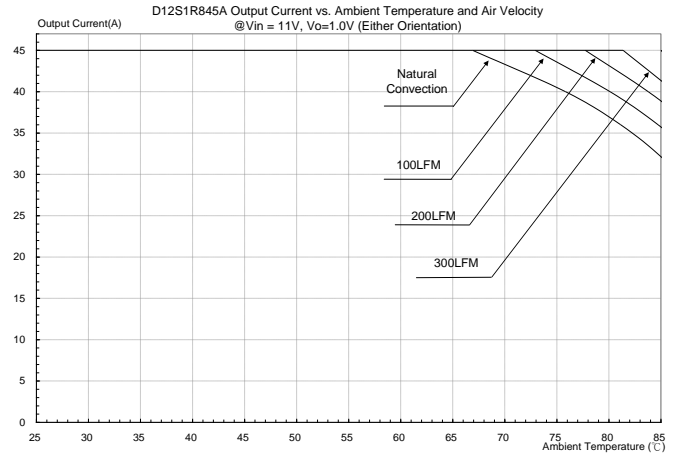

Figure 32: Output current vs. ambient temperature and air velocity @ $V_{in}=11V$, $V_{out}=1.0V$ (Either Orientation)

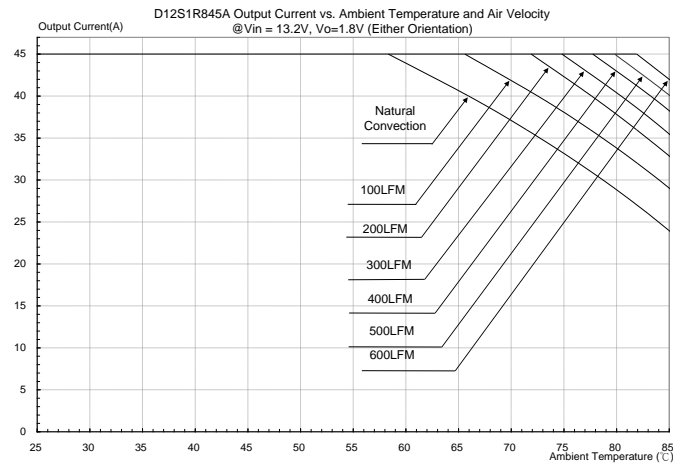

Figure 30: Output current vs. ambient temperature and air velocity @ $V_{in}=13.2V$, $V_{out}=1.8V$ (Either Orientation)

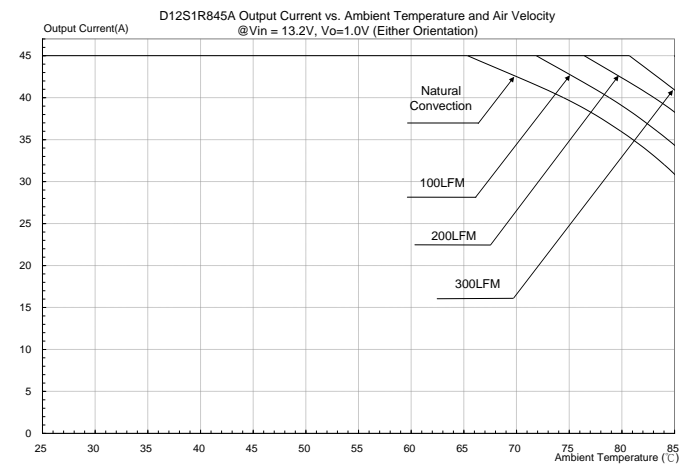
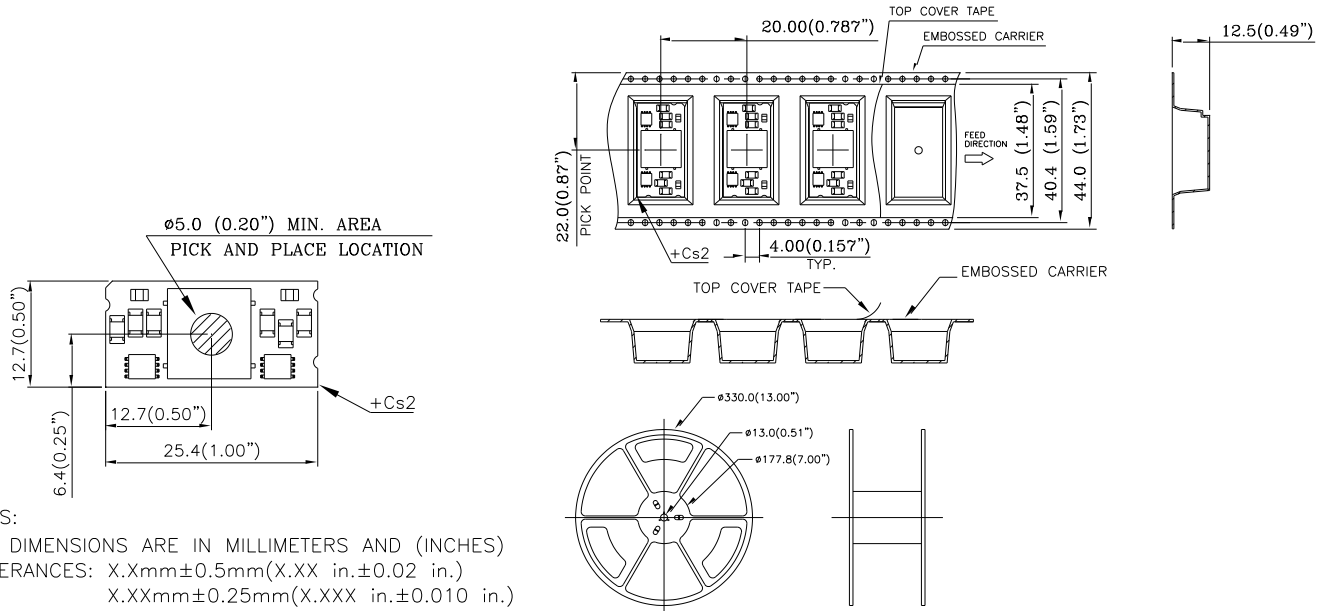

Figure 33: Output current vs. ambient temperature and air velocity @ $V_{in}=13.2V$, $V_{out}=1.0V$ (Either Orientation)

MECHANICAL CONSIDERATIONS

SURFACE-MOUNT TAPE & REEL



NOTES:
 ALL DIMENSIONS ARE IN MILLIMETERS AND (INCHES)
 TOLERANCES: X.Xmm \pm 0.5mm(X.XX in. \pm 0.02 in.)
 X.XXmm \pm 0.25mm(X.XXX in. \pm 0.010 in.)

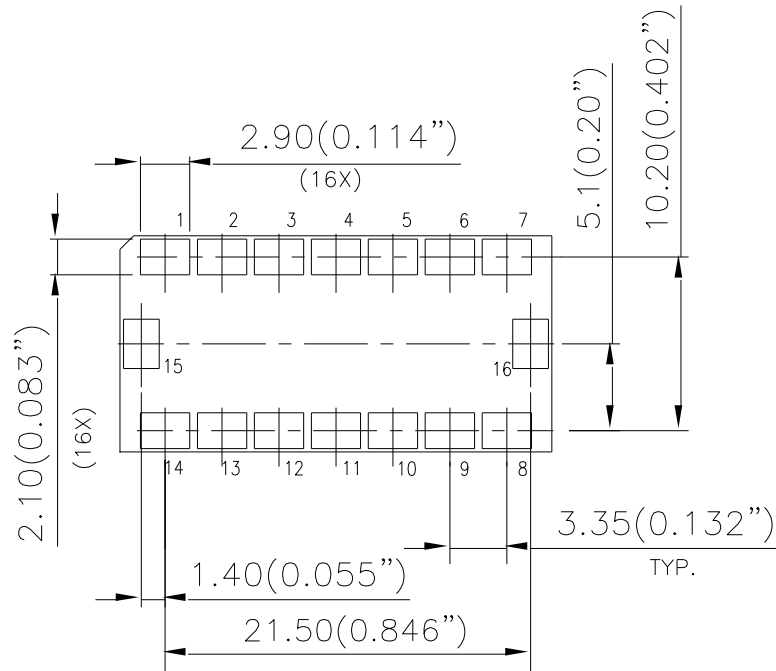

RECOMMENDED PAD LAYOUT

MECHANICAL DRAWING

TOP VIEW

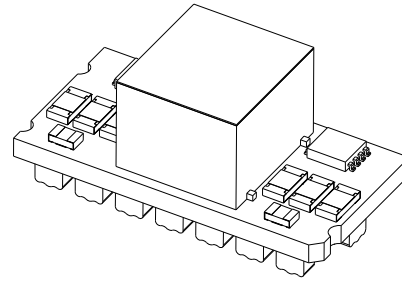
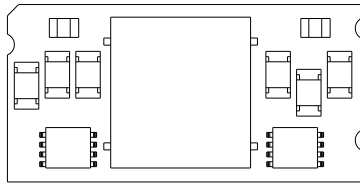

SIDE VIEW

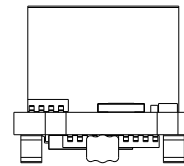
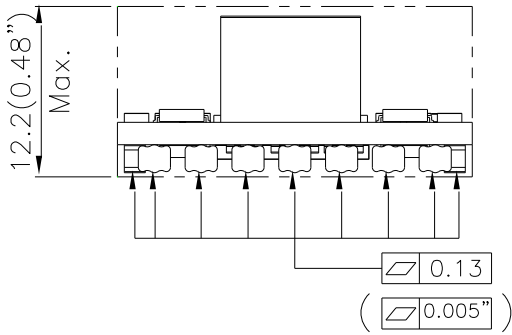

BOTTOM VIEW

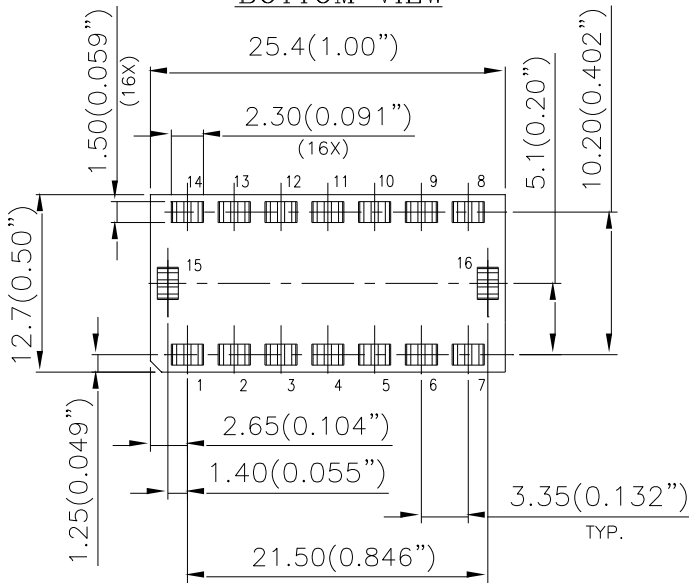

PIN#	Function
1	-Cs1
2	GND
3	Vout1
4	+7Vin
5	Vout2
6	GND
7	-Cs2
8	+Cs2
9	Vin2
10	PWM2
11	GND
12	PWM1
13	Vin1
14	+Cs1
15	Temperature1
16	Temperature2

NOTES:

ALL DIMENSIONS ARE IN MILLIMETERS AND (INCHES)
 TOLERANCES: X.Xmm±0.5mm(X.XX in.±0.02 in.)
 X.XXmm±0.25mm(X.XXX in.±0.010 in.)

**** ALL PIN ARE COPPER WITH MATTE TIN PLATED.**



PART NUMBERING SYSTEM

D	12	S	1R8	45	D
Type of Product	Input Voltage	Number of Outputs	Output Voltage	Output Current	Option Code
D - DC/DC modules	12 - 7 ~13.2V	S - Single	1R8 - 0.6~3.3V	45 - 45A max	D - Standard

MODEL LIST

Model Name	Input Voltage	Output Voltage	Output Current	RoHS	Total Height	Efficiency 7Vin, 3.3Vout @ 35A
D12S1R845D	7.0 ~ 13.2Vdc	0.6V ~ 3.3V	45A max	RoHS 6/6	0.48"	95.5%

CONTACT: www.deltaww.com/dcdc Email: dcdc@deltaww.com

USA:

Telephone:
East Coast: 978-656-3993
West Coast: 510-668-5100
Fax: (978) 656 3964

Europe:

Phone: +31-20-655-0967
Fax: +31-20-655-0999

Asia & the rest of world:

Telephone: +886 3 4526107
ext 6220~6224
Fax: +886 3 4513485

WARRANTY

Delta offers a two (2) year limited warranty. Complete warranty information is listed on our web site or is available upon request from Delta.

Information furnished by Delta is believed to be accurate and reliable. However, no responsibility is assumed by Delta for its use, nor for any infringements of patents or other rights of third parties, which may result from its use. No license is granted by implication or otherwise under any patent or patent rights of Delta. Delta reserves the right to revise these specifications at any time, without notice.