

### Extrusion

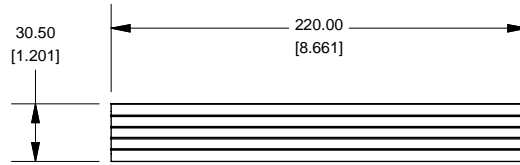

EXTRUSION DESIGNED FOR 160MM WIDE PC BOARD

### Slot Details

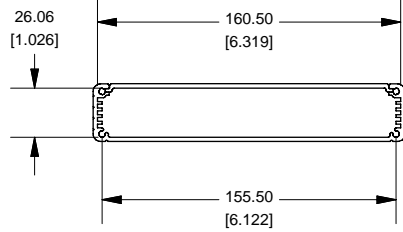
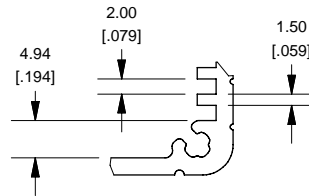

### End Plate

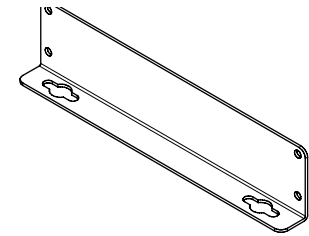
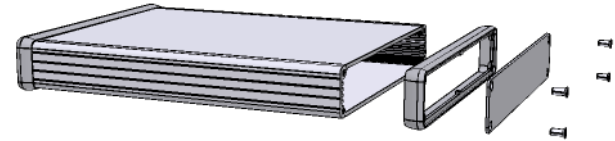
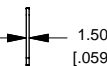
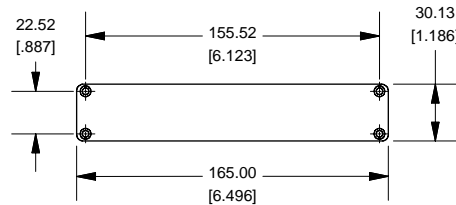

### OPTIONAL FLANGE END PANELS 1455RF

Enclosures can be Factory Modified ( Milling, Drilling, Printing etc. )  
 Solid models of this enclosure available in STEP or IGES.  
 Contact Factory [mjm@hammondmfg.com](mailto:mjm@hammondmfg.com)

NOTE	
Purchased assembly includes box, plastic bezels, end panels, #6 Taptight screws and self adhesive rubber feet.	
Box made from Extruded Aluminum 6063.	
Bezels made with polycarbonate.	

1455R2201 PART NUMBERS	
Clear Anodized	1455R2201
Black Anodized	1455R2201BK
ACCESSORIES	
See website for accessories.	

### Open Bezel

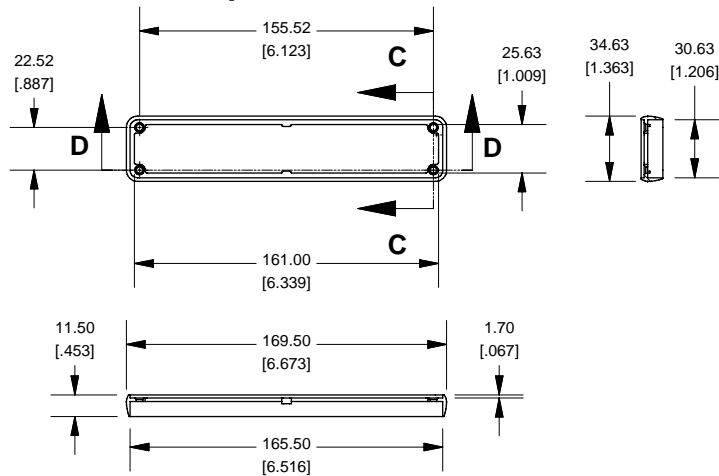

**HAMMOND MANUFACTURING™**

**1455R2201**

[www.hammondmfg.com](http://www.hammondmfg.com)