

REVISIONS				
REV.	ECO. NO	DESCRIPTION	DATE	BY
A	2259	INITIAL RELEASE	3/08/2011	JH
B	3189	ADD 'T' MATERIAL, UPDATE DWG FORMAT	3/30/2015	MG

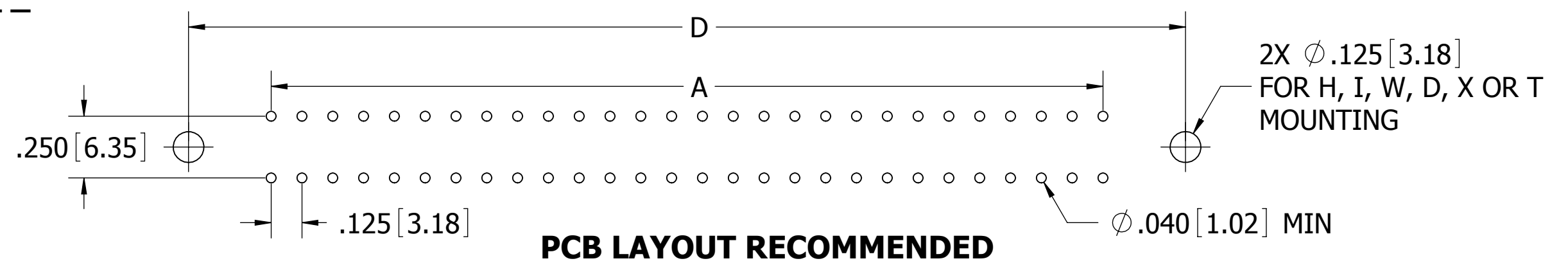

- NOTES:
1. INSULATOR MATERIAL: SEE PART NUMBER CODING
  2. CONTACT MATERIAL: SEE PART NUMBER CODING
  3. PLATING: SEE PART NUMBER CODING
  4. OPERATING TEMPERATURE: SEE PART NUMBER CODING
  5. PROCESSING TEMP: SEE PART NUMBER CODING
  6. UL FLAMMABILITY RATING: 94V-0
  7. OPERATING VOLTAGE: 750 VAC
  8. CURRENT RATING: 3 AMP
  9. CONTACT RESISTANCE: 30 MILLI OHM MAX
  10. INSULATION RESISTANCE: 5000 MEGA OHM MIN
  11. DURABILITY: 500 CYCLES MIN
  12. CONNECTOR IDENTIFICATION: THE PART SHALL BE MARKED WITH A PART NUMBER AND LOT CODE
  13. BOARD THICKNESS ACCOMMODATED:  $.062 \pm .008 [1.57 \pm 0.20]$
  14. INSERTION FORCE: 8 OZ MAX PER CONTACT PAIR WHEN USING A .062" TEST BLADE.
  15. WITHDRAWAL FORCE: 1 OZ MIN PER CONTACT PAIR USING .062" PCB
  16. MODIFICATION: SEE PART NUMBER CODING

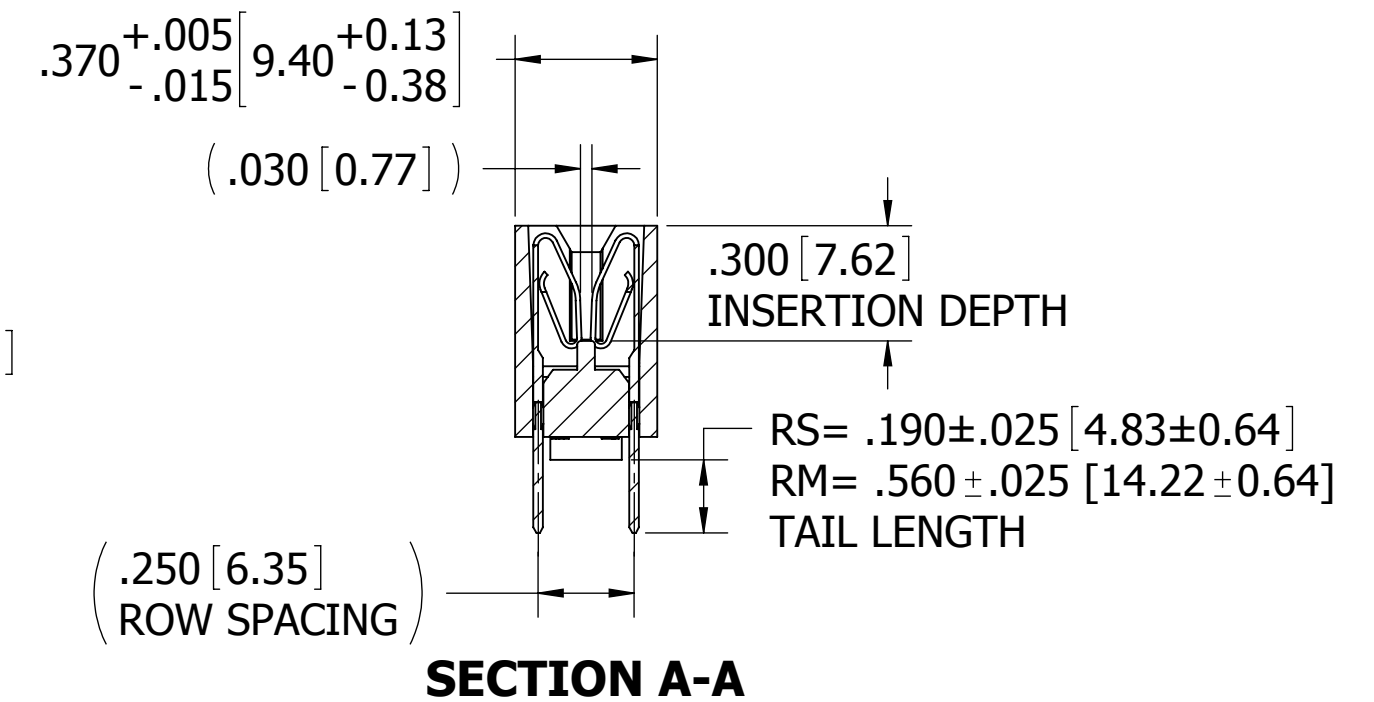
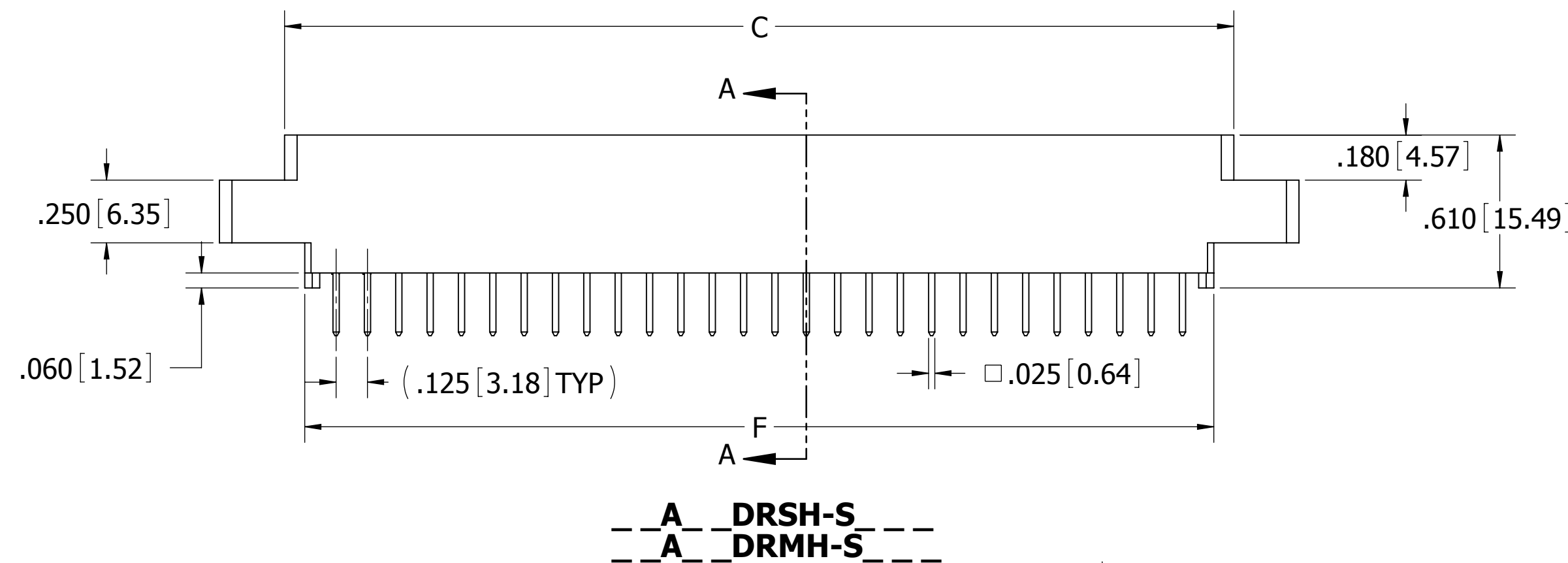
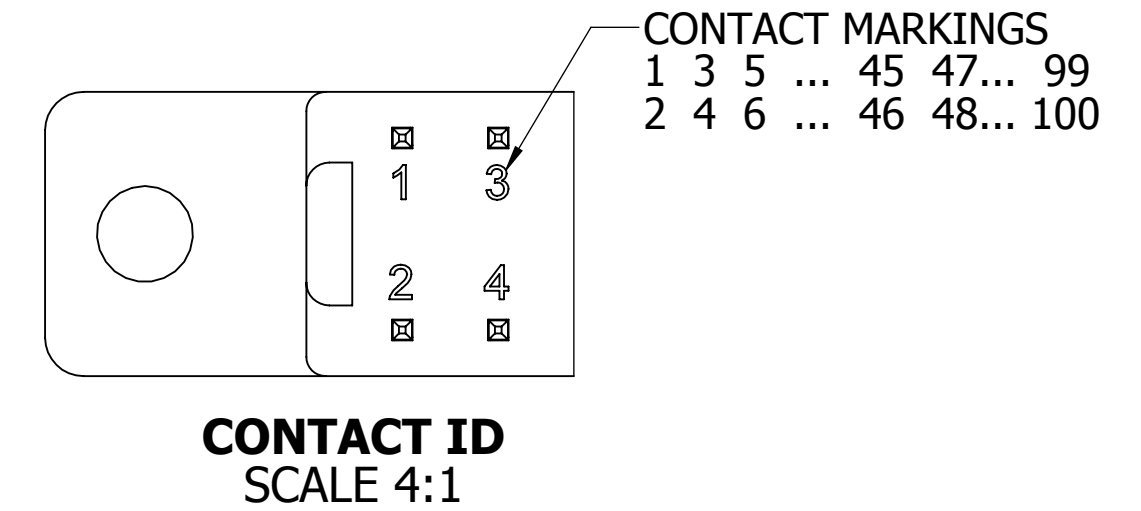
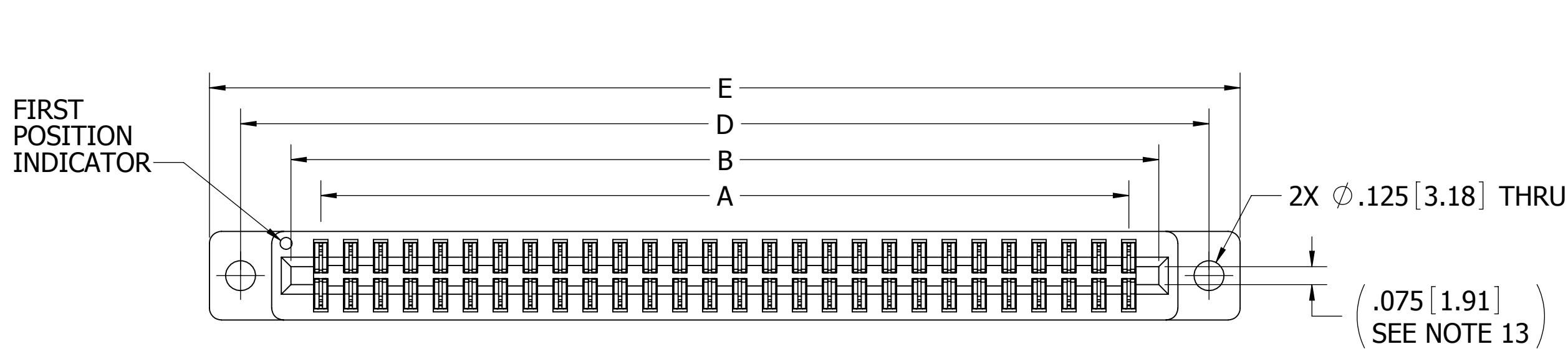

UNLESS OTHERWISE SPECIFIED: DIMENSIONS ARE IN INCHES [MM]		DRAWN	DATE	NAME	
			6/24/2011	JH	
TOLERANCES: ANGULAR: $\pm 1^\circ$  DECIMALS .XX = $\pm .02 [0.5]$ .XXX = $\pm .005 [0.13]$ .XXXX = $\pm .0005 [0.013]$					TITLE <b>EDGECARD .125" PITCH, HP</b>
THE INFORMATION HEREIN CONTAINS PROPRIETARY INFORMATION OF SULLINS ELECTRONICS AND IS NOT TO BE REPRODUCED, USED OR DISCLOSED TO OTHERS FOR ANY PURPOSE EXCEPT AS SPECIFICALLY AUTHORIZED IN WRITING BY AN OFFICER OF SULLINS ELECTRONICS.					PART NUMBER <b>__A__DRS (DRM)_ (-S38, S81, S328)</b>
SIZE	CAGE CODE	DWG. NO.	REV		
C	54453	C11651	B		
SCALE: 2:1		SHEET 1 OF 3			

**CUSTOMER COPY**

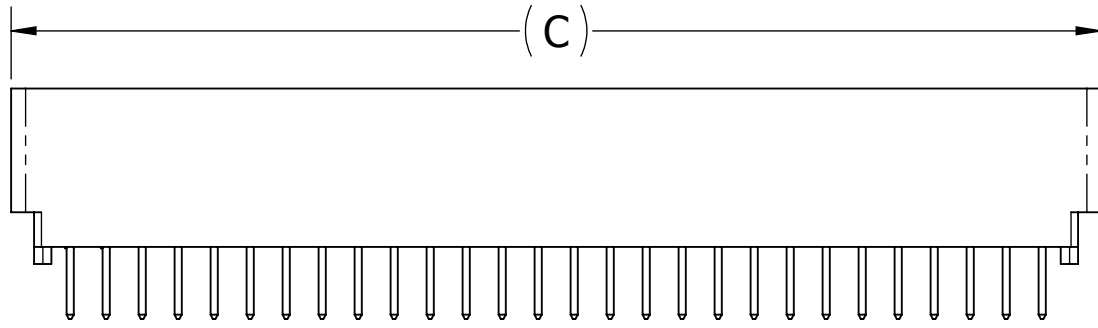
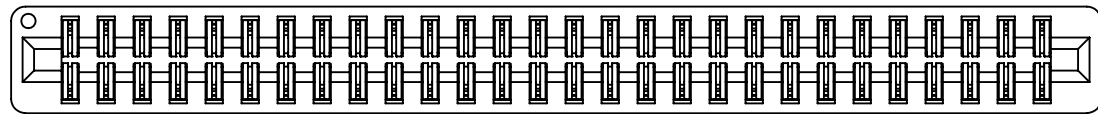

**A** **DRSN-S**  
**A** **DRMN-S**

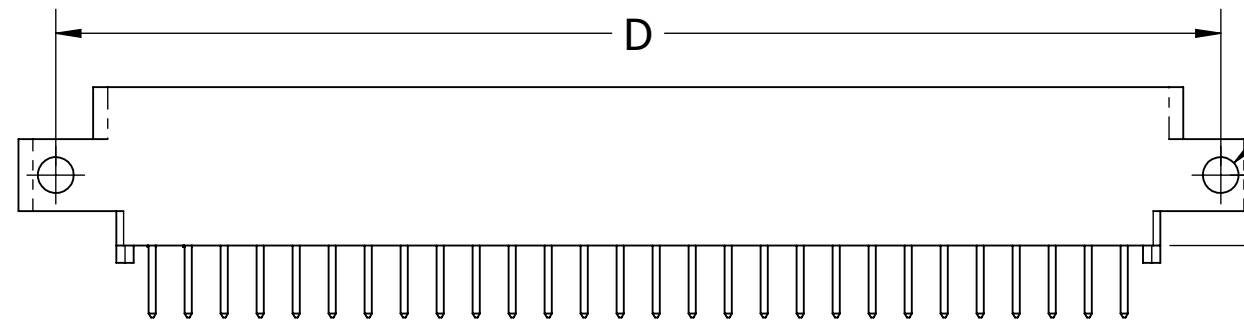
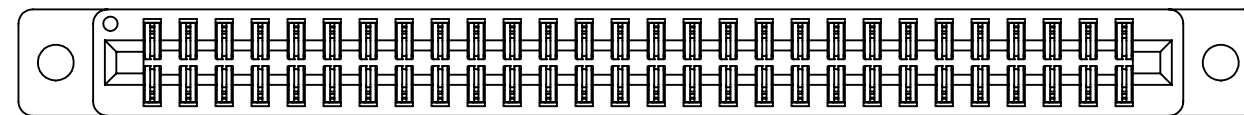

**A** **DRSS-S**  
**A** **DRMS-S**

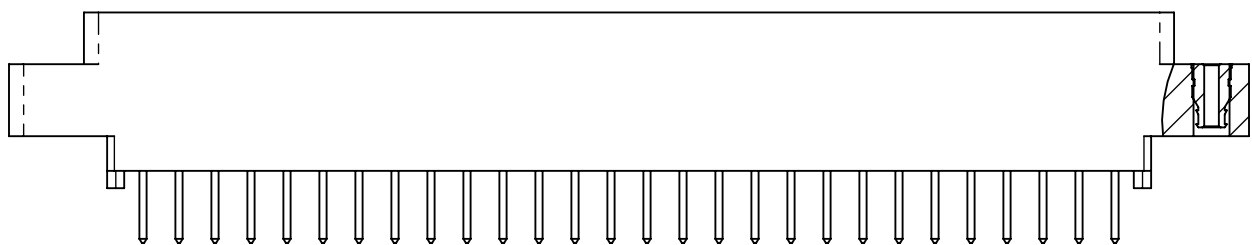
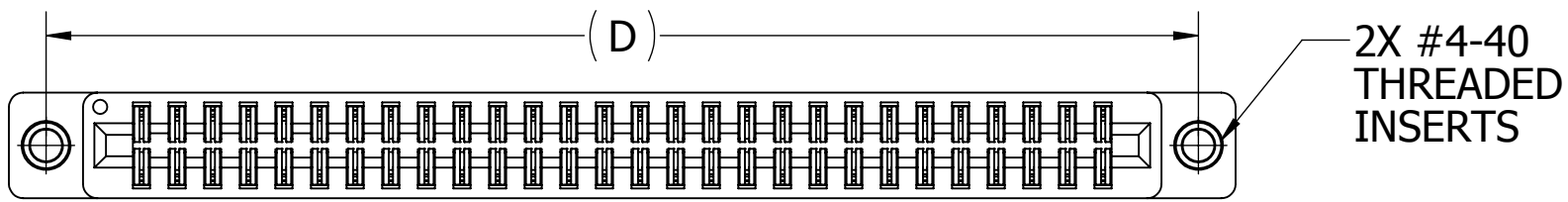

**A** **DRSI-S**  
**A** **DRMI-S**

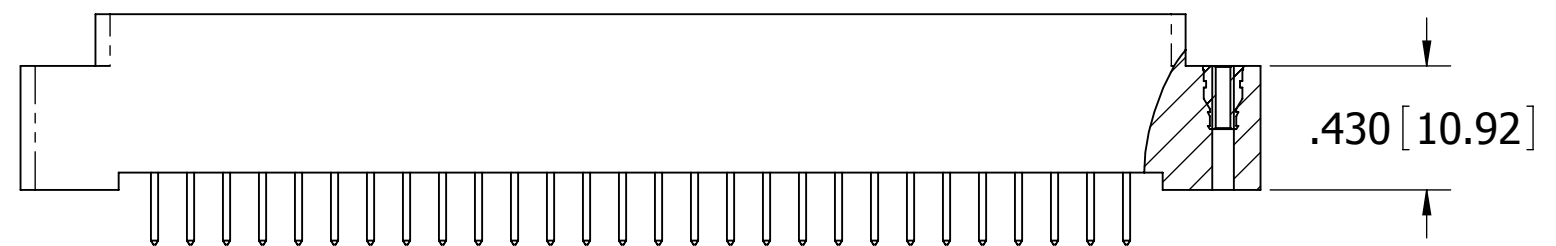
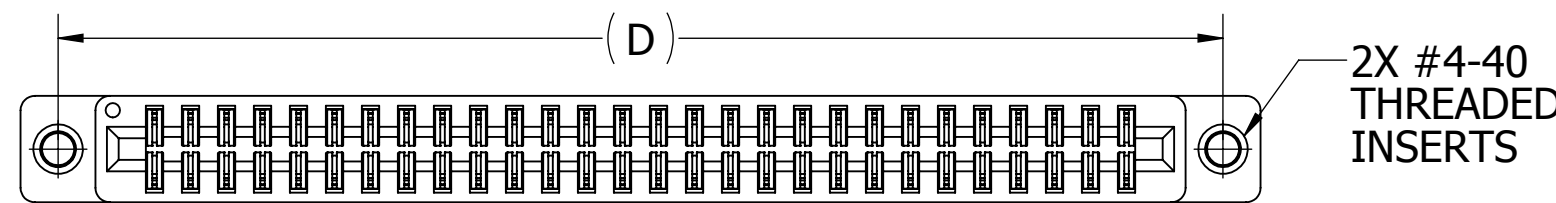

**A** **DRSX-S**  
**A** **DRMX-S**

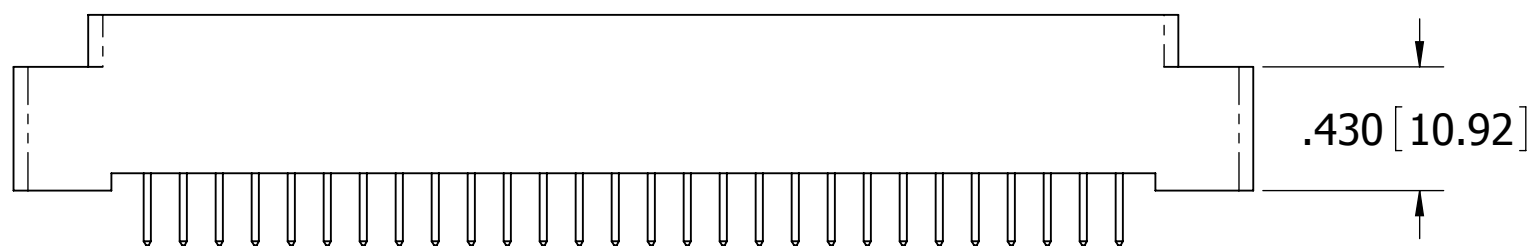
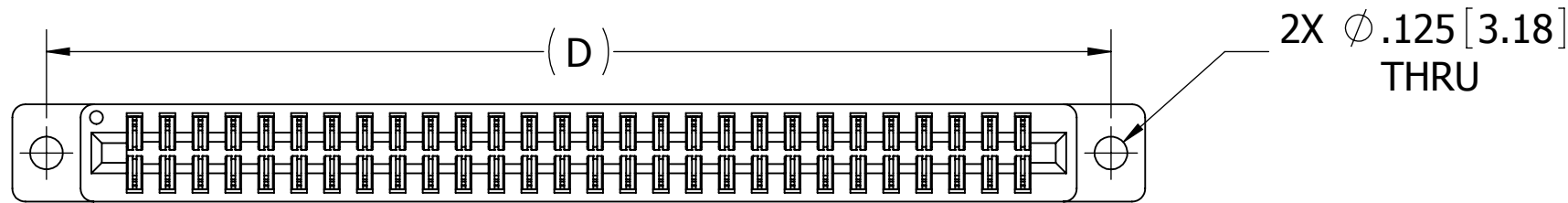

**A** **DRSW-S**  
**A** **DRMW-S**

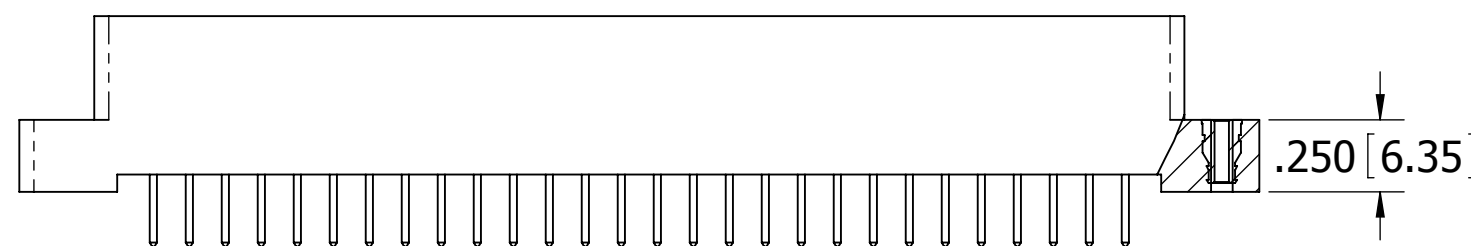
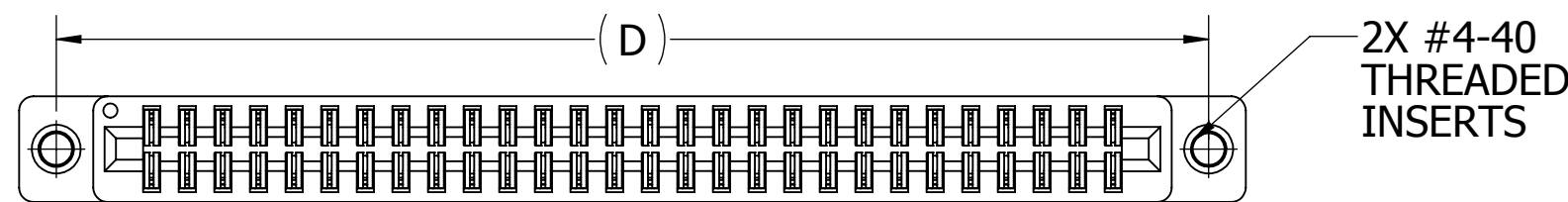

**A** **DRST-S**  
**A** **DRMT-S**

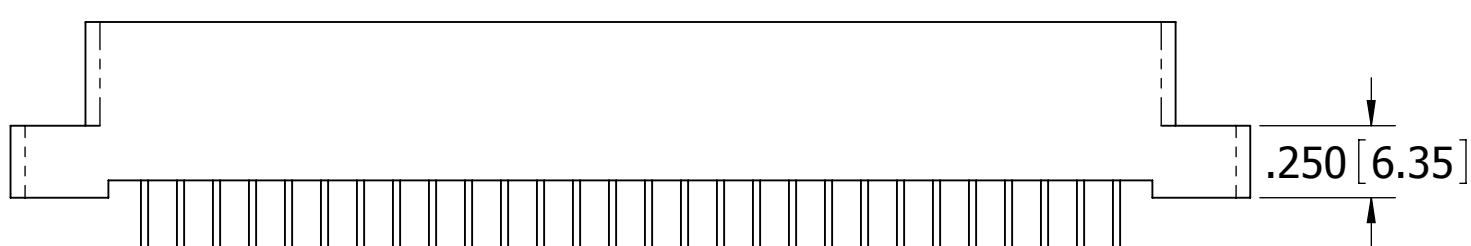
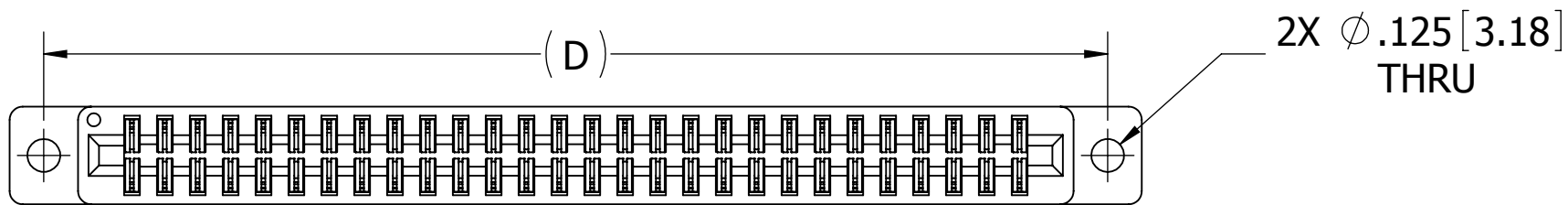

**A** **DRSD-S**  
**A** **DRMD-S**

# CUSTOMER COPY

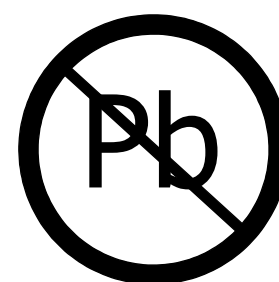

RoHS COMPLIANT

UNLESS OTHERWISE SPECIFIED:  
DIMENSIONS ARE IN INCHES [MM]

TOLERANCES:

ANGULAR: ± 1°

DECIMALS

.XX = ± .02 [.5]

.XXX = ± .005 [.13]

.XXXX = ± .0005 [.013]

DRAWN DATE NAME

6/24/2011 JH

THE INFORMATION HEREIN CONTAINS  
PROPRIETARY INFORMATION OF  
SULLINS ELECTRONICS AND IS NOT  
TO BE REPRODUCED, USED OR  
DISCLOSED TO OTHERS FOR ANY  
PURPOSE EXCEPT AS SPECIFICALLY  
AUTHORIZED IN WRITING BY AN  
OFFICER OF SULLINS ELECTRONICS.

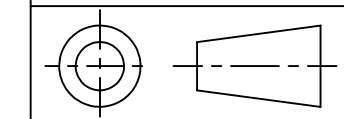

TITLE **EDGECARD .125" PITCH, HP**

PART NUMBER **A\_DRS (DRM)\_(-S38, S81, S328)**

SIZE CAGE CODE DWG. NO. REV

C 54453 C11651 B

SCALE: 1.5:1 SHEET 2 OF 3

PART NUMBER	A±.008[0.20]		B±.008[0.20]		C±.015[0.38]		D±.010[0.25]		E±.020[0.51]		F±.015[0.38]	
	INCH	MM	INCH	MM	INCH	MM	INCH	MM	INCH	MM	INCH	MM
A06DR -S	0.625	15.88	0.875	22.23	1.035	26.29	1.295	32.89	1.555	39.50	0.875	22.23
A10DR -S	1.125	28.58	1.375	34.93	1.535	38.99	1.795	45.59	2.055	52.20	1.375	34.93
A14DR -S	1.625	41.28	1.875	47.63	2.035	51.69	2.295	58.29	2.555	64.90	1.875	47.63
A15DR -S	1.750	44.45	2.000	50.80	2.160	54.86	2.420	61.47	2.680	68.07	2.000	50.80
A18DR -S	2.125	53.98	2.375	60.33	2.535	64.39	2.795	70.99	3.055	77.60	2.375	60.33
A22DR -S	2.625	66.68	2.875	73.03	3.035	77.09	3.295	83.69	3.555	90.30	2.875	73.03
A24DR -S	2.875	73.03	3.125	79.38	3.285	83.44	3.545	90.04	3.805	96.65	3.125	79.38
A25DR -S	3.000	76.20	3.250	82.55	3.410	86.61	3.670	93.22	3.930	99.82	3.250	82.55
A28DR -S	3.375	85.73	3.625	92.08	3.785	96.14	4.045	102.74	4.305	109.35	3.625	92.08
A30DR -S	3.625	92.08	3.875	98.43	4.035	102.49	4.295	109.09	4.555	115.70	3.875	98.43
A31DR -S	3.750	95.25	4.000	101.60	4.160	105.66	4.420	112.27	4.680	118.87	4.000	101.60
A32DR -S	3.875	98.43	4.125	104.78	4.285	108.84	4.545	115.44	4.805	122.05	4.125	104.78
A35DR -S	4.250	107.95	4.500	114.30	4.660	118.36	4.920	124.97	5.180	131.57	4.500	114.30
A36DR -S	4.375	111.13	4.625	117.48	4.785	121.54	5.045	128.14	5.305	134.75	4.625	117.48
A40DR -S	4.875	123.83	5.125	130.18	5.285	134.24	5.545	140.84	5.805	147.45	5.125	130.18
A43DR -S	5.250	133.35	5.500	139.70	5.660	143.76	5.920	150.37	6.180	156.97	5.500	139.70
A44DR -S	5.375	136.53	5.625	142.88	5.785	146.94	6.045	153.54	6.305	160.15	5.625	142.88
A49DR -S	6.000	152.40	6.250	158.75	6.410	162.81	6.670	169.42	6.930	176.02	6.250	158.75
A50DR -S	6.125	155.58	6.375	161.93	6.535	165.99	6.795	172.59	7.055	179.20	6.375	161.93

**PART NUMBER CODING**

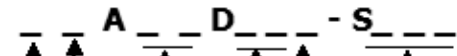

**MATERIALS (INSULATOR / CONTACT)**

- E = PBT/PHOSPHOR BRONZE**  
OPERATING TEMP: -65°C TO +125°C  
PROCESSING TEMP: WAVE/MANUAL SOLDERING ONLY
- R = PPS/PHOSPHOR BRONZE**  
OPERATING TEMP: -65°C TO +125°C  
PROCESSING TEMP: 260°C MAX FOR 20 SECS
- G = PA9T/PHOSPHOR BRONZE**  
OPERATING TEMP: -65°C TO +125°C  
PROCESSING TEMP: 260°C MAX FOR 20 SECS
- A = PPS/BERYLLIUM COPPER**  
OPERATING TEMP: -65°C TO +150°C  
PROCESSING TEMP: 260°C MAX FOR 20 SECS
- J = PA9T/BERYLLIUM COPPER**  
OPERATING TEMP: -65°C TO +150°C  
PROCESSING TEMP: 260°C MAX FOR 20 SECS
- T = PPS/BERYLLIUM COPPER (SPECIAL, CONSULT FACTORY)**  
OPERATING TEMP: -65°C TO +175°C  
PROCESSING TEMP: 260°C MAX FOR 20 SECS  
(CONSULT FACTORY FOR OTHER MATERIALS)

**MODIFICATION CODE**

- OMIT FOR STANDARD, EX: EBA22DRSN
- S38 = BLACK PBT (MATERIAL CODE 'E' ONLY)
- S81 = GREEN PBT (MATERIAL CODE 'E' ONLY)
- S328 = BROWN PPS (MATERIAL CODE 'R', 'A' OR, 'T' ONLY)

**MOUNTING STYLE**

- H = .125" DIA. CLEARANCE HOLES
- I = #4-40 THREADED INSERT
- S = .125" DIA. SIDE MOUNTING
- N = NO MOUNTING EARS
- D = .250" EARS, FLUSH MOUNTING
- T = .250" EARS, FLUSH MOUNTING WITH # 4-40 THREADED INSERT
- W = .430" EARS, FLUSH MOUNTING
- X = .430" EARS, FLUSH MOUNTING WITH # 4-40 THREADED INSERT

**TERMINATION TYPE**

- RS = .190" TAIL LENGTH
- RM = .560" TAIL LENGTH

**NUMBER OF POSITIONS (CONTACTS PER ROW)**

**PLATING**

- ALL PLATINGS ARE LEAD FREE AND HAVE .000050" NICKEL UNDERPLATE
- | CONTACT SURFACE                          | TERMINATION              |
|--|--------------------------|
| B = .000010" GOLD                        | .000100" PURE TIN, MATTE |
| C = .000030" GOLD                        | .000100" PURE TIN, MATTE |
| S = .000010" GOLD                        | .000010" GOLD OVERALL    |
| M = .000030" GOLD                        | .000010" GOLD OVERALL    |
| ** E = .000100" PURE TIN, MATTE, OVERALL |                          |
| G = .000010" GOLD                        | .000005" GOLD            |
| Y = .000030" GOLD                        | .000005" GOLD            |
- \*\* OVERALL PURE TIN ONLY AVAILABLE ON MATERIAL CODES E, R AND G

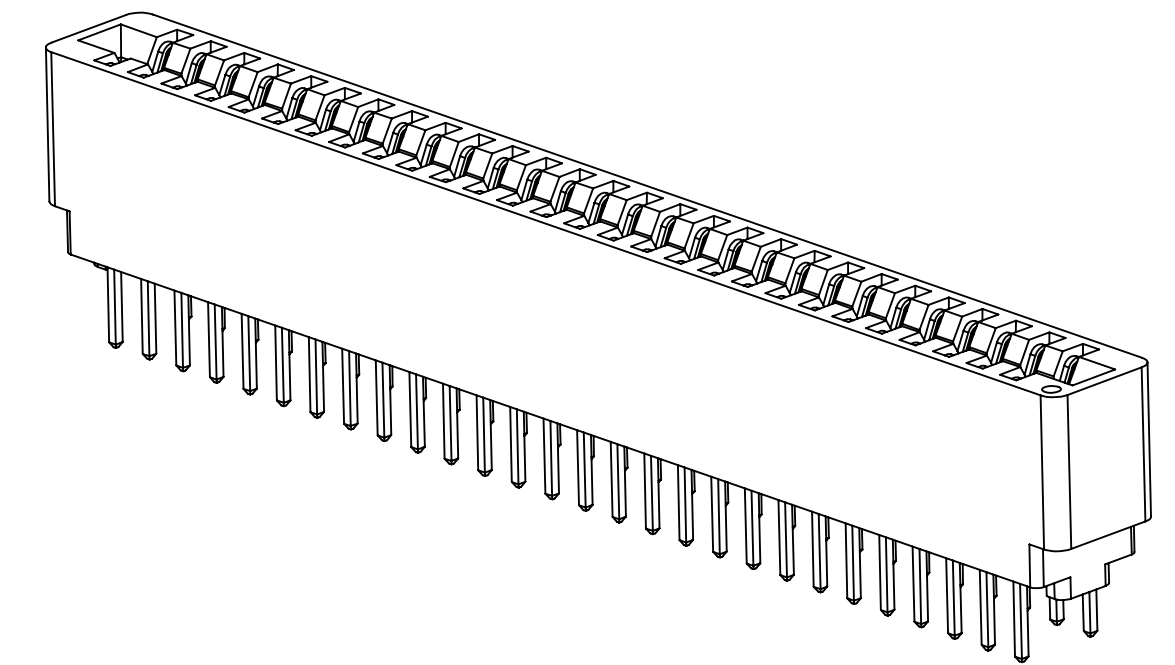

**CUSTOMER COPY**

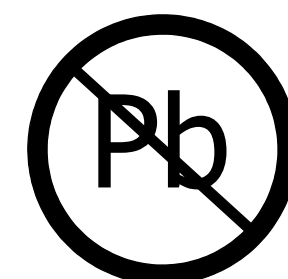

RoHS COMPLIANT

UNLESS OTHERWISE SPECIFIED: DIMENSIONS ARE IN INCHES [MM]		DRAWN	DATE	NAME			
			6/24/2011	JH			
TOLERANCES:					<small>THE INFORMATION HEREIN CONTAINS PROPRIETARY INFORMATION OF SULLINS ELECTRONICS AND IS NOT TO BE REPRODUCED, USED OR DISCLOSED TO OTHERS FOR ANY PURPOSE EXCEPT AS SPECIFICALLY AUTHORIZED IN WRITING BY AN OFFICER OF SULLINS ELECTRONICS.</small>		
ANGULAR: ± 1°					TITLE		
DECIMALS					EDGE CARD .125" PITCH, HP		
.XX = ± .02 [.5]					PART NUMBER		
.XXX = ± .005 [.13]					_A_DRS (DRM)_ (-S38, S81, S328)		
.XXXX = ± .0005 [.013]					SIZE	CAGE CODE	DWG. NO.
					C	54453	C11651
					SCALE: 2:1	SHEET 3 OF 3	
					REV	B	