

NXP WIRELESS POWER SOLUTIONS

MAY – 2017

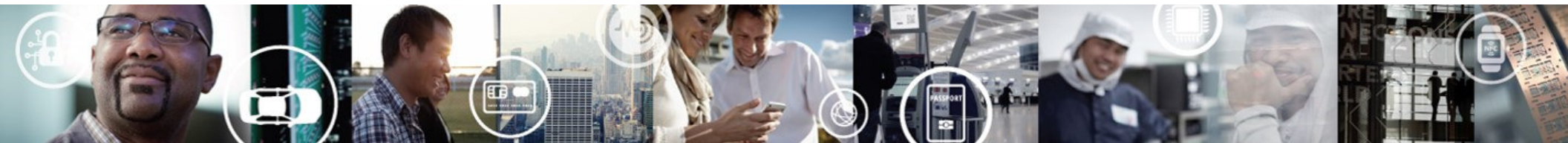

EXTERNAL USE







SECURE CONNECTIONS
FOR A SMARTER WORLD

Wireless Power Transfer



Wireless Power Standards

	Standard	Technology	Characteristics
Compatible HW base	Qi (WPC) 	<ul style="list-style-type: none"> - Inductive coupling - 80 – 200kHz - 2 – 2000W 	<ul style="list-style-type: none"> - Dominant market share - low power – up to 15W - high power – up to 200W - kitchen – up to 2000W - resonant – free positioning
	Apple 	<ul style="list-style-type: none"> - Inductive coupling - 100 – 200kHz - 2W 	<ul style="list-style-type: none"> - Apple Watch - Qi subset frequency range
	PMA 	<ul style="list-style-type: none"> - Inductive coupling - 105 – 400kHz - 2 – 15W 	<ul style="list-style-type: none"> - Qi subset frequency range
	A4WP 	<ul style="list-style-type: none"> - Inductive resonant coupling - 6.78MHz - 2 – 50W 	<ul style="list-style-type: none"> - No released products (May '16) - Intel, pulled out (May '16)

} *

2 EXTERNAL USE ^{*} Merged to the AirFuel Alliance, but two incompatible technology lines (kHz vs. MHz band)



WPC Qi Everywhere

Mobiles	Cars	Consumer
Samsung, Google, LG, Sony, HTC, Motorola, Microsoft, Nokia, ...	Toyota, Ford, Audi, VW, Skoda, Honda, Hyundai, BMW, Mercedes-Benz, ...	Dell, Ikea, Philips, Panasonic, McDonalds, AirCharge, PowerSquare, ...
		 

NXP Wireless Power Products on the Market



Automotive	
AUDI	Q7, A4
HONDA	Accord, Civic, CRV
BMW	5 Series, 7 Series
KIA	K5 JK, Sportage, K7
VW	Tiguan
HYUNDAI	Avante, Ecqus
SEAT	Ateca
SKODA	Superb, Octavia

Consumer	
LG	G3 Phone Tx
Philips	S8860 Tx
PowerSquare	Tango Dual Tx
Belkin	BOOST↑UP™ Tx



Customer Challenges

Time to market is key factor to success (big boom of Wireless Charging)

- New technology
- Know-how
- Standards compliance
- Certification

NXP Wireless Power Solutions perfectly address all this needs!



NXP is Key Contributor in WPC

Founding member of Qi Wireless Power Consortium (WPC)

Co-chair of Specification Working Groups in WPC



NXP Qi Solutions are golden units in WPC specification

NXP Qi Solutions are part of certification interoperability test bed



NXP WIRELESS POWER PORTFOLIO



MI vs. MR

- **Magnetic Induction (MI)**

- Transmitter coil creates a magnetic field, and receiver coil picks up the magnetic field and generates electric current

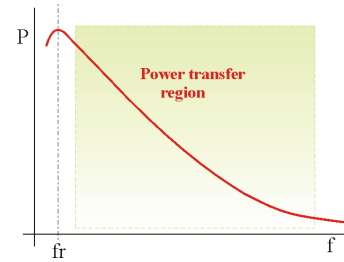
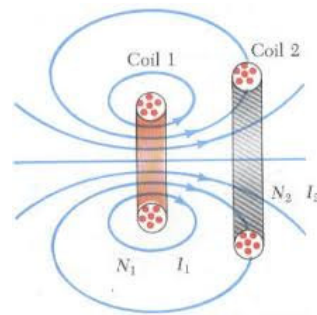

- **Magnetic Resonance (MR)**

- Both transmitter and receiver coils operate at approximately same natural frequencies

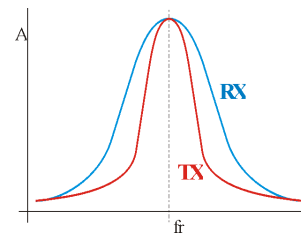
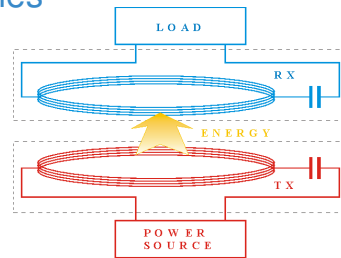

Actually You've Known

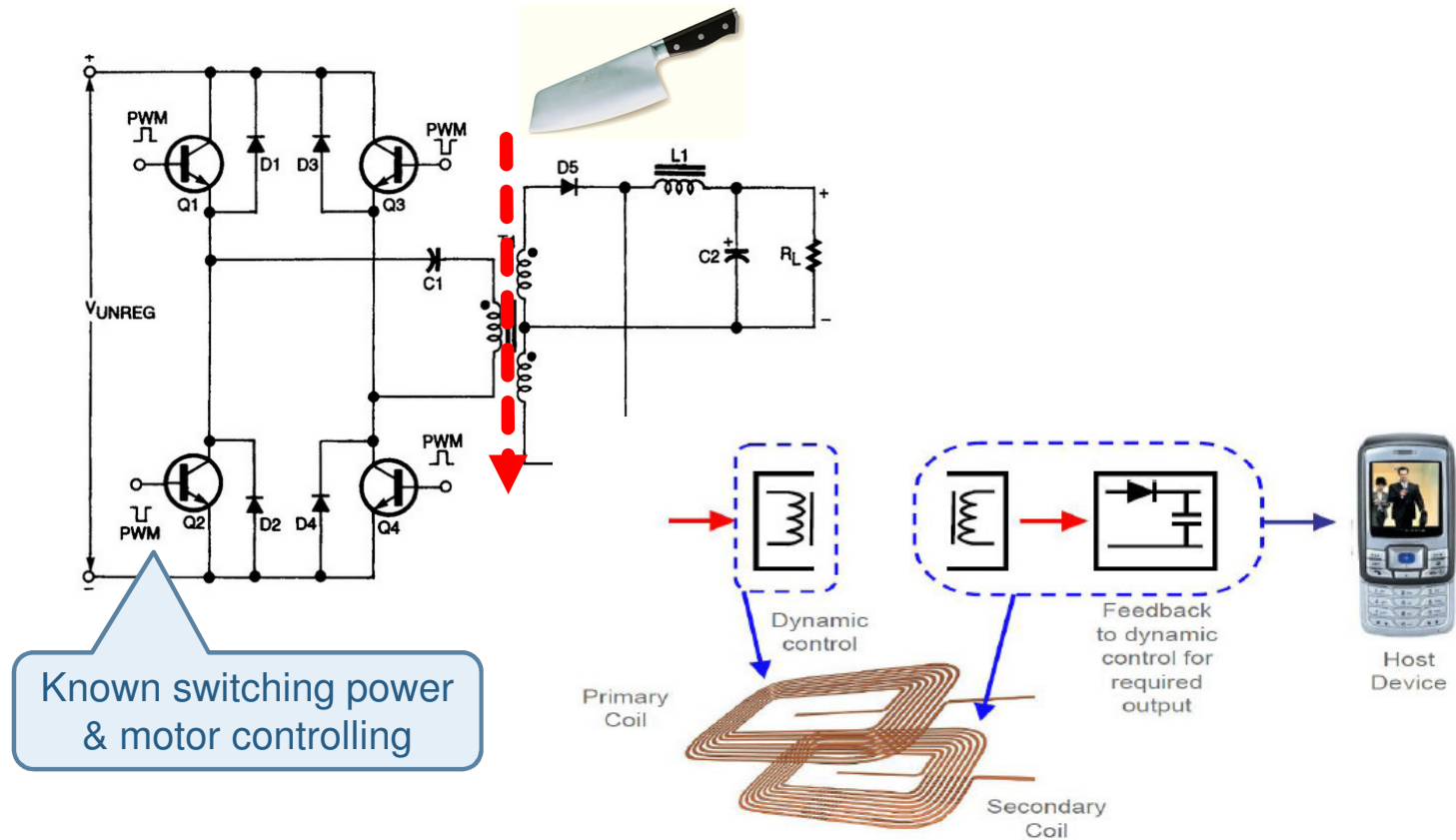

NXP MCU-based Solutions for Advanced Designs

Questions	Feasibility
<ul style="list-style-type: none">➤ <i>Higher cost?</i>➤ <i>Harder to start up?</i>➤ <i>Longer design period?</i>	<ul style="list-style-type: none">➤ <i>Flexibility to use your own favorite parts</i>➤ <i>Turn-key solutions</i>➤ <i>Easier for tuning for certifications</i>➤ <i>Specification update without PCBA change</i>➤ <i>Controllable thermal / EMI performance</i>➤ <i>Function extensible</i><ul style="list-style-type: none">• <i>Customized U/I</i>• <i>Higher watts provided</i>• <i>etc..</i>

Wireless Power Solutions Platform

HW

- Reference design
- Optimized BOM

SW

- Professional Grade Qi certified library
- Customizable application / clean API

Support

- Application Expertise
- On-site support up to production

Certification

- WPC consortium co-chair
- Only available  1.2.3 certified solution

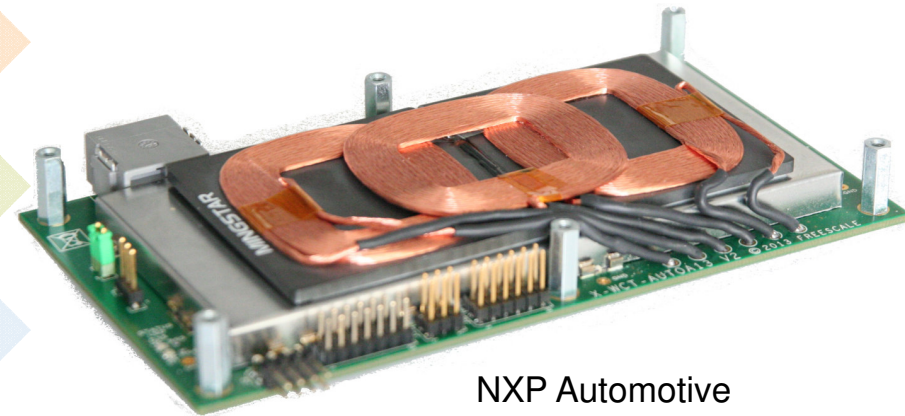

NXP Automotive
Wireless Charging Tx
Solutions Platform

Customers Benefits:

- Reduced Time to Market
- Reduced Risk
- Reduced Development Cost

Application Flexibility

- Custom FOD
- Additional application
- Qi disablement/enablement
- PMA disablement/enablement
- System/user interfaces definition
- Proprietary devices enablement
- Proprietary monitoring/protections
- Proprietary messages between Tx and Rx



Software Structure

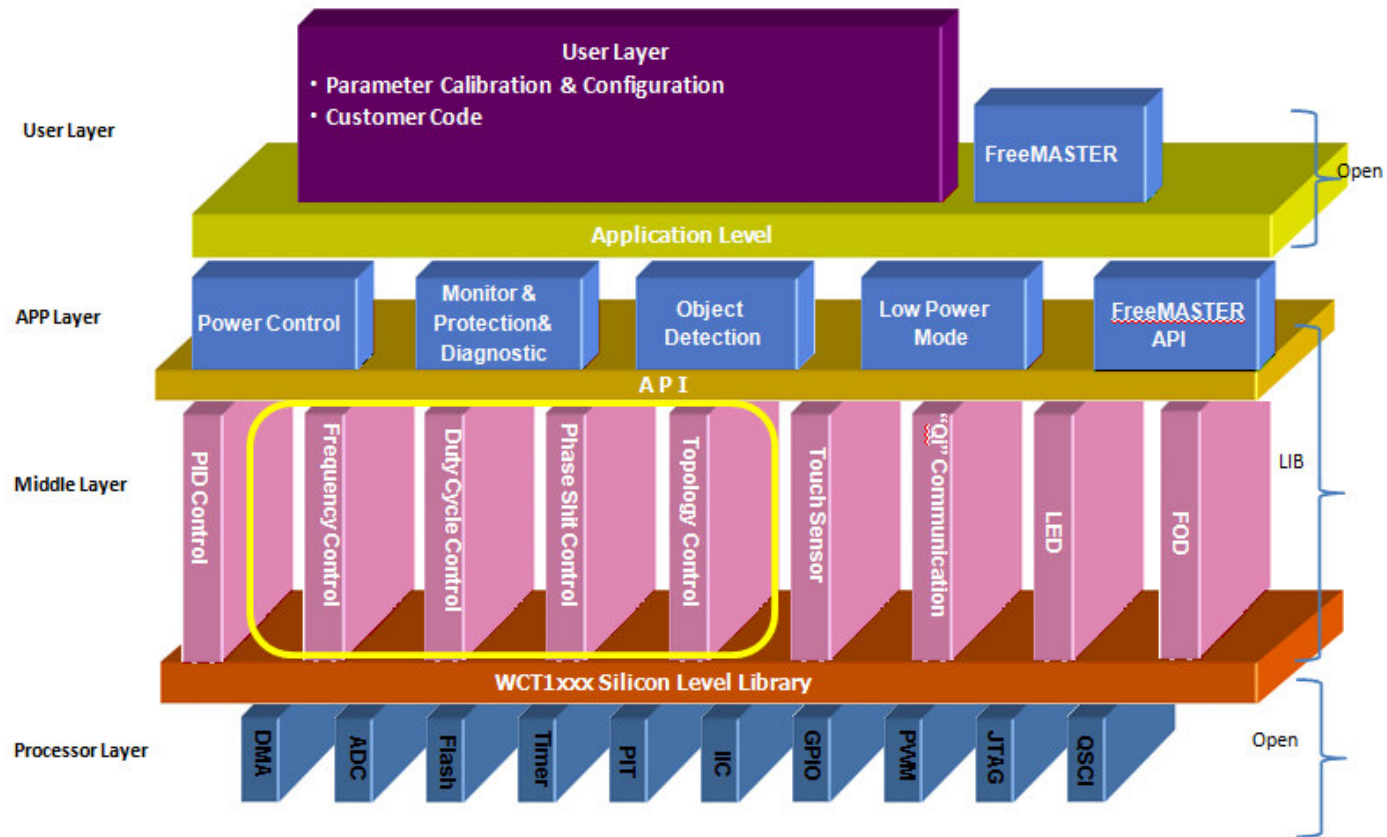

Development Tools

CodeWarrior

- Eclipse based IDE



FreeMASTER

- Monitoring
- Tuning
- Calibration
- Debugging

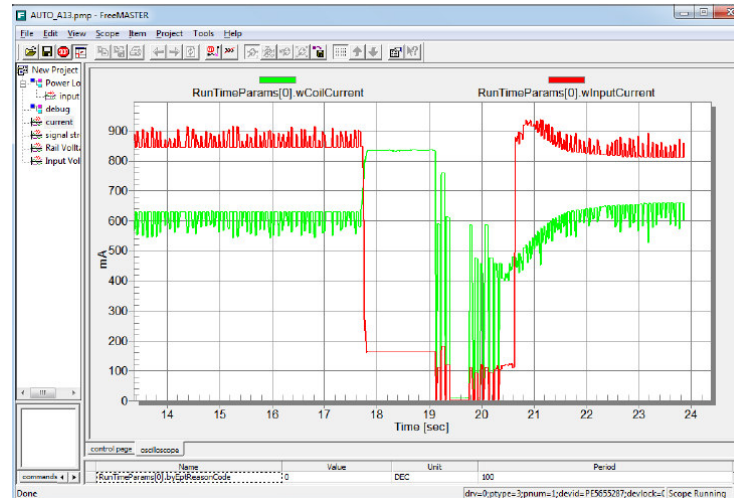

FreeMASTER for Wireless Charging

• Real-time Design Analysis

- Data Visualization
- Data real-time acquiring
- UART / JTAG / CAN

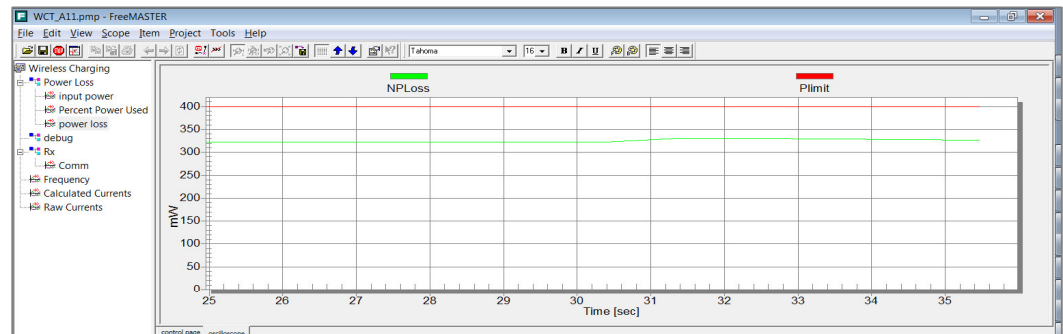

WCT GUI for Low Power 5W, 1 coil

Calibration

- 1) Set Device ID: 0
- 2) Set the calibration constant to default before calibration: **Reset** ✓
- 3) Enter to debug mode: **Enter** ✓
- 4) Read Voltage by processor **Read** ✓ 5221 mV
- 5) Measure Voltage by multimeter 5000 mV
- 6) Move Calibration Constant 31381 to NVM: **Move** ✓

Input Voltage Calibration

Read In I, Rail U: 0 In U? mV, In I ? mA, Coil I ? mA
In P? mW, Tx loss? mW, Out P? mW

Coil Frequency: 0 Coil Frequency of desired Coil ID: 140000 Hz

Coil Discharge: On Off 0 Enables or disables Coil Discharge.

Coil Duty Cycle: 0 Coil Duty Cycle of desired Coil ID: 50 %

Name	Value	Unit	Period
wMeasuredCoilCurrent	862	mA	300
wMeasuredInputVoltage	4976	mV	300
dwMeasuredInputCurrent	82	mA	300
ms.PowerLossParams[0].FodCharacterizationParams[0].swConstantCoefficient	133	DEC	300
ms.PowerLossParams[0].FodCharacterizationParams[0].swPowerLossCalibrationOffset	416	mW	600
dwCalculatedInputPower	330	mW	300
swTxInternalLoss	86	mW	500
	330	mW	300
	0	mW	300
	330	mW	200
	0	DEC	200
	326	mW	400
dwDeviceControlFlags	460	mW	200
byPercentPowerUsed	0x65	HEX	600
	0	DEC	100
	5	V	300
byPowerLossFaultCount	0	DEC	400
	25	DEC	500
ms.PowerLossParams[0].FodNormalizationParams[0].QuadraticParams[0].swQuadC	4	DEC	1000
ms.PowerLossParams[0].FodNormalizationParams[0].QuadraticParams[0].swQuadExp	0	DEC	1000

• Debugging & Tuning

- Parameter tuning
 - System parameters
 - Coil parameters
 - Calibration ex. FOD boundary
- Result written to Flash
- Configuration file creating



Configuration in FreeMASTER

The screenshot shows the FreeMASTER configuration window for a WCT GUI. The 'System Params' tab is selected, displaying the following configuration options:

Parameter	Value	High	Low	Description
Common for all	Read/Write			
LED configuration				
Led 1 On/Off	241	<input type="checkbox"/>	<input checked="" type="checkbox"/>	
Led 1 Blinking	49156	<input checked="" type="checkbox"/>	<input checked="" type="checkbox"/>	
Led 2 On/Off	13	<input type="checkbox"/>	<input checked="" type="checkbox"/>	
Led 2 Blinking	258	<input type="checkbox"/>	<input checked="" type="checkbox"/>	
Fault Blink Rate (ms)	200			This parameter represents the period of time used to establish a blink rate for any LED in a SYSTEM FAULT or DEVICE FAULT condition. Value 0 to 65535.
FOD Fault Blink Rate (ms)	200			This parameter represents the period of time used to establish a blink rate for any LED in a FOD FAULT condition. Value 0 to 65535.
Operational State Blink Rate (ms)	1000			This parameter represents the period of time used to establish a blink rate for any LED when the system is in a non-fault state. Value 0 to 65535.
Delay At Power-Up (ms)	1000			This parameter can be used to /hold/ the state of the LED(s) following initial power-up of the system. Value 0 to 65535.
PWM deadtime configuration				
Default DWM Dead				

A callout box on the right side of the window contains the text: "Define system & coil parameters".



Tuning in FreeMASTER

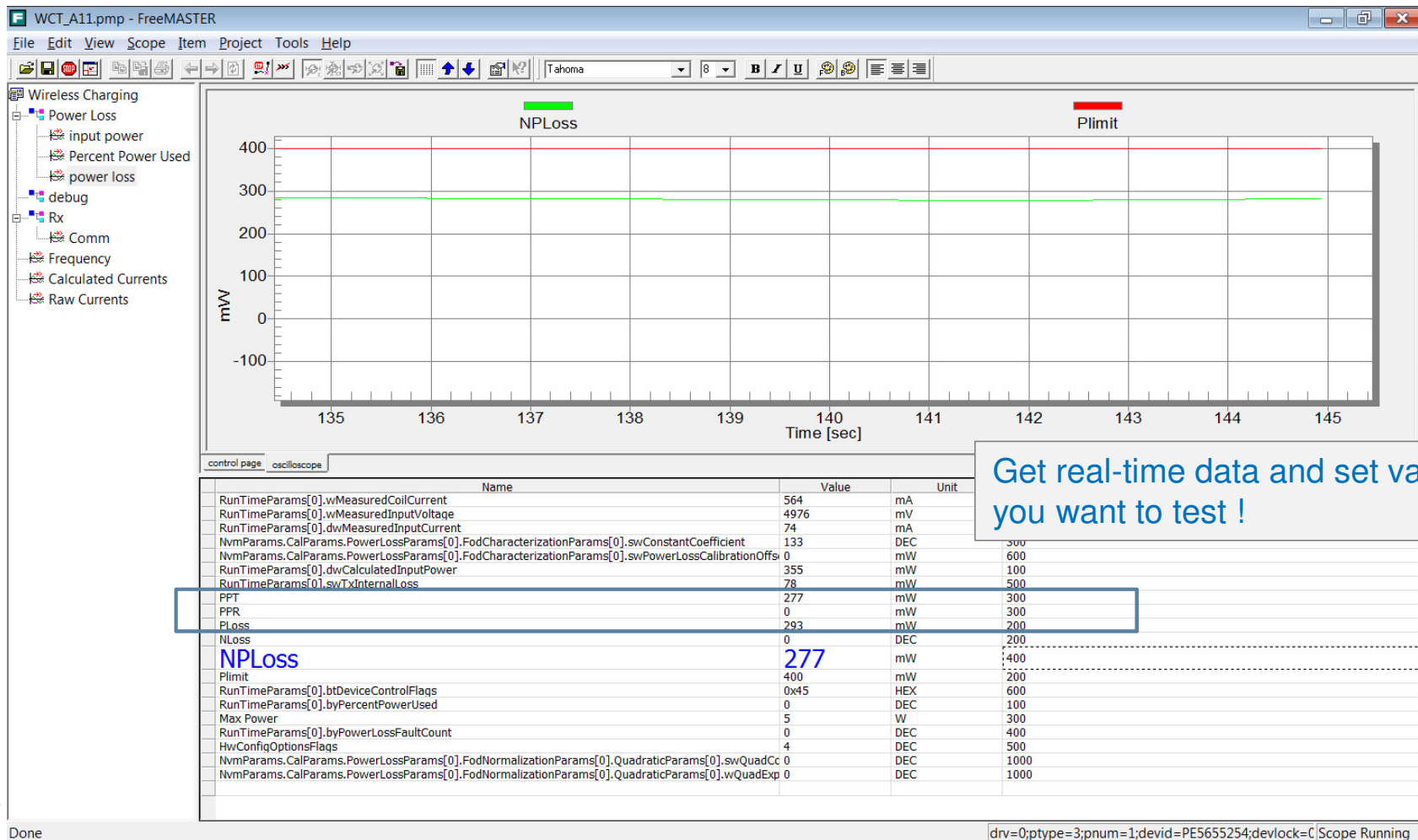

Calibration in FreeMASTER

Input Voltage Calibration

- 1) Set Device ID:
- 2) Set the calibration constant to default before calibration: ✓
- 3) Enter to debug mode: ✓
- 4) Read Voltage by processor ✓ mV
- 5) Measure Voltage by multimeter mV
- 6) Move Calibration Constant to NVM: ✓
- 7) Save final calibration constant to FLASH: ✓
- 8) Disconnect FreeMASTER and reset CPU

Input Current Calibration

- 1) Set device ID:
- 2) Set the calibration constant to default before calibration:
- 3) Enter to debug mode:
- 4) Measure the input current for different loads

	uProc I	Real I
<input type="button" value="Read"/>	<input type="text" value="50"/> mA	<input type="text" value="50"/> mA
<input type="button" value="Read"/>	<input type="text" value="100"/> mA	<input type="text" value="100"/> mA
<input type="button" value="Read"/>	<input type="text" value="180"/> mA	<input type="text" value="180"/> mA
<input type="button" value="Read"/>	<input type="text" value="320"/> mA	<input type="text" value="320"/> mA
<input type="button" value="Read"/>	<input type="text" value="500"/> mA	<input type="text" value="500"/> mA
<input type="button" value="Read"/>	<input type="text" value="700"/> mA	<input type="text" value="700"/> mA
<input type="button" value="Read"/>	<input type="text" value="1000"/> mA	<input type="text" value="1000"/> mA

Measured Input Current [mA]

uProc Input Current [mA]

control page oscilloscope

drv=0;ptype=3;pnum=1;devid=PE5655254;devlock=C Scope Running

Just follow the steps to finish calibration !









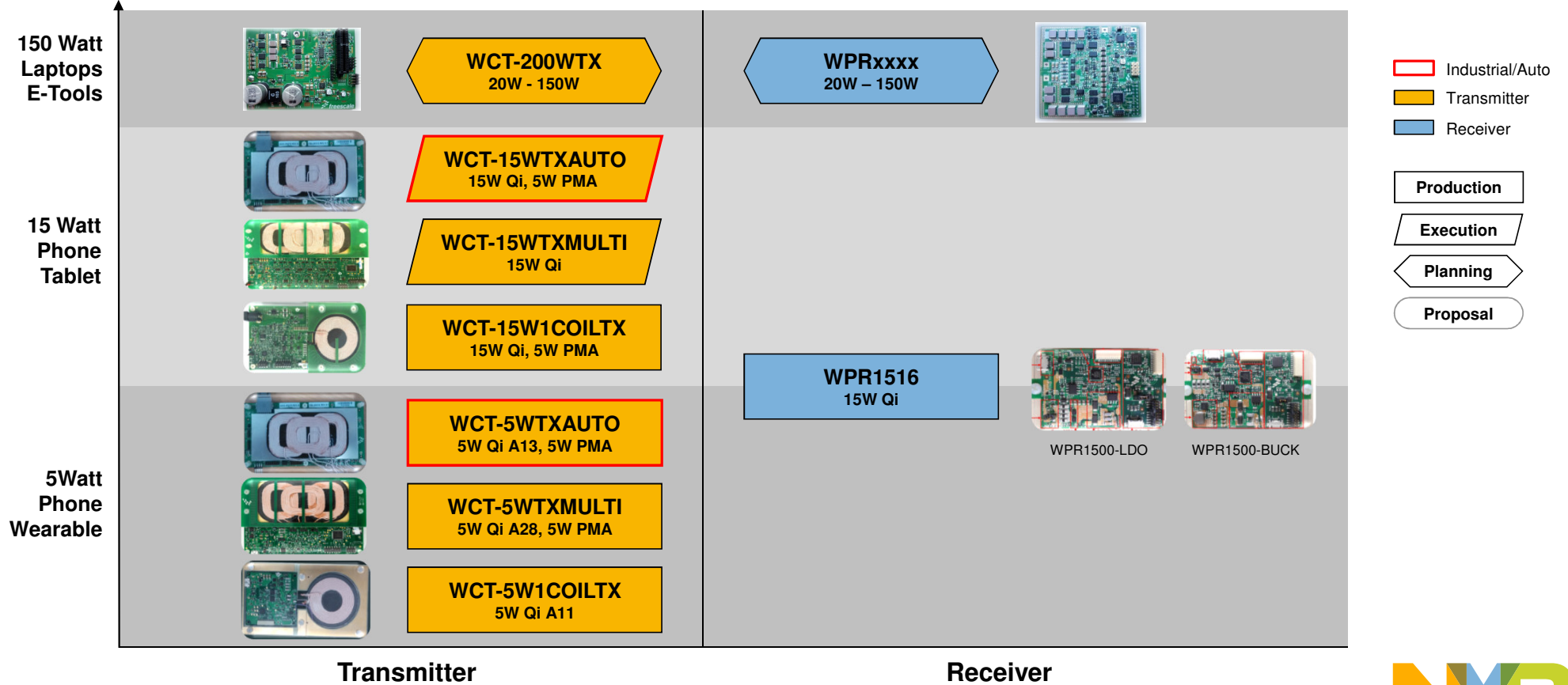

NXP WIRELESS POWER PORTFOLIO



NXP Wireless Power Solutions Portfolio

Power / Applications



-  Industrial/Auto
-  Transmitter
-  Receiver
-  Production
-  Execution
-  Planning
-  Proposal

Transmitter

Receiver



NXP BASE POWER SOLUTIONS



A11 5W Single Coil Transmitter

- **Target Applications:**

- Wearable Charger, Mobile Charger

- **Features:**

- Compliant with WPC low power specifications
- On chip digital demodulation
- Resonance Shift and Power Loss FOD methods
- Dynamic input power limit
- Power transfer efficiency exceeds 75%
- <http://www.nxp.com/products/power-management/wireless-charging-ics/wct-5w1coiltx-single-coil-wireless-charger-reference-design:RDWCT-5W1COILTX>



- **Availability & Certification:**

- Available for demo and evaluation now!
- Got WPC Qi certification with WCT1000CFM

A28 5W 3 Coil Transmitter

- **Target Applications:**

- Wearable Charger, Mobile Charger, Free positioning

- **Features:**

- Compliant with WPC low power specifications
- On chip digital demodulation
- Resonance Shift and Power Loss FOD methods
- Dynamic input power limit
- Power transfer efficiency exceeds 70%
- PMA v1.0 specifications
- NXP IP in WPC specifications
- <http://www.nxp.com/products/power-management/wireless-charging-ics/5w-multi-coil-a-type-wireless-charging-transmitter-reference-design:RDWCT-5WTXMULTI>

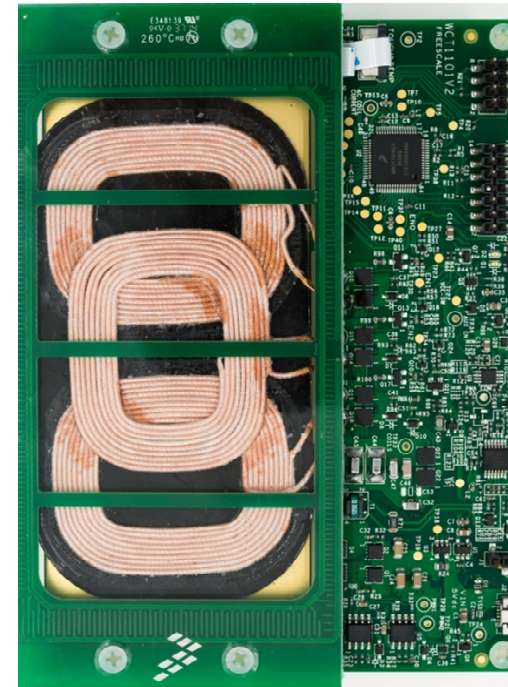

- **Availability & Certification:**

- Available for demo and evaluation now!
- Got WPC Qi certification with WCT1101CLH

A13 5W 3 Coil Automotive Transmitter

- **Target Applications:**

- Automotive, Wearable Charger, Mobile Charger, Free positioning

- **Features:**

- Compliant with WPC low power specifications
- On chip digital demodulation
- CAN, NFC interfaces
- Fixed frequency PWM control (better EMC)
- Resonance Shift and Power Loss FOD methods
- Key FOB and AM band avoidance
- PMA v1.0 specifications
- AEC-Q100 grade 2 certification
- <http://www.nxp.com/products/power-management/wireless-charging-ics/wct-5wtxauto-multi-coil-wireless-charging-transmitter-reference-platform-for-automotive-applications:RDWCT-5WTXAUTO>

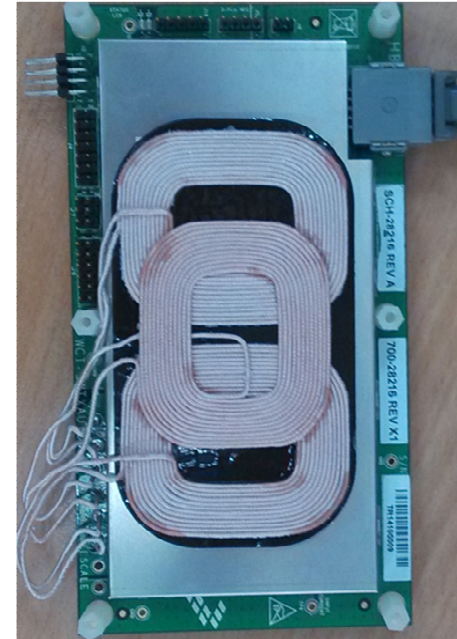

- **Availability & Certification:**

- Available for demo and evaluation now!
- Got WPC Qi certification with WCT1001AVLH

KeyFob Avoidance in A13

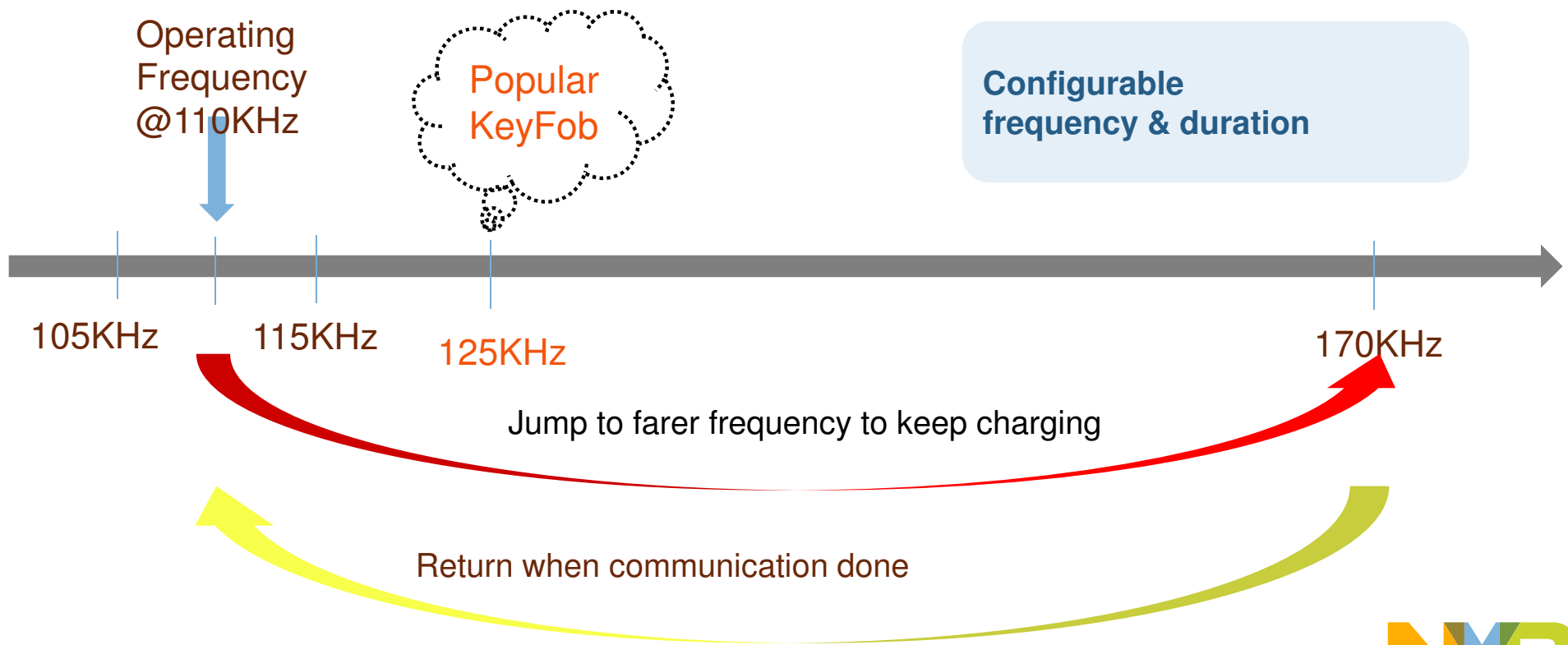

NXP EXTENDED POWER SOLUTIONS



15W Single Coil Transmitter

- **Target Applications:**

- Fast Mobile Charger, Tablet Charger

- **Features and Enablement:**

- Compliant with WPC-Qi medium power specifications
- On-chip digital demodulation
- Back compliant with WPC low power specifications
- More than 75% transfer efficiency
- Q-Factor and Power Loss FOD methods
- Ultra-low bill-of-materials (BOM) cost
- <http://www.nxp.com/products/power-management/wireless-charging-ics/wct-15w1coiltx-15-watt-single-coil-wireless-charging-transmitter-reference-platform:RDWCT-15W1COILTX>



- **Availability & Certification:**

- Available for demo and evaluation now!
- Qi Certification on-going

15W Multi Coil Transmitter

- **Target Applications:**

- Fast Mobile Charger, Tablet Charger, Free positioning

- **Features and Enablement:**

- Compliant with WPC-Qi medium power specifications
- On-chip digital demodulation
- Back compliant with WPC low power specifications
- 1st WPC free positioning multiple coils medium power transmitter solution using frequency control, duty cycle control, phase shift control, and topology switch
- Q-Factor and Power Loss FOD methods

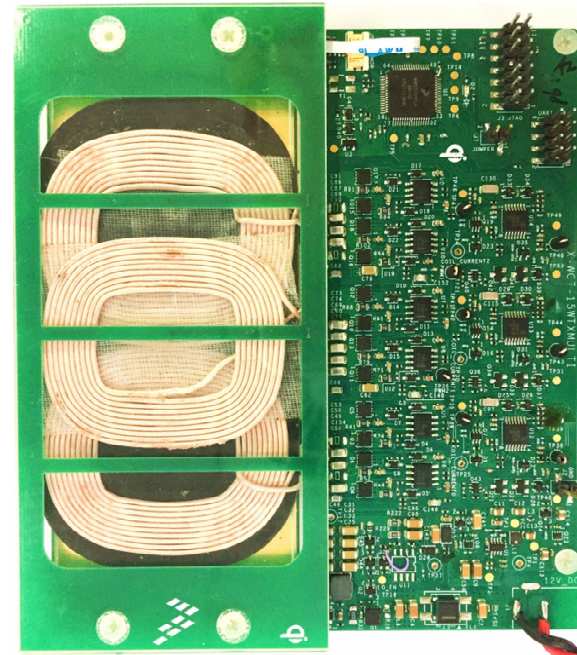

- **Availability & Certification:**

- Q2'16
- Qi Certification on-going

15W Receiver

- **Target Applications:**

- Tablet Charger, Fast Mobile Charger

- **Features and Enablement:**

- Compliant with latest WPC medium power specifications
- Input power (3.5 V ~ 20 Vac peak) from the transmitter via the receiver coil
- Power transfer efficiency exceed 74%
- Support two-way communication, transmitter to receiver by FSK and receiver to transmitter by ASK
- Hardware protection of rectifier voltage, output voltage and output current
- **Directly support Quick Charge 2.0 & 3.0 (Class A) & Pump Express +**
- PCB size 40 mm × 40 mm
- Selected as WPC golden MP receiver
- <http://www.nxp.com/products/power-management/wireless-charging-ics/wpr1500-buck-15w-wireless-charging-receiver:RDWPR1500-BUCK>

WPR1500-LDO

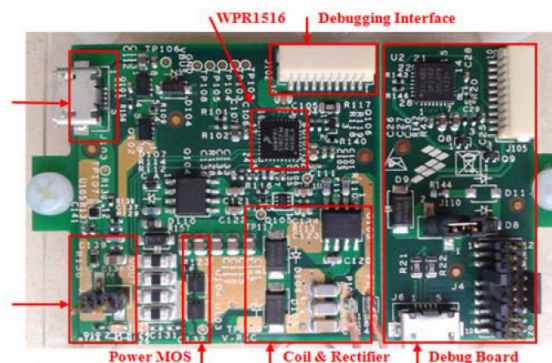

WPR1500-BUCK

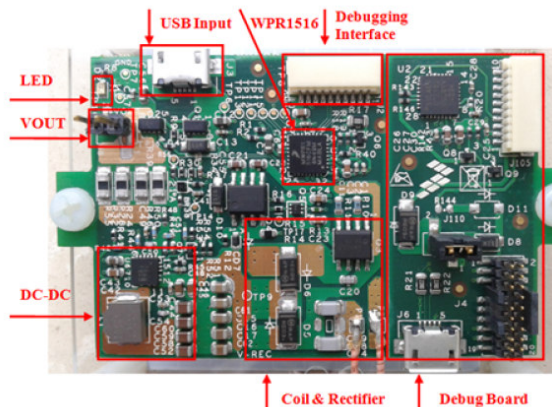

- **Availability & Certification:**

- Available for demo and evaluation now!



15W Multi Coil Automotive Transmitter

- **Target Applications:**

- Automotive, Fast Mobile Charger, Tablets Charger, Free positioning

- **Features and Enablement:**

- Dual mode compliant, WPC-Qi medium power spec and PMA
- On-chip digital demodulation
- Back compliant with WPC low power specifications
- Q-Factor and Power Loss FOD methods
- Key FOB and AM band avoidance
- CAN interface to connect with vehicle network
- NFC enabled, NCF3340

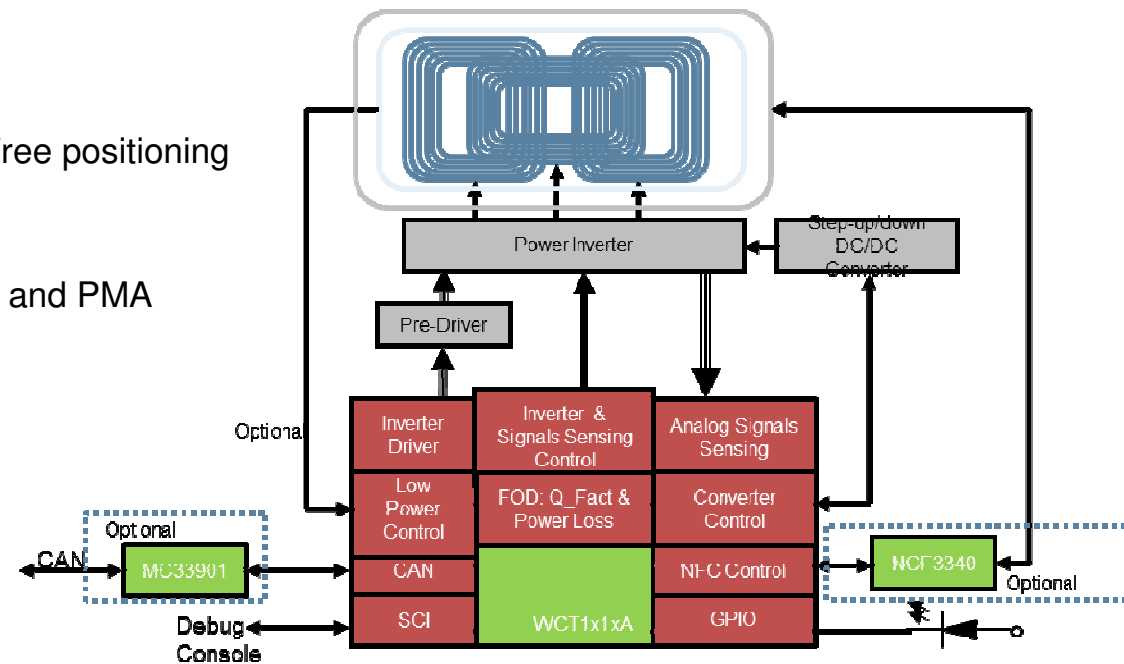

- **Availability & Certification:**

- Q1'17

NXP HIGH POWER SOLUTIONS



20W – 200W Single Coil System (Tx + Rx)

- Developing

- **Target Applications:**

- Laptop Charging, Power Tools Charging, Tablet Charging

- **Features and Enablement:**

- High efficiency >90% (Best eff: 94%/110W)
- Low temperature without any heatsink (up to 42°C)
- Prepared to be compatible with Qi specs for <15W
- Transmitter supply voltage: 24 V DC / 6A;
- Working frequency from 90-110kHz;
- Distance gap between TX and RX – from 5 to 14mm;
- All types of Lithium based batteries;
- Battery capacity up to ~10Ah, 3 to 6-cells in series;

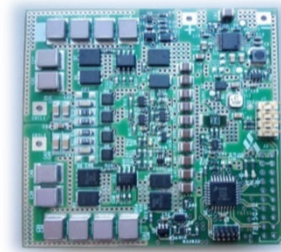
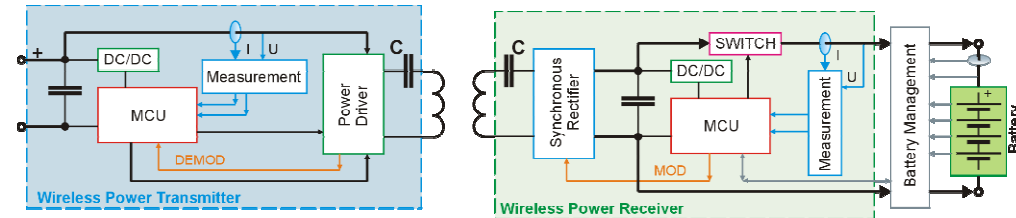
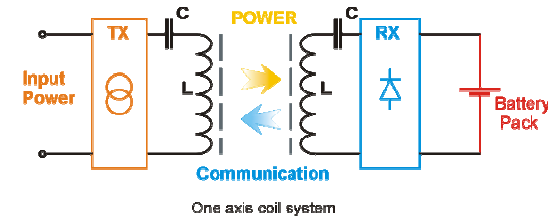

Rx Thermal Operation

30min of **100W** power transfer

Max temperature **42.2 °C**

Placed on rubber plate on table

No heat sink

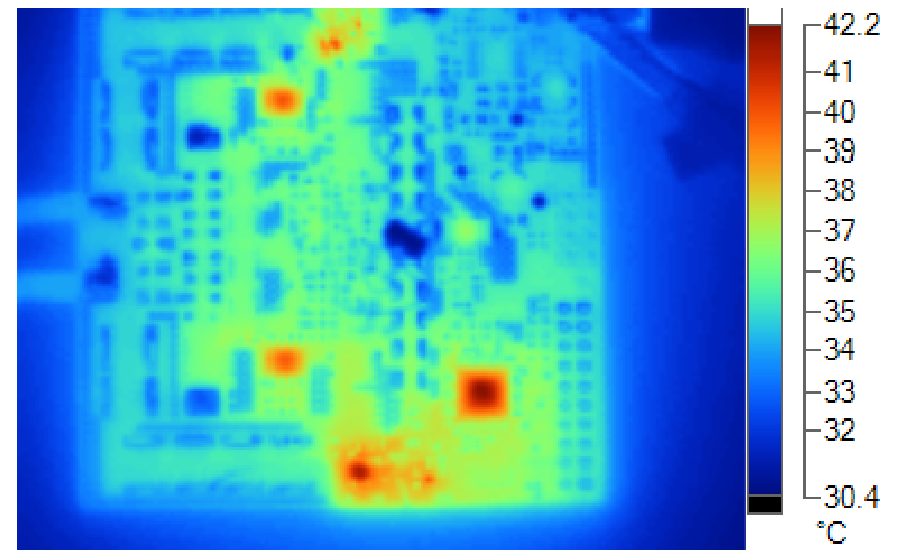



SECURE CONNECTIONS
FOR A SMARTER WORLD