

High Power Infrared Emitter (940 nm) Version 1.4

SFH 4045N



Features:

- High Power Infrared LED
- Short switching time
- small package: (WxDxH) 3 mm x 2.65 mm x 1.2mm
- SMT Sidelooker

Applications

- Interrupters, Lightcurtains
- Sensor technology
- Proximity sensor
- Touchscreen
- Industrial electronics

Notes

Depending on the mode of operation, these devices emit highly concentrated non visible infrared light which can be hazardous to the human eye. Products which incorporate these devices have to follow the safety precautions given in IEC 60825-1 and IEC 62471.

Ordering Information

Type:	Radiant Intensity I_e [mW/sr] $I_F = 70 \text{ mA}, t_p = 20 \text{ ms}$	Ordering Code
SFH 4045N	90 (≥ 40)	Q65111A3903

Note: Measured at a solid angle of $\Omega = 0.01 \text{ sr}$

Maximum Ratings ($T_A = 25\text{ °C}$)

Parameter	Symbol	Values	Unit
Operation and storage temperature range	$T_{op}; T_{stg}$	-40 ... 85	°C
Reverse voltage	V_R	5	V
Forward current	I_F	70	mA
Surge current ($t_p \leq 100\ \mu\text{s}$, $D = 0$)	I_{FSM}	0.7	A
Total power dissipation	P_{tot}	140	mW
ESD withstand voltage (acc. to ANSI/ ESDA/ JEDEC JS-001 - HBM)	V_{ESD}	2	kV
Thermal resistance junction - ambient ^{1) page 12}	R_{thJA}	540	K / W
Thermal resistance junction - soldering point ^{2) page 12}	R_{thJS}	360	K / W

Characteristics ($T_A = 25\text{ °C}$)

Parameter		Symbol	Values	Unit
Peak wavelength ($I_F = 70\text{ mA}$, $t_p = 20\text{ ms}$)	(typ)	λ_{peak}	950	nm
Centroid wavelength ($I_F = 70\text{ mA}$, $t_p = 20\text{ ms}$)	(typ)	$\lambda_{centroid}$	940	nm
Spectral bandwidth at 50% of I_{max} ($I_F = 70\text{ mA}$, $t_p = 10\text{ ms}$)	(typ)	$\Delta\lambda$	42	nm
Half angle	(typ)	φ	± 9	°
Dimensions of active chip area	(typ)	L x W	0.2 x 0.2	mm x mm
Rise and fall time of I_e (10% and 90% of $I_{e\ max}$) ($I_F = 70\text{ mA}$, $R_L = 50\ \Omega$)	(typ)	t_r, t_f	12	ns
Forward voltage ($I_F = 70\text{ mA}$, $t_p = 20\text{ ms}$)	(typ (max))	V_F	1.6 (≤ 2)	V
Forward voltage ($I_F = 700\text{ mA}$, $t_p = 100\ \mu\text{s}$)	(typ (max))	V_F	2.8	V
Reverse current ($V_R = 5\text{ V}$)		I_R	not designed for reverse operation	μA
Total radiant flux ($I_F = 70\text{ mA}$, $t_p = 20\text{ ms}$)	(typ)	Φ_e	40	mW

Parameter		Symbol	Values	Unit
Temperature coefficient of I_e or Φ_e ($I_F = 70$ mA, $t_p = 10$ ms)	(typ)	TC_I	-0.5	% / K
Temperature coefficient of V_F ($I_F = 70$ mA, $t_p = 10$ ms)	(typ)	TC_V	-1.3	mV / K
Temperature coefficient of wavelength ($I_F = 70$ mA, $t_p = 10$ ms)	(typ)	TC_λ	0.3	nm / K

Grouping ($T_A = 25$ °C)

Group	Min Radiant Intensity	Max Radiant Intensity	Typ Radiant Intensity
	$I_F = 70$ mA, $t_p = 20$ ms $I_{e, \min}$ [mW / sr]	$I_F = 70$ mA, $t_p = 20$ ms $I_{e, \max}$ [mW / sr]	$I_F = 700$ mA, $t_p = 25$ μ s $I_{e, \text{typ}}$ [mW / sr]
SFH 4045N-U	40	80	420
SFH 4045N-V	63	125	660
SFH 4045N-AW	100	200	1050

Note: measured at a solid angle of $\Omega = 0.01$ sr

Only one group in one packing unit (variation lower 2:1).

Relative Spectral Emission ^{3) page 12}

$$I_{\text{rel}} = f(\lambda), T_A = 25^\circ\text{C}$$

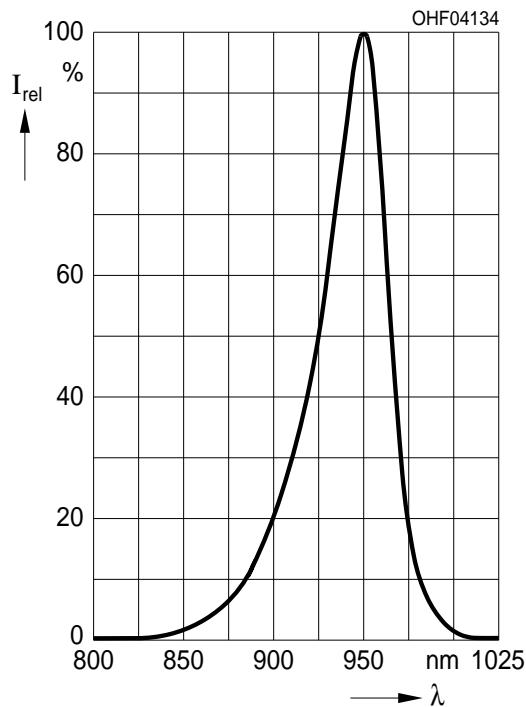

Radiant Intensity ^{3) page 12}

$$I_e / I_e(70 \text{ mA}) = f(I_F), \text{ single pulse, } t_p = 25 \mu\text{s}, T_A = 25^\circ\text{C}$$

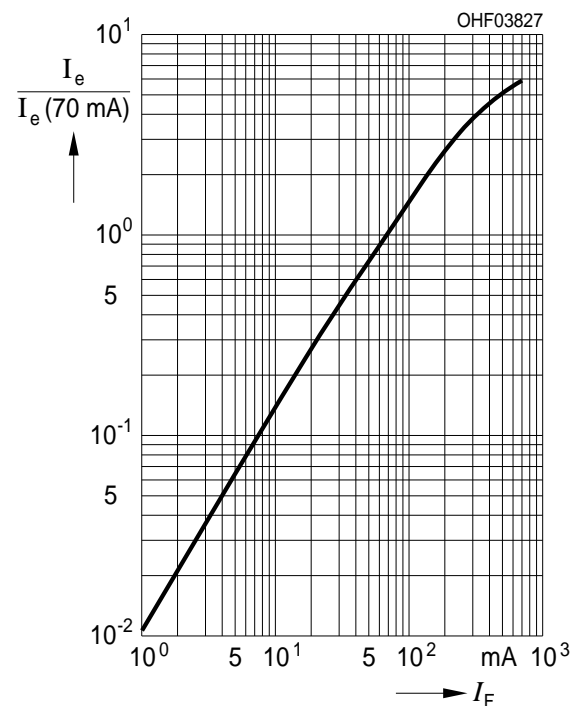

Max. Permissible Forward Current

$I_{F, max} = f(T_A), R_{thJA} = 540 \text{ K/W}$

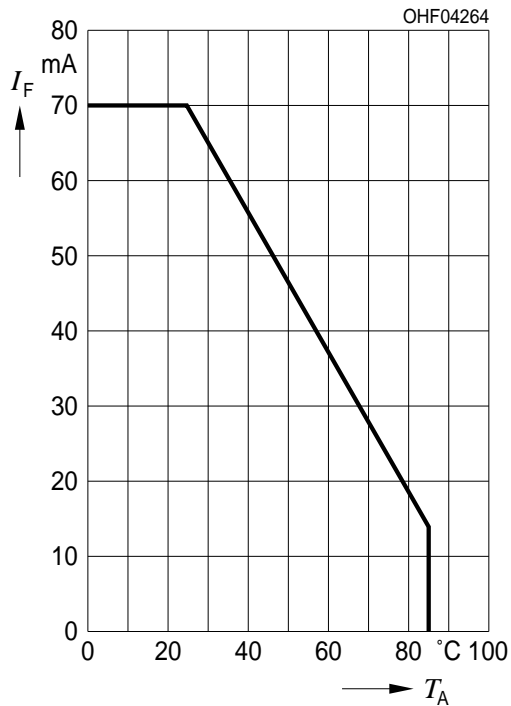

Forward Current ^{3) page 12}

$I_F = f(V_F), \text{ single pulse, } t_p = 100 \mu\text{s}, T_A = 25^\circ\text{C}$

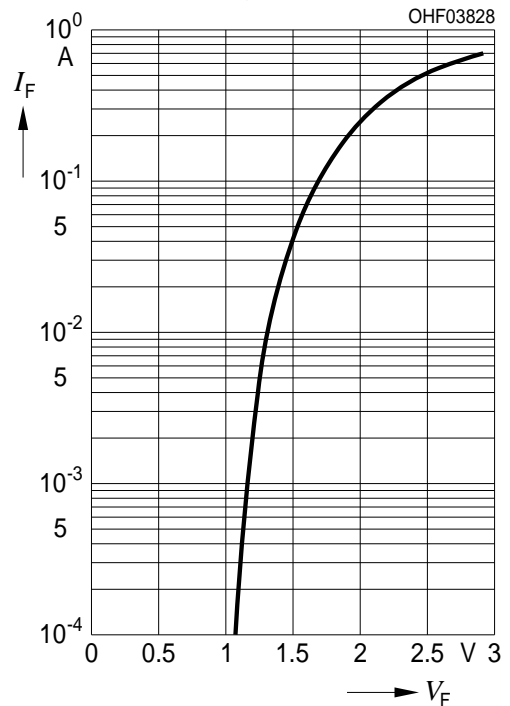

Permissible Pulse Handling Capability

$I_F = f(t_p), T_A = 25^\circ\text{C}, \text{ duty cycle } D = \text{parameter}$

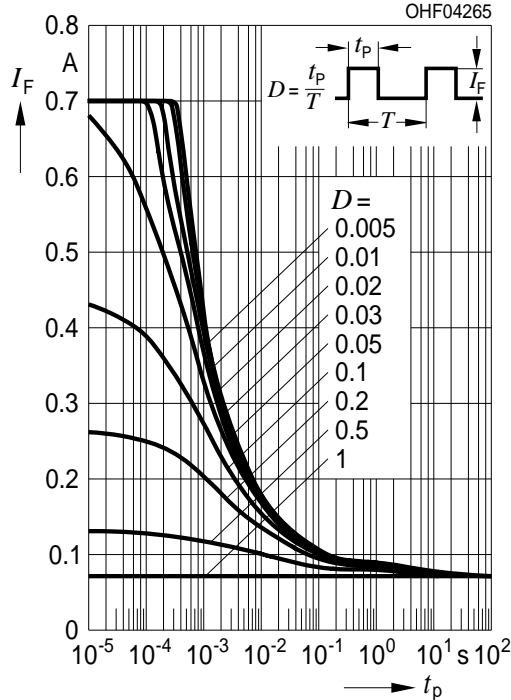

Permissible Pulse Handling Capability

$I_F = f(t_p), T_A = 85^\circ\text{C}, \text{ duty cycle } D = \text{parameter}$

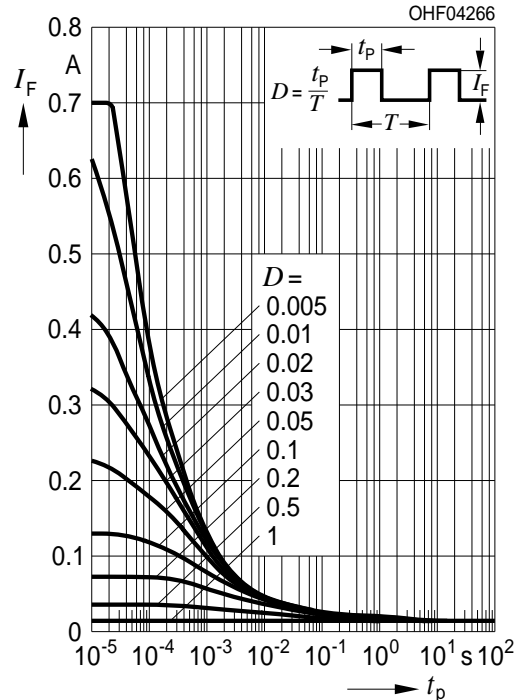

Radiation Characteristics ^{3) page 12}

$I_{rel} = f(\phi), T_A = 25^\circ C$

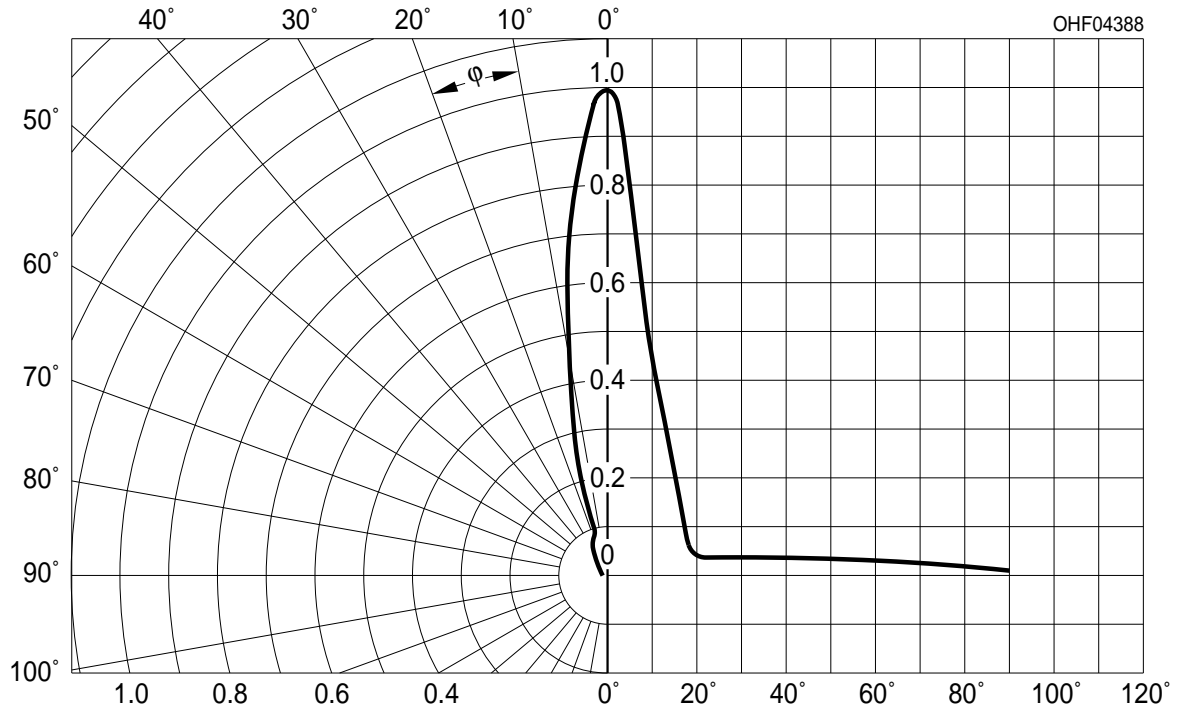

Package Outline

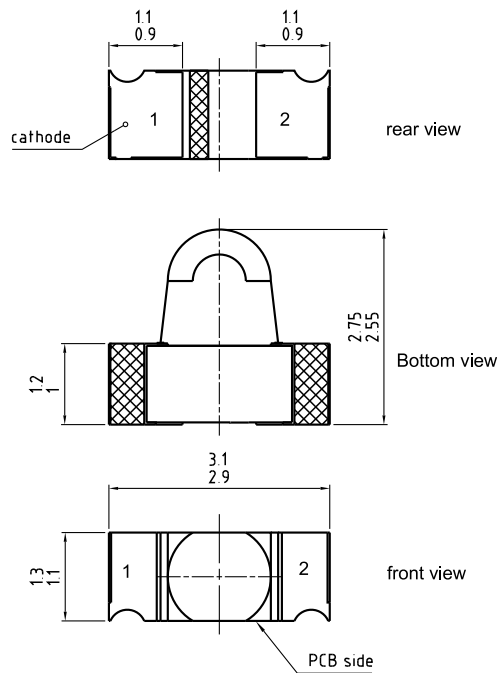

Dimensions in mm.

Package
Chiplid

Approximate Weight:

0.1 mg

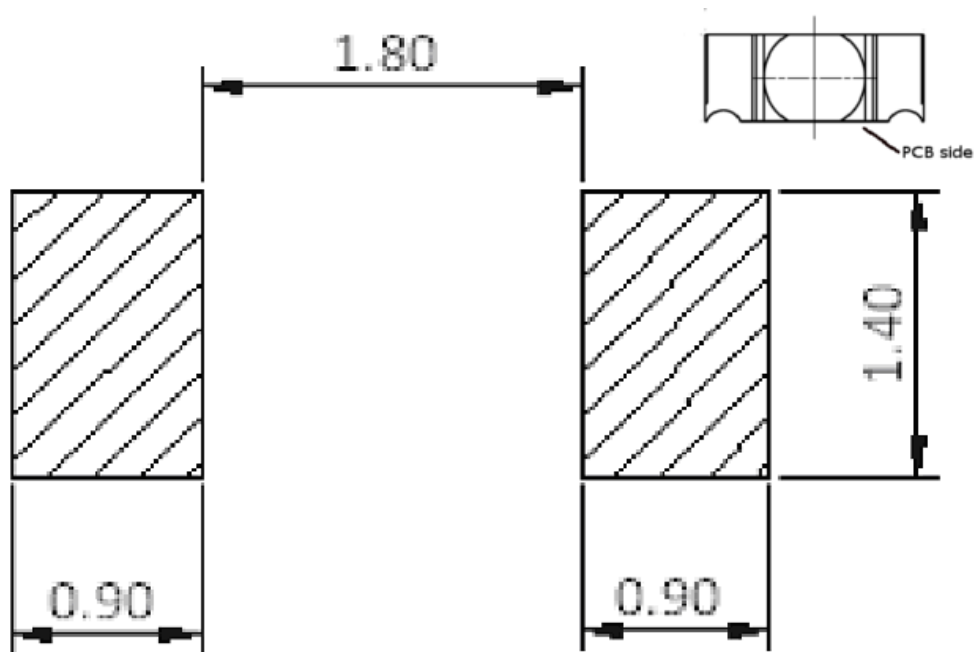
Recommended Solder Pad

Dimensions in mm.

Note:

- metalization layer is thicker than the solder resist layer

Note:- recommended solder thickness: 120 - 150 μm

Reflow Soldering Profile

Product complies to MSL Level 3 acc. to JEDEC J-STD-020D.01



OHA04612

Profile Feature Profil-Charakteristik	Symbol Symbol	Pb-Free (SnAgCu) Assembly			Unit Einheit
		Minimum	Recommendation	Maximum	
Ramp-up rate to preheat*) 25 °C to 150 °C			2	3	K/s
Time t_s T_{Smin} to T_{Smax}	t_s	60	100	120	s
Ramp-up rate to peak*) T_{Smax} to T_p			2	3	K/s
Liquidus temperature	T_L		217		$^{\circ}\text{C}$
Time above liquidus temperature	t_L		80	100	s
Peak temperature	T_p		245	260	$^{\circ}\text{C}$
Time within 5 °C of the specified peak temperature $T_p - 5\text{ K}$	t_p	10	20	30	s
Ramp-down rate* T_p to 100 °C			3	6	K/s
Time 25 °C to T_p				480	s

All temperatures refer to the center of the package, measured on the top of the component

* slope calculation DT/Dt : Dt max. 5 s; fulfillment for the whole T-range

Taping

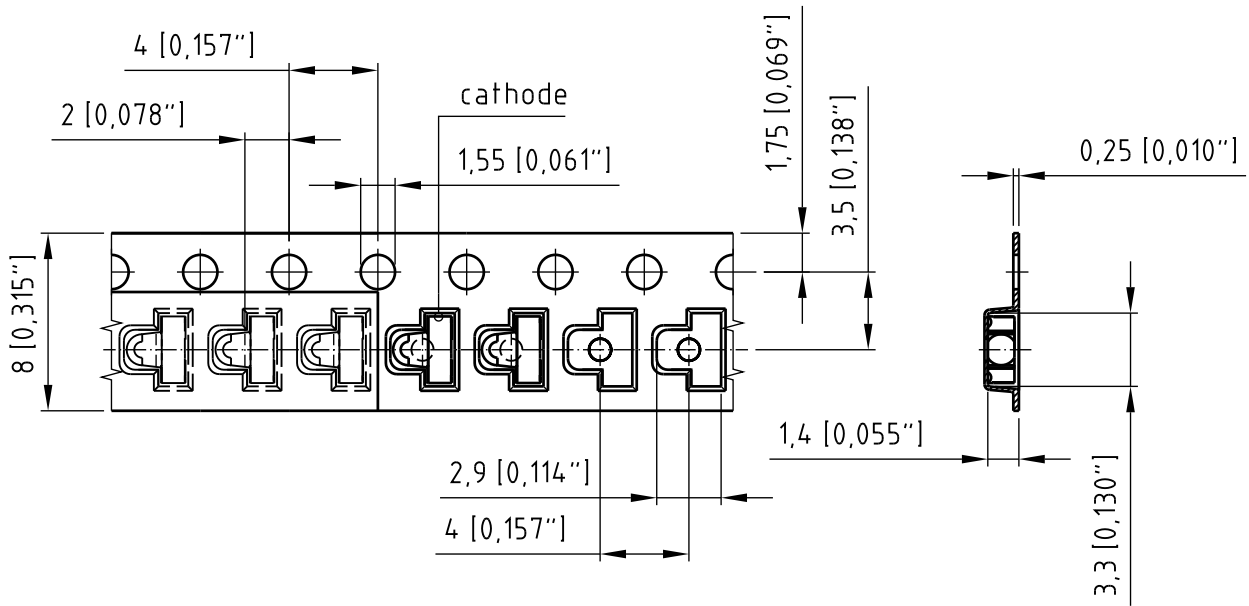

C63062-A4189-B1-03

Dimensions in mm [inch].

Tape and Reel

8 mm tape with 2000 pcs. on \varnothing 180 mm reel



Leader: min. 400 mm *

Trailer: min. 160 mm *

*) Dimensions acc. to IEC 60286-3; EIA 481-D

OHAY0324

Tape dimensions [mm]

W	P ₀	P ₁	P ₂	D ₀	E	F
8 + 0.3 / -0.1	4 ± 0.1	2 ± 0.05 or 4 ± 0.1	2 ± 0.05	1.5 ± 0.1	1.75 ± 0.1	3.5 ± 0.05

Reel dimensions [mm]

A	W	N _{min}	W ₁	W _{2max}
180	8	60	8.4 + 2	14.4

Barcode-Product-Label (BPL)



Dry Packing Process and Materials



Note:

Moisture-sensitive product is packed in a dry bag containing desiccant and a humidity card. Regarding dry pack you will find further information in the internet. Here you will also find the normative references like JEDEC.

Transportation Packing and Materials



Dimensions of transportation box in mm

Width	Length	Height
200 ± 5	195 ± 5	30 ± 5

Disclaimer

Language english will prevail in case of any discrepancies or deviations between the two language wordings.

Attention please!

The information describes the type of component and shall not be considered as assured characteristics.

Terms of delivery and rights to change design reserved. Due to technical requirements components may contain dangerous substances.

For information on the types in question please contact our Sales Organization.

If printed or downloaded, please find the latest version in the Internet.

Packing

Please use the recycling operators known to you. We can also help you – get in touch with your nearest sales office.

By agreement we will take packing material back, if it is sorted. You must bear the costs of transport. For packing material that is returned to us unsorted or which we are not obliged to accept, we shall have to invoice you for any costs incurred.

Components used in life-support devices or systems must be expressly authorized for such purpose!

Critical components* may only be used in life-support devices** or systems with the express written approval of OSRAM OS.

*) A critical component is a component used in a life-support device or system whose failure can reasonably be expected to cause the failure of that life-support device or system, or to affect its safety or the effectiveness of that device or system.

**) Life support devices or systems are intended (a) to be implanted in the human body, or (b) to support and/or maintain and sustain human life. If they fail, it is reasonable to assume that the health and the life of the user may be endangered.

Glossary

- 1) **Thermal resistance:** junction -ambient, mounted on PC-board (FR4), pads size 16 mm² each
- 2) **Thermal resistance:** junction - soldering point, of the device only, mounted on an ideal heatsink (e.g. metal block)
- 3) **Typical Values:** Due to the special conditions of the manufacturing processes of LED, the typical data or calculated correlations of technical parameters can only reflect statistical figures. These do not necessarily correspond to the actual parameters of each single product, which could differ from the typical data and calculated correlations or the typical characteristic line. If requested, e.g. because of technical improvements, these typ. data will be changed without any further notice.

Published by OSRAM Opto Semiconductors GmbH
Leibnizstraße 4, D-93055 Regensburg
www.osram-os.com © All Rights Reserved.

EU RoHS and China RoHS compliant product



此产品符合欧盟 RoHS 指令的要求；
按照中国的相关法规和标准，不含有毒有害物质或元素。