

SMPS IGBT

IRGB20B60PD1PbF

WARP2 SERIES IGBT WITH  
ULTRAFAST SOFT RECOVERY DIODE

**Applications**

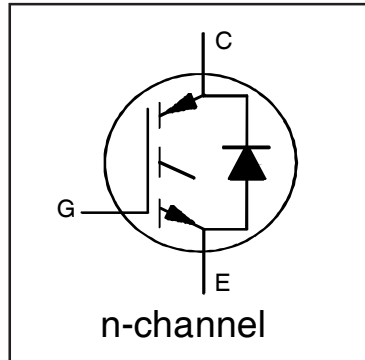
- Telecom and Server SMPS
- PFC and ZVS SMPS Circuits
- Uninterruptable Power Supplies
- Consumer Electronics Power Supplies
- Lead-Free

**Features**

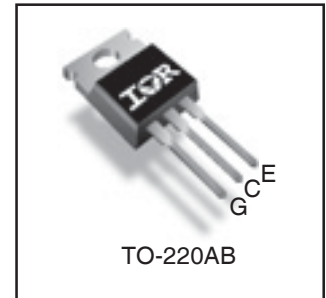
- NPT Technology, Positive Temperature Coefficient
- Lower  $V_{CE(SAT)}$
- Lower Parasitic Capacitances
- Minimal Tail Current
- HEXFRED Ultra Fast Soft-Recovery Co-Pack Diode
- Tighter Distribution of Parameters
- Higher Reliability

**Benefits**

- Parallel Operation for Higher Current Applications
- Lower Conduction Losses and Switching Losses
- Higher Switching Frequency up to 150kHz



$V_{CES} = 600V$
$V_{CE(on)} \text{ typ.} = 2.05V$ @ $V_{GE} = 15V$ $I_C = 13.0A$
<b>Equivalent MOSFET Parameters</b> ①
$R_{CE(on)} \text{ typ.} = 158m\Omega$
$I_D$ (FET equivalent) = 20A



**Absolute Maximum Ratings**

	Parameter	Max.	Units
$V_{CES}$	Collector-to-Emitter Voltage	600	V
$I_C @ T_C = 25^\circ C$	Continuous Collector Current	40	A
$I_C @ T_C = 100^\circ C$	Continuous Collector Current	22	
$I_{CM}$	Pulse Collector Current (Ref. Fig. C.T.4)	80	
$I_{LM}$	Clamped Inductive Load Current ②	80	
$I_F @ T_C = 25^\circ C$	Diode Continuous Forward Current	10	
$I_F @ T_C = 100^\circ C$	Diode Continuous Forward Current	4	
$I_{FRM}$	Maximum Repetitive Forward Current ③	16	
$V_{GE}$	Gate-to-Emitter Voltage	$\pm 20$	
$P_D @ T_C = 25^\circ C$	Maximum Power Dissipation	215	W
$P_D @ T_C = 100^\circ C$	Maximum Power Dissipation	86	
$T_J$	Operating Junction and	-55 to +150	$^\circ C$
$T_{STG}$	Storage Temperature Range		
	Soldering Temperature, for 10 sec.		
	Mounting Torque, 6-32 or M3 Screw	10 lbf-in (1.1 N·m)	

**Thermal Resistance**

	Parameter	Min.	Typ.	Max.	Units
$R_{\theta JC}$ (IGBT)	Thermal Resistance Junction-to-Case-(each IGBT)	—	—	0.58	$^\circ C/W$
$R_{\theta JC}$ (Diode)	Thermal Resistance Junction-to-Case-(each Diode)	—	—	5.0	
$R_{\theta CS}$	Thermal Resistance, Case-to-Sink (flat, greased surface)	—	0.50	—	
$R_{\theta JA}$	Thermal Resistance, Junction-to-Ambient (typical socket mount)	—	—	80	
	Weight	—	2 (0.07)	—	g (oz)

# IRGB20B60PD1PbF

Electrical Characteristics @ T<sub>J</sub> = 25°C (unless otherwise specified)

International  
 Rectifier

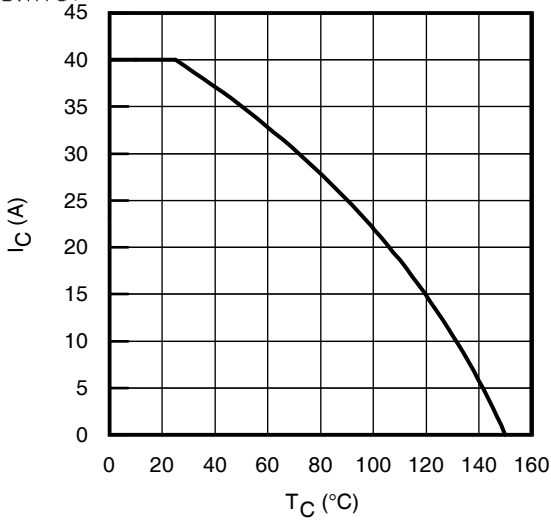
	Parameter	Min.	Typ.	Max.	Units	Conditions	Ref.Fig
V <sub>(BR)CES</sub>	Collector-to-Emitter Breakdown Voltage	600	—	—	V	V <sub>GE</sub> = 0V, I <sub>C</sub> = 500μA	
ΔV <sub>(BR)CES</sub> /ΔT <sub>J</sub>	Temperature Coeff. of Breakdown Voltage	—	0.32	—	V/°C	V <sub>GE</sub> = 0V, I <sub>C</sub> = 1mA (25°C-125°C)	
R <sub>G</sub>	Internal Gate Resistance	—	4.3	—	Ω	1MHz, Open Collector	
V <sub>CE(on)</sub>	Collector-to-Emitter Saturation Voltage	—	2.05	2.35	V	I <sub>C</sub> = 13A, V <sub>GE</sub> = 15V	4, 5,6,8,9
		—	2.50	2.80		I <sub>C</sub> = 20A, V <sub>GE</sub> = 15V	
		—	2.65	3.00		I <sub>C</sub> = 13A, V <sub>GE</sub> = 15V, T <sub>J</sub> = 125°C	
		—	3.30	3.70		I <sub>C</sub> = 20A, V <sub>GE</sub> = 15V, T <sub>J</sub> = 125°C	
V <sub>GE(th)</sub>	Gate Threshold Voltage	3.0	4.0	5.0	V	I <sub>C</sub> = 250μA	7,8,9
ΔV <sub>GE(th)</sub> /ΔT <sub>J</sub>	Threshold Voltage temp. coefficient	—	-11	—	mV/°C	V <sub>CE</sub> = V <sub>GE</sub> , I <sub>C</sub> = 1.0mA	
g <sub>f</sub>	Forward Transconductance	—	19	—	S	V <sub>CE</sub> = 50V, I <sub>C</sub> = 40A, PW = 80μs	
I <sub>CES</sub>	Collector-to-Emitter Leakage Current	—	1.0	250	μA	V <sub>GE</sub> = 0V, V <sub>CE</sub> = 600V	
		—	0.1	—	mA	V <sub>GE</sub> = 0V, V <sub>CE</sub> = 600V, T <sub>J</sub> = 125°C	
V <sub>FM</sub>	Diode Forward Voltage Drop	—	1.5	1.8	V	I <sub>F</sub> = 4.0A, V <sub>GE</sub> = 0V	10
		—	1.4	1.7		I <sub>F</sub> = 4.0A, V <sub>GE</sub> = 0V, T <sub>J</sub> = 125°C	
I <sub>GES</sub>	Gate-to-Emitter Leakage Current	—	—	±100	nA	V <sub>GE</sub> = ±20V, V <sub>CE</sub> = 0V	

## Switching Characteristics @ T<sub>J</sub> = 25°C (unless otherwise specified)

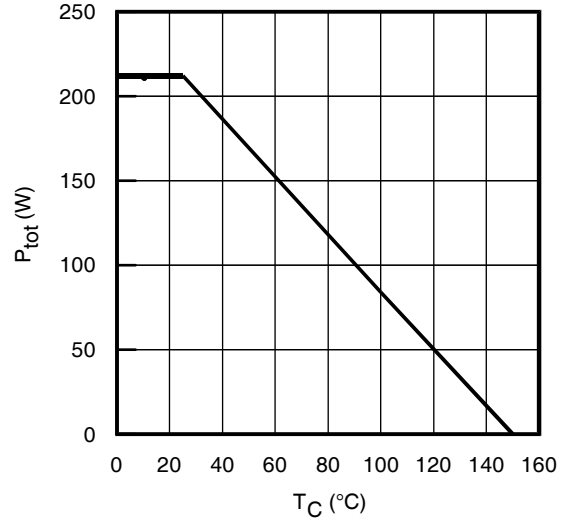
	Parameter	Min.	Typ.	Max.	Units	Conditions	Ref.Fig
Q <sub>g</sub>	Total Gate Charge (turn-on)	—	68	102	nC	I <sub>C</sub> = 13A	17
Q <sub>gc</sub>	Gate-to-Collector Charge (turn-on)	—	24	36		V <sub>CC</sub> = 400V	CT1
Q <sub>ge</sub>	Gate-to-Emitter Charge (turn-on)	—	10	15		V <sub>GE</sub> = 15V	
E <sub>on</sub>	Turn-On Switching Loss	—	95	140	μJ	I <sub>C</sub> = 13A, V <sub>CC</sub> = 390V	CT3
E <sub>off</sub>	Turn-Off Switching Loss	—	100	145		V <sub>GE</sub> = +15V, R <sub>G</sub> = 10Ω, L = 200μH	
E <sub>total</sub>	Total Switching Loss	—	195	285		T <sub>J</sub> = 25°C ④	
t <sub>d(on)</sub>	Turn-On delay time	—	20	26	ns	I <sub>C</sub> = 13A, V <sub>CC</sub> = 390V	CT3
t <sub>r</sub>	Rise time	—	5.0	7.0		V <sub>GE</sub> = +15V, R <sub>G</sub> = 10Ω, L = 200μH	
t <sub>d(off)</sub>	Turn-Off delay time	—	115	135		T <sub>J</sub> = 25°C ④	
t <sub>f</sub>	Fall time	—	6.0	8.0			
E <sub>on</sub>	Turn-On Switching Loss	—	165	215		I <sub>C</sub> = 13A, V <sub>CC</sub> = 390V	
E <sub>off</sub>	Turn-Off Switching Loss	—	150	195	μJ	V <sub>GE</sub> = +15V, R <sub>G</sub> = 10Ω, L = 200μH	11,13
E <sub>total</sub>	Total Switching Loss	—	315	410		T <sub>J</sub> = 125°C ④	WF1,WF2
t <sub>d(on)</sub>	Turn-On delay time	—	19	25		I <sub>C</sub> = 13A, V <sub>CC</sub> = 390V	CT3
t <sub>r</sub>	Rise time	—	6.0	8.0	ns	V <sub>GE</sub> = +15V, R <sub>G</sub> = 10Ω, L = 200μH	12,14
t <sub>d(off)</sub>	Turn-Off delay time	—	125	140		T <sub>J</sub> = 125°C ④	WF1,WF2
t <sub>f</sub>	Fall time	—	13	17			
C <sub>ies</sub>	Input Capacitance	—	1560	—		pF	V <sub>GE</sub> = 0V
C <sub>oes</sub>	Output Capacitance	—	95	—	V <sub>CC</sub> = 30V		
C <sub>res</sub>	Reverse Transfer Capacitance	—	20	—	f = 1Mhz		
C <sub>oes eff.</sub>	Effective Output Capacitance (Time Related) ⑤	—	83	—	V <sub>GE</sub> = 0V, V <sub>CE</sub> = 0V to 480V		15
C <sub>oes eff. (ER)</sub>	Effective Output Capacitance (Energy Related) ⑤	—	61	—			
RBSOA	Reverse Bias Safe Operating Area	FULL SQUARE				T <sub>J</sub> = 150°C, I <sub>C</sub> = 80A V <sub>CC</sub> = 480V, V <sub>p</sub> = 600V R <sub>g</sub> = 22Ω, V <sub>GE</sub> = +15V to 0V	3 CT2
t <sub>rr</sub>	Diode Reverse Recovery Time	—	28	42	ns	T <sub>J</sub> = 25°C I <sub>F</sub> = 4.0A, V <sub>R</sub> = 200V,	19
		—	38	57		T <sub>J</sub> = 125°C di/dt = 200A/μs	
Q <sub>rr</sub>	Diode Reverse Recovery Charge	—	40	60	nC	T <sub>J</sub> = 25°C I <sub>F</sub> = 4.0A, V <sub>R</sub> = 200V,	21
		—	70	105		T <sub>J</sub> = 125°C di/dt = 200A/μs	
I <sub>rr</sub>	Peak Reverse Recovery Current	—	2.9	5.2	A	T <sub>J</sub> = 25°C I <sub>F</sub> = 4.0A, V <sub>R</sub> = 200V,	19,20,21,22
		—	3.7	6.7		T <sub>J</sub> = 125°C di/dt = 200A/μs	

### Notes:

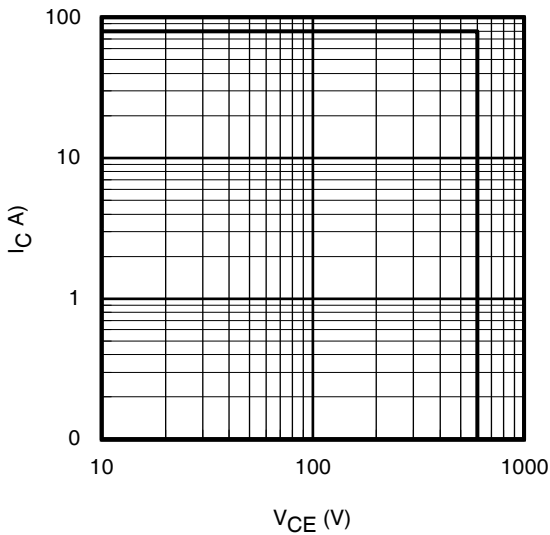
- ① R<sub>CE(on)</sub> typ. = equivalent on-resistance = V<sub>CE(on)</sub> typ. / I<sub>C</sub>, where V<sub>CE(on)</sub> typ. = 2.05V and I<sub>C</sub> = 13A. I<sub>D</sub> (FET Equivalent) is the equivalent MOSFET I<sub>D</sub> rating @ 25°C for applications up to 150kHz. These are provided for comparison purposes (only) with equivalent MOSFET solutions.
- ② V<sub>CC</sub> = 80% (V<sub>CES</sub>), V<sub>GE</sub> = 15V, L = 28μH, R<sub>G</sub> = 22Ω.
- ③ Pulse width limited by max. junction temperature.
- ④ Energy losses include "tail" and diode reverse recovery. Data generated with use of Diode 8ETH06.
- ⑤ C<sub>oes eff.</sub> is a fixed capacitance that gives the same charging time as C<sub>oes</sub> while V<sub>CE</sub> is rising from 0 to 80% V<sub>CES</sub>.  
C<sub>oes eff.(ER)</sub> is a fixed capacitance that stores the same energy as C<sub>oes</sub> while V<sub>CE</sub> is rising from 0 to 80% V<sub>CES</sub>.



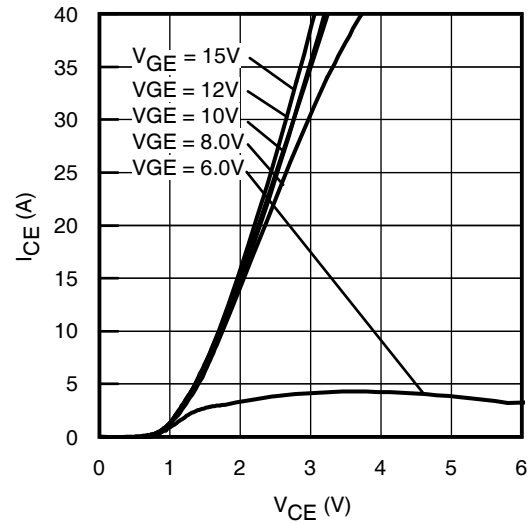
**Fig. 1** - Maximum DC Collector Current vs. Case Temperature



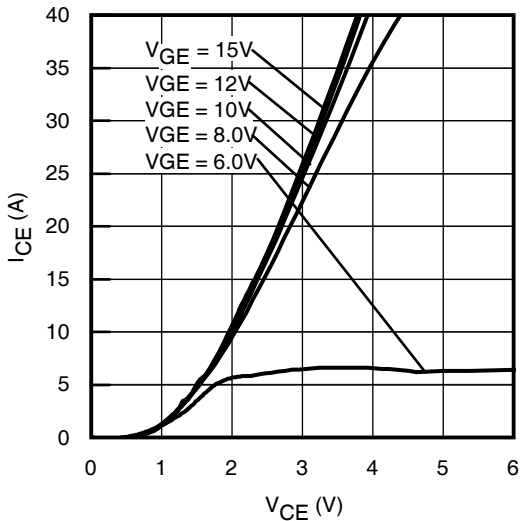
**Fig. 2** - Power Dissipation vs. Case Temperature



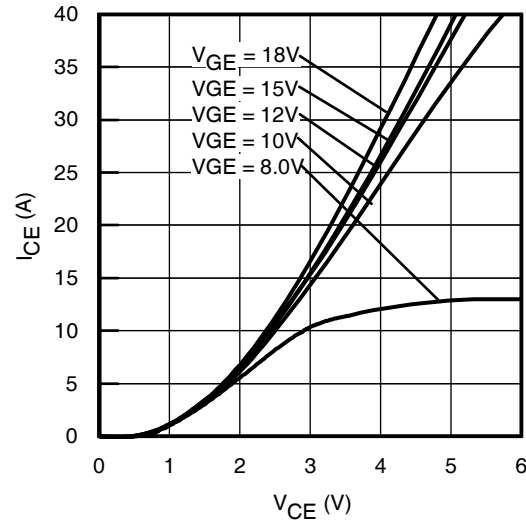
**Fig. 3** - Reverse Bias SOA  
 $T_J = 150^\circ\text{C}$ ;  $V_{GE} = 15\text{V}$



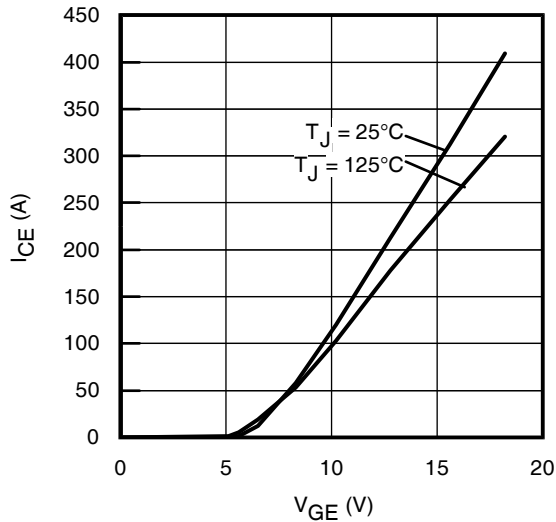
**Fig. 4** - Typ. IGBT Output Characteristics  
 $T_J = -40^\circ\text{C}$ ;  $t_p = 80\mu\text{s}$



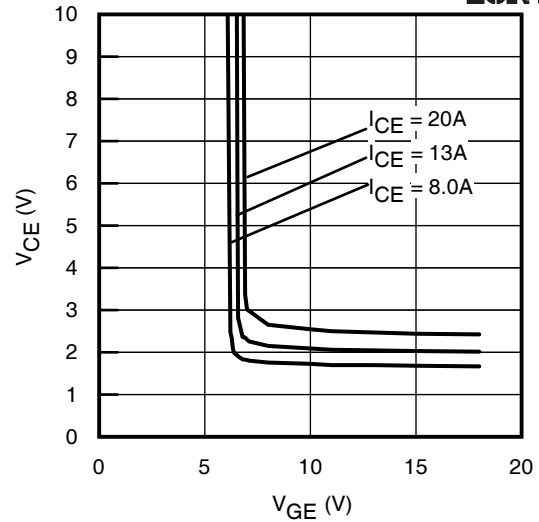
**Fig. 5** - Typ. IGBT Output Characteristics  
 $T_J = 25^\circ\text{C}$ ;  $t_p = 80\mu\text{s}$



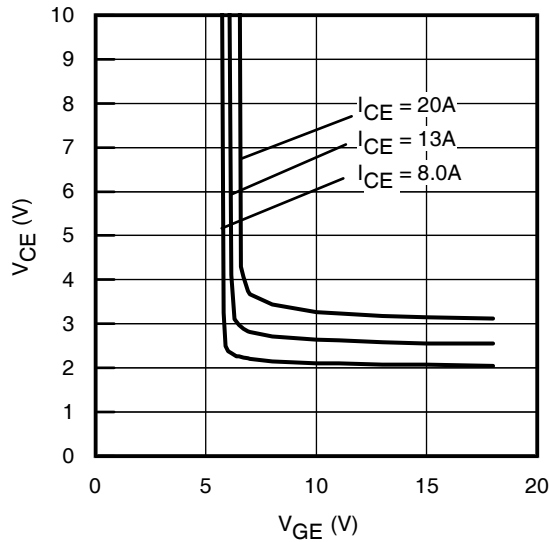
**Fig. 6** - Typ. IGBT Output Characteristics  
 $T_J = 125^\circ\text{C}$ ;  $t_p = 80\mu\text{s}$



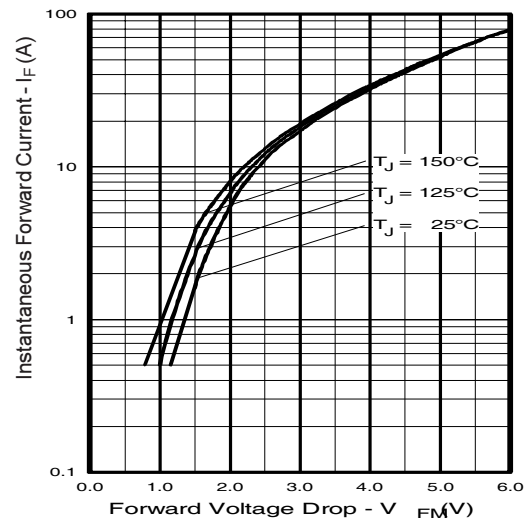
**Fig. 7** - Typ. Transfer Characteristics  
 $V_{CE} = 50V$ ;  $t_p = 10\mu s$



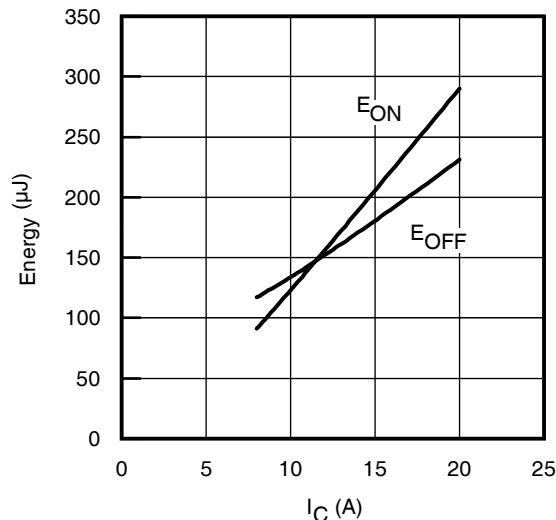
**Fig. 8** - Typical  $V_{CE}$  vs.  $V_{GE}$   
 $T_J = 25^\circ C$



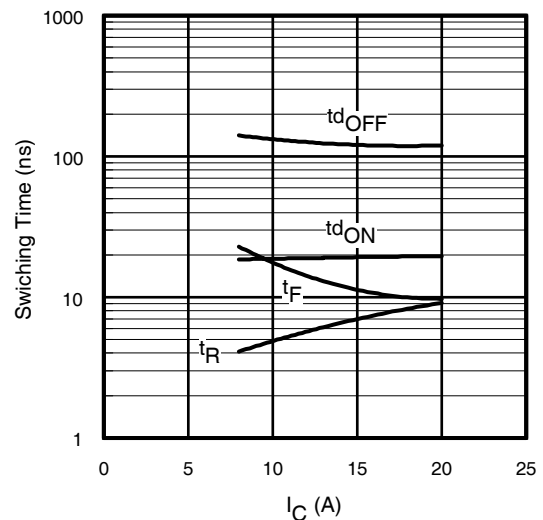
**Fig. 9** - Typical  $V_{CE}$  vs.  $V_{GE}$   
 $T_J = 125^\circ C$



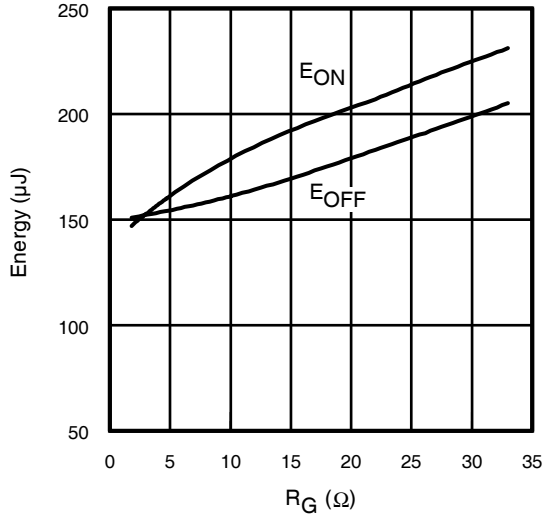
**Fig. 10** - Typ. Diode Forward Characteristics  
 $t_p = 80\mu s$



**Fig. 11** - Typ. Energy Loss vs.  $I_C$   
 $T_J = 125^\circ C$ ;  $L = 200\mu H$ ;  $V_{CE} = 390V$ ;  $R_G = 10\Omega$ ;  $V_{GE} = 15V$ .  
Diode clamp used: 8ETH06 (See C.T.3)

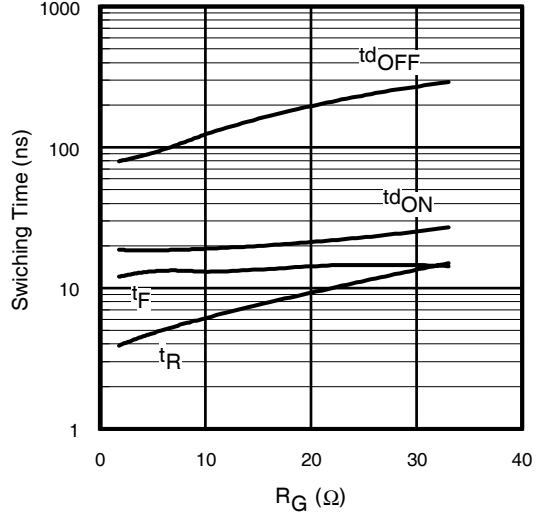


**Fig. 12** - Typ. Switching Time vs.  $I_C$   
 $T_J = 125^\circ C$ ;  $L = 200\mu H$ ;  $V_{CE} = 390V$ ;  $R_G = 10\Omega$ ;  $V_{GE} = 15V$ .  
Diode clamp used: 8ETH06 (See C.T.3)



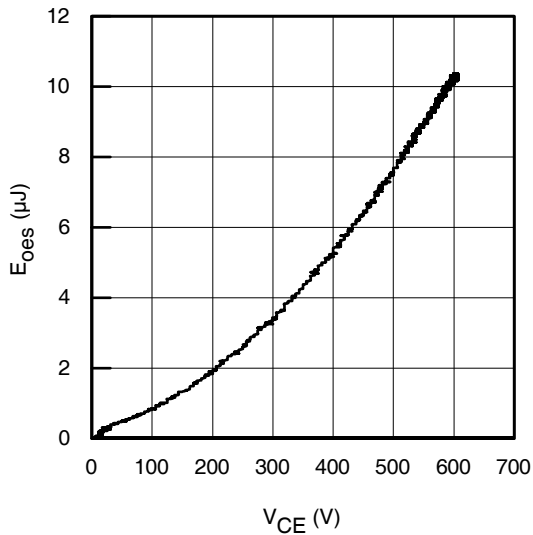
**Fig. 13** - Typ. Energy Loss vs.  $R_G$

$T_J = 125^\circ\text{C}$ ;  $L = 200\mu\text{H}$ ;  $V_{CE} = 390\text{V}$ ;  $I_{CE} = 13\text{A}$ ;  $V_{GE} = 15\text{V}$   
Diode clamp used: 8ETH06 (See C.T.3)

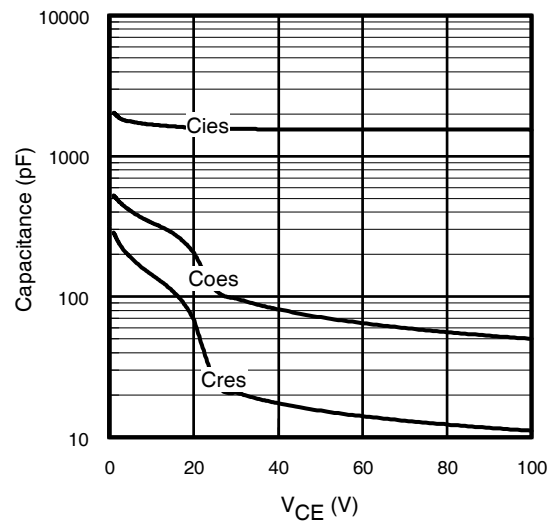


**Fig. 14** - Typ. Switching Time vs.  $R_G$

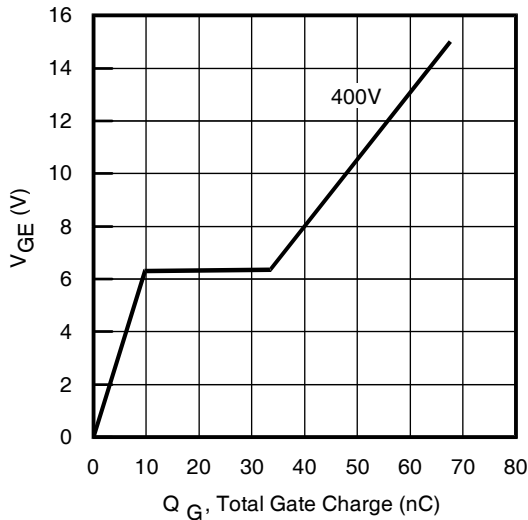
$T_J = 125^\circ\text{C}$ ;  $L = 200\mu\text{H}$ ;  $V_{CE} = 390\text{V}$ ;  $I_{CE} = 13\text{A}$ ;  $V_{GE} = 15\text{V}$   
Diode clamp used: 8ETH06 (See C.T.3)



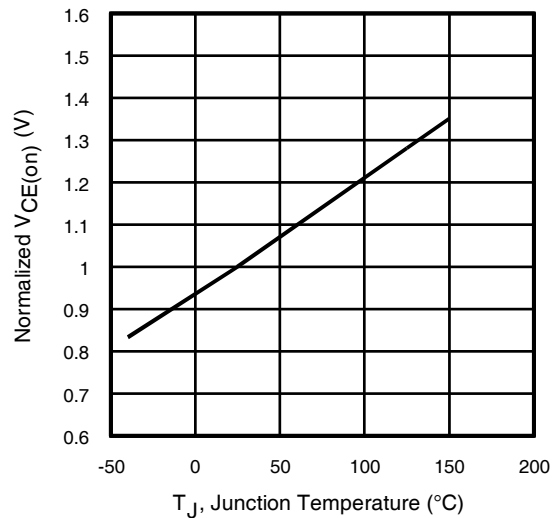
**Fig. 15**- Typ. Output Capacitance  
Stored Energy vs.  $V_{CE}$



**Fig. 16**- Typ. Capacitance vs.  $V_{CE}$   
 $V_{GE} = 0\text{V}$ ;  $f = 1\text{MHz}$



**Fig. 17** - Typical Gate Charge vs.  $V_{GE}$   
 $I_{CE} = 13\text{A}$



**Fig. 18** - Normalized Typical  $V_{CE(on)}$  vs.  
Junction Temperature  
 $I_{CE} = 13\text{A}$ ;  $V_{GE} = 15\text{V}$

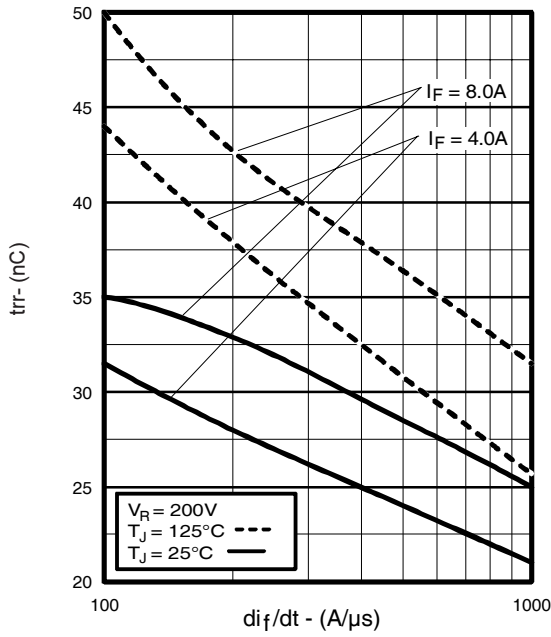


Fig. 19 - Typical Reverse Recovery vs.  $dI_f/dt$

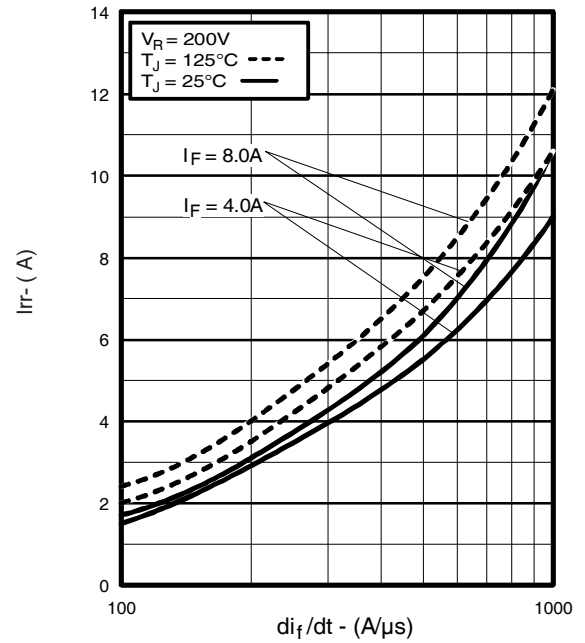


Fig. 20 - Typical Recovery Current vs.  $dI_f/dt$

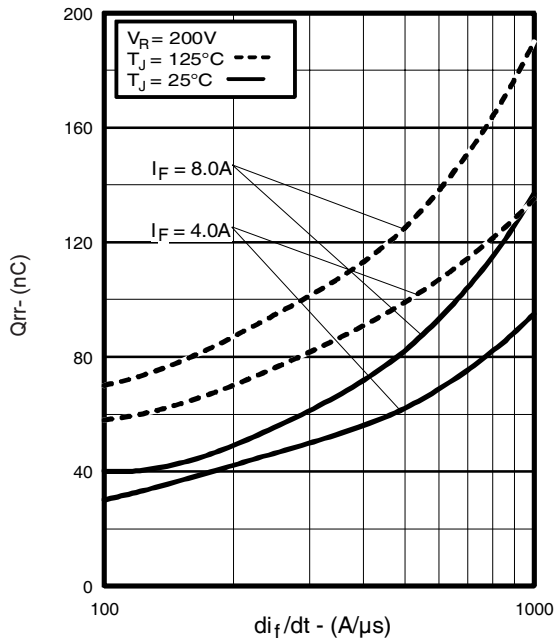


Fig. 21 - Typical Stored Charge vs.  $dI_f/dt$

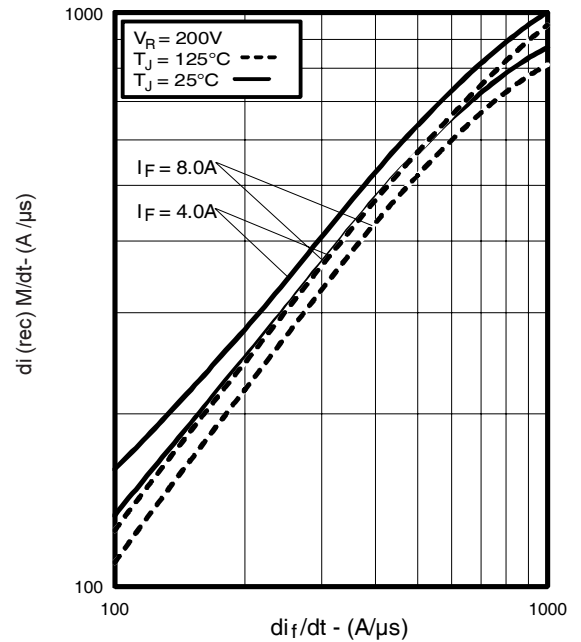


Fig. 22 - Typical  $dI_{(rec)M}/dt$  vs.  $dI_f/dt$

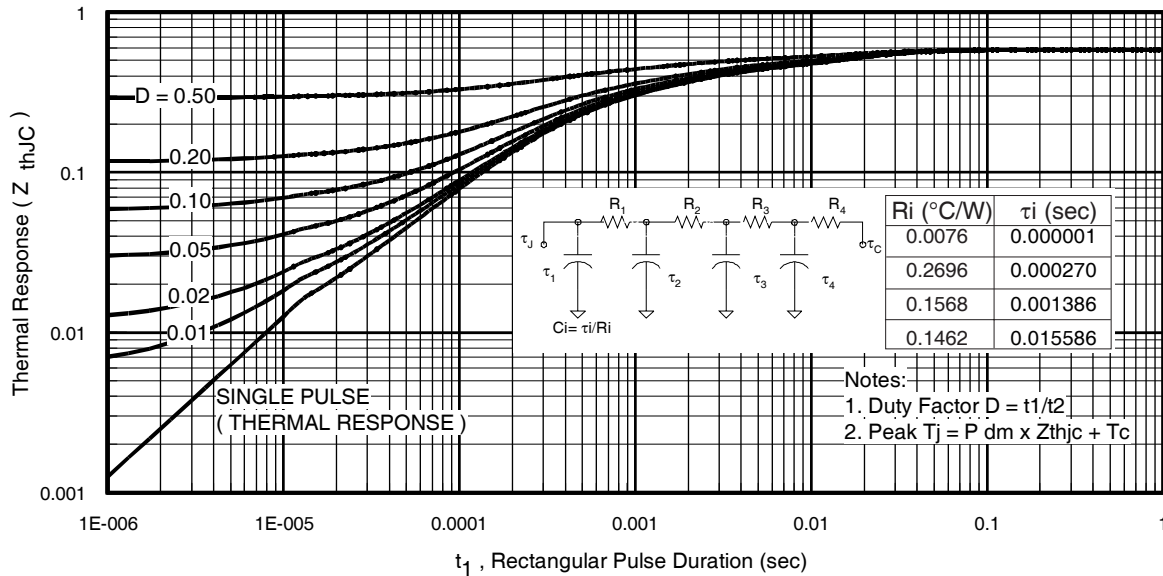


Fig 23. Maximum Transient Thermal Impedance, Junction-to-Case (IGBT)

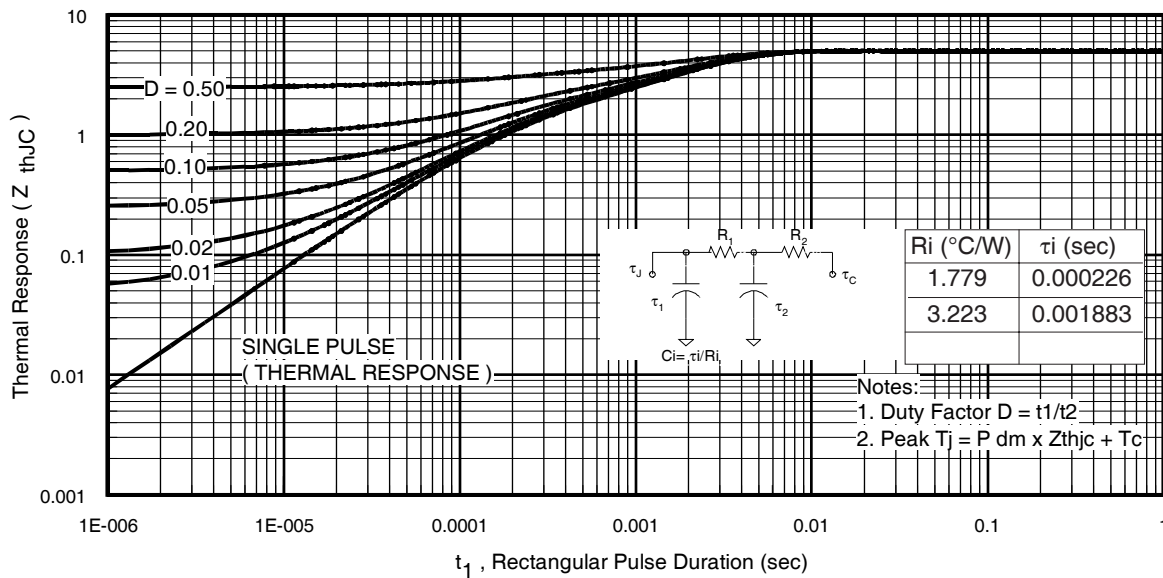
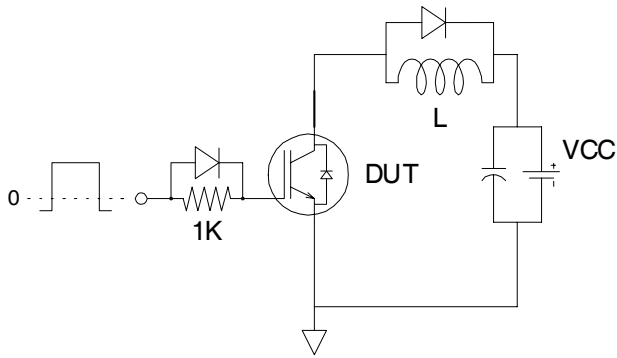
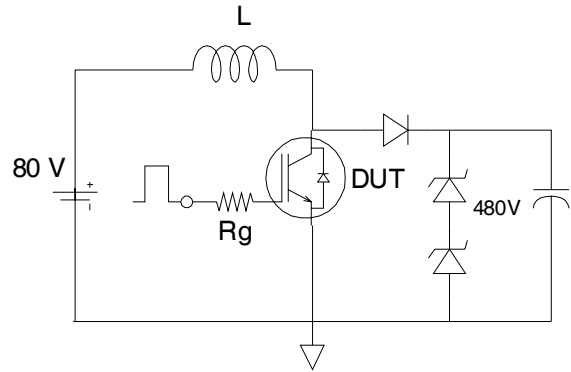


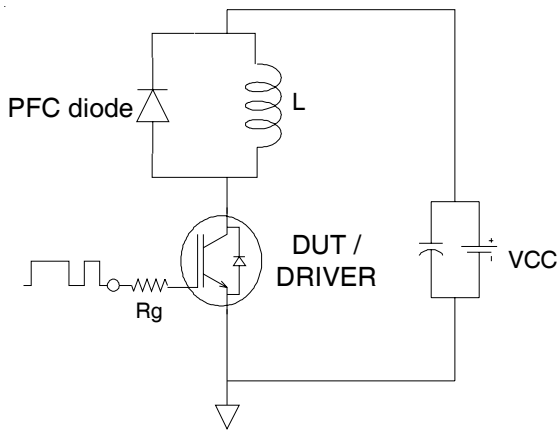
Fig. 24. Maximum Transient Thermal Impedance, Junction-to-Case (DIODE)



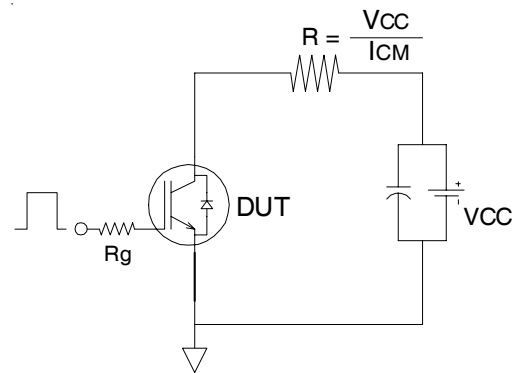
**Fig.C.T.1** - Gate Charge Circuit (turn-off)



**Fig.C.T.2** - RBSOA Circuit

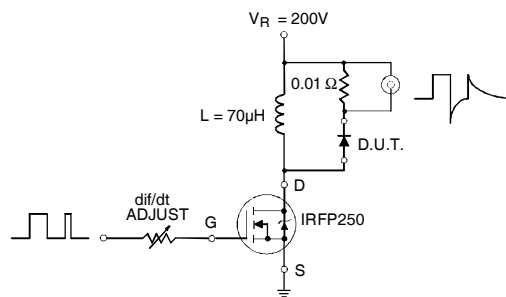


**Fig.C.T.3** - Switching Loss Circuit



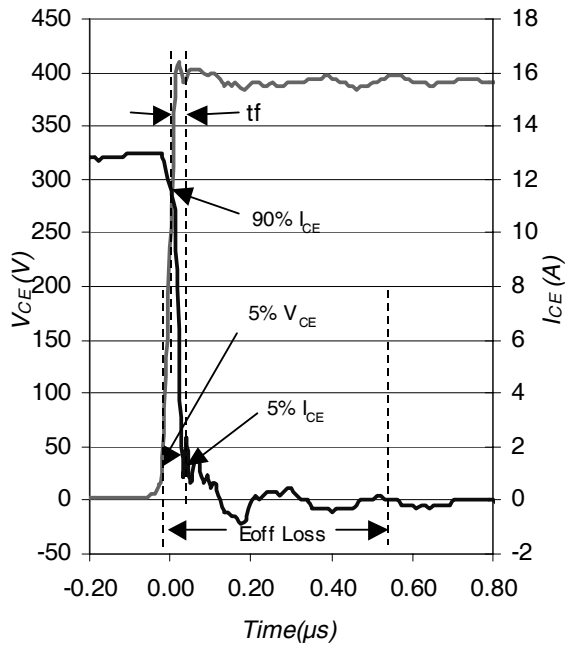
**Fig.C.T.4** - Resistive Load Circuit

### REVERSE RECOVERY CIRCUIT

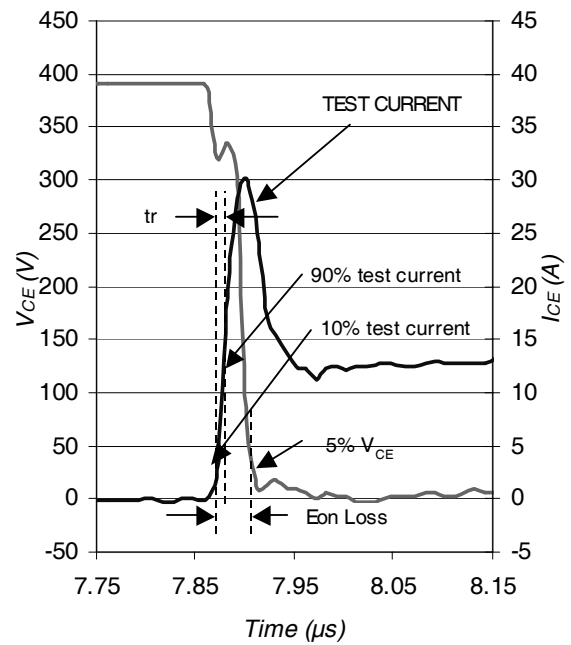


**Fig. C.T.5** - Reverse Recovery Parameter Test Circuit

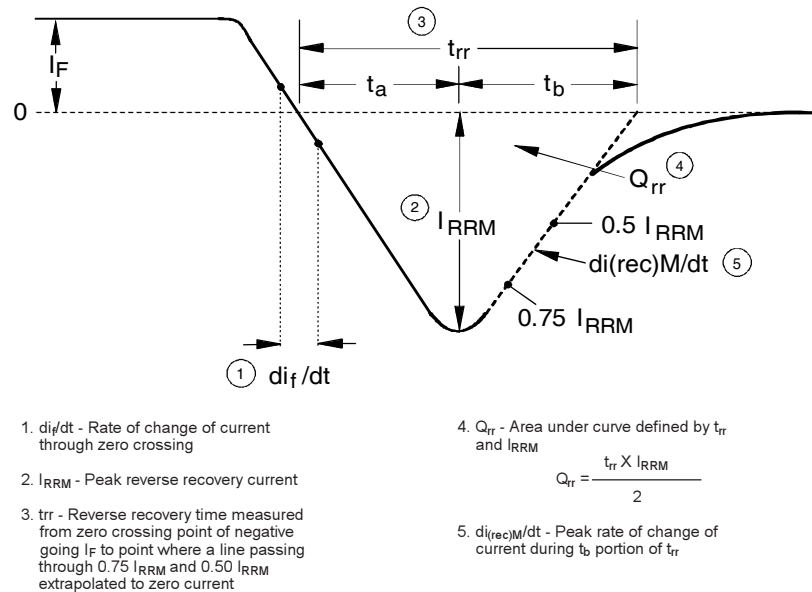




**Fig. WF1** - Typ. Turn-off Loss Waveform  
@  $T_J = 125^\circ\text{C}$  using Fig. CT.3



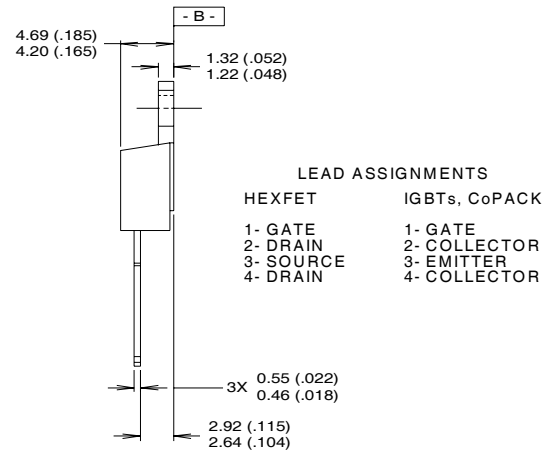
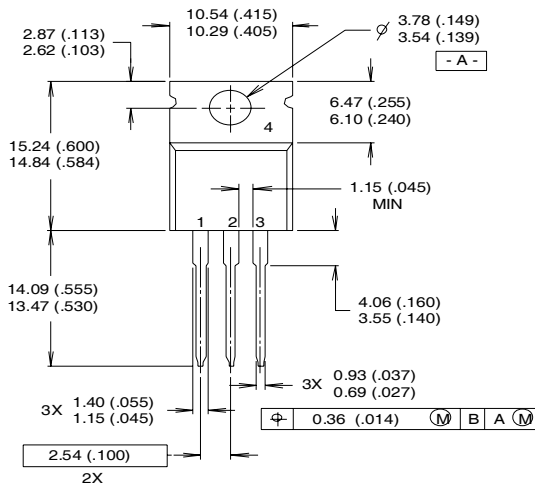
**Fig. WF2** - Typ. Turn-on Loss Waveform  
@  $T_J = 125^\circ\text{C}$  using Fig. CT.3



**Fig. WF3** - Reverse Recovery Waveform and Definitions

## TO-220AB Package Outline

Dimensions are shown in millimeters (inches)



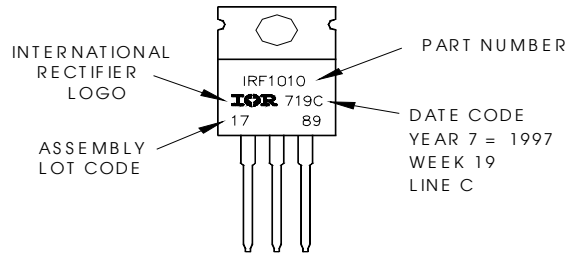
**NOTES:**

- 1 DIMENSIONING & TOLERANCING PER ANSI Y14.5M, 1982.
- 2 CONTROLLING DIMENSION : INCH

- 3 OUTLINE CONFORMS TO JEDEC OUTLINE TO-220AB.
- 4 HEATSINK & LEAD MEASUREMENTS DO NOT INCLUDE BURRS.

## TO-220AB Part Marking Information

EXAMPLE: THIS IS AN IRF1010  
 LOT CODE 1789  
 ASSEMBLED ON WW 19, 1997  
 IN THE ASSEMBLY LINE "C"  
**Note:** "P" in assembly line  
 position indicates "Lead-Free"



**TO-220AB package is not recommended for Surface Mount Application.**

Data and specifications subject to change without notice.  
 This product has been designed and qualified for Industrial market.  
 Qualification Standards can be found on IR's Web site.

Note: For the most current drawings please refer to the IR website at:  
<http://www.irf.com/package/>