

**HiPerFRED**

$$V_{RRM} = 1200V$$

$$I_{DAV} = 30A$$

$$t_{rr} = 40ns$$

High Performance Fast Recovery Diode  
 Low Loss and Soft Recovery  
 3~ Rectifier Bridge

Part number

FUE30-12N1

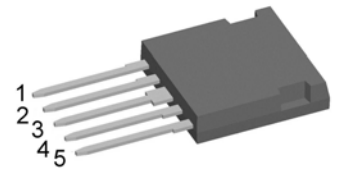

Backside: isolated

 E72873

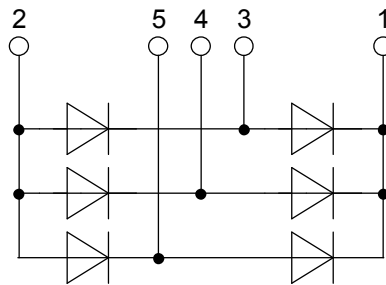
**Features / Advantages:**

- Planar passivated chips
- Very low leakage current
- Very short recovery time
- Improved thermal behaviour
- Very low  $I_{rm}$ -values
- Very soft recovery behaviour
- Avalanche voltage rated for reliable operation
- Soft reverse recovery for low EMI/RFI
- Low  $I_{rm}$  reduces:
  - Power dissipation within the diode
  - Turn-on loss in the commutating switch

**Applications:**

- Rectifiers in switch mode power supplies (SMPS)

**Package: i4-Pac**

- Isolation Voltage: 3000V~
- Industry convenient outline
- RoHS compliant
- Epoxy meets UL 94V-0
- Soldering pins for PCB mounting
- Backside: DCB ceramic
- Reduced weight
- Advanced power cycling

Fast Diode				Ratings			
Symbol	Definition	Conditions	min.	typ.	max.	Unit	
$V_{RSM}$	max. non-repetitive reverse blocking voltage	$T_{VJ} = 25^{\circ}C$			1200	V	
$V_{RRM}$	max. repetitive reverse blocking voltage	$T_{VJ} = 25^{\circ}C$			1200	V	
$I_R$	reverse current, drain current	$V_R = 1200 V$	$T_{VJ} = 25^{\circ}C$		100	$\mu A$	
		$V_R = 1200 V$	$T_{VJ} = 150^{\circ}C$		0.5	mA	
$V_F$	forward voltage drop	$I_F = 10 A$	$T_{VJ} = 25^{\circ}C$		2.37	V	
		$I_F = 30 A$			3.17	V	
		$I_F = 10 A$	$T_{VJ} = 150^{\circ}C$		1.60	V	
		$I_F = 30 A$			2.54	V	
$I_{DAV}$	bridge output current	$T_C = 120^{\circ}C$	$T_{VJ} = 175^{\circ}C$		30	A	
		rectangular $d = \frac{1}{3}$					
$V_{FO}$	threshold voltage	} for power loss calculation only	$T_{VJ} = 175^{\circ}C$		0.97	V	
$r_F$	slope resistance				48	m $\Omega$	
$R_{thJC}$	thermal resistance junction to case				2.3	K/W	
$R_{thCH}$	thermal resistance case to heatsink			0.20		K/W	
$P_{tot}$	total power dissipation		$T_C = 25^{\circ}C$		65	W	
$I_{FSM}$	max. forward surge current	$t = 10 ms; (50 Hz), sine; V_R = 0 V$	$T_{VJ} = 45^{\circ}C$		90	A	
$C_J$	junction capacitance	$V_R = 600 V f = 1 MHz$	$T_{VJ} = 25^{\circ}C$		5	pF	
$I_{RM}$	max. reverse recovery current	} $I_F = 15 A; V_R = 600 V$	$T_{VJ} = 25^{\circ}C$		6	A	
			$T_{VJ} = 100^{\circ}C$		9	A	
$t_{rr}$	reverse recovery time	} $-di_F/dt = 200 A/\mu s$	$T_{VJ} = 25^{\circ}C$		50	ns	
			$T_{VJ} = 100^{\circ}C$		140	ns	

Package i4-Pac		Ratings				
Symbol	Definition	Conditions	min.	typ.	max.	Unit
$I_{RMS}$	RMS current	per terminal			50	A
$T_{stg}$	storage temperature		-55		150	°C
$T_{VJ}$	virtual junction temperature		-55		175	°C
<b>Weight</b>				9		g
$F_C$	mounting force with clip		20		120	N
$d_{Spp/App}$	creepage distance on surface   striking distance through air	terminal to terminal	1.7			mm
$d_{Spb/Apb}$		terminal to backside	5.1			mm
$V_{ISOL}$	isolation voltage	t = 1 second	3000			V
		t = 1 minute	2500			V

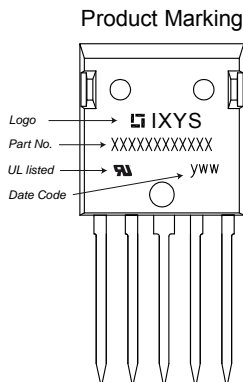

Ordering	Part Number	Marking on Product	Delivery Mode	Quantity	Code No.
Standard	FUE30-12N1	FUE30-12N1	Tube	25	488690

### Equivalent Circuits for Simulation

\* on die level

$T_{VJ} = 175\text{ °C}$



**Fast Diode**

$V_{0\ max}$	threshold voltage	0.97	V
$R_{0\ max}$	slope resistance *	46	mΩ

## Outlines i4-Pac

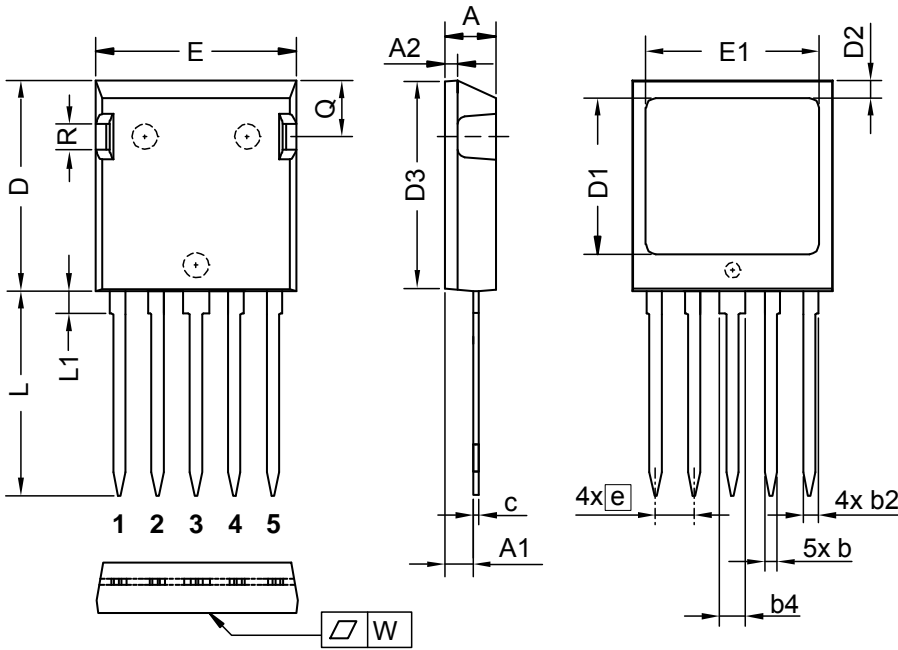

Dim.	Millimeter		Inches	
	min	max	min	max
A	4.83	5.21	0.190	0.205
A1	2.59	3.00	0.102	0.118
A2	1.17	2.16	0.046	0.085
b	1.14	1.40	0.045	0.055
b2	1.47	1.73	0.058	0.068
b4	2.54	2.79	0.100	0.110
c	0.51	0.74	0.020	0.029
D	20.80	21.34	0.819	0.840
D1	14.99	15.75	0.590	0.620
D2	1.65	2.03	0.065	0.080
D3	20.30	20.70	0.799	0.815
E	19.56	20.29	0.770	0.799
E1	16.76	17.53	0.660	0.690
e	3.81 BSC		0.150 BSC	
L	19.81	21.34	0.780	0.840
L1	2.11	2.59	0.083	0.102
Q	5.33	6.20	0.210	0.244
R	2.54	4.57	0.100	0.180
W	-	0.10	-	0.004

Die konvexe Form des Substrates ist typ. < 0.05 mm über der Kunststoffoberfläche der Bauteilunterseite  
 The convexbow of substrate is typ. < 0.05 mm over plastic surface level of device bottom side

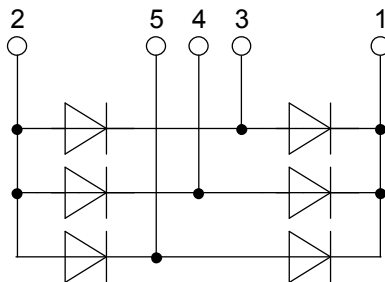

## Fast Diode

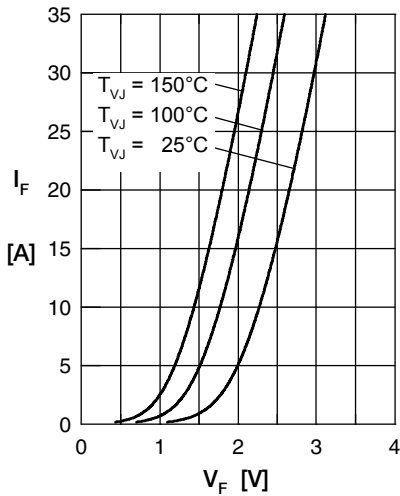

Fig. 1 Forward current  $I_F$  versus  $V_F$

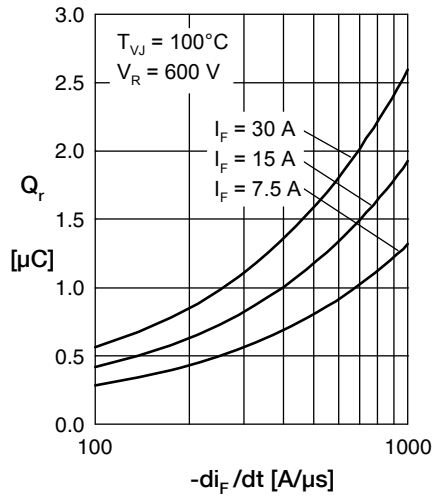

Fig. 2 Reverse recovery charge  $Q_r$  versus  $-di_F/dt$

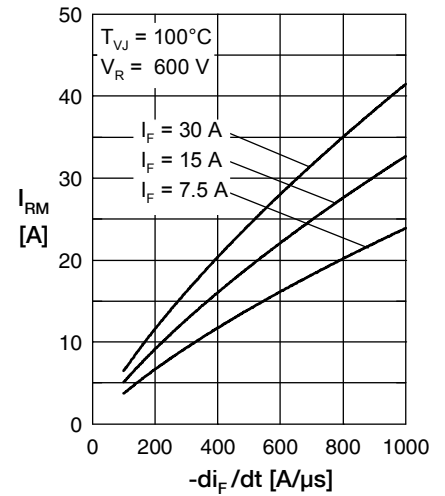

Fig. 3 Peak reverse current  $I_{RM}$  versus  $-di_F/dt$

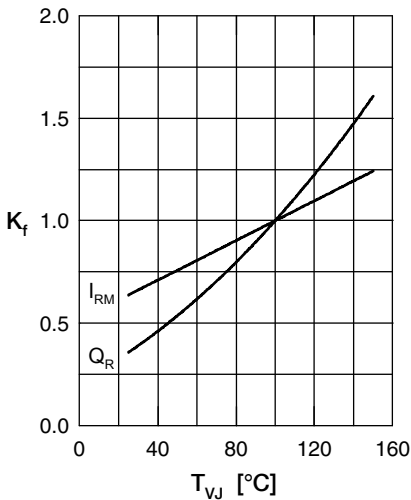

Fig. 4 Dynamic parameters  $Q_r$ ,  $I_{RM}$  versus  $T_{VJ}$

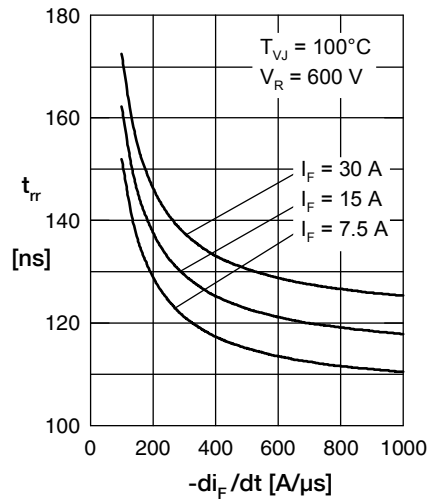

Fig. 5 Recovery time  $t_{rr}$  versus  $-di_F/dt$

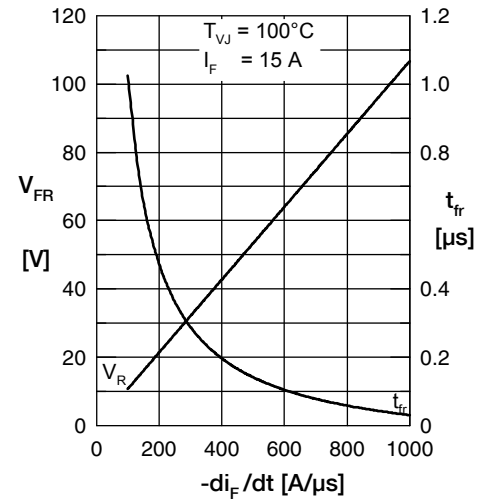

Fig. 6 Peak forward voltage  $V_{FR}$  and  $t_{fr}$  versus  $di_F/dt$

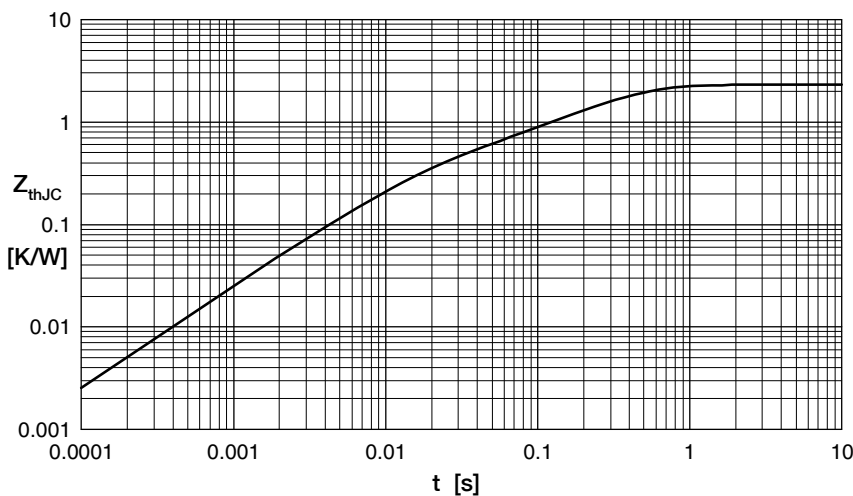

Fig. 7 Transient thermal resistance junction to case

Constants for  $Z_{thJC}$  calculation:

i	$R_{thi}$ (K/W)	$t_i$ (s)
1	0.78545	0.0052
2	0.30245	0.0003
3	0.0621	0.0004
4	1.15	0.0092