

Industrial Modbus Gateway

MB5408A / MB5416A
MB5408A2-N / MB5416A2-N

Hardware Installation Guide

Version 1.2
Updated in December, 2014



Tel: 886-3-5508137
Fax: 886-3-5508131
www.atop.com.tw

P/N:89900460G

Package Check List

Check whether your package contains following items:



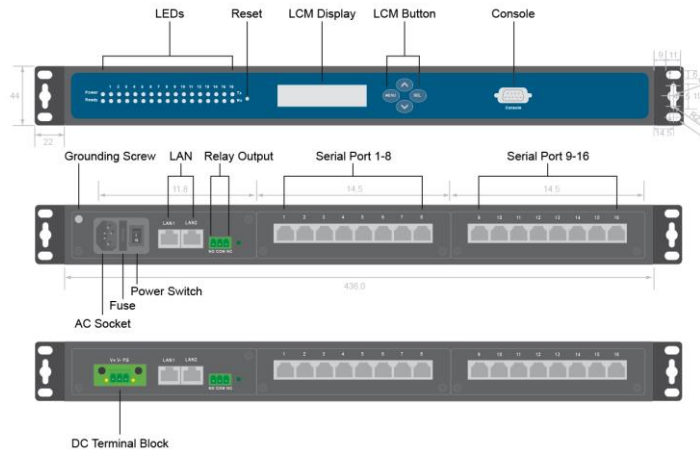

- MB5408A / MB5408A2-N / MB5416A / MB5416A2-N Industrial Modbus Gateway
- Hardware Installation Guide with Warranty Card
- Product CD
- 3-Pin 5.08mm Terminal Block
- 3-Pin 5.08mm Lockable Terminal Block (DC models only)
- RJ-45 to Male DB9 cable
- AC Power Cord (EU / US models only)
- Foot Rubbers
- Rack Mount Kit

Panel Layout



*MB5408A/A2-N has its serial ports 9-16 covered up compared to MB5416A/A2-N

LCM Display

Buttons	Function
	Open Main Menu or go back one level higher
	Scroll up
	Scroll down
	Confirm the selection. When working with IP addresses, pressing <SEL> means moving to the next digit

Installation Overview

1. Ground the device properly. If you are using the AC model, you can use the grounding screw next to the AC inlet. Else, if you are using the DC model, you can use the FG pin in the terminal block. It is required to connect to the grounds at all times to ensure overall maximum performance.
 2. If you opt to place the device on a rack, your will need to secure the rack mounts kit on to the device before placing it on the rack. If you opt to place the device on a surface, you can put on the foot rubbers to prevent the device from sliding.
 3. You can then choose whether to plug in the I/O ports at this point or do it later. Next you can then proceed to connect the device to the LAN (switch or PC), take care on using the RJ-45 connector; after this we can then proceed to the device's settings.
- The openings to the sides are for the devices heat dissipation. Please never obstruct or cover them with any objects.
 - The device server's factory IP by default is 10.0.50.100. You can access the device by its WebUI once it is connected to a physical network or use Serial Manager, for more information on Serial Manger, please refer to its manual. Please be aware that the PC needed for this procedure needs to be in the same subnet, or you may refer yourself to the device's manual on Web UI configuration.

Pin Assignments

Serial and RJ-45 Connectors

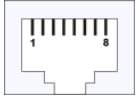
	Ethernet	RS-232	RS-422 /4-Wire RS-485	2-Wire RS-485
Pin 1	Tx+	RTS	-	-
Pin 2	Tx-	DTR ⁽¹⁾	TX-	-
Pin 3	Rx+	TXD	TX+	-
Pin 4	-	SG	SG	SG
Pin 5	-	SG	SG	SG
Pin 6	Rx-	RXD	RX+	Data+
Pin 7	-	DSR ⁽¹⁾	RX-	Data-
Pin 8	-	CTS	-	-

⁽¹⁾The isolated models does not have DTR/DSR available.

Serial and Male DB9 Connectors

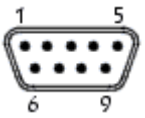
	RS-232	RS-422 /4-Wire RS-485	2-Wire RS-485
Pin 1	DCD	-	-
Pin 2	RXD	TXD+	-
Pin 3	TXD	RXD+	Data+
Pin 4	DTR	-	-
Pin 5	SG	SG	SG
Pin 6	DSR	-	-
Pin 7	RTS	RXD-	Data-
Pin 8	CTS	TXD-	-
Pin 9	RI	-	-

*This cable (RJ-45 to Male DB9) is included in the package.

LED Indicators

Name	Color	Status	Message
Power	Green	On	System is powered on
		Off	System is not powered on
Ready	Green	Blinking	AP firmware is running normally
		On/Off	System is not running normally
COM	Green	Blinking	Data is transmitting on COM port
		Off	No data is transmitting
LAN	Orange	On	Ethernet is connected at 100Mbps
		Off	Ethernet is connected at 10Mbps or Disconnected
	Green	Blinking	Data is transmitting on this port
		Off	Ethernet is Disconnected

Field Maintenance and Service

- If the device requires servicing of any kind, you may need to disconnect and remove it from its mounting. The initial installation should be done in a way that makes this as convenient as possible.
- Voltage/Power lines should be properly insulated as well as other cables. Be careful when handling them so as to not trip over.
- Do not under any circumstance insert foreign objects of any kind into the heat dissipation holes located in the different faces of the device. This may not only harm the internal layout, but might cause harm to you as well.
- Do not under any circumstance open the device for any reason. Please contact your dealer for any repair needed or follow the instructions on section of your manual.

Warranty Policy

Warranty Conditions

Products supplied by Atop Technologies are covered in this warranty for sub-standard performance or defective workmanship. The warranty is not, however, extended to goods damaged in the following circumstances:

- Excessive forces or impacts
- War or an Act of God: wind storm, fire, flood, electric shock, earthquake
- Use of unqualified power supply, connectors, or unauthorized parts/kits
- Replacement with unauthorized parts

RMA and Shipping Costs Reimbursement

Customers shall always obtain an authorized "RMA" number from Atop before shipping the goods to be repaired to Atop. When in normal use, a sold product shall be replaced with a new one within 3 months after purchase. The shipping cost from the customer to Atop will be reimbursed by Atop.

After 3 months and still within the warranty period, it is up to Atop whether to replace the unit with a new one; normally, as long as a product is under warranty, all parts and labor are free of charge to the customers.

After the warranty period, the customer shall cover the cost for parts and labor. Three months after purchase, the shipping cost from the customer to Atop will not be reimbursed, but the shipping cost from Atop to the customer will be paid by Atop.

Limited Liability

Atop shall not be held responsible for any consequential losses from using Atop's product.

Warranty Period

Product Categories	Warranty
Ethernet Switches	5 Years
Wireless	
Serial Device Servers	
Modbus Gateways	
Embedded Device Servers	
DIN-Rail Power Supplies	3 Years
Power Adaptors	1 Year
Antennas	
Other Accessories	

The Warranty Certification will not be effective until an authorized stamp issued by Atop's overseas agents.

Purchase Date: / / (yyyy/mm/dd)

Serial Number:

ATOP Customer Services and Supports

- Please contact your local dealers or Atop Technical Support Center at the following numbers.

+886-3-550-8137 (Atop Taiwan)
+86-21-6495-6232 (Atop China)

- Please report the defected problems via Atop's Web site or E-mail account

Web Site: www.atop.com.tw e-mail: service@atop.com.tw

Web Site: www.atop.com.cn e-mail: service@atop.com.cn

-Any changes to this material will be announced on Atop website.-