

SPECIFICATION

- Part No. : **WS.02.B.205111**
- Product Name : 4dBi 2.4GHz Omni-Directional
Heavy Duty Screw Mount Antenna
- Features : Wi-Fi/ISM Bands/ZigBee/WLAN/ Bluetooth
UV and Vandal Resistant ABS Housing
Cable length and connector customizable
IP67 & IP69K Waterproof Rating
2M CFD-200 SMA(M) – Standard
- RoHS Compliant**



1 Introduction

WS.02 Hercules is a high efficiency, high gain thread mount 2.4GHz wireless antenna for external use on vehicles and outdoor assets worldwide. Omni-directional gain across the frequency bands ensures constant reception and transmission making the WS.02 an ideal solution for a Zigbee Wireless Mesh for remote applications e.g. – remote metering.

It has been designed for heavy duty work with extra thick threads; with durable UV-resistant PC housing, it is resistant to vandalism and direct attack. At only 29 mm high it complies with the latest EU height restrictions directives for roof-mounted objects, whilst also enabling covert operation with a diameter of 49mm.

Many module manufacturers specify peak gain limits for any antennas that are to be connected to that module. Those peak gain limits are based on free-space conditions. In practice, the peak gain of an antenna tested in free-space can degrade by at least 1 or 2dBi when put inside a device. So ideally you should go for a slightly higher peak gain antenna than mentioned on the module specification to compensate for this effect, giving you better performance.

Upon testing of any of our antennas with your device and a selection of appropriate layout, integration technique, or cable, Taoglas can make sure any of our antennas' peak gain will be below the peak gain limits. Taoglas can then issue a specification and/or report for the selected antenna in your device that will clearly show it complying with the peak gain limits, so you can be assured you are meeting regulatory requirements for that module.

For example, a module manufacturer may state that the antenna must have less than 2dBi peak gain, but you don't need to select an embedded antenna that has a peak gain of less than 2dBi in free-space. This will give you a less optimized solution. It is better to go for a slightly higher free-space peak gain of 3dBi or more if available. Once that antenna gets integrated into your device, performance will degrade below this 2dBi peak gain due to the effects of GND plane, surrounding components, and device housing. If you want to be absolutely sure, contact Taoglas and we will test. Choosing a Taoglas antenna with a higher peak gain than what is specified by



the module manufacturer and enlisting our help will ensure you are getting the best performance possible without exceeding the peak gain limits.

The antenna housing is completely waterproof to IP67, and also to IP69K, which means it is waterproof against high pressure water jets used in industrial environments for cleaning. Low loss industrial coax cable is used to achieve high gain and efficiency over long cable length.

2 Specification

ELECTRICAL			
Frequency (GHz)	2.4	2.45	2.5
VSWR	1.38	1.80	1.89
Return Loss (dB)	-15.86	-10.87	-10.23
Peak Gain(dB)	4.42	4.16	4.75
Avg Gain (dB)	-2.48	-2.69	-1.98
Efficiency (%)	56.5	53.9	63.4
Impedance	50Ω		
Polarization	Linear		
Radiation Pattern	Omni		
Cable/Connectors	2M CFD-200 SMA(M)		
Recommended Mounting Torque	24.5N·m		
Maximum Mounting Torque	29.4N·m		
MECHANICAL			
Dimensions	Height 28.5mm x Diameter 47.8mm		
Casing	UV resistant PC		
Base and thread	Nickel plated Steel/Zinc		
Thread diameter	18mm		
Weather proof gasket	CR4305 foam with 3M9448B double-side adhesive		
Antenna Weight	0.13kg		
ENVIRONMENTAL			
Waterproof	IP67 & IP69K		
Corrosion	5% NaCl for 48hrs - Nickel plated steel base and thread		
Temperature Range	-40°C to +85°C		
Thermal Shock	100 cycles -40°C to +80°C		
Humidity	Non-condensing 65°C 95% RH		
Shock (drop test)	1m drop on concrete 6 axes		
Cable pull	8 KGf		

* Value above is for standard 2 meter CFD 200 cable tested in free space. The WS.02.B.205111 antenna performance was measured with CFD 200 coaxial cable at 300 mm, 1 meter, 2 meter, 3 meter and 5 meter length with and without a 30x30 cm ground plane.

3 Antenna Characteristics

3.1 Test set-up

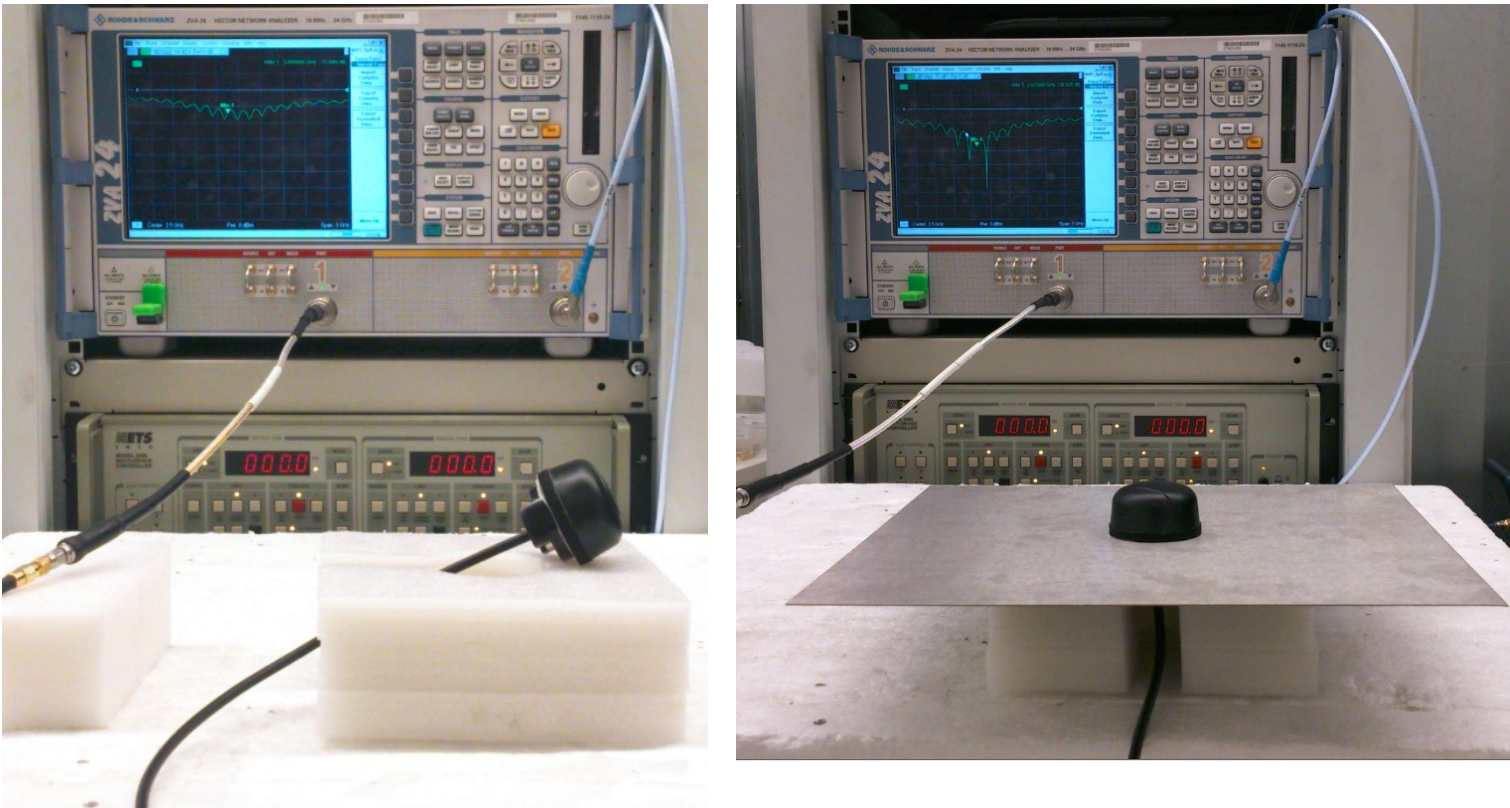

Figure 1. Return loss measurements.

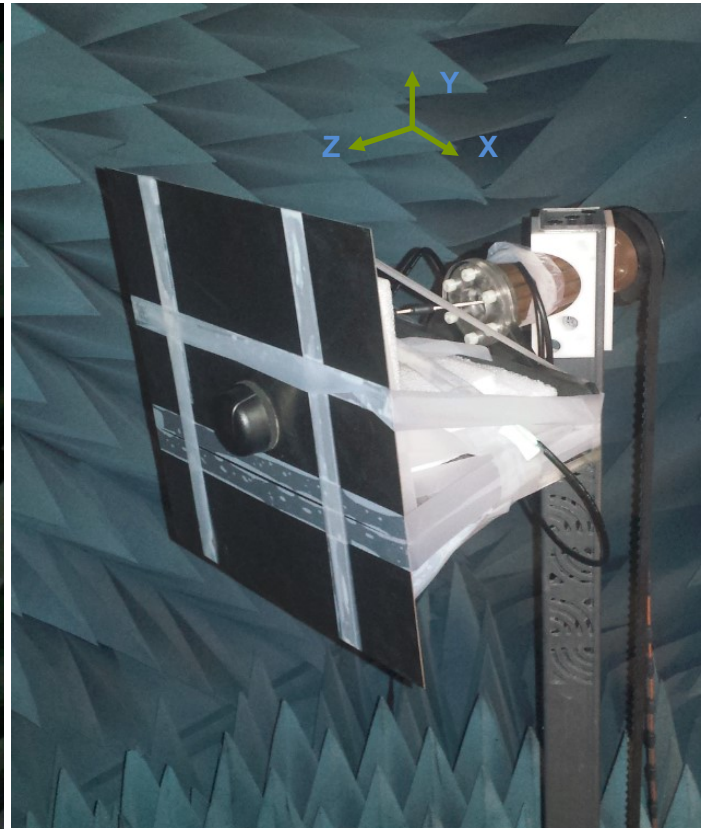
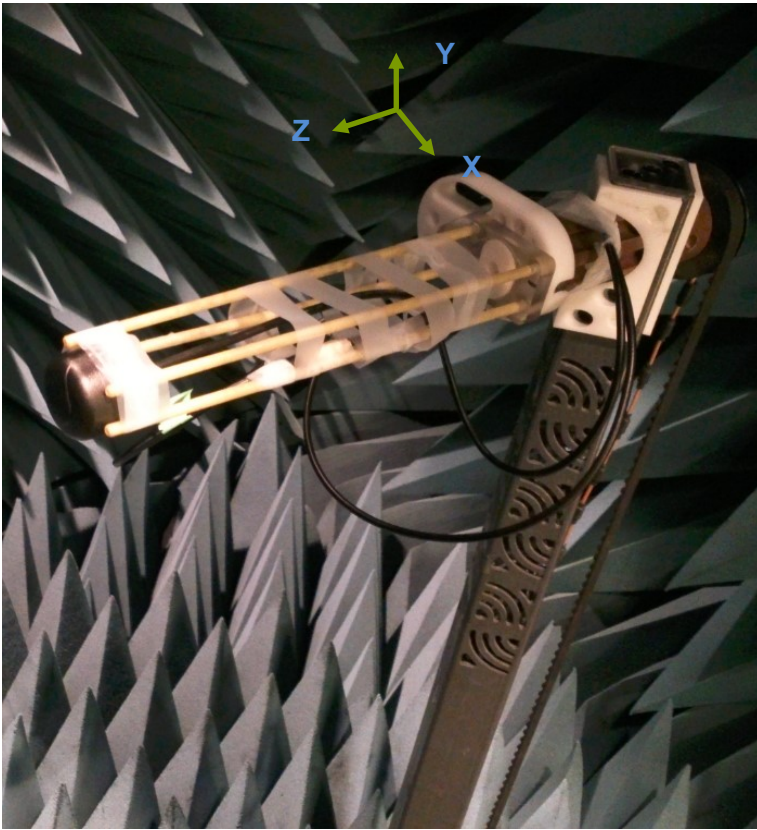

Figure 2. Peak gain, efficiency and radiation pattern measurements

3.2 Return Loss (in Free Space)

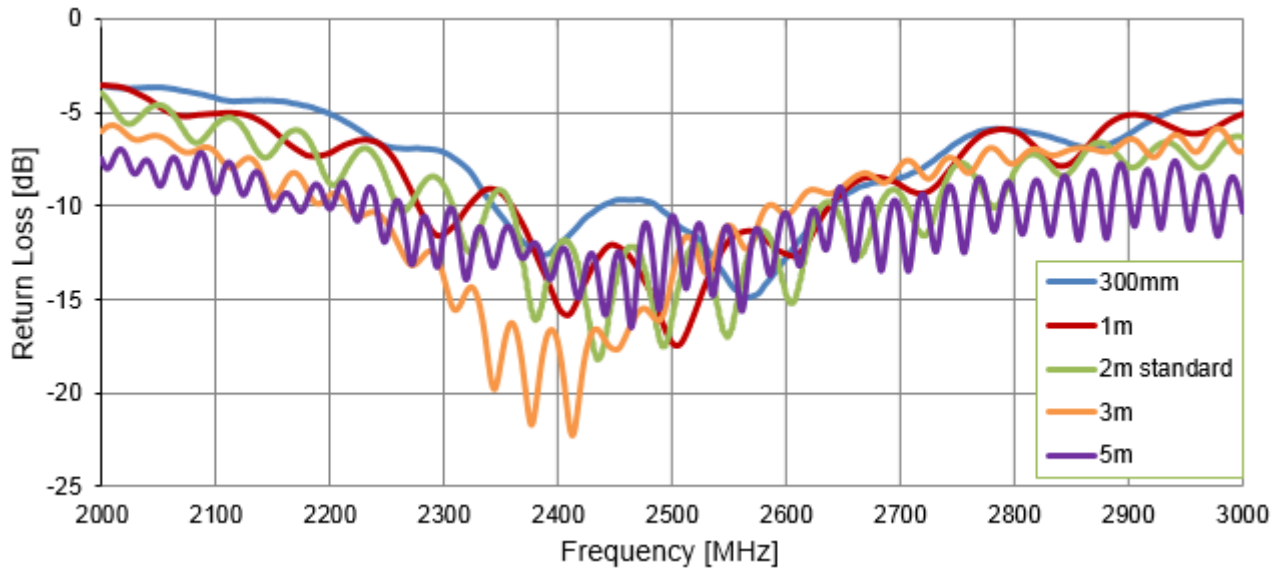

Figure 3. Return Loss of the Hercules WS.02 antenna with different length CFD200 cable in free space

3.3 Return Loss (on 30 x 30 cm Ground Plane)

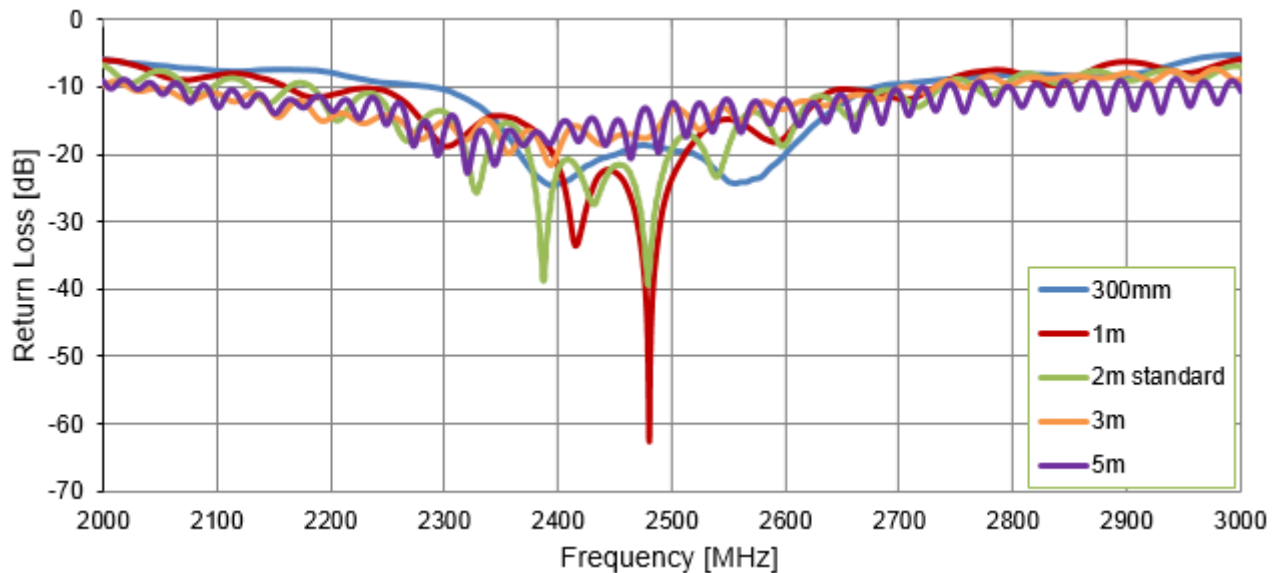

Figure 4. Return Loss of the Hercules WS.02 antenna with different length CFD200 cable on 30 x 30cm ground plane

3.4 VSWR (in Free Space)

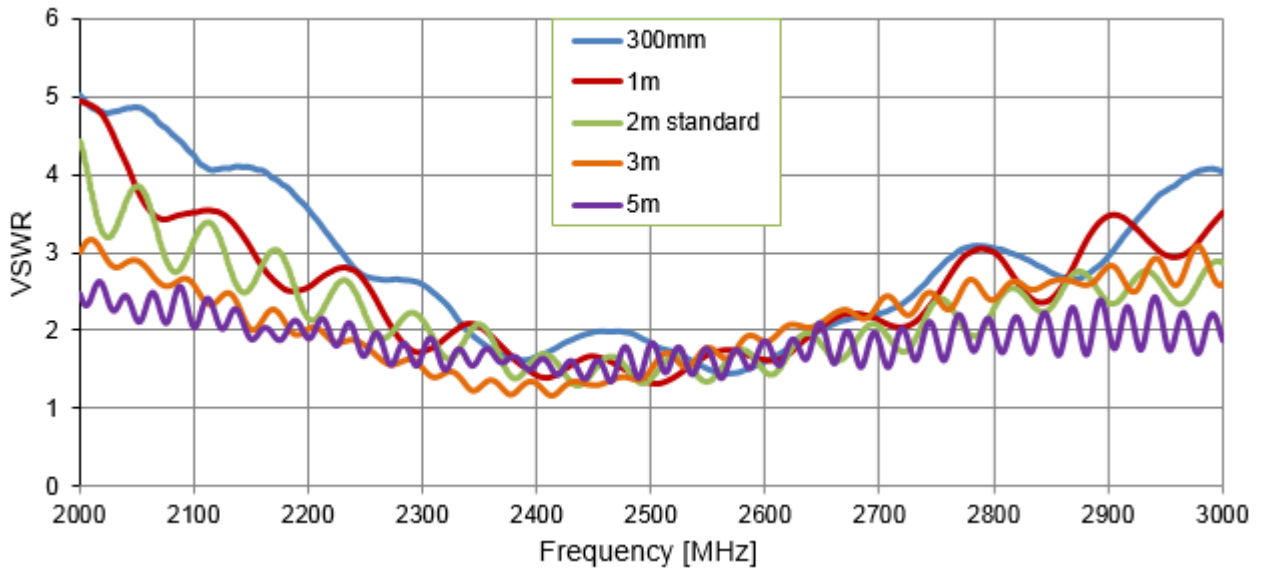

Figure 5. VSWR of the Hercules WS.02 antenna with different length CFD200 cable in free space

3.5 VSWR (on 30 x 30cm Ground Plane)

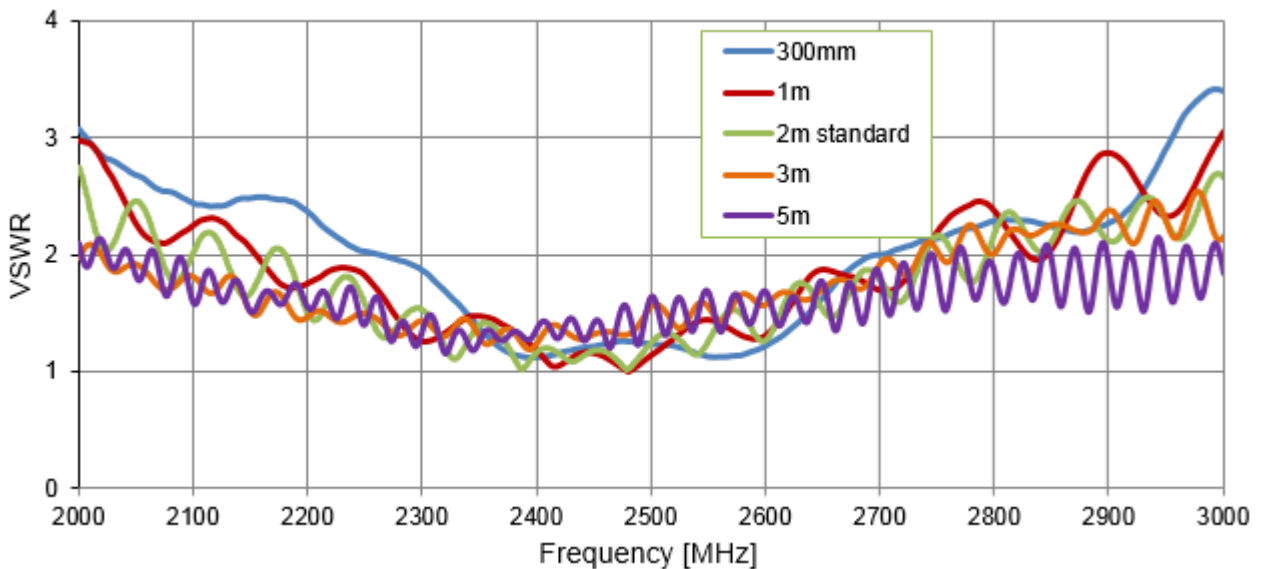

Figure 6. VSWR of the Hercules WS.02 antenna with different length CFD200 cable on 30 x 30cm ground plane

3.6 Efficiency (in Free Space)

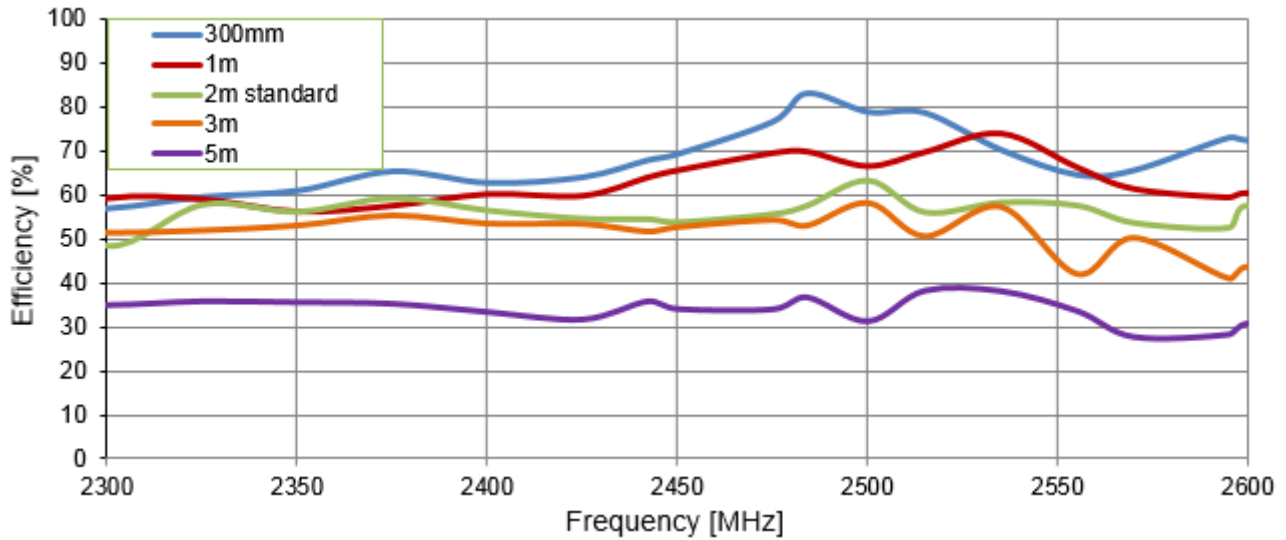

Figure 7. Efficiency of the Hercules WS.02 antenna with different length CFD200 cable in free space

3.7 Efficiency (on 30 x 30 cm Ground Plane)

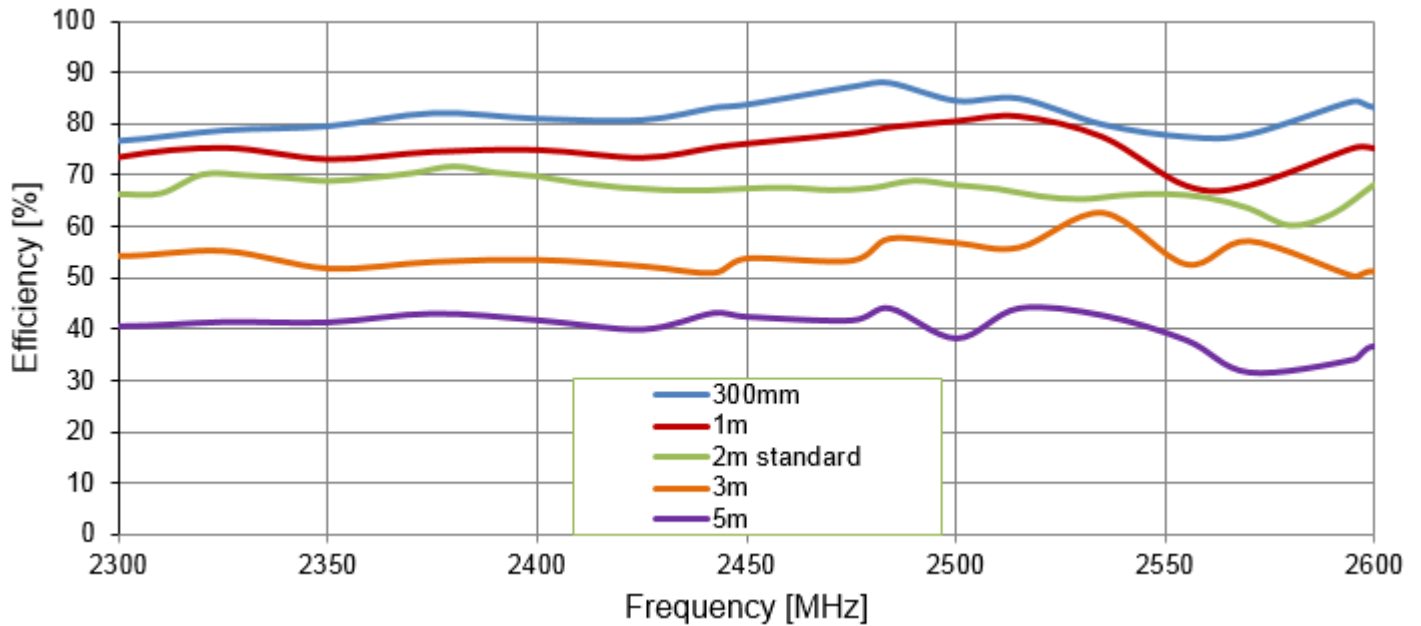

Figure 8. Efficiency of the Hercules WS.02 antenna with different length CFD200 cable on 30 x 30 cm ground plane

3.8 Peak Gain (in Free Space)

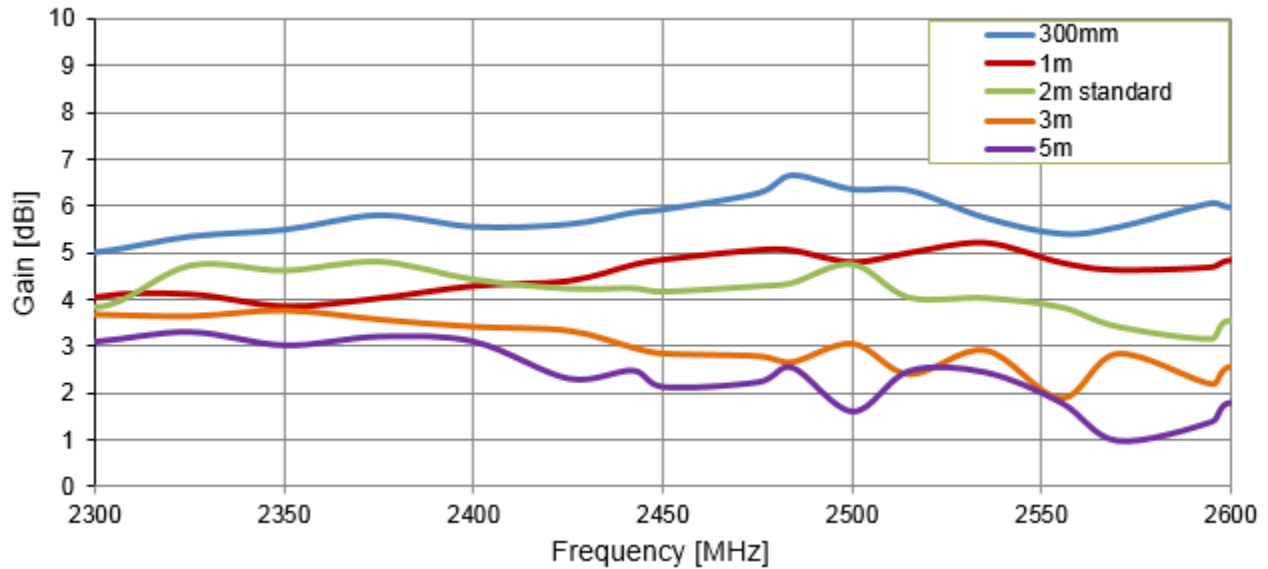

Figure 9. Peak Gain of the Hercules WS.02 antenna with different length CFD200 cable in free space

3.9 Peak Gain (on 30 x 30 cm Ground Plane)

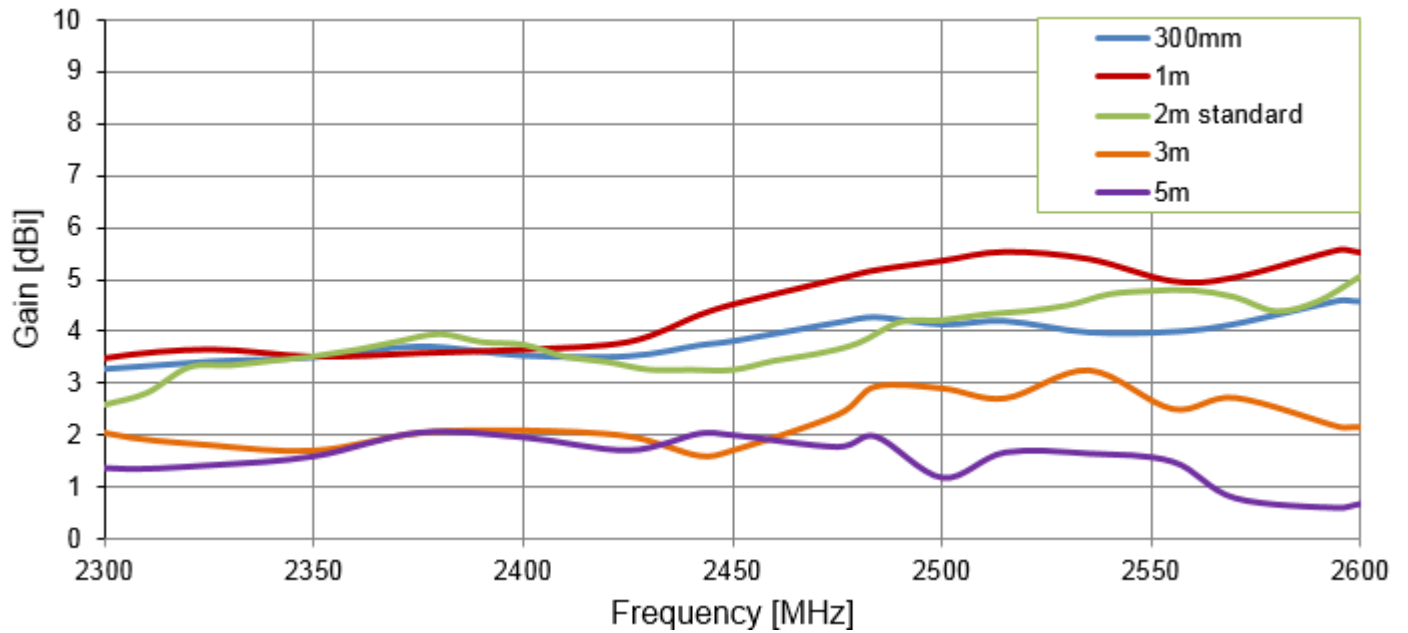

Figure 10. Peak Gain of the Hercules WS.02 antenna with different length CFD200 cable on 30 x 30 cm ground plane

3.10 Average Gain (in Free Space)

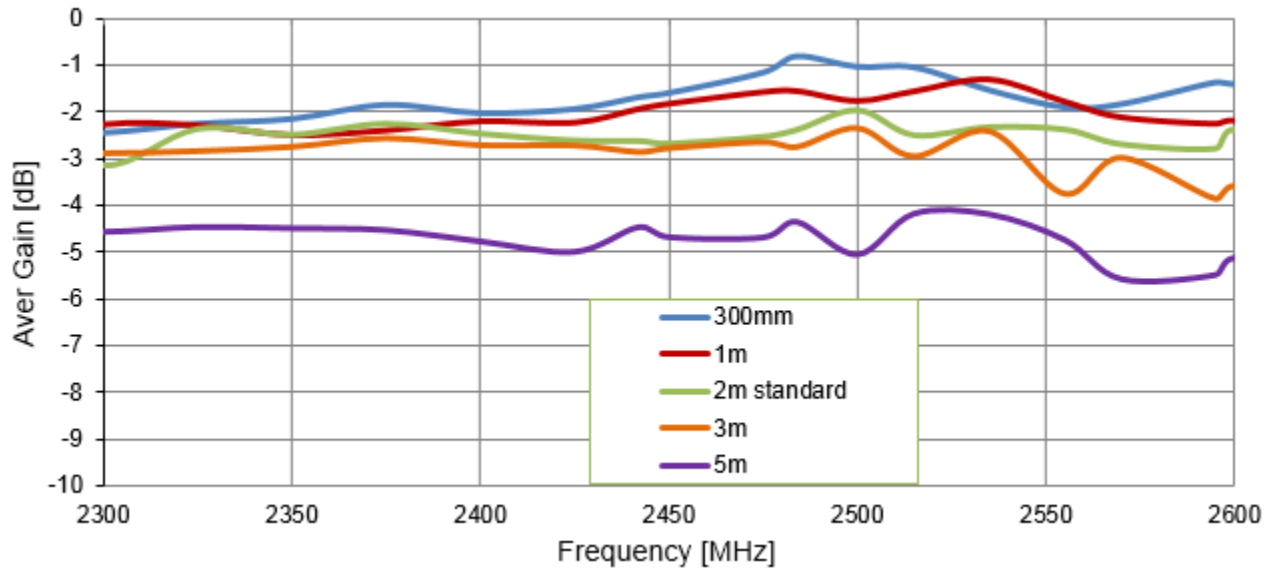

Figure 11. Average Gain of the Hercules WS.02 antenna with different length CFD200 cable in free space

3.11 Average Gain (on 30 x 30 cm Ground Plane)

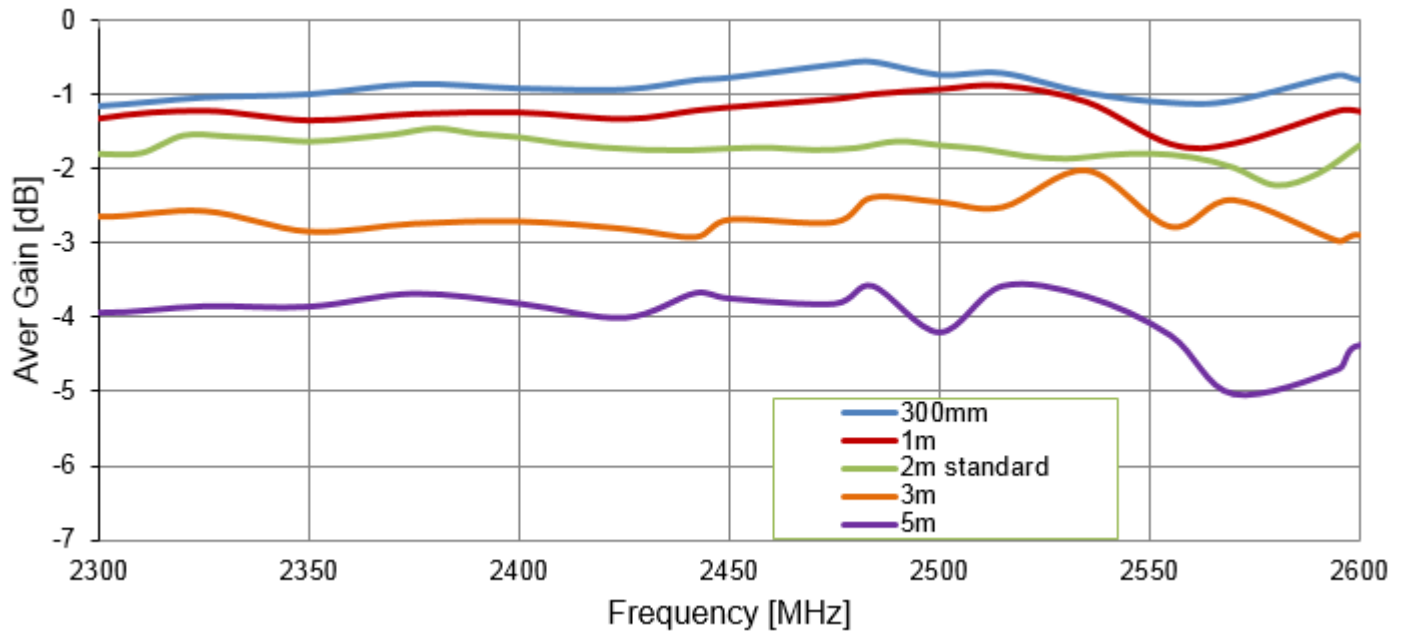

Figure 12. Average Gain of the Hercules WS.02 with different length CFD200 cable on 30 x 30 cm ground plane

3.12 Results Table (Free Space)

FREQUENCY [MHz]	EFFICIENCY [%]				
	300 MM	1 METER	2 METER	3 METER	5 METER
2200	58.4	55.5	45.9	55.6	32.4
2225	55.3	56.9	54.4	46.9	32.1
2250	55.1	54.5	54.4	50.8	34.2
2275	57.1	53.0	61.6	51.8	35.6
2300	57.1	59.0	48.4	51.4	35.0
2325	59.7	58.8	57.9	52.0	35.8
2350	61.1	56.0	56.3	53.1	35.6
2375	65.5	57.4	59.4	55.4	35.3
2400	62.9	60.0	56.5	53.	33.4
2425	64.2	59.6	54.7	53.4	31.7
2442	68.0	63.8	54.6	51.7	35.8
2450	69.5	65.4	53.9	52.7	34.1
2475	76.8	69.3	55.7	54.4	34.0
2484	83.3	69.7	57.7	53.1	36.7
2500	79.0	66.4	63.4	58.2	31.3
2515	78.8	69.6	56.1	50.7	38.2
2535	70.4	73.8	58.4	57.3	38.1
2555	64.7	66.1	57.7	42.1	33.6
2570	65.8	61.2	53.7	50.3	27.7
2595	73.2	59.3	52.6	41.1	28.3
2600	72.5	60.2	57.6	43.8	30.8
2650	69.1	53.5	42.7	40.4	30.4
2700	57.9	52.1	32.4	37.2	27.2

3.13 Results Table (on 30 x 30 cm Ground Plane)

FREQUENCY [MHz]	EFFICIENCY [%]				
	300 mm	1 meter	2 meter	3 meter	5 meter
2200	81.2	74.3	66.2	59.2	42.7
2225	76.1	72.8	66.4	51.7	40.6
2250	75.7	71.0	70.1	57.6	41.7
2275	76.2	68.2	70.0	56.0	41.6
2300	76.8	73.7	69.5	54.3	40.5
2325	78.8	75.5	68.8	55.2	41.3
2350	79.6	73.3	69.5	51.8	41.2
2375	82.2	74.7	70.4	53.1	42.9
2400	81.1	75.1	71.7	53.5	41.6
2425	80.8	73.6	70.5	52.3	39.8
2442	83.2	75.6	69.8	51.0	43.0
2450	83.8	76.3	68.4	53.8	42.3
2475	87.3	78.3	67.6	53.4	41.6
2484	88.0	79.5	67.1	57.6	44.0
2500	84.5	80.7	67.0	56.8	38.1
2515	85.0	81.6	67.4	55.9	44.0
2535	79.9	77.6	67.5	62.7	42.6
2555	77.5	68.1	67.1	52.6	37.7
2570	78.0	68.2	67.5	57.2	31.4
2595	84.5	75.5	68.9	50.3	34.0
2600	83.2	75.4	68.0	51.3	36.6
2650	76.1	64.8	67.3	43.3	36.9
2700	68.5	66.1	65.8	41.2	31.4

3.14 3D Radiation Patterns (2 meter Standard cable, Free Space)

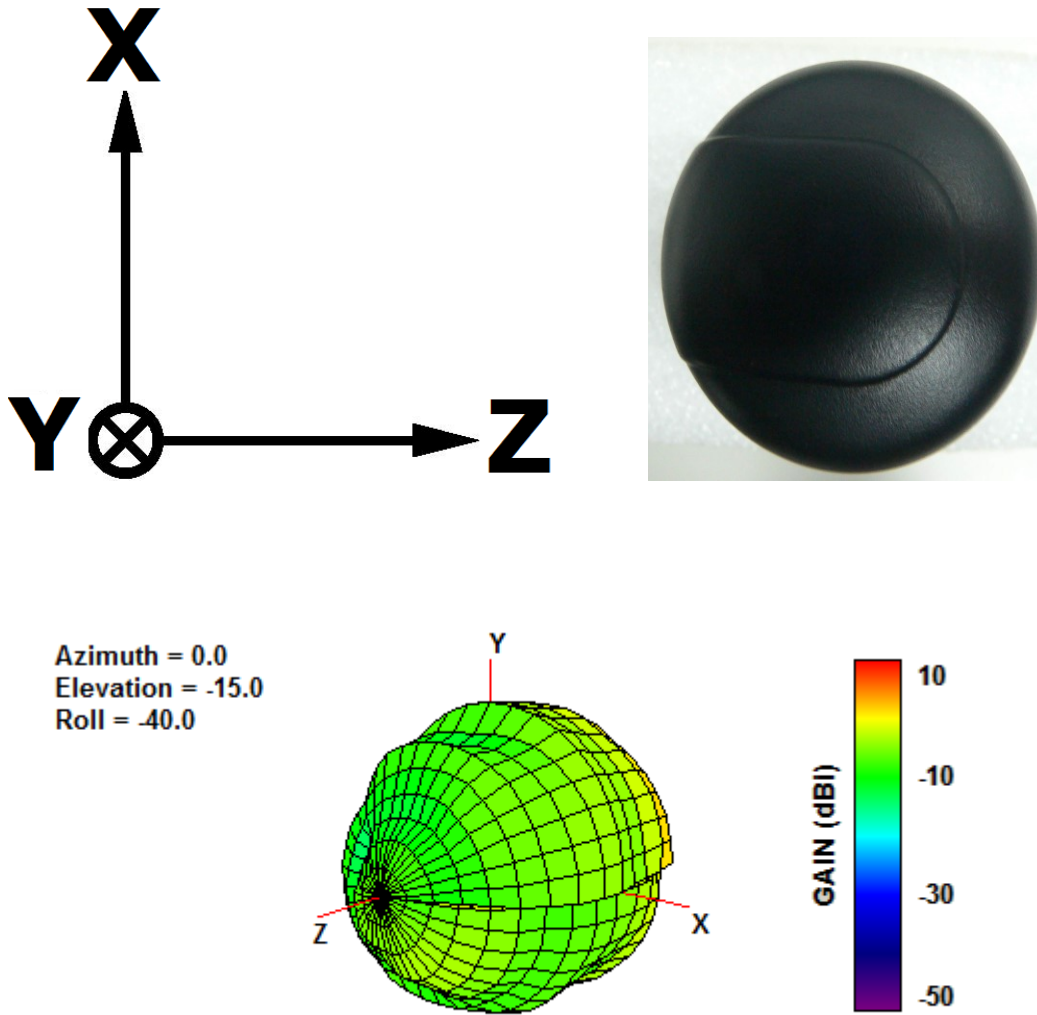
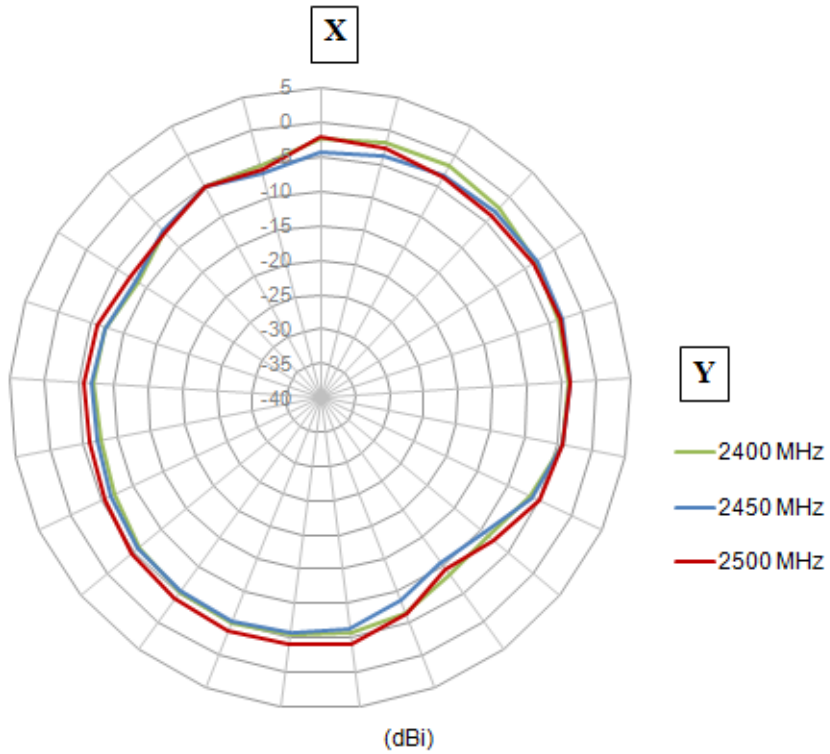

Figure 13. 3D Radiation Pattern at 2450 MHz of the WS.02 Antenna with standard 2 meter cable

3.15 2D Radiation Patterns (2 meter Standard cable, Free Space)

XY Plane



XZ Plane

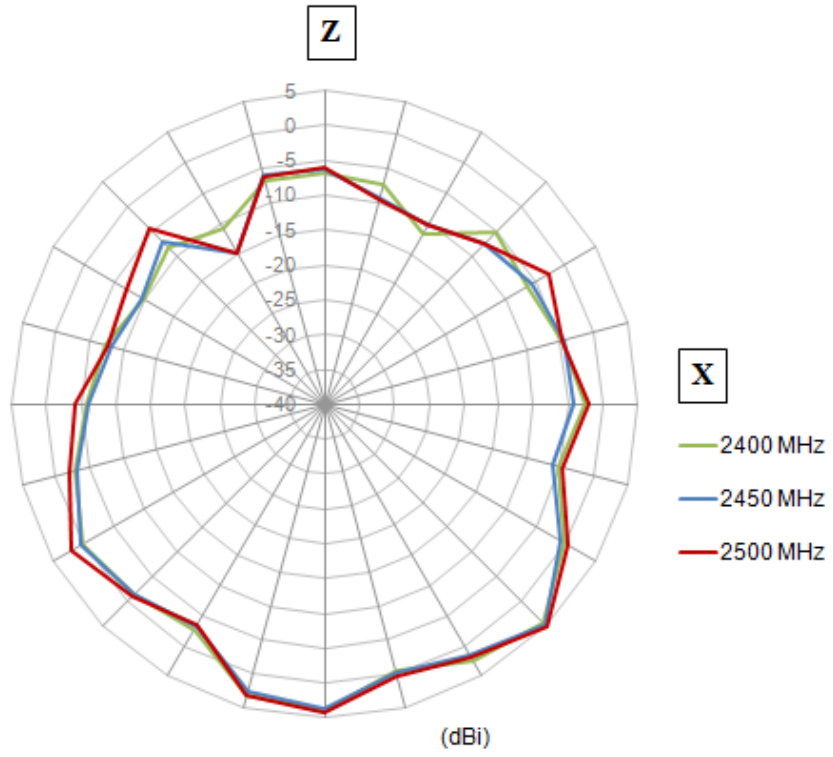

YZ Plane

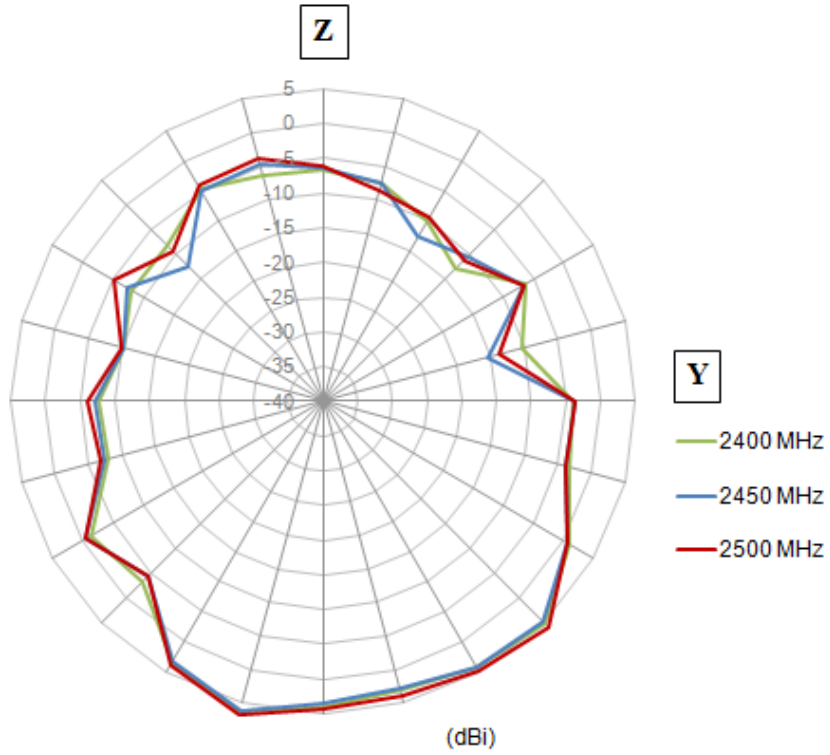
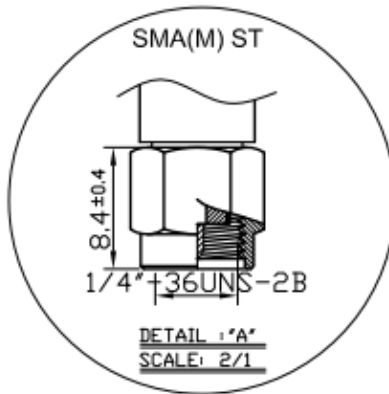
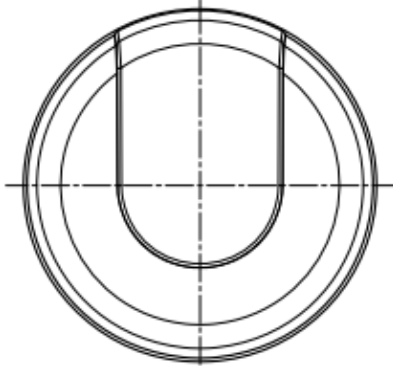

Figure 14. 2D Radiation Pattern of the WS.02 Antenna with standard 2 meter cable

4 Technical Drawing

Top View



Front View

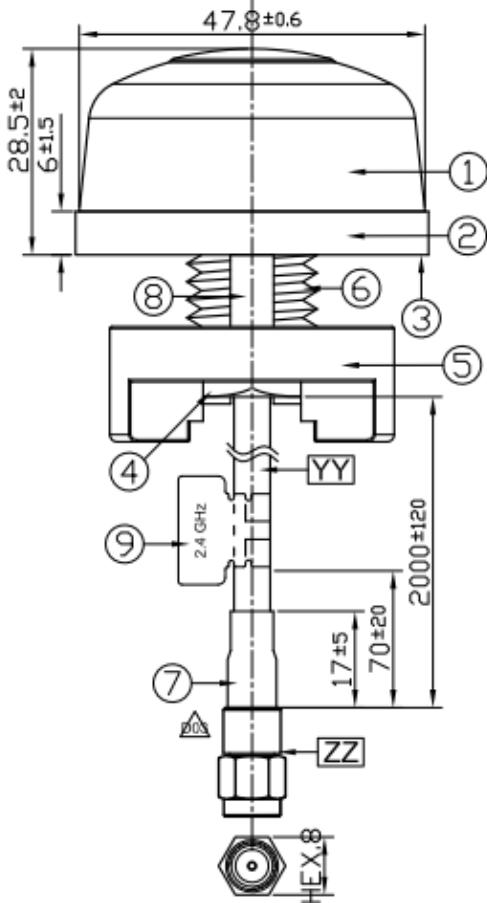

Side View

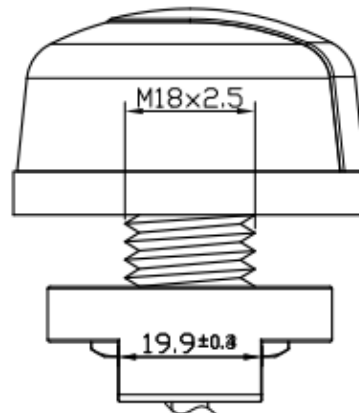

Bottom Thread View

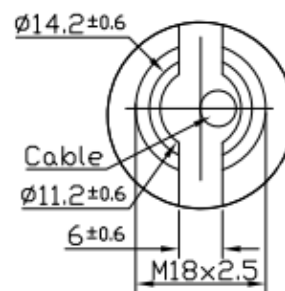

	Name	Material	Finish	QTY
1	Housing	PC	Black	1
2	Closed Cell Foam	CR 4305	Black	1
3	3M Double Adhesive	3M 9448 HK	White Liner	1
4	M18 Inner Nut	Steel Carbon	Ni Plated	1
5	Outer Nut Cover	ABS	Black	1
6	M18x2.5 Thread 14.6L	Zinc Alloy	Ni Plated	1
7	Heat Shrink Tube	PE	Black	1
8	Rubber Stopper	Rubber	Black	1
9	2.4 GHz Label	Coated Paper	Light Green	1
	Name	Spec	Finish	QTY
YY	Cable Type	CFD-200	Black	1
ZZ	Connector Type	SMA(M) ST	Gold	1

Figure 15. Technical Drawing

5 Installation

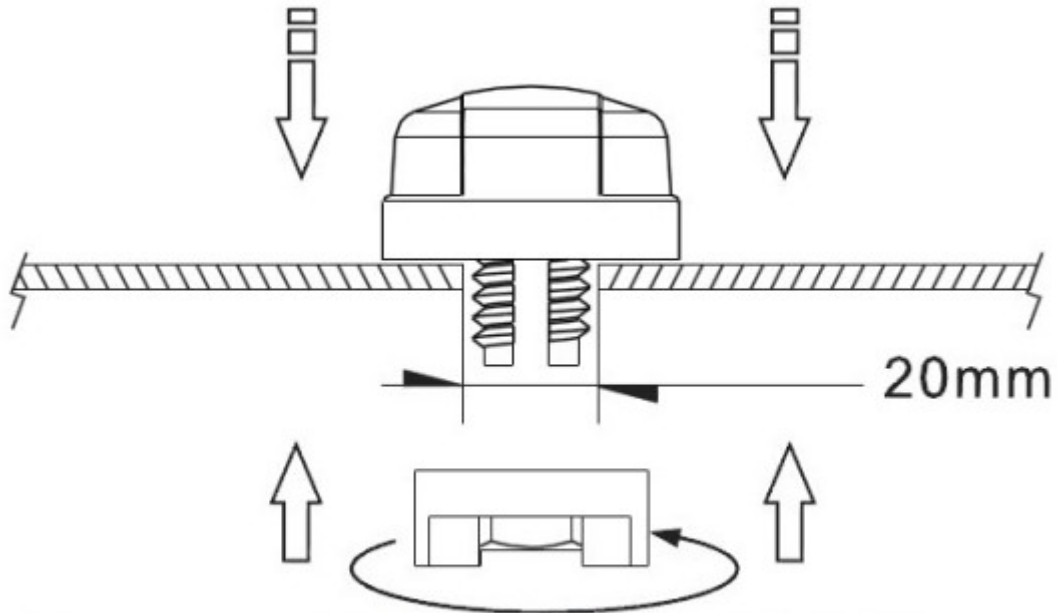

Recommended torque for Mounting is 24.5N·m
Maximum torque for mounting is 29.4 N·m



Figure 16. Installation

6 Packaging

1pc per PE Bag (Weight 0.13Kg)

40 PE Bags per Carton

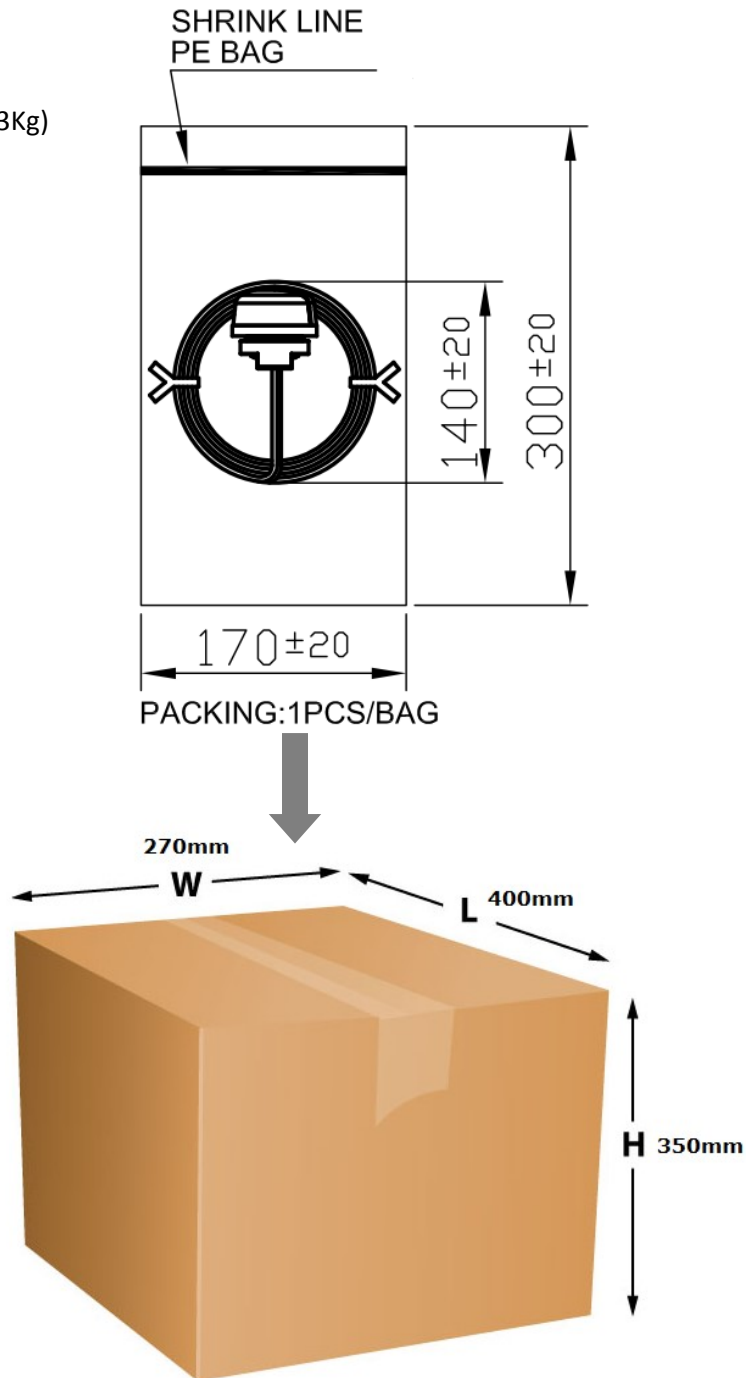

Figure 17. Packaging

Taoglas makes no warranties based on the accuracy or completeness of the contents of this document and reserves the right to make changes to specifications and product descriptions at any time without notice. Taoglas reserves all rights to this document and the information contained herein.

Reproduction, use or disclosure to third parties without express permission is strictly prohibited.

Copyright © Taoglas Ltd.