

User Guide for  
FEBFAN302HL\_CH442v1  
Evaluation Board

FAN302HL 5V / 1A PSR Mobile Phone  
Battery Charger

Featured Fairchild Product:  
FAN302HL

***Direct questions or comments  
about this Evaluation Board to:  
“Worldwide Direct Support”***

***[Fairchild Semiconductor.com](http://Fairchild Semiconductor.com)***

## Table of Contents

1. General Introduction .....	3
1.1. General Specification .....	3
2. Function Check Report .....	3
2.1. Input Current .....	4
2.2. Input Wattage at No-load Condition .....	4
2.3. Startup Time .....	6
2.4. DC Output Rising Time .....	7
2.5. Line and Load Regulation .....	9
2.6. Efficiency .....	9
2.7. Output Ripple and Noise .....	10
2.8. Step Response .....	12
2.9. Over-Power Protection .....	13
2.10. Hold-up Time .....	13
2.11. Short-Circuit Protection .....	15
2.12. Brownout Test .....	16
2.13. $V_{DD}$ Voltage Level .....	16
2.14. Voltage Stress on MOSFET and Rectifiers .....	20
2.15. Constant Voltage (CV) and Constant Current (CC) Curves .....	21
2.16. $V_S$ OVP Test .....	22
2.17. Over-Temperature Protection Test (OTP) .....	23
2.18. EMI Test .....	24
2.19. Surge Test .....	25
2.20. ESD Test .....	25
3. Photographs .....	26
4. Schematic .....	27
5. PCB Layout .....	28
6. Bill of Materials .....	29
7. Transformer Specification .....	30
7.1. Specification Approval .....	30
8. Revision History .....	34

## 1. General Introduction

This document describes a 5W power supply using a FAN302HL device. This power supply is targeted for mobile phone battery chargers with a 10mW solution and requiring high efficiency.

To get the standby power consumption lower than 10mW at 230V<sub>AC</sub>, the FAN302HL has functions to enhance the standby power consumption, including proprietary Burst Mode with lower operation current under light-load conditions and built-in HV startup circuitry in the IC side to reduce startup resistor power loss.

Using FAN302HL, a charger can be implemented with the few external components and minimized cost.

### 1.1. General Specification

Specification	Min.	Normal	Max.	Units
<b>Input</b>				
Voltage	90		264	V <sub>RMS</sub>
Frequency	47		63	Hz
<b>Output</b>				
Output Voltage 1	4.75	5.00	5.25	V
Output Current 1	1.0	1.2	1.4	A
<b>Total Output Power</b>				
Full-Load Output Power	4.75	6.00	7.35	W

## 2. Function Check Report

<b>Test Model</b>	FEBFAN302HL_CH442v1
<b>Test Date</b>	March 2011
<b>Test Temperature</b>	Ambient
<b>Test Equipment</b>	AC source: 6800 AC POWER SOURCE Electronic Load: Chroma 63030 and 63102 Power Meter: WT210 Oscilloscope: LeCory 24Xs-A
<b>Test Items</b>	<ol style="list-style-type: none"> <li>1. Input current</li> <li>2. Input wattage at no-load condition</li> <li>3. Startup time</li> <li>4. DC-output rising time</li> <li>5. Line and load regulation</li> <li>6. Efficiency</li> <li>7. Output ripple and noise</li> <li>8. Step response</li> <li>9. Over power protection</li> <li>10. Hold-up time</li> <li>11. Short-circuit protection</li> <li>12. Brownout test</li> <li>13. V<sub>DD</sub> voltage level</li> </ol>

	14. Voltage stress on MOSFET and rectifiers 15. Constant voltage (CV) and constant current (CC) curve 16. VS OVP test 17. OTP test 18. EMI test 19. Surge test 20. ESD test
--	---

## 2.1. Input Current

### 2.1.1. Test Condition

Measure the AC input current at maximum loading.

### 2.1.2. Test Result

Input Voltage	Input Current (mA)	Specification
90V / 60Hz	120.20	
264V / 50Hz	51.57	

## 2.2. Input Wattage at No-load Condition

### 2.2.1. Test Condition

Measure the input wattage and output voltage at no load.

### 2.2.2. Test Result

Input Voltage	Input Wattage (mW)	Output Voltage (V)	Specification
90V / 60Hz	6.3	5.116	<10mW
115V / 60Hz	6.5	5.116	
230V / 50Hz	7.3	5.116	
264V / 50Hz	9.0	5.116	

### 2.2.3. Measured Waveforms

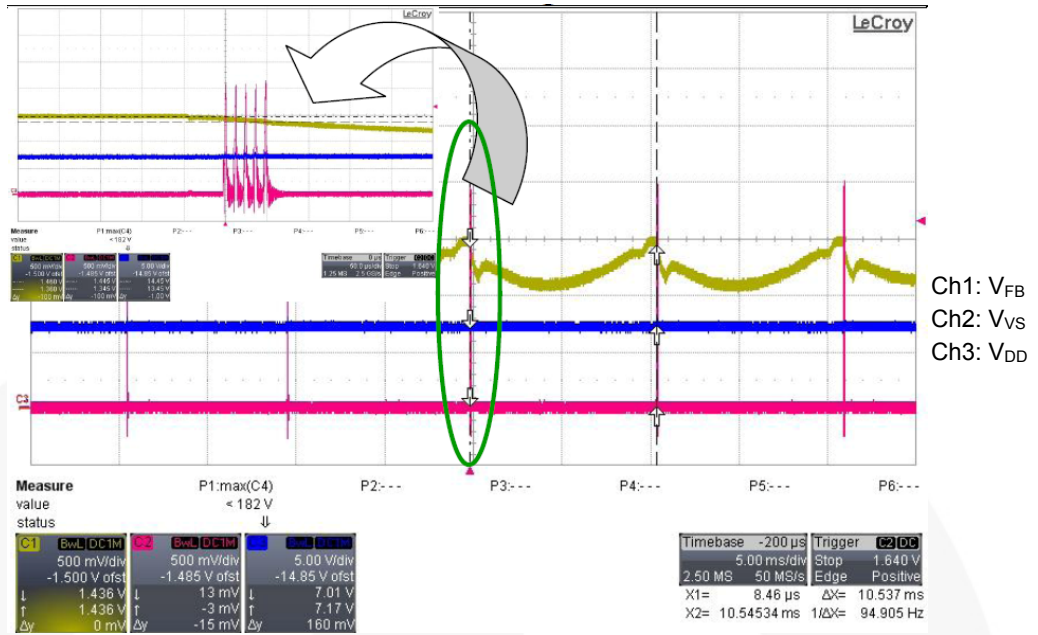

Figure 1. 90V / 60Hz at No Load

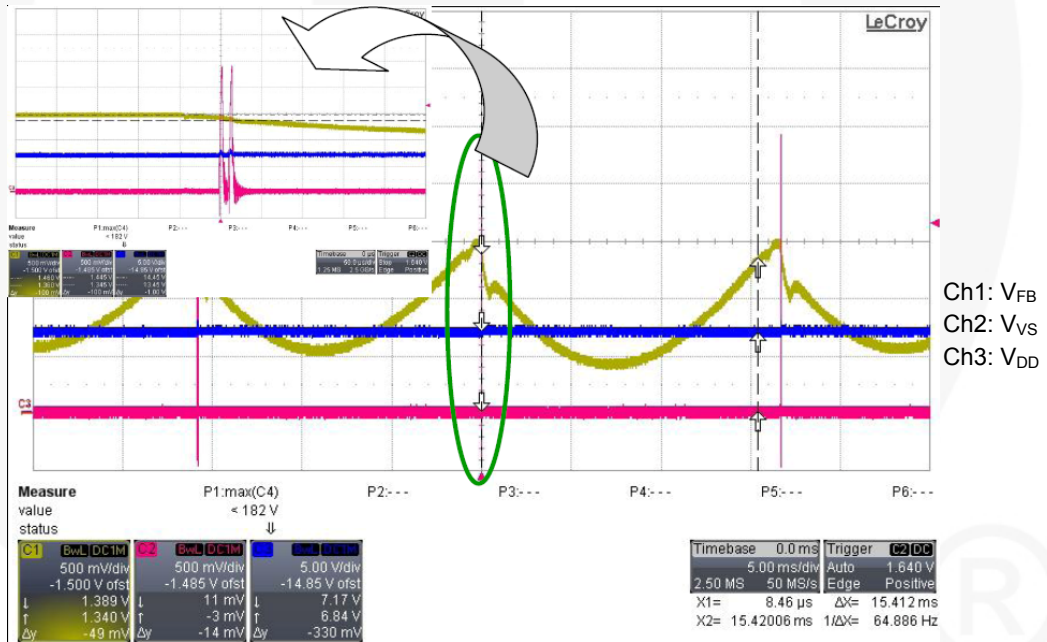

Figure 2. 264V / 50Hz at No Load

## 2.3. Startup Time

### 2.3.1. Test Condition

Set output at maximum loading. Measure the interval between AC plug-in and stable output.

### 2.3.2. Test Result

Input Voltage	Startup Time (ms)	Specification
90V / 60Hz	249	<3s
264V / 50Hz	236	

### 2.3.3. Measured Waveforms

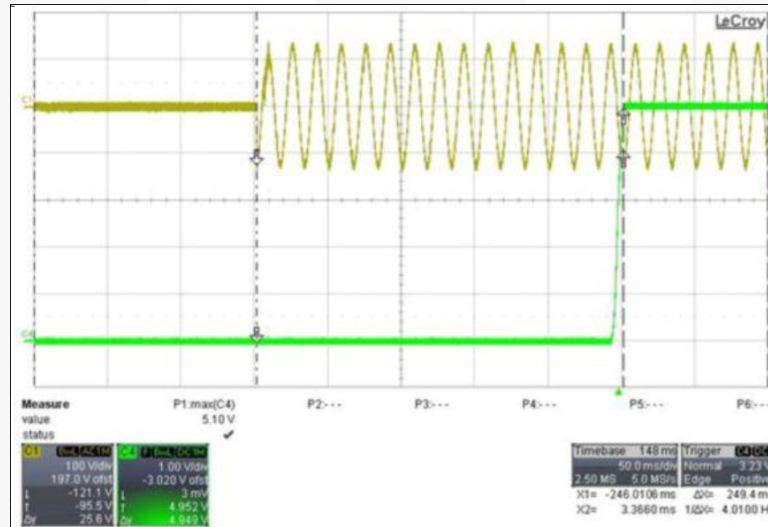

Figure 3. 90V / 60Hz at Maximum Load

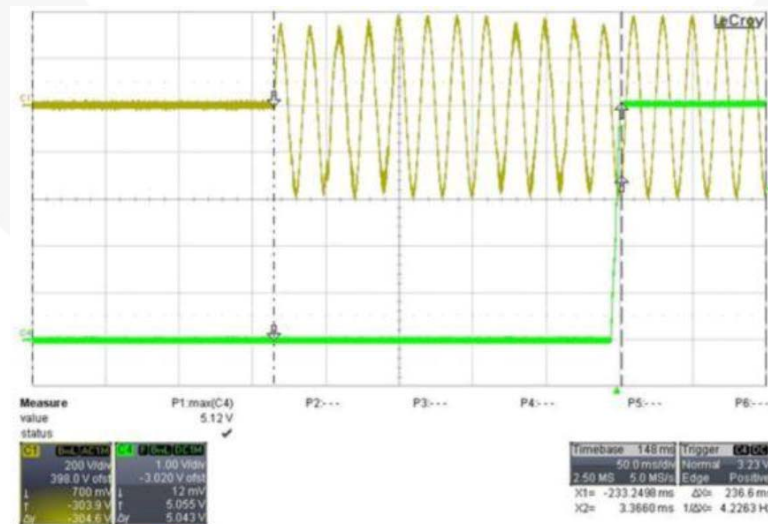

Figure 4. 264V / 50Hz at Maximum Load

## 2.4. DC Output Rising Time

### 2.4.1. Test Condition

Set output at maximum loading and no loading. Measure the time interval between 10% and 90% output during startup.

### 2.4.2. Test Result

Input Voltage	Maximum Load (ms)	No Load (ms)	Specification
90V / 60Hz	4.841	3.185	<20ms
264V / 50Hz	4.882	3.229	

### 2.4.3. Measured Waveforms

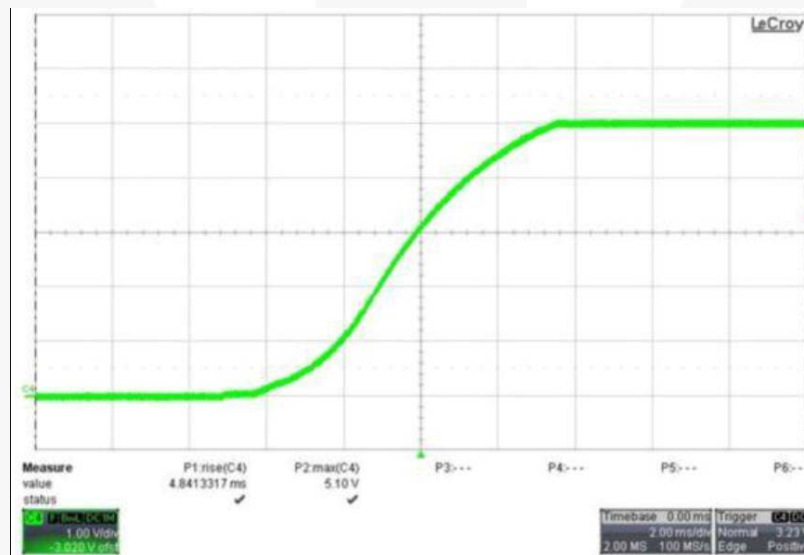

Figure 5. 90V / 60Hz at Maximum Load

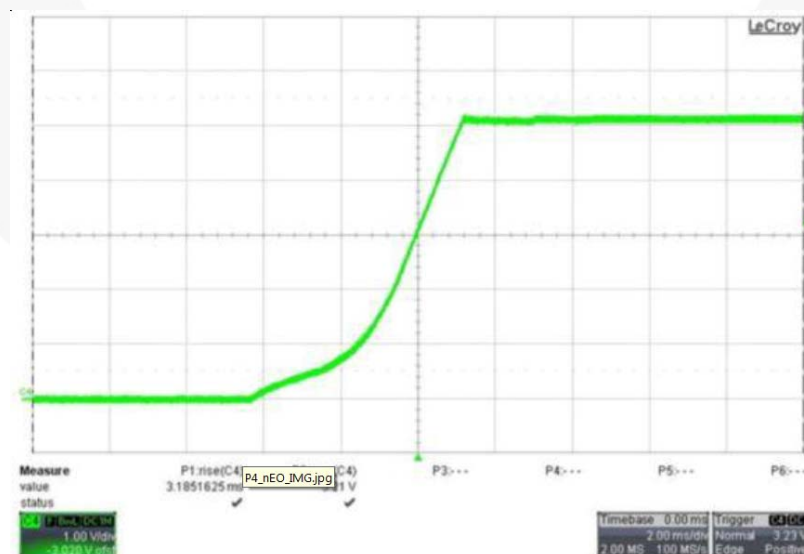
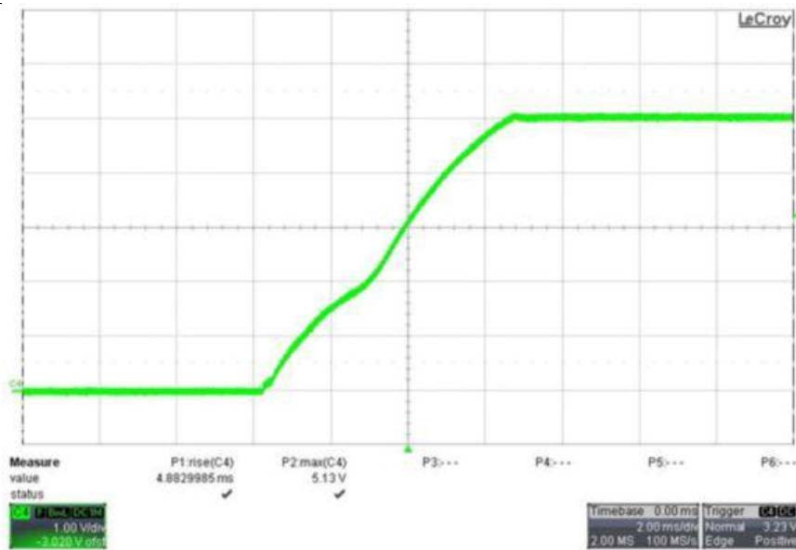
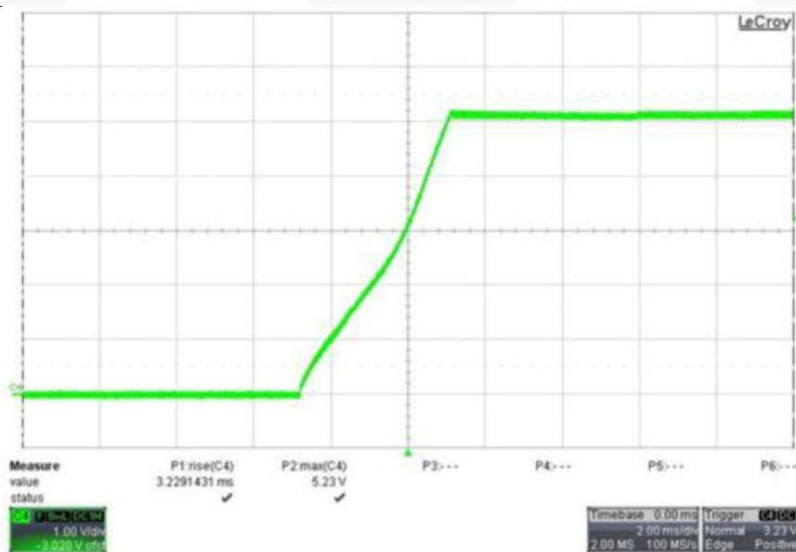

Figure 6. 90V / 60Hz at No Load



Ch4: V<sub>o</sub>

Figure 7. 264V / 50Hz at Maximum Load



Ch4: V<sub>o</sub>

Figure 8. 264V / 50Hz at No Load



## 2.5. Line and Load Regulation

### 2.5.1. Test Condition

Measure line and load regulation as shown in the table below.

### 2.5.2. Test Result

Input Voltage	Output V at Max. Load (V)	Output V at Min. Load (V)	Load Regulation (%)	Specification
90V / 60Hz	4.990	5.116	2.46	
115V / 60Hz	4.994	5.116	2.38	
132V / 60Hz	4.998	5.116	2.31	
180V / 50Hz	5.006	5.112	2.07	
230V / 50Hz	5.018	5.112	1.84	
264V / 50Hz	5.022	5.112	1.76	
Line Regulation(%)	0.64	0.078		

## 2.6. Efficiency

### 2.6.1. Test Condition

Measure input wattage and output wattage at maximum load.

### 2.6.2. Test Result

Input Voltage	Input Wattage (W)	Output Wattage (W)	Efficiency (%)	Specification
90V / 60Hz	6.938	4.980	71.78	
115V / 60Hz	6.808	4.990	73.30	
132V / 60Hz	6.748	4.994	74.01	
180V / 50Hz	6.719	5.006	74.51	
230V / 50Hz	6.743	5.016	74.39	
264V / 50Hz	6.797	5.024	73.91	

### 2.6.3. Average Efficiency Test Result

Input Voltage	Efficiency(%)					Avg.	Spec.
	25% Load	50% Load	75% Load	100% Load			
115V / 60Hz	76.06%	75.34%	75.45%	73.30%	74.79%	Avg>68.17%	
230V / 50Hz	72.91%	73.52%	74.28%	74.39%	73.78%		

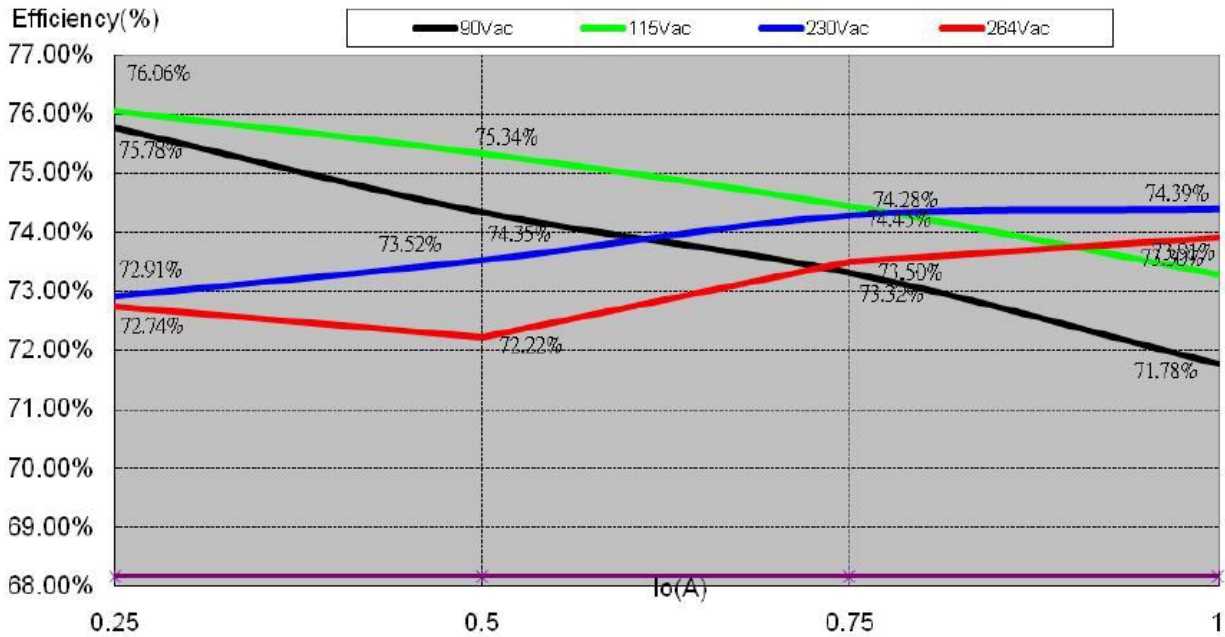

Figure 9. Efficiency Chart

## 2.7. Output Ripple and Noise

### 2.7.1. Test Condition

Ripple and noise are measured using a 20MHz bandwidth-limited oscilloscope with a 10μF capacitor paralleled with a high-frequency 0.1μF capacitor across each output.

### 2.7.2. Test Result

Input Voltage	Max. Load (mV)	Before Leaving Burst Mode (mV)	Min. Load (mV)	Spec.
90V / 60Hz	38	56	15	<150mV
115V / 60Hz	34	52	16	
230V / 50Hz	33	57	25	
264V / 50Hz	32	65	22	

### 2.7.3. Measured Waveforms

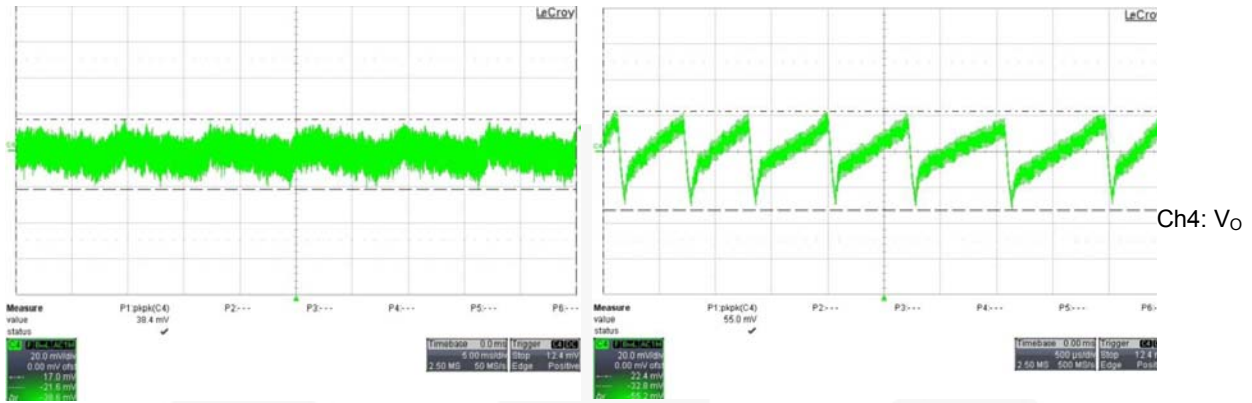

**Figure 10. 90V / 60Hz at Maximum Load AC and Burst Ripple**

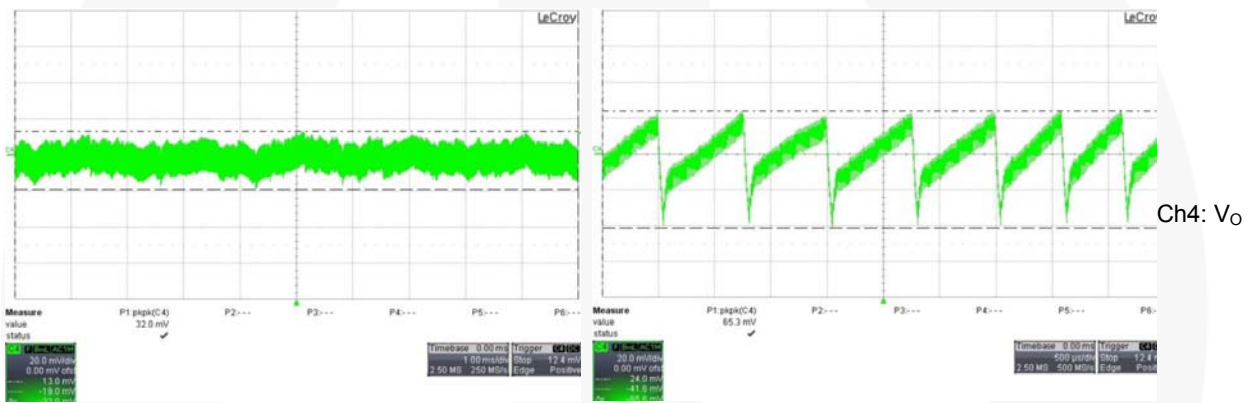

**Figure 11. 264V / 50Hz at Maximum Load AC and Burst Ripple**

## 2.8. Step Response

### 2.8.1. Test Condition

Dynamic loading (20%–80%) of the full load, 5ms duty cycle, 2.5A/ $\mu$ s rise/fall time).

### 2.8.2. Test Result

Input Voltage	Overshoot (mV)	Undershoot (mV)	Specification
115V / 60Hz	105.6	112.0	
230V / 50Hz	93.6	86.4	

### 2.8.3. Measured Waveforms

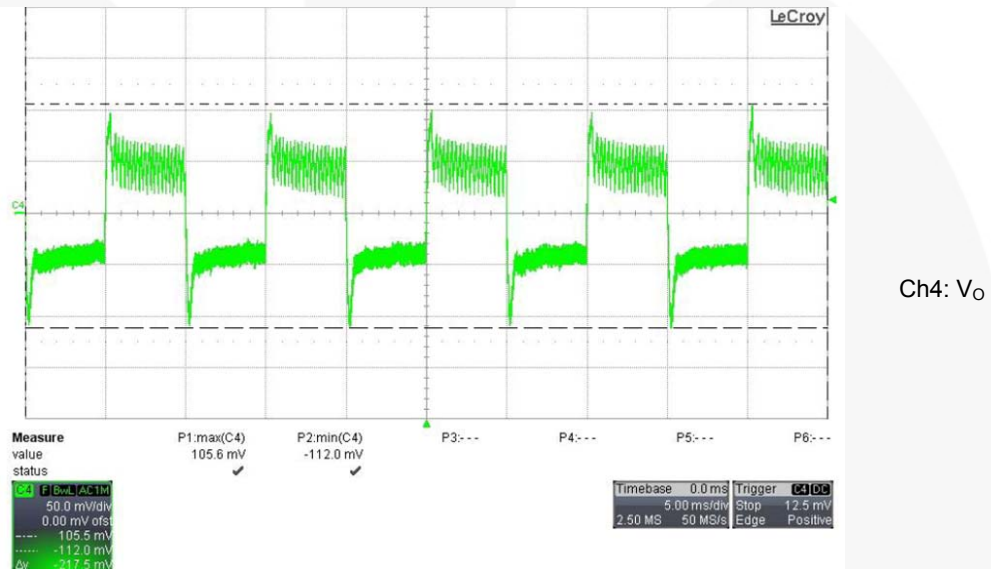

Figure 12. 115V / 60Hz at Step Response

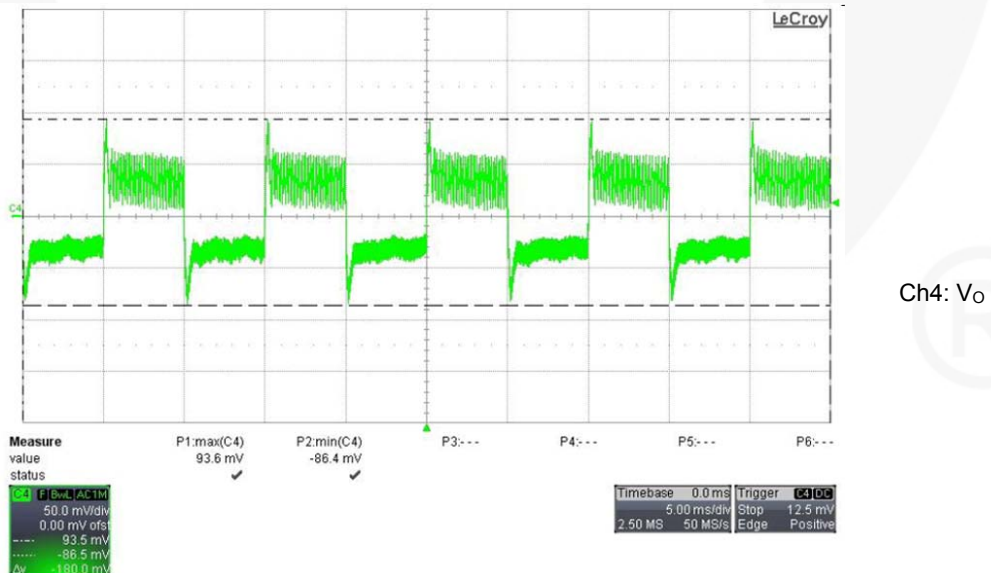

Figure 13. 230V / 50Hz at Step Response

## 2.9. Over-Power Protection

### 2.9.1. Test Condition

Increase output loading gradually. Measure the output maximum power.

### 2.9.2. Test Result

Input Voltage	Output Power (W)	Specification
90V / 60Hz	6.00 (4.932V / 1.216A)	
115V / 60Hz	6.05 (4.952V / 1.224A)	
230V / 50Hz	6.38 (4.958V / 1.290A)	
264V / 50Hz	6.40 (4.976V / 1.293A)	

## 2.10. Hold-up Time

### 2.10.1. Test Condition

Set output at maximum load. Measure the time interval between AC off and output voltage falling to the lower limit of the rated value. The AC waveform should be off at zero degrees.

### 2.10.2. Test Result

Input Voltage	Hold-up Time (ms)	Specification
90V / 60Hz	11.84	
115V / 60Hz	26.06	
230V / 50Hz	108.7	
264V / 50Hz	149.5	

2.10.3. Measured Waveforms

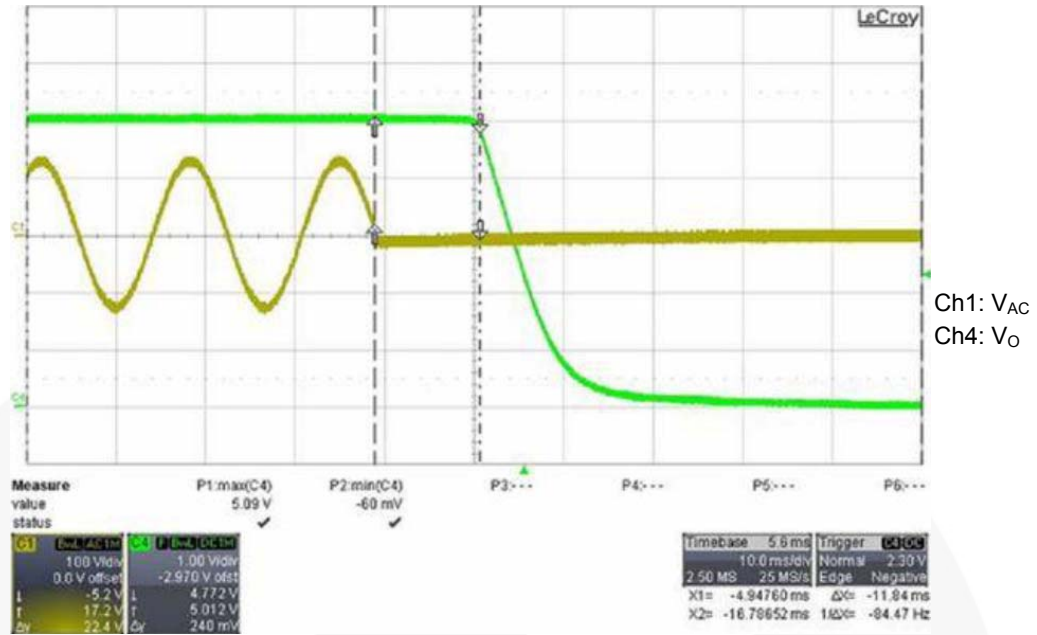

Figure 14. 90V / 60Hz at Maximum Load

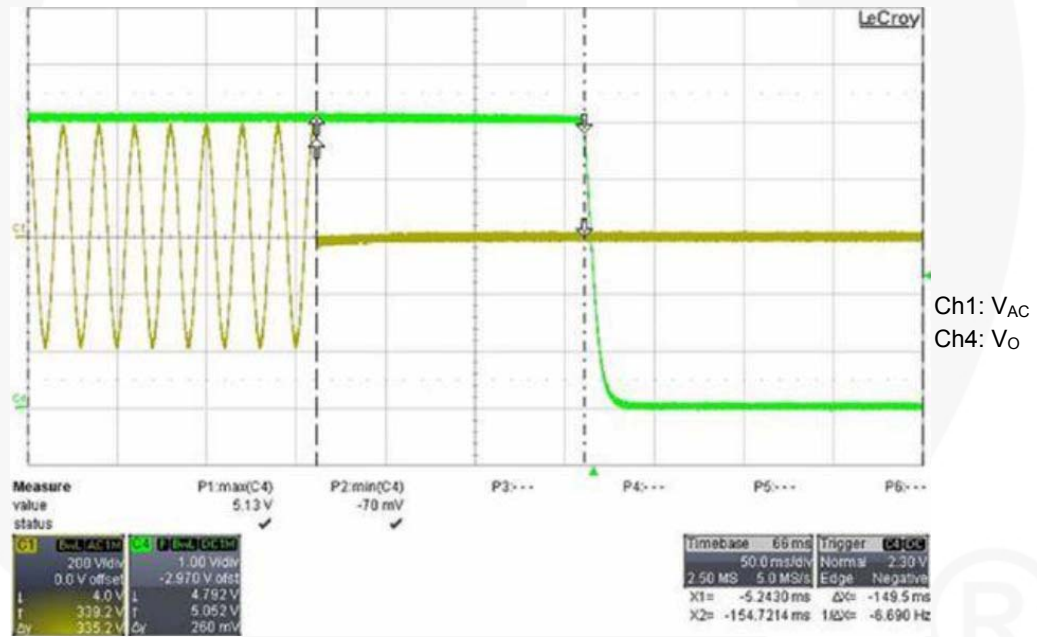

Figure 15. 264V / 50Hz at Maximum Load

## 2.11. Short-Circuit Protection

### 2.11.1. Test Condition

Short the output of the power supply. The power supply should enter “Hiccup” Mode protection with less than 2W input voltage.

### 2.11.2. Test Result

Input Voltage	Input Wattage at Maximum Loading (W)	Input Wattage at Minimum Loading (W)	Specification
90V / 60Hz	0.468	0.465	<2W
264V / 50Hz	0.93	0.95	

### 2.11.3. Measured Waveforms

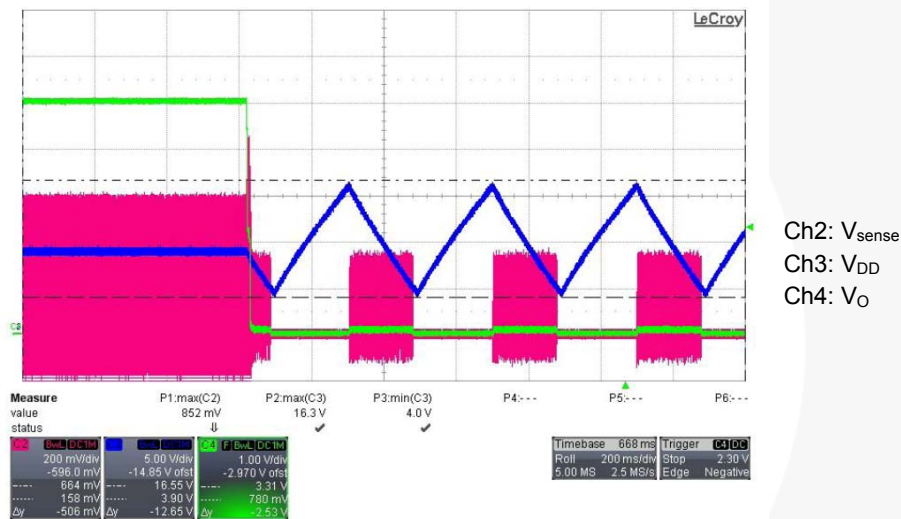

Figure 16. 90V / 60Hz at Maximum Load Short

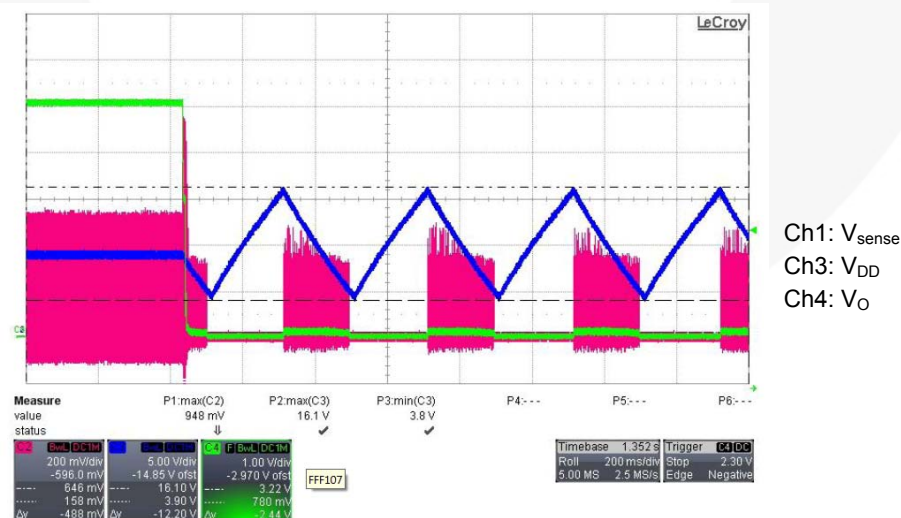

Figure 17. 264V / 60Hz at Maximum Load

## 2.12. Brownout Test

### 2.12.1. Test Condition

Set output at maximum loading. Decrease input voltage with 5V<sub>AC</sub> step. Record input wattage and output voltage. After the output is off, increase the AC voltage gradually and record the recovery voltage.

### 2.12.2. Test Result

Input Voltage	Input Wattage (W)	Output Voltage (V)
90V / 60Hz	6.936	4.988
85V / 60Hz	6.962	4.978
80V / 60Hz	7.015	4.976
75V / 60Hz	7.076	4.972
70V / 60Hz	7.174	4.970
65V / 60Hz	7.290	4.966
60V / 60Hz	7.476	4.956
55V / 60Hz	7.413	4.870
50V / 60Hz	7.027	4.666
45V / 60Hz	6.501	4.420
40V / 60Hz	5.793	4.112
35V / 60Hz	4.677	3.642
30V / 60Hz	3.744	3.172
25V / 60Hz	0	0

Recovery Voltage	Input Wattage (W)	Output Voltage (V)
53V / 60Hz	7.331	4.822 / 0.967A
70V / 60Hz	7.162	4.974 / 1.00A

## 2.13. V<sub>DD</sub> Voltage Level

### 2.13.1. Test Result

	Min. Load (V)	Max. Load (V)	Near OPP (V)	Output SC (Max. Value) (V)	Spec.
90V / 60Hz	7.110	8.819	8.829	16.30	<24V
264V / 50Hz	7.830	8.772	8.826	16.10	



### 2.13.2. Measured Waveforms

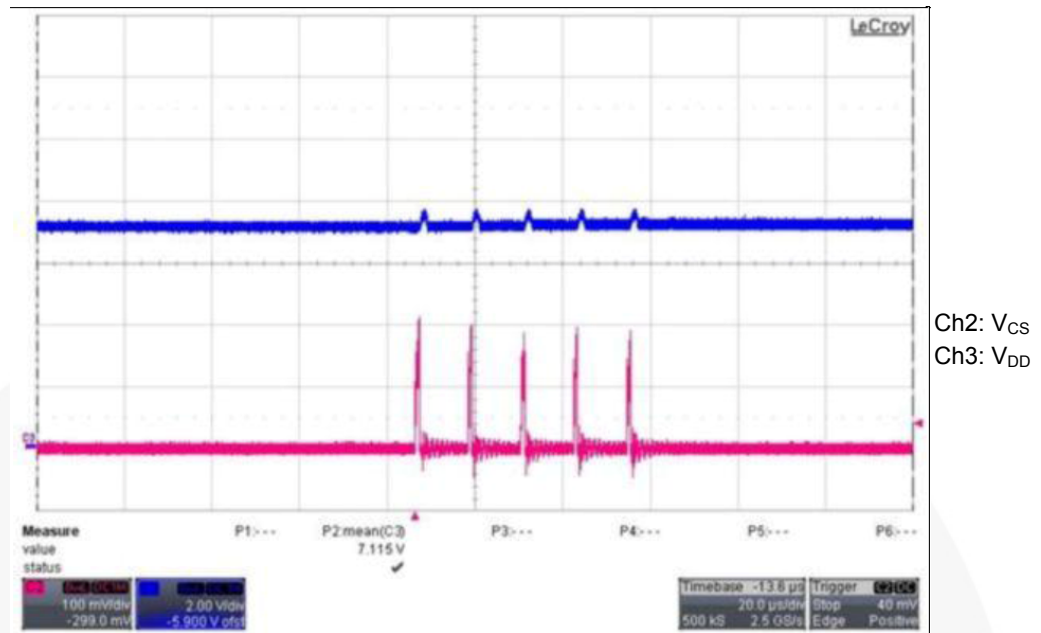

Figure 18. 90V / 60Hz at No Load

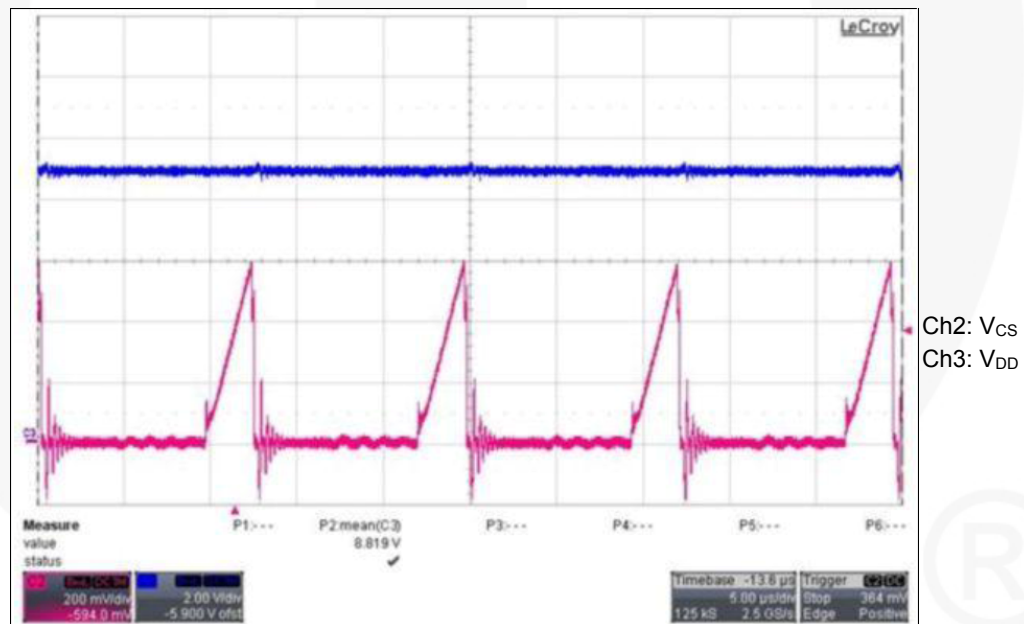

Figure 19. 90V / 60Hz at Maximum Load

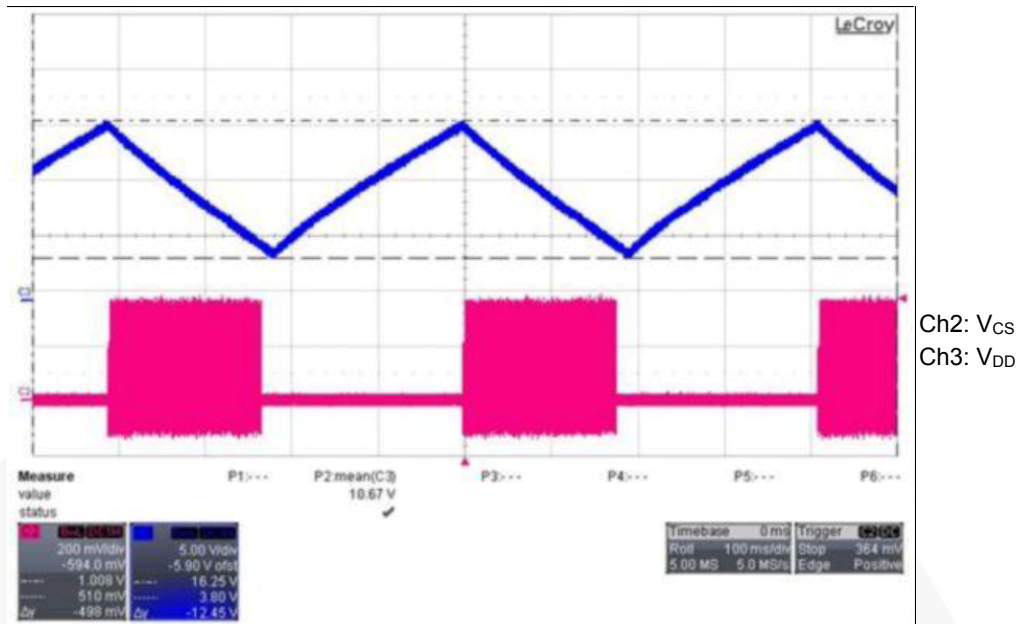

Figure 20. 90V / 60Hz at Short Circuit

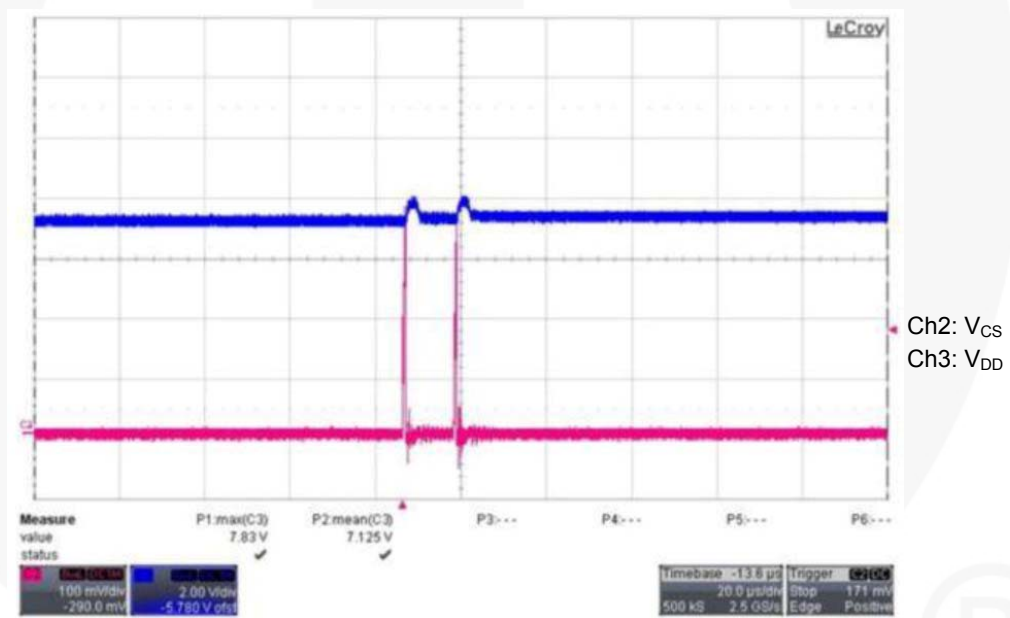

Figure 21. 264V / 50Hz at No Load

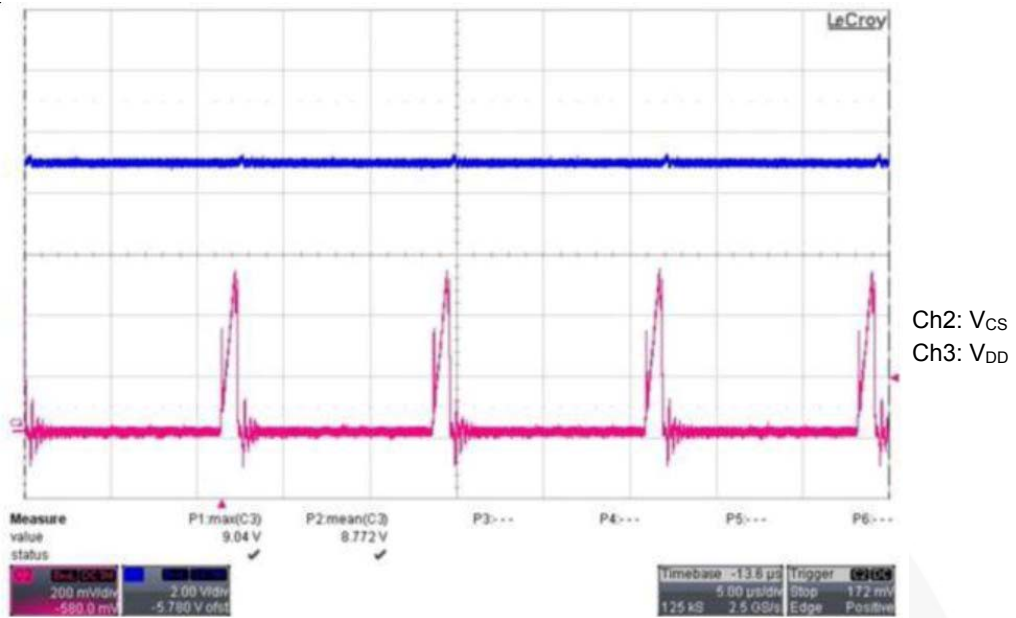

Figure 22. 264V / 50Hz at Maximum Load

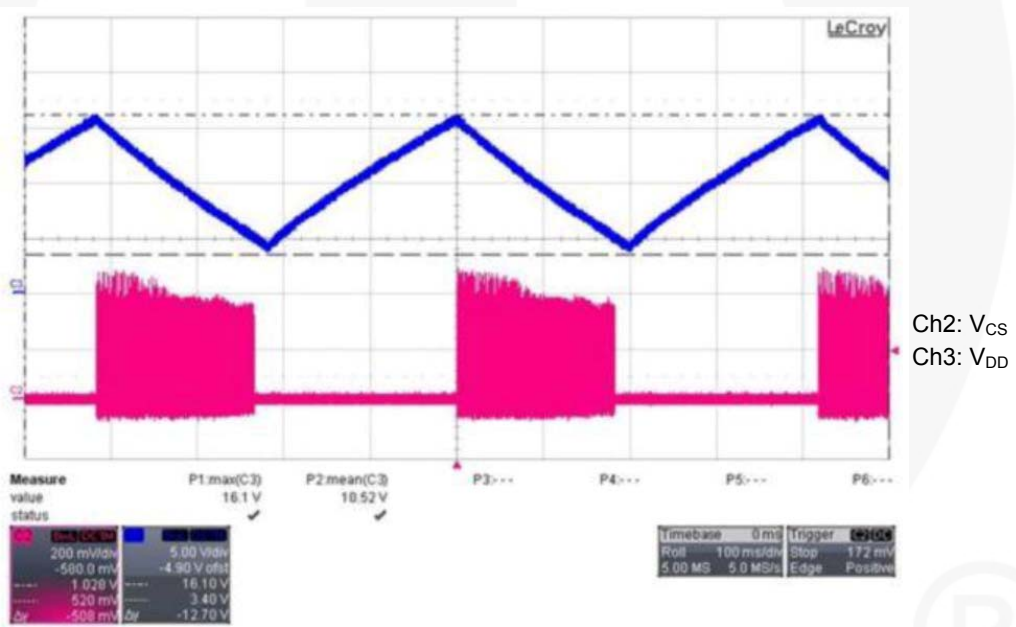

Figure 23. 264V / 50Hz at Short Circuit

## 2.14. Voltage Stress on MOSFET and Rectifiers

### 2.14.1. Test Condition

Measure the voltage stress on MOSFET and secondary rectifiers under conditions specified in Table 2.

### 2.14.2. Test Result

Condition	Stress on MOSFET	Rating	Stress on Output Rectifier	Rating
90V / 60Hz, Max. Load	378V	650V	16.2V	40V
90V / 60Hz, Max. Load, Startup	390V		17.1V	
90V / 60Hz, Max. Load, Output Short	384V		16.5V	
264V / 50Hz, Max. Load	614V		37.2V	
264V / 50Hz, Max. Load, Startup	634V		39.1V	
264V / 50Hz, Max. Load, Output Short	627V		37.8V	
264V / 50Hz, Max. Load Turns Off	621V		37.8V	

### 2.14.3. Measured Waveforms

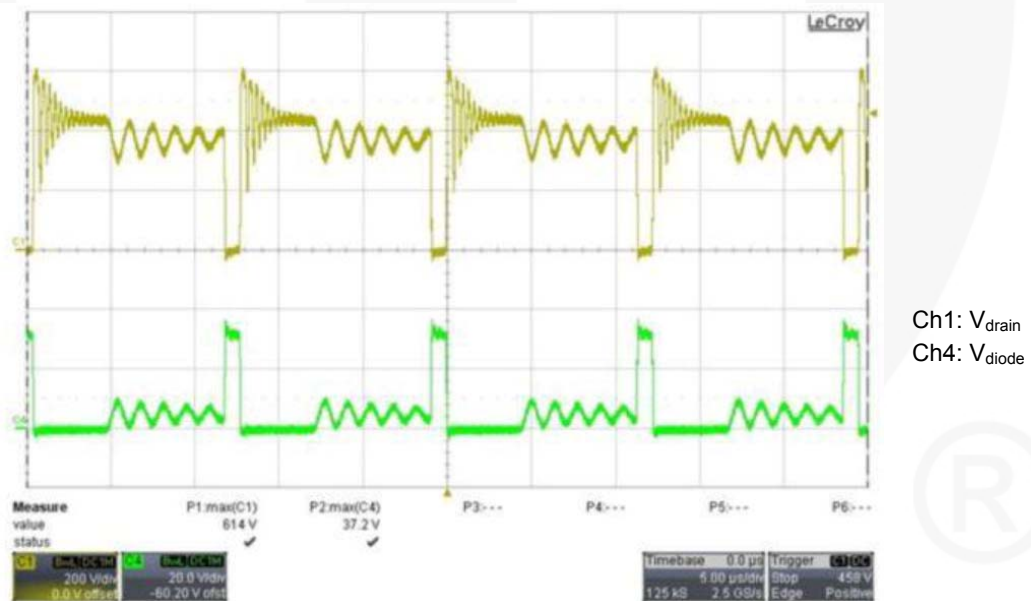
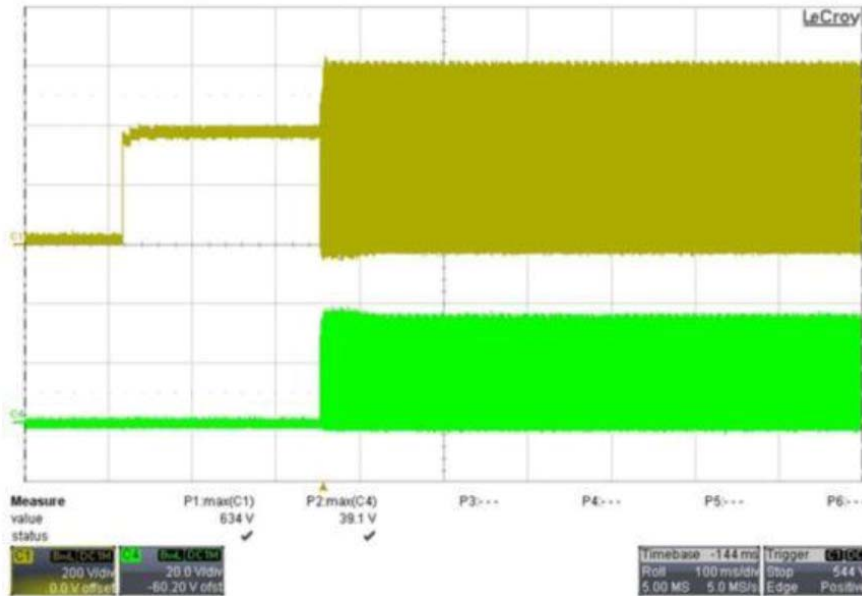

Figure 24. 264V / 50Hz at Maximum Load



Ch1: V<sub>drain</sub>  
Ch4: V<sub>diode</sub>

**Figure 25. 264V / 50Hz at Maximum Load Startup**

2.15. Constant Voltage (CV) and Constant Current (CC) Curves

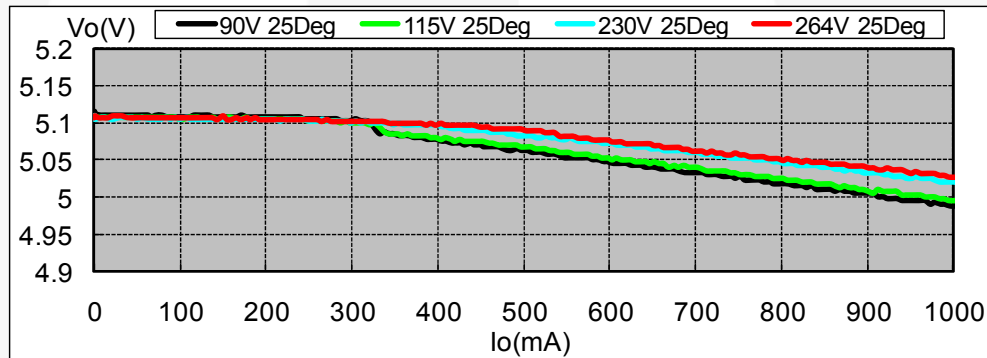

**Figure 26. Constant Voltage Curve**

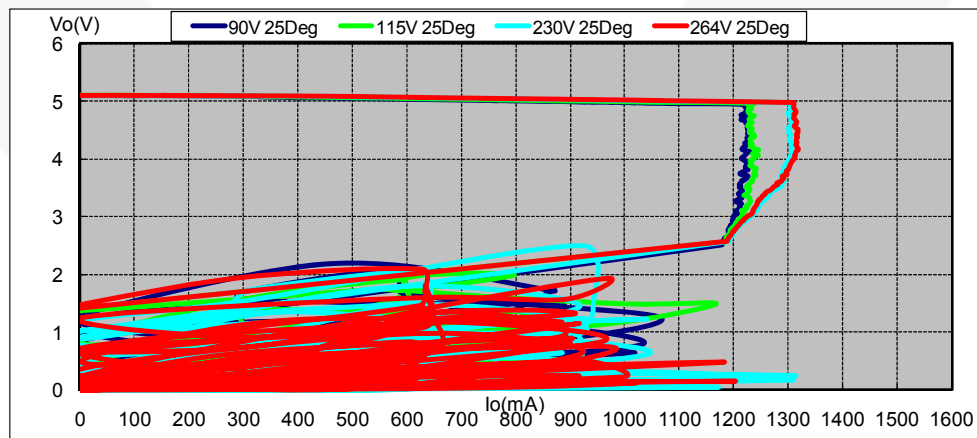

**Figure 27. Constant Current Curve**

## 2.16. $V_S$ OVP Test

### 2.16.1. Test Condition

Measure the maximum output voltage when the secondary side feedback signal is disabled.

### 2.16.2. Test Result

AC Line/ Loading	90V <sub>AC</sub> Max. Load	90V <sub>AC</sub> Min. Load	264V <sub>AC</sub> Max. Load	264V <sub>AC</sub> Min. Load
Max. $V_O$ (V)	5.501V	5.773V	5.564V	5.787V

### 2.16.3. Measured Waveforms

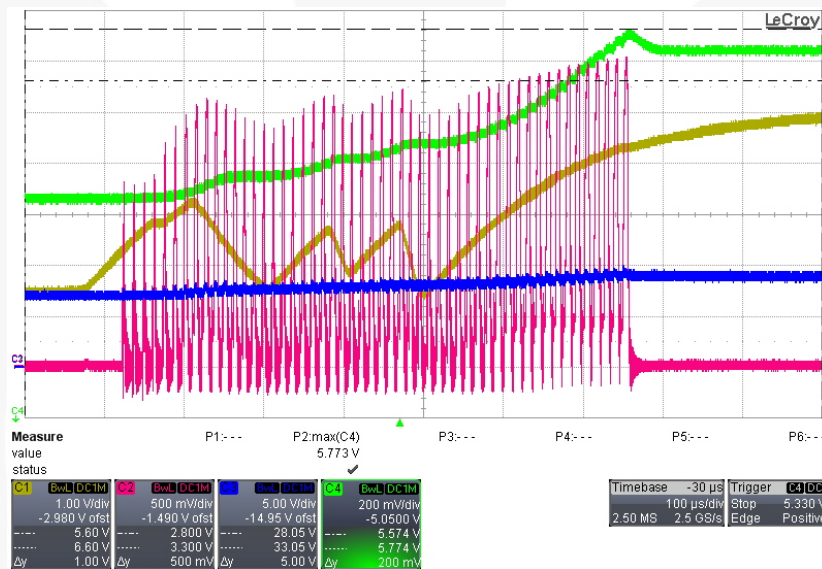

CH1:  $V_{FB}$   
CH2:  $V_{VS}$   
CH3:  $V_{DD}$   
CH4:  $V_O$

Figure 28. 90V<sub>AC</sub> Minimum Load

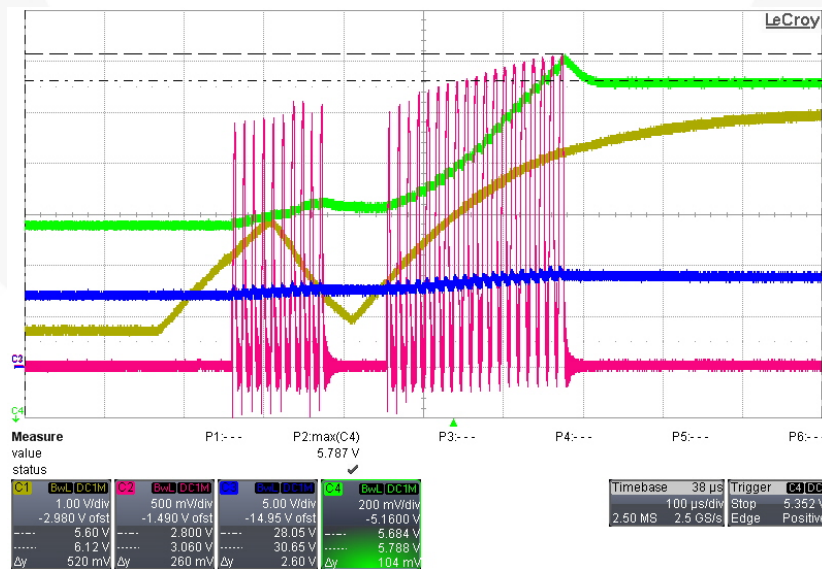

CH1:  $V_{FB}$   
CH2:  $V_{VS}$   
CH3:  $V_{DD}$   
CH4:  $V_O$

Figure 29. 264V<sub>AC</sub> Minimum Load

## 2.17. Over-Temperature Protection Test (OTP)

### 2.17.1. Test Condition

Measure the output voltage and Gate when the IC temperature exceeds 140°C.

### 2.17.2. Test Result

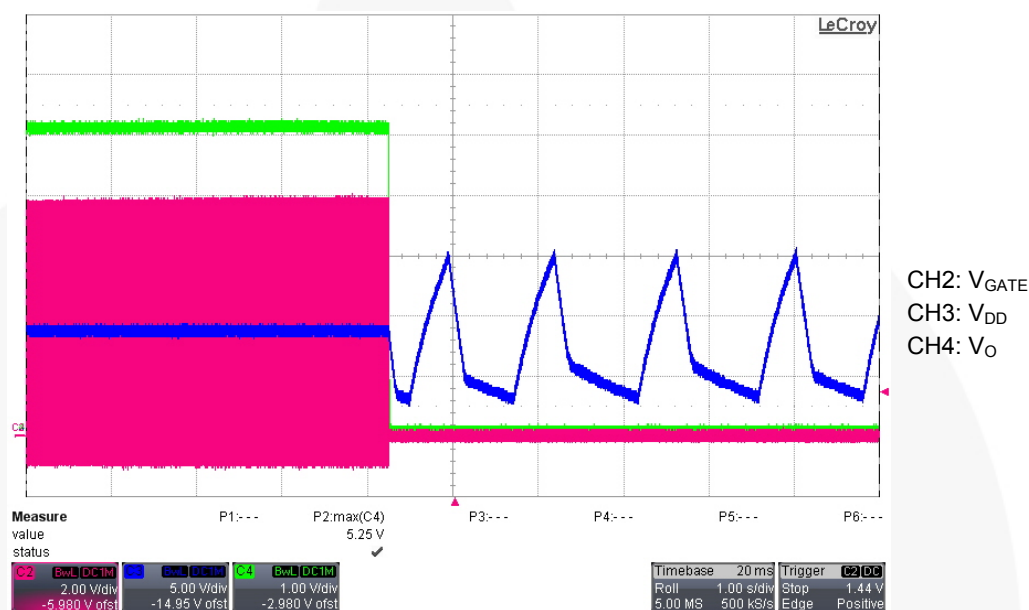

Figure 30. 90V<sub>AC</sub> Maximum Load

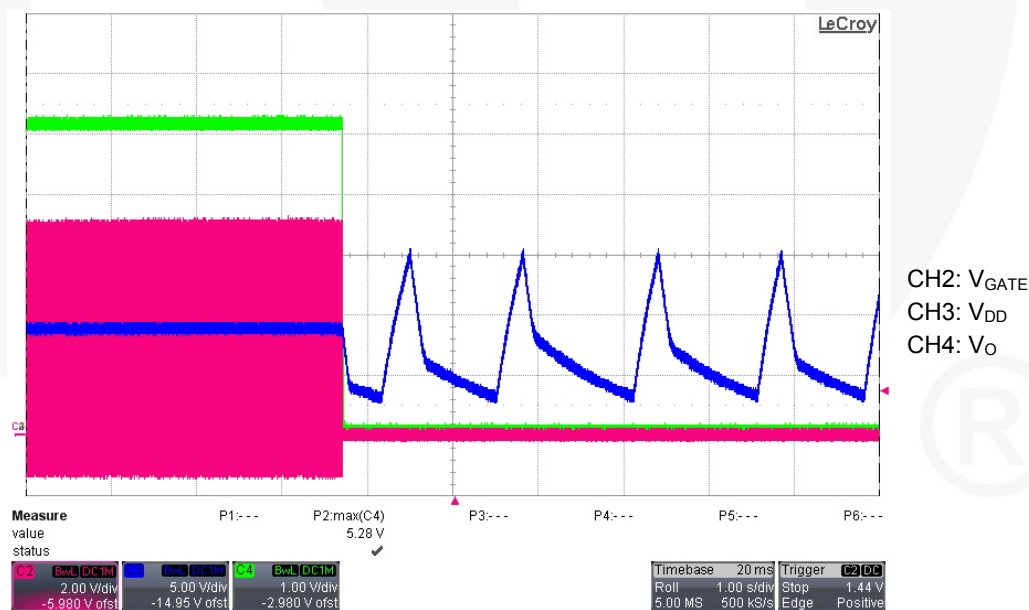
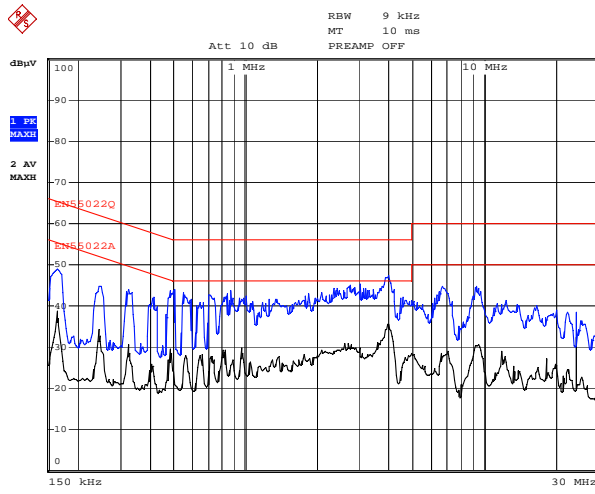

Figure 31. 264V<sub>AC</sub> Maximum Load

## 2.18. EMI Test



Date: 16.NOV.2010 20:12:04

**Line at 115V<sub>AC</sub>**

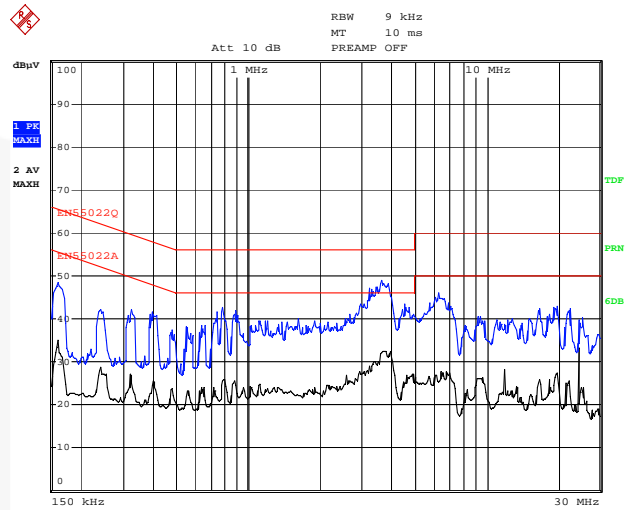

Date: 16.NOV.2010 20:14:04

**Neutral at 115V<sub>AC</sub>**

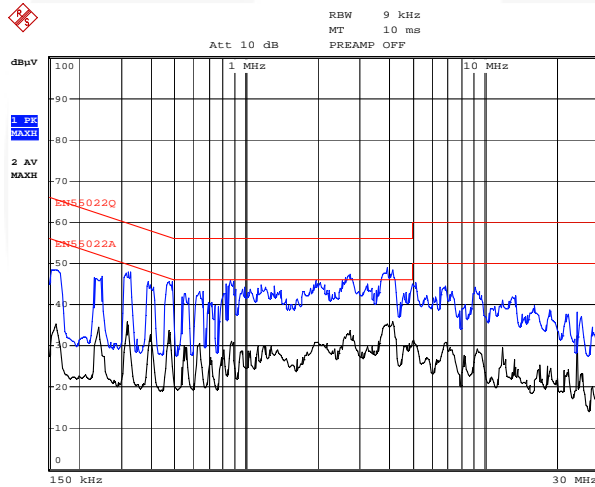

Date: 16.NOV.2010 20:15:52

**Line at 230V<sub>AC</sub>**

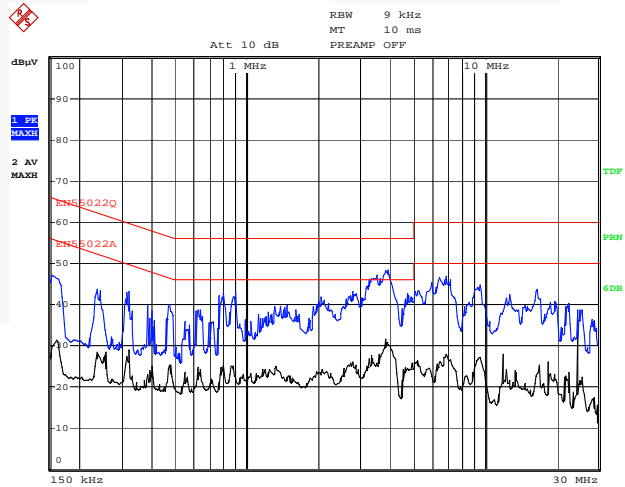

Date: 16.NOV.2010 20:17:41

**Neutral at 230V<sub>AC</sub>**

**Figure 32. Conduction EMI — Line and Neutral**



## 2.19. Surge Test

Mode	Polarity	Phase	Voltage	Condition
L-PE	+/-	0°	4.4KV	PASS
	+/-	90°		PASS
	+/-	180°		PASS
	+/-	270°		PASS
N-PE	+/-	0°	4.4KV	PASS
	+/-	90°		PASS
	+/-	180°		PASS
	+/-	270°		PASS

## 2.20. ESD Test

Air Discharge (+/-16.5KV)		Contact Discharge (+/-8.8KV)	
PASS	PASS	PASS	PASS

### 3. Photographs



Figure 33. Front Side

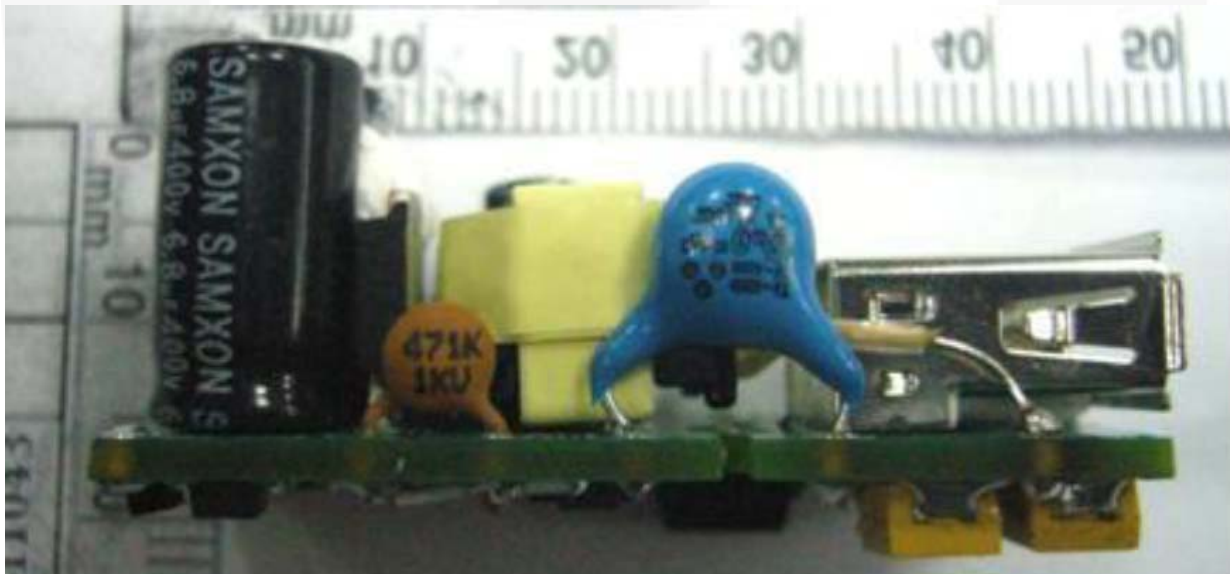

Figure 34. Flank Side / Side View

## 4. Schematic

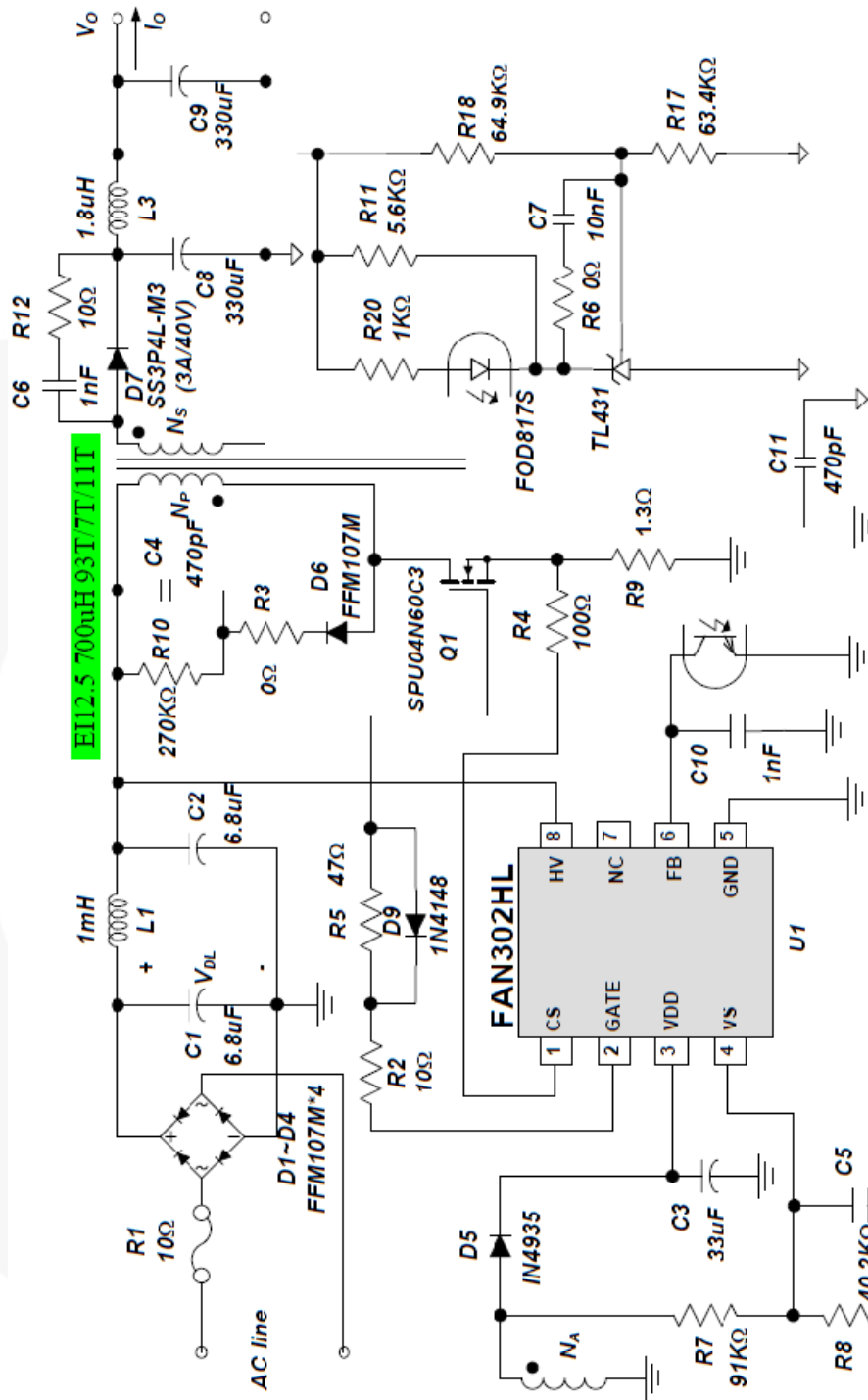

Figure 35. Circuit Schematic

## 5. PCB Layout

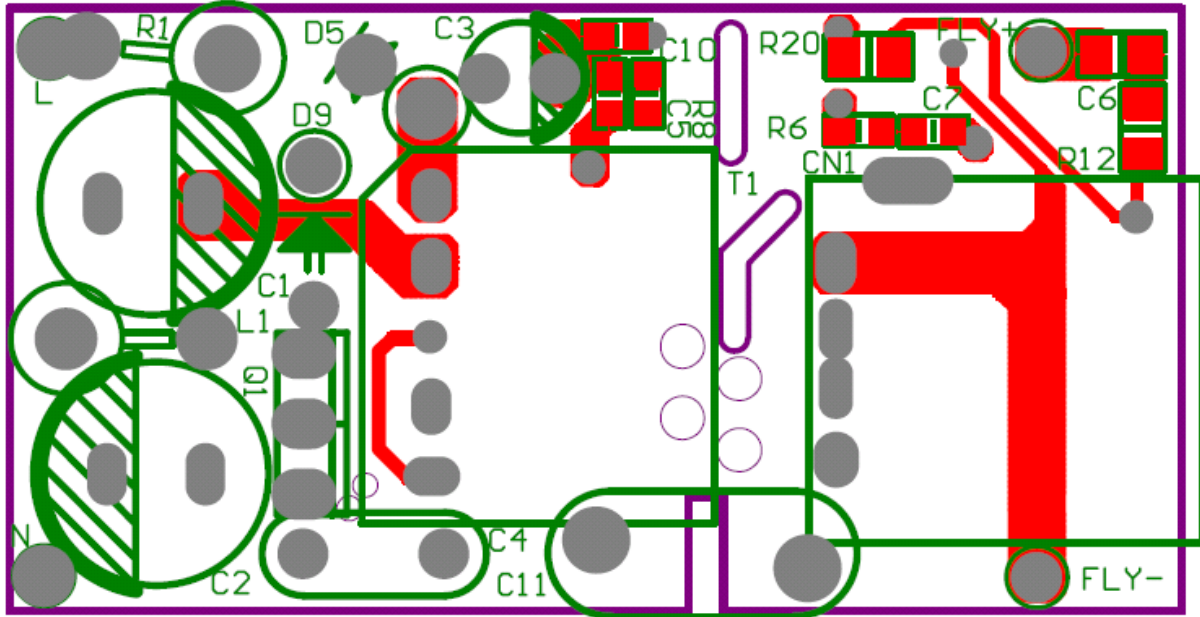

Figure 36. Front Side

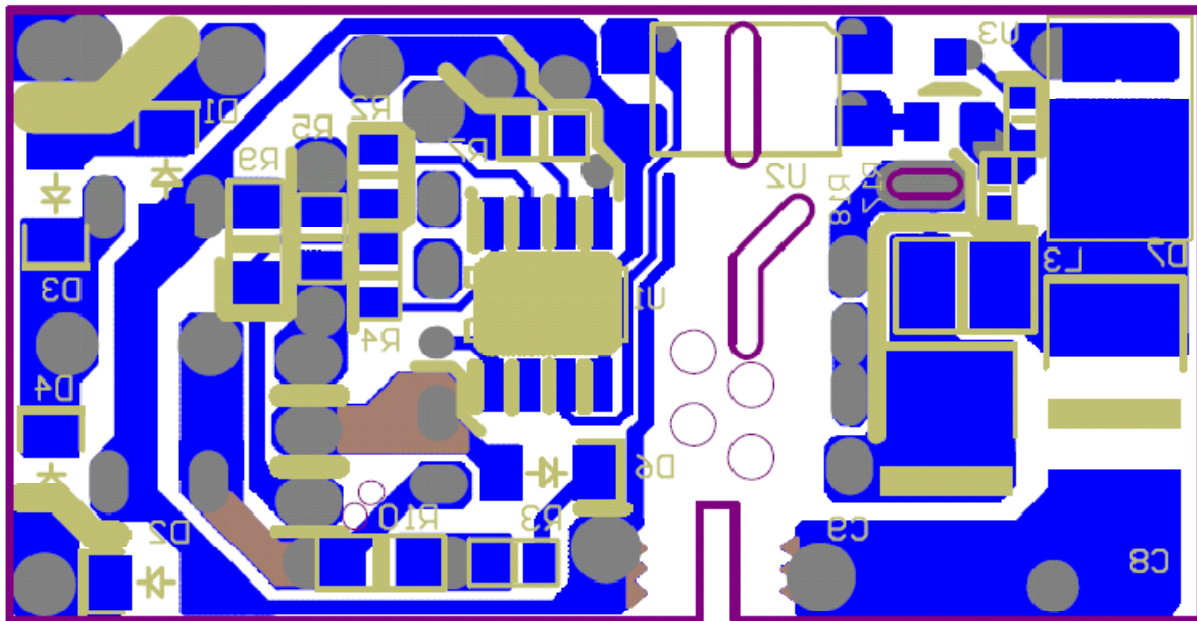

Figure 37. Back Side

## 6. Bill of Materials

Component	Qty	Part No.	Manufacturer	Reference
Chip Resistor 0603 0Ω±5%	1			R6
Chip Resistor 0603 40K2Ω±1%	1			R8
Chip Resistor 0603 63K4Ω±1%	1			R17
Chip Resistor 0603 64K9Ω±1%	1			R18
Chip Resistor 0805 0Ω±5%	1			R3
Chip Resistor 0805 10Ω±5%	2			R2 R12
Chip Resistor 0805 47Ω±5%	1			R5
Chip Resistor 0805 100Ω±5%	1			R4
Chip Resistor 0805 1KΩ±5%	1			R20
Chip Resistor 0805 5K6Ω±1%	1			R11
Chip Resistor 0805 91KΩ±5%	1			R7
Chip Resistor 1206 1Ω3±5%	1			R9
Chip Resistor 1206 270KΩ±5%	1			R10
Wire Wound Resistor 1W 10Ω ±5%	1			R1
Ceramic Capacitor 471P 1KV +80/-20%	1			C4
0603 MLCC X7R ±10% 20P 50V	1			C5
0603 MLCC X7R ±10% 102P 50V	1			C10
0603 MLCC X7R ±10% 103P 50V	1			C7
0805 NPO ±5% 102P 50V	1			C6
SMD TANTALUM Capacitor D 330μ 10V +/-20%	2	TAJ-293D	AVX	C8 C9
Electrolytic Capacitor 6μ8 400V 105°	2	8*16 KM	JACKCON	C1 C2
Electrolytic Capacitor 33μ 50V 105°	1	5*11 LHK	JACKCON	C3
Y1 Capacitor 471P 400V ±20%	1	D7xF7xT9.5mm		C11
SMD 1.8μH GS43-1R8M	1	TRN0311	GANGSONG	L3
Fixed Inductor 1mH ±10%	1	EC36-102K		L1
Transformer EI-12.5 700μH	1	TRN0312	SEN HUEI	
SMD Diode 3A/40V SMPC (TO-277A)	1	SS3P4L-M3	VISHAY	D7
Diode 1A/200V DO-41 TAPING	1	1N4935	FAIRCHILD	D5
SMD Diode 1A/1000V SOD-123	5	FFM107-M	FORMOSA	D1 D2 D3 D4 D6
Diode 0.2A/100V DO-35	1	1N4148	FAIRCHILD	D9
SMD REGULATOR SOT-23 ±1%	1	KA431SAMF2TF	FAIRCHILD	U3
MOS 4.5A/650V TO-251	1	SPU04N60C3	INFINEON	Q1
Phototransistor Output Opto-coupler SMDIP-B	1	FOD817S	FAIRCHILD	U2
PWM Controller SOP8	1	FAN302HLMY	FAIRCHILD	U1
USB 4411-02003L	1		DINTEK	CN1
PCB PLM0110 REV1	1	For FAN302HL 5W 2*5		

## 7. Transformer Specification

### 7.1. Specification Approval

Customer	SYSTEM GENERAL CORP.	P/N:	TRN-0312
DATE	06/18/2011	Version	A
		Page	1/4

1.DIMENSION : Unit : mm

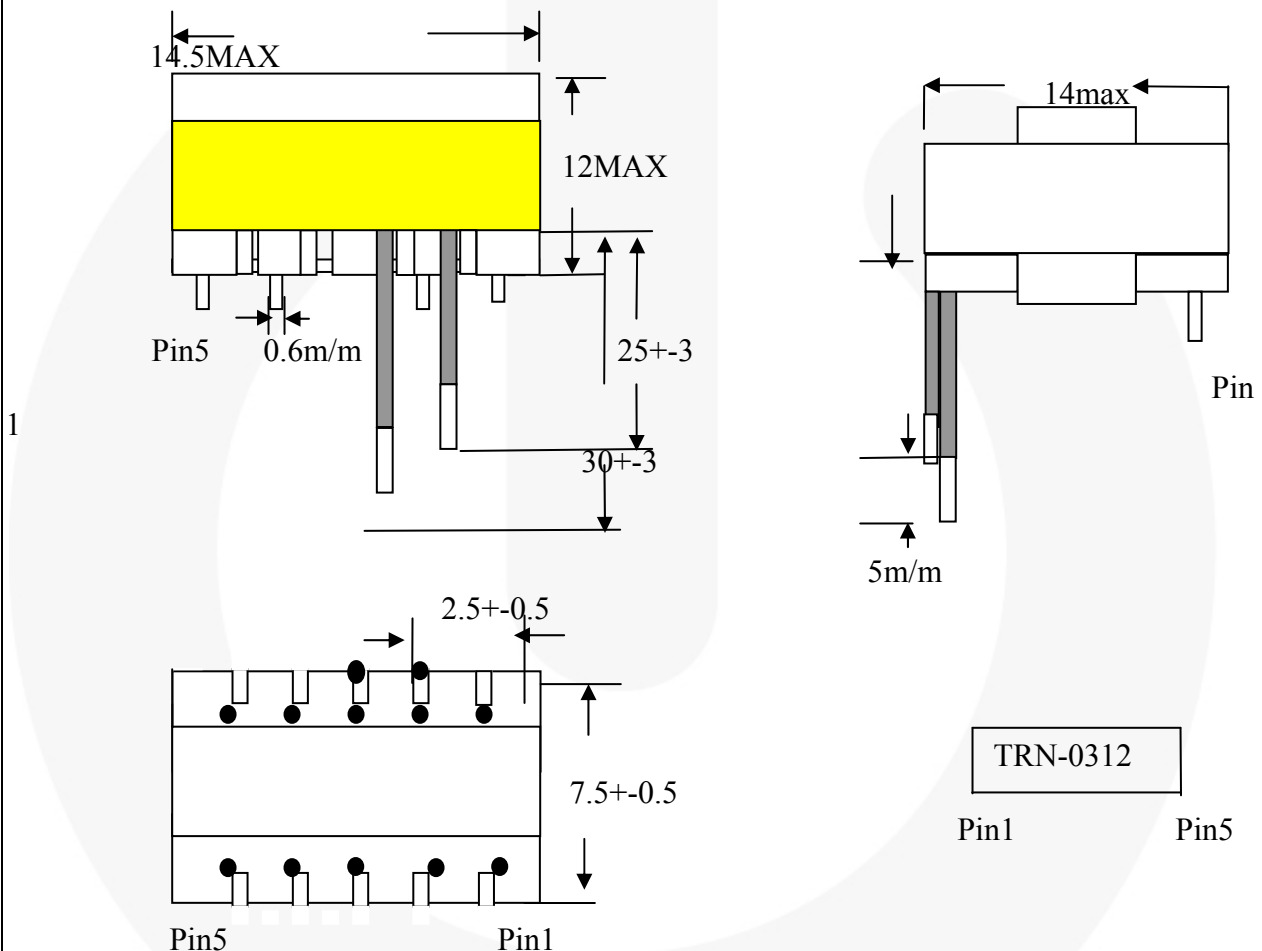

Note :

- 1.Remove Pin 3、6、7、8、9、10
2. N2 fly+ line is 30mm of 5mm+/-3mm for soldering - fly- line is 25m/m of 5mm+/-3mm for soldering.
- 3.Core assembly is completed have the wire of  $\phi 0.18$  loose 5Ts and package of three turns tape.

UNIT	m/m	DRAWN	CHECK	TITLE	TRANS
TEL	(02)29450588	Ci wun Chen	Guo long Huang	IDENT N O.	TRN-0312
FAX	(02)29447647	SEN HUEI INDUSTRIAL CO., LTD.		D W G N O.	I1201
No.26-1, Lane 128, Sec. 2, Singnan Rd., Jhonghe City, Taipei County 235, Taiwan (R.O.C.)					

Customer	SYSTEM GENERAL CORP.		P/N:	TRN-0312
DATE	03/18/2011	Version	A	Page 2/4

2.Schematic :

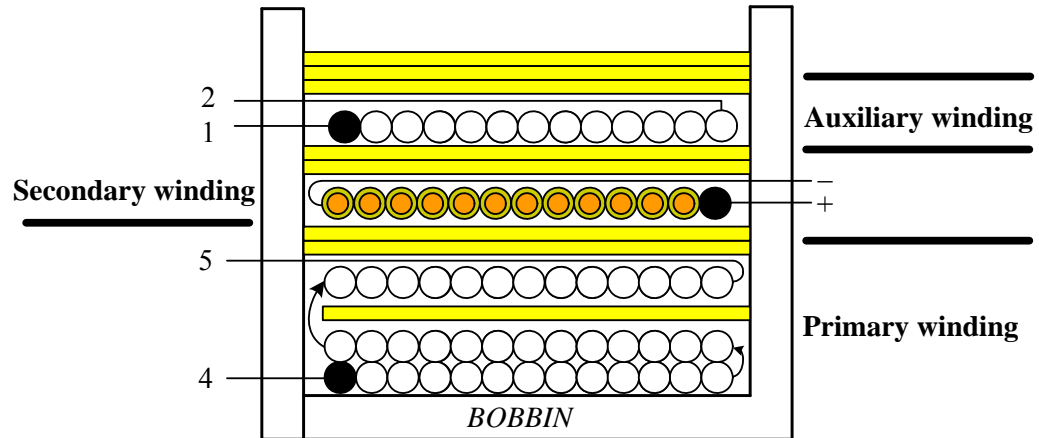

NO	TERMINAL		WIRE	Ts	INSULATION
	S	F			Ts
W1	4	5	2UEW 0.1*1	26	0
				25	1
				24	0
				18	2
W2	Fly+	Fly-	TEX-E 0.45*1	7	2
W3	1	2	2UEW 0.18*1	11	0
			CORE ROUNDING TAPE		3
			Core		0
W4	2	-	2UEW 0.18*1	5	2
			CORE ROUNDING TAPE		3

Notes:

1. W1 is four winds, each wind of turns refers to above turns, need one added insulating tape between the one and two layer.
2. W2 is wound two layer and uses triple insulated wire, end of positive fly line is 3cm; the end of negative fly line is 2.5cm.
3. W3 is spares winding in one layer.
4. W4 is wound in the core of the outermost layer and sparse winding.

UNIT	m/m	DRAWN	CHECK	TITLE	TRANS
TEL	(02)29450588	Ci wun Chen	Guo long Huang	IDENT N O.	TRN-0312
FAX	(02)29447647	SEN HUEI INDUSTRIAL CO.,LTD.		D W G N O.	
No.26-1, Lane 128, Sec. 2, Singnan Rd., Jhonghe City, Taipei County 235, Taiwan (R.O.C.)					

Customer	SYSTEM GENERAL CORP.		P/N:	TRN-0312
DATE	03/18/2011	Version	A	Page 3/4

3. Electrical Specification:

3.1 Inductance test : at 100KHz ,1V

Pin4 to Pin5 : 700  $\mu$ H  $\pm$  7% (650 $\mu$ H Min. – 750 $\mu$ H Max.)

3.2 Hi-pot test :

AC 3.0K V /60Hz/5mA hi-pot for one minute between primary and secondary.

AC 1.5K V /60Hz/5mA hi-pot for one minute between primary and core.

AC 1.5K V /60Hz/5mA hi-pot for one minute between secondary and core.

3.3 Insulation test :

The insulation resistance is between primary and secondary and windings and core measured by DC

500V, must be over 100 M $\Omega$ .

3.4 Terminal strength :

1.0 Kg on terminals for 30 seconds, test the breakdown.

UNIT	m/m	DRAWN	CHECK	TITLE	TRANS
TEL	(02)29450588	Ci wun Chen	Guo long Huang	IDENT N O.	TRN-0312
FAX	(02)29447647	SEN HUEI INDUSTRIAL CO.,LTD.		D W G N O.	
No.26-1, Lane 128, Sec. 2, Singnan Rd., Jhonghe City, Taipei County 235, Taiwan (R.O.C.)					



Customer	SYSTEM GENERAL CORP.		P/N:	TRN-0312
DATE	03/18/2011	Version	A	Page 4/4

MATERIALS LIST :

COMPONENT	MATERIAL	MANUFACTURER	FILE NO.
1. Bobbin	Phenolic 94V-0,T373J,150	EI-12.5.(TF-1613) Chang Chun plastics Co., Ltd	E59481(S)
2. Core	PC-40,BH2,2E6 3C85,NC-2H,	Ferrite core EI-12.5 TDK,Tokin.Tomita.Philip.Nicera.	
3. Wire	UEWE 130	Tai-I electric wire & cable Co., LTD	E85640 ( S )
	UEW-2 130	Jung Shing wire Co., LTD	E174837
	UEW-B 130	Chuen Yih wire Co., LTD	E154709 ( S )
	TEX-E 105/120	Furukawa electric Co., LTD	E206440
4. Varnish	BC-346A 180	John C Dolph Co., LTD	E51047 ( M )
	468-2FC 130	Ripley resin engineering co inc.	E81777 ( N )
5. Tape t=0.064mm	31CT 130	Nitto denk corp.	E34833 ( M )
	Polyester 3M #1350(b) 130	Minnesota mining & MFG Co., LTD CTI material group	E17385 ( N )
6. Tube	Teflon tube TFL 150V,200	Great holding industriat Co., LTD	E156256 ( S )
7. Terminals	Tin coated- Copper wire	Will for special wire CORP.	
8. Shield	Copper foil	Hitachi cable lid. (copper foil: 0.025t x7mm)	

UNIT	m/m	DRAWN	CHECK	TITLE	TRANS
TEL	(02)29450588	Ci wun Chen	Guo long Huang	IDENT N O.	TRN-0312
FAX	(02)29447647	SEN HUEI INDUSTRIAL CO.,LTD.		D W G N O.	
No.26-1, Lane 128, Sec. 2, Singnan Rd., Jhonghe City, Taipei County 235, Taiwan (R.O.C.)					

## 8. Revision History

Rev.	Date	Description
1.0.0	November, 2011	Initial release

---

### WARNING AND DISCLAIMER

Replace components on the Evaluation Board only with those parts shown on the parts list (or Bill of Materials) in the Users' Guide. Contact an authorized Fairchild representative with any questions.

This board is intended to be used by certified professionals, in a lab environment, following proper safety procedures. Use at your own risk. The Evaluation board (or kit) is for demonstration purposes only and neither the Board nor this User's Guide constitute a sales contract or create any kind of warranty, whether express or implied, as to the applications or products involved. Fairchild warrants that its products meet Fairchild's published specifications, but does not guarantee that its products work in any specific application. Fairchild reserves the right to make changes without notice to any products described herein to improve reliability, function, or design. Either the applicable sales contract signed by Fairchild and Buyer or, if no contract exists, Fairchild's standard Terms and Conditions on the back of Fairchild invoices, govern the terms of sale of the products described herein.

#### DISCLAIMER

FAIRCHILD SEMICONDUCTOR RESERVES THE RIGHT TO MAKE CHANGES WITHOUT FURTHER NOTICE TO ANY PRODUCTS HEREIN TO IMPROVE RELIABILITY, FUNCTION, OR DESIGN. FAIRCHILD DOES NOT ASSUME ANY LIABILITY ARISING OUT OF THE APPLICATION OR USE OF ANY PRODUCT OR CIRCUIT DESCRIBED HEREIN; NEITHER DOES IT CONVEY ANY LICENSE UNDER ITS PATENT RIGHTS, NOR THE RIGHTS OF OTHERS.

#### LIFE SUPPORT POLICY

FAIRCHILD'S PRODUCTS ARE NOT AUTHORIZED FOR USE AS CRITICAL COMPONENTS IN LIFE SUPPORT DEVICES OR SYSTEMS WITHOUT THE EXPRESS WRITTEN APPROVAL OF THE PRESIDENT OF FAIRCHILD SEMICONDUCTOR CORPORATION.

As used herein:

1. Life support devices or systems are devices or systems which, (a) are intended for surgical implant into the body, or (b) support or sustain life, or (c) whose failure to perform when properly used in accordance with instructions for use provided in the labeling, can be reasonably expected to result in significant injury to the user.
2. A critical component is any component of a life support device or system whose failure to perform can be reasonably expected to cause the failure of the life support device or system, or to affect its safety or effectiveness.

---

### ANTI-COUNTERFEITING POLICY

Fairchild Semiconductor Corporation's Anti-Counterfeiting Policy. Fairchild's Anti-Counterfeiting Policy is also stated on our external website, [www.fairchildsemi.com](http://www.fairchildsemi.com), under Sales Support.

Counterfeiting of semiconductor parts is a growing problem in the industry. All manufacturers of semiconductor products are experiencing counterfeiting of their parts. Customers who inadvertently purchase counterfeit parts experience many problems such as loss of brand reputation, substandard performance, failed applications, and increased cost of production and manufacturing delays. Fairchild is taking strong measures to protect ourselves and our customers from the proliferation of counterfeit parts. Fairchild strongly encourages customers to purchase Fairchild parts either directly from Fairchild or from Authorized Fairchild Distributors who are listed by country on our web page cited above. Products customers buy either from Fairchild directly or from Authorized Fairchild Distributors are genuine parts, have full traceability, meet Fairchild's quality standards for handling and storage and provide access to Fairchild's full range of up-to-date technical and product information. Fairchild and our Authorized Distributors will stand behind all warranties and will appropriately address any warranty issues that may arise. Fairchild will not provide any warranty coverage or other assistance for parts bought from Unauthorized Sources. Fairchild is committed to combat this global problem and encourage our customers to do their part in stopping this practice by buying direct or from authorized distributors.

---

### EXPORT COMPLIANCE STATEMENT

These commodities, technology, or software were exported from the United States in accordance with the Export Administration Regulations for the ultimate destination listed on the commercial invoice. Diversion contrary to U.S. law is prohibited.

U.S. origin products and products made with U.S. origin technology are subject to U.S. Re-export laws. In the event of re-export, the user will be responsible to ensure the appropriate U.S. export regulations are followed.