

APPLICATION TOOLING

Crimping tools and machines

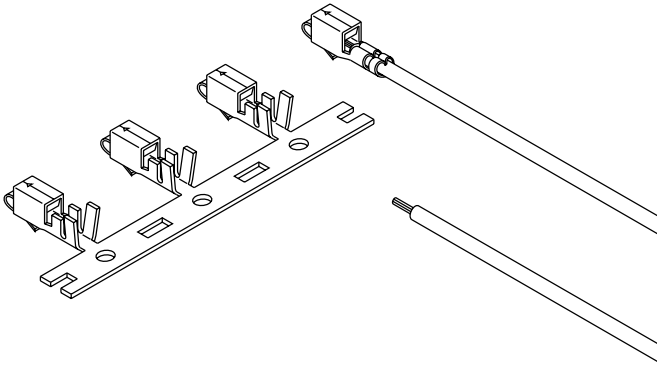

Strip-crimp applicator for side feeding terminals

Model No.: MKS-SC
1

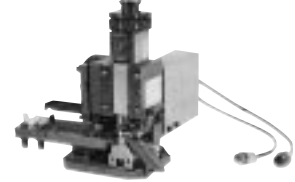

- Dimensions: (W x L x H) 198 x 186 x 203mm (7.8"x7.3"x8.0")
- Weight: 6.5kg (14.3lb)
- Applicable terminals: Side-feeding terminals for wires AWG #20 to #30
- Accessories: Vacuum unit (optional)
- Both foot-switch-operated type and touch-sensor-operated type are available.

Fully automatic crimping machine

ATM-4 (Refer to page 534.)
7



Crimping applicator for end-feeding terminals

Model No.: MK-L
2

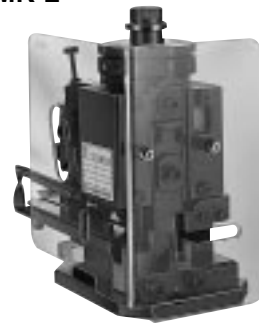

Hand crimp tools **6**

YC



Dimensions: (WxL) 70x296mm (2.8"x11.7")

YRS



Dimensions: (WxL) 72x220mm (2.8"x8.7")

Crimping applicator for side-feeding terminals

Model No.: MKS-L
3

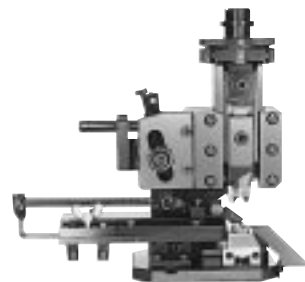

Crimping tools and machines

The arrow mark indicates the press that is applicable to the applicator.

Compact crimping applicator for side-feeding terminals

Model No.: MKS-LS

4

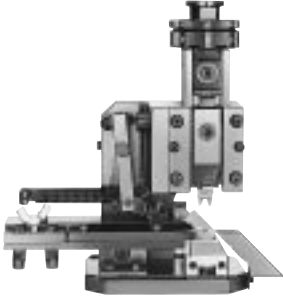

Electric press

Model No.: AP-K2N

8

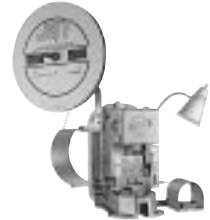

- Dimensions: (W x L x H)(280 x 480 x 505mm)
11.0" x 18.9" x 19.9"
- Weight: 90kg(198lb)
- Power source: 100/115/220/240V AC, 50/60Hz
- Pressure output: 14.7kN [1,500kg (3307lb)]
- Dies: Applicator replacement

Crimping applicator for end-feeding flag terminals

Model No.: MKF-L

5



ID applicator for discrete wires

Model No.: MKD-LP

12



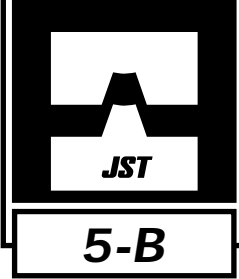



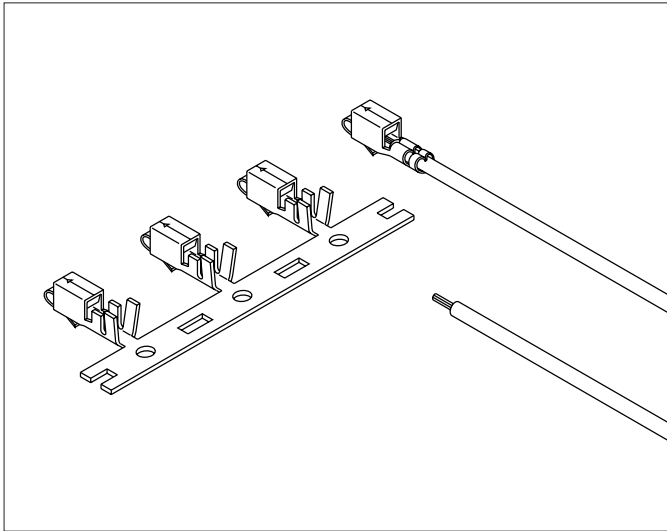

Crimping tools and machines

Crimping tools and machines

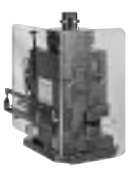

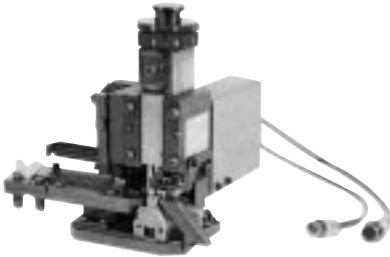
JST offers semi-automatic and fully-automatic crimping machines. Semi-automatic crimping machines (presses) connect a wire to a chain terminal each time a footswitch is pressed. Fully-automatic crimping machines measure, cut, strip and connect numerous wire to chain terminals. We also offer hand tools that connect wires to loose-piece terminals.

	Semi-automatic press: AP-K2N			
	Standard (crimp applicator)		Strip-crimp applicator	
	Applicator	Die set	Applicator	Die set
Terminals and parts model number in alphabetical order	MK-L 2	MKS-L 3	MKS-SC 1	
				
	MKF-L 5	MKS-LS 4		
				
GEC-SC1112	MKS-L	MK-DS GEC11	—	—
GEC-SC1212	MKS-L	MK-DS GEC12	—	—
JK-SP 2***	MKS-L	MK-DS JK-SP/SS2	MKS-SC-JK	MKS-SC-DS JK-SP/SS2
JK-SS 2***				
JK-FL15B-11.3	MKS-RG	MK-DS JK-MC15	—	—
J-FL15B-10.5	MKS-RG	MK-DS J-MC15	—	—
J-SP 1***	MKS-L	MK-DS J-SP/SS1	MKS-SC	MKS-SC-DS J-SP/SS1
J-SS 1***				
J-SP 2***	MKS-L	MK-DS J-SP/SS2	MKS-SC	MKS-SC-DS J-SP/SS2
J-SS 2***				
MD-PCC8T-S1	MKS-L	MK-DS MD-PCC8T-S1	—	—
MD-PCC8T-S2	MKS-L	MK-DS MD-PCC8T-S2	—	—

Crimping tools and machines

Semi-automatic press

AP-K2N

8

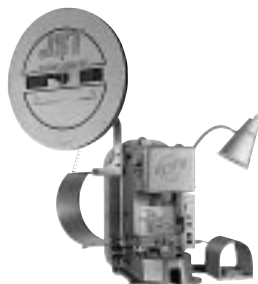

Fully-automatic machine

ATM-4

7



Note 1 on Hand tools:

These hand tools are applicable to the wire with the outside diameters of insulation conforming to UL1007. Special wires may not be crimped.

Each YC tool has two crimping sections (A and B). These sections must be used properly.







Since the dies are fixed, the crimping height cannot be adjusted.

Therefore, some of the applicable wires described in this catalog may not be crimped properly. Before use, check for proper crimping (such as tensile strength, terminal/contact deformation).

When hand crimping board-in terminals (SAN, SCN, SDN, SIN, SZN), care should be taken not to contaminate the solder tails of the terminals, as with greasy or oily fingers. If a solder problem arises, some cleaning of the tips of the terminal is advisable.

Note 2 on Extraction and Insertion tools: Extraction tools are used to extract contacts improperly inserted in the housing.

Insertion tools allow contacts be inserted in the housing. This tool greatly increases efficiency especially when thin wires are used.

Fully-automatic machine: ATM-4		Hand tools (See the Note above)			Extraction and Insertion tools	
Crimp applicator		for chain terminals	for loose piece terminals			
AMK-R		YRS series 6 (See Note above)		YC series 6 (See Note above)	Extraction tool 	Insertion tool 
AMKS-L						
Applicator	Die set	YRS series	YC series	Terminal model No.	Extraction tool	Insetion tool
—	—	—	—	—	—	—
—	—	—	—	—	—	—
—	—	YRS-370	—	—	KEJ-07	—
—	—	—	—	—	KEJ-0.4	—
—	—	—	—	—	—	—
—	—	—	—	—	—	—
—	—	YRS-440	YC-440	J-BP 1*** J-BS 1***	DEJ-0.3	—
—	—	YRS-330	—	—	DEJ-0.3	—
—	—	—	—	—	—	—
—	—	—	—	—	—	—

Crimping tools and machines

Terminals and parts model number in alphabetical order	Standard crimp applicator		Strip-crimp applicator	
	Applicator	Die set	Applicator	Die set
MD-PCC9T-S3	MKS-L	MK-DS MD-PCC9T-S3	—	—
MD-PS8SL	MKS-LS-RG	MK-DS MD-PS8SR	—	—
MD-PS8ASR	MKS-LS-RG	MK-DS MD-PS8SR	—	—
MD-PS8BSR	MKS-LS-RG	MK-DS MD-PS8SR	—	—
MD-PS8SR	MKS-LS-RG	MK-DS MD-PS8SR	—	—
MD-SP 12**	MKS-L	MK-DS MD-SP12	MKS-SC	MKS-SC-DS MD-SP12
MD-SP 22**	MKS-L	MK-DS MD-SP22	MKS-SC-JK	MKS-SC-DS MD-SP22
PSL-40(T)	MKS-L (Note 1)	MK-DS PSL40	—	—
PSL-60(T)	MKS-L (Note 1)	MK-DS PSL60	—	—
PSL-80(T)	MKS-L (Note 1)	MK-DS PSL80	—	—
RA-SC1290	MKS-L	MK-DS RA-SC12	MKS-SC	MKS-SC-DS RA-SC12
RF-SC 22**	MKS-L	MK-DS RF-SC22	—	—
SAA-21(T)-**	MK-L	MK-DS SAA21	—	—
SAA-50(T)-**	MK-L	MK-DS SAA50	—	—
SAA-51(T)-**	MK-L	MK-DS SAA51	—	—
SAB-51(T)-**	MK-L	MK-DS SAB51	—	—
SAD-01T-**	MK-L	MK-DS SAD01	—	—
SAN-002T-0.8A	MKS-L MKS-LS	MK-DS SAN002-08	MKS-SC	MKS-SC-DS SAN002-08
SAN-002T-0.8K				
SBH-001T-P0.5	MKS-L	MK-DS SBH001-05	—	—
SBT-31(T)-001	MKS-L	MK-DS SBT31-001	—	—
SBT-31(T)-002	MK-L MKS-L	MK-DS SBT31-002	—	—
SBT-31(T)-003				
SCN-001T-1.0K	MKS-L	MK-DS SCN001-10	MKS-SC	MKS-SC-DS SCN001-10
SCN-001T-P1.0				
SCS-41T-2.3	MK-L	MK-DS SCS41-23	—	—
SDF-01T-1.0A	MKS-L	MK-DS SDF01-13	—	—
SDF-01T-1.3AS				
SDN-21T-P1.5	MKS-L	MK-DS SDN21-15	—	—
SDY-01T-P1.6ASV	MKS-L	MK-DS SDY01-16AS	—	—
SEH-001T-P0.6	MKS-L MKS-LS	MK-DS SEH001-06	MKS-SC	MKS-SC-DS SEH001-06
SEH-003T-P0.6L	MKS-L-10	MK-DS SEH003-06	MKS-SC	MKS-SC-DS SEH003-06L
SFO-1.0(T)-250N	MKS-L-FO	MK-DS SFO1.0-250N	—	—
SFO-2.5(T)-250N	MKS-L-FO	MK-DS SFO2.5-250N	—	—
SFO-41(T)-187N	MKF-L-187	MK-DS SFO41-187N	—	—
SFO-61(T)-250A	MKF-L-250	MK-DS SFO61-250A	—	—
SFO-41T-2.3	MKF-L-2.3	MK-DS SFO41-23	—	—
SFPS-41T-187	MKF-L-SP187	MK-DS SFPS41-187	—	—
SFPS-61T-250	MKF-L-SP250	MK-DS SFPS61-250	—	—
SFT-61T-250N	MKS-L	MK-DS SFT61-250N	—	—
SGF-21(T)-5	MK-L	MK-DS SGF21-5	—	—
SGF-41(T)-4	MK-L	MK-DS SGF41-4	—	—
SGF-51(T)-5	MK-L	MK-DS SGF51-5	—	—
SGF-51T-5A				

(Note 1) The safety cover specification for this applicator is different from that of the other MKS-L applicators. Use the model number "MKS-L2 WITH SAFETY COVER" when ordering one "with safety cover."

Crimping tools and machines

Applicator for fully automatic machine		Hand tools			Extraction and Insertion tools	
Applicator	Die set	YRS series	YC series	Terminal model No.	Extraction tool	Insertion tool
—	—	—	—	—	—	—
—	—	—	—	—	—	—
—	—	—	—	—	—	—
—	—	—	—	—	—	—
—	—	—	—	—	—	—
—	—	YRS-470	—	—	MEJ-06	—
—	—	YRS-460	—	—	MEJ-06	—
—	—	—	—	—	—	—
—	—	—	—	—	—	—
—	—	—	—	—	—	—
—	—	YRS-231	—	—	EJ-RA	—
AMKS-L	AMK-DS RF-SC22	—	(Note3)	RF BC22**	—	—
—	—	—	YC-141	LAA 21(T) **	—	—
AMK-R	AMK-DS SAA50	—	YC-182	LAA 50(T) **	—	—
AMK-R	AMK-DS SAA51	—	YC-142	LAA 51(T) **	—	—
—	—	—	YC-142	LAB 51(T) **	—	—
—	—	—	—	—	—	—
AMKS-L	AMK-DS SAN002-08	YRS-220	—	—	—	PHJ-05
—	—	—	YC-670R	BBH-001T-P0.5	—	—
—	—	—	—	—	—	—
AMKS-L	AMK-DS SBT31-002	—	—	—	—	—
AMKS-L	AMK-DS SCN001-10	YRS-191	—	—	—	—
—	—	—	—	—	CSJ-23	—
AMKS-L	AMK-DS SDF01-13	—	YC-045	LDF-01T-1.3A LDF-01T-1.3AS	— —	— —
—	—	—	—	—	—	—
—	—	—	—	—	YLJ-0.5	—
AMKS-L	AMK-DS SEH001-06	YRS-260	YC-260R	BEH-001T-P0.6	—	—
—	—	—	—	—	—	—
AMKS-L-FO	AMK-DS SFO1.0-250N	(Note 2)	—	—	—	—
AMKS-L-FO	AMK-DS SFO2.5-250N		—	—	—	—
AMKF-R	AMK-DS SFO41-187N		—	—	—	—
AMKF-R	AMK-DS SFO61-250N		—	—	—	—
—	—	—	—	—	—	—
—	—	—	—	—	—	—
—	—	—	—	—	—	—
—	—	YRS-510	YC-510	BFT-61T-250N	—	—
AMK-R	AMK-DS SGF21-5	—	—	—	—	—
—	—	—	YC-055	LGF-41(T)-4	—	—
AMK-R	AMK-DS SGF51-5	—	YC-065	LGF-51(T)-5 LGF-51-5A	— —	— —

(Note 2) Contact J.S.T. Europe N.V. for the applicable hand tools.

(Note 3) YC series for this contact is not available. Use YRM-230 instead.

Crimping tools and machines

Terminals and parts model number in alphabetical order	Standard crimp applicator		Strip-crimp applicator	
	Applicator	Die set	Applicator	Die set
SGM-21(T)-5	MK-L	MK-DS SGM21-5	—	—
SGM-51(T)-4	MK-L	MK-DS SGM51-4	—	—
SGM-51(T)-5	MK-L	MK-DS SGM51-5	—	—
SHC-21(T)-001	MKS-L-HC	MK-DS SHC21-001	—	—
SHC-21(T)-002				
SHF-001T-0.8BS	MKS-L MKS-LS	MK-DS SHF001-08S	MKS-SC	MKS-SC-DS SHF001-08S
SHF-002T-0.8BS	MKS-L MKS-LS	MK-DS SHF002-08S	MKS-SC	MKS-SC-DS SHF002-08S
SHR-001T-P0.6	MKS-L	MK-DS SHR/MR001-06	MKS-SC	MKS-SC-DC-SHR/MR001-06
SIM-1.0(T)-250D	MK-L-IM	MK-DS SIM1.0-250D	—	—
SIM-2.5(T)-250D	MK-L-IM	MK-DS SIM2.5-250D	—	—
SIM-01(T)-110A	MK-L	MK-DS SIM01-110A	—	—
SIM-21(T)-250	MK-L	MK-DS SIM21-250	—	—
SIM-41(T)-110B	MK-L	MK-DS SIM41-110B	—	—
SIM-51(T)-250N	MK-L	MK-DS SIM51-250N	—	—
SIN-001T-1.2	MKS-L	MK-DS SIN001-12	MKS-SC	MKS-SC-DS SIN001-12
SIN-001T-1.2B	MKS-L	MK-DS SIN001-12B	MKS-SC	MKS-SC-DS SIN001-12B
SIN-002T-1.0	MKS-L	MK-DS SIN002-10	MKS-SC	MKS-SC-DS SIN002-10
SIN-002T-1.0S	MKS-L-IN	MK-DS SIN002-10S	—	—
SIN-002T-1.2N	MKS-L	MK-DS SIN002-12N	MKS-SC	MKS-SC-DS SIN002-12N
SIN-01T-1.2	MKS-L	MK-DS SIN01-12	MKS-SC	MKS-SC-DS SIN01-12
SIN-01T-1.8(N)	MKS-L	MK-DS SIN01-18	MKS-SC	MKS-SC-DS SIN01-18
SIN-21T-1.8	MKS-L	MK-DS SIN21-18	—	—
SIN-21T-1.8S	MKS-L-SIN	MK-DS SIN21-18S	MKS-SC	MKS-SC-DS SIN21-18S
SIN-41T-2.4S	MKS-L-SIN	MK-DS SIN41-24S	—	—
SIN-61T-2.6S	MKS-L-SIN	MK-DS SIN61-26S	—	—
SLC-21T-2.0	MKS-L	MK-DS SLC21-20	—	—
SLC-22T-2.0	MKS-L	MK-DS SLC22-20	—	—
SLF/M-01T-P1.3E	MKS-L	MK-DS SLF/M01-13E	MKS-SC	MKS-SC-DS SLF/M01-13E
SLF/M-41T-P1.3E	MKS-L	MK-DS SLF/M41-13E	MKS-SC	MKS-SC-DS SLF/M41-13E
SLF/M-42T-P1.3E	MKS-L	MK-DS SLF/M42-13E	—	—
SMF-01T-1.0	MKS-L	MK-DS SMF01-10	—	—
SMF-01T-1.3	MKS-L	MK-DS SMF01-13	—	—
SMM-003T-0.5	MKS-L MKS-LS	MK-DS SMM003-05	MKS-SC	MKS-SC-DS SMM003-05
SMR-001T-0.6	MKS-L	MK-DS SHR/MR001-06	—	—
SOM-21(T)-187	MK-L	MK-DS SOM21-187	—	—
SOM-51(T)-250	MK-L	MK-DS SOM51-250	—	—
SPC-01(T)	MKS-L (Note 1)	MK-DS SPC01	—	—
SPC-20(T)	MKS-L (Note 1)	MK-DS SPC20	—	—

(Note 1) The safety cover specification for this applicator is different from that of the other MKS-L applicators. Use the model number "MKS-L2 WITH SAFETY COVER" when ordering one "with safety cover."

Crimping tools and machines

Applicator for fully automatic machine		Hand tools			Extraction and Insertion tools	
Applicator	Die set	YRS series	YC series	Terminal model No.	Extraction tool	Insertion tool
AMK-R	AMK-DS SGM21-5	—	—	—	—	—
—	—	—	YC-056	LGM-51(T)-4	—	—
AMK-R	AMK-DS SGM51-5	—	YC-056	LGM-51(T)-5	—	—
—	—	—	—	—	—	—
AMKS-L	AMK-DS SHF001-08S	YRS-122	YC-122R	BHF-001T-0.8BS	SMJ-06	—
AMKS-L	AMK-DS SHF002-08S	YRS-300	—	—	SMJ-06	—
—	—	YRS-580	YC-580R	BHR-001T-P0.6	—	—
AMK-R-IM	AMK-DS SIM1.0-250D	(Note 2)	—	—	—	—
AMK-R-IM	AMK-DS SIM2.5-250D				—	—
AMK-R	AMK-DS SIM01-110A	—	YC-054	LIM-01(T)-110A	—	—
—	—	—	—	—	—	—
AMK-R	AMK-DS SIM41-110B	—	YC-067	LIM-41(T)-110B	—	—
AMK-R	AMK-DS SIM51-250N	—	YC-321	LIM-51(T)-250N	—	—
AMKS-L	AMK-DS SIN001-12	YRS-034	—	—	—	—
AMKS-L	AMK-DS SIN001-12B	—	—	—	—	—
AMKS-L	AMK-DS SIN002-10	—	—	—	—	—
—	—	YRS-035	—	—	—	—
AMKS-L	AMK-DS SIN002-12N	—	—	—	—	—
AMKS-L	AMK-DS SIN01-12	—	—	—	—	—
AMKS-L	AMK-DS SIN01-18	—	—	—	—	—
AMKS-L	AMK-DS SIN21-18	—	—	—	—	—
—	—	—	—	—	—	—
—	—	—	—	—	—	—
—	—	—	—	—	—	—
AMKS-L	AMK-DS SLC21-20	—	YC-310	LLC-21T-2.0	—	—
—	—	—	—	—	—	—
AMKS-L	AMK-DS SLF/M01-13E	—	YC-202	LLF/M-01T-P1.3E	LEJ-13	LIT-2013
AMKS-L	AMK-DS SLF/M41-13E	—	YC-203	LLF/M-41T-P1.3E	—	—
—	—	—	—	—	—	—
AMKS-L	AMK-DS SMF-01-10	—	YC-081	LMF-01T-1.0	—	—
—	—	—	YC-082	LMF-01T-1.3	—	—
—	—	YRS-800	—	—	—	—
—	—	—	YC-580R	BMR-001T-0.6E	HRWJ	—
—	—	—	YC-680	LOM-21(T)-187	—	—
—	—	—	YC-066	LOM-51(T)-250	—	—
—	—	—	—	—	—	—
—	—	—	—	—	—	—

(Note 2) Contact J.S.T. Europe N.V. for the applicable hand tools.

Crimping tools and machines

Terminals and parts model number in alphabetical order	Standard crimp applicator		Strip-crimp applicator	
	Applicator	Die set	Applicator	Die set
SPC-40(T)	MKS-L (Note 1)	MK-DS SPC40	—	—
SPB-1.0(T)-250N	MKS-L-PB	MK-DS SPB1.0-250N	—	—
SPB-2.5(T)-250N	MKS-L-PB	MK-DS SPB2.5-250N	—	—
SPC-1.0(T)	MK-L-PC	MK-DS SPC1.0	—	—
SPC-2.5(T)	MK-L-PC	MK-DS SPC2.5	—	—
SPF-01T-2.5C	MK-L	MK-DS SPF01-25C	—	—
SPH-002T-P0.5S	MKS-L MKS-LS	MK-DS SPH002-05S	MKS-SC	MKS-SC-DS SPH002-05S
SPH-004T-P0.5S	MKS-L-10	MK-DS SPH004-05S	—	—
SPHD-001T-P0.5	MKS-L-10 MKS-LS-10	MK-DS SPH001-05	MKS-SC-10	MKS-SC-DS SPHD001-05
SPHD-002T-P0.5	MKS-L-10 MKS-LS-10	MK-DS SPHD002-05	MKS-SC-10	MKS-SC-DS SPHD002-05
SPJ-002T-1.2	MKS-L	MK-DS SPJ002-14/N12	—	—
SPJ-002T-1.4		or MK-DS SPJ002-14/N16		
SPS-01T-110	MK-L-SPS	MK-DS SPS01-110	—	—
SPS-01T-187	MK-L-SPS	MK-DS SPS01-187	—	—
SPS-41T-110	MK-L-SPS	MK-DS SPS41-110	—	—
SPS-51T-187	MK-L-SPS	MK-DS SPS51-187	—	—
SPS-61T-250	MK-L-SPS	MK-DS SPS61-250	—	—
SPS-61T-250S	MK-L-SPS	MK-DS SPS61-250	—	—
SPS-91T-250S	MK-L-SPS	MK-DS SPS91-250	—	—
SRA-01(T)-**	MK-L	MK-DS SRA01	—	—
SRA-20(T)-**	MK-L	MK-DS SRA20	—	—
SRA-21(T)-**	MK-L	MK-DS SRA21	—	—
SRA-50(T)-**	MK-L	MK-DS SRA50	—	—
SRA-51(T)-**	MK-L	MK-DS SRA51	—	—
SRB-1.0(T)-M3/4	MK-L	MK-DS SRB1.0-W8	—	—
SRB-1.0(T)-M5-W8				
SRB-1.0(T)-M3/4-W9.5	MK-L	MK-DS SRB1.0 W9.5	—	—
SRB-1.0(T)-M5/6				
SRB-2.5(T)-M3/4	MK-L	MK-DS SRB2.5 W8	—	—
SRB-2.5(T)-M5-W8				
SRB-2.5(T)-M3/4-W9.5	MK-L	MK-DS SRB2.5 W9.5	—	—
SRB-2.5(T)-M5/6				
SRB-50(T)-**	MK-L	MK-DS SRB50	—	—
SRB-51(T)-**	MK-L	MK-DS SRB51	—	—
SRC-01(T)-**	MK-L	MK-DS SRC01	—	—
SRC-50(T)-**	MK-L	MK-DS SRC50	—	—
SRC-51(T)-**	MK-L	MK-DS SRC51	—	—
SRD-20(T)-**	MK-L	MK-DS SRD20	—	—
SRGB-002T-0.3J	MKS-L	MK-DS SRGB002-03J	MKS-SC	MKS-SC-DS SRGB002-03
SRF-51(T)-**	MK-L	MK-DS SRF51	—	—
SRT-1.0T/N-M5S	MK-L	MK-DS SRT1.0-M5	—	—
SRT-2.5T/N-M5S	MK-L	MK-DS SRT2.5-M5	—	—

(Note 1) The safety cover specification for this applicator is different from that of the other MKS-L applicators. Use the model number "MKS-L2 WITH SAFETY COVER" when ordering one "with safety cover ."

Crimping tools and machines

Applicator for fully automatic machine		Hand tools			Extraction and Insertion tools	
Applicator	Die set	YRS series	YC series	Terminal model No.	Extraction tool	Insertion tool
—	—	—	—	—	—	—
AMKS-L-PB	AMK-DS SPB1.0-250N	(Note 2)	—	—	—	—
AMKS-L-PB	AMK-DS SPB2.5-250N					
AMK-R-PC	AMK-DS SPC1.0					
AMK-R-PC	AMK-DS SPC2.5					
—	—	YRS-241	YC-043R	LPF-01T-2.5C	—	—
AMKS-L	AMK-DS SPH002-05S	YRS-240	—	—	PHJ-05	—
—	—	—	—	—	PHJ-05	—
—	—	—	YC-610R	BPHD-001T-P0.5	EJ-PHD	—
—	—	YRS-620	—	—	EJ-PHD	—
—	—	—	—	—	—	—
AMK-R	AMK-DS SPS01-110	—	—	—	—	—
AMK-R	AMK-DS SPS01-187	—	YC730 YC731 (Note 5)	LPS-01T-187	EJ-PS187	—
AMK-R	AMK-DS SPS41-110	—	—	—	—	—
AMK-R	AMK-DS SPS51-187	—	YC710 YC711 (Note 6)	LPS-51T-187	EJ-PS187	—
AMK-R	AMK-DS SPS61-250	—	YC720 YC721 (Note 7)	LPS-61T-250	EJ-PS250	—
AMK-R	AMK-DS SPS61-250	—	—	—	—	—
AMK-R	AMK-DS SPS91-250	—	—	—	—	—
AMK-R	AMK-DS SRA01	—	—	—	—	—
AMK-R	AMK-DS SRA20	—	YC-181	LRA-20(T)-**	—	—
AMK-R	AMK-DS SRA21	—	YC-141	LRA-21(T)-**	—	—
AMK-R	AMK-DS SRA50	—	YC-182	LRA-50(T)-**	—	—
AMK-R	AMK-DS SRA51	—	YC-142	LRA-51(T)-**	—	—
AMK-R	AMK-DS SRB1.0-W8	(Note 2)	—	—	—	—
AMK-R	AMK-DS SRB1.0-W9.5					
AMK-R	AMK-DS SRB2.5-W8					
AMK-R	AMK-DS SRB2.5-W9.5					
—	—	—	—	—	—	—
AMK-R	AMK-DS SRB51	—	YC-142	LRB-51(T)-**	—	—
AMK-R	AMK-DS SRC01	—	YC-033	LRC-01(T)-**	—	—
AMK-R	AMK-DS SRC50	—	YC-183	LRC-50(T)-**	—	—
AMK-R	AMK-DS SRC51	—	YC-142	LRC-51(T)-**	—	—
AMK-R	—	—	—	—	RGB-EJ-A,RGB-EJ-B	—
—	—	—	—	—	—	—
—	—	—	YC-142	LRF-51(T)-**	—	—
—	—	(Note 2)	—	—	—	—
—	—					

(Note 2) Contact J.S.T. Europe N.V. for the applicable hand tools.

(Note 5) YC-730 is for AWG#26 and #22 wires, while YC-731 is for AWG#24 and #20 wires.

(Note 6) YC-710 is for AWG#20 and #16 wires, while YC-711 is for AWG#18 and #14 wires.

(Note 7) YC-720 is for AWG#18 and #16 wires, while YC-721 is for AWG#14 wires.

Crimping tools and machines

Terminals and parts model number in alphabetical order	Standard crimp applicator		Strip-crimp applicator	
	Applicator	Die set	Applicator	Die set
SRT-51T-3FE	MK-L	MK-DS SRT51	-	-
SRT-51T-4FE				
SSF/M-01T-P1.4	MKS-L	MK-DS SSF/M01-14	-	-
SSF/M-21T-P1.4	MKS-L	MK-DS SSF/M21-14	-	-
STB-01T-001	MKS-L	MK-DS STB01-001	-	-
STB-001T-P	MKS-L	MK-DS STB001-P	-	-
STI-1.0(T)-250D	MK-L	MK-DS STI-1.0-250D/N	-	-
STI-1.0(T)-250N				
STI-2.5(T)-250D	MK-L	MK-DS STI-2.5-250D/N	-	-
STI-2.5(T)-250N				
STI-01(T)-110N	MK-L	MK-DS STI01-110N	-	-
STI-41(T)-110N	MK-L	MK-DS STI41-110N	-	-
STI-51(T)-250N	MK-L	MK-DS STI51-250N	-	-
STO-1.0(T)-110N-5	MK-L	MK-DS STO1.0-110N	-	-
STO-1.0(T)-110N-8				
STO-1.0(T)-187N-5	MK-L	MK-DS STO1.0-187N	-	-
STO-1.0(T)-187N-8				
STO-1.0(T)-250N	MK-L	MK-DS STO1.0-250N	-	-
STO-2.5(T)-250N	MK-L	MK-DS STO2.5-250N	-	-
STO-6.0(T)-250N	MK-L	MK-DS STO6.0-250N	-	-
STO-01(T)-110N(-8)	MK-L	MK-DS STO01-110N	-	-
STO-01(T)-187N(-8)	MK-L	MK-DS STO01-187N	-	-
STO-21(T)-205N(-5)	MK-L	MK-DS STO21-205N	-	-
STO-21(T)-250N	MK-L	MK-DS STO21-250N	-	-
STO-41(T)-110N(-8)	MK-L	MK-DS STO41-110N	-	-
STO-41(T)-187N(-8)	MK-L	MK-DS STO41-187N	-	-
STO-41T-187S	MK-L	MK-DS STO41-187S	-	-
STO-61(T)-250N	MK-L	MK-DS STO61-250N	-	-
STO-62T-187N	MK-L	MK-DS STO62-187N	-	-
STO-62T-250N	MK-L	MK-DS STO62-250N	-	-
STO-81(T)-250N	MK-L	MK-DS STO81-250N	-	-
STO-82T-187N	MK-L	MK-DS STO82-187N	-	-
SVA-41T-P1.1	MKS-L	MK-DS SVA41-11	MKS-SC	MKS-SC-DS SVA41-11
SVF-01T-1.5A	MK-L	MK-DS SVF01-15A	-	-
SVF-01T-1.5N	MKS-L	MK-DS SVF01-15N	-	-
SVF-01T-1.5S				
SVF-01T-2.36LN	MKS-L	MK-DS SVF01-236LN	-	-
SVF-01T-2.36N	MK-L	MK-DS SVF01-236N	-	-
SVF-42T-P2.0	MKS-L	MK-DS SVF/M42-20	-	-
SVF/M-61T-P2.0	MKS-L	MK-DS SVF/M61-20	-	-
SVF/M-81T-P2.0	MKS-L	MK-DS SVF/M81-20	-	-
SVH-21T-P1.1	MKS-L	MK-DS SVH21-11	MKS-SC	MKS-SC-DS SVH21-11
SVT-41T-P1.1	MKS-L	MK-DS SVT41-11	-	-
SWS-40-01	MK-L	MK-DS SWS40-01	-	-

(Note 1) The safety cover specification for this applicator is different from that of the other MKS-L applicators. Use the model number "MKS-L2 WITH SAFETY COVER" when ordering one "with safety cover."

Crimping tools and machines

Applicator for fully automatic machine		Hand tools			Extraction and Insertion tools	
Applicator	Die set	YRS series	YC series	Terminal model No.	Extraction tool	Insertion tool
-	-	-	YC-143R	LRT-51T-3FE	-	-
				LRT-51T-4FE	-	-
AMKS-L	AMK-DS SSF/M01-14	-	YC-500	BSF/M-01T-P1.4	SLJ-1.4	ITBL-08V
AMKS-L	AMK-DS SSF/M21-14	-	YC-550	BSF/M-21T-P1.4	SLJ-1.4	-
AMKS-L	AMK-DS STB01-001	-	-	-	-	-
-	-	-	-	-	-	-
AMK-R	AMK-DS STI1.0-250 D/N	(Note 2)			-	-
AMK-R	AMK-DS STI2.5-250 D/N				-	-
AMK-R	AMK-DS STI01-110N	-	YC-041	LTI-01(T)-110N	-	-
AMK-R	AMK-DS STI41-110N	-	YC-063	LTI-41(T)-110N	-	-
AMK-R	AMK-DS STI51-250N	-	YC-322	LTI-51(T)-250N	-	-
AMK-R	AMK-DS STO1.0-110N	(Note 2)			-	-
AMK-R	AMK-DS STO1.0-187N				-	-
AMK-R	AMK-DS STO1.0-250N				-	-
AMK-R	AMK-DS STO2.5-250N				-	-
-	-				-	-
AMK-R	AMK-DS STO01-110N	-	YC-041	LTO-01(T)-110N(-8)	-	-
AMK-R	AMK-DS STO01-187N	-	YC-042	LTO-01(T)-187N(-8)	-	-
AMK-R	AMK-DS STO21-205N	-	-	-	-	-
AMK-R	AMK-DS STO21-250N	-	YC-102	LTO-21(T)-250N	-	-
AMK-R	AMK-DS STO41-110N	-	YC-062	LTO-41(T)-110N(-8)	-	-
AMK-R	AMK-DS STO41-187N	-	YC-051	LTO-41T-187N	-	-
AMK-R	-	-	YC-064	LTO-41T-187S	-	-
-	AMK-DS STO61-250N	-	YC-047	LTO-61(T)-250N	-	-
AMK-R	-	-	-	-	-	-
-	-	-	-	-	-	-
-	AMK-DS STO81-250N	-	YC-280	LTO-81(T)-250N	-	-
AMK-R	-	-	-	-	-	-
-	-	-	YC-450	BVA-41T-P1.1	EJ-SMP	-
-	AMK-DS SVF01-15A	-	YC-044	LVF-01T-1.5A	-	-
AMKS-L	AMK-DS SVF01-15N	-	YC-151	LVF-01T-1.5N	-	-
		-	-	-	-	-
AMKS-L	AMK-DS SVF01-236LN	-	-	-	LVJ-08	-
AMK-R	AMK-DS SVF01-236N	-	YC-152	LVF-01T-2.36N	LVJ-08	-
AMKS-L	AMK-DS SVF/M42-20	-	-	-	VLJ-20	-
-	-	-	YC-590	BVF/M-61T-P2.0	VLJ-20	-
AMKS-L	AMK-DS SVF/M81-20	-	(Note 4)	BVF/M-81T-P2.0	VLJ-20	-
AMKS-L	AMK-DS SVH21-11	-	YC-160R	BVH-21T-P1.1	EJ-NV	-
-	-	-	YC-630	LVT-41T-P1.1	EJ-VT	-
-	-	-	-	-	-	-

(Note 2) Contact J.S.T. Europe N.V. for the applicable hand tools.

(Note 4) YC series for this contact is not available. Use YRF-591 instead.

Crimping tools and machines

Terminals and parts model number in alphabetical order	Standard crimp applicator		Strip-crimp applicator	
	Applicator	Die set	Applicator	Die set
SXA-001T-P0.6	MKS-L	MK-DS SXA/M001-06	MKS-SC	MKS-SC-DS-SXA/M-001-06
SXA-01T-P0.6	MKS-L	MK-DS SXA/M01-06	—	—
SXF-01T-P0.7	MKS-L	MK-DS SXF01-07	—	—
SXF-41T-P0.7	MKS-L	MK-DS SXF41-07	—	—
SXH-001T-P0.6	MKS-L MKS-LS	MK-DS SXH001-06	MKS-SC	MKS-SC-DS SXH001-06
SXH-002T-P0.6	MKS-L MKS-LS	MK-DS SXH002-06	MKS-SC	MKS-SC-DS SXH002-06
SXM-001T-P0.6	MKS-L	MK-DS SXA/M001-06	MKS-SC	MKS-SC-DS SXA/M-001-06
SYF-001T-P0.6	MKS-L	MK-DS SYF001-06	—	—
SYF/M-01T-P0.5A	MKS-L	MK-DS SYF/M01-05	MKS-SC-YL	MKS-SC-DS SYF/M01-06
SYF/M-41T-P0.5A	MKS-L	MK-DS SYF/M41-05	MKS-SC-YL	MKS-SC-DS SYF/M41-05
SYM-001T-P0.6	MKS-L MKS-LS	MK-DS SYM001-06	MKS-SC	MKS-SC-DS SYM001-06
SYM-01T-P0.7	MKS-L	MK-DS SYM01-07	—	—
SYM-41T-P0.7	MKS-L	MK-DS SYM41-07	—	—
SZF/M-01T-P0.7	MKS-L	MK-DS SZF/M01-07	—	—
SZF/M-41T-P0.7	MKS-L	MK-DS SZF/M41-07	—	—
SZH-002T-P0.5	MKS-L	MK-DS SZH002-05	—	—
SZH-003T-P0.5	MKS-L	MK-DS SZH003-05	MKS-SC	MKS-SC-DS SZH003-05
SZN-002T-P0.7K	MKS-L	MK-DS SZN002-07	—	—
SZN-003T-P0.7K	MKS-LS	MK-DS SZN003-07	MKS-SC	MKS-SC-DS SZN003-07

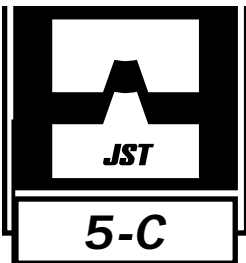

ATM-4

7



Fully automatic crimping machine.

Features

- The machine is controlled via a new touch sensitive visual display interface which is user friendly, and helps the operator program the machine in a simple step-by-step sequence.
- The strip length and cutter depth information is programmed into the machine via the touch sensitive visual display, and no longer requires the adjustment of spacer blocks. This development also has the advantage of allowing semi-strip operations to be processed on the machine.
- The in-out position of the stripped wire in relationship with the crimping position is adjustable via the touch sensitive screen, this feature eliminates manually moving the press forwards and backwards to obtain the correct wire placement in the terminal.
- The ATM-4 has a memory function enabling the set-up specifications of 250 jobs to be stored in the memory, so that frequently used set-ups can be recalled without re-setting the machine.
- The MCB-2 crimping presses on the ATM-4 have been developed to incorporate electromagnetic clutches which have the advantage of reducing noise generated by the machine.

Crimping tools and machines

Applicator for fully automatic machine		Hand tools			Extraction and Insertion tools	
Applicator	Die set	YRS series	YC series	Terminal model No.	Extraction tool	Insertion tool
—	—	—	YC-690R	BXA-001T-P0.6	EJ-XMP	IT-XA
—	—	—	—	—	—	—
AMKS-L	AMK-DS SXF01-07	—	YC-251	BXF-01T-(P)0.7	LEJ-7	—
AMKS-L	AMK-DS SXF41-07	—	YC-252	BXF-41T-(P)0.7	LEJ-7	—
AMKS-L	AMK-DS SXH001-06	YRS-110	YC-110R	BXH-001T-P0.7	XJ-06	—
AMKS-L	AMK-DS SXH002-06	YRS-480	—	—	XJ-06	—
—	—	—	YC-690R	BXM-001T-P0.6	EJ-XMR	—
AMKS-L	AMK-DS SYF001-06	—	—	—	—	—
AMKS-L	AMK-DS SYF/M01-05	—	YC-520	BYF/M-01T-P0.5	YLJ-0.5	—
AMKS-L	AMK-DS SYF/M41-05	—	YC-530	BYF/M-41T-P0.5	YLJ-0.5	—
AMKS-L	AMK-DS SYM001-06	—	YC-121R	BYM-001T-(P)0.6	SMJ-06	—
AMKS-L	AMK-DS SYM01-07	—	YC-251	BYM-01T-(P)0.7	LEJ-7	—
AMKS-L	AMK-DS SYM41-07	—	YC-252	BYM-41T-(P)0.7	LEJ-7	—
AMKS-L	AMK-DS SZF/M01-07	—	YC-390R	BZF/M-01T-(P)0.7	ZLJ-07(S)	—
AMKS-L	AMK-DS SZF/M41-07	—	YC-380R	BZF/M-41T-(P)0.7	ZLJ-07(S)	—
AMKS-L	AMK-DS SZH002-05	—	—	—	—	—
AMKS-L	AMK-DS SZH003-05	YRS-490	—	—	—	—
AMKS-L	AMK-DS SZN002-07	—	—	—	—	—
AMKS-L	AMK-DS SZN003-07	YRS-540	—	—	—	—

ATM-4

Productivity

The productivity of the ATM-4 is dependent on the length of the wires to be processed.

Production rate(leads per minute, using standard viny I wire)

Length mm(in.)	70 (2.756)	100 (3.937)	200 (7.874)	300 (11.811)	500 (19.685)	750 (29.528)	1000 (39.370)	1500 (59.055)	2000 (78.740)	2500 (98.425)	3000 (118.100)	3500 (137.795)
Speed	84	83	80	69	59	54	50	45	41	37	35	32

Specifications

- Dimensions: (WxLxH)1,800x2,300 x1,840mm(71" x91" x59")
- Weight: 1,050kg
- Power source: 415V AC, 3-phase, 50/60Hz
- Pneumatic supply: 5kg/cm²
- Maximum crimping capacity: 5,100 wires/hour
- Cutting length: 80 to 20,000mm(3.150" to 787.4") (Note1)
- Wire length accuracy: ±1.0mm(.039") on programmed length
- Strip length: 2 to 13mm(.079" to .512")(front end)
2 to 18mm(.079" to .709")(rear end)

Note1: It may be possible to process shorter lengths than 80mm depending on the wire type.
Contact JST for details.