

IEC Appliance Inlet C14 or C18 with Line Switch 1- or 2-pole



Screw-on mounting



Snap-in version



Screw-on mounting and line Switch illuminated



See below:
[Approvals and Compliances](#)

Description

- Panel mount :
 Screw-on version from front or rear side, snap-in version from front side
- Appliance Inlet protection class I or II , Line Switch 1- or 2-pole
- V-Lock notch standard
- Quick connect terminals 4.8 x 0.8 mm

Unique Selling Proposition

- Ultra compact design
- Line switch for high inrush currents
- Components internally wired
- V-Lock cord retaining

Characteristics

- All single elements are already wired
- Unwired versions available on request
- Line switch non-illuminated or illuminated
- Ideal for application with high transient loads
- Suitable for use in equipment according to IEC/UL 60950

Other versions on request

- Unwired versions
- Solder terminals
- Line switch with other rocker marking

References

Alternative: version with line filter [DC12](#)
 Substitute for type [KEB1](#); [KEB2](#); [6010-K](#)

Weblinks

[pdf datasheet](#), [html-datasheet](#), [General Product Information](#), [Distributor-Stock-Check](#), [Accessories](#), [Detailed request for product](#), [Microsite](#)

Technical Data

Ratings IEC	10A / 250VAC; 50Hz
Ratings UL/CSA	15A / 250VAC; 50/60Hz ¹⁾
Dielectric Strength	> 2.5kVAC between L-N > 3kVAC between L/N-PE (1 min/50Hz)
Allowable Operation Temperature	-25 °C to 70 °C
IP-Protection	from front side IP 40 acc. to IEC 60529
Insulation cover	Suitable for appliances with protection class I or II acc. to IEC 61140
Terminal	Quick connect terminals 4.8 x 0.8 mm
Panel Thickness S	Screw: max 6 mm Mounting screw torque max 0.5Nm Snap-in: 1/1.5/2/2.5/3 mm
Material: Housing	Thermoplastic, black, UL 94V-0

appliance inlet/-outlet	C14 / C18 acc. to IEC 60320-1, UL 498, CSA C22.2 no. 42 (for cold conditions) pin-temperature 70 °C, 10A, Protection Class I or II
Line Switch	Rocker switch 1 or 2 pole, non-illuminated or illuminated, acc. to IEC 61058-1 Technical Details

¹⁾ Standard version 12 A / special version 15A



Approvals and Compliances

Detailed information on product approvals, code requirements, usage instructions and detailed test conditions can be looked up in [Details about Approvals](#)

Approvals





The approval mark is used by the testing authorities to certify compliance with the safety requirements placed on electronic products.

Approval Reference Type: DC11

Approval Logo	Certificates	Certification Body	Description
	VDE Approvals	VDE	Certificate Number: 40007009
	UL Approvals	UL	UL File Number: E96454
	CQC Approvals	CQC	CCC Certificate Number: 2013010204594013



Product standards

Product standards that are referenced

Organization	Design	Standard	Description
	Designed according to	IEC 60320-1	Appliance couplers for household and similar general purposes
	Designed according to	IEC 61058-1	Switches for appliances. Part 1. General requirements
	Designed according to	UL 498	Standard for Attachment Plugs and Receptacles
	Designed according to	CSA C22.2 no. 42	General Use Receptacles, Attachment Plugs, and Similar Wiring Devices







Application standards

Application standards where the product can be used

Organization	Design	Standard	Description
	Designed for applications acc.	IEC/UL 60950	IEC 60950-1 includes the basic requirements for the safety of information technology equipment.
	Designed for applications acc.	IEC 60335-1	Safety of electrical appliances for household and similar purposes. Meets the requirements for appliances in unattended use. This includes the enhanced requirements of glow wire tests acc. to IEC 60695-2-12 and -13.

Compliances

The product complies with following Guide Lines

Identification	Details	Initiator	Description
	CE declaration of conformity	SCHURTER AG	The CE marking declares that the product complies with the applicable requirements laid down in the harmonisation of Community legislation on its affixing in accordance with EU Regulation 765/2008.
	RoHS	SCHURTER AG	EU Directive RoHS 2011/65/EU
	China RoHS	SCHURTER AG	The law SJ / T 11363-2006 (China RoHS) has been in force since 1 March 2007. It is similar to the EU directive RoHS.
	REACH	SCHURTER AG	On 1 June 2007, Regulation (EC) No 1907/2006 on the Registration, Evaluation, Authorization and Restriction of Chemicals 1 (abbreviated as "REACH") entered into force.
	MicrositeV-Lock	SCHURTER AG	V-Lock system are based on a matching plug-dose combination. The connector is equipped with a notch intended for use with the latching cordset. The cord latching system prevents against accidental removal of the cordset.
	White paperGlow wire test	SCHURTER AG	Meets the requirements of IEC 60335-1 for appliances in unattended use. This includes the enhanced requirements of glow wire tests acc. to IEC 60695-2-12 and -13.

Dimensions [mm]

Screw-on mounting

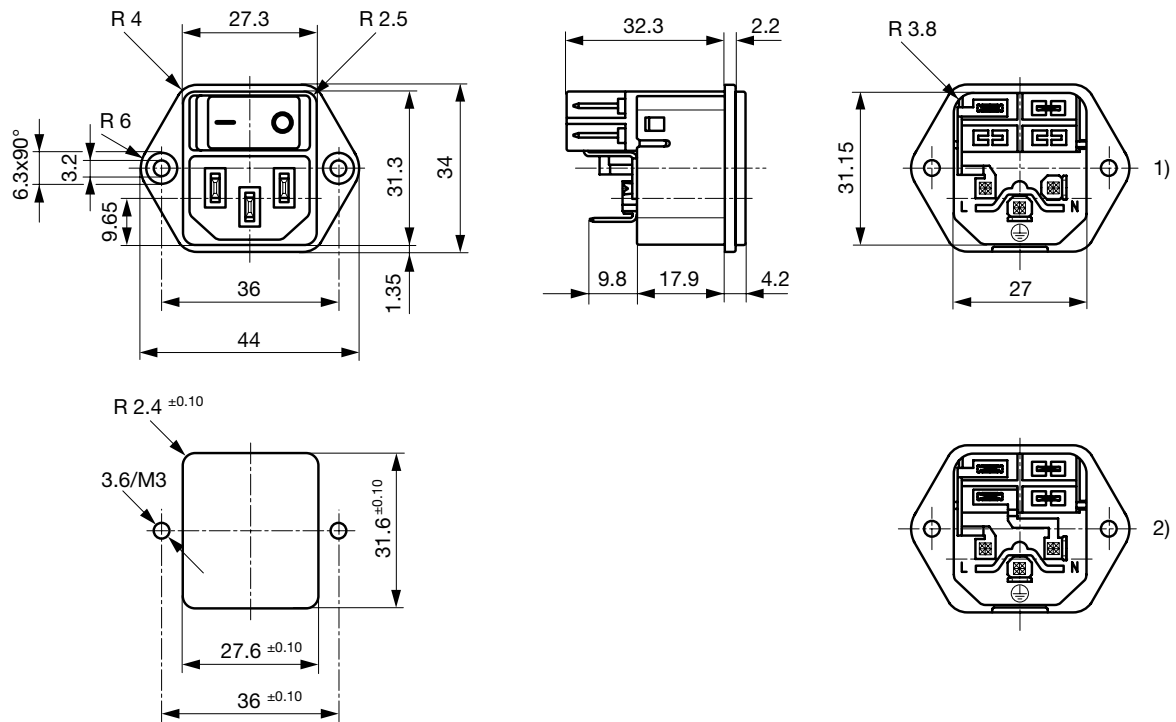

- 1) 1-pol non-illuminated
- 2) 2-pol illuminated, 2-pol non-illuminated

Snap-in mounting

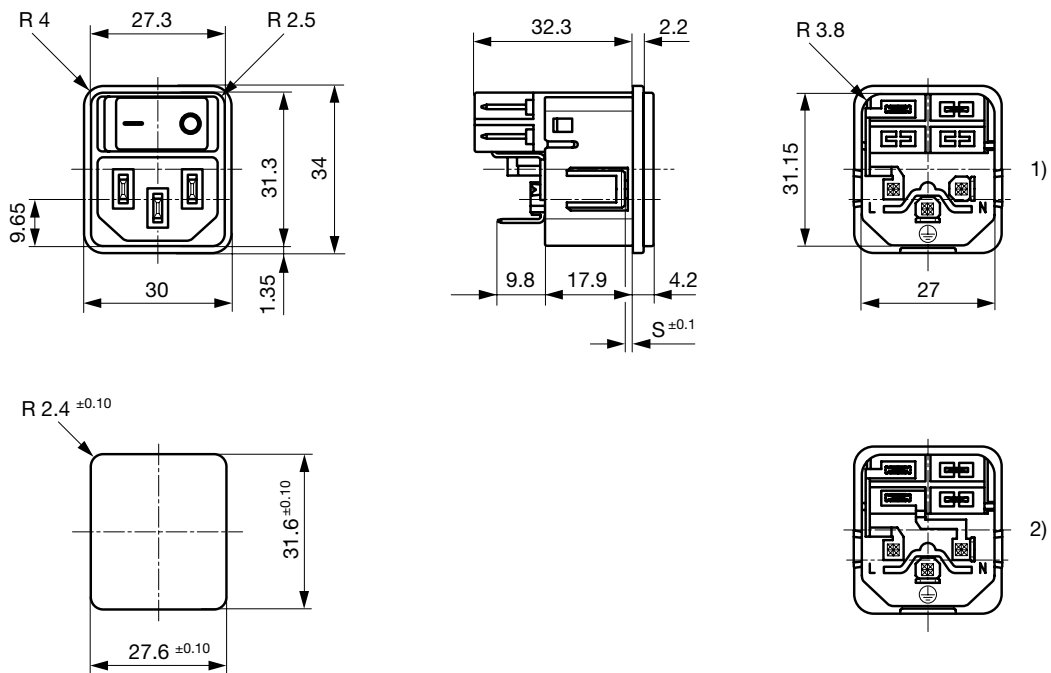

- 1) 1-pol non-illuminated
- 2) 2-pol illuminated, 2-pol non-illuminated

Diagrams

Line switch non-illuminated 2-pole

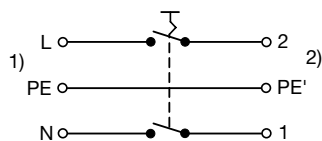

1) Line
2) Load

Line switch illuminated 2-pole

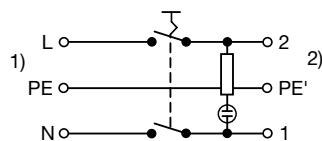

1) Line
2) Load

Line switch non-illuminated 1-pole

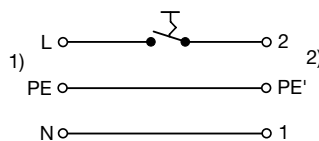

1) Line
2) Load

All Variants

Rated Current UL	Protection Class	Panel mounting	Panel Thickness s [mm]	Line Switch	Illumination	Color	Order Number
12	I	Snap-in	1.5	2-pole	●	red	DC11.0021.201
15	I	Snap-in	1.5	2-pole	●	red	DC11.0021.206
12	I	Snap-in	2	2-pole	●	red	DC11.0021.301
12	I	Snap-in	2.5	2-pole	●	red	DC11.0021.401
12	I	Snap-in	1.5	2-pole	●	green	DC11.0031.201
12	I	Snap-in	2	2-pole	●	green	DC11.0031.301
12	I	Snap-in	2.5	2-pole	●	green	DC11.0031.401
12	I	Snap-in	1.5	1-pole	-	-	DC11.0001.203
15	I	Snap-in	1.5	1-pole	-	-	DC11.0001.207
12	I	Snap-in	2	1-pole	-	-	DC11.0001.303
12	I	Snap-in	2.5	1-pole	-	-	DC11.0001.403
12	I	Snap-in	1.5	2-pole	-	-	DC11.0001.201
15	I	Snap-in	1.5	2-pole	-	-	DC11.0001.206
12	I	Snap-in	2	2-pole	-	-	DC11.0001.301
12	II	Snap-in	2	2-pole	-	-	DC11.0001.351
15	I	Snap-in	2.5	2-pole	-	-	3-107-445
12	I	Snap-in	2.5	2-pole	-	-	DC11.0001.401
12	I	Snap-in	3	2-pole	-	-	DC11.0001.501
12	I	Screw	-	2-pole	●	red	DC11.0021.001
15	I	Screw	-	2-pole	●	red	DC11.0021.006
12	I	Screw	-	2-pole	●	green	DC11.0031.001
12	I	Screw	-	1-pole	-	-	DC11.0001.003
15	I	Screw	-	1-pole	-	-	DC11.0001.007
12	I	Screw	-	2-pole	-	-	DC11.0001.001
15	I	Screw	-	2-pole	-	-	DC11.0001.006

Most Popular.

Availability for all products can be searched real-time: <https://www.schurter.com/en/Stock-Check/Stock-Check-SCHURTER>

With screw mounting on PCB, 2 screws are included

All variants according VDE (ENEC 10) approved for 10 A

Packaging unit 50 Pcs

Accessories

Description



Wire Harness
 Wire harness for SCHURTER products

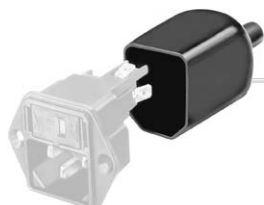

Assorted Covers
 Rear Cover

0859.0047

4311.9403



Cord retaining kits
 Cord retaining strain relief

Flat head, A

4700.0001

Countersunk, B

4700.0002

Mating Outlets/Connectors

Category / Description

Appliance Outlet Overview complete



IEC Appliance Outlet F, Screw-on Mounting, Front Side, Solder Terminal

4787

IEC Appliance Outlet F, Snap-in Mounting, Front Side, Solder or Quick-connect Terminal

4788

IEC Appliance Outlet F or H, Screw-on Mounting, Front Side, Solder, PCB or Quick-connect Terminal

5091

[Appliance Outlet further types to DC11](#)

Connector Overview complete



4782 Mounting: Power Cord, 3 x 1 mm² / 3 x 18 AWG, Cable, Connector: IEC C13

4782

4785 Mounting: Power Cord, 3 x 1 mm² / 3 x 18 AWG, Cable, Connector: IEC C13

4785

4300-06 Mounting: Power Cord, 3 x 1 mm² / 3 x 18 AWG, Cable, Connector: IEC C13

4300-06

IEC Connector C15 for hot conditions 120°C, Rewireable, Straight

4781

IEC Connector C15 for hot conditions 120°C, Rewireable, Angled

4784

[Connector further types to DC11](#)

...

Power Supply Cord Overview complete



Cord Sets 10 A, Europlug, 2.5 m, Connector IEC C13, H05VV-F3G1.0, black

6004.0215

Cord Sets 10 A, Europlug, 2.5 m, Connector IEC C13, H05VV-F3G1.0, black

6003.0215

[Power Supply Cord further types to DC11](#)

Mating Outlets/Connectors shuttered



[Power Cord Overview complete](#)

VAC13KS, Overview, diverse Connector IEC C13, cord end:

VAC13KS

Power cord with IEC connector C17, V-Lock, straight

VAC17KS

[Power Cord further types to DC11](#)