

STK5C4U3XXJGEVB

STK5C4U3xx Series Evaluation Board User's Manual



ON Semiconductor®

www.onsemi.com

Introduction

By using this board, STK5C4U3xx series (DIPS) can be evaluated.

EVAL BOARD USER'S MANUAL

ONPN of EVAL Board	ONPN of IPM	Io
STK5C4U332JGEVB	STK5C4U332J-E	3A

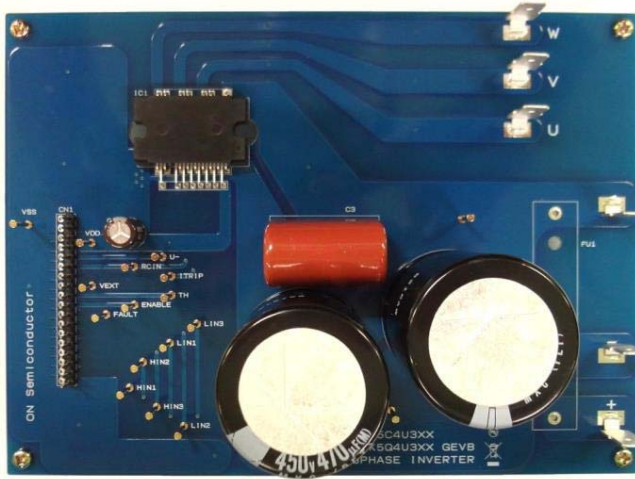

Surface

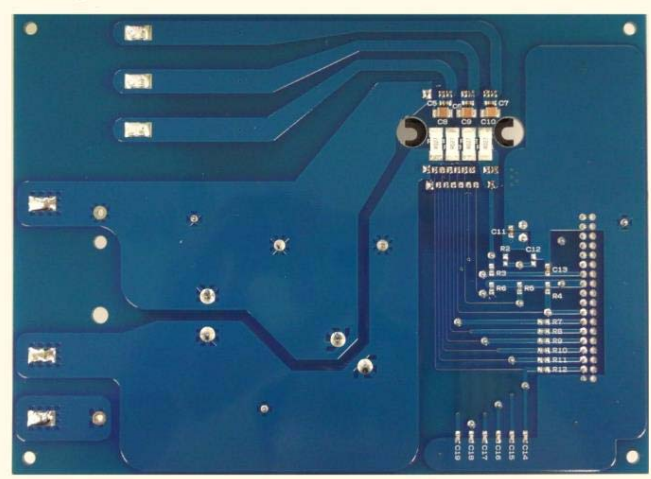

Back side

Figure 1. Evaluation Board Photos

STK5C4U3XXJGEVB

CIRCUIT DIAGRAM

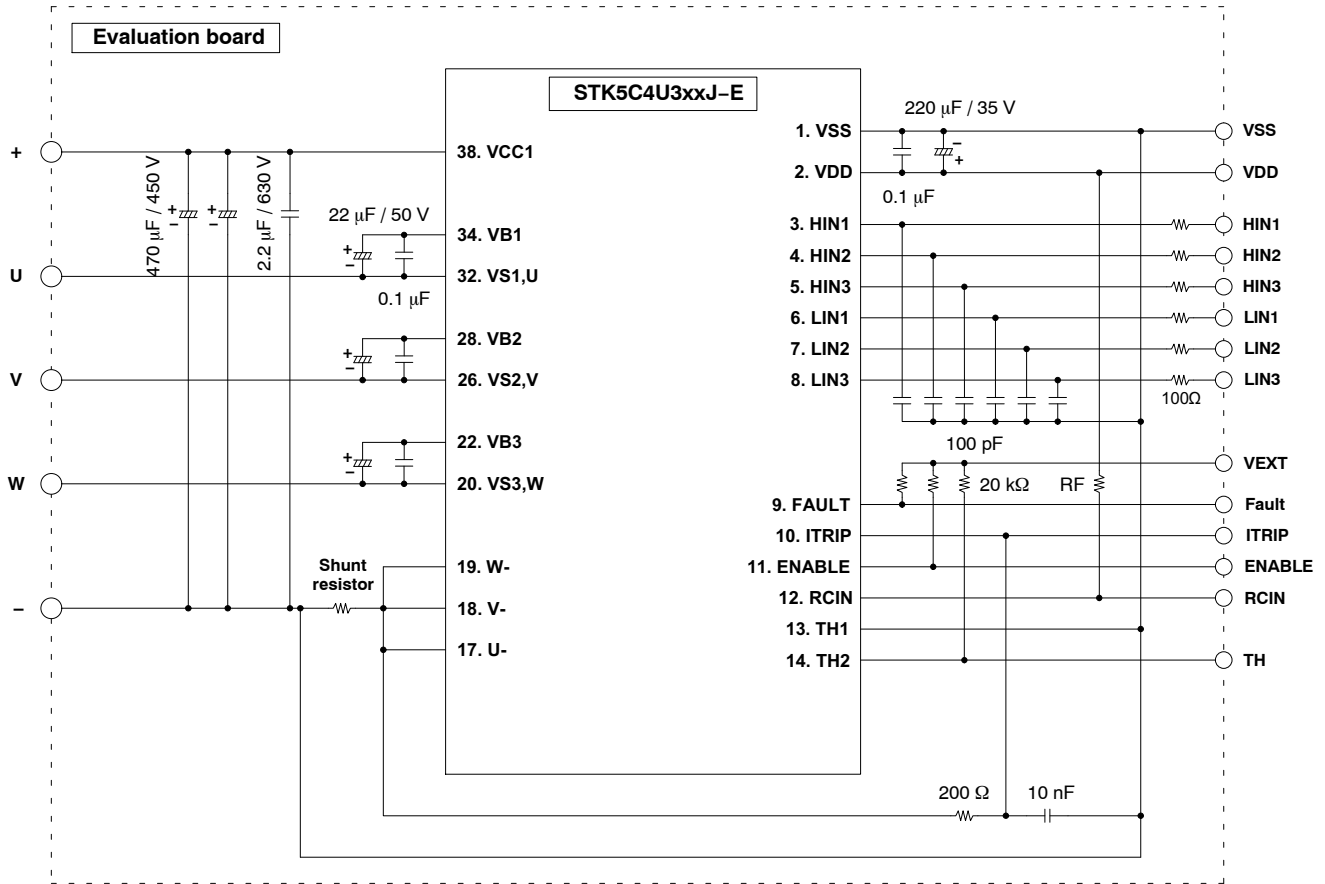

Figure 2. Circuit Diagram

STK5C4U3XXJGEVB

PIN DESCRIPTION

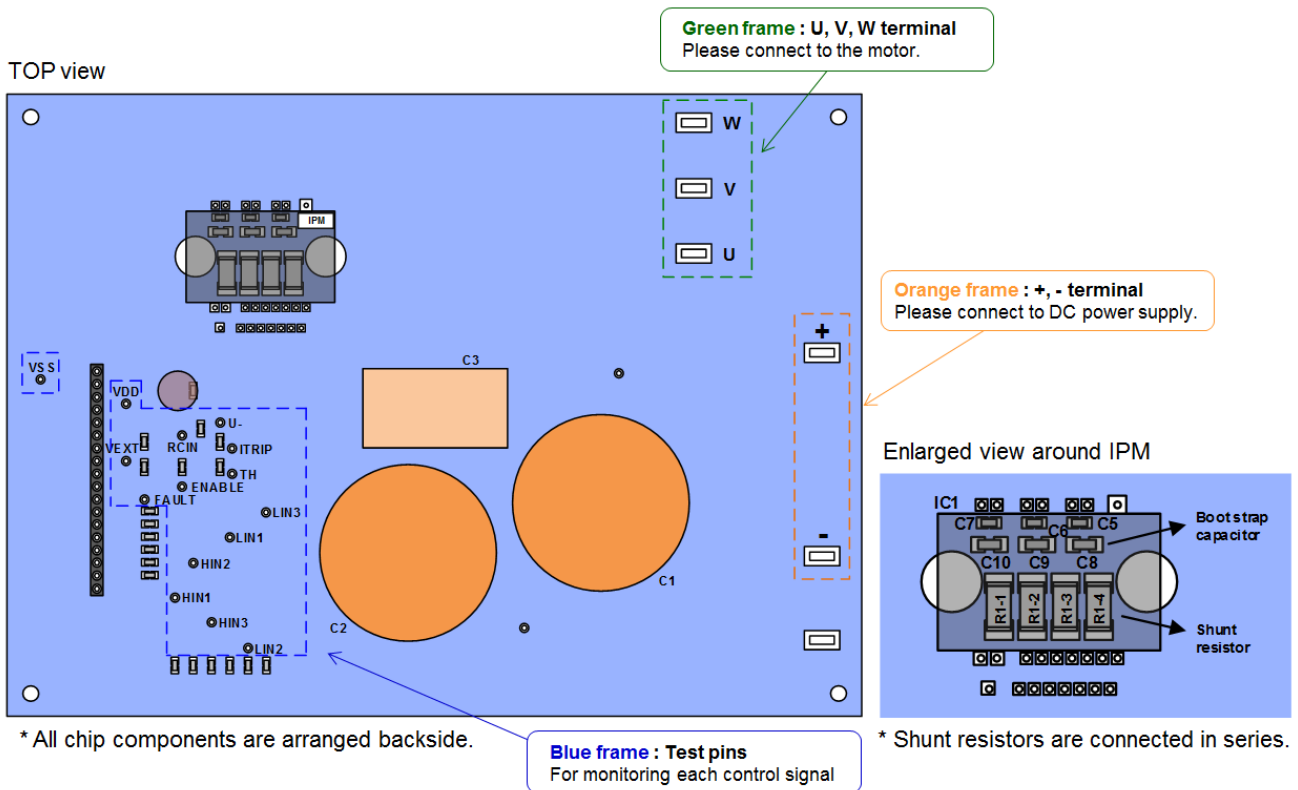

Figure 3. Pin Description 1

Enlarged view around test pins

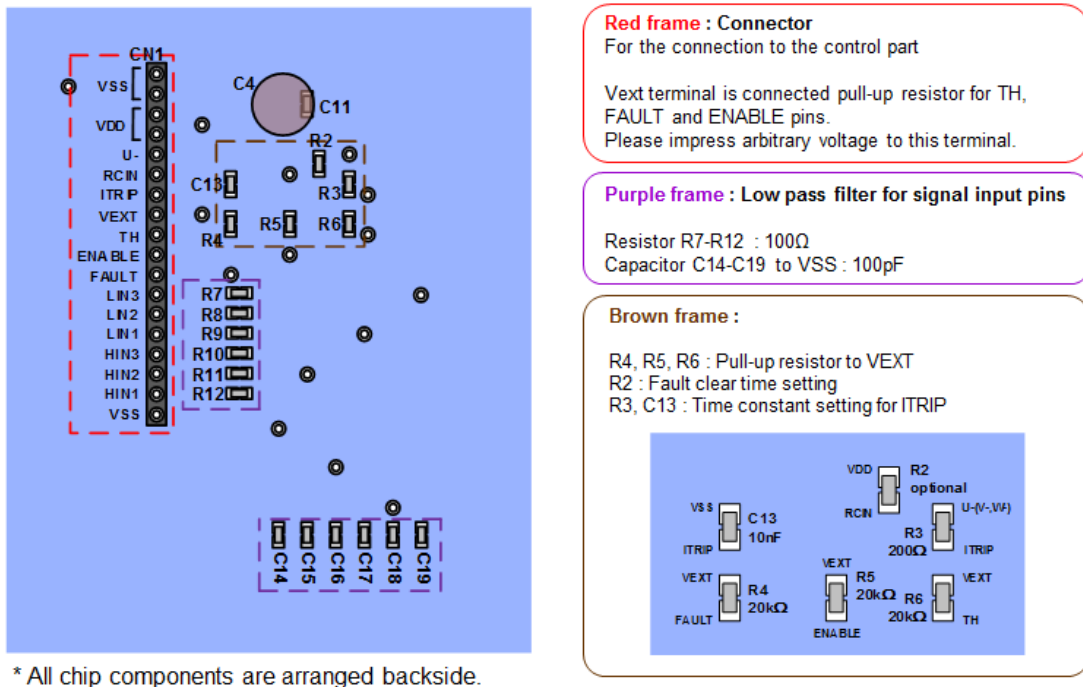

Figure 4. Pin Description 2

STK5C4U3XXJGEVB

OPERATION PROCEDURE

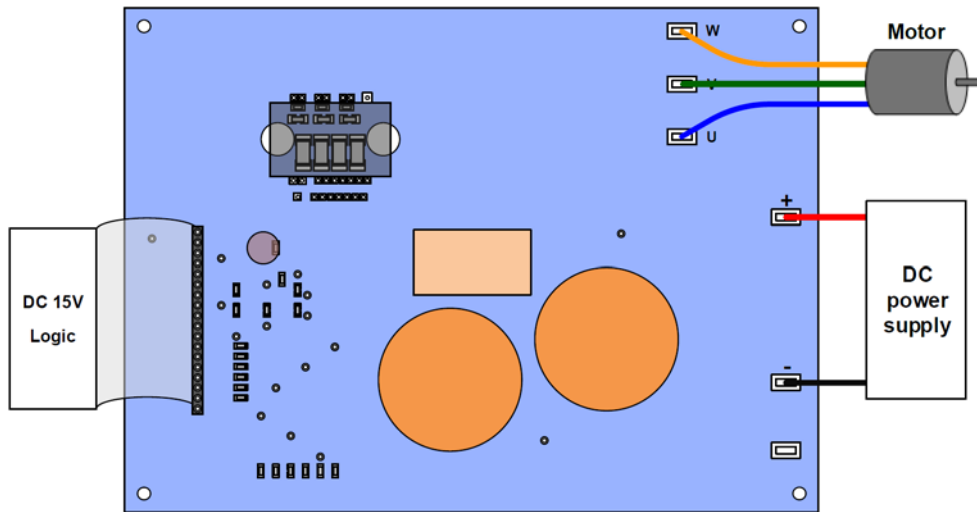

Figure 5. Connection Example

- Step 1. Please connect IPM, each power supply, logic parts, and the motor to the evaluation board, and confirm that each power supply is OFF at this time.
- Step 2. Please impress the power supply of DC 15 V.
- Step 3. Please perform a voltage setup according to specifications, and impress the power supply between the “+” and the “-” terminal.

- Step 4. By inputting signal to the logic part, IPM control is started.
(Therefore, please set electric charge to the boot-strap capacitor of upper side to turn on lower side IGBT before running.)

NOTE: When turning off the power supply part and the logic part, please carry out in the reverse order to above steps.

STK5C4U3XXJGEVB

LAYOUT (TOP VIEW)

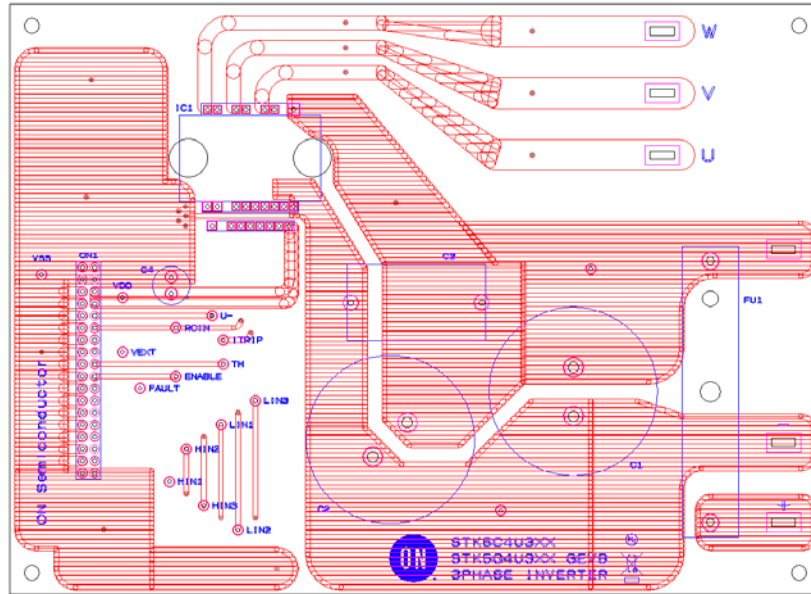

Figure 6. Layout – Surface

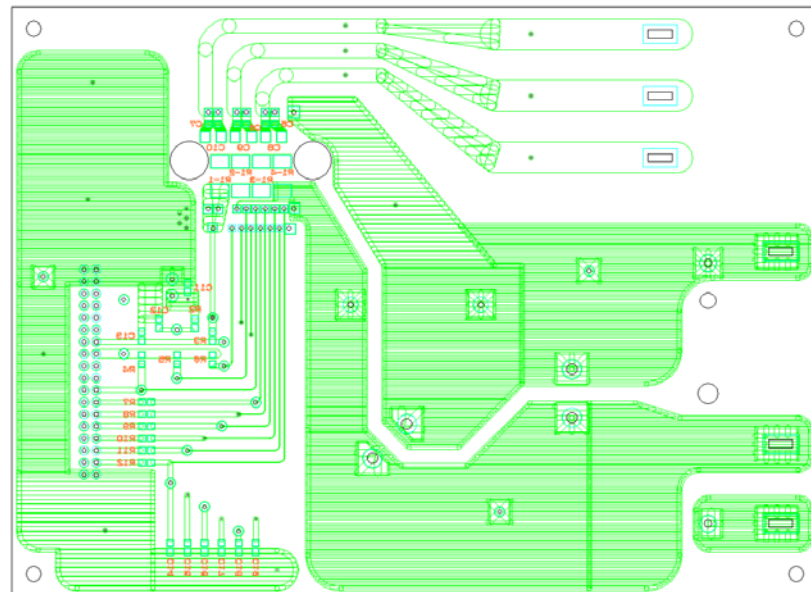

Figure 7. Layout – Back Side

Length: 124 mm

Side: 170 mm

Thickness: 1.6 mm

Rigid double-sided substrate (Material: FR-4)

Both sides resist coating

Copper foil thickness: 70 μm

STK5C4U3XXJGEVB

BILL OF MATERIALS

Table 1. BILL OF MATERIALS

Designator	Qty	Description	Value	Tolerance	Footprint	Manufacturer	Manufacturer Part Number	Substitution Allowed
R1-1 - R1-4	4	Shunt resistor	27 mΩ / 2 W	±1%	SMD 6432	SUSUMU	KRL3264E-C-R027-F (for 332)	Yes
R2	1	Setting fault clear time / resistor	optional		SMD 1608			Yes
R3	1	Setting time constant / resistor	200 Ω / 0.1 W	±1%	SMD 1608	KOA	RK73H1JT2D2000F	Yes
R4 - R6	3	Fault, ENABLE, TH pull-up / resistor	20 kΩ / 0.1 W	±1%	SMD 1608	KOA	RK73H1JT2D2002F	Yes
R7 - R12	6	Signal input low pass filter / resistor	100 Ω / 0.1 W	±1%	SMD 1608	KOA	RK73H1JT2D1000F	Yes
C1, C2	2	Aluminum electrolytic capacitor, Plus - Minus	470 μF / 450 V	±20%	Through- hole	Rubycon	450MXC470MEFCSN35X50	Yes
C3	1	Film capacitor Plus - Minus, Snubber	2.2 μF / 630 V	±5%	Through- hole	PANASONIC	ECQE6225JT	Yes
C4	1	Aluminum electrolytic capacitor, VDD - VSS	220 μF / 35 V	±20%	Through- hole	Nippon Chemi-Con	EKMG350ELL221MHB5D	Yes
C5 - C7, C11	4	VBx - VSx, VDD - VSS / capacitor	0.1 μF / 50 V	±10%	SMD 1608	MURATA	GRM188B31H104K	Yes
C8 - C10	3	VBx - VSx / capacitor	22 μF / 25 V	±20%	SMD 3225	MURATA	GRM32ER71E226ME15	Yes
C13	1	Setting time constant / capacitor	10 nF / 50 V	±10%	SMD 1608	MURATA	GRM188B11H103K	Yes
C14 - C19	6	Signal input low pass filter / capacitor	100 pF / 50 V	±5%	SMD 1608	MURATA	GRM1882C1H101J	Yes
CN1	1	Header - 18 Pin			Through- hole 2.54 pitch	HIROSE ELECTRIC	A2-18PA-2.54DSA(71)	Yes
VSS, VDD, U-, RCIN, ITRIP, VEXT, TH, ENABLE, FAULT, HIN1-3, LIN1-3, +, -	17	Test Pins			Through- hole	Mac8	ST-1-3	Yes
U, V, W, +, -	5	Faston terminal (Tab)			Through- hole			Yes
IC1	1	Inverter IPM			DIP-38	ON Semiconductor	STK5C4U3xxJ-E	No

NOTE All Components are lead free.

STK5C4U3XXJGEVB

HEAT SINK MOUNTING

Table 2. MOUNTING CONDITION

Item	Recommended Condition
Pitch	26.0 ± 0.1 mm (Please refer to Package Outline Diagram)
Screw	Diameter: M3 Bind machine screw, Truss machine screw, Pan machine screw
Washer	Plane washer Don't use spring washer. The size is D = 7 mm, d = 3.2 mm and t = 0.5 mm (Figure 9) JIS B 1256
Heat Sink	Material: copper or Aluminum Warpage (the surface that contacts IPM): -50 ~ 50 μm Screw holes must be countersunk. No contamination on the heat sink surface that contacts IPM.
Torque	Final tightening: 0.4 ~ 0.6 Nm Temporary tightening: 50 ~ 60% of final tightening
Grease	Silicone grease Thickness: 50 ~ 100 μm Uniformly apply silicone grease to whole back. (Figure 10)

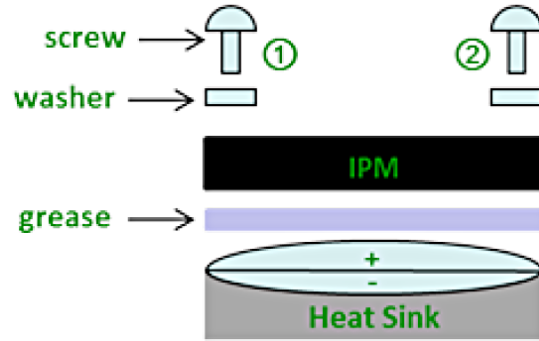

Figure 8. Mounting Composition

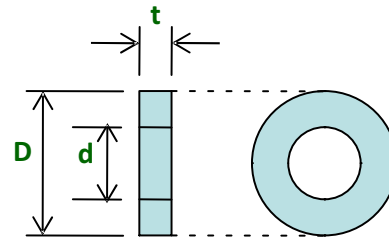

Figure 9. Size of Washer

Procedure for the Heat Sink Mounting

1st step: Tighten the screws until the torque of temporary tightening while maintaining the balance of left (1) and right (2).

2nd step: Tighten them until the torque of final tightening.

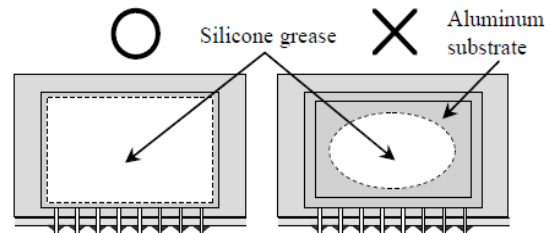



Figure 10. Grease Application

ON Semiconductor and the  are registered trademarks of Semiconductor Components Industries, LLC (SCILLC) or its subsidiaries in the United States and/or other countries. SCILLC owns the rights to a number of patents, trademarks, copyrights, trade secrets, and other intellectual property. A listing of SCILLC's product/patent coverage may be accessed at www.onsemi.com/site/pdf/Patent-Marking.pdf. SCILLC reserves the right to make changes without further notice to any products herein. SCILLC makes no warranty, representation or guarantee regarding the suitability of its products for any particular purpose, nor does SCILLC assume any liability arising out of the application or use of any product or circuit, and specifically disclaims any and all liability, including without limitation special, consequential or incidental damages. "Typical" parameters which may be provided in SCILLC data sheets and/or specifications can and do vary in different applications and actual performance may vary over time. All operating parameters, including "Typicals" must be validated for each customer application by customer's technical experts. SCILLC does not convey any license under its patent rights nor the rights of others. SCILLC products are not designed, intended, or authorized for use as components in systems intended for surgical implant into the body, or other applications intended to support or sustain life, or for any other application in which the failure of the SCILLC product could create a situation where personal injury or death may occur. Should Buyer purchase or use SCILLC products for any such unintended or unauthorized application, Buyer shall indemnify and hold SCILLC and its officers, employees, subsidiaries, affiliates, and distributors harmless against all claims, costs, damages, and expenses, and reasonable attorney fees arising out of, directly or indirectly, any claim of personal injury or death associated with such unintended or unauthorized use, even if such claim alleges that SCILLC was negligent regarding the design or manufacture of the part. SCILLC is an Equal Opportunity/Affirmative Action Employer. This literature is subject to all applicable copyright laws and is not for resale in any manner.

PUBLICATION ORDERING INFORMATION

LITERATURE FULFILLMENT:

Literature Distribution Center for ON Semiconductor
P.O. Box 5163, Denver, Colorado 80217 USA
Phone: 303-675-2175 or 800-344-3860 Toll Free USA/Canada
Fax: 303-675-2176 or 800-344-3867 Toll Free USA/Canada
Email: orderlit@onsemi.com

N. American Technical Support: 800-282-9855 Toll Free
USA/Canada
Europe, Middle East and Africa Technical Support:
Phone: 421 33 790 2910
Japan Customer Focus Center
Phone: 81-3-5817-1050

ON Semiconductor Website: www.onsemi.com
Order Literature: <http://www.onsemi.com/orderlit>

For additional information, please contact your local Sales Representative